



Zacta

TEST REPORT

Report number : Z101C-14152

Issue date : January 20, 2015

The device, as described herewith, was tested pursuant to applicable test procedure and complies with the requirements of;

FCC Part 27 Subpart C

The test results are traceable to the international or national standards.

Applicant	: KYOCERA Corporation
Equipment under test (EUT)	: Mobile Phone
Model number	: KYV33
FCC ID	: JOYKYV33

Date of test : December 5, 9, 27, 2014
January 5, 9, 2015
Test place : TÜV SÜD Zacta Ltd. Yonezawa Testing Center
4149-7 Hachimanpara 5-chome
Yonezawa-shi Yamagata 992-1128 Japan
Phone: +81-238-28-2880 Fax: +81-238-28-2888
Test results : Complied

The results in this report are applicable only to the equipment tested.
This report shall not be re-produced except in full without the written approval of TÜV SÜD Zacta Ltd.
This test report must not be used by client to claim product certification, approval, or endorsement by NVLAP, NIST, or any agency of the federal government.

Tested by : Taiki Watanabe Chiaki Kanno
Taiki Watanabe Chiaki Kanno

Tested by : Hikaru Shibata
Hikaru Shibata

Authorized by : Hiroaki Suzuki
Hiroaki Suzuki
Manager of EMC Technical Department

NVLAP[®]
NVLAP LAB CODE 200306-0



Table of contents

	Page
1. Summary of Test	4
1.1 Purpose of test	4
1.2 Standards	4
1.3 List of applied test to the EUT	4
1.4 Modification to the EUT by laboratory	4
2. Equipment Under Test	5
2.1 General Description of equipment	5
2.2 EUT information	5
2.3 Variation of the family model(s)	6
2.4 Description of Test mode	6
3. Configuration of equipment	7
3.1 Equipment(s) used	7
3.2 System configuration	7
4. Conducted Output Power	8
4.1 Measurement procedure	8
4.2 Measurement result	8
5. Effective Radiated Power	10
5.1 Measurement procedure	10
5.2 Calculation method	10
5.3 Limit	10
5.4 Test data	11
6. Peak to Average Ratio	12
6.1 Measurement procedure	12
6.2 Limit	12
6.3 Measurement result	12
6.4 Trace data	13
7. Occupied Bandwidth	15
7.1 Measurement procedure	15
7.2 Limit	15
7.3 Measurement result	16
7.4 Trace data	17
8. Band Edge Spurious and Harmonic at Antenna Terminals	21
8.1 Measurement procedure	21
8.2 Limit	21
8.3 Measurement result	21
8.4 Trace data	22
9. Radiated Emissions and Harmonic Emissions	36
9.1 Measurement procedure	36
9.2 Calculation method	36
9.3 Limit	36
9.4 Test data	37
10. Frequency Stability	40
10.1 Measurement procedure	40



Zacta

10.2 Limit.....	40
10.3 Measurement result.....	41
11. Uncertainty of measurement	42
12. Laboratory description	43
Appendix A. Test equipment	44

1. Summary of Test

1.1 Purpose of test

It is the original test in order to verify conformance to FCC Part 27 Subpart C.

1.2 Standards

CFR47 FCC Part 27 Subpart C

1.2.1 Test Methods

ANSI/TIA/EIA-603-C-2004

1.2.2 Deviation from standards

None

1.3 List of applied test to the EUT

Test items Section	Test items	Condition	Result
2.1046	Conducted Output Power	Conducted	PASS
27.50	Effective Radiated Power	Radiated	PASS
27.50	Peak to Average Ratio	Conducted	PASS
2.1049	Occupied Bandwidth	Conducted	PASS
27.53 2.1051	Band Edge Spurious and Harmonic at Antenna Terminal	Conducted	PASS
27.53 2.1053	Radiated emissions and Harmonic Emissions	Radiated	PASS
27.54 2.1055	Frequency Stability	Conducted	PASS

1.3.1 Test set up

Table-Top

1.4 Modification to the EUT by laboratory

None



2. Equipment Under Test

2.1 General Description of equipment

EUT is the Mobile Phone.

2.2 EUT information

Applicant	:	KYOCERA Corporation Yokohama Office 2-1-1 Kagahara, Tsuzuki-ku Yokohama-shi, Kanagawa, Japan Phone: +81-45-943-6253 Fax: +81-45-943-6314
Equipment under test	:	Mobile Phone
Trade name	:	Kyocera
Model number	:	KYV33
Serial number	:	N/A
EUT condition	:	Pre-Production
Power ratings	:	Battery: DC 3.8V
Size	:	(W) 68.0 × (D) 8.9 × (H) 131.0 mm
Environment	:	Indoor and Outdoor use
Terminal limitation	:	-20°C to 60°C
RF Specification Frequency of Operation	:	Up Link LTE Band X VII: 704-716MHz Down Link LTE Band X VII: 734-746MHz
Modulation type	:	QPSK, 16QAM
Emission designator	:	BW 5M QPSK: 4M51G7D, 16QAM: 4M52W7D BW 10M QPSK: 9M00G7D, 16QAM: 9M01W7D
Output power	:	LTE Band X VII (QPSK) : 0.035W ERP (15.4dBm) LTE Band X VII (16QAM): 0.037W ERP (15.7dBm)
Antenna type	:	Internal antenna
Antenna gain	:	-7.0dBi

2.3 Variation of the family model(s)

Not applicable

2.4 Description of Test mode

The EUT had been tested under operating condition.
There are three channels have been tested as following:

Band	Modulation	Bandwidth	Channel	Frequency [MHz]
LTE Band X VII	QPSK	5MHz	23775	706.5
			23790	710.0
			23825	713.5
		10MHz	23780	709.0
	23790		710.0	
	16QAM	5MHz	23800	711.0
			23775	706.5
			23790	710.0
10MHz		23825	713.5	
	23780	709.0		
			23790	710.0
			23800	711.0

The field strength of spurious emissions was measured at each position of all three axis X, Y and Z to compare the level, and the maximum noise.

The worst emission was found in X axis and the worst case recorded.



Zacta

3. Configuration of equipment

3.1 Equipment(s) used

No.	Equipment	Company	Model No.	Serial No.	FCC ID / DoC	Comment
1	Mobile Phone	KYOCERA	KYV33	N/A	JOYKYV33	EUT

3.2 System configuration

1. Mobile Phone
(EUT)

Note1: Numbers assigned to equipment or cables on this diagram correspond to the list in "3.1 Equipment(s) used".

4. Conducted Output Power

4.1 Measurement procedure [FCC 2.1046]

The conducted output power was measured with a wireless communication tester connected to the antenna terminal. The wireless communication tester parameters were set to produce the maximum power from the EUT.

- Test configuration

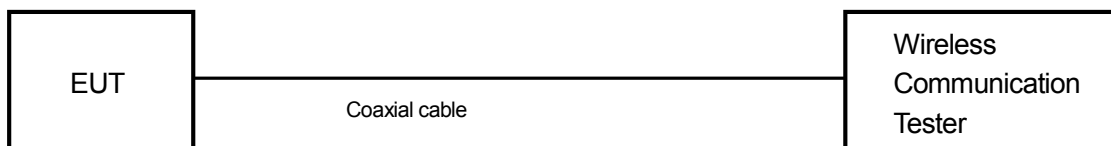

4.2 Measurement result

Date : December 5, 2014
 Temperature : 22.0 [°C]
 Humidity : 24.0 [%]
 Test place : Shielded room No.4

Test engineer :

Chiaki Kanno

Band	BW [MHz]	Mode	RB Allocation	RB offset	Target MPR	Avg Power[dBm]		
						23755	23790	23825
						706.5 MHz	710.0 MHz	713.5 MHz
LTE Band 17	5	QPSK	1	0	0	23.89	23.92	23.85
			1	12	0	23.84	23.87	23.87
			1	24	0	23.86	23.87	23.94
			12	0	1	22.87	22.87	22.84
			12	7	1	22.88	22.86	22.86
			12	13	1	22.85	22.84	22.94
			25	0	1	22.86	22.87	22.86
		16QAM	1	0	1	22.81	22.85	22.76
			1	12	1	22.74	22.79	22.79
			1	24	1	22.74	22.80	22.88
			12	0	2	21.92	21.98	21.93
			12	7	2	21.90	21.96	21.93
			12	13	2	21.86	21.96	21.94
			25	0	2	21.86	21.96	21.93

Date : December 9, 2014
 Temperature : 20.0 [°C]
 Humidity : 24.5 [%]
 Test place : Shielded room No.4

Test engineer : Chiaki Kanno

Band	BW [MHz]	Mode	RB Allocation	RB offset	Target MPR	Avg Power[dBm]		
						23780	23790	23800
						709.0 MHz	710.0 MHz	711.0 MHz
LTE Band 17	10	QPSK	1	0	0	23.88	<u>23.95</u>	23.87
			1	25	0	23.82	23.89	23.76
			1	49	0	23.87	23.92	23.93
			25	0	1	22.91	22.86	22.88
			25	12	1	22.88	22.81	22.83
			25	25	1	22.85	22.88	22.85
			50	0	1	22.86	22.83	22.87
		16QAM	1	0	1	22.90	22.88	23.03
			1	25	1	22.87	22.80	22.96
			1	49	1	22.92	22.93	23.10
			25	0	2	21.90	21.96	21.87
			25	12	2	21.87	21.91	21.88
			25	25	2	21.90	21.91	21.91
			50	0	2	21.91	21.91	21.91

5. Effective Radiated Power

5.1 Measurement procedure [FCC 27.50]

<Step 1>

The EUT and support equipment are placed on a 1 meter x 1.5 meter surface, 0.8 meter height FRP table. Radiated emission measurements are performed at 3 meter distance with the broadband antenna (double ridged guide antenna). The antenna is positioned both the horizontal and vertical planes of polarization and height is varied 1 to 4 meters and stopped at height producing the maximum emission. The bandwidth of the spectrum analyzer is set to 1MHz. The turntable is rotated by 360 degrees and stopped at azimuth of producing the maximum emission.

<Step 2>

The substitution antenna is replaced by the transmitter antenna (EUT). The frequency of the signal generator is adjusted to the measurement frequency. Level of the signal generator is adjusted to the level that is obtained from step 1, and record the emission level of signal generator.

Spectrum analyzer setting

- Detector: RMS Average (RBW: 430kHz, VBW: 1.5MHz)

- Test configuration

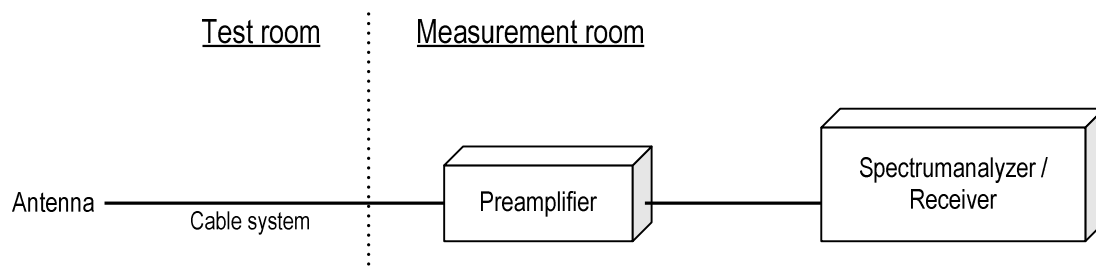

5.2 Calculation method

Result (ERP) = S.G Reading – Cable loss + Antenna Gain

Margin = Limit – Result (ERP)

5.3 Limit

3 W (34.7dBm)

5.4 Test data

Date : December 27, 2014
 Temperature : 21.7 [°C]
 Humidity : 27.4 [%]
 Test place : 3m Semi-anechoic chamber
 Test engineer : Taiki Watanabe

Date : January 9, 2015
 Temperature : 20.1 [°C]
 Humidity : 27.1 [%]
 Test place : 3m Semi-anechoic chamber
 Test engineer : Taiki Watanabe

[WCDMA Band X VII] QPSK, BW 5MHz

H/V	Frequency [MHz]	S.A Reading [dBm]	S.G Reading [dBm]	Cable loss [dB]	Ant.Gain [dBi]	Result [dBm]	Limit [dBm]	Margin [dB]
H	709.0	-13.7	25.7	0.6	-10.1	15.0	34.7	19.7
H	710.0	-13.5	26.1	0.6	-10.1	15.4	34.7	19.3
H	711.0	-13.7	26.1	0.6	-10.1	15.4	34.7	19.3

16QAM, BW 5MHz

H/V	Frequency [MHz]	S.A Reading [dBm]	S.G Reading [dBm]	Cable loss [dB]	Ant.Gain [dBi]	Result [dBm]	Limit [dBm]	Margin [dB]
H	709.0	-13.9	26.1	0.6	-10.1	15.4	34.7	19.3
H	710.0	-13.9	25.7	0.6	-10.1	15.0	34.7	19.7
H	711.0	-13.6	26.2	0.6	-10.1	15.5	34.7	19.2

QPSK, BW 10MHz

H/V	Frequency [MHz]	S.A Reading [dBm]	S.G Reading [dBm]	Cable loss [dB]	Ant.Gain [dBi]	Result [dBm]	Limit [dBm]	Margin [dB]
H	709.0	-13.7	26.1	0.6	-10.1	15.4	34.7	19.3
H	710.0	-13.5	26.1	0.6	-10.1	15.4	34.7	19.3
H	711.0	-14.2	25.5	0.6	-10.1	14.8	34.7	19.9

16QAM, BW 10MHz

H/V	Frequency [MHz]	S.A Reading [dBm]	S.G Reading [dBm]	Cable loss [dB]	Ant.Gain [dBi]	Result [dBm]	Limit [dBm]	Margin [dB]
H	709.0	-13.6	26.1	0.6	-10.1	15.4	34.7	19.3
H	710.0	-13.7	25.9	0.6	-10.1	15.2	34.7	19.5
H	711.0	-13.3	26.4	0.6	-10.1	15.7	34.7	19.0

6. Peak to Average Ratio

6.1 Measurement procedure [FCC 27.50]

The peak to average ratio was measured with a spectrum analyzer connected to the antenna terminal.

The spectrum analyzer is set to;
- Power Stat CCDF mode

- Test configuration

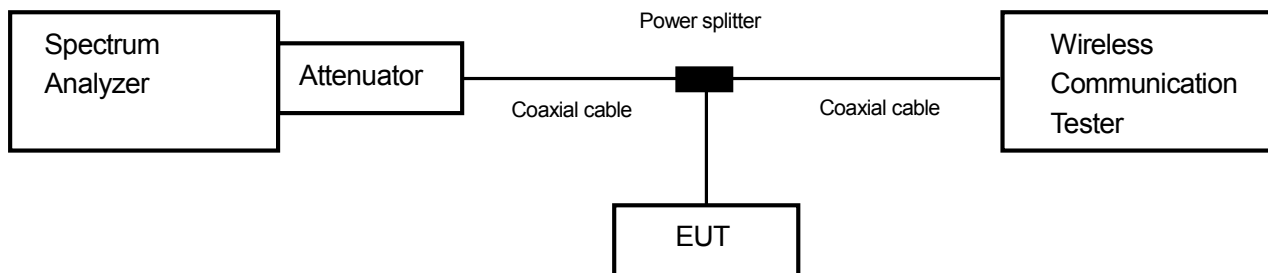

6.2 Limit

13dB or less

6.3 Measurement result

Date : January 5, 2015
 Temperature : 22.1 [°C]
 Humidity : 46.3 [%]
 Test place : Shielded room No.4

Test engineer : Taiki Watanabe

Band	Channel	Frequency [MHz]	Modulation	BW [MHz]	RB	Peak to Average Power Ratio [dB]	Limit [dB]
LTE Band X VII	23790	710.0	QPSK	5	25-0	5.21	13
				10	50-0	4.66	13
			16QAM	5	25-0	6.04	13
				10	50-0	6.17	13



Zacta

6.4 Trace data
[LTE Band X VII]
Channel: 23790
QPSK, BW 5MHz, RB25-0

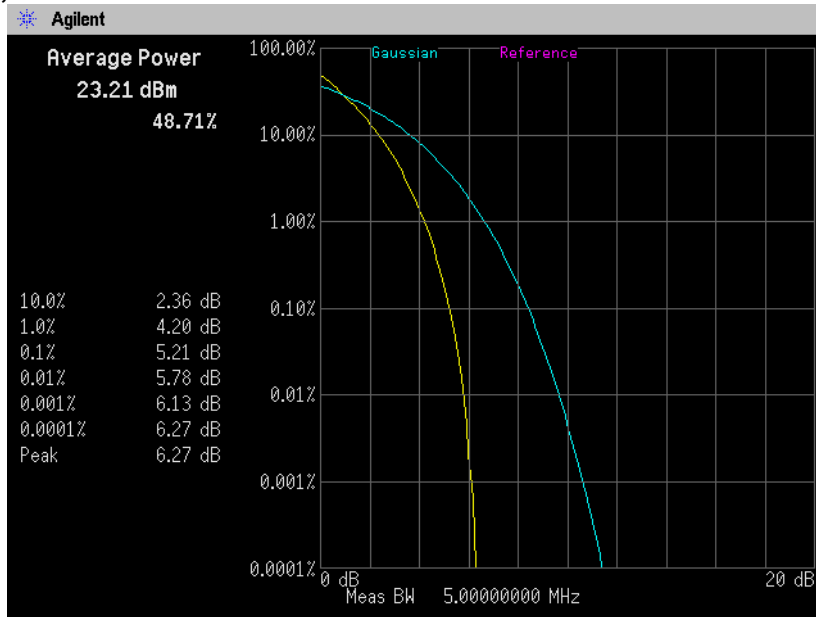

QPSK, BW 10MHz, RB50-0

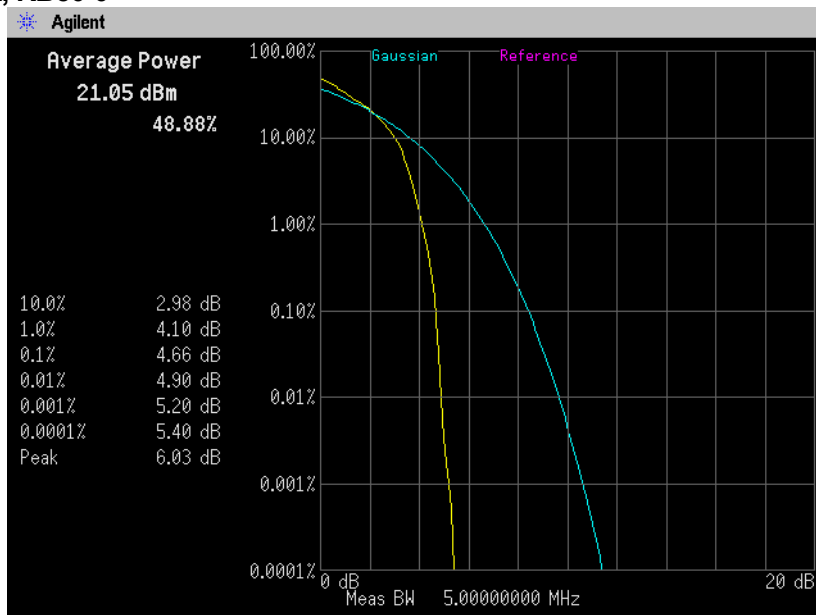



Zacta

16QAM, BW 5MHz, RB25-0

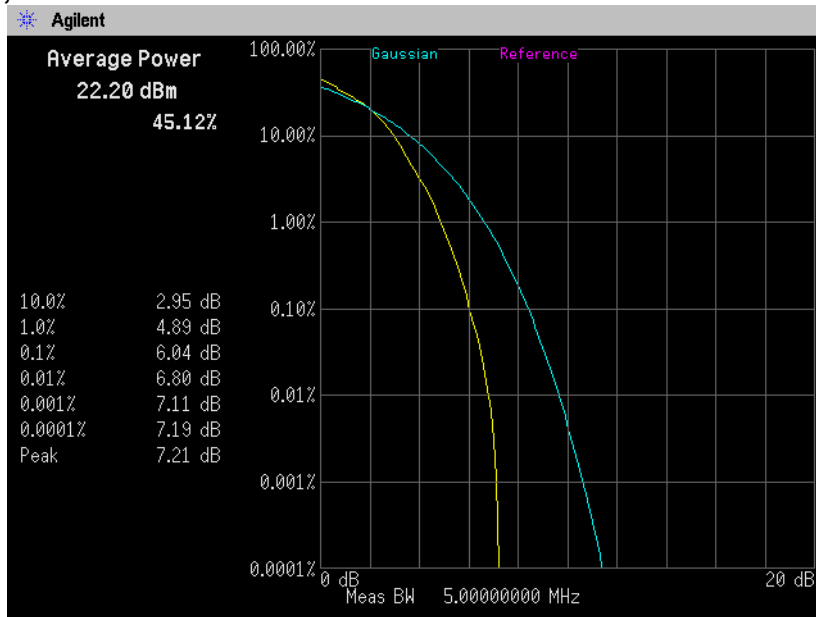

16QAM, BW 10MHz, RB50-0

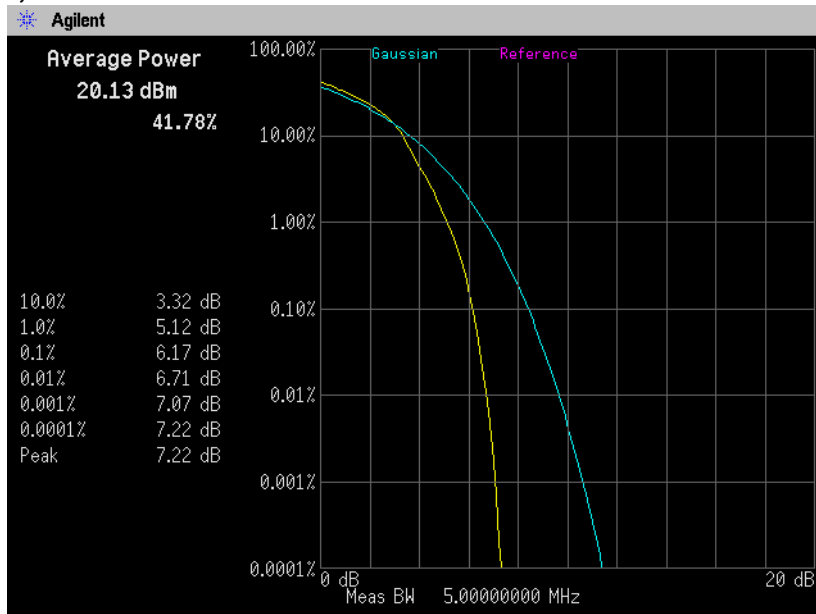

7. Occupied Bandwidth

7.1 Measurement procedure [FCC 2.1049]

The Occupied bandwidth was measured with a spectrum analyzer connected to the antenna terminal.

The spectrum analyzer is set to;

- RBW=100kHz, VBW=300kHz, Span=10MHz, Sweep=auto, Detector=Peak, Trace mode=Max hold
- RBW=200kHz, VBW=620kHz, Span=20MHz, Sweep=auto, Detector=Peak, Trace mode=Max hold

- Test configuration

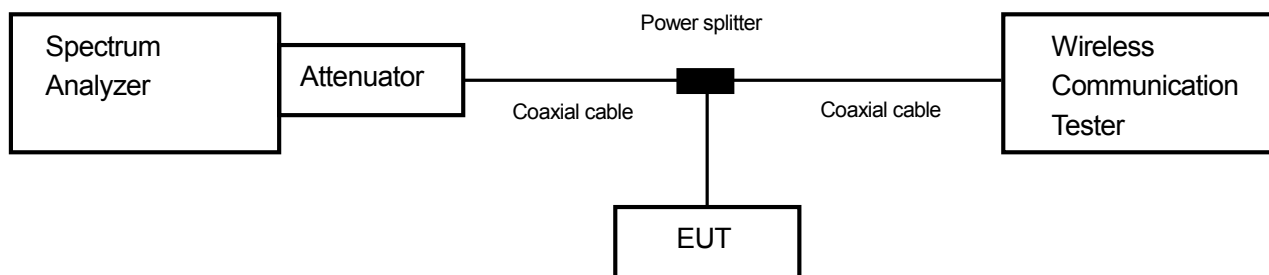

7.2 Limit

None

7.3 Measurement result

Date : January 5, 2015

Temperature : 22.1 [°C]

Humidity : 46.3 [%]

Test place : Shielded room No.4

Test engineer :

Taiki Watanabe

BW	Mode	UL RB Allocation	UL RB Start	Frequency [MHz]	26dB Bandwidth [MHz]	99% OBW [MHz]
5MHz	QPSK	1	0	710.0	0.710	0.4970
		1	24		0.727	0.5039
		12	7		3.322	2.3113
		25	0		4.967	4.5072
5MHz	16QAM	1	0	710.0	0.705	0.4780
		1	24		0.675	0.4820
		12	7		3.385	2.3376
		25	0		4.988	4.5184
10MHz	QPSK	1	0	710.0	1.050	0.7564
		1	49		1.053	0.7442
		25	12		5.930	4.6526
		50	0		9.938	9.0005
10MHz	16QAM	1	0	710.0	1.046	0.7515
		1	49		1.025	0.7400
		25	12		5.949	4.6813
		50	0		9.990	9.0116



Zacta

7.4 Trace data
[LTE Band X VII]
Channel: 23790
QPSK, BW 5MHz, RB1-0

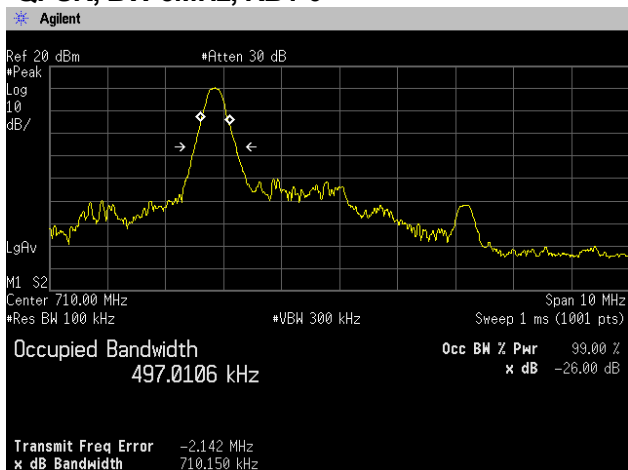

RB1-24

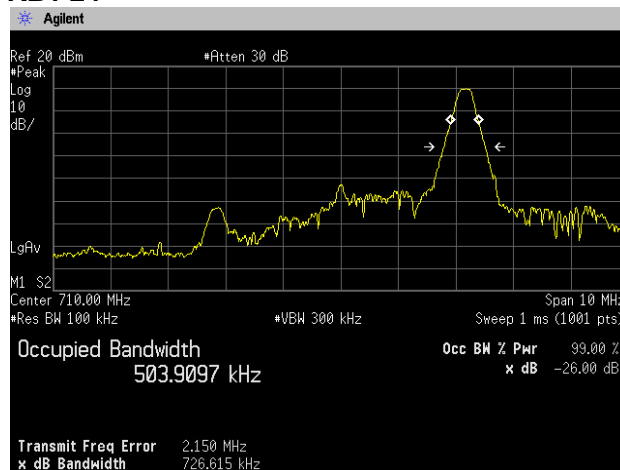

RB12-7

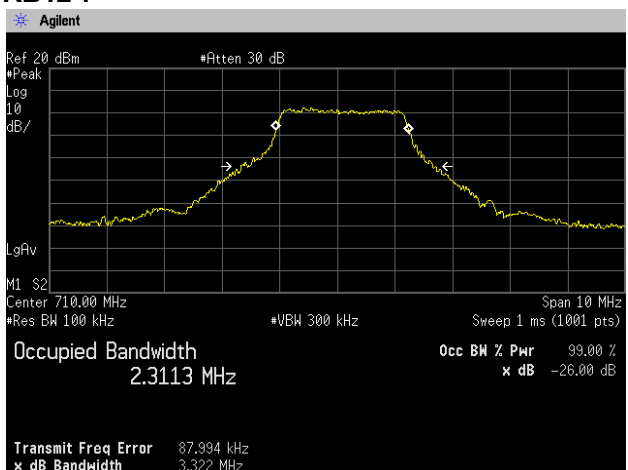

RB25-0

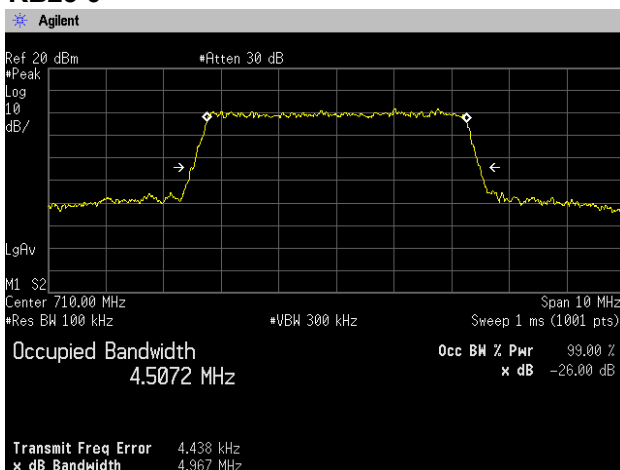



Zacta

16QAM, BW 5MHz, RB1-0

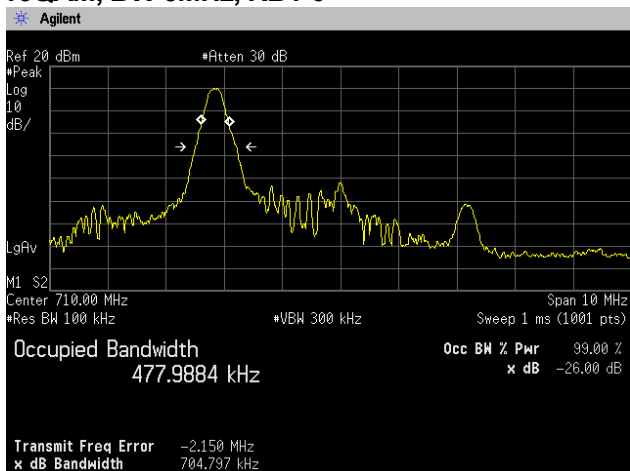

RB1-24

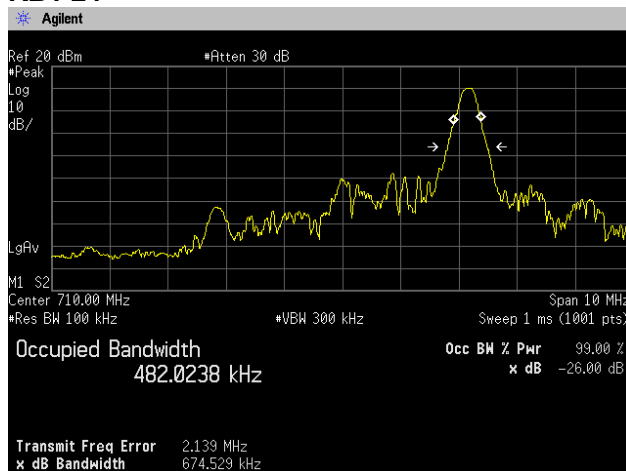

RB12-7

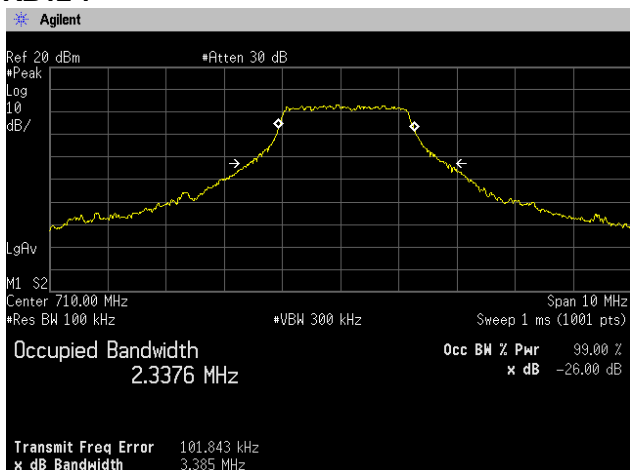

RB25-0

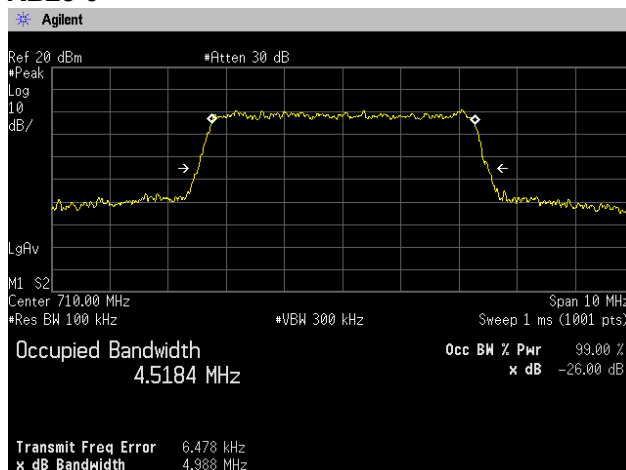



Zacta

QPSK, BW 10MHz, RB1-0

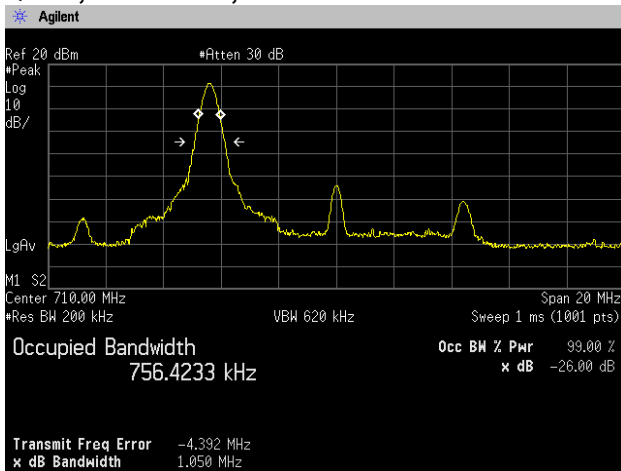

RB1-49

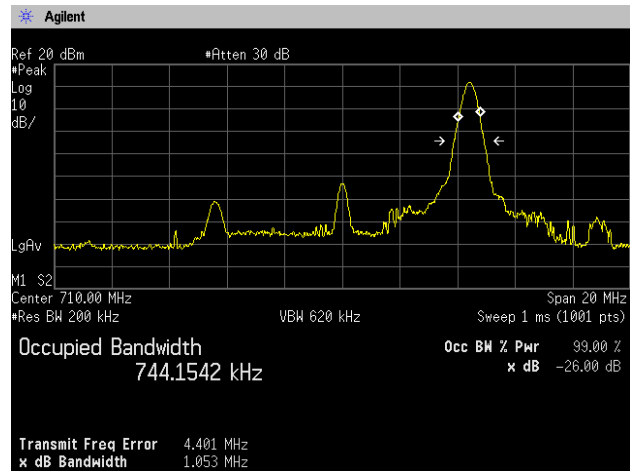

RB25-12

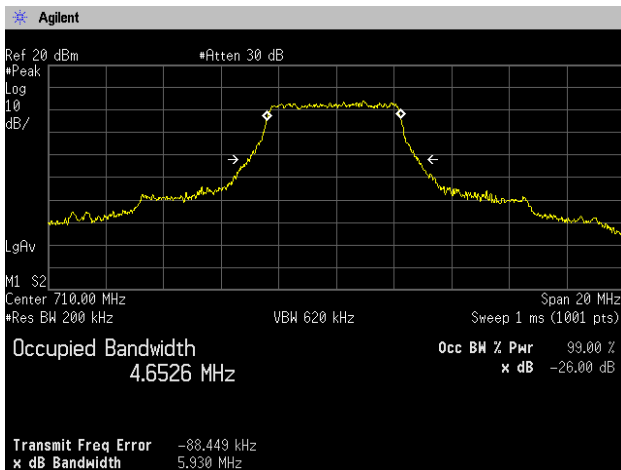

RB50-0

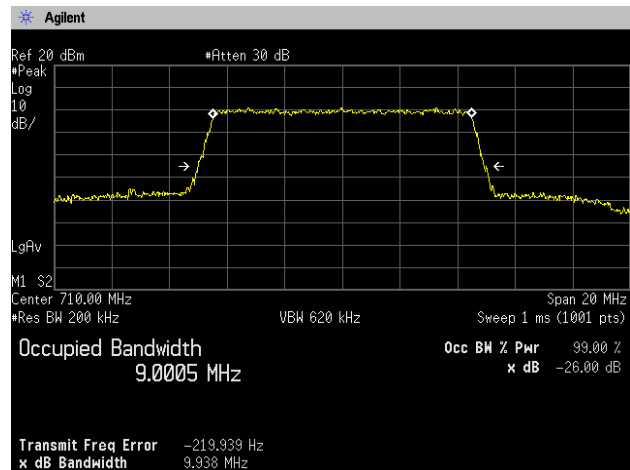



Zacta

16QAM, BW 10MHz, RB1-0

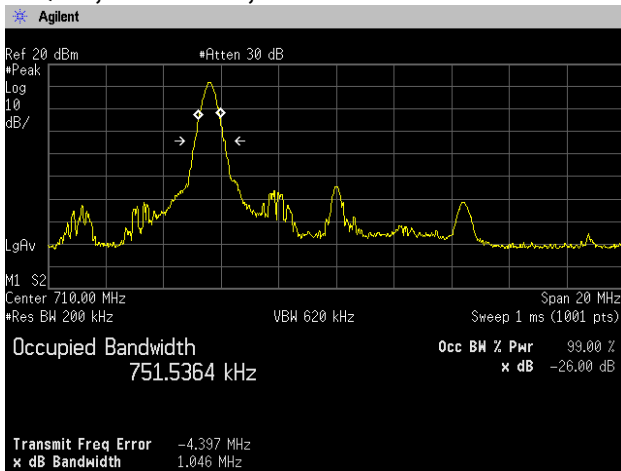

RB1-49

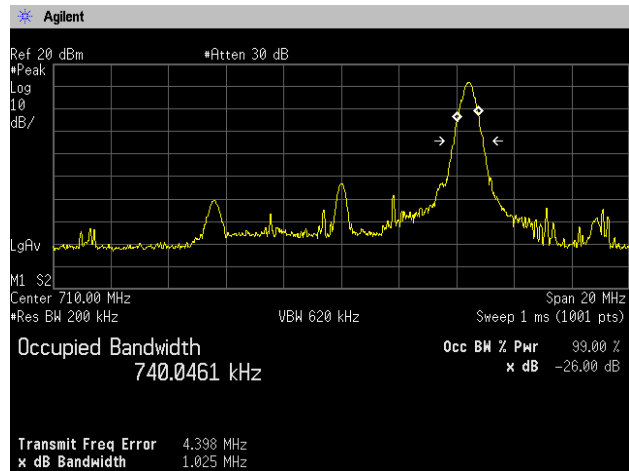

RB25-12

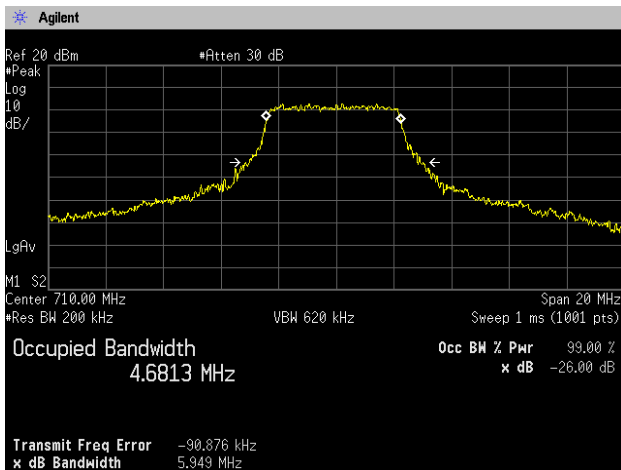

RB50-0

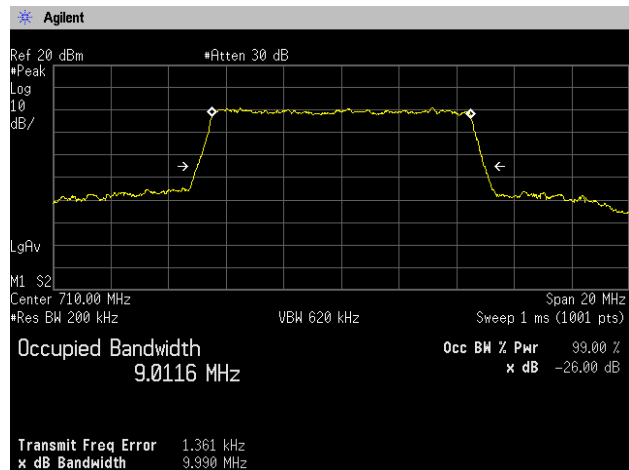

8. Band Edge Spurious and Harmonic at Antenna Terminals

8.1 Measurement procedure

[FCC 27.53, 2.1051]

The band edge spurious and harmonic was measured with a spectrum analyzer connected to the antenna terminal.

The spectrum analyzer is set to;

<Band Edge>

- RBW=100kHz, VBW=300kHz, Span=2MHz, Sweep=auto, Detector=RMS, Trace mode=Max hold

<Spurious Emissions>

- RBW=1MHz, VBW=3MHz, Span=Arbitrary setting, Sweep=auto, Detector=Peak, Trace mode=Max hold

- Test configuration

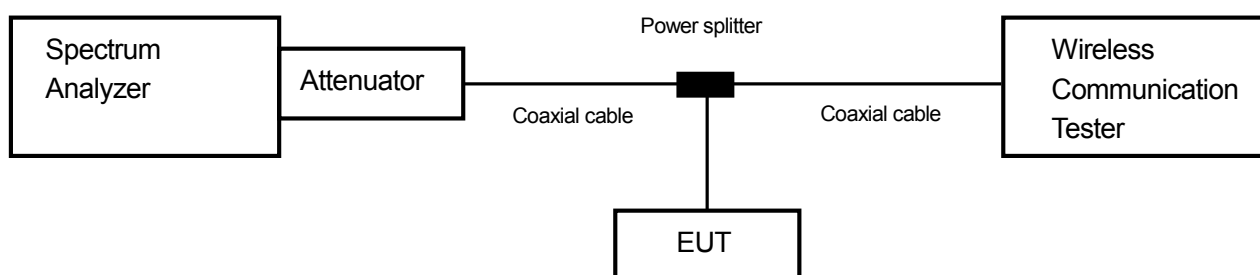

8.2 Limit

-13dBm or less

8.3 Measurement result

Date : January 5, 2015

Temperature : 22.1 [°C]

Humidity : 46.3 [%]

Test place : Shielded room No.4

Test engineer :

Taiki Watanabe

Band	Modulation	Bandwidth	Results	
LTE Band X VII	QPSK	5MHz	See the trace data	PASS
		10MHz	See the trace data	PASS
	16QAM	5MHz	See the trace data	PASS
		10MHz	See the trace data	PASS



Zacta

8.4 Trace data
[LTE Band X VII]
(Band Edge)
QPSK, BW 5MHz, RB1-0
Channel: Low

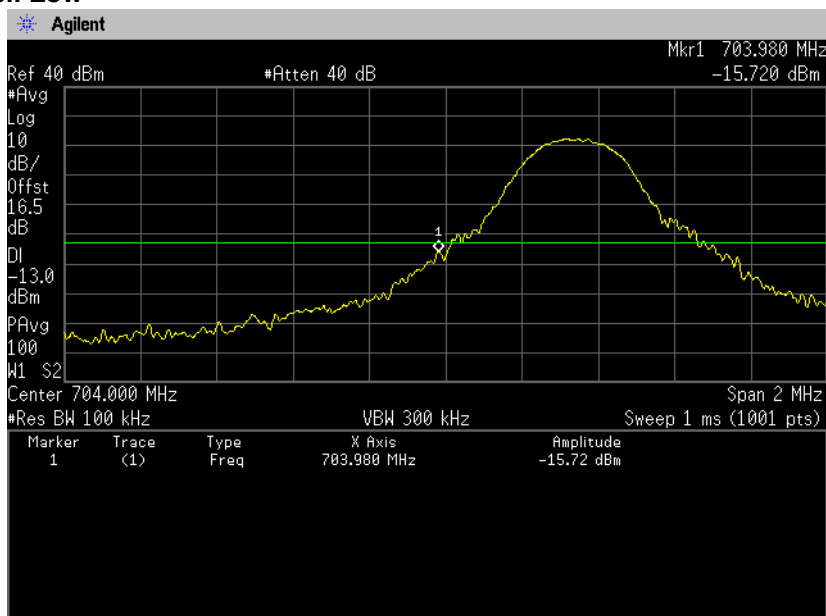

QPSK, BW 5MHz, RB1-24
Channel: High

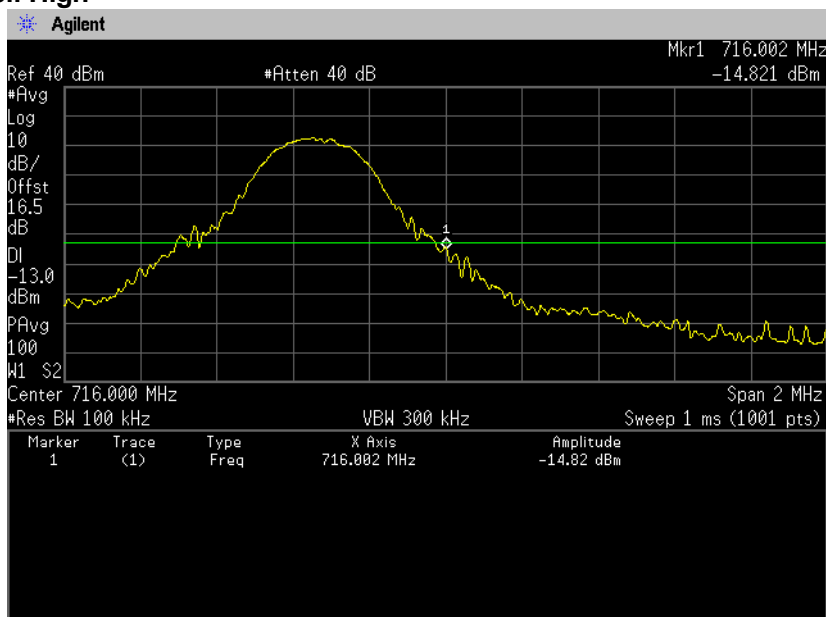



Zacta

QPSK, BW 5MHz, RB25-0
Channel: Low

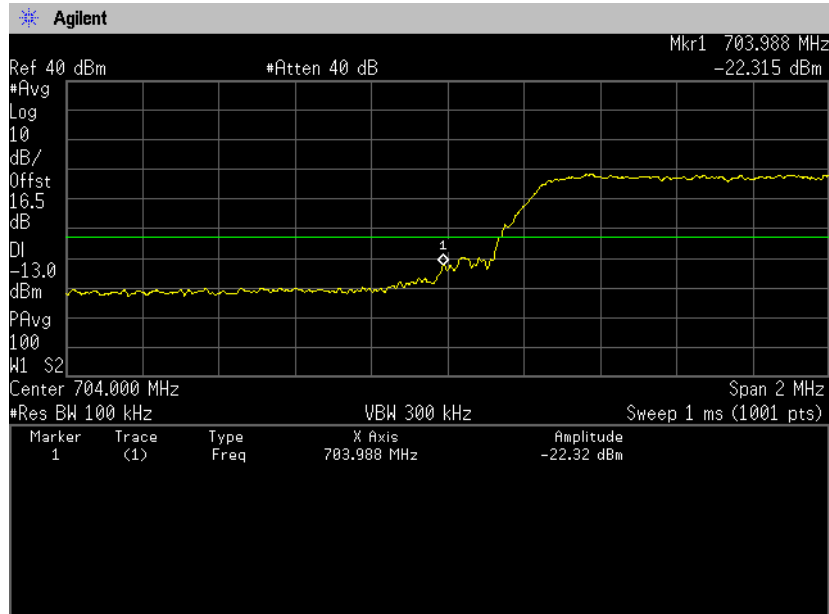

QPSK, BW 5MHz, RB25-0
Channel: High

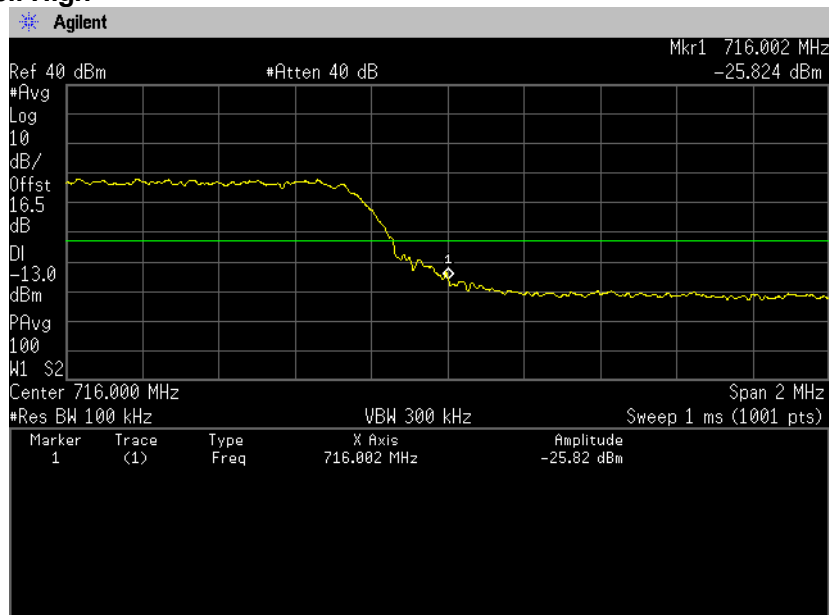



Zacta

16QAM, BW 5MHz, RB1-0
Channel: Low

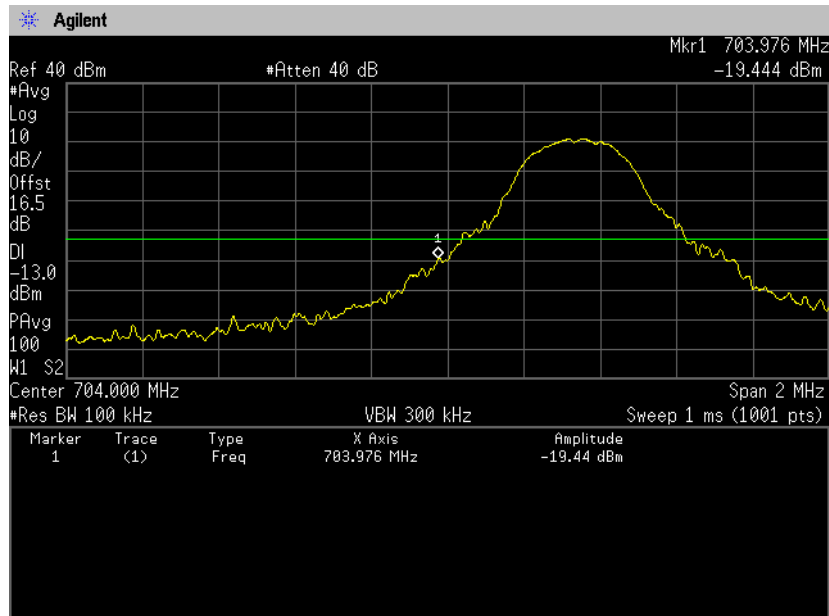

16QAM, BW 5MHz, RB1-24
Channel: High

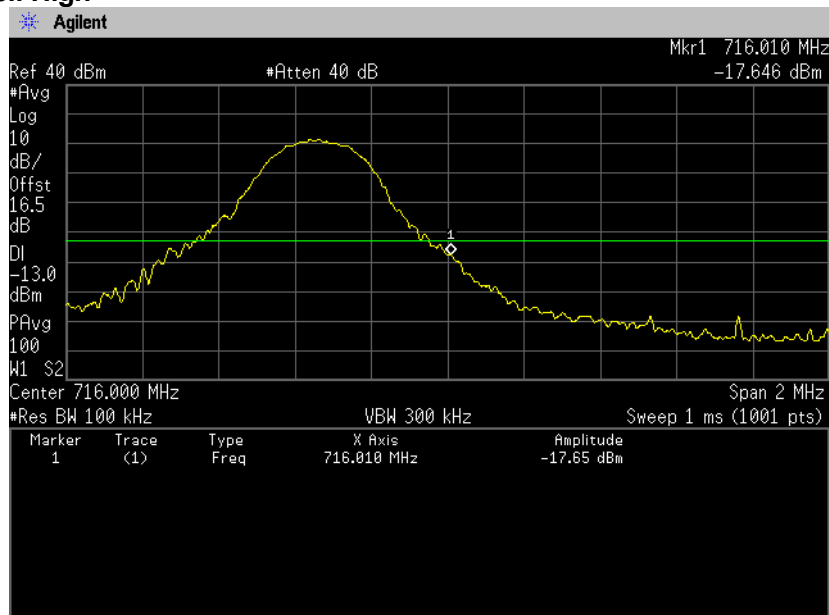

16QAM, BW 5MHz, RB25-0
Channel: Low

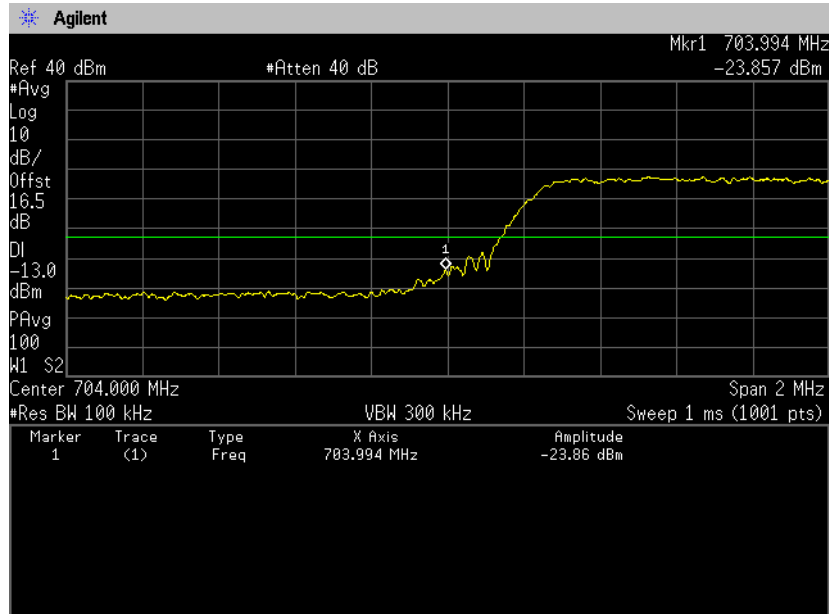

16QAM, BW 5MHz, RB25-0
Channel: High

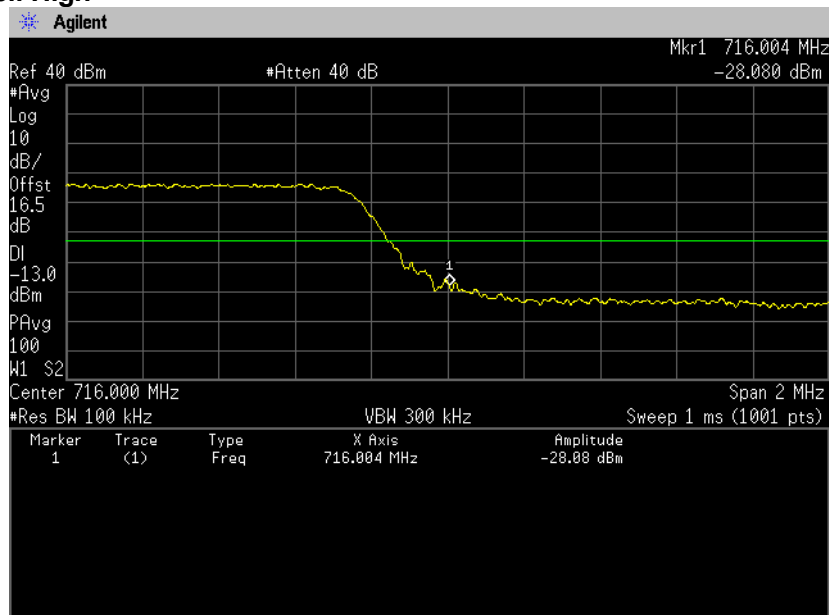



Zacta

QPSK, BW 10MHz, RB1-0 Channel: Low

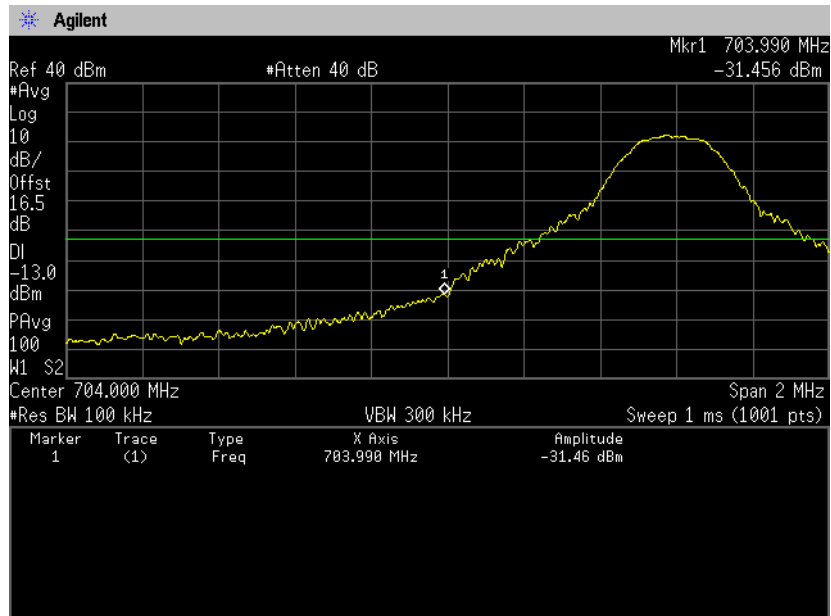

QPSK, BW 10MHz, RB1-49 Channel: High

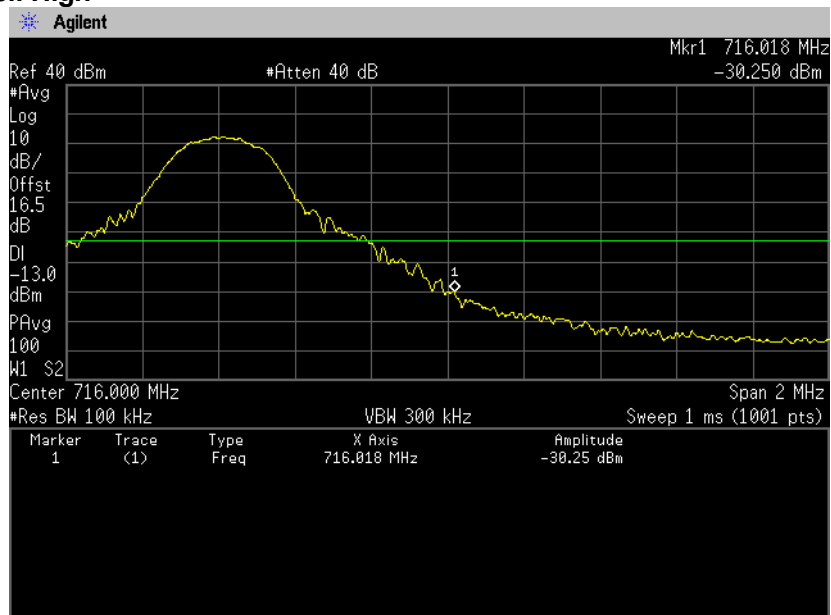

QPSK, BW 10MHz, RB50-0 Channel: Low

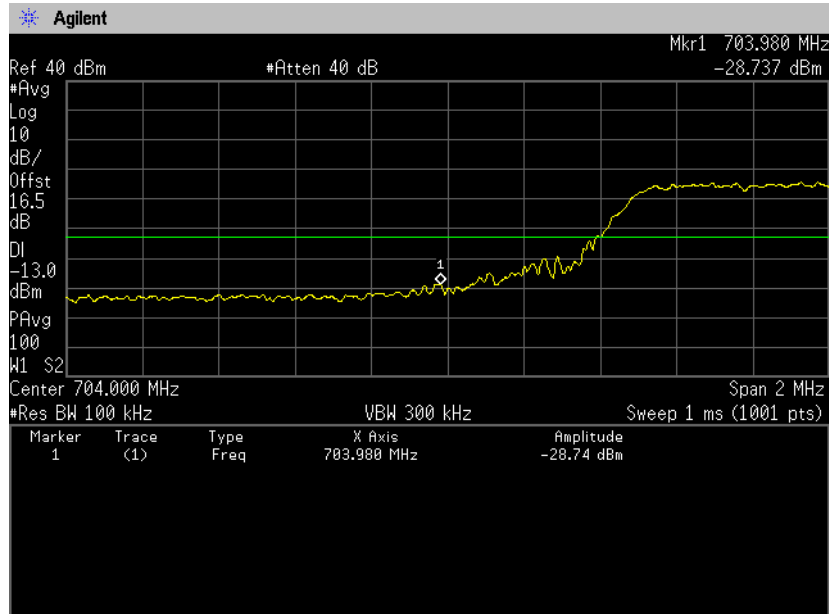

QPSK, BW 10MHz, RB50-0 Channel: High

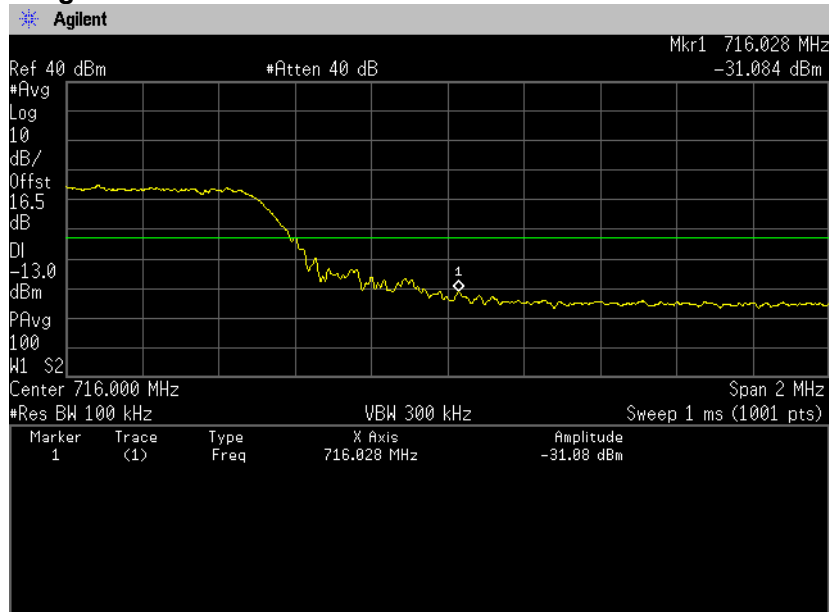



Zacta

16QAM, BW 10MHz, RB1-0 Channel: Low

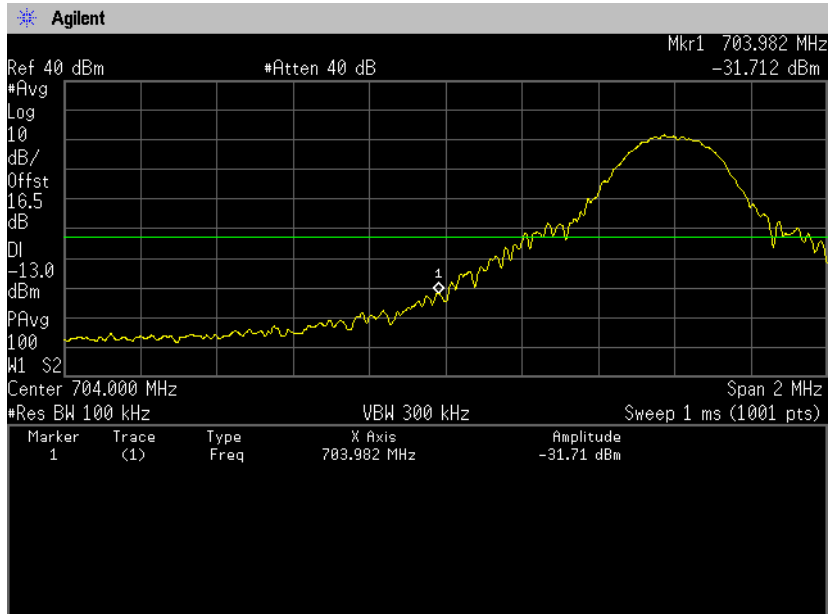

16QAM, BW 10MHz, RB1-49 Channel: High

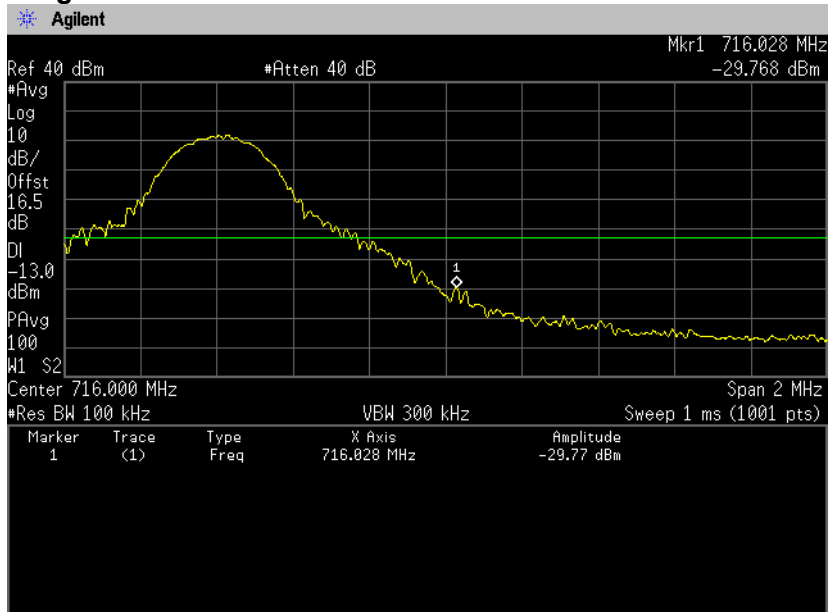

16QAM, BW 10MHz, RB50-0
Channel: Low

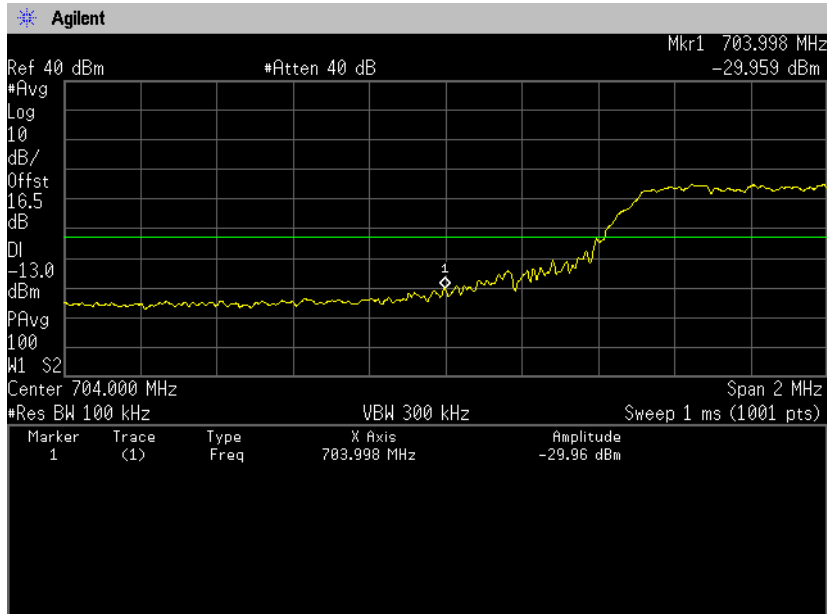

16QAM, BW 10MHz, RB50-0
Channel: High

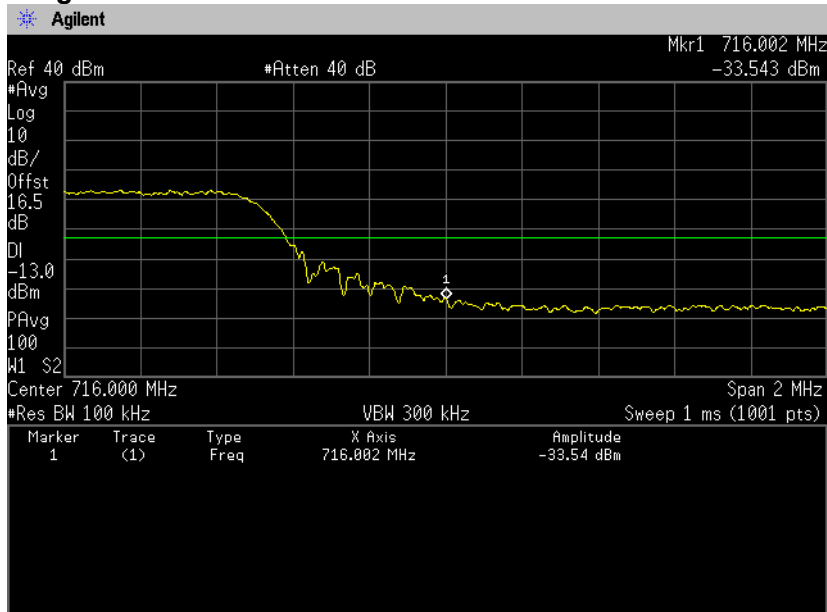



Zacta

(Spurious Emissions)
QPSK, BW 10MHz, RB1-0
Channel: 23780
30MHz-5GHz

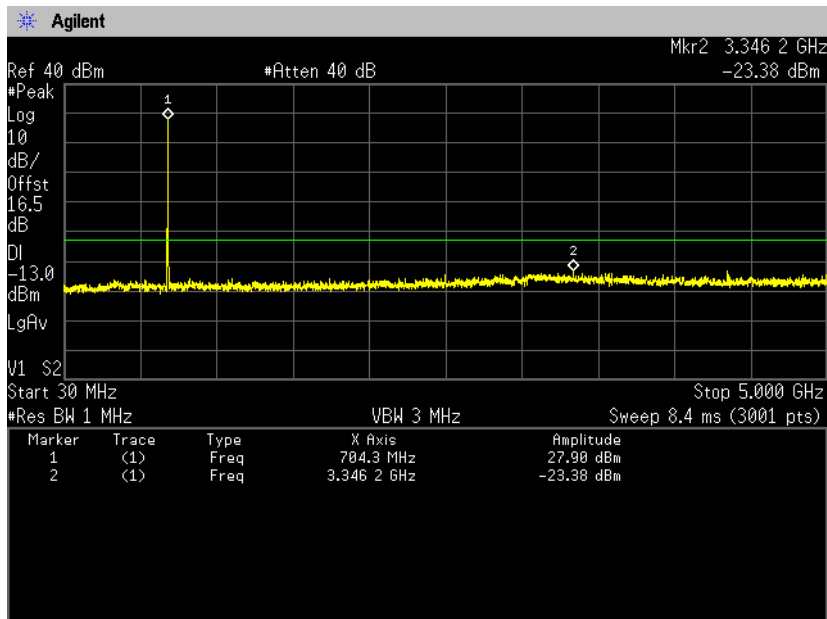

5GHz-10GHz

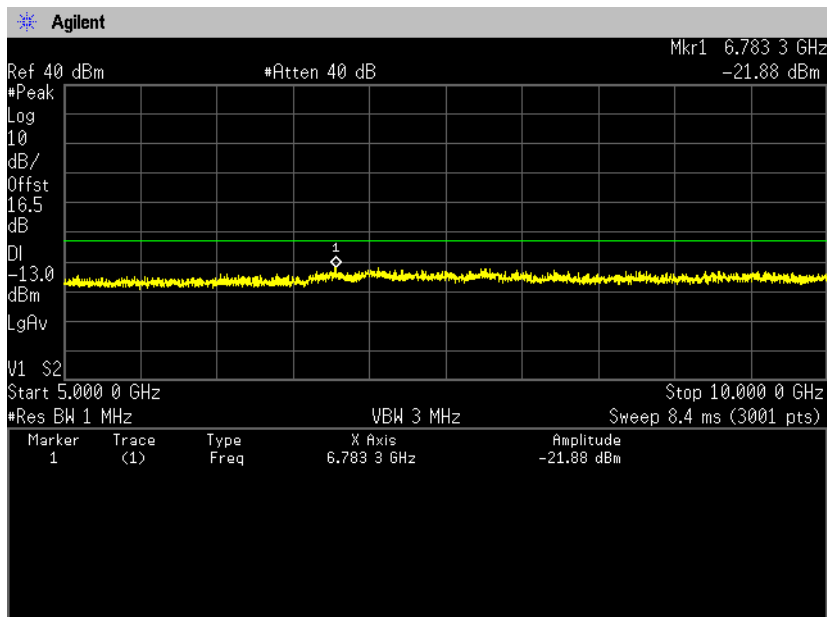



Zacta

**Channel: 23790
30MHz-5GHz**

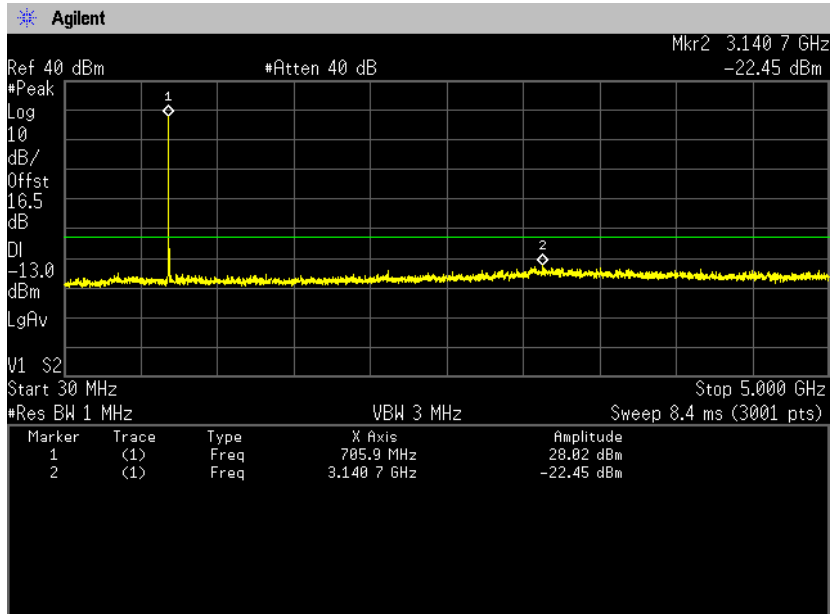

5GHz-10GHz

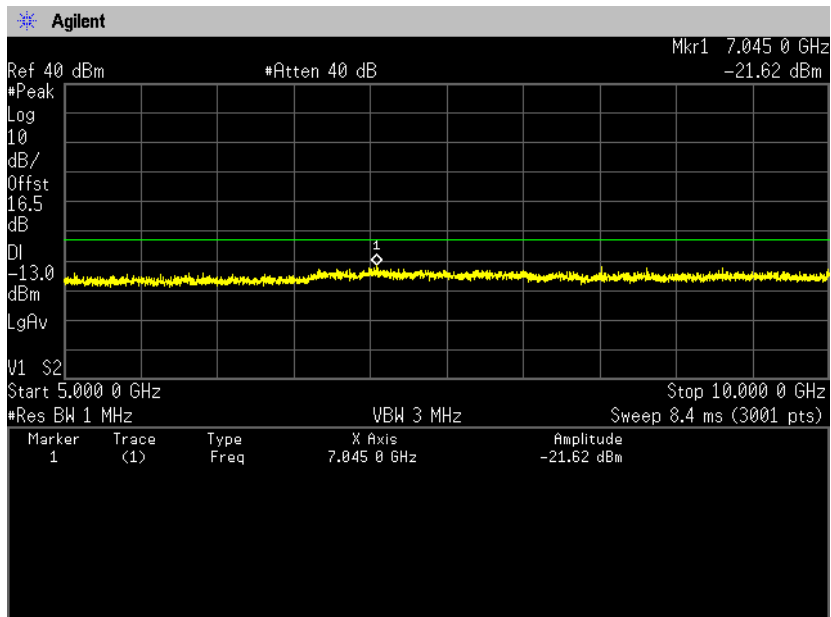



Zacta

**Channel: 23800
30MHz-5GHz**

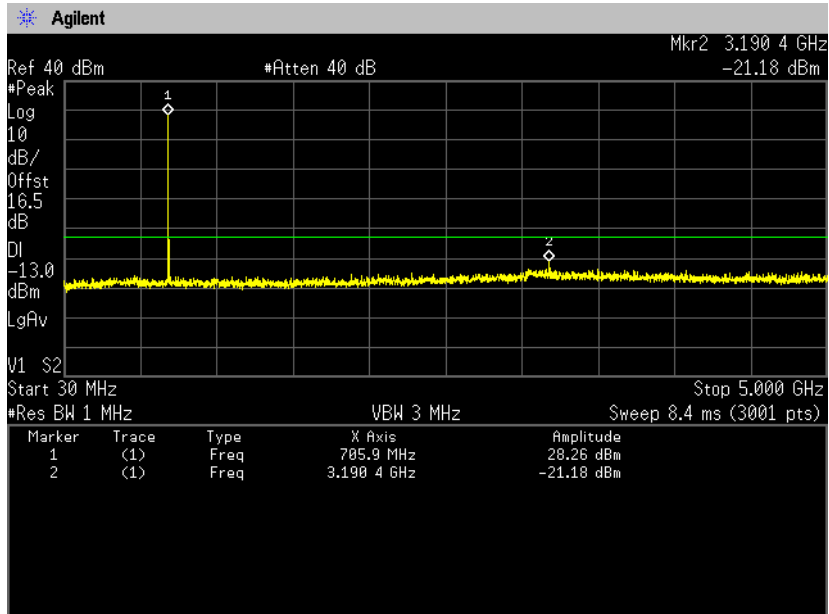

5GHz-10GHz

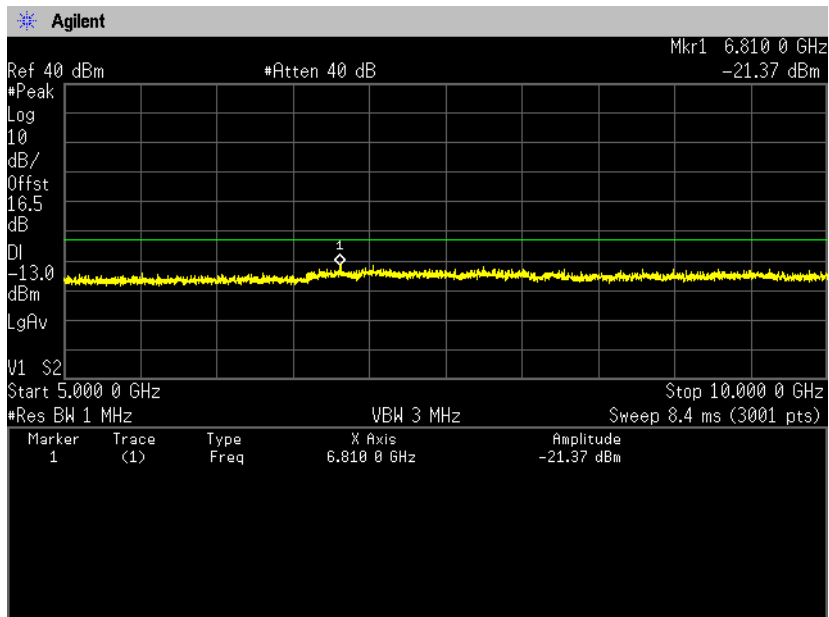



Zacta

16QAM, BW 10MHz, RB1-49
Channel: 23780
30MHz-5GHz

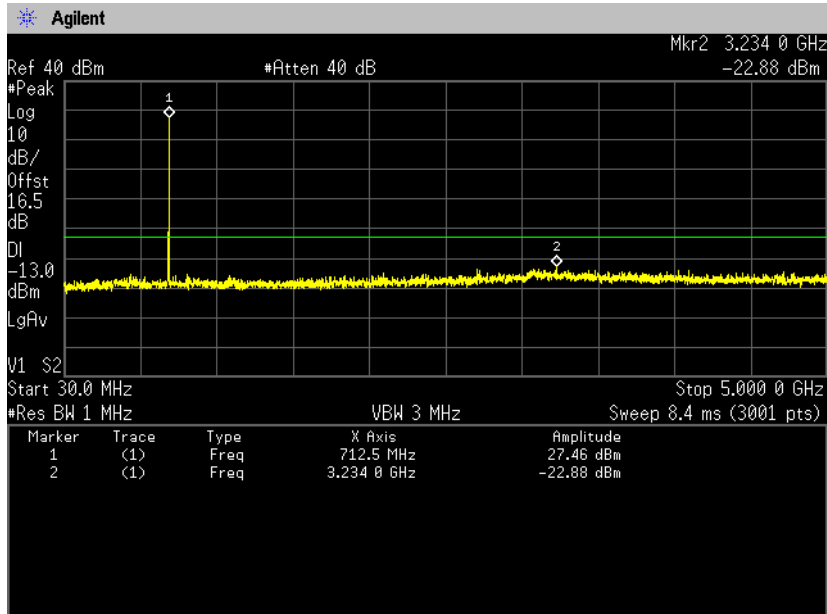

5GHz-10GHz

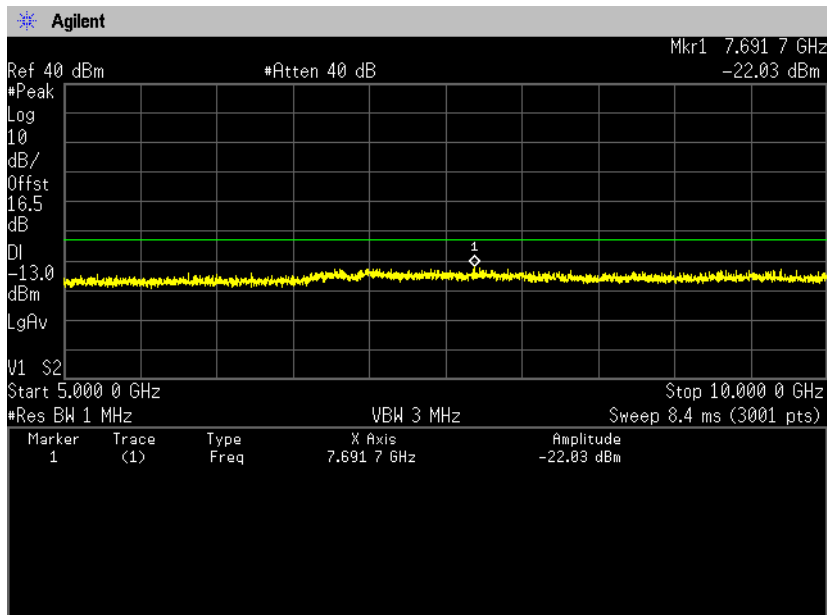



Zacta

**Channel: 23790
30MHz-5GHz**

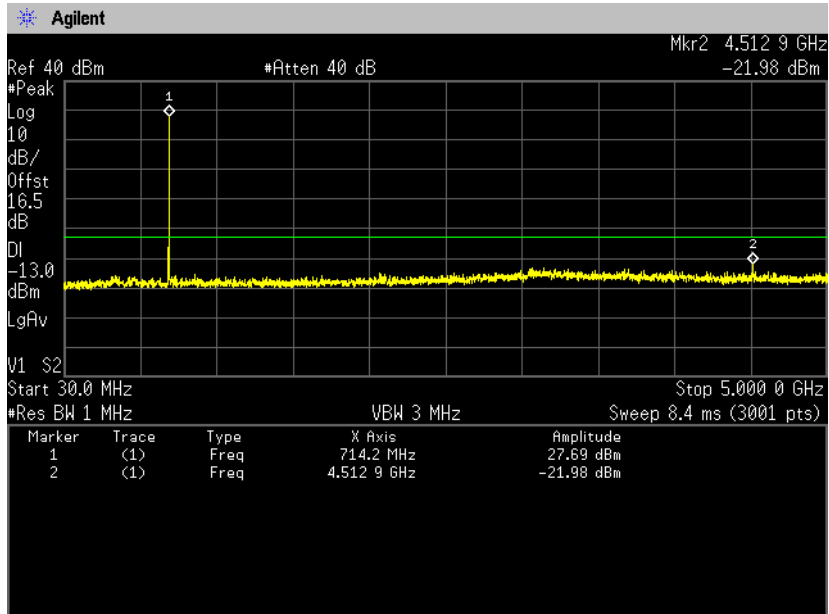

5GHz-10GHz

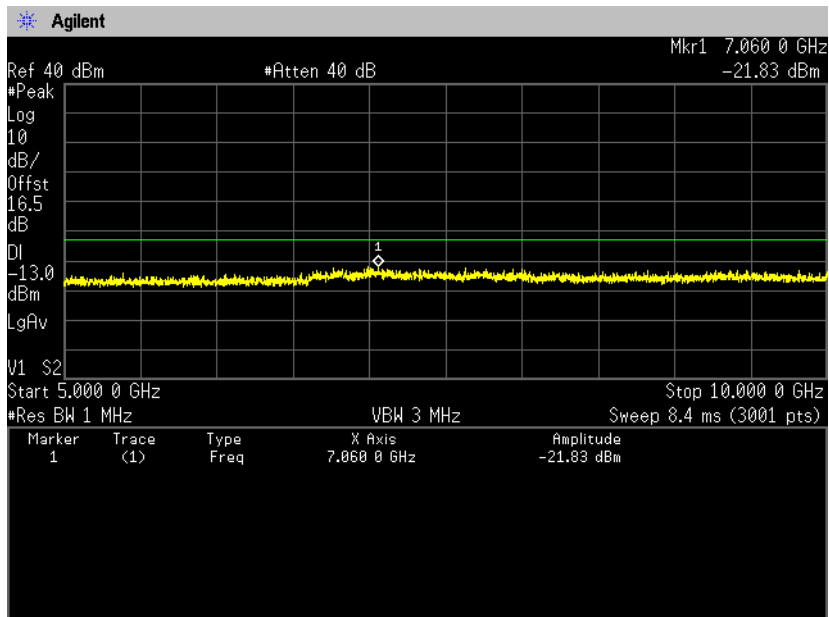



Zacta

**Channel: 23800
30MHz-5GHz**

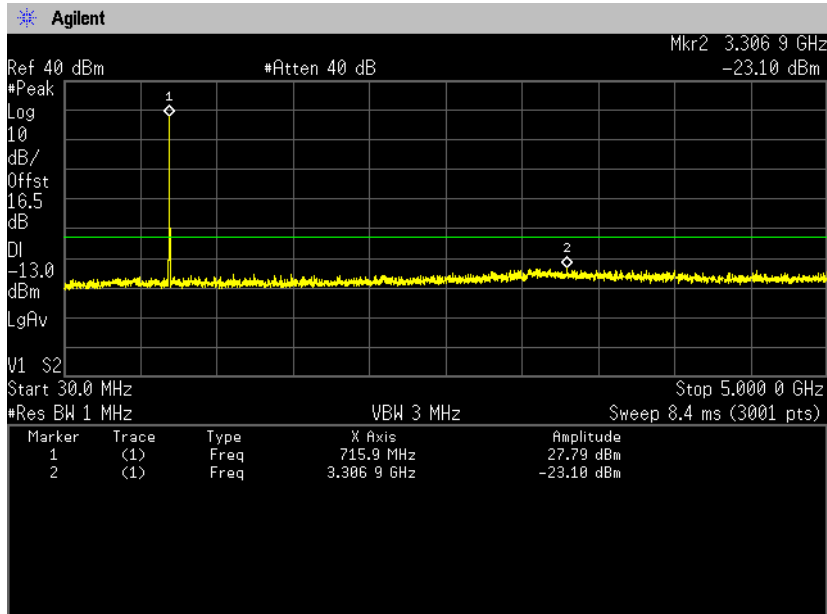

5GHz-10GHz

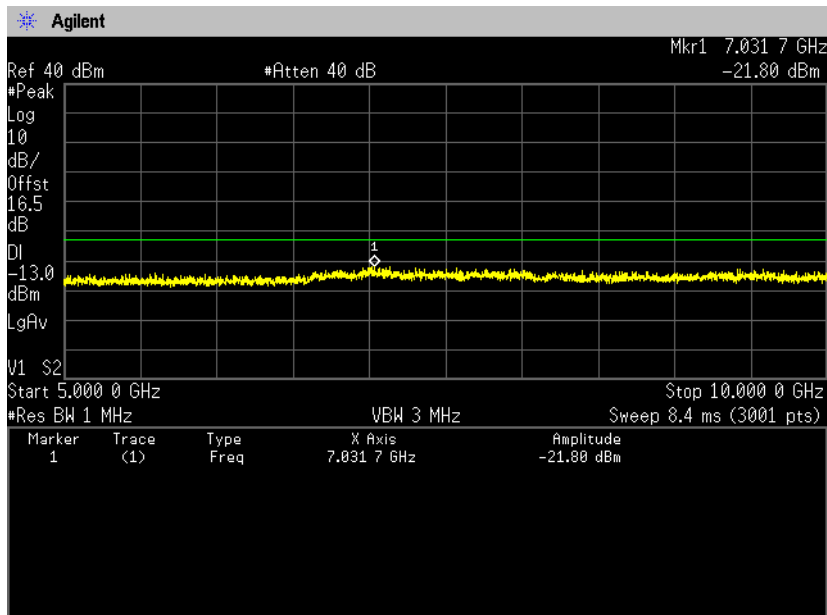

9. Radiated Emissions and Harmonic Emissions

9.1 Measurement procedure

[FCC 27.53, 2.1053]

<Step 1>

The EUT and support equipment are placed on a 1 meter x 1.5 meter surface, 0.8 meter height FRP table. Radiated emission measurements are performed at 3 meter distance with the broadband antenna (Biconical antenna, Log periodic antenna and double ridged guide antenna). The antenna is positioned both the horizontal and vertical planes of polarization and height is varied 1 to 4 meters and stopped at height producing the maximum emission.

The bandwidth of the spectrum analyzer is set to 1MHz. The turntable is rotated by 360 degrees and stopped at azimuth of producing the maximum emission. The frequency is investigated up to 20GHz.

<Step 2>

The substitution antenna is replaced by the transmitter antenna (EUT).

The frequency of the signal generator is adjusted to the measurement frequency.

Level of the signal generator is adjusted to the level that is obtained from step 1, and record the emission level of signal generator.

Spectrum analyzer setting

- Detector: Peak (RBW: 1MHz, VBW: 3MHz)

- Test configuration

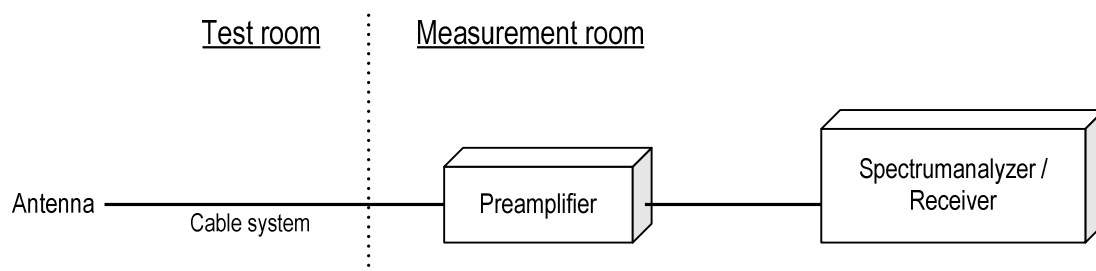

9.2 Calculation method

Result = S.G Reading – Cable loss + Antenna Gain

Margin = Limit – Result (ERP)

9.3 Limit

-13dBm or less

9.4 Test data

Date	: December 27, 2014	Test engineer	:	Hikaru Shibata
Temperature	: 17.6 [°C]			
Humidity	: 24.1 [%]			
Test place	: 3m Semi-anechoic chamber			
Date	: January 5, 2015	Test engineer	:	Hikaru Shibata
Temperature	: 15.1 [°C]			
Humidity	: 32.9 [%]			
Test place	: 3m Semi-anechoic chamber			
Date	: January 9, 2015	Test engineer	:	Taiki Watanabe
Temperature	: 20.1 [°C]			
Humidity	: 27.1 [%]			
Test place	: 3m Semi-anechoic chamber			

[LTE Band X VII] QPSK, BW 5MHz Channel: 23775

H/V	Frequency [MHz]	S.A Reading [dBm]	S.G Reading [dBm]	Cable loss [dB]	Ant.Gain [dBi]	Result [dBm]	Limit [dBm]	Margin [dB]
H	2113.0	-55.8	-75.5	1.2	6.7	-70.0	-13.0	57.0
V	2113.0	-58.4	-69.6	1.2	6.7	-64.1	-13.0	51.1

Channel: 23790

H/V	Frequency [MHz]	S.A Reading [dBm]	S.G Reading [dBm]	Cable loss [dB]	Ant.Gain [dBi]	Result [dBm]	Limit [dBm]	Margin [dB]
H	1420.0	-59.6	-79.5	1.0	5.9	-74.5	-13.0	61.5
H	2123.0	-57.9	-75.8	1.2	6.7	-70.2	-13.0	57.2
V	2123.0	-60.7	-79.8	1.2	6.7	-74.2	-13.0	61.2

Channel: 23825

H/V	Frequency [MHz]	S.A Reading [dBm]	S.G Reading [dBm]	Cable loss [dB]	Ant.Gain [dBi]	Result [dBm]	Limit [dBm]	Margin [dB]
H	2134.0	-57.4	-70.1	1.2	6.8	-64.4	-13.0	51.4
V	2134.0	-60.7	-73.1	1.2	6.8	-67.4	-13.0	54.4

16QAM, BW 5MHz**Channel: 23775**

H/V	Frequency [MHz]	S.A Reading [dBm]	S.G Reading [dBm]	Cable loss [dB]	Ant.Gain [dBi]	Result [dBm]	Limit [dBm]	Margin [dB]
H	1413.0	-60.4	-74.5	1.0	5.9	-69.6	-13.0	56.6

Channel: 23790

H/V	Frequency [MHz]	S.A Reading [dBm]	S.G Reading [dBm]	Cable loss [dB]	Ant.Gain [dBi]	Result [dBm]	Limit [dBm]	Margin [dB]
H	1416.0	-57.6	-68.1	1.0	5.9	-63.2	-13.0	50.2
H	2123.0	-59.8	-72.5	1.2	6.7	-66.9	-13.0	53.9

Channel: 23825

H/V	Frequency [MHz]	S.A Reading [dBm]	S.G Reading [dBm]	Cable loss [dB]	Ant.Gain [dBi]	Result [dBm]	Limit [dBm]	Margin [dB]
H	1426.0	-57.9	-72.8	1.0	6.0	-67.8	-13.0	54.8
H	2134.0	-57.6	-70.3	1.2	6.8	-64.6	-13.0	51.6

QPSK, BW 10MHz**Channel: 23780**

H/V	Frequency [MHz]	S.A Reading [dBm]	S.G Reading [dBm]	Cable loss [dB]	Ant.Gain [dBi]	Result [dBm]	Limit [dBm]	Margin [dB]
H	2124.0	-58.7	-78.4	1.2	6.8	-72.8	-13.0	59.8

Channel: 23790

H/V	Frequency [MHz]	S.A Reading [dBm]	S.G Reading [dBm]	Cable loss [dB]	Ant.Gain [dBi]	Result [dBm]	Limit [dBm]	Margin [dB]
H	2117.0	-59.3	-75.7	1.2	6.7	-70.2	-13.0	57.2

Channel: 23800

H/V	Frequency [MHz]	S.A Reading [dBm]	S.G Reading [dBm]	Cable loss [dB]	Ant.Gain [dBi]	Result [dBm]	Limit [dBm]	Margin [dB]
H	1413.0	-57.7	-72.6	1.0	5.9	-67.7	-13.0	54.7
H	2120.0	-58.2	-70.3	1.2	6.7	-64.8	-13.0	51.8

16QAM, BW 10MHz**Channel: 23780**

H/V	Frequency [MHz]	S.A Reading [dBm]	S.G Reading [dBm]	Cable loss [dB]	Ant.Gain [dBi]	Result [dBm]	Limit [dBm]	Margin [dB]
H	1418.0	-60.8	-75.5	1.0	5.9	-70.5	-13.0	57.5
V	1418.0	-61.2	-69.9	1.0	5.9	-64.9	-13.0	51.9

Channel: 23790

H/V	Frequency [MHz]	S.A Reading [dBm]	S.G Reading [dBm]	Cable loss [dB]	Ant.Gain [dBi]	Result [dBm]	Limit [dBm]	Margin [dB]
H	2117.0	-58.4	-74.8	1.2	6.7	-69.3	-13.0	56.3

Channel: 23800

H/V	Frequency [MHz]	S.A Reading [dBm]	S.G Reading [dBm]	Cable loss [dB]	Ant.Gain [dBi]	Result [dBm]	Limit [dBm]	Margin [dB]
H	2120.0	-53.6	-71.5	1.2	6.7	-66.0	-13.0	53.0

10. Frequency Stability

10.1 Measurement procedure [FCC 27.54, 2.1055]

The EUT was placed inside of a constant temperature chamber as the temperature in the chamber was varied between -30°C and $+50^{\circ}\text{C}$. The temperature was incremented by 10°C intervals and the unit was allowed to stabilize at each measurement. The frequency drift was measured with the normal Temperature and voltage tolerance and it is presented as the ppm unit.

- Test configuration

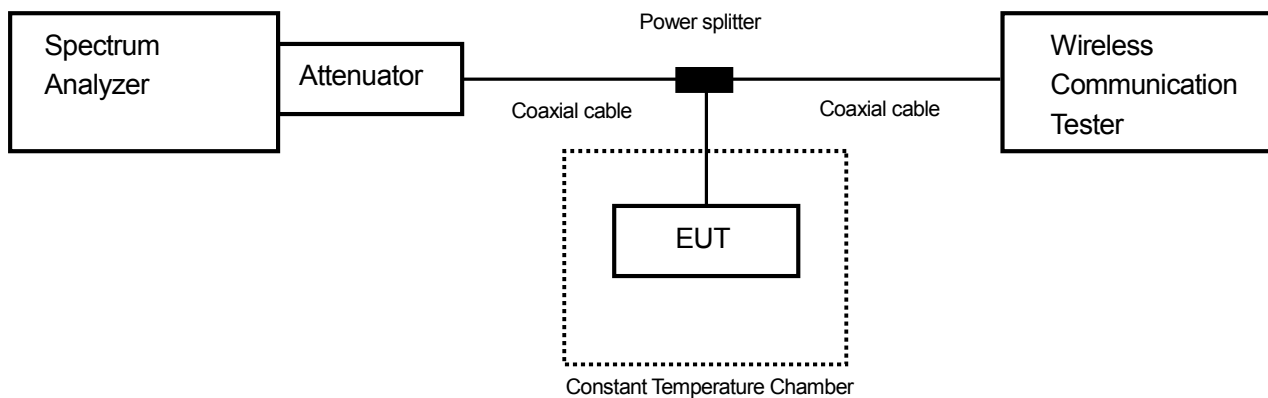

10.2 Limit

$\pm 2.5\text{ppm}$

10.3 Measurement result

Date : December 27, 2014
 Temperature : 22.5 [°C]
 Humidity : 46.0 [%]
 Test place : Shielded room No.4

Test engineer :

Hikaru Shibata

[LTE Band X VII] (Channel: 23790)

Calculation;

$$\text{Frequency Tolerance (ppm)} = \frac{\text{Measurements Frequency (Hz)} - \text{Reference Frequency (Hz)}}{\text{Reference Frequency (Hz)}} \times 1000000$$

Limit: $\pm 0.00025\% = \pm 2.5\text{ppm}$					
Power Supply [V]	Temperature [°C]	Measurements Frequency [Hz]	Frequency Tolerance [ppm]	Limit [ppm]	Result
3.80	25(Ref.)	709,995,609	0.00000	± 2.5	PASS
	50	709,995,591	-0.02535	± 2.5	PASS
	40	709,995,613	0.00563	± 2.5	PASS
	30	709,995,608	-0.00141	± 2.5	PASS
	20	709,995,887	0.39155	± 2.5	PASS
	10	709,995,616	0.00986	± 2.5	PASS
	0	709,996,095	0.68451	± 2.5	PASS
	-10	709,996,118	0.71691	± 2.5	PASS
	-20	709,996,207	0.84226	± 2.5	PASS
	-30	709,996,175	0.79719	± 2.5	PASS
3.230	25	709,995,589	-0.02817	± 2.5	PASS
4.370	25	709,995,617	0.01127	± 2.5	PASS



Zacta

11. Uncertainty of measurement

Expanded uncertainties stated are calculated with a coverage Factor $k=2$.

Please note that these results are not taken into account when determining compliance or non-compliance with test result.

Test item	Measurement uncertainty
Conducted emission at mains port	$\pm 3.0\text{dB}$
Radiated emission (9kHz – 30MHz)	$\pm 4.4\text{dB}$
Radiated emission (30MHz – 1000MHz)	$\pm 4.5\text{dB}$
Radiated emission (1000MHz – 26GHz)	$\pm 3.9\text{dB}$

12. Laboratory description

1. Location:

TÜV SÜD Zacta Ltd. Yonezawa Testing Center
 4149-7 Hachimanpara 5-chome Yonezawa-shi Yamagata 992-1128 Japan
 Phone: +81-238-28-2880 Fax: +81-238-28-2888

2. Facility filing information:

1) NVLAP accreditation: NVLAP Lab. code: 200306-0

2) VLAC accreditation: Lab. code: VLAC-013

Site name	Radiated emission	Conducted emission for mains port	Conducted emission for telecom port	Radiated emission (CMAD)	Expiry Date
3m Semi-anechoic chamber	VLAC-013	VLAC-013	VLAC-013	-	Jul. 3, 2015
10m Semi-anechoic chamber No.1				VLAC-013	
10m Semi-anechoic chamber No.2				VLAC-013	
Shielded room No.1	-	VLAC-013	-	-	

3) FCC filing:

Site name	Registration Number	Expiry Date
Site 3	91065	Oct.31, 2014
3m Semi-anechoic chamber	540072	Feb. 20, 2017
10m Semi-anechoic chamber No.1		
10m Semi-anechoic chamber No.2		
Shielded room No.1		

4) Industry Canada Oats site filing:

Site name	Sites on file: Oats 3m/10m	Expiry Date
Site 3	4224A-3	Jan. 23, 2015
3m Semi-anechoic chamber	4224A-4	
10m Semi-anechoic chamber No.1	4224A-5	
10m Semi-anechoic chamber No.2	4224A-6	Jan. 15, 2017

5) VCCI site filing:

Site name	Radiated emission	Conducted emission for mains port	Conducted emission for telecom port	Expiry Date
Site 3	R-138	C-134	T-1222	Nov. 16, 2014 Nov. 28, 2014* (*:Telecom port)
3m Semi-anechoic chamber	A-0166	A-0166	A-0166	Jul. 3, 2015
10m Semi-anechoic chamber No.1				
10m Semi-anechoic chamber No.2				
Shielded room No.1	-	A-0166		

6) TÜV SÜD PS authorization:

Authorized as an EMC test laboratory

7) TÜV Rheinland authorization:

Authorized as an EMC test laboratory



Appendix A. Test equipment

Antenna port conducted test

Equipment	Company	Model No.	Serial No.	Cal. due	Cal. date
Spectrum analyzer	Agilent Technologies	E4440A	US44302655	May 31, 2015	May 30, 2014
Microwave cable	RS	YH_13S5	N/A (S403)	May 31, 2015	May 10, 2014
Attenuator	Weinschel	56-10	J4180	Nov. 30, 2015	Nov. 12, 2014
Microwave cable	SUHNER	SUCOFLEX104/1.5m	199121/4	Oct. 31, 2015	Oct. 7, 2014
Microwave cable	SUHNER	SUCOFLEX104/1.5m	322086/4	Jul. 31, 2015	Jul. 30, 2014
Power splitter	ANRITSU	K240B	020205	Mar. 31, 2015	Mar. 17, 2014
Wideband radio frequency tester	ROHDE&SCHWARZ	CMW500	116338	Mar. 31, 2015	Mar. 7, 2014
Operation type temperature controlled bath	Espec	PL1KP	14007261	Dec. 31, 2014	Dec. 27, 2013

Radiated emission

Equipment	Company	Model No.	Serial No.	Cal. Due	Cal. Date
EMI Receiver	ROHDE&SCHWARZ	ESCI	100765	Aug. 31, 2015	Aug. 9, 2014
Preamplifier	ANRITSU	MH648A	M96057	Jun. 30, 2015	Jun. 12, 2014
Biconical antenna	Schwarzbeck	VHA9103/BBA9106	2125	May 31, 2015	May 7, 2014
Log periodic antenna	Schwarzbeck	UHALP9108A	0560	May 31, 2015	May 7, 2014
Attenuator	TME	CFA-01NPJ-6	N/A (S275)	Jun. 30, 2015	Jun. 9, 2014
Attenuator	TME	CFA-01NPJ-3	N/A (S272)	Jun. 30, 2015	Jun. 9, 2014
Spectrum analyzer	Agilent Technologies	E4440A	US44302655	May 31, 2015	May 30, 2014
Preamplifier	Agilent Technologies	8449B	3008A1008	Dec. 31, 2015	Dec. 5, 2014
Dipole antenna	Schwarzbeck	VHAP	1020	Sep. 30, 2015	Sep. 5, 2014
Dipole antenna	Schwarzbeck	UHAP	994	Sep. 30, 2015	Sep. 5, 2014
Double ridged guide antenna	EMCO	3115	5205	Dec. 31, 2015	Dec. 10, 2013
Attenuator	Agilent Technologies	8491B	MY39268633	Jan. 31, 2015	Jan. 15, 2014
Double ridged guide antenna	EMCO	3115	4328	Jan. 31, 2015	Jan. 21, 2014
Signal generator	ROHDE&SCHWARZ	SMB100A	177525	Feb. 28, 2015	Feb. 18, 2014
Power amplifier	R&K	CGA020M602-2633R	B40240	Mar.31, 2015	Mar. 7, 2014
Microwave cable	SUHNER	SUCOFELX102/2m	31648/2	Feb. 28, 2015	Feb. 13, 2014
High pass filter	Micro-Tronics	HPM50115	004	Jul. 31, 2015	Jul. 12, 2014
High pass filter	Wainwright	WHKX2.8/18G-6SS	1	Jul. 31, 2015	Jul. 17, 2014
Wideband radio frequency tester	ROHDE&SCHWARZ	CMW500	116338	Mar. 31, 2015	Mar. 7, 2014
Microwave cable	SUHNER	SUCOFLEX104/9m	346316/4	Oct. 31, 2015	Oct. 31, 2014
		SUCOFLEX104/1m	322084/4	Oct. 31, 2015	Oct. 31, 2014
		SUCOFLEX104/1.5m	317226/4	Oct. 31, 2015	Oct. 31, 2014
		SUCOFLEX104/7m	41625/6	Oct. 31, 2015	Oct. 31, 2014
PC	DELL	DIMENSION E521	75465BX	N/A	N/A
Software	TOYO Corporation	EP5/RE-AJ	0611193/V5.3.61	N/A	N/A
3m Semi-anechoic chamber	TOKIN	N/A	N/A (9002-NSA)	May 31, 2015	May 6, 2014
3m Semi-anechoic chamber	TOKIN	N/A	N/A (9002-SVSWR)	May 31, 2015	May 6, 2014

*: The calibrations of the above equipment are traceable to NIST or equivalent standards of the reference organizations.