



Zacta

# TEST REPORT

Report number : Z101C-14128

Issue date : December 26, 2014

The device, as described herewith, was tested pursuant to applicable test procedure and complies with the requirements of;

## FCC Part 24 Subpart E

The test results are traceable to the international or national standards.

Applicant	: KYOCERA Corporation
Equipment under test (EUT)	: Mobile Phone
Model number	: KC-S701
FCC ID	: JOYKYO701

Date of test : November 4, December 8, 11, 20, 2014  
 Test place : TÜV SÜD Zacta Ltd. Yonezawa Testing Center  
 4149-7 Hachimanpara 5-chome  
 Yonezawa-shi Yamagata 992-1128 Japan  
 Phone: +81-238-28-2880 Fax: +81-238-28-2888  
 Test results : Complied

The results in this report are applicable only to the equipment tested.  
 This report shall not be re-produced except in full without the written approval of TÜV SÜD Zacta Ltd.  
 This test report must not be used by client to claim product certification, approval, or endorsement by NVLAP, NIST, or any agency of the federal government.

Tested by : Chiaki Kanno Hikaru Shibata  
 Chiaki Kanno Hikaru Shibata

Taiki Watanabe  
 Taiki Watanabe

Authorized by : Eiji Akiba  
 Eiji Akiba  
 Deputy General Manager of EMC Technical Department

**NVLAP**<sup>®</sup>  
 NVLAP LAB CODE 200306-0



## ***Table of contents***

---

	<b>Page</b>
<b>1. Summary of Test .....</b>	<b>4</b>
1.1 Purpose of test .....	4
1.2 Standards .....	4
1.3 List of applied test to the EUT .....	4
1.4 Modification to the EUT by laboratory .....	4
<b>2. Equipment Under Test .....</b>	<b>5</b>
2.1 General Description of equipment .....	5
2.2 EUT information .....	5
2.3 Variation of the family model(s) .....	6
2.4 Description of Test mode .....	6
<b>3. Configuration of equipment .....</b>	<b>7</b>
3.1 Equipment(s) used .....	7
3.2 System configuration .....	7
<b>4. Conducted Output Power .....</b>	<b>8</b>
4.1 Measurement procedure .....	8
4.2 Measurement result .....	8
<b>5. Equivalent Isotropic Radiated Power .....</b>	<b>10</b>
5.1 Measurement procedure .....	10
5.2 Calculation method .....	10
5.3 Limit .....	10
5.4 Test data .....	11
<b>6. Peak to Average Ratio .....</b>	<b>12</b>
6.1 Measurement procedure .....	12
6.2 Limit .....	12
6.3 Measurement result .....	12
6.4 Trace data .....	13
<b>7. Occupied Bandwidth .....</b>	<b>15</b>
7.1 Measurement procedure .....	15
7.2 Limit .....	15
7.3 Measurement result .....	15
7.4 Trace data .....	16
<b>8. Band Edge Spurious and Harmonic at Antenna Terminals .....</b>	<b>18</b>
8.1 Measurement procedure .....	18
8.2 Limit .....	18
8.3 Measurement result .....	18
8.4 Trace data .....	19
<b>9. Radiated Emissions and Harmonic Emissions .....</b>	<b>28</b>
9.1 Measurement procedure .....	28
9.2 Calculation method .....	28
9.3 Limit .....	28
9.4 Test data .....	29
<b>10. Frequency Stability .....</b>	<b>31</b>
10.1 Measurement procedure .....	31



Zacta

<b>10.2 Limit.....</b>	<b>31</b>
<b>10.3 Measurement result.....</b>	<b>32</b>
<b>11. Uncertainty of measurement .....</b>	<b>33</b>
<b>12. Laboratory description .....</b>	<b>34</b>
<b>Appendix A. Test equipment .....</b>	<b>35</b>

## 1. Summary of Test

---

### 1.1 Purpose of test

It is the original test in order to verify conformance to FCC Part 24 Subpart E.

### 1.2 Standards

CFR47 FCC Part 24 Subpart E

#### 1.2.1 Test Methods

ANSI/TIA/EIA-603-C-2004

#### 1.2.2 Deviation from standards

None

### 1.3 List of applied test to the EUT

Test items Section	Test items	Condition	Result
2.1046	Conducted Output Power	Conducted	PASS
24.232(c)	Effective Radiated Power Equivalent Isotropic Radiated Power	Radiated	PASS
24.232(d)	Peak to Average Ratio	Conducted	PASS
24.238(a) 2.1049	Occupied Bandwidth	Conducted	PASS
24.238(a) 2.1051	Band Edge Spurious and Harmonic at Antenna Terminal	Conducted	PASS
24.238(a) 2.1053	Radiated emissions and Harmonic Emissions	Radiated	PASS
24.235 2.1055	Frequency Stability	Conducted	PASS

#### 1.3.1 Test set up

Table-Top

### 1.4 Modification to the EUT by laboratory

None



Zacta

## 2. Equipment Under Test

---

### 2.1 General Description of equipment

EUT is the Mobile Phone.

### 2.2 EUT information

Applicant	:	KYOCERA Corporation Yokohama Office 2-1-1 Kagahara, Tsuzuki-ku Yokohama-shi, Kanagawa, Japan Phone: +81-45-943-6253 Fax: +81-45-943-6314
Equipment under test	:	Mobile Phone
Trade name	:	Kyocera
Model number	:	KC-S701
Serial number	:	N/A
EUT condition	:	Pre-Production
Power ratings	:	Battery: DC 3.8V
Size	:	(W) 69.0 × (D) 13.5 × (H) 136.0 mm
Environment	:	Indoor and Outdoor use
Terminal limitation	:	-20°C to 60°C
RF Specification	:	
Frequency of Operation	:	Up Link GSM1900: 1850.2-1909.8MHz WCDMA Band II: 1852.4-1907.6MHz
	:	Down Link GSM1900: 1930.2-1989.8MHz WCDMA Band II: 1932.4-1987.6MHz
Modulation type	:	GSM1900: GMSK WCDMA Band II: QPSK, 16QAM
Emission designator	:	GSM1900: 248KGXW WCDMA Band II: 4M16F9W
Output power	:	GSM1900: 1.549W EIRP (31.9dBm) WCDMA Band II: 1.259W EIRP (31.0dBm)
Antenna type	:	Internal antenna
Antenna gain	:	GSM1900: -1.2dBi WCDMA Band II: -1.2dBi

### 2.3 Variation of the family model(s)

Not applicable

### 2.4 Description of Test mode

The EUT had been tested under operating condition.  
There are three channels have been tested as following:

Band	Channel	Frequency
GSM1900	512	1850.2MHz
	661	1880.0MHz
	810	1909.8MHz
WCDMA Band II	9262	1852.4MHz
	9400	1880.0MHz
	9538	1907.6MHz

The field strength of spurious emissions was measured at each position of all three axis X, Y and Z to compare the level, and the maximum noise.  
The worst emission was found in X axis and the worst case recorded.



Zacta

### ***3. Configuration of equipment***

---

#### **3.1 Equipment(s) used**

<b>No.</b>	<b>Equipment</b>	<b>Company</b>	<b>Model No.</b>	<b>Serial No.</b>	<b>FCC ID / DoC</b>	<b>Comment</b>
1	Mobile Phone	KYOCERA	KC-S701	N/A	JOYKYO701	EUT

#### **3.2 System configuration**

1. Mobile Phone  
(EUT)

Note1: Numbers assigned to equipment or cables on this diagram correspond to the list in "3.1 Equipment(s) used".

## 4. Conducted Output Power

### 4.1 Measurement procedure [FCC 2.1046]

The conducted output power was measured with a wireless communication tester connected to the antenna terminal. The wireless communication tester parameters were set to produce the maximum power from the EUT.

- Test configuration

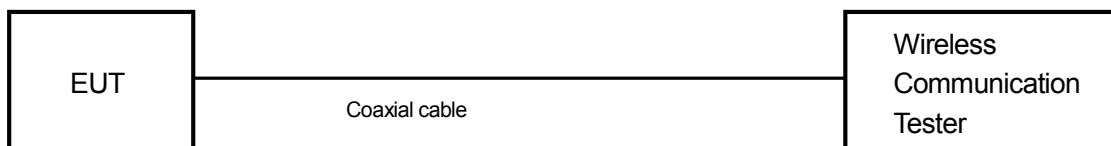

### 4.2 Measurement result

Date : November 4, 2014  
 Temperature : 22.0 [°C]  
 Humidity : 46.0 [%]  
 Test place : Shielded room No.4

Test engineer : Chiaki Kanno

Band	Channel	Frequency [MHz]	Maximum Burst-Averaged Output Power [dBm]				
			Voice GSM CS 1slot	GPRS/EDGE(GMSK)Data			
				GPRS 1 TX Slot	GPRS 2 TX Slot	GPRS 3 TX Slot	GPRS 4 TX Slot
PCS 1900	512	1850.2	<u>29.78</u>	29.68	28.77	26.67	25.61
	661	1880.0	29.75	29.75	28.56	26.65	25.55
	810	1909.8	29.77	29.75	28.80	26.82	25.79





Zacta

Date : November 4, 2014  
 Temperature : 22.0 [°C]  
 Humidity : 46.0 [%]  
 Test place : Shielded room No.4

Test engineer :

Chiaki Kanno

3GPP Release Version	Mode		Sub- Test	Cellular Band [dBm]			MPR	Bc	βd	Bc/βd
	Channel			9262	9400	9538				
	Frequency [MHz]			1852.4	1880.0	1907.6				
99	W-CDMA	RMC	-	22.59	22.52	<u>22.61</u>	-	-	-	-
		AMR	-	22.44	22.44	22.59	-	-	-	-
5	HSDPA	1	1	21.62	21.48	21.62	0	2/15	15/15	2/15
5		2	2	21.57	21.53	21.53	0	12/15	15/15	12/15
5		3	3	21.00	21.00	21.14	0.5	15/15	8/15	15/8
5		4	4	20.99	20.89	21.12	0.5	15/15	4/15	15/4
6	HSUPA	1	1	21.17	21.28	20.96	0	11/15	15/15	11/15
6		2	2	20.06	20.05	20.22	2	6/15	15/15	6/15
6		3	3	20.18	20.14	20.23	1	15/15	9/15	15/9
6		4	4	20.58	20.53	20.15	2	2/15	15/15	2/15
6		5	5	21.58	21.45	21.62	0	15/15	15/15	15/15

## 5. Equivalent Isotropic Radiated Power

### 5.1 Measurement procedure [FCC 24.232(c)]

#### <Step 1>

The EUT and support equipment are placed on a 1 meter x 1.5 meter surface, 0.8 meter height FRP table. Radiated emission measurements are performed at 3 meter distance with the broadband antenna (double ridged guide antenna). The antenna is positioned both the horizontal and vertical planes of polarization and height is varied 1 to 4 meters and stopped at height producing the maximum emission. The bandwidth of the spectrum analyzer is set to 1MHz. The turntable is rotated by 360 degrees and stopped at azimuth of producing the maximum emission.

#### <Step 2>

The substitution antenna is replaced by the transmitter antenna (EUT). The frequency of the signal generator is adjusted to the measurement frequency. Level of the signal generator is adjusted to the level that is obtained from step 1, and record the emission level of signal generator.

#### Spectrum analyzer setting

- Detector: Peak (RBW: 3MHz, VBW: 8MHz): GSM
- Detector: Peak (RBW: 5MHz, VBW: 8MHz): WCDMA

#### - Test configuration

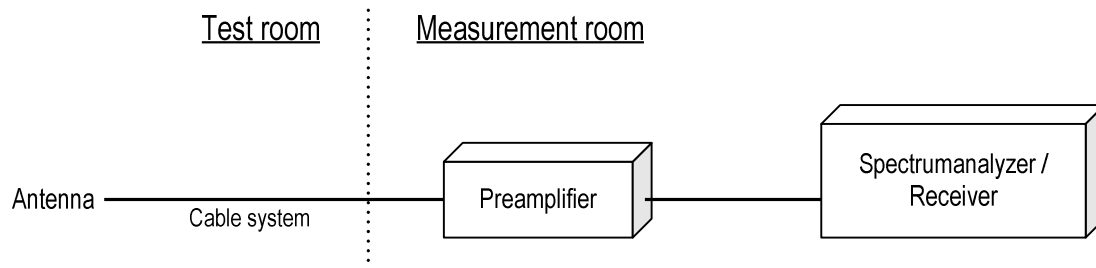

### 5.2 Calculation method

Result (EIRP) = S.G Reading – Cable loss + Antenna Gain

Margin = Limit – Result (EIRP)

### 5.3 Limit

2 W (33dBm)



Zacta

## 5.4 Test data

Date : December 20, 2014                      Test personnel :  
 Temperature : 20.1 [°C]  
 Humidity : 27,1 [%]                              Tested by :  
 Test place : 3m Semi-anechoic chamber                      Taiki Watanabe

### [GSM1900]

H/V	Frequency [MHz]	S.A Reading [dBm]	S.G Reading [dBm]	Cable loss [dB]	Ant.Gain [dBi]	Result [dBm]	Limit [dBm]	Margin [dB]
V	1850.2	-13.2	24.7	1.1	8.2	31.8	33.0	1.2
V	1880.0	-13.6	24.7	1.1	8.4	31.9	33.0	1.1
H	1909.8	-15.3	22.1	1.1	8.5	29.5	33.0	3.5

### [WCDMA Band II]

H/V	Frequency [MHz]	S.A Reading [dBm]	S.G Reading [dBm]	Cable loss [dB]	Ant.Gain [dBi]	Result [dBm]	Limit [dBm]	Margin [dB]
H	1852.4	-18.6	21.6	1.1	8.2	28.7	33.0	4.3
H	1880.0	-16.2	23.8	1.1	8.4	31.0	33.0	2.0
H	1907.6	-16.9	22.5	1.1	8.5	29.8	33.0	3.2

## 6. Peak to Average Ratio

### 6.1 Measurement procedure [FCC 24.232(d)]

The peak to average ratio was measured with a spectrum analyzer connected to the antenna terminal.

The spectrum analyzer is set to;

- RBW=1MHz, VBW=3MHz, Span=5MHz, Sweep=auto, Detector=Peak/average, Trace mode=Max hold
- Power Start CCDF (WCDMA Band II)

- Test configuration

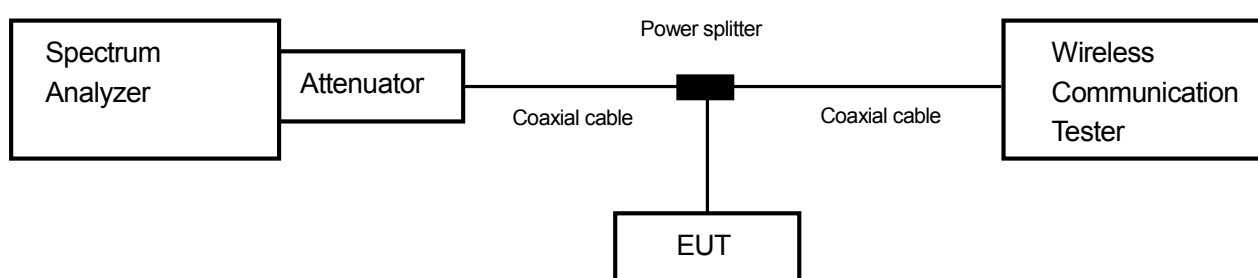

### 6.2 Limit

13dB or less

### 6.3 Measurement result

Date : December 11, 2014

Temperature : 25.1 [°C]

Humidity : 46.6 [%]

Test place : Shielded room No.4

Test engineer :

Hikaru Shibata

Mode	Channel	Frequency [MHz]	Peak to Average Power Ratio [dB]	Limit [dB]
GSM1900	512	1850.2	0.01	13.0
	661	1880.0	0.03	
	810	1909.8	0.02	
WCDMA Band II	9262	1852.4	3.26	13.0
	9400	1880.0	3.46	
	9538	1907.6	3.27	



Zacta

6.4 Trace data  
[GSM1900]

Channel: 512

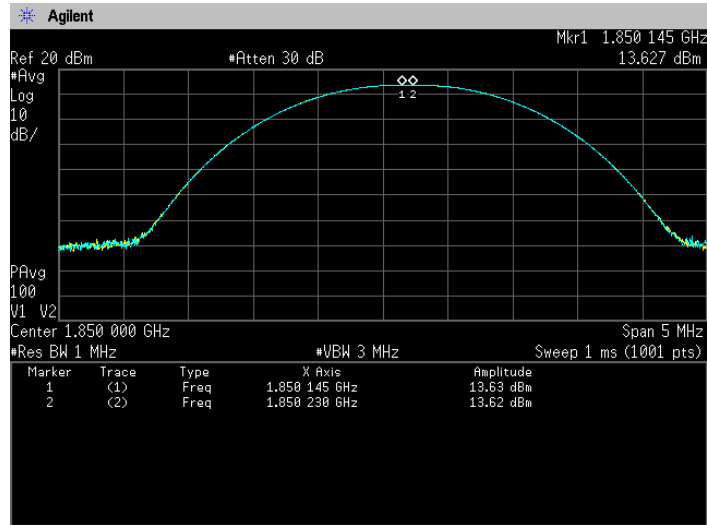

Channel: 661

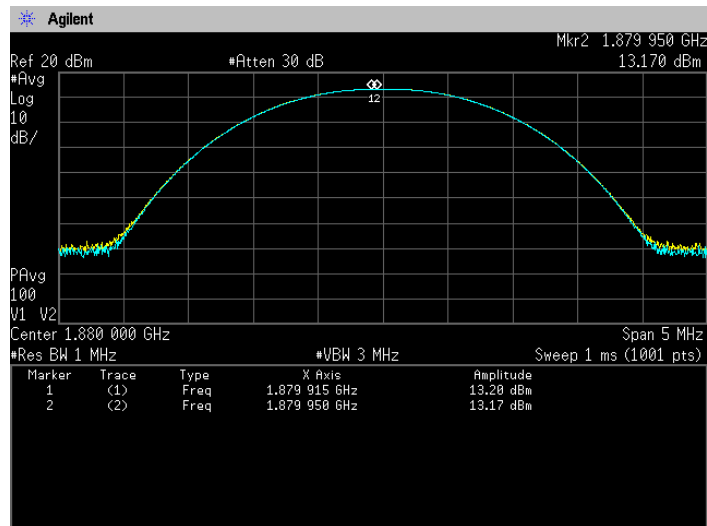

Channel: 810

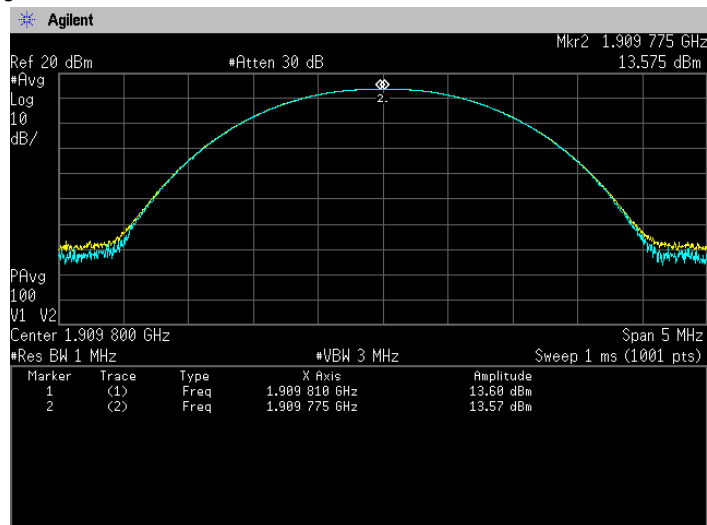



Zacta

[WCDMA Band II]  
Channel: 9262

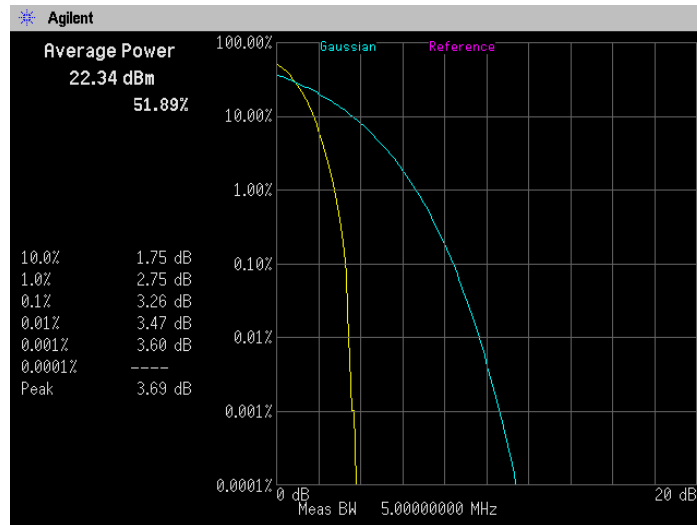

Channel: 9400

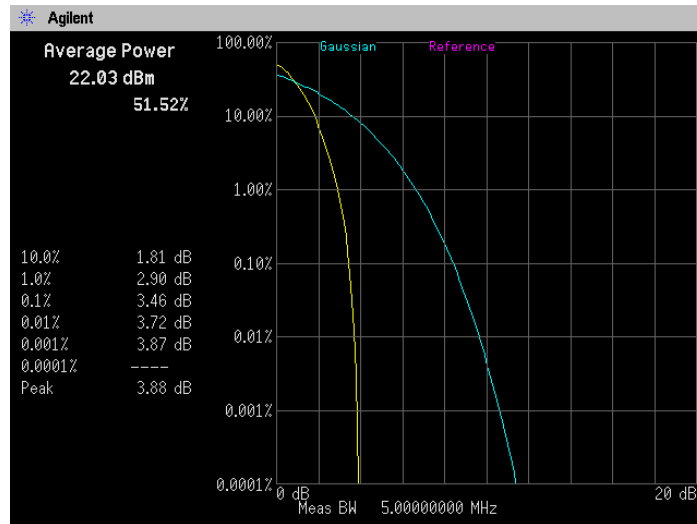

Channel: 9538

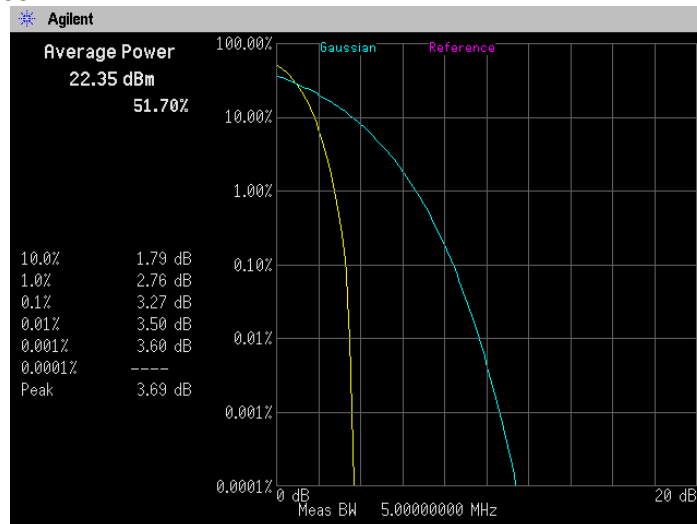

## 7. Occupied Bandwidth

### 7.1 Measurement procedure [FCC 24.238(a), 2.1049]

The Occupied bandwidth was measured with a spectrum analyzer connected to the antenna terminal.

The spectrum analyzer is set to;

- RBW=3kHz, VBW=9.1kHz, Span=1MHz, Sweep=auto, Detector=Peak, Trace mode=Max hold
- RBW=51kHz, VBW=150kHz, Span=10MHz, Sweep=auto, Detector=Peak, Trace mode=Max hold

- Test configuration

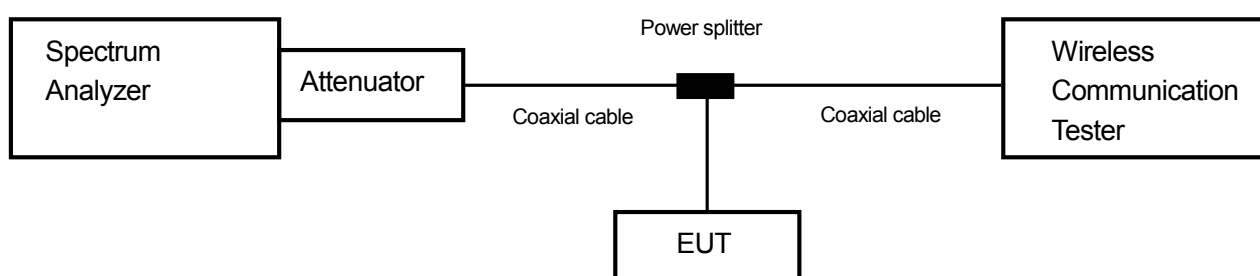

### 7.2 Limit

None

### 7.3 Measurement result

Date : December 25, 2014

Temperature : 25.1 [°C]

Humidity : 46.6 [%]

Test place : Shielded room No.4

Test engineer :

Hikaru Shibata

Band	Channel	Frequency (MHz)	Test Result (kHz)
GSM1900	512	1850.2	242.9978
	661	1880.0	247.8045
	810	1909.8	243.0276

Band	Channel	Frequency (MHz)	Test Result (MHz)
WCDMA Band II	9262	1852.4	4.1394
	9400	1880.0	4.1368
	9538	1907.6	4.1550



Zacta

7.4 Trace data  
[GSM1900]

Channel: 512

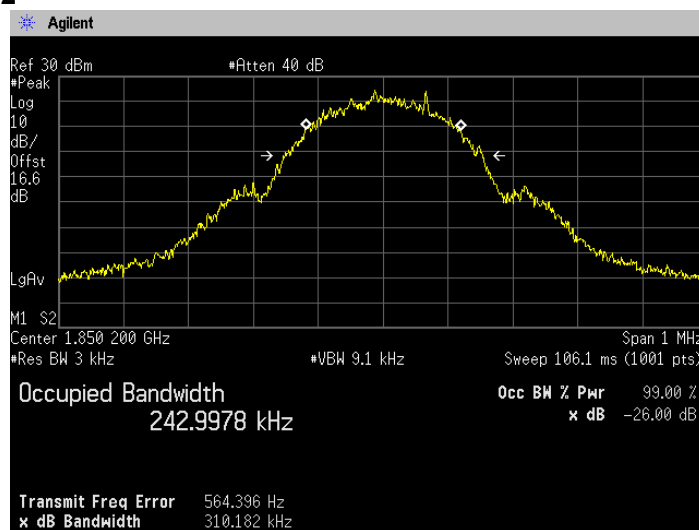

Channel: 661

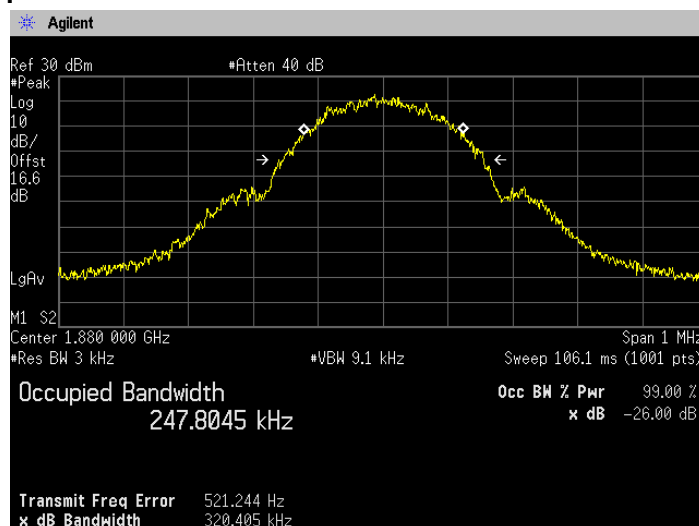

Channel: 810

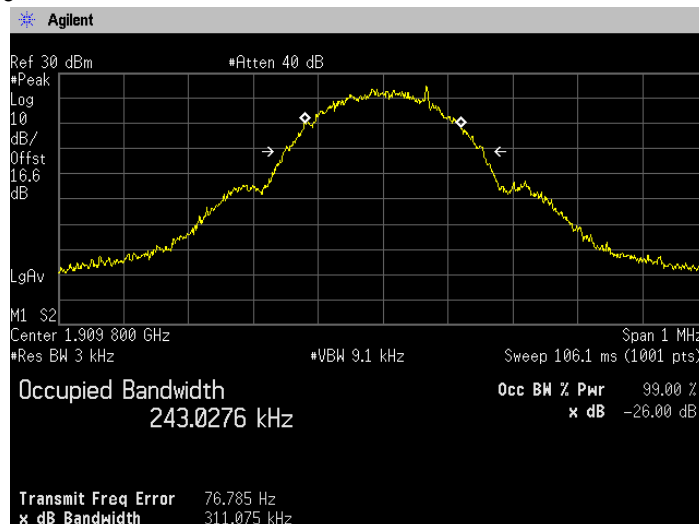





Zacta

[WCDMA]

Channel: 9262

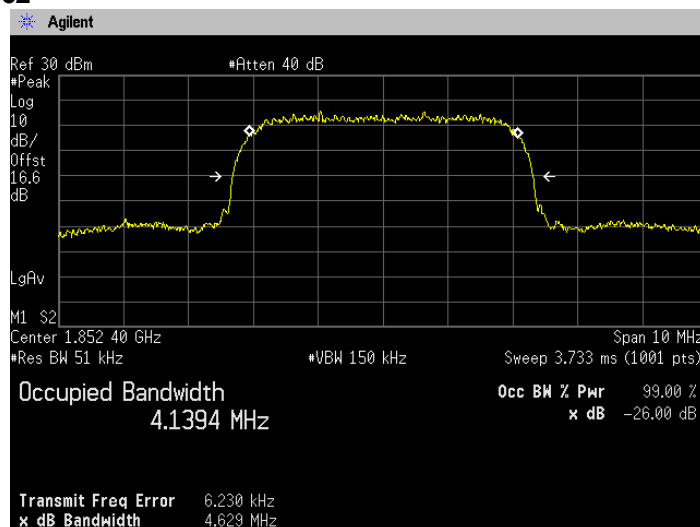

Channel: 9400

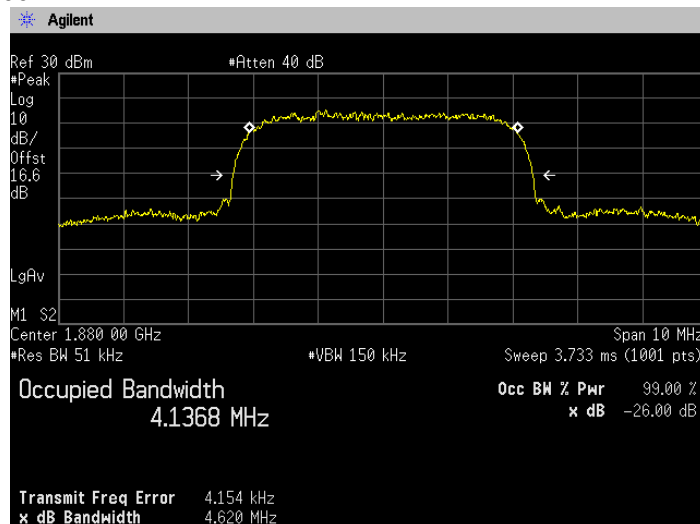

Channel: 9538

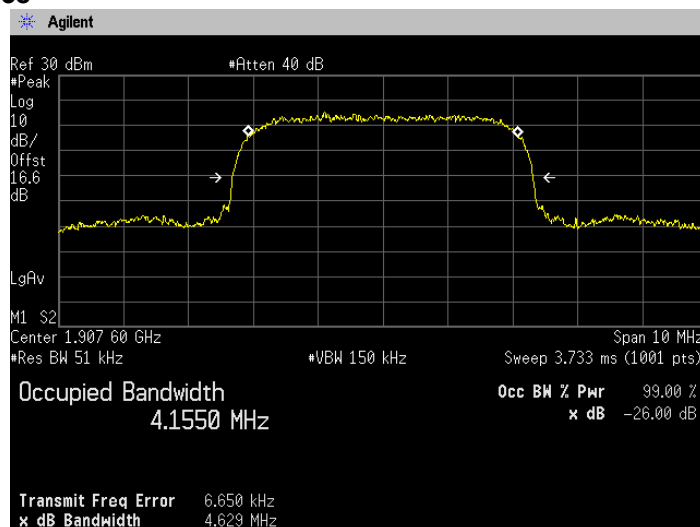

## 8. Band Edge Spurious and Harmonic at Antenna Terminals

### 8.1 Measurement procedure [FCC 24.238(a), 2.1051]

The band edge spurious and harmonic was measured with a spectrum analyzer connected to the antenna terminal.

The spectrum analyzer is set to;

<Band Edge>

- RBW=3kHz, VBW=9.1kHz, Span=1MHz, Sweep=auto, Detector=Peak, Trace mode=Max hold
- RBW=51kHz, VBW=150kHz, Span=10MHz, Sweep=auto, Detector=Peak, Trace mode=Max hold

<Spurious Emissions>

- RBW=1MHz, VBW=3MHz, Span=Arbitrary setting, Sweep=auto, Detector=Peak, Trace mode=Max hold

- Test configuration

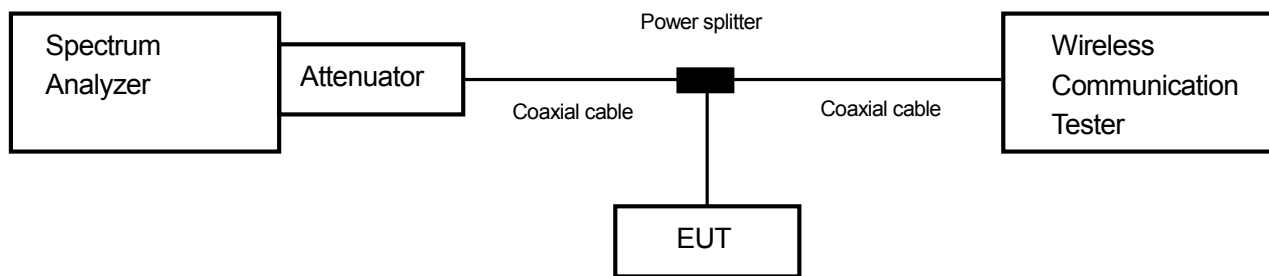

### 8.2 Limit

-13dBm or less

### 8.3 Measurement result

Date : December 11, 2014  
 Temperature : 25.1 [°C]  
 Humidity : 46.6 [%]  
 Test place : Shielded room No.4

Test engineer : Hikaru Shibata

Band	Channel	Frequency [MHz]	Limit [dB]	Results	Results
GSM1900	512	1850.2	-13.0	See the trace data	PASS
	810	1909.8	-13.0	See the trace data	PASS
WCDMA Band II	9262	1852.4	-13.0	See the trace data	PASS
	9538	1907.6	-13.0	See the trace data	PASS



Zacta

**8.4 Trace data  
[GSM1900]  
(Band Edge)**

**Channel: 512**

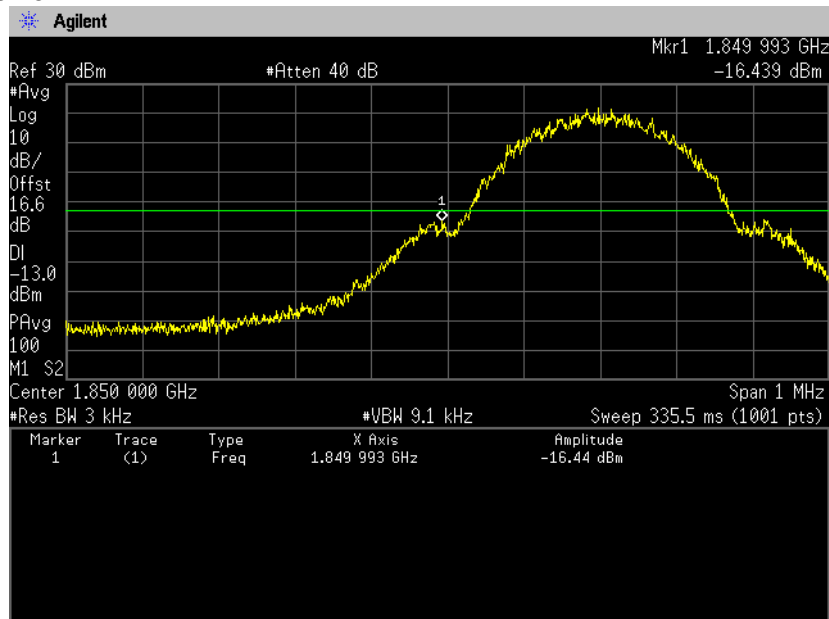

**Channel: 810**

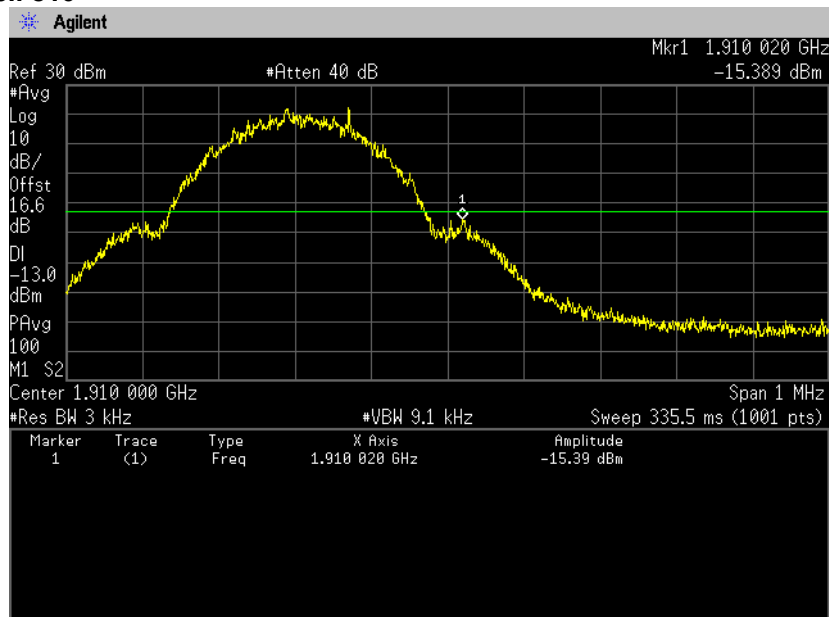



Zacta

**(Spurious Emissions)**

**Channel: 512**

**30MHz-5GHz**

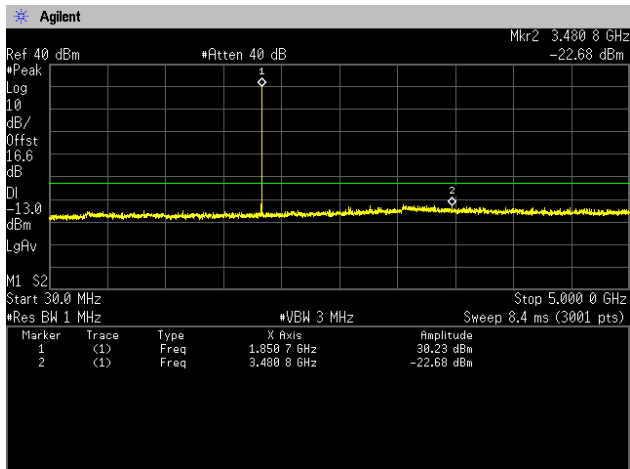

**5GHz-10GHz**

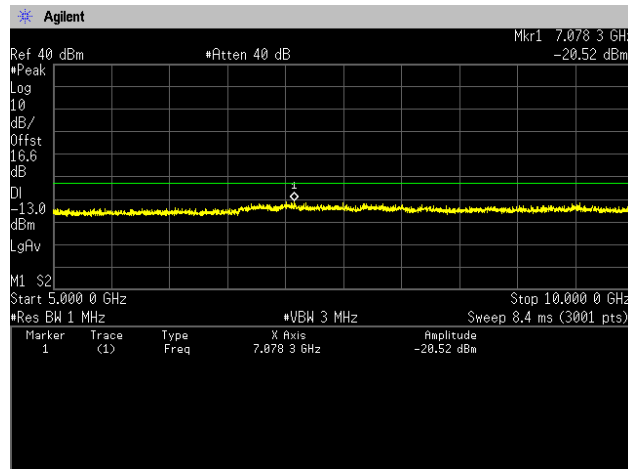

**10GHz-15GHz**

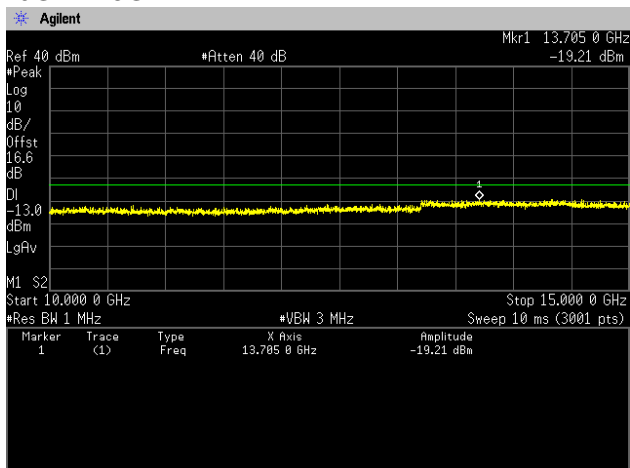

**15GHz-20GHz**

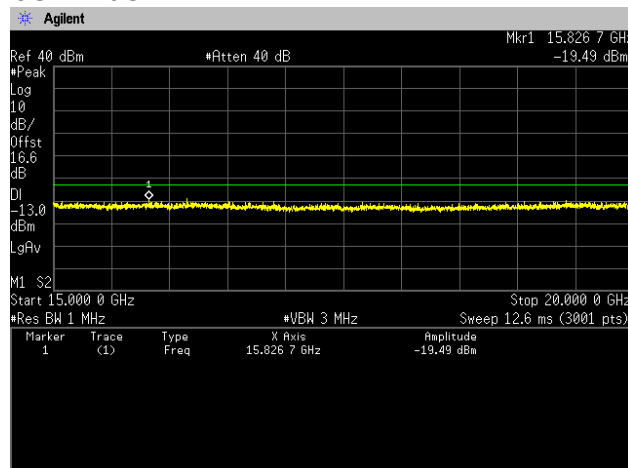



Zacta

**Channel: 661  
30MHz-5GHz**

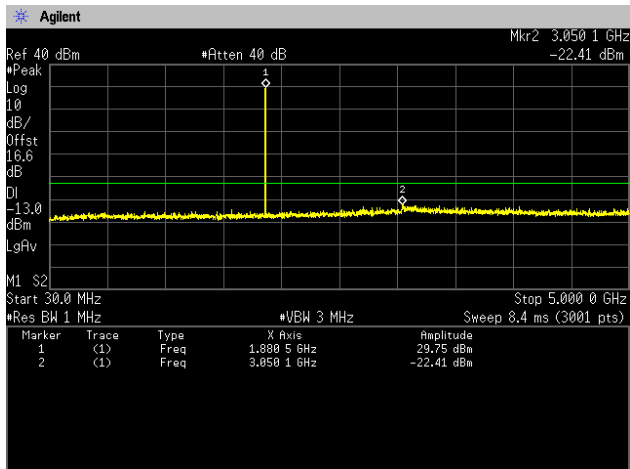

**5GHz-10GHz**

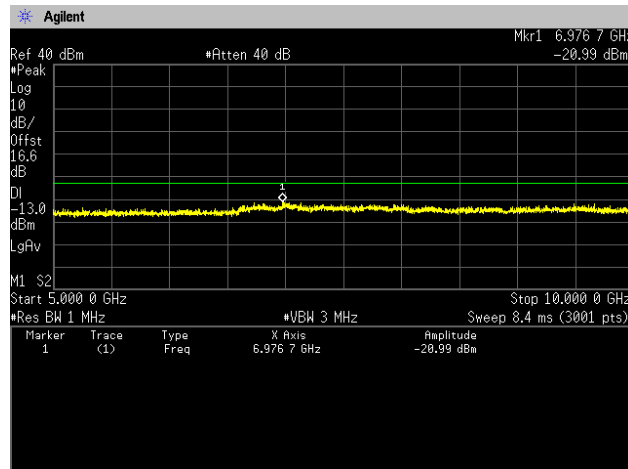

**10GHz-15GHz**

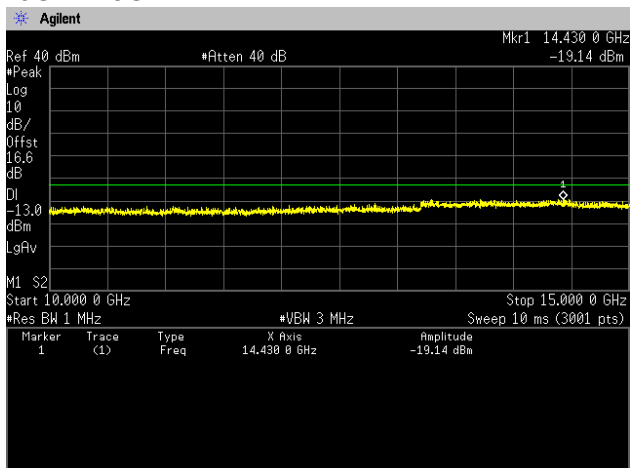

**15GHz-20GHz**

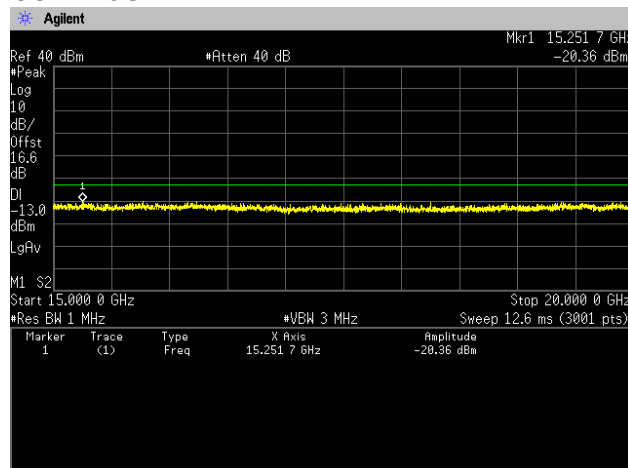



Zacta

**Channel: 810  
30MHz-5GHz**

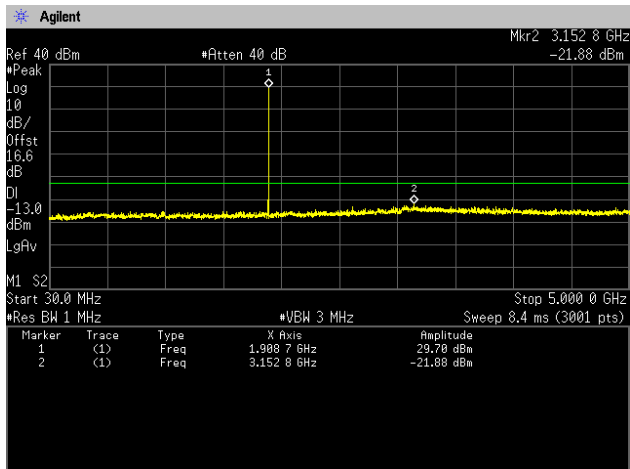

**5GHz-10GHz**

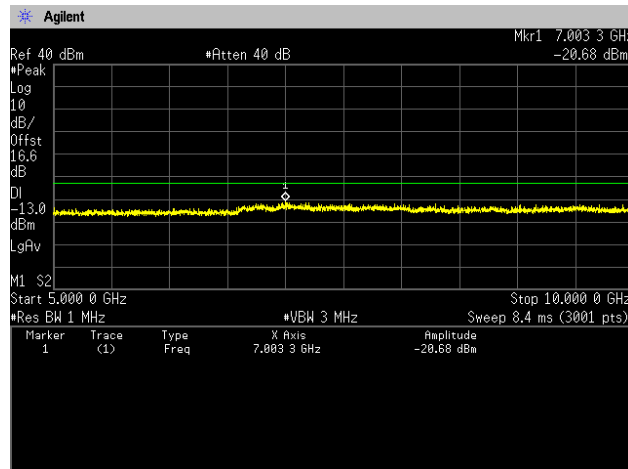

**10GHz-15GHz**

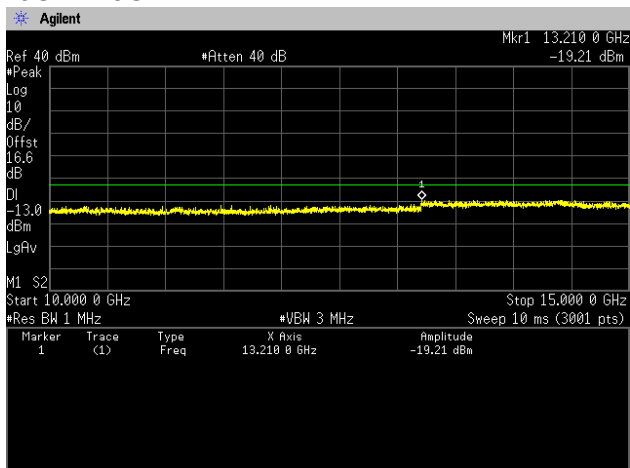

**15GHz-20GHz**

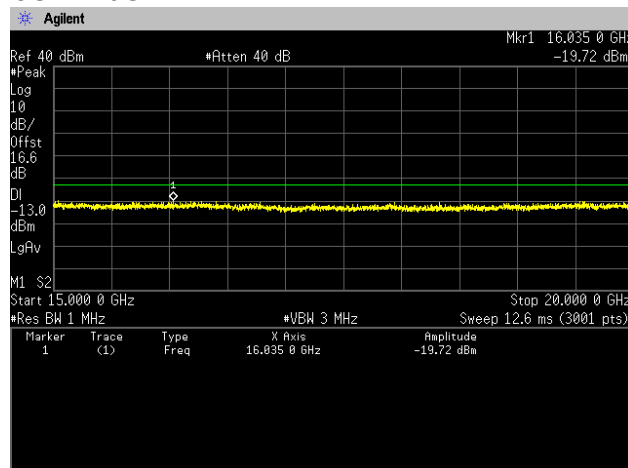



Zacta

**[WCDMA Band II]  
(Band Edge)  
Channel: 9262**

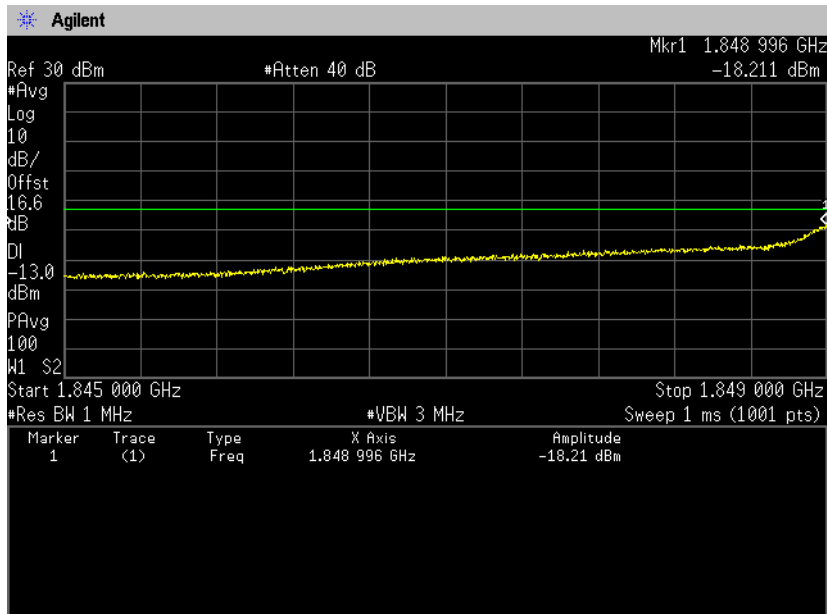
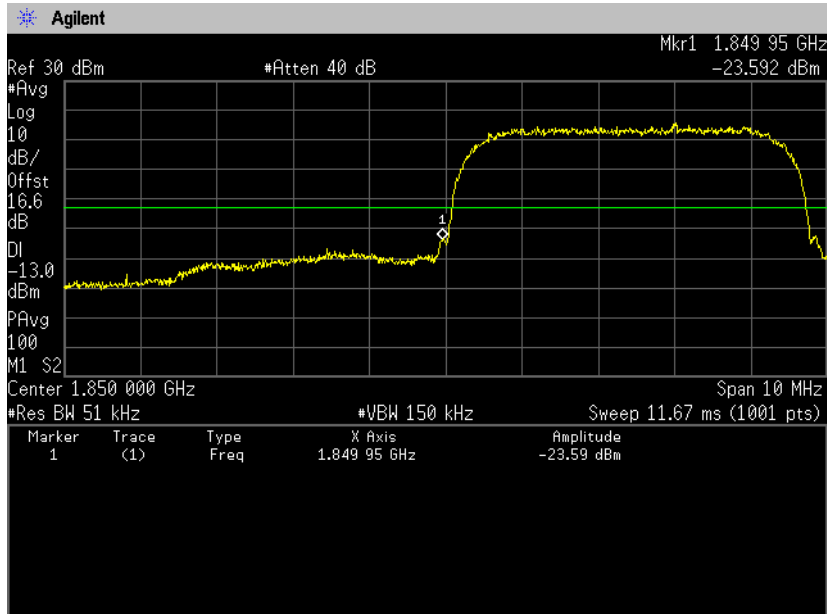



Zacta

**Channel: 9538**

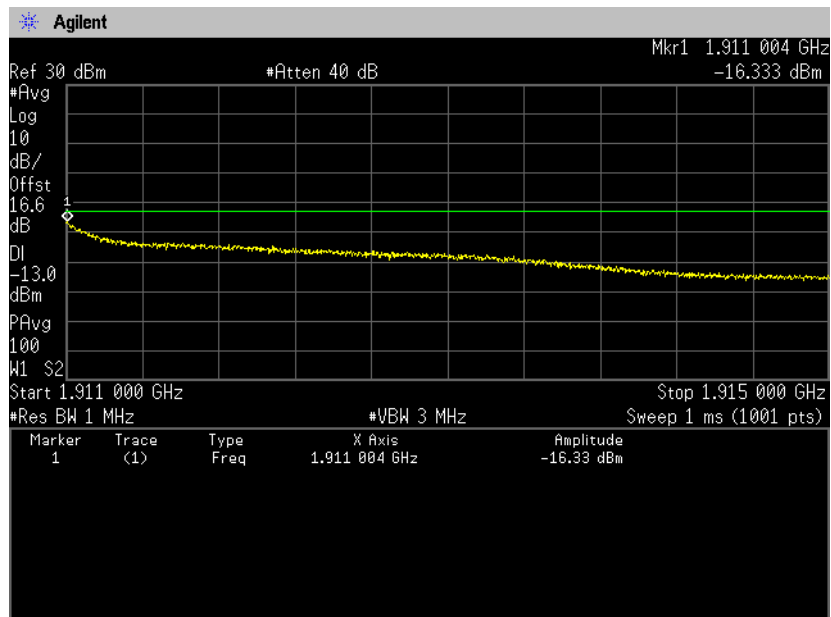
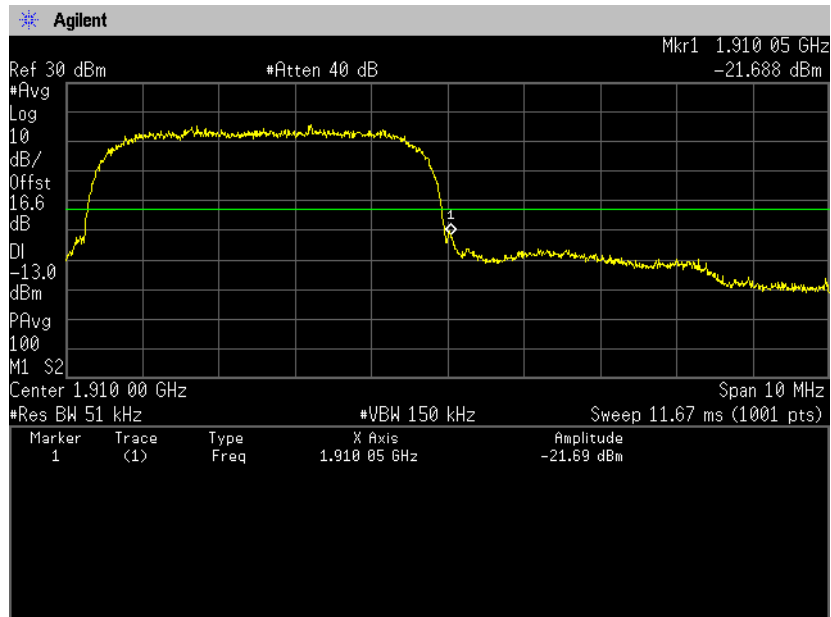





Zacta

**(Spurious Emissions)**

**Channel: 9262**

**30MHz-5GHz**

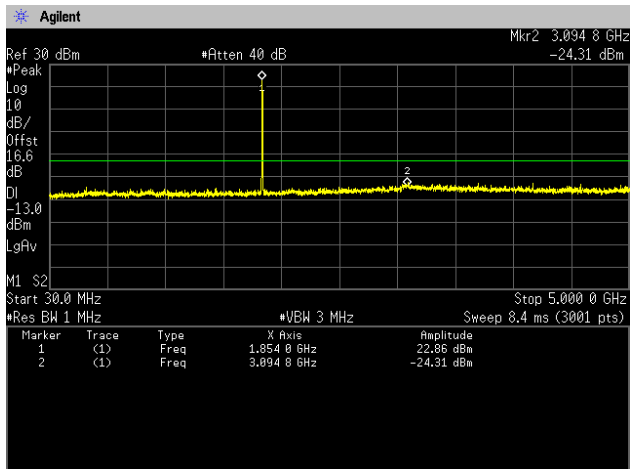

**5GHz-10GHz**

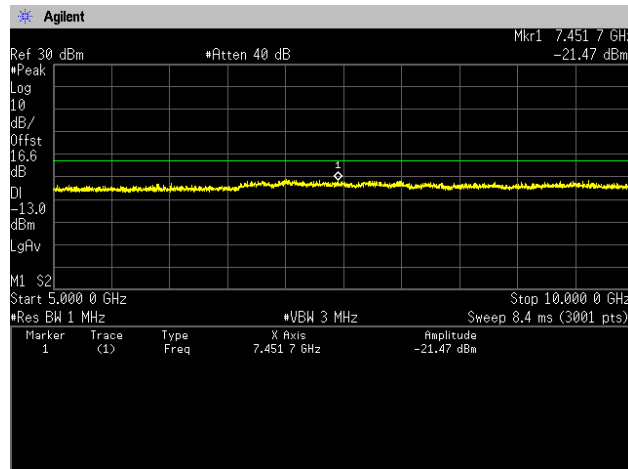

**10GHz-15GHz**

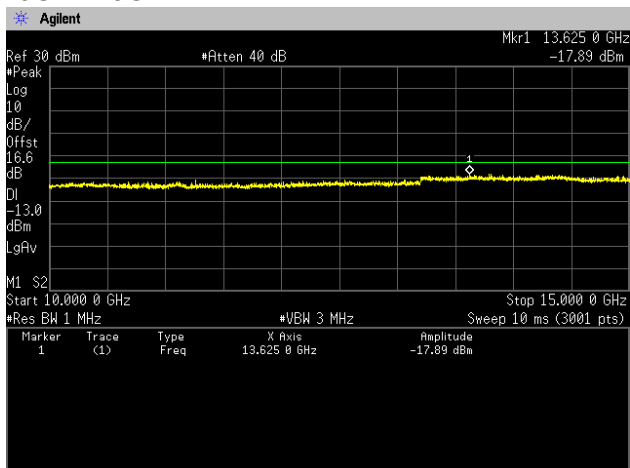

**15GHz-20GHz**

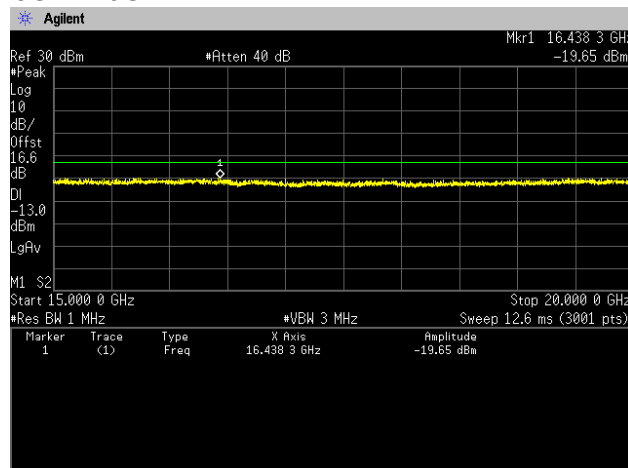



Zacta

**Channel: 9400**  
**30MHz-5GHz**

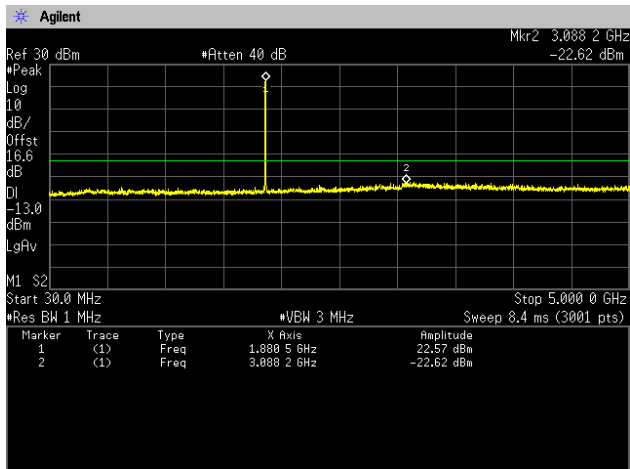

**5GHz-10GHz**

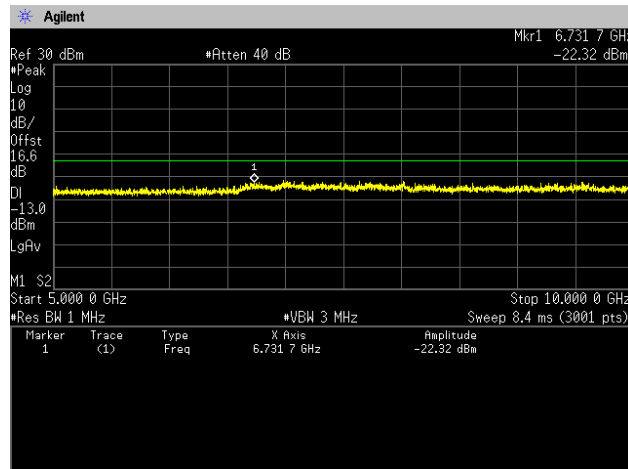

**10GHz-15GHz**

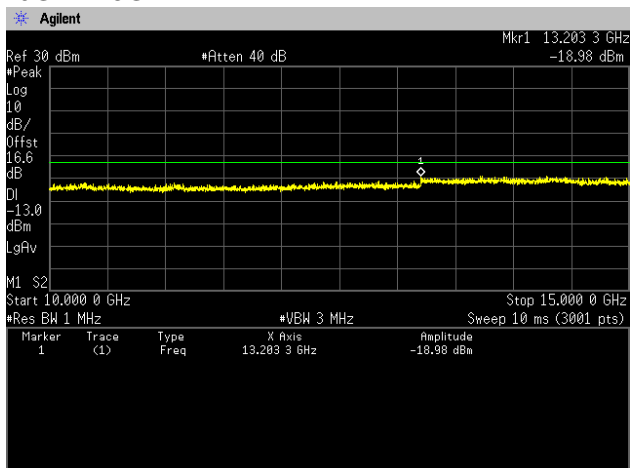

**15GHz-20GHz**

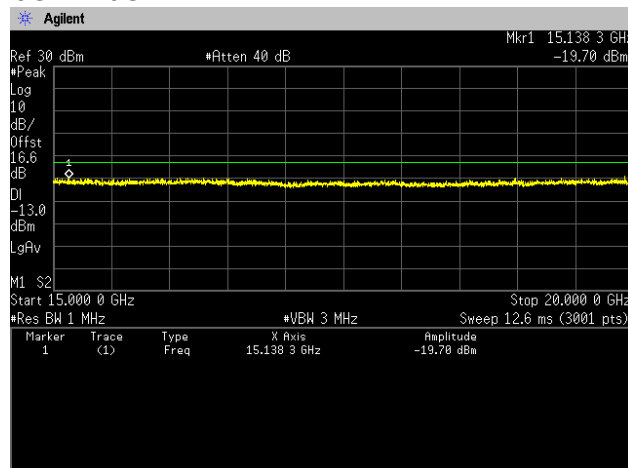



Zacta

**Channel: 9538**  
**30MHz-5GHz**

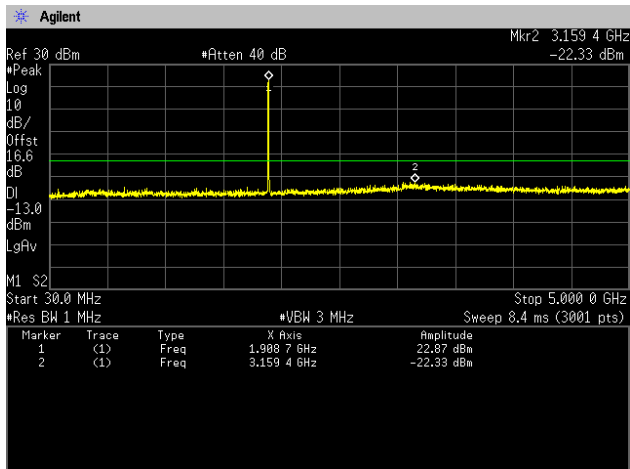

**5GHz-10GHz**

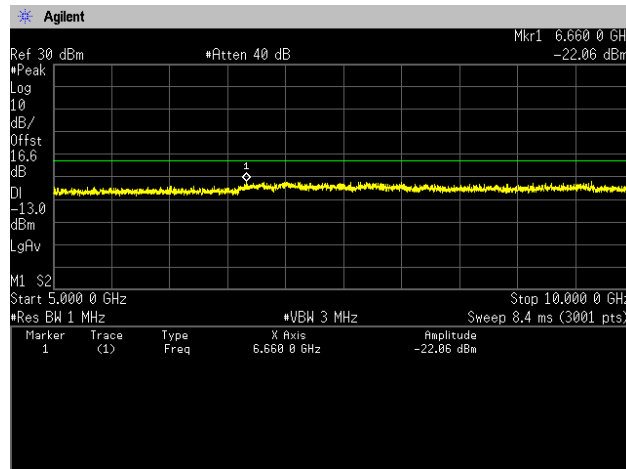

**10GHz-15GHz**

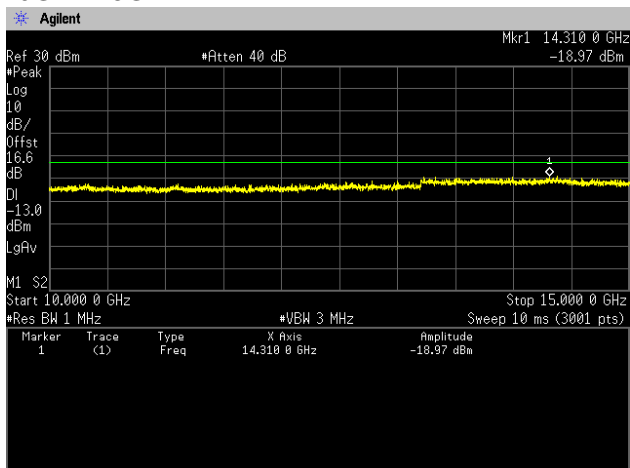

**15GHz-20GHz**

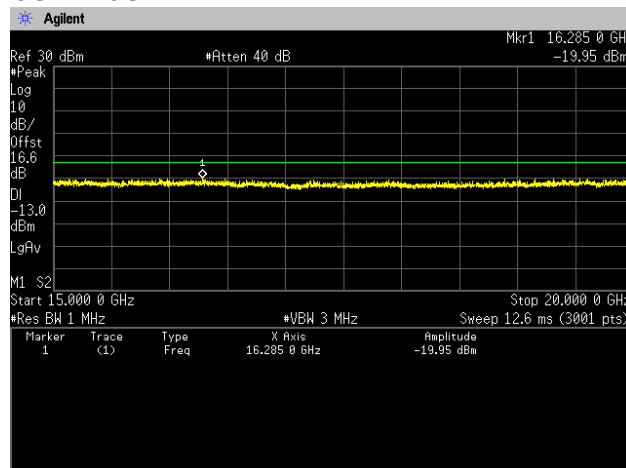

## 9. Radiated Emissions and Harmonic Emissions

### 9.1 Measurement procedure [FCC 24.238(a), 2.1053]

#### <Step 1>

The EUT and support equipment are placed on a 1 meter x 1.5 meter surface, 0.8 meter height FRP table. Radiated emission measurements are performed at 3 meter distance with the broadband antenna (Biconical antenna, Log periodic antenna and double ridged guide antenna). The antenna is positioned both the horizontal and vertical planes of polarization and height is varied 1 to 4 meters and stopped at height producing the maximum emission.

The bandwidth of the spectrum analyzer is set to 1MHz. The turntable is rotated by 360 degrees and stopped at azimuth of producing the maximum emission. The frequency is investigated up to 20GHz.

#### <Step 2>

The substitution antenna is replaced by the transmitter antenna (EUT).

The frequency of the signal generator is adjusted to the measurement frequency.

Level of the signal generator is adjusted to the level that is obtained from step 1, and record the emission level of signal generator.

#### Spectrum analyzer setting

- Detector: Peak (RBW: 1MHz, VBW: 3MHz)

- Test configuration

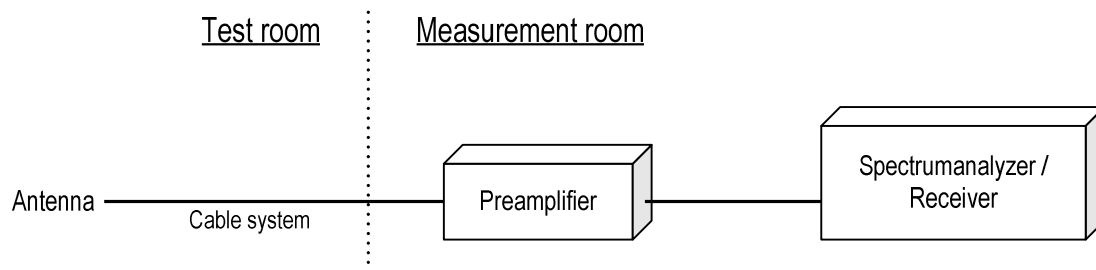

### 9.2 Calculation method

Result = S.G Reading – Cable loss + Antenna Gain

Margin = Limit – Result (EIRP)

### 9.3 Limit

-13dBm or less



Zacta

#### 9.4 Test data

Date : December 8, 2014      Test personnel :  
 Temperature : 19.2 [°C]  
 Humidity : 17.6 [%]      Tested by :  
 Test place : 3m Semi-anechoic chamber      Hikaru Shibata

Date : December 20, 2014      Test personnel :  
 Temperature : 20.1 [°C]  
 Humidity : 27.1 [%]      Tested by :  
 Test place : 3m Semi-anechoic chamber      Taiki Watanabe

#### [GSM1900] (Channel: 512)

H/V	Frequency [MHz]	S.A Reading [dBm]	S.G Reading [dBm]	Cable loss [dB]	Ant.Gain [dBi]	Result [dBm]	Limit [dBm]	Margin [dB]
H	3700.2	-55.4	-59.9	1.6	9.4	-52.1	-13.0	39.1
V	3700.2	-57.0	-68.5	1.6	9.4	-60.7	-13.0	47.7

#### (Channel: 661)

H/V	Frequency [MHz]	S.A Reading [dBm]	S.G Reading [dBm]	Cable loss [dB]	Ant.Gain [dBi]	Result [dBm]	Limit [dBm]	Margin [dB]
H	3760.0	-55.8	-58.0	1.6	9.3	-50.3	-13.0	37.3
V	3760.0	-56.8	-63.9	1.6	9.3	-56.2	-13.0	43.2

#### (Channel: 810)

H/V	Frequency [MHz]	S.A Reading [dBm]	S.G Reading [dBm]	Cable loss [dB]	Ant.Gain [dBi]	Result [dBm]	Limit [dBm]	Margin [dB]
H	3819.6	-54.3	-58.0	1.6	9.3	-50.3	-13.0	37.3
V	3819.6	-54.3	-61.1	1.6	9.3	-53.4	-13.0	40.4



Zacta

**[WCDMA Band II]  
(Channel: 9262)**

H/V	Frequency [MHz]	S.A Reading [dBm]	S.G Reading [dBm]	Cable loss [dB]	Ant.Gain [dBi]	Result [dBm]	Limit [dBm]	Margin [dB]
H	3704.8	-61.5	-51.6	1.6	9.4	-43.8	-13.0	30.8
V	3704.8	-62.2	-51.0	1.6	9.4	-43.2	-13.0	30.2

**(Channel: 9400)**

H/V	Frequency [MHz]	S.A Reading [dBm]	S.G Reading [dBm]	Cable loss [dB]	Ant.Gain [dBi]	Result [dBm]	Limit [dBm]	Margin [dB]
H	3758.0	-59.3	-48.8	1.6	9.3	-41.1	-13.0	28.1
V	3758.0	-59.0	-47.7	1.6	9.3	-40.0	-13.0	27.0

**(Channel: 9538)**

H/V	Frequency [MHz]	S.A Reading [dBm]	S.G Reading [dBm]	Cable loss [dB]	Ant.Gain [dBi]	Result [dBm]	Limit [dBm]	Margin [dB]
H	3815.2	-61.5	-51.0	1.6	9.3	-43.3	-13.0	30.3
V	3815.2	-62.5	-51.3	1.6	9.3	-43.6	-13.0	30.6

## 10. Frequency Stability

### 10.1 Measurement procedure [FCC 24.235, 2.1055]

The EUT was placed inside of a constant temperature chamber as the temperature in the chamber was varied between  $-30^{\circ}\text{C}$  and  $+50^{\circ}\text{C}$ . The temperature was incremented by  $10^{\circ}\text{C}$  intervals and the unit was allowed to stabilize at each measurement. The frequency drift was measured with the normal Temperature and voltage tolerance and it is presented as the ppm unit.

- Test configuration

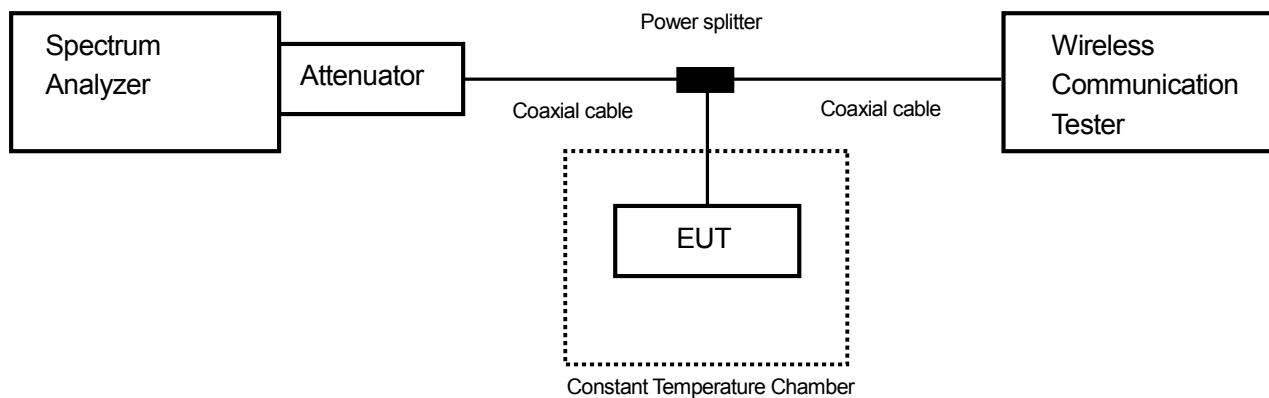

### 10.2 Limit

$\pm 2.5\text{ppm}$



Zacta

### 10.3 Measurement result

Date : December 11, 2014  
 Temperature : 25.1 [°C]  
 Humidity : 46.6 [%]  
 Test place : Shielded room No.4

Test engineer : Hikaru Shibata

#### [GSM1900]

(Channel: 661)

Limit: ±0.00025% = ±2.5ppm					
Power Supply [V]	Temperature [°C]	Measurements Frequency [Hz]	Frequency Tolerance [ppm]	Limit [ppm]	Result
3.80	25(Ref.)	1,880,000,242	0.00000	±2.5	PASS
	50	1,880,000,275	0.01728	±2.5	PASS
	40	1,880,000,291	0.02589	±2.5	PASS
	30	1,880,000,135	-0.05674	±2.5	PASS
	20	1,880,000,174	-0.03594	±2.5	PASS
	10	1,880,000,191	-0.02697	±2.5	PASS
	0	1,880,000,260	0.00973	±2.5	PASS
	-10	1,880,000,067	-0.09296	±2.5	PASS
	-20	1,880,000,139	-0.05466	±2.5	PASS
	-30	1,880,000,068	-0.09246	±2.5	PASS
3.230	25	1,880,000,150	-0.04888	±2.5	PASS
4.370	25	1,880,000,202	-0.02121	±2.5	PASS

#### [WCDMA Band II]

(Channel: 9400)

Limit: ±0.00025% = ±2.5ppm					
Power Supply [V]	Temperature [°C]	Measurements Frequency [Hz]	Frequency Tolerance [ppm]	Limit [ppm]	Result
3.80	25(Ref.)	1,880,001,121	0.00000	±2.5	PASS
	50	1,880,000,868	-0.13438	±2.5	PASS
	40	1,880,000,982	-0.07398	±2.5	PASS
	30	1,880,000,999	-0.06469	±2.5	PASS
	20	1,880,000,919	-0.10738	±2.5	PASS
	10	1,880,000,822	-0.15891	±2.5	PASS
	0	1,880,001,043	-0.04170	±2.5	PASS
	-10	1,880,000,631	-0.26051	±2.5	PASS
	-20	1,880,001,342	0.11771	±2.5	PASS
	-30	1,880,000,694	-0.22727	±2.5	PASS
3.230	25	1,880,000,958	-0.08657	±2.5	PASS
4.370	25	1,880,000,972	-0.07907	±2.5	PASS

Calculation;

Frequency Tolerance (ppm) = Measurements Frequency (Hz) – Reference Frequency (Hz) / Reference Frequency (Hz) x 1000000



## 11. Uncertainty of measurement

---

Expanded uncertainties stated are calculated with a coverage Factor  $k=2$ .

Please note that these results are not taken into account when determining compliance or non-compliance with test result.

Test item	Measurement uncertainty
Conducted emission at mains port	$\pm 3.0\text{dB}$
Radiated emission (9kHz – 30MHz)	$\pm 4.4\text{dB}$
Radiated emission (30MHz – 1000MHz)	$\pm 4.5\text{dB}$
Radiated emission (1000MHz – 26GHz)	$\pm 3.9\text{dB}$



Zacta

## 12. Laboratory description

### 1. Location:

TÜV SÜD Zacta Ltd. Yonezawa Testing Center  
 4149-7 Hachimanpara 5-chome Yonezawa-shi Yamagata 992-1128 Japan  
 Phone: +81-238-28-2880 Fax: +81-238-28-2888

### 2. Facility filing information:

1) NVLAP accreditation: NVLAP Lab. code: 200306-0

2) VLAC accreditation: Lab. code: VLAC-013

Site name	Radiated emission	Conducted emission for mains port	Conducted emission for telecom port	Radiated emission (CMAD)	Expiry Date
3m Semi-anechoic chamber	VLAC-013	VLAC-013	VLAC-013	-	Jul. 3, 2015
10m Semi-anechoic chamber No.1				VLAC-013	
10m Semi-anechoic chamber No.2				VLAC-013	
Shielded room No.1	-	VLAC-013	-	-	

3) FCC filing:

Site name	Registration Number	Expiry Date
Site 3	91065	Oct. 1, 2017
3m Semi-anechoic chamber	540072	Feb. 20, 2017
10m Semi-anechoic chamber No.1		
10m Semi-anechoic chamber No.2		
Shielded room No.1		

4) Industry Canada Oats site filing:

Site name	Sites on file: Oats 3m/10m	Expiry Date
Site 3	4224A-3	Jan. 23, 2015
3m Semi-anechoic chamber	4224A-4	
10m Semi-anechoic chamber No.1	4224A-5	
10m Semi-anechoic chamber No.2	4224A-6	Jan. 15, 2017

5) VCCI site filing:

Site name	Radiated emission	Conducted emission for mains port	Conducted emission for telecom port	Expiry Date
Site 3	R-138	C-134	T-1222	Nov. 16, 2017
3m Semi-anechoic chamber	A-0166	A-0166	A-0166	Jul. 3, 2015
10m Semi-anechoic chamber No.1				
10m Semi-anechoic chamber No.2				
Shielded room No.1	-	A-0166	A-0166	

6) TÜV SÜD PS authorization:

Authorized as an EMC test laboratory

7) TÜV Rheinland authorization:

Authorized as an EMC test laboratory



Zacta

## Appendix A. Test equipment

### Antenna port conducted test

Equipment	Company	Model No.	Serial No.	Cal. due	Cal. date
Spectrum analyzer	Agilent Technologies	E4440A	US44302655	May 31, 2015	May 30, 2014
Microwave cable	RS	YH_13S5	N/A (S403)	May 31, 2015	May 10, 2014
Attenuator	Weinschel	56-10	J4180	Nov. 30, 2015	Nov. 12, 2014
Microwave cable	SUHNER	SUCOFLEX104/1.5m	199121/4	Oct. 31, 2015	Oct. 7, 2014
Microwave cable	SUHNER	SUCOFLEX104/1.5m	322086/4	Jul. 31, 2015	Jul. 30, 2014
Power splitter	ANRITSU	K240B	020205	Mar. 31, 2015	Mar. 17, 2014
Wideband radio frequency tester	ROHDE&SCHWARZ	CMW500	116338	Mar. 31, 2015	Mar. 7, 2014
Operation type temperature controlled bath	Espec	PL1KP	14007261	Dec. 31, 2014	Dec. 27, 2013

### Radiated emission

Equipment	Company	Model No.	Serial No.	Cal. Due	Cal. Date
EMI Receiver	ROHDE&SCHWARZ	ESCI	100765	Aug. 31, 2015	Aug. 9, 2014
Preamplifier	ANRITSU	MH648A	M96057	Jun. 30, 2015	Jun. 12, 2014
Biconical antenna	Schwarzbeck	VHA9103/BBA9106	2125	May 31, 2015	May 7, 2014
Log periodic antenna	Schwarzbeck	UHALP9108A	0560	May 31, 2015	May 7, 2014
Attenuator	TME	CFA-01NPJ-6	N/A (S275)	Jun. 30, 2015	Jun. 9, 2014
Attenuator	TME	CFA-01NPJ-3	N/A (S272)	Jun. 30, 2015	Jun. 9, 2014
Spectrum analyzer	Agilent Technologies	E4440A	US44302655	May 31, 2015	May 30, 2014
Preamplifier	Agilent Technologies	8449B	3008A1008	Dec. 31, 2014	Dec. 9, 2013
Dipole antenna	Schwarzbeck	VHAP	1020	Sep. 30, 2015	Sep. 5, 2014
Dipole antenna	Schwarzbeck	UHAP	994	Sep. 30, 2015	Sep. 5, 2014
Double ridged guide antenna	EMCO	3115	5205	Dec. 31, 2014	Dec. 10, 2013
Attenuator	Agilent Technologies	8491B	MY39268633	Jan. 31, 2015	Jan. 15, 2014
Double ridged guide antenna	EMCO	3115	4328	Jan. 31, 2015	Jan. 21, 2014
Signal generator	ROHDE&SCHWARZ	SMB100A	177525	Feb. 28, 2015	Feb. 18, 2014
Power amplifier	R&K	CGA020M602-2633R	B40240	Mar.31, 2015	Mar. 7, 2014
Microwave cable	SUHNER	SUCOFELX102/2m	31648/2	Feb. 28, 2015	Feb. 13, 2014
High pass filter	Micro-Tronics	HPM50115	004	Jul. 31, 2015	Jul. 12, 2014
High pass filter	Wainwright	WHKX2.8/18G-6SS	1	Jul. 31, 2015	Jul. 17, 2014
Wideband radio frequency tester	ROHDE&SCHWARZ	CMW500	116338	Mar. 31, 2015	Mar. 7, 2014
Microwave cable	SUHNER	SUCOFLEX104/9m	346316/4	Oct. 31, 2015	Oct. 31, 2014
		SUCOFLEX104/1m	322084/4	Oct. 31, 2015	Oct. 31, 2014
		SUCOFLEX104/1.5m	317226/4	Oct. 31, 2015	Oct. 31, 2014
		SUCOFLEX104/7m	41625/6	Oct. 31, 2015	Oct. 31, 2014
PC	DELL	DIMENSION E521	75465BX	N/A	N/A
Software	TOYO Corporation	EP5/RE-AJ	0611193/V5.3.61	N/A	N/A
3m Semi-anechoic chamber	TOKIN	N/A	N/A (9002-NSA)	May 31, 2015	May 6, 2014
3m Semi-anechoic chamber	TOKIN	N/A	N/A (9002-SVSWR)	May 31, 2015	May 6, 2014

\*: The calibrations of the above equipment are traceable to NIST or equivalent standards of the reference organizations.