



KC-S701

User Guide

Getting Started

Thank you for purchasing a KYOCERA smartphone.

Before use, please read the User Guide and the supplied Quick Reference Guide for proper usage.

Choose the model you are using from the list at the URL below to view the USB driver.
<http://global.kyocera.com/ruggedphone/>

List of Packaged Items

- KC-S701 main unit











- Power adapter
- Micro USB cable
- Headset with microphone
- Warranty
- Quick Reference Guide



Notes

- The battery is built into the product.
- MicroSD card and wireless charger are not included.



Notations Used in This Document

In this document, the symbols , , , , , , , , and  are used to represent key operation. Also, the notations used for selecting icons and items visible on the display are as follows.

Example :

On the Home screen tap  ►  ► [About phone].

Explanation :

Tap the  icon at the bottom of the Home screen. On the Apps list that is displayed, swipe right or left and tap . Then swipe up and down on the Settings menu screen that is displayed, and tap [About phone].

Notes

- This manual describes operations from the Home screen at factory settings. If you change things like the settings, then operation procedures, icons, etc. may differ from those described. Also, operations are described based on a vertical display. If using a horizontal display, things like menu items may differ.
- The screens and illustrations used in this manual are representations and may differ from the actual product and screens. In addition, a portion of the screen may be omitted.

Table of Contents

List of Packaged Items	1
Notations Used in This Document.....	1
Disclaimers	3
Safety Precautions (Observe Strictly).....	4
Product Disposal.....	12
Handling Precautions	13
Notes on Waterproof, Dustproof and Shock-Resistant Properties	20
Using Apps	29

Things to Check and Setup Before Use 30

Names and Functions of Parts.....	30
Inserting/Removing a Nano SIM Card	32
Inserting/Removing a MicroSD Card.....	33
Charging.....	35
Turning the Power On/Off	36
Initial Settings.....	38
How to Use the Touch Panel	38
Home Screen	39
Status Bar	40
Notification Panel	41
Using the Apps List	42

Applications 42

Phone.....	42
People	43
Messaging.....	44
Email	45
Gmail.....	46
Chrome	47
Camera	48

Gallery	49
Play Store	50
Eco Mode	50

Product settings 51

Displaying the Settings Menu.....	51
WIRELESS & NETWORKS.....	51
DEVICE	54
PERSONAL.....	56
ACCOUNTS	57
SYSTEM.....	57

Appendix 58

Main Specifications.....	58
Specific Absorption Rate of Mobile Phone	58
OpenSSL License.....	60
FCC Notice.....	61
European RF Exposure Information.....	63
Declaration of Conformity	63
Intellectual Property Rights.....	64
Open Source Software	66

Disclaimers

- The Company is not liable for any damages arising from earthquakes, lightning, storms, floods, or other natural disasters, nor from fires, actions by third parties, other accidents, intentional or mistaken misoperation by the customer, or use under other unusual conditions outside the responsibility of the Company.
- The Company is not liable for any incidental damages (change/disappearance of described content, loss of business income, disruption of business, etc.) arising from the use or inability to use this product.
- The Company is not liable for any damages arising from failure to observe the described content of this manual.
- The Company is not liable for any damages arising, for example, from a malfunction caused in conjunction with connected devices or software not related to the Company.
- Shot image data or downloaded data may sometimes be altered or lost due to faults, repair, or other handling of this product. The Company is not liable for any damage or lost income that results from recovering this data.



- It is recommended you keep a copy of important data on your PC's hard disk, etc. Whatever the cause of the defect or malfunction may be, the Company assumes no responsibility for the alteration or loss of saved data.

Notes







- Reproduction of the content of this manual in part or in whole is prohibited.
- The content of this manual is subject to change without notice.

Safety Precautions (Observe Strictly)

- Before using this product, thoroughly read the Safety Precautions for proper use. After reading, store the precautions in a safe place.
- These precautions contain instructions that should be observed to prevent damage to property and/or injury to the user and other people.
- These precautions are divided into the following categories according to the severity of the damage that could occur if the instructions are not followed.

 DANGER	This symbol indicates the "imminent danger of death or serious injury" if the instructions are not followed.
 WARNING	This symbol indicates the "possibility of death or serious injury" if the instructions are not followed.
 CAUTION	This symbol indicates the "risk of minor injury or physical damage" if the instructions are not followed.

- Explanation of graphics used in these precautions

	Indicates an action that is not allowed.
	Indicates that disassembly is not allowed.
	Indicates that use in a place where the product is likely to get wet or allowing the product to get wet is not allowed.
	Indicates that handling with wet hands is not allowed.
	Indicates an action that must be taken.
	Indicates that the power plug must be disconnected from the mains.

Precautions common to the main unit, internal battery, power adapter, and peripheral devices

DANGER

-  Do not use, store, or leave the product in hot places (e.g. by fire, near a heater, in direct sunlight, in a car in the hot sun). Doing so might cause ignition, rupture, fault, fire, or injury.

-  Before entering an area where flammable gas is generated, such as a petrol station, be sure to turn off the product.

 Do not put the product in a cooking apparatus such as microwave oven or a pressure vessel. Doing so might cause ignition, rupture, fault, fire, or injury.

 Do not throw the product into a fire or heat it. Doing so might cause ignition, rupture, or fire.

 Do not short-circuit the external connection terminal, earphone microphone terminal, etc. Also, do not allow conductive foreign objects (metal fragments, pencil leads, etc.) to come into contact with or get inside the external connection terminal, earphone microphone terminal, etc. Doing so might cause a fire, burns, or a fault due to heat generation.

 When using metal accessories, etc., be sure not to allow the metal part to come in contact with the external connection terminal, earphone microphone terminal, or power outlet. Doing so might cause electric shock, ignition, injury, or a fault.

 Do not expose the camera lens to direct sunlight for an extended period. Doing so might cause ignition, rupture, or fire by the light-collecting mechanism of the lens.

 You are not allowed to disassemble, modify, or repair the product. Doing so might cause a fault, ignition, electric shock, or injury. The Company is not liable in the event that any nonconformities arise on this product or peripheral devices as a result of modification, etc.



WARNING



 Do not drop the product or subject it to strong impact, such as throwing. Doing so might cause rupture, overheating, ignition, or a fault.

 Do not use outside when you can hear thunder. Doing so puts you at risk of lightning strikes and electric shock.

 Do not let your hands, fingers, and other parts of the body touch the external connection terminal. Doing so might cause electric shock, injury, or a fault.

 If the product is damaged from being dropped, etc., and its display is cracked or internal parts are exposed, do not touch the cracked display or exposed parts with your hands. Doing so might cause electric shock or injury from damaged parts.

  If the product is charged while wet, electric shock, a short circuit, or corrosion might occur, and overheating might cause fire, malfunction, or burns.

  Although this product model has waterproof properties, stop use if water or another liquid gets inside the product from the external connection terminal cover, card slot cover, earphone microphone terminal cover, etc. Continued use of the product in this state might cause overheating, fire, or a fault.

 Do not operate the product while driving a vehicle, riding a motorized bicycle or bicycle, or walking. Doing so might compromise traffic safety and cause an accident.

 If charging is not completed after the specified charging time, stop charging. Failure to do so might cause leakage of liquid, overheating, rupture, or ignition.

 Do not leave in places within the reach of small children. Small children might mistakenly swallow small parts, etc. and choke on them, or might drop the product and cause an accident or injury.

CAUTION

 Do not store the product in places subject to direct sunlight (e.g. in vehicles), places that get hot, places that get extremely cold, or in humid or dusty places. Doing so might cause overheating, fire, deformation, or a fault.

 Do not leave in unstable locations such as unsteady stands or tilting surfaces. Dropping the product might cause injury or damage. Pay extra attention while the vibration is set. Also, pay sufficient attention to impact, etc.

 Do not cover or wrap up the product in bedding, etc. while using or charging the product. Doing so might cause fire, fault, or injury.

 Do not touch the product or power adapter for extended periods while power is being supplied from an external source. Doing so might cause low-temperature burns.

 The product may become hot from prolonged use, especially in a high-temperature environment. Be careful about prolonged skin contact when using the product, as it might cause low-temperature burns.

 Do not use power outlets or wiring apparatus beyond their ratings. Also, exceeding the rating by, for example, connecting multiple devices to a single power strip might cause overheating and fire.

 Do not place near corrosive chemicals or in places where corrosive gas is generated. Doing so might cause a fault or loss of internal data.

 Do not use if there is smoke, abnormal odour or noise, excessive overheating, or other abnormalities. If you are charging, unplug the power adapter from the mains, confirm that the product is not too hot, and turn off the power.

 When plugging earphones, etc. into the product, adjust the volume to the proper level. Setting the volume too loud or using earphones continuously for an extended time period might adversely affect your ears. Also, raising the volume too high might prevent you from hearing sounds around you, which might in turn lead to a traffic accident at a railway crossing or pedestrian crossing.

 When adjusting the volume with earphones, etc. plugged into the product, raise the volume a little at a time. If you raise the volume too much from the outset, a sudden loud noise from the earphones, etc. might adversely affect your ears.

 When using the power adapter or an external device, insert/remove the connector straight to/from the terminal. Check the orientation of the connector. If not correct, it may cause damage or a fault.

Main unit

DANGER

 Do not puncture the product with a nail, hit it with a hammer, or step on the product. Doing so might cause fire or damage.

 Be careful that the product is not bitten by your pet. It might cause leakage, overheating, rupture, ignition of the internal battery, fire, or injury.

WARNING

 Do not use the product while you are aboard an aeroplane. Although, some airline companies do allow their passengers to use cell phones. For details, contact the airline company you use.

 Turn the product off near high precision electronic devices. Failure to do so might affect the electronic devices. (Examples of electronic devices that might be affected by the product include cardiac pacemakers, hearing aids, other electronic medical devices, fire alarms, and automatic doors. If you are using an electronic medical device, contact the device manufacturer or retailer for information about the possible effects of radio waves.)

-
-  When using the product near an implanted pacemaker, implanted cardioverter-defibrillator, or other electronic medical device, radio waves might affect these units and devices. So, please observe the following.
- Those with an implanted pacemaker or implanted cardioverter-defibrillator should carry or use the product at least 15 cm away from the pacemaker or cardioverter-defibrillator.
 - Turn the product off or set it to “Aero-plane mode” when it may be difficult to keep at least 15 cm away, such as in situations where you cannot move freely, because there may be people with a cardiac pacemaker or implanted cardioverter-defibrillator nearby.
 - Pay attention to the following points when using the product inside medical institutions.
 - Do not bring the product into operating rooms, intensive-care units (ICU), and coronary care units (CCU).
 - Turn the product off in hospital wards.
 - Even if you are in a lobby, etc., be sure to turn the product off when there are electronic medical devices nearby.
 - When a medical institution has laid down designated areas where use of the product is prohibited or is not allowed to be brought in, abide by the instructions of that medical institution.

- When using electronic medical devices other than an implanted pacemaker or implanted cardioverter-defibrillator outside a medical institution (e.g. home medical treatment), check with the individual manufacturers of the electronic medical devices regarding the influence of radio waves.

-
-  Stay alert to your surroundings when calling, messaging, browsing the Internet, shooting photos, playing games, or listening to music. Failure to do so might cause a fall or traffic accident.

-
-  Do not use the light in front of a person's eyes. Do not stare into the light when it is illuminated. Doing so might cause impairment of eyesight, etc. Be especially careful not to photograph small children from a very close distance.

-
-  Do not turn the light on toward a driver of a car, motorbike, bicycle, etc. If disoriented by the light, the driver might become unable to drive and cause an accident.

-
-  On rare occasions, some people demonstrate symptoms such as temporary muscle spasms, loss of consciousness, etc. from watching repeatedly flickering screens. Those with a past history of this should consult with a physician beforehand.

-
-  Chemically hardened glass is used for the product's display. If it is broken, do not touch the broken part. The broken part might cause injury.

-  Do not hold the speaker close to your ear. Loud volume might affect hearing.



CAUTION

-  Although it is rare, use of the main unit in a vehicle sometimes affects on-board electronic devices. If this happens, stop use, since this may impair safe travel.

-  If you feel any skin abnormalities, immediately stop use and consult a dermatologist. Itching, rashes, eczema, etc. sometimes occur, depending on your physical constitution and condition. The materials of parts used on the product are as follows.

Part	Material	Surface treatment
Outer case (display side)	PA resin	Acrylic UV-cured coating, urethane heat-cured coating
Outer case (display-side top), outer case (display-side bottom), volume up/down key, direct button (circumference), speaker panel, camera lens ring, flash ring, decorative screws (rear side)	PC resin	Acrylic UV-cured coating

Part	Material	Surface treatment
Outer case (rear side), earphone microphone terminal cover, card slot cover	PC resin/urethane resin	Acrylic UV-cured coating
Direct button (inside), camera lens, flash lens	PMMA resin	Hard coat treatment
Display	Chemically hardened glass	Antifouling treatment
Back key, home key, recent apps key, external connection terminal cover	PC resin/urethane resin	None
Power key, speakerphone key, camera key	Urethane resin	None
Decorative screws (display side)	SWCH	Trivalent black plating

-  Do not bring the product close to magnetized objects such as cash cards, floppy disks, credit cards, and prepaid cards. Doing so might result in a loss of recorded information.
-  Do not allow liquids, metal objects, burnable items, and other foreign matter to get inside the earphone microphone terminal, the external connection terminal, the microSD card slot, or the nano SIM card slot. Doing so might cause fire, electric shock, injury, or a fault.

 Do not swing the product from a grip on the earphones, a phone strap, etc. Doing so might cause an accident or damage.

 Use the product with the external connection terminal cover, card slot cover, and earphone microphone terminal cover closed. If the covers are open, dirt or water might get inside and cause a fault.

 People with weak hearts should be careful when setting the incoming vibration and ringtone volume. Not doing so can cause adverse effects on your heart.

 Do not place the product directly on the sand at a beach, etc. Sand or other small particles might get inside the microphone, speaker, noise cancelling microphone, etc. causing the volume to drop. If sand gets inside the product, it might cause overheating or a fault.

 When using the product for calling or data communications, be careful not to keep the product in direct contact with your skin for an extended period, and do not cover the product with paper, cloth, bedding, etc. The main unit might get hot, causing a fire, injury, burns, or a fault.

Internal battery



The internal battery of this product is a lithium-ion battery. The internal battery is not fully charged at the time of purchase. Charge the battery before using the product.

DANGER

 If the leaked liquid gets on your skin or clothes, immediately rinse it off with water to avoid the risk of injury. If the liquid gets into your eyes, do not rub them. Wash your eyes with water, and then immediately consult a doctor to avoid the risk of losing your eyesight. If the liquid gets on a device, wipe it off without touching it.

 The internal battery is a consumable item. If the performance of the internal battery has depleted (e.g. the usable time after each charge has become extremely short), the battery is at the end of service life, so stop use. Failure to do so might cause overheating, fire, rupture, or leakage. The life span of the internal battery depends on the usage, etc.

Power adapter

WARNING

 Do not use any voltages other than the specified power supply voltage. Doing so might cause ignition, fire, overheating, electric shock, or injury.

 Fully insert the power plug of the power adapter into the mains. Incomplete insertion of the power plug might result in electric shock, overheating, ignition, fire, or injury. Do not use when the power adapter is damaged, or a power outlet is loose.

 Do not damage, modify, twist, pull, or place a heavy object on the cable of the power adapter. Do not use a damaged cable. Doing so might cause an electric shock, short circuit, fire, or injury.

 Do not let your hands, fingers, or other parts of your body touch the external connection terminal or the earphone microphone terminal. Doing so might cause electric shock, injury, or a fault.

 If you hear thunder, do not touch the power plug. Doing so might cause an electric shock as a result of a lightning strike.

 When cleaning the power adapter, unplug it from the mains. If the equipment remains plugged in while you clean it, it might cause a short circuit.

 Wipe off dust on the power plug. Failure to do so might cause fire, burns, or electric shock.

 Situate and install in-car devices in places where they do not hinder driving or safety equipment such as air bags. Failure to do so might cause a traffic accident. Install in-car devices by following the instructions in their manuals.

 When the power adapter will not be used for a long time, unplug it from the mains. Failure to do so might cause fire or a fault.

 Do not use in places subject to direct splashing with water, pet urine, or other liquids. Doing so might result in faults and injury from overheating, fire, electric shock, or short-circuiting of electronic circuits. In the event that the product is splashed with liquid, immediately unplug the power adapter.

CAUTION

 Do not use in humid places, such as bath areas, or connect/disconnect the power adapter with wet hands. Doing so might cause electric shock, injury, or a fault.

 Charge the battery in a stable place. If placed on an inclined surface or wobbly stand, the product might fall and cause injury or damage. Pay extra attention while the vibration is set. In addition, do not cover or wrap the product with a cloth or bedding. Doing so might cause a fire, injury, or a fault.

- !** When unplugging the power adapter from the mains, grip the power adapter and remove it. If you pull the cable, the cable might be damaged.

Product Disposal

Battery:

This product is a unibody (one-piece) device, so the back cover and battery cannot be removed. Please be careful.

Observe the following precautions.

- Do not attempt to open the back cover.
- Do not take out the battery, replace it, or dismantle it.
- Do not damage the back cover of the product.
- Do not incinerate the product or dispose of it like you would household rubbish.

Dispose of the product (including the internal battery) in accordance with the environmental regulations of your region.



When cellular devices and accessories bearing this mark have reached the end of their product lives, it is necessary to bring them to a given waste collection point.

- The waste collection box for each part, located at the waste treatment facility in your area

- The waste collection box at the retail store

To prevent these waste products from polluting the environment, they are recycled.

European countries:

Waste collection points are free to use.

It is necessary to bring all products bearing this mark to a collection point.

Non-European countries:

If your area lacks suitable waste collection or if it has a recycling facility for the parts of devices bearing this mark, it is necessary to take them to the collection point for recyclables. Do not throw them out with normal rubbish.

Handling Precautions

These precautions are provided to ensure full performance. Thoroughly read these precautions to ensure correct use.

■ Precautions common to the main unit, internal battery, power adapter, and peripheral devices

- Do not apply excessive force to the product during use. Be sure not to place the product into a tightly packed bag or to put it beneath a heavy object in the bag. Sitting with the product in your pocket might damage the display or internal circuit board, resulting in a malfunction. Keeping an external device connected to the external connection terminal or earphone microphone terminal might damage the connector, resulting in a malfunction. Such damage and malfunctions are not covered by the warranty, even if there is no external damage.
- To ensure the waterproof properties (equivalent to IPX5 and IPX8) of this product, use the product with the external connection terminal cover, card slot cover, and earphone microphone terminal cover securely closed. Note that the waterproof

properties are not guaranteed in every usage condition. Do not allow water to get inside the product or splash water onto the power adapter. Do not open/close the external connection terminal cover, card slot cover, or earphone microphone terminal cover in the rain or with water drops on the surface of the product. Doing so might cause water intrusion resulting in internal corrosion. Malfunctions determined to be caused by water intrusion are not covered by the warranty.

- Do not use these items in extremely hot, cold, or humid places. (Use within an ambient temperature range of 5°C to 35°C and humidity range of 35% to 85%).
 - Power adapter
 - Peripheral devices
- Do not use these items in extremely hot, cold, or humid places. (Use within an ambient temperature range of 5°C to 35°C and humidity range of 35% to 90%. Temporary use at -21°C to 50°C is acceptable.)
 - Main unit
- Do not use in places subject to lots of dust or vibration.

- Periodically clean the external connection terminal and earphone microphone terminal with dry cotton swabs, etc. Soiled terminals might cause poor connections. Do not exert strong force when cleaning the external connection terminal or earphone microphone terminal, to avoid deformation.
 - Clean the product with a soft, dry cloth (such as the type used for glasses). Do not rub roughly with the dry cloth, or the display may be damaged. Leaving drops of water or dirt on the display may cause stains. Wiping the product using alcohol, thinner, benzene, detergent, etc. might remove the printing on the outer casing or cause discoloration.
 - Use as far away as possible from land-line phones, TVs, and radios, as nearby use might affect them.
 - The product may become warm while charging or during other operations, depending on the situation, but this is not abnormal.
 - When a child will be using the product, parents or guardians should thoroughly read these materials and teach the child how to use it.
 - Do not put stickers on the product. Sound may not be emitted or your voice may not reach the other party.
- **Main unit**
- Do not forcefully press, tap, or intentionally subject the display to strong impact. Doing so might cause scratching or damage.
 - Do not forcefully press your fingernails, sharp objects, or hard objects against the keys or display surface. Doing so might cause scratching or damage. The touch panel is designed to be lightly touched by your fingers. Do not press hard with your fingers or push sharp objects (fingernails, ballpoint pens, pins, etc.) against it.
 - If you do the following things, the touch panel may become unresponsive to touch. Note that these may even cause a malfunction.
 - Operation with fingernails
 - Operation with a foreign substance still on the display
 - Operation with a protective sheet or sticker on the screen
 - Operation underwater
 - To prevent unlawful modification, the product has been designed so that it cannot be easily disassembled.

- Contents saved on the product, such as contacts and emails, might be altered or lost in an accident, fault, repair, or mishandling. Be sure to keep a copy of important contents. Note that the Company assumes no responsibility for any damages or lost profits resulting from altered or lost contents.
- The product uses liquid crystal in its display. The response speed of the display may slow down when the ambient temperature is low, which is due to the properties of liquid crystal and is not a malfunction. Display response speed will return to normal at room temperature.
- Although the display on this product was made using high-precision technology, some pixels might be lit or out at all times. This is not a malfunction.
- Take care not to inconvenience people around you when you use the product in a public place.
- It is recommended that you store copies of your data, such as photos you took, videos, and music, on your PC by sending each file as an email attachment, etc. Note, however, that you may not be able to make copies of copyrighted data, even by the above-mentioned means.
- Take care not to place magnetized items such as magnetic cards, speakers, and TV sets near the product, as it might cause malfunction. Putting a strong magnet close to the product might cause false operation.
- When you put the product in your pocket or bag, take care so that the display does not come in contact with metal objects or other hard objects. Doing so might cause scratching or damage. Also, be careful not to scratch or damage the display by using a strap with metal or another hard part that comes in contact with the display.
- When suddenly brought into a warm place from a cold place, when in a humid location, or when used where the temperature suddenly changes (e.g. near the air discharge port of an air conditioner), water droplets (i.e. condensation) sometimes form inside the product. Note that when used under such conditions, the humidity might cause corrosion or a fault.

- When wiping the display, wipe with a soft, dry cloth. Use of a moistened cloth, glass cleaner, or other similar liquid might cause a fault.
 - When connecting/disconnecting an external device to/from the external connection terminal or the earphone microphone terminal, be sure that the connector or plug of the external device is straight with the terminal.
 - Note that applying unnecessary force to the external connection terminal or the earphone microphone terminal when connected to an external device might cause damage.
 - Do not discard the product together with normal rubbish.
 - Insert only a microSD card into the card slot on the product.
 - Do not use excessive force when inserting/removing a microSD card. Doing so might injure your hands or fingers.
 - While writing/reading data to/from a microSD card, do not subject the product to vibration or impact, or turn off the power. Doing so might cause loss of data or a fault.
 - Take care not to cover the microphone with your fingers during a call. The other party may not be able to hear your voice clearly.
 - When doing a handsfree call, note that the speaker might emit loud sounds. Take care to keep the speaker a safe distance from your ears.
 - Do not cover the sensor with your finger or put a sticker over it. Doing so may prevent the sensor from detecting ambient light levels and functioning correctly.
 - Do not put a sticker, etc. on the proximity sensor. Doing so may cause the sensor to malfunction, making the display turn off and remain off whenever you're receiving or taking a call.
- **Touch panel**
- Use your fingers to operate the touch panel. Do not use ballpoint pens, pencils, or other sharp-pointed objects. Using such objects does not only hinder correct operation of the touch panel, but might also cause scratching or damage to the display.
 - Do not put stickers or sheets (e.g. commercially available protective films, peep prevention sheets) on the display. Doing so might hinder correct operation of the touch panel.

- Do not operate the touch panel with your fingernails. Doing so might result in split nails or jammed fingers.
 - If the display surface is dirty, it may not function correctly. In such cases, wipe the display surface with a soft, dry cloth.
 - When carrying the product in your pocket or bag, take care not to put the touch panel close to metals or other conductive materials, as it might cause false operation of the touch panel.
 - Gloves can be worn while operating the touch panel. However, operation may not be optimal, depending on the thickness and material of the gloves.
 - If water on the gloves prevents operation of the touch panel, wipe the water off.
 - If touch operation with gloves is not possible immediately after operating with no gloves, temporarily put the product in Sleep mode and reawaken it.
 - If touch operation is not possible with gloves that are not snug on the fingertips, use the pads of your fingers.
- **Internal battery**
- Using the product in very hot or cold environments, like being left in a vehicle with the windows closed, will cause the internal battery capacity to drop and will shorten the potential battery usage time. This will also shorten the internal battery's service life. Whenever possible, try to use the product at room temperature.
 - After the internal battery is charged, battery power decreases bit by bit, even if the product is not used. The internal battery may be discharged if the product is not used for a long time. We recommend charging the product before use.
 - To avoid lowering the battery performance or decreasing battery life, do not store the product in the following conditions:
 - When fully charged (right after charging)
 - When the battery is empty (too low to turn the product on)
 - In hot and humid places
 - Charge the battery before using the product for the first time after purchase, or if you have not used the product for a long time.

- The internal battery is a consumable item. If the performance of the internal battery does not recover when charged, the battery is at the end of service life, so stop use.

■ Power adapter

- When not using the power adapter, unplug it from the mains.
- Do not forcibly bend the power adapter's plug or the connection area of the micro USB cable. Doing so might cause electric shock, fault, injury, overheating, or fire.

■ Camera function

- When using the camera, follow common rules of etiquette regarding camera use.
- Picture/video data might be altered or lost due to a malfunction, repairs, or mishandling of the product. The Company takes no responsibility for the recovery of altered or lost data, damages resulting from altered or lost data, or for lost profits.
- When photographing important occasions (such as a wedding), take a trial shot and check the shot image to make sure it is correctly shot.

- Do not use the camera to make a record of commercially available books or information of which photography is not allowed.
- Do not leave the camera lens exposed to direct sunlight. Imaging elements might be discoloured or burnt.

■ Music and videos

- Do not listen to music or watch videos while driving a car or motorbike, or riding a bicycle. In addition, stay alert to the traffic around you even when walking. Surrounding sounds may not be heard clearly, and gazing at the screen might distract your attention and cause a traffic accident. Be especially careful at railway crossings, on station platforms, and at pedestrian crossings.
- Take care not to listen at resoundingly loud volumes for extended periods, as it might affect hearing.
- Be careful of sound leakage from earphones when on trains and at other places with many surrounding people.

■ Copyrights and rights of portrait

- Without the consent of the copyright holder, you are not allowed to copy, distribute, publish, modify, or edit the data that you shot, recorded, or downloaded using this product, unless for personal use or uses under copyright law. In addition, do not use or modify the portraits or names of other individuals without their consent, as it might infringe on their rights of portrait. Note that shooting and recording may be restricted at some live performances, shows, and exhibitions, even for personal use.
- Be careful about copyrights and portrait rights when posting pictures you shot, etc. on Internet web pages.

■ Back up content on the product

- Please back up important content registered on the product or downloaded to the product from an outside source. Content saved to the product's memory sometimes disappears or is altered by unexpected factors, such as static electricity or a fault, repair, mishandling, etc.

- Store important data such as contact data, music, and shot pictures and videos on microSD cards. You can also send files as email attachments or transfer them to your PC. Although, some data cannot be copied using these means. Please be aware.

PIN Code

■ PIN code

To prevent unauthorized use of the Nano SIM Card by a third party, you can set the product to require PIN code entry every time the power is turned on. You also need to enter the PIN code when setting whether the PIN code entry is required. If the PIN code is incorrectly entered a certain number of times, the PIN code will be locked. You can unlock the PIN code using the PUK code.

■ PUK code

If the PIN code is locked, you can unlock it by entering the PUK code.

- After entering the PUK code, you need to set a new PIN code.
- The PIN code is not reset by initializing the product.

Notes on Waterproof, Dustproof and Shock-Resistant Properties

This product has waterproof properties equivalent to IPX5^{*1} and IPX8^{*2}, as well as a dustproof property equivalent to IP6X^{*3}, provided that the external connection terminal cover, card slot cover, and earphone microphone terminal cover are securely closed.

- *1 IPX5 equivalent means that the product will maintain its operability as a phone even if it is sprayed with water from a 6.3 mm diameter nozzle at a distance of about 3 meters for more than 3 minutes at a rate of about 12.5 litres per minute from any direction.
- *2 IPX8 equivalent means that the product will maintain its operability as a phone with no water getting inside the main unit, even if it is gently submerged in a tank of still tap water at room temperature to a depth of 1.5 meters for about 30 minutes.
- *3 IP6X equivalent means that the product will not allow the intrusion of grit or dust even when it is placed in an apparatus with grit and dust of diameters of 75 µm or less and shaken for 8 hours.

Testing has also been carried out that conforms to the procurement standards (MIL-STD-810G) of the US Dept. of Defense, which carries out rigid testing (by our testing method).

- Water resistance: 30 straight minutes of water resistance in falling rain and immersion, and IPX5/IPX8 water resistance
- Dust resistance: Tested in dusty conditions for 6 straight hours (8.9 ± 1.3 m/sec, 10.6 ± 7 g/m³), and IP6X dust resistance
- Shock resistance: Tested by dropping from a height of approximately 1.22 m onto plywood (lauan) in 26 directions
- Vibration resistance: Tested with vibration for 1 straight hour (3 directions for 1 hour each, 20 to 2,000 Hz)
- Sunlight resistance: Tested in sunlight for 24 straight hours (totalling 1,120 W/m²)
- Humidity resistance: Tested at high humidity for 10 consecutive days (for 16 hours at 45% and for 8 hours at 95% per day)
- Temperature endurance: Operating environment: -21°C to 50°C (3 straight hours each), Storage environment: -30°C to 60°C (4 straight hours each)

- Low-pressure capability: Tested at low pressure for 2 straight hours (57.11 kPa: approx. 4,572 m)
- Salt-fog resistance: Tested at 5% salt fog for 24 straight hours, then dried for 24 hours
- * Before using the product, thoroughly read “Important Items to Remember before Use” and “Tips for Comfortable Use” to ensure correct use. Failure to follow the content described in these sections may cause the intrusion of water, sand, or other foreign materials, resulting in overheating, ignition, electric shock, injury, or a fault.
- * Because operation of the product in various usage scenes was confirmed based on the above criteria, proper operation of the product in every possible condition during actual use is not guaranteed. Malfunctions determined to be caused by mishandling by the customer are not covered by the warranty.

Important Items to Remember before Use

- Make sure that the external connection terminal cover, card slot cover, and earphone microphone terminal cover are firmly closed.
 - Waterproofness is only effective when the covers are securely closed.
 - Just a small particle (a hair, a grain of sand, etc.) on the seals can cause a water leak.
 - Do not open/close the external connection terminal cover, card slot cover, or earphone microphone terminal cover if the product or your hands are wet.

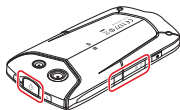

■ **How to close the external connection terminal cover, card slot cover, and earphone microphone terminal cover**

After stowing the cover hinge, press on the cover evenly with your finger pad. Rub your finger over the cover in the direction of arrows to ensure that the cover is not partially open.

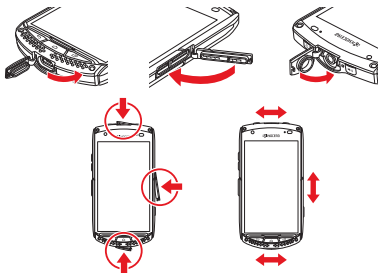

- Do not immerse the product in water with soap, detergent, or bath salts in it.
- Do not immerse the product in seawater, a swimming pool, or a hot spring.
- Do not immerse the product in any liquid (alcohol, etc.) besides water.

- Do not place the product directly on the sand at a beach, etc. Sand or other small particles might get inside the microphone, speaker, noise cancelling microphone, etc. causing the volume to drop. If sand gets inside the product, it might cause overheating or a fault.
- Do not use the product underwater.
- The product does not float in water.
- Do not leave the product in a bathroom, kitchen, or other humid place for an extended period of time.



Tips for Comfortable Use

- Once the product gets wet, water may remain in gaps on the product. Shake the product well to the drain water. Especially make sure to drain water remaining in the microphone, speaker, and noise canceller microphone.
- Even after the water is drained, the inner parts might be still wet. Although the product can still be used, do not place it near things that must not get wet. Take care not to let it dampen your clothes, bag, or the contents of a bag.
- If it becomes temporarily hard to hear sound due to water remaining in the microphone, drain the water.

Notes on various usage scenes

<In the rain>

You can make calls while holding the product with wet hands in the rain without an umbrella (101.6 mm per hour, wind speed 17.8 m/s, for 30 minutes).

- Never open/close the external connection terminal cover, card slot cover, or earphone microphone terminal cover if the product is exposed to rain, or your hands are wet.

<In the shower>

You can make calls holding the product with wet hands after a shower.

- Avoid spraying the product with high-pressure water.

<Washing>

You can wash the product under a mild flow (up to 6 litres per minute) of tap water at room temperature (5°C to 35°C) at a distance of about 10 cm from the tap or showerhead.

- Do not spray the product with high-pressure water or submerge it in water for extended periods of time.
- Make sure to hold down the external connection terminal cover, card slot cover, and earphone microphone terminal cover so that they will not open, and wash the product with your hands. Do not use a brush or sponge.
- Do not wash the product in a washing machine or ultrasound bath.
- Do not splash the product with or immerse it in soap water, detergent water, or anything besides tap water.

<In the bath>

You can use the product in a bathroom.

- Although you can make calls with wet hands, do not immerse the product in a bathtub.

- Do not use the product in a bathroom for an extended period of time.
- Do not immerse the product in hot spring water, soap water, detergent water, or water with bath salts in it. Also, do not use the product underwater. Doing so might cause a fault.
- Extreme changes in temperature cause condensation. Wait until the product reaches room temperature before you bring the product from a cold place into a warm bathroom.
- If condensation occurs inside the display, leave the product at room temperature for a while until the condensation is cleared.
- Do not splash the product with hot water. Also, do not use the product in a sauna.

<At a poolside>

- Do not immerse or drop the product in pool water. Also, do not use the product underwater.
- If the product gets splashed with pool water, immediately rinse it off with tap water* at room temperature, because pool water contains chlorine for disinfection. Do not use a brush, etc. to wash the product.

* Mild flow (6 litres per minute or less)

<In a kitchen>

You can use the product in the kitchen and other places where water is used.

- Do not splash the product with or immerse it in soap water, detergent water, flavouring, juice, or anything besides tap water.
- Do not immerse the product in or splash it with boiling water.
- Do not put the product in a place that gets extremely hot or cold, such as near a stove or in a refrigerator.

Common precautions

■ External connection terminal cover, card slot cover, and earphone microphone terminal cover

- Make sure that the external connection terminal cover, card slot cover, and earphone microphone terminal cover are firmly closed. Just a small particle (a hair, a grain of sand, etc.) on the seals can cause a water leak.
- Do not open/close the external connection terminal cover, card slot cover, or earphone microphone terminal cover with gloved hands. Just a small particle (a hair, a grain of sand, etc.) on the seals can cause a water leak. Wipe off any minuscule droplets of water or dirt with a clean, dry cloth before closing the covers.
- If the external connection terminal cover, card slot cover, or earphone microphone terminal cover is deteriorated or damaged, the waterproof property becomes ineffective.

■ If any liquid other than plain water gets on the product

- If any liquid other than plain water (e.g. seawater, detergent, alcohol) gets on the product, immediately rinse it with plain water.
- You can wash the product under a mild flow (up to 6 litres per minute) of tap water at room temperature (5°C to 35°C) at a distance of about 10 cm from the tap or showerhead.
- If the product gets dirty, do not use a brush as you hand-wash it, holding down the external connection terminal cover, card slot cover, and earphone microphone terminal cover so that they do not open.

■ After the product gets wet

- After the product gets wet, drain the water, and wipe the main unit with a clean, dry cloth. Do not blow hot air (e.g. hairdryer) on the product.
- In cold climates, water on the product might freeze. Using a frozen product might cause a fault. Do not leave the product without first wiping off the water. (No special measures against condensation have been implemented on this product.)

■ Rubber seals

- The rubber seals around the external connection terminal cover, card slot cover, and earphone microphone terminal cover are important to maintaining the waterproof properties. Do not damage or remove the rubber seals.
- When closing the external connection terminal cover, card slot cover, or earphone microphone terminal cover, take care not to snag the rubber seals. Forcibly closing the covers when the rubber seals are snagged might damage them, resulting in loss of the waterproof properties. Just a small particle (a hair, a grain of sand, etc.) on the seals can cause a water leak.
- If any liquid other than plain water (e.g. alcohol) gets on the rubber seals, it may cause deterioration in durability.
- Do not insert sharp objects into the gaps around the external connection terminal cover, card slot cover, or earphone microphone terminal cover. Doing so might damage or deform the product or damage the rubber seals, causing a water leak.

■ Impact

The product might break if it is intentionally subjected to extreme impact, such as being thrown or dropped forcibly. The product can also be damaged, etc. from a normal drop. Do not poke the microphone, speaker, noise cancelling microphone, etc. with a cotton swab or sharp object. Doing so may damage/deform the product or allow the intrusion of water.

Draining water after wetting the product

If the product has gotten wet, there are some non-waterproof areas. If you use the product in this state, water remaining in those parts might dampen your clothes or bag, or the sound might become hard to hear.

- Follow these steps to drain the water.

- 1 **Thoroughly wipe away water from the surface of the product with a clean, dry cloth that doesn't shed fibres.**

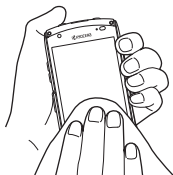

- 2 **Grasp the product firmly, and shake it in the direction of the arrows until water no longer comes out (Noise cancelling microphone side: at least 20 times each direction, Speaker/microphone side: at least 20 times each direction)**
 - When shaking the product, stay alert to your surroundings.
 - Be careful that the product does not slip from your hand, but hold it firmly to drain water.

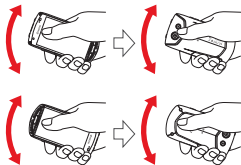

- 3 **Wipe off the water that came out, and place the product on top of a clean, dry towel or cloth at room temperature.**
 - The microphone, the speaker, and the noise cancelling microphone are particularly hard to drain. Place those parts face down and press each area to wipe them.

- 4 **Press the product gently into a clean, dry cloth that doesn't shed, and wipe off the water that remains in the gaps in the microphone, speaker, noise cancelling microphone, etc.**

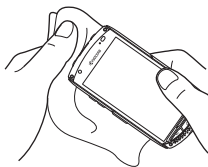

- 5 **After thoroughly draining the water, leave the product to dry for an hour or more at room temperature.**
Even after you do these steps, water may remain on the product. Do not place the product near things that you do not want to get wet. Also, take care not to let it dampen your clothes, bag, etc.

Precautions on charging

Accessories do not have waterproof/dustproof properties. Be sure to check the following points before and after charging.



- Never charge the battery while the product is wet. Doing so might cause electric shock or a short circuit, resulting in fire, burns, or a fault.
- Check that the product is not wet. If you are charging the battery just after the product gets wet, thoroughly drain the water and wipe the remaining water off with a clean, dry cloth before opening the external connection terminal cover.
- If you charge the battery with the external connection terminal cover open, be sure to tightly close the cover when charging is finished.
- Do not touch the AC adapter with wet hands. Doing so might cause electric shock.
- Do not splash water over the specified charging equipment. Do not use it near water, such as in a bathroom, shower room, kitchen, or toilet. Doing so might cause fire, electric shock, injury, or a fault. Do not bring it into a bathroom, etc. even when you are not charging. Doing so might cause fire, electric shock, injury, or a fault.





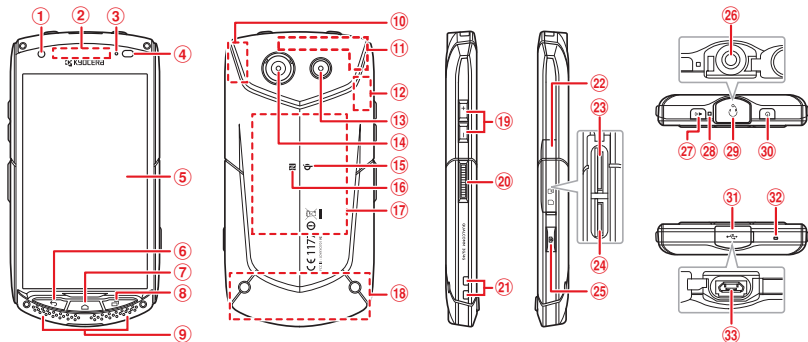

Using Apps

- Be sure to check the security of the app, then install it at your own risk. Some apps might contain viruses, damage various data, or transmit your location information, usage history, or the personal information stored in the product via the Internet.
- If an app you install causes some sort of malfunction, the Company will not be held responsible. Repair costs in this case may be charged, even during the warranty period.
- The Company assumes no responsibility for any disadvantages brought upon you or any third party by the apps you have installed.
- Inserting a microSD card is necessary to use some apps.
- Some apps prohibit the product from entering sleep mode while they are active, or rapidly drain the battery while running in the background.
- Operational procedures and the on-screen appearance of apps that were preinstalled on this product or installed by you are subject to change without notice as a result of version upgrades. In addition, operating procedures described in this manual may differ from the actual procedures.

Names and Functions of Parts



- ① Front-facing camera (lens)
- ② Receiver: Hear the voice of the other party during a phone call. This product is equipped with a SMART SONIC RECEIVER, which vibrates the display to relay sounds. The receiver section does not have holes, but can still be used normally.
- ③ Incoming (charging) light
Illuminates red while charging. Flashes green when you have an incoming call, e-mail, etc.
- ④ Proximity sensor/Light sensor: The proximity sensor prevents erroneous operation of the touch panel during a call. The light sensor detects ambient brightness to adjust the display brightness. Do not put things like stickers over the proximity sensor/light sensor.
- ⑤ Display (touch panel)
- ⑥  Back key: Return to the previous screen.
- ⑦  Home key: Display the Home screen or cancel Sleep mode. Press and hold for at least 1 second to activate Google Now.
- ⑧  Recent apps key: Display and activate recently-used applications, or remove them from the list to close them.
- ⑨ Speaker: Hear notification and alarm noises.
- ⑩ GPS aerial
- ⑪ Sub aerial
- ⑫ Bluetooth® aerial/Wi-Fi aerial
- ⑬ Flash/Torch
- ⑭ Rear-facing camera (lens)
- ⑮ Φ mark
When charging wirelessly, place the area with the Φ mark on top of the Φ marked area of the wireless charging device.

- 16 NFC mark
- 17 NFC aerial
- 18 Main aerial
- 19  Volume UP/DOWN key: Adjust the volume. Press and hold  for at least 1 second to set/cancel Silent mode.
- 20  Direct button: Press and hold for at least 1 second to activate a set function or application. Change the function from the Settings menu.
- 21 Strap eyelet
- 22 Card slot cover
- 23 MicroSD card slot
- 24 Nano SIM card slot
- 25  Camera key: Press and hold for at least 1 second to activate the camera. Also used as the shutter for taking pictures.
- 26 Earphone microphone terminal
- 27  Speakerphone key: Switch speakerphone on/off during a call.
- 28 Noise cancelling microphone: Automatically filters out ambient noise to make it easier for the other party to hear your voice. Do not cover it with your finger during phone calls.
- 29 Earphone microphone terminal cover
- 30  Power key: Turn the power on/off, set/cancel Sleep mode, etc.
- 31 External connection terminal cover
- 32 Microphone: Transmits your voice to the other party during a call. Also used for voice recording. Do not cover it with your finger during phone calls or video shooting.
- 33 External connection terminal: Used for connecting a micro USB cable, etc.

Notes

- Aerials are built into the main unit. Do not cover the aerials with your hand or put things like stickers over the areas. Doing so can adversely affect calling/transmission quality.
- The battery is built into the product, so you cannot remove it. Forcibly removing the back cover causes damage or faults.
- The product contains a barometer. Using an app that displays the atmospheric pressure, you can view the atmospheric pressure and altitude, but these values are not absolute. A variety of factors can cause fluctuations, so these values are merely guidelines.

About the SMART SONIC RECEIVER

This product is equipped with a SMART SONIC RECEIVER, which vibrates the display to relay sounds. The receiver section does not have holes, but can still be used normally.

Touching to your ear

When you touch the product to your ear in the vicinity of the receiver, covering your ear to shut out ambient noise makes it easier to hear vocal sounds. Make adjustments, moving the product up/down/left/right according to your hearing conditions and the surrounding environment.

Notes

- While calling, be careful not to cover the microphone or noise cancelling microphone of the product with your finger, etc.
- When earphones are connected, sound comes from the earphones and not from the SMART SONIC RECEIVER.
- Do not put any stickers or clear film on the display. Sounds from the receiver can become harder to hear.
- The ease of hearing depends on the person.
- A person's ability to hear varies depending on the surrounding environment.

Inserting/Removing a Nano SIM Card

- Unplug the power adapter or other micro USB plug from the product when inserting/removing a nano SIM card.

Notes

- If a nano SIM card is inserted, the product can make phone calls and transfer data. Available mobile networks are different depending on the country and the region. Connecting to the network may require configuration of the product. If you are unable to connect the product to a network, please contact your service provider.
- Depending on the nano SIM card, there is a chance that inserting the nano SIM card might damage the product or the card, itself.

KYOCERA does not cover damage caused by those or any modified nano SIM cards in the warranty, and assumes no such responsibility.

Inserting a nano SIM card

- 1 **Turn off the product, and open the card slot cover.**
- 2 **Check the alignment of the nano SIM card, and slowly insert it straight until you hear it click.**
When inserting, make sure there is a click to signify it locking. If you remove your finger before the nano SIM card is locked in place, it may come flying out.
 - The nano SIM card slot is on the left side, while the microSD card slot is on the right, as illustrated below.

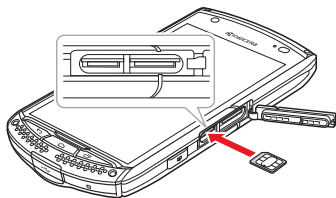

- 3 **Close the card slot cover.**

Removing a nano SIM card

- 1 **Turn off the product, and open the card slot cover.**
- 2 **Slowly press in the nano SIM card until it clicks.**
Once it clicks, pull your finger back slightly, along with the nano SIM card. If you release your finger after pushing hard, the card may come flying out.

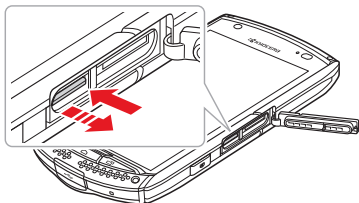

- 3 **Slowly pull the nano SIM card straight out.**
Some nano SIM cards cannot be unlocked and do not eject. In this case, remove the card by pulling lightly with your fingers.
- 4 **Close the card slot cover.**

Note

- Do not forcefully remove the nano SIM card. Doing so might cause a fault, damage, or loss of data.

Inserting/Removing a MicroSD Card

This product is compatible with microSD cards, microSDHC cards, and microSDXC cards.

- Contact the microSD card maker about compatible microSD cards.

Notes

- Do not touch the microSD card terminal section.
- A microSD card that was initialized on another device may not function properly in the product, so use the product to initialize.
- microSDXC cards can only be used by devices compatible with SDXC.

Inserting a microSD card

- 1 **Open the card slot cover.**
- 2 **Check the alignment of the microSD card, and slowly insert it straight until you hear it click.**
When inserting, make sure there is a click to signify it locking. If you remove your finger before the microSD card is locked in place, it may come flying out.
 - The nano SIM card slot is on the left side, while the microSD card slot is on the right, as illustrated below.

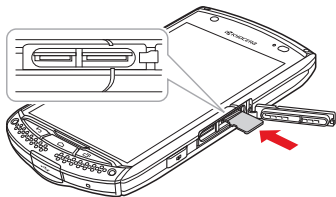



- 3 **Close the card slot cover.**

Note

- The front/back and top/bottom of a microSD card are distinct. Forcing the card into the slot can cause an inability to remove the card or damage to the data.

Removing a microSD card

- 1 **On the Home screen tap  ►  ► [Storage] ► [Unmount SD card] ► [OK].**
- 2 **Open the card slot cover.**
- 3 **Slowly press in the microSD card until it clicks.**
Once it clicks, pull your finger back slightly, along with the microSD card. If you release your finger after pushing hard, the card may come flying out.

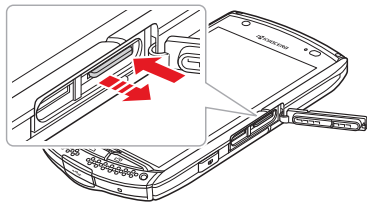

- 4 **Slowly pull the microSD card straight out.**
Some microSD cards cannot be unlocked and do not eject. In this case, remove the card by pulling lightly with your fingers.
- 5 **Close the card slot cover.**

 **Notes**

- Do not forcefully remove the microSD card. Doing so might cause a fault, damage, or loss of data.
- After being used for a long period, the microSD card that you removed may be hot, but this is not a problem.

Charging

The internal battery is not fully charged at the time of purchase. Be sure to charge the battery before using the product.

When the illuminated red charging light turns off, charging is complete.

 **Notes**

- While charging, the product becomes hot, but this is not abnormal.
- If you use the camera or other functions while charging, the time it takes to charge might lengthen.
- Turning on the torch while charging causes charging to stop. Turn off the torch to resume charging.
- Doing various operations while the product is connected to a power adapter may cause you to repeatedly charge and discharge the battery in short intervals, and the duration of a single use will shorten.
- If the ambient temperature or the temperature of the product becomes too hot or too cold, charging may stop. Whenever possible, try to charge at room temperature.

- If the product's charging light begins flashing red, check whether it is connected properly. If it continues flashing, stop charging.
- To keep water and dust from entering, securely close the external connection terminal cover after charging is complete. Do not strongly pull or twist the cover.
- If you stop charging when the charging light is still illuminated, the product may not be fully charged, even if the  icon is displayed. In this case the usage life will be shorter.
- Do not charge wirelessly while a power adapter or microUSB cable is connected. This can not only prevent proper charging, it might cause a fault.
- While charging the electric current can affect magnetism, so the geomagnetic sensor might not function properly.

Using the power adapter to charge

- Usable adapters are different depending on the country or region.

- 1 **Open the product's external connection terminal cover.**
- 2 **Insert the micro USB plug of the micro USB cable straight into the external connection terminal, with the protrusions pointing down.**

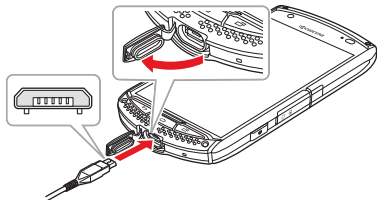

- 3 **Insert the USB plug of the micro USB cable straight into the adapter's USB port, and insert the adapter into the mains.**
Check that the product's red charging light turns on. When charging is complete, the charging light turns off.







- 4 **When charging is complete, remove the micro USB plug straight from the external connection terminal.**
- 5 **Close the external connection terminal cover.**
- 6 **Unplug the adapter from the mains.**

Notes

- The mains should be a short distance from the product and easily accessible.
- Applying unnecessary force to the external connection terminal when it's connected to an external device might cause damage.
- If you charge the device when the battery is empty, the charging light may not turn on immediately, but charging has begun.

Turning the Power On/Off

Turning on the power

- 1 **Press  until the product vibrates.**
When the Start screen appears, tap  and then tap  to cancel the security. After tapping , tap  to activate the camera, or  to activate the phone.

Note

- While the various logos are being displayed after turning on the power, do not touch the screen, because the touch panel's initial settings are being processed. If you do, the touch panel may not function normally.

Start screen

Swipe right and left to switch between the Compass, Barometer, and other widgets that are displayed on the Start screen.

- Change the Start screen from the Settings menu.



- Widget
- Indicator

Tap to switch widgets, and tap to add widgets from a list.

Sleep mode

If the product is not operated for a set amount of time, the screen darkens to curb battery consumption, and the product enters Sleep mode.

- Press to enter Sleep mode.
- Press or to cancel Sleep mode.
- The time it takes to enter Sleep mode can be changed in the Settings menu.

Note

- While in Sleep mode, when you press or to display the screen, do not touch the screen. If you do, the touch panel may not function normally.

Turning off the power

- Hold down for at least 1 second.
- [Power off] ► [OK]

Note

- If the screen is not responding and you cannot turn off the power, hold down for at least 11 seconds to force the product to turn off and restart. If you force the product to restart, unsaved data will be lost. Do not do so unless the product is inoperable.

Initial Settings

After turning on the power, if a language selection screen is displayed, follow the on-screen instructions to choose your initial settings.

1 Confirm each setting

- Language settings
- Nano SIM card insertion
- Wi-Fi function settings
- Google account settings

Notes

- If the screen operations guide is displayed, confirm the contents, and proceed.
- If you did not set up the Wi-Fi function in step 1, date and time settings, Google services, and other screens will appear.
- You can change the settings later from the Settings menu.

How to Use the Touch Panel

Touch panel precautions

- The touch panel is designed to be lightly touched by your fingers. Do not apply strong pressure to the touch panel with your fingers or sharp-pointed objects (such as fingernails, ballpoint pens, and pins).
- If you do the following things, the touch panel may become unresponsive to touch. Note that these may even cause a malfunction.
 - Operation with fingernails
 - Operation with a foreign substance still on the display
 - Operation with a protective sheet or sticker on the screen
 - Operation underwater
- If touch operation with gloves is not possible immediately after operating with no gloves, temporarily put the product in Sleep mode and reawaken it. Please read the precautions regarding the “Touch panel” as well (P. 16).

Operating the touch panel

- **Tap**
Lightly touch an icon, menu item, etc. with your finger, and release quickly.
- **Double-tap**
Quickly tap twice in the same location.
- **Touch and hold**
Touch an icon, menu item, etc. with your finger for an extended time.
- **Swipe (flick)**
Touch the screen and move your finger up/down/left/right as if sweeping something aside.
- **Drag**
Trace your finger across the screen until reaching your desired position, then release.
- **Scroll**
When a screen's contents are not all displayed, move the contents up/down/left/right to move the display position.
- **Spread/pinch with 2 fingers**
Touch the screen with 2 fingers, and widen the space between your fingers to enlarge the display, or close the space to shrink the display.

Home Screen

The Home screen is configured across multiple parts. Swipe right and left to switch parts.



- ① **Status Bar**
The left side of the status bar displays missed calls, new e-mails, and other notification icons, while the right side displays the product's current conditions as status icons.
- ② **Google Search widget**
You can enter characters into the search box to search for information on the product or by using the Internet.
- ③ **Customizable area**
Arrange apps, widgets, and folders here.
- ④ **Indicator**
Displays your current position on the Home screen.
- ⑤ **Quick launch area**
Displays on all parts of the Home screen.
- ⑥  **Apps list**
Displays the Apps list.

Notes







- To relocate an app or widget on the Home screen, touch and hold, then drag it. To remove it, touch and hold the item, then drag it to  at the top of the screen.
- To arrange the apps on the Home screen into folders, touch and hold, then drag an app to where it overlaps with another app to create a folder.
- If you touch and hold on an area of the Home screen without any apps or widgets, you can change the wallpaper, add widgets and Home screen pages, etc.

















Status Bar

The status bar is displayed at the top of the screen. The left side of the status bar displays missed calls, new e-mails, and other notification icons, while the right side displays the product's current conditions as status icons.

Status icons

The main status icons displayed on the status bar are as follows.

















-  : Signal strength
-  : Out of range
-  : 3G available
-  : 3G in communications
-  : LTE available
-  : LTE in communications

-  : GSM available
-  : GSM in communications
-  : Battery level
-  : Charging
-  : Low battery
-  : Nano SIM card uninserted
-  : Wi-Fi connected
-  : Wi-Fi in communications
-  : Mobile data unavailable
-  : Bluetooth function turned on
-  : Bluetooth device connected
-  : Aeroplane mode set
-  : Silent mode (vibration) set
-  : Silent mode (mute) set
-  : Alarm set
-  : GPS positioning on

Notification icons

The main notification icons displayed on the status bar are as follows.

-  : New e-mail message
-  : New Gmail message
-  : New SMS message
-  : New MMS message
-  : Screenshot
-  : Data download completed
-  : Data upload completed
-  : Data received via Bluetooth connection
-  : MicroSD card dismantled
-  : Update available

-  : Installation completed
 -  : Call arriving
 -  : Missed call
 -  : Calendar event notification
 -  : Stopwatch in use*
 -  : Timer in use*
 -  : Alarm advance notice
 -  : Playing music with Play Music*
 -  : Wi-Fi function is on and Wi-Fi network available
 -  : Error message/warning message
 -  : Connected by Wi-Fi tethering
 -  : Connected by USB tethering
 -  : Connected to 2 or more tethers
 -  : Connected by Bluetooth tethering
 -  : Eco mode activated
 -  : Diminished free space in internal memory
 -  : Notifications that cannot be displayed
- * Appears when you switch to the Home screen and some other screens.

Notification Panel

Swipe down on the status bar to display the Notification panel, check the contents of notification icons, and run applications. Swipe down on the status bar with 2 fingers to display the Quick settings screen, set functions on/off, etc.





- ① Quick settings icon
Displays the Quick settings screen.
- ② Clear all
Delete all content displayed in the notification panel. Depending on the notification content, sometimes it cannot be deleted.
- ③ Notification panel icon
Displays the Notification panel.

Notes

- To close the notification panel, press .
- Swipe a notification to the right or left to clear it from the list on the Notification panel.
- Touch and hold a notification on the notification panel to check the application information.

Using the Apps List

- Display a screen menu either by tapping  or by touching and holding an input field or item.
- 1 **On the Home screen tap .**
A list of installed apps is displayed.
Tap to open.







Note

- To add an app from the Apps list to the Home screen, touch and hold, then drag the app to wherever you want it.









Phone

The nano SIM card is necessary for making calls.



Making a phone call

- 1 **On the Home screen tap  ► .**
- 2 **Enter phone number ► tap .**
 - Tap  to erase the number.
- 3 **When you've finished a call tap .**



Notes

- To adjust the call volume (the volume of the other party's voice), press   during a call.
- To switch speakerphone on/off during a call, tap . To switch call holding on/off tap .
- Be careful, as even if you cover the microphone, your voice will reach the other party. To prevent the other party from hearing your voice during a call, mute yourself from .
- When you hold the phone to your ear, etc. while calling, the screen turns off to prevent malfunction.
- In step 1 tap  to display the outgoing call log, or tap  to display the incoming call log. You can make a call using the call log.
- In step 1 tap  to display a list of your contacts and make a call from your contacts.



Receiving a call

- 1 **When a call is arriving, drag  to  on the right.**
- 2 **When you've finished a call tap .**

Notes

- To turn off the ringtone and vibration when receiving a call, press   .
- Tap  while receiving a call to end the call with a message or reject the call.

Displaying your own phone number

- 1 **On the Home screen tap  ► 
► [About phone].**
- 2 **[Status] ► [My phone number]**

Note

- You can also check your phone number from your profile in the People app.



People

People displays various information for each of your contacts.



Note

- The names, numbers, etc. that are registered in People can disappear due to an accident or fault. We recommend making copies of phone numbers, etc. Note that the Company assumes no responsibility for any damages or lost profits resulting from altered or lost contacts caused by an accident or failure.

Displaying contacts

- 1 **On the Home screen tap  ► .**
Displays your contacts list.

Registering contacts

- 1 **On the Home screen tap  ► .**
- 2 **Tap .**
 - If the account selection screen is displayed, follow the on-screen instructions.
- 3 **Enter the necessary items.**





4 [DONE]

- If you tap a registered contact, the details are displayed, and you can check the registered content.

 **Notes**

- If your contacts are not registered at step 1, a selection screen for creating a new contact, setting up an account, or importing contacts is displayed.
- You can manage your own profile from the contacts list.
- After setting up an account, on the contacts list tap  to create and manage groups. Also, contacts that are saved on the server can be synced with those in People on the product. To set up an account, something like Wi-Fi or a nano SIM card that can connect to the network is necessary.
- You can import and export contacts from the internal storage, a microSD card, etc.

Editing contacts

- 1 **On the Home screen tap**   
▶ **choose a contact.**
- 2   **[Edit]**
- 3 **Choose and edit items.**
- 4 **[DONE]**

 **Note**





- After tapping  in step 2, you can delete a contact, share it via another application, etc.

Messaging

A nano SIM card that can connect to the network is necessary.

- The number of characters and amount of data that you can send varies depending on the transmission method. Depending on your service provider, you might not be able to use this feature.

Sending a message.

- 1 **On the Home screen tap**  
.
- 2 **Enter the recipient's phone number or e-mail address.**
- 3 **Enter the main text.**
- 4 **Tap**  / .

 **Note**

- Depending on your contract and service provider, you can tap  while creating a message to attach and send files.

Reading a message

Received messages are displayed by their participants.

- 1 **On the Home screen tap** .
- 2 **Choose the message you want to check.**

Notes



- To reply, enter a message into the message field and send.
- Touch and hold a message to do things like forward or delete it.

Email

Something like Wi-Fi or a nano SIM card that can connect to the network is necessary. You can send and receive emails as if on a computer.

- To use Email it is necessary to set up an email account beforehand (P. 57). You can even set up multiple email accounts.

Creating and sending an email

- 1 **On the Home screen tap**   .
- 2 **Enter the recipient's email address.**





- 3 **Input the subject and body.**

- 4 **Tap** .





Note

- Tap  while creating an email to attach a file, add an address, etc.

Receiving and reading an email

- 1 **On the Home screen tap**  .
 - If multiple email accounts are set up, tap an account at the top of the screen to choose which email account is displayed.
- 2 **On the Inbox or other screen tap**   **[Refresh]**.
- 3 **Tap an email.**

Notes

- Tap  to reply, or tap  to forward or reply all. Then create an email and send.
- To delete an email, in the Inbox or individual folder screen touch and hold the email and tap , or choose the email and then tap .

Gmail





Something like Wi-Fi or a nano SIM card that can connect to the network is necessary. You can check, send, and receive Gmail messages from this product.

- To use Gmail it is necessary to set up a Google account beforehand (P. 57). You can even set up multiple Google accounts.

Note

- For more details on things like usage, please refer to the Google home page.





Creating and sending a Gmail

- 1 **On the Home screen tap**   .
- 2 **Enter the recipient's email address.**
- 3 **Input the subject and body.**
- 4 **Tap** .





Note

- Tap  while creating a Gmail to attach a file, add an address, etc.

Receiving and reading a Gmail

- 1 **On the Home screen tap**   .
 - If multiple Google accounts are set up, tap an account at the top of the screen to choose which Google account is displayed.
- 2 **On the Inbox or other screen tap**   **[Refresh]** .
- 3 **Tap Gmail.**

Notes



- Tap  to reply, or tap  to forward or reply all. Then create a Gmail and send.
- To delete a Gmail, in the Inbox or individual folder screen touch and hold the Gmail and tap , or choose the Gmail and then tap .

Chrome

Something like Wi-Fi or a nano SIM card that can connect to the network is necessary.

- If the Google Chrome Terms of Service are displayed, confirm the contents, and follow the on-screen instructions.

Connecting to the Internet





- 1 **On the Home screen tap** .
- 2 **Enter search terms or a URL in the URL entry field at the top of the screen.**
- 3 **Tap one of the search suggestions or** .

Note

- If you touch and hold a link or image, a menu is displayed, from which you can save, copy, etc.

Registering a bookmark

You can register frequently viewed web pages as bookmarks, so they're easy to display.

- 1 **On the Home screen tap** .
- 2 **Display a web page you want to register.**
- 3 **Tap**   .
- 4 **Set the name and save folder**  **[Save].**

Note

- On a web page tap  to display your registered bookmarks and history, change your Chrome settings, etc.



Camera

You can take pictures and video.

Note

- If the remaining battery is low or if the product becomes too hot, you cannot use the camera. Also, if the battery is depleted or the temperature rises during use, the brightness of the display might dim.

Activating the camera







- 1 **On the Home screen tap .**
 - You can also hold down  for at least 1 second to activate the camera.











Note

- Press  to close the camera.





Shooting screen icons

The main icons displayed on the Shooting screen are as follows.





- Displayed items will vary depending on the camera settings.
-  : Remaining battery
-  : Save location
-  : Store position/location information
-  : Scene-specific shooting/Focus
 - If the scene is set to , the focus settings icon is displayed.
-  : Continuous shooting mode

-  : Self-timer
-  : Effect
 - Is displayed if the shooting mode is set to .
-  : Mute
-  : Remaining number of pictures possible
-  : Length of video recording possible
-  : Take picture (Shutter)
-  : Record video
-  : Stop
-  : Switch between front-facing and rear-facing cameras
-  : Settings
 - Set Continuous shooting, Panorama, and other shooting modes; set Portrait, Landscape, and other scene-specific shooting; and control the Timer, the Flash, and other settings.





Taking pictures

- 1 **On the Home screen tap .**
 - You can also hold down  for at least 1 second to activate the camera.
- 2 **Tap .**
 - You can also press  to shoot.

 **Notes**

- You can adjust the focal point by tapping the screen.
- The zoom bar is displayed when you tap the screen or press  . Drag your finger across the screen to adjust the zoom.
- Hold down  and  simultaneously for at least 1 second to save a screenshot of the screen that is being displayed.

Taking videos

- 1 **On the Home screen tap .**
 - You can also hold down  for at least 1 second to activate the camera.
- 2 **Tap .**
Recording begins.
- 3 **When you've finished recording tap .**
 - You can also press  to finish recording.



 **Note**

- When taking videos, do not cover the microphone with your finger, etc.



Gallery

You can edit, view, and playback the pictures, videos, and so forth that are saved to internal storage or a microSD card.

- The first time you activate the Gallery, the Google usage screen is displayed.

- 1 **On the Home screen tap  ► .**
- 2 **Tap a folder.**
- 3 **Tap a picture or video.**
 - For videos, continue by tapping  and choosing an app.

 **Notes**

- Pictures and videos can also be displayed in the  app and from the thumbnails visible when the camera is open.
- On the playback screen for pictures and videos tap  to do things like delete, edit, and crop them.

Play Store

To install an app from Google Play, something like Wi-Fi or a nano SIM card that can connect to the network is necessary.

- Setting up a Google account is necessary to use Google Play.



- 1 **On the Home screen tap** .
- 2 **Search for the app ► choose the app.**
 - After looking over the displayed content, follow the on-screen instructions.

Notes

- For paid apps, follow the purchasing procedure before downloading.
- You can remove apps that were installed via Google Play, as well as reference the help page.
- Depending on the app, it may perform automatic updates.
- Operational procedures and the on-screen appearance of apps are subject to change without notice as a result of version upgrades. Be aware that they may differ from the descriptions in this manual.

Eco Mode

Battery consumption is reduced by changing the screen's Sleep time or brightness and by disabling the Wi-Fi and Bluetooth functions.



- 1 **On the Home screen tap**  ► .
- 2 **Tap [ECO MODE].**
- 3 **[On]/[Auto On]**
- 4 **Set each item.**

Notes



- When setting Eco Mode to Auto On, set the battery level where the product switches into Eco Mode.
- You can also set restrictions on background mobile data transmissions.

Displaying the Settings Menu

Change various settings from the Settings menu.

- 1 **On the Home screen tap**   

WIRELESS & NETWORKS

- 1 **On the Home screen tap**   
- 2 **Choose item operation.**
[Aeroplane mode] : Set Aeroplane mode.
[Wi-Fi] : Set Wi-Fi function.
[Bluetooth] : Set Bluetooth function.
[Data usage] : Set whether mobile data transmissions are enabled/disabled, and set an upper limit on data usage.
[More...] : Tap to display the following items.
[Default SMS app] : Set up the message application used on the product.
[NFC] : Enable/disable NFC function.

[Android Beam] : Use the Android Beam function to exchange data with cellular phones and other devices equipped with an NFC function.

[Tethering & portable hotspot] : Use the product as a modem and connect other USB-compatible devices, Wi-Fi devices, and Bluetooth devices to the Internet.



[VPN] : Use a virtual private network for outside connection to information that is saved within the local network of a business, school, etc.

[Mobile networks] : Set whether mobile data transmissions are enabled/disabled, and setup an access point for connecting to the Internet.

[Mobile broadcasts] : Control settings related to emergency alerts.

Setting Aeroplane mode

Calling, Internet connections, email correspondence, and all other functions that transmit radio waves are disabled.

- 1 **On the Home screen tap**   

- 2 Tap  for **Aeroplane mode or drag it to the right.**
 - When on,  is displayed in the status bar.

Note



- You can also hold down  for at least 1 second to set Aeroplane mode.

Wi-Fi

You can use Wi-Fi to connect to home networks, work networks, public wireless LAN services, and other wireless access points.

- You can still use the mobile network when the Wi-Fi function is turned on. However, the Wi-Fi function gets priority when connected to a Wi-Fi network.

Connecting to a Wi-Fi network

- 1 **On the Home screen tap  ► .**
- 2 Tap  for **Wi-Fi or drag it to the right.**
- 3 **[Wi-Fi]**
 - A list of available Wi-Fi networks is displayed.





- 4 **Choose a Wi-Fi network.**
 - If you are connecting to a Wi-Fi network with security protection, password entry is necessary.

Note

- To disconnect from a Wi-Fi network, select the Wi-Fi network you are currently connected to.

Easily setting up a Wi-Fi network

You can easily connect using WPS features.

- Turn on the Wi-Fi function before starting.
- 1 **On the Home screen tap  ► 
► [Wi-Fi].**
 - 2 **Manipulate as intended.**
 - If connecting by the WPS button method, operate from . If connecting by the WPS PIN entry method, operate from . Follow the onscreen instructions to operate.

Bluetooth Function





Connect the product to a Bluetooth device to do things like wireless transmissions and music playback.

- We do not guarantee a wireless connection with all Bluetooth devices.
- Connect with other Bluetooth devices within about a 10 m radius, unobstructed. Depending on if there are any obstacles between the product and a Bluetooth device, the general surroundings (walls, furniture, etc.), and the structure of the building, the connection range may be shorter.
- The supported profiles and features*1 are as follows:
 - SPP: Serial Port Profile
 - A2DP: Advanced Audio Distribution Profile
 - AVRCP: Audio/Video Remote Control Profile
 - HSP: Headset Profile
 - HFP: Hands-Free Profile
 - OPP: Object Push Profile
 - PBAP: Phone Book Access Profile
 - HID: Human Interface Device Profile
 - PAN: Personal Area Networking Profile
 - PAN NAP: Personal Area Networking- Network Access Point

- PAN USER: Personal Area Networking-User
- HOGP: HID over GATT Profile
- MAP: Message Access Profile
- DUN: Dial-Up Networking Profile*2

- *1 Specifications provided in Bluetooth standards for communications between Bluetooth-compatible devices in accordance with their intended use.
- *2 Compatible with only a portion of car navigation systems.

Registering and connecting to a Bluetooth device

- While registering a device, it may be necessary to enter a PIN. The product's PIN is "0000". If product registration does not work when you enter "0000", refer to the Bluetooth device's operating instructions.
- 1 **On the Home screen tap  ► .**
 - 2 **Tap  for Bluetooth or drag it to the right.**
 - When on,  is displayed in the status bar.
 - 3 **Tap [Bluetooth] ► the name of the product.**

- 4 [SEARCH FOR DEVICES]
- 5 Choose a Bluetooth device.
- 6 Follow the on-screen instructions.



■ If receiving a connection request from another Bluetooth device

- 1 Confirm the pass code on the Pair settings request screen ► [Pair].

Setting up an access point



You can set up an access point for connecting to the Internet. They can be added and changed as needed.

- Contact your service provider regarding the information necessary to set up an access point.

- 1 On the Home screen tap  ►  ► [More...] ► [Mobile networks] ► [Access Point Names].
- 2 Tap .
- 3 [Name] ► enter name ► [OK].
- 4 [APN] ► enter access point name ► [OK].
- 5 Set the items required by your service provider.



- 6  ► [Save]

DEVICE

- 1 On the Home screen tap  ► .
- 2 Choose item operation.
 - [Sound/Vibration/LED] : Set Silent mode or Vibrate, ringtones, notification sounds, operation sounds, and other things related to the sound and Incoming light.
 - [Display] : Set screen brightness, wallpaper, auto-rotate screen, Sleep mode, font size, and other things related to the screen display.
 - [Direct button] : Choose which function or application activates with you hold down  for 1 second or more.
 - [Storage] : Confirm the capacity of the product or a microSD card, or initialize a microSD card.
 - [Battery] : Check the remaining battery level, charging status, battery usage time, and the battery use of each function.
 - [Apps] : Manage and delete applications that you installed, view their memory usage, change the settings, etc.

Setting Silent mode



Set the product to not release ringtones and notification sounds from the speaker.

- 1 **On the Home screen tap**  **►** 
► [Sound/Vibration/LED].
- 2 **Put a tick by [Silent mode].**
- 3 **[OK]**





Note

- You can also hold down  for at least 1 second to set Silent mode.



Changing the Silent mode type

- 1 **On the Home screen tap**  **►** 
► [Sound/Vibration/LED] ►
[Silent mode type].
- 2 **[Vibrate]/[Silent]**



Note

- Hold down  for at least one second, and then tap  /  to switch between Silent/Vibrate. Tap  to turn off Silent mode.

Setting a ringtone



- 1 **On the Home screen tap**  **►** 
► [Sound/Vibration/LED] ►
[Phone ringtone].
- 2 **Choose a ringtone ► [OK].**

Setting a wallpaper

- 1 **On the Home screen tap**  **►** 
► [Display] ► [Wallpaper].
- 2 **Choose an item.**
- 3 **Follow the on-screen instructions.**



Automatically switching between a vertical and horizontal screen display

Set the screen to automatically switch between a vertical display and a horizontal display, depending on how the product is oriented.



- 1 **On the Home screen tap**  **►** 
► [Display].
- 2 **Put a tick by [Auto-rotate screen].**

Setting a screen off time



After a set amount of time passes, the screen automatically goes dark and enters Sleep mode.

- 1 **On the Home screen tap**  **►** 
► [Display] ► [Sleep].
- 2 **Choose a time.**

PERSONAL

- 1 **On the Home screen tap**  ► .
- 2 **Choose item operation.**
[Location] : Control settings related to location information from using the Wi-Fi function, GPS, etc.
[Start screen] : Control settings related to the Start screen.
[Security] : Control settings related to security.
[Language & input] : Set the display language and things related to character input.
[Backup & reset] : Back up data, restore settings, or reset the product.

Setting the security release method for the Start screen



- 1 **On the Home screen tap**  ►  ► **[Start screen]** ► **[Security type]**.
- 2 **[None]/[Swipe]/[Face Unlock]/[Pattern]/[PIN]/[Password]**
- 3 **Follow the on-screen instructions.**

Note

- If you set a password or other release method, be careful not to forget it.



Resetting the product

When you reset the product, all of the data and applications stored on the product are erased.

- Be sure to backup your data before resetting.
- 1 **On the Home screen tap**  ►  ► **[Backup & reset]** ► **[Factory data reset]** ► **[Reset phone]**.
 - Depending on the security release method you have set for the Start screen, it may be necessary to unlock it.
 - 2 **[Erase everything]**

ACCOUNTS



Adding an account

- 1 On the Home screen tap  ► 
► [Add account].
- 2 Choose an account type.
- 3 Follow the on-screen instructions.



Note

- Even if you do not have a Google account, you can use the product, but you cannot use Google services like Gmail, Google Play, etc.

SYSTEM

- 1 On the Home screen tap  ► .
- 2 Choose item operation.
 - [Date & time]** : Control settings related to date and time.
 - [Accessibility]** : Control settings related to accessibility.
 - [Printing]** : Control settings for a printer using Google Cloud print.
 - [About phone]** : Check information such as your phone number and remaining battery life.

Setting the date and time

- 1 On the Home screen tap  ► 
► [Date & time].
- 2 Set each item.
 - [Automatic date & time]** : Automatically use network information to revise the date and time.
 - Remove the tick to manually set the date and time.
 - [Automatic time zone]** : Automatically use network information to revise the time zone.
 - Remove the tick to manually set the time zone.
 - [Set date]** : Manually set the date.
 - [Set time]** : Manually set the time.
 - [Select time zone]** : Manually set the time zone.
 - [Use 24-hour format]** : Enter a tick to display the time in 24-hour format. Remove the tick for 12-hour format.
 - [Choose date format]** : Choose a format for displaying the date.

Main Specifications

Display	Approx. 4.5 inches Approx. 16,770,000 colours 1,280 × 720 pixels (HD)	
Weight	Approx. 182 g	
Size (W × H × D)	Approx. 68 mm × 136 mm × 13.5 mm Approx. 15.4 mm at thickest point	
Internal memory capacity*1	ROM: Approx. 16 GB RAM: Approx. 2 GB	
Effective pixels in rear-facing camera	Approx. 8,000,000 pixels	
Effective pixels in front-facing camera	Approx. 2,000,000 pixels	
Wi-Fi Function	IEEE802.11a/b/g/n/ac compatible	
Bluetooth Function	Version	Bluetooth standard Ver. 4.0 compatible*2
	Output	Bluetooth standard Class 1
	Frequency bands	2.4 GHz band

*1 Because data and applications are saved in a shared region, the internal saving capacity shrinks with how much your use applications.

*2 All of the Bluetooth equipment built into the product is confirmed and certified as being compliant with the Bluetooth standards put in place by Bluetooth SIG. However, depending

on the characteristics and specifications of the connected device, the operation method may be different, or it may not be possible to send and receive data over the connection.

Specific Absorption Rate of Mobile Phone

This model KC-S701 mobile phone complies with Japanese technical regulations and international guidelines regarding exposure to radio waves. This mobile phone has been designed in observance of the Japanese technical regulations regarding exposure to radio waves* and limits to exposure to radio waves recommended by equivalent international guidelines.

These international guidelines were set out by the International Commission on Non-Ionizing Radiation Protection (ICNIRP), which is in collaboration with the World Health Organization (WHO), and the permissible limits include a substantial safety margin designed to assure the safety of all persons, regardless of age and health condition. The Japanese technical regulations and international guidelines define the limits using a unit of measurement known as the Specific Absorption Rate (SAR),

which represents the average amount of radio frequency energy absorbed by the human. The SAR limit for mobile phones is 2.0 W/kg. The highest SAR value for this mobile phone when tested for use at the ear is 0.490 W/kg. The highest SAR value for this mobile phone when tested for use on the body is 0.381 W/kg. The actual SAR of this mobile phone while talking on the phone can be well below that indicated above. This is due to automatic changes in the power level of the mobile phone to ensure it only outputs the minimum power required to communicate with a base station.

Therefore in general, the closer you are to a base station, the lower the power output of the mobile phone.

This mobile phone can be used in positions other than against your ear. Use an accessory such as a carrying case, etc. so that you can hold the product at least 1.5 cm away from your body and also do not contain metal parts between the product and your body. By doing this, this mobile phone complies with Japanese technical regulations and international guidelines regarding exposure to radio waves. The World Health Organization has stated that present scientific information does not

indicate the use of mobile devices has any harmful effects on the human body. They recommend that if you are still worried about your exposure then you can limit your talk time or use a handsfree kit to keep the mobile phone away from your head and body. If you would like to know more detailed information, please refer to the WHO website.

http://www.who.int/docstore/peh-emf/publications/facts_press/fact_english.htm

Please refer to the websites listed below if you would like to know more detailed information regarding SAR.

- Ministry of Internal Affairs and Communications website
<http://www.tele.soumu.go.jp/j/e/index.htm>
- Association of Radio Industries and Businesses website
<http://www.arib-emf.org/index02.html>
(in Japanese only)
 - * Technical regulations are defined by the Ministerial Ordinance Related to Radio Law (Article 14-2 of Radio Equipment Regulations).

OpenSSL License

[OpenSSL License]

Copyright © 1998-2011 The OpenSSL Project. All rights reserved.

This product includes software developed by the OpenSSL Project for use in the OpenSSL Toolkit. (<http://www.openssl.org/>)

THIS SOFTWARE IS PROVIDED BY THE OpenSSL PROJECT "AS IS" AND ANY EXPRESSED OR IMPLIED WARRANTIES, INCLUDING, BUT NOT LIMITED TO, THE IMPLIED WARRANTIES OF MERCHANTABILITY AND FITNESS FOR A PARTICULAR PURPOSE ARE DISCLAIMED. IN NO EVENT SHALL THE OpenSSL PROJECT OR ITS CONTRIBUTORS BE LIABLE FOR ANY DIRECT, INDIRECT, INCIDENTAL, SPECIAL, EXEMPLARY, OR CONSEQUENTIAL DAMAGES (INCLUDING, BUT NOT LIMITED TO, PROCUREMENT OF SUBSTITUTE GOODS OR SERVICES; LOSS OF USE, DATA, OR PROFITS; OR BUSINESS INTERRUPTION) HOWEVER CAUSED AND ON ANY

THEORY OF LIABILITY, WHETHER IN CONTRACT, STRICT LIABILITY, OR TORT (INCLUDING NEGLIGENCE OR OTHERWISE) ARISING IN ANY WAY OUT OF THE USE OF THIS SOFTWARE, EVEN IF ADVISED OF THE POSSIBILITY OF SUCH DAMAGE.

[Original SSLeay License]
Copyright © 1995-1998 Eric Young (eay@cryptsoft.com) All rights reserved.

This product includes cryptographic software written by Eric Young (eay@cryptsoft.com)

THIS SOFTWARE IS PROVIDED BY ERIC YOUNG "AS IS" AND ANY EXPRESS OR IMPLIED WARRANTIES, INCLUDING, BUT NOT LIMITED TO, THE IMPLIED WARRANTIES OF MERCHANTABILITY AND FITNESS FOR A PARTICULAR PURPOSE ARE DISCLAIMED. IN NO EVENT SHALL THE AUTHOR OR CONTRIBUTORS BE LIABLE FOR ANY DIRECT, INDIRECT, INCIDENTAL, SPECIAL, EXEMPLARY, OR CONSEQUENTIAL DAMAGES (INCLUDING, BUT NOT LIMITED TO, PROCUREMENT OF SUBSTITUTE GOODS OR SERVICES; LOSS OF USE,

DATA, OR PROFITS; OR BUSINESS INTERRUPTION) HOWEVER CAUSED AND ON ANY THEORY OF LIABILITY, WHETHER IN CONTRACT, STRICT LIABILITY, OR TORT (INCLUDING NEGLIGENCE OR OTHERWISE) ARISING IN ANY WAY OUT OF THE USE OF THIS SOFTWARE, EVEN IF ADVISED OF THE POSSIBILITY OF SUCH DAMAGE.

FCC Notice

This device complies with part 15 of the FCC Rules. Operation is subject to the following two conditions:

- ① This device may not cause harmful interference, and
- ② This device must accept any interference received, including interference that may cause undesired operation.

Note:

This equipment has been tested and found to comply with the limits for a Class B digital device, pursuant to part 15 of the FCC Rules. These limits are designed to provide reasonable protection against harmful interference in a residential installation. This equipment generates,

uses, and can radiate radio frequency energy and, if not installed and used in accordance with the instructions, may cause harmful interference to radio communications.

However, there is no guarantee that interference will not occur in a particular installation. If this equipment does cause harmful interference to radio or television reception, which can be determined by turning the equipment off and on, the user is encouraged to try to correct the interference by one or more of the following measures:

- Reorient or relocate the receiving antenna.
- Increase the separation between the equipment and receiver.
- Connect the equipment into an outlet on a circuit different from that to which the receiver is connected.
- Consult the dealer or an experienced radio/TV technician for help and for additional suggestions.

Warning

The user is cautioned that changes or modifications not expressly approved by the manufacturer could void the user's authority to operate the equipment.



FCC RF EXPOSURE INFORMATION

Warning! Read this information before using your phone.

Warning! Read this information before using your phone. In August 1996, the Federal Communications Commission (FCC) of the United States, with its action in Report and Order FCC 96-326, adopted an updated safety standard for human to radio frequency electromagnetic energy emitted by FCC regulated transmitters. Those guidelines are consistent with the safety standard previously set by both U.S. and international standards bodies. The design of this phone complies with the FCC guidelines and these international standards.

Body-worn Operation

This device was tested for typical body-worn operations with the back of the phone kept 0.39 inches (1.0 cm) from the body. To comply with FCC RF exposure requirements, a minimum separation distance of 0.39 inches (1.0 cm) must be maintained between the user's body and the back of the phone, including the

antenna. All beltclips, holsters and similar accessories used by this device must not contain any metallic components. Body-worn accessories that do not meet these requirements may not comply with FCC RF exposure limits and should be avoided. This device is not intended to be used with a lanyard or strap on the body. The device contains a mounting point that may be used to attach the device to equipment, a backpack or tool belt, etc.

Turn off your phone before flying.

You should turn off your phone when boarding any aircraft. To prevent possible interference with aircraft systems, U.S. Federal Aviation Administration (FAA) regulations require you to have permission from a crew member to use your phone while the plane is on the ground. To prevent any risk of interference, FCC regulations prohibit using your phone while the plane is in the air.

European RF Exposure Information

Your mobile device is both a radio transmitter and receiver, and is designed not to exceed limits for exposure to radio waves recommended by international guidelines. These guidelines were produced by independent scientific organization, ICNIRP, and include safety margins designed to protect all persons, regardless of age and condition of health. The guidelines apply a unit of measurement known as the Specific Absorption Rate (SAR). The SAR limit for mobile devices is 2W/kg, and the highest SAR value for this device was 0.556 W/kg¹.

As testing measures SAR at the highest transmitting power of a device, actual SAR tends to be lower during ordinary operation. Lower SAR levels are typical during ordinary operation as automatic changes are made within the device to ensure the network can be reached with minimal power.

The World Health Organization (WHO) has stated that present scientific information does not indicate the need for any special precautions to be adopted when using mobile devices. WHO also

notes that those wishing to reduce exposure may do so by limiting call length and by using a 'hands-free' device to distance the phone from the head and body. For further information, please see the WHO website: <http://www.who.int/peh-emf/en/>

* Note that tests are also carried out in accordance with international testing guidelines.

Declaration of Conformity

Product is declared to conform with the essential requirements of European Union Directive 1999/5/EC Radio and Telecommunications Terminal Equipment Directive 3.1 (a), 3.1 (b) and 3.2.

-Note-

The following frequency bands are restricted to indoor use only:

5150 - 5250 MHz (802.11a/n/ac) in US
5150 - 5350 MHz (802.11a/n/ac) in EU

Safety Information

To prevent possible hearing damage, do not listen at high volume levels for long periods.



Intellectual Property Rights

Trademarks

© 2015 Kyocera Corporation. All rights reserved. KYOCERA is a registered trademark of Kyocera Corporation. All other trademarks are the property of their respective owners.

- Google and Google logo, Android and Android logo, Google Play and Google Play logo, Play Music and Play Music logo, Play Movies & TV and Play Movies & TV logo, Gmail and Gmail logo, Google Maps and Google Maps logo, Google Drive and Google Drive logo, Hangouts and Hangouts logo, Google+ and Google+ logo, Google Now and Google Now logo, Google Voice Search and Google Voice Search logo, Chrome and Chrome logo, and YouTube and YouTube logo are trademarks or registered trademarks of Google Inc.
- The microSD logo, microSDHC logo, and microSDXC logo are trademarks of SD-3C, LLC.



- The Bluetooth word mark and logos are registered trademarks owned by Bluetooth SIG, Inc., and any use of such marks by Kyocera Corporation is under license. Other trademarks and trade names are those of their respective owners.



- Wi-Fi, WPA, Wi-Fi CERTIFIED logo, and Wi-Fi Protected Setup logo are registered trademarks of Wi-Fi Alliance. Wi-Fi CERTIFIED and Wi-Fi Protected Setup are trademarks of Wi-Fi Alliance.



- The “Qi” symbol is a trademark of the Wireless Power Consortium.



- THIS PRODUCT IS LICENSED UNDER THE MPEG-4 VISUAL PATENT PORTFOLIO LICENSE FOR THE PERSONAL AND NON-COMMERCIAL USE OF A CONSUMER FOR (i) ENCODING VIDEO IN COMPLIANCE WITH THE MPEG-4 VISUAL STANDARD (“MPEG-4 VIDEO”) AND/OR (ii) DECODING MPEG-4 VIDEO THAT WAS ENCODED BY A CONSUMER ENGAGED IN A

PERSONAL AND NONCOMMERCIAL ACTIVITY AND/OR WAS OBTAINED FROM A VIDEO PROVIDER LICENSED BY MPEG LA TO PROVIDE MPEG-4 VIDEO. NO LICENSE IS GRANTED OR SHALL BE IMPLIED FOR ANY OTHER USE. ADDITIONAL INFORMATION INCLUDING THAT RELATING TO PROMOTIONAL, INTERNAL AND COMMERCIAL USES AND LICENSING MAY BE OBTAINED FROM MPEG LA, LLC. SEE [HTTP://WWW.MPEGLA.COM](http://www.mpegla.com).

- ① ACCESS, the ACCESS logo, and NetFront are registered trademarks or trademarks of ACCESS CO., LTD. in the United States, Japan and/or other countries.
- ② This software is based in part on the work of the Independent JPEG Group.
- **N** is a trademark or registered trademark of NFC Forum, Inc. in the United States and other countries.
- “SMART SONIC RECEIVER” is a registered trademark of KYOCERA Corporation.
- “PhotoSolid”, the image stabilization technology, is a product of Morpho, Inc. “PhotoSolid” is a registered trademark of Morpho, Inc.
- “MovieSolid”, the motion video stabilizing technology, is a product of Morpho, Inc. “MovieSolid” is a registered trademark of Morpho, Inc.
- “Morpho Defocus”, the background defocus generation technology, is a product of Morpho, Inc. “Morpho Defocus” is a trademark of Morpho, Inc.
- “Morpho Effect Library”, the visual effect technology, is a product of Morpho, Inc. “Morpho Effect Library” is a trademark of Morpho, Inc.
- “Morpho HDR”, the high dynamic range technology, is a product of Morpho, Inc. “Morpho HDR” is a trademark of Morpho, Inc.
- “QuickPanorama”, the panoramic image generation technology, is a product of Morpho, Inc. “QuickPanorama” is a registered trademark of Morpho, Inc.
- “TrackSolid”, the automatic object tracking technology, is a product of Morpho, Inc. “TrackSolid” is a registered trademark of Morpho, Inc.
- All other company names and product names are trademarks or registered trademarks of the respective companies referred to in this manual. Still, TM and the © mark do not appear in this text.

- Users of the product are authorized to use software installed on this product as described in this instruction manual. Pay attention to the following points when using the software.

- ① The software installed on this product or part of it may not be altered, delivered, modified, analysed, reverse-engineered, or derived, and any such actions are prohibited.
- ② Illegally exporting the software or a part of it is prohibited.
- ③ This Software is provided without implied warranties of merchantability, fitness for a particular purpose, and noninfringement of third party rights.

Note that the existing license agreement takes priority for usage of GNU General Public License (GPL), GNU Library/ Lesser General Public License (LGPL) included in software, software based on other open source software license, and software that KYOCERA Corporation is licensed.

For information on the open source software, see the following “Open Source Software” section.

Open Source Software

This product includes software that falls under the conditions of the GNU General Public License (GPL), GNU Library/ Lesser General Public License (LGPL), and other open source software licenses. For more information on the specific conditions of the GPL, LGPL, and other licenses, refer to the “About phone” section of the settings menu on the product. For details, refer to the KYOCERA Corporation website. This product incorporates software copyrighted to the KYOCERA Corporation and software for which KYOCERA holds a license. The KYOCERA Corporation designed this product to comply with the open source software standards and license. The software that was developed belongs to the KYOCERA Corporation and relevant third parties. With the exception of usage that is allowed by Copyright Law and that which the KYOCERA Corporation has specially granted, you cannot distribute, copy, modify, publicly transmit, etc. this software without permission from the KYOCERA Corporation.

