



Zacta

TEST REPORT

Report number : Z101C-14086

Issue date : October 17, 2014

The device, as described herewith, was tested pursuant to applicable test procedure and complies with the requirements of;

FCC Part 22 Subpart H

The test results are traceable to the international or national standards.

Applicant	: KYOCERA Corporation
Equipment under test (EUT)	: Mobile Phone
Model number	: KC-01
FCC ID	: JOYKC-01

Date of test : September 2, October 8, 9, 14, 2014
 Test place : TÜV SÜD Zacta Ltd. Yonezawa Testing Center
 4149-7 Hachimanpara 5-chome
 Yonezawa-shi Yamagata 992-1128 Japan
 Phone: +81-238-28-2880 Fax: +81-238-28-2888
 Test results : Complied

The results in this report are applicable only to the equipment tested.
 This report shall not be re-produced except in full without the written approval of TÜV SÜD Zacta Ltd.
 This test report must not be used by client to claim product certification, approval, or endorsement by NVLAP, NIST, or any agency of the federal government.

Tested by :

Chiaki Kanno *Taiki Watanabe*
 Chiaki Kanno Taiki Watanabe

Authorized by :

Eiji Akiba
 Eiji Akiba
 Deputy General Manager of EMC Technical Department

NVLAP[®]
 NVLAP LAB CODE 200306-0

Table of contents

	Page
1. Summary of Test	3
1.1 Purpose of test	3
1.2 Standards	3
1.3 List of applied test to the EUT	3
1.4 Modification to the EUT by laboratory	3
2. Equipment Under Test	4
2.1 General Description of equipment	4
2.2 EUT information	4
2.3 Variation of the family model(s)	5
2.4 Description of Test mode	5
3. Configuration of equipment	6
3.1 Equipment(s) used	6
3.2 System configuration	6
4. Conducted Output Power	7
4.1 Measurement procedure	7
4.2 Measurement result	7
5. Effective Radiated Power	8
5.1 Measurement procedure	8
5.2 Calculation method	8
5.3 Limit	8
5.4 Test data	9
6. Occupied Bandwidth	10
6.1 Measurement procedure	10
6.2 Limit	10
6.3 Measurement result	10
6.4 Trace data	11
7. Band Edge Spurious and Harmonic at Antenna Terminals	13
7.1 Measurement procedure	13
7.2 Limit	13
7.3 Measurement result	13
7.4 Trace data	14
8. Radiated Emissions and Harmonic Emissions	23
8.1 Measurement procedure	23
8.2 Calculation method	23
8.3 Limit	23
8.4 Test data	24
9. Frequency Stability	26
9.1 Measurement procedure	26
9.2 Limit	26
9.3 Measurement result	27
10. Uncertainty of measurement	28
11. Laboratory description	29
Appendix A. Test equipment	30

1. Summary of Test

1.1 Purpose of test

It is the original test in order to verify conformance to FCC Part 22 Subpart H.

1.2 Standards

CFR47 FCC Part 22 Subpart H

1.2.1 Test Methods

ANSI/TIA/EIA-603-C-2004

1.2.2 Deviation from standards

None

1.3 List of applied test to the EUT

Test items Section	Test items	Condition	Result
2.1046	Conducted Output Power	Conducted	PASS
22.913(a)	Effective Radiated Power	Radiated	PASS
22.917(a) 2.1049	Occupied Bandwidth	Conducted	PASS
22.917(a) 2.1051	Band Edge Spurious and Harmonic at Antenna Terminal	Conducted	PASS
22.917(a) 2.1053	Radiated emissions and Harmonic Emissions	Radiated	PASS
22.355 2.1055	Frequency Stability	Conducted	PASS

1.3.1 Test set up

Table-Top

1.4 Modification to the EUT by laboratory

None



Zacta

2. Equipment Under Test

2.1 General Description of equipment

EUT is the Mobile Phone.

2.2 EUT information

Applicant	:	KYOCERA Corporation Yokohama Office 2-1-1 Kagahara, Tsuzuki-ku Yokohama-shi, Kanagawa, Japan Phone: +81-45-943-6253 Fax: +81-45-943-6314
Equipment under test	:	Mobile Phone
Trade name	:	Kyocera
Model number	:	KC-01
Serial number	:	N/A
EUT condition	:	Pre-Production
Power ratings	:	Battery: DC 3.8V
Size	:	(W) 64 × (D) 11.1 × (H) 127.0 mm
Environment	:	Indoor and Outdoor use
Terminal limitation	:	-20°C to 60°C
RF Specification Frequency of Operation	:	Up Link GSM850: 824.2-848.8MHz WCDMA Band V: 826.4-846.6MHz
		Down Link GSM850: 869.20-893.8MHz WCDMA Band V: 871.4-891.6MHz
Modulation type	:	GSM850: GMSK WCDMA Band V: QPSK, 16QAM
Emission designator	:	GSM850: 246KGXW WCDMA Band V: 4M15F9W
Output power	:	GSM850: 1.479W ERP (31.7dBm) WCDMA Band V: 0.081W ERP (19.1dBm)
Antenna type	:	Internal antenna
Antenna gain	:	GSM850: -1.6dBi WCDMA Band V: -1.6dBi

2.3 Variation of the family model(s)

Not applicable

2.4 Description of Test mode

The EUT had been tested under operating condition.
There are three channels have been tested as following:

Band	Channel	Frequency
GSM850	128	824.2MHz
	190	836.6MHz
	251	848.8MHz
WCDMA Band V	4132	826.4MHz
	4183	836.6MHz
	4233	846.6MHz

The field strength of spurious emissions was measured at each position of all three axis X, Y and Z to compare the level, and the maximum noise.
The worst emission was found in Z axis and the worst case recorded.



Zacta

3. Configuration of equipment

3.1 Equipment(s) used

No.	Equipment	Company	Model No.	Serial No.	FCC ID / DoC	Comment
1	Mobile Phone	KYOCERA	KC-01	N/A	JOYKC-01	EUT

3.2 System configuration

1. Mobile Phone
(EUT)

Note1: Numbers assigned to equipment on this diagram correspond to the list in "3.1 Equipment(s) used".

4. Conducted Output Power

4.1 Measurement procedure [FCC 2.1046]

The conducted output power was measured with a wireless communication tester connected to the antenna terminal. The wireless communication tester parameters were set to produce the maximum power from the EUT.

- Test configuration

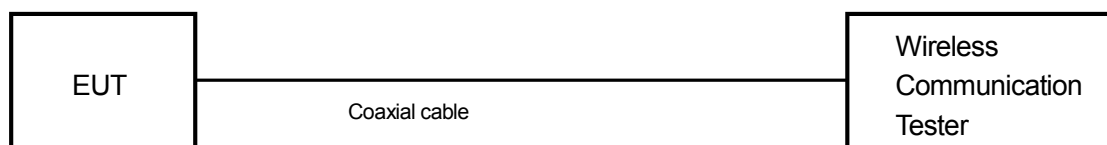

4.2 Measurement result

Date : Sep. 2, 2014
 Temperature : 23.0 [°C]
 Humidity : 54.0 [%]
 Test place : Shielded room No.4

Test engineer : Chiaki Kanno

Band	Channel	Frequency [MHz]	Maximum Burst-Averaged Output Power [dBm]								
			Voice GSM CS 1slot	GPRS/EDGE(GMSK)Data				EDGE(8-PSK)Data			
				GPRS 1 TX Slot	GPRS 2 TX Slot	GPRS 3 TX Slot	GPRS 4 TX Slot	EDGE 1 TX Slot	EDGE 2 TX Slot	EDGE 3 TX Slot	EDGE 4 TX Slot
GSM 850	128	824.2	33.37	33.37	32.24	30.11	28.79	N/A	N/A	N/A	N/A
	190	836.6	33.32	33.21	32.09	30.02	28.97	N/A	N/A	N/A	N/A
	251	848.8	33.27	33.18	32.16	30.21	28.96	N/A	N/A	N/A	N/A

3GPP Release Version	Mode		Sub-Test	Cellular Band [dBm]			MPR	Bc	fd	Bc/fd
	Channel			4132	4183	4233				
	Frequency [MHz]			826.4	836.6	846.6				
99	W-CDMA	RMC	-	24.11	24.45	24.23	-	-	-	-
		AMR	-	23.93	24.37	24.17	-	-	-	-
5	HSDPA		1	23.01	23.36	23.09	0	2/15	15/15	2/15
5			2	21.62	21.96	21.86	0	12/15	15/15	12/15
5			3	20.67	21.01	20.81	0.5	15/15	8/15	15/8
5			4	20.56	20.89	20.71	0.5	15/15	4/15	15/4
6	HSUPA		1	22.20	22.68	22.38	0	11/15	15/15	11/15
6			2	21.21	21.61	21.49	2	6/15	15/15	6/15
6			3	21.70	21.79	21.65	1	15/15	9/15	15/9
6			4	21.73	22.07	22.37	2	2/15	15/15	2/15
6			5	22.99	23.09	22.83	0	15/15	15/15	15/15

5. Effective Radiated Power

5.1 Measurement procedure [FCC 22.913(a)]

<Step 1>

The EUT and support equipment are placed on a 1 meter x 1.5 meter surface, 0.8 meter height FRP table. Radiated emission measurements are performed at 3 meter distance with the broadband antenna (double ridged guide antenna). The antenna is positioned both the horizontal and vertical planes of polarization and height is varied 1 to 4 meters and stopped at height producing the maximum emission. The bandwidth of the spectrum analyzer is set to 1MHz. The turntable is rotated by 360 degrees and stopped at azimuth of producing the maximum emission.

<Step 2>

The substitution antenna is replaced by the transmitter antenna (EUT). The frequency of the signal generator is adjusted to the measurement frequency. Level of the signal generator is adjusted to the level that is obtained from step 1, and record the emission level of signal generator.

Spectrum analyzer setting

- Detector: Peak (RBW: 3MHz, VBW: 8MHz): GSM
- Detector: Peak (RBW: 5MHz, VBW: 8MHz): WCDMA

- Test configuration

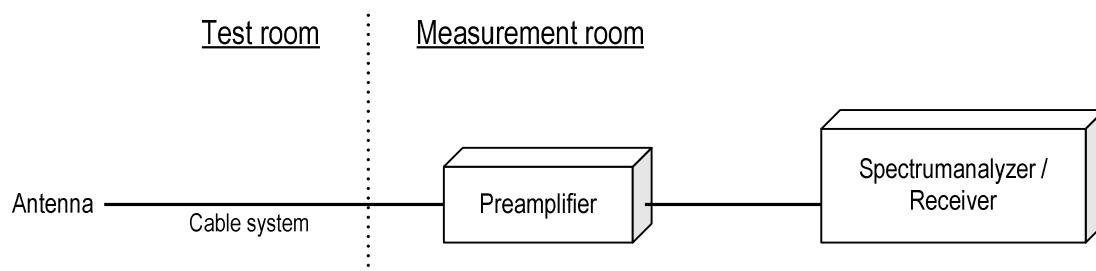

5.2 Calculation method

Result (ERP) = S.G Reading – Cable loss + Antenna Gain
Margin = Limit – Result (ERP)

5.3 Limit

7 W (38.45dBm)



Zacta

5.4 Test data

Date : Oct. 14, 2014 Test personnel :
 Temperature : 24.9 [°C]
 Humidity : 58.4 [%] Tested by :
 Test place : 3m Semi-anechoic chamber Taiki Watanabe

[GSM850]

H/V	Frequency [MHz]	S.A Reading [dBm]	S.G Reading [dBm]	Cable loss [dB]	Ant.Gain [dBd]	Result [dBm]	Limit [dBm]	Margin [dB]
H	824.2	24.0	43.0	0.7	-10.7	31.7	38.4	6.7
H	836.6	22.9	41.5	0.7	-10.7	30.1	38.4	8.3
H	848.8	22.4	41.7	0.7	-10.7	30.3	38.4	8.1

[WCDMA Band V]

H/V	Frequency [MHz]	S.A Reading [dBm]	S.G Reading [dBm]	Cable loss [dB]	Ant.Gain [dBd]	Result [dBm]	Limit [dBm]	Margin [dB]
H	826.4	14.7	28.5	0.7	-10.7	17.1	38.4	21.3
H	836.6	15.2	30.2	0.7	-10.7	18.8	38.4	19.6
H	846.6	15.2	30.5	0.7	-10.7	19.1	38.4	19.3

6. Occupied Bandwidth

6.1 Measurement procedure [FCC 22.917(a), 2.1049]

The Occupied bandwidth was measured with a spectrum analyzer connected to the antenna terminal.

The spectrum analyzer is set to;

- RBW=3kHz, VBW=9.1kHz, Span=1MHz, Sweep=auto, Detector=Peak, Trace mode=Max hold
- RBW=51kHz, VBW=150kHz, Span=10MHz, Sweep=auto, Detector=Peak, Trace mode=Max hold

- Test configuration

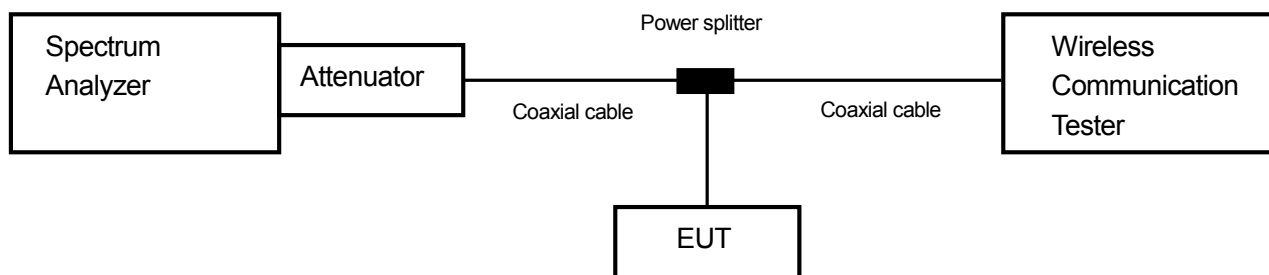

6.2 Limit

None

6.3 Measurement result

Date : Oct. 9, 2014

Temperature : 26.6 [°C]

Humidity : 45.6 [%]

Test place : Shielded room No.4

Test engineer :

Taiki Watanabe

Band	Channel	Frequency (MHz)	Test Result (kHz)
GSM850	128	824.2	242.9832
	190	836.6	242.9671
	251	848.8	245.5713

Band	Channel	Frequency (MHz)	Test Result (MHz)
W-CDMA850	4132	826.4	4.1544
	4183	836.6	4.1440
	4233	846.6	4.1465



Zacta

6.4 Trace data
[GSM850]

Channel: 128

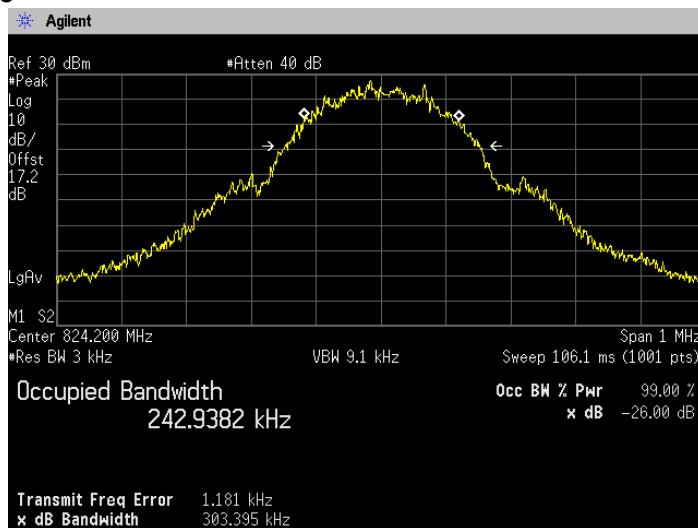

Channel: 190

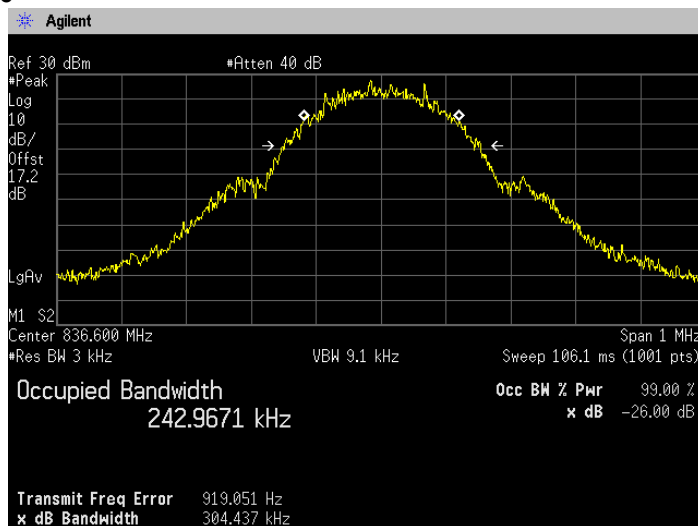

Channel: 251

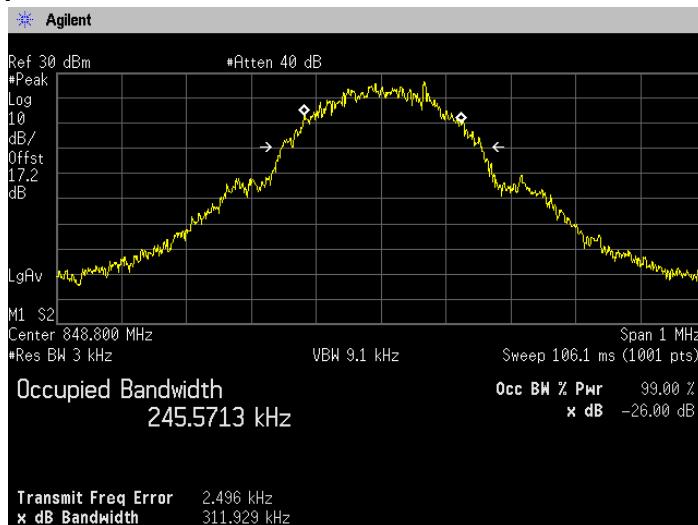



Zacta

**[WCDMA Band V]
Channel: 4132**

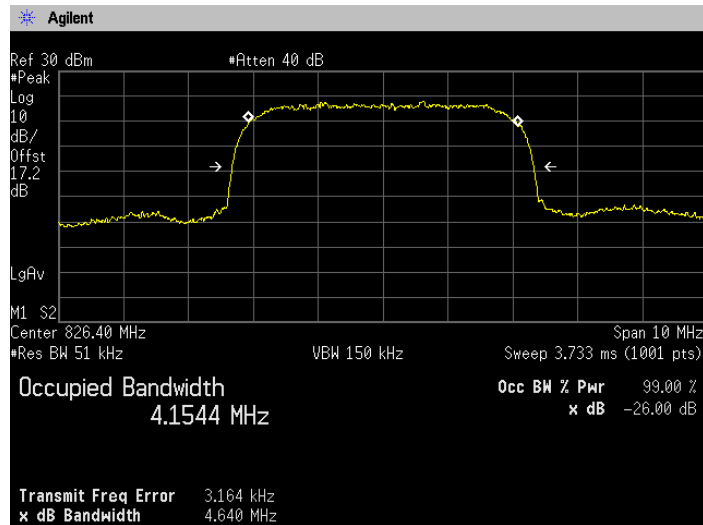

Channel: 4183

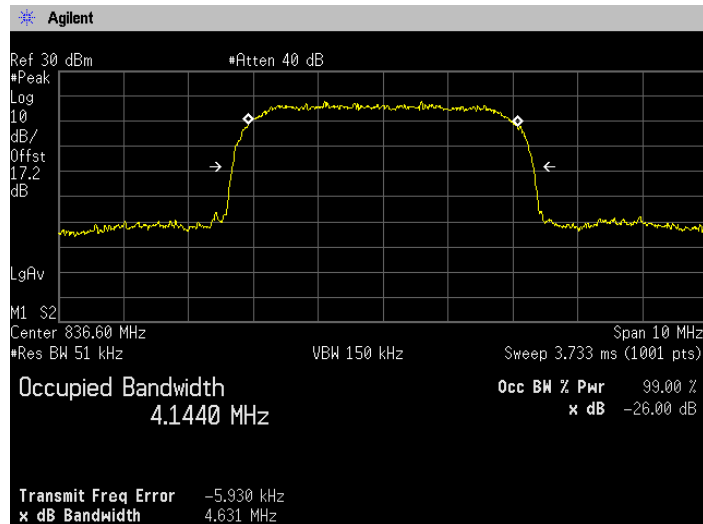

Channel: 4233

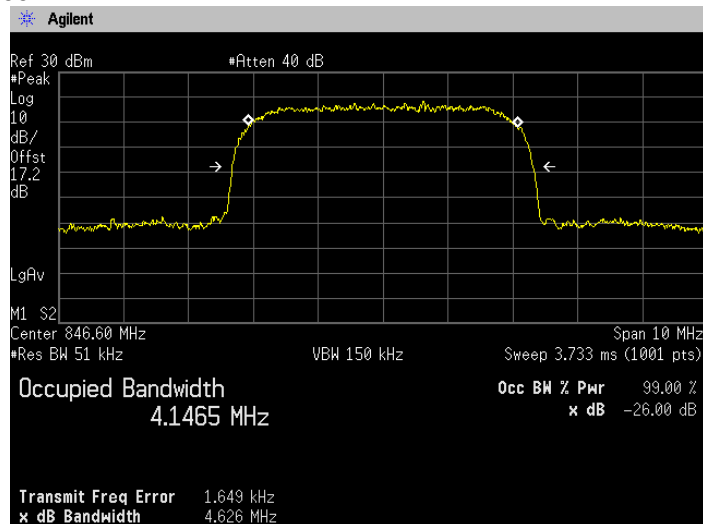

7. Band Edge Spurious and Harmonic at Antenna Terminals

7.1 Measurement procedure [FCC 22.917(a), 2.1051]

The band edge spurious and harmonic was measured with a spectrum analyzer connected to the antenna terminal.

The spectrum analyzer is set to;

<Band Edge>

- RBW=3kHz, 51kHz, VBW=9.1kHz, 150kHz, Span=1MHz, 10MHz, Sweep=auto, Detector=Average, Trace mode=Max hold

<Spurious Emissions>

- RBW=1MHz, VBW=3MHz, Span=Arbitrary setting, Sweep=auto, Detector=Peak, Trace mode=Max hold

- Test configuration

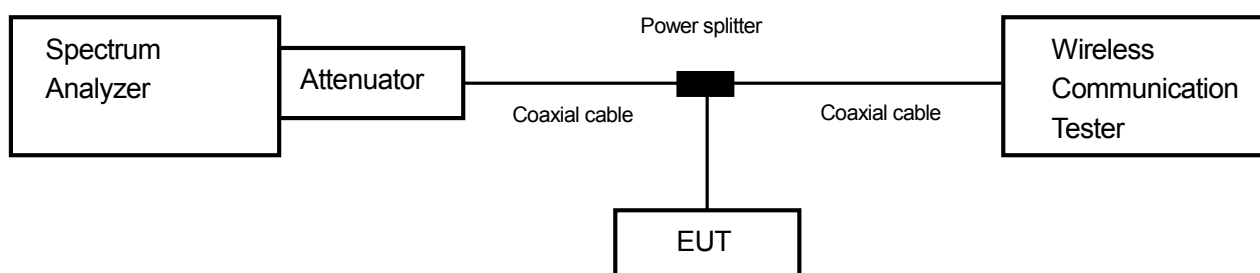

7.2 Limit

-13dBm or less

7.3 Measurement result

Date : Oct. 9, 2014

Temperature : 26.6 [°C]

Humidity : 45.6 [%]

Test place : Shielded room No.4

Test engineer :

Taiki Watanabe

Band	Channel	Frequency [MHz]	Limit [dB]	Results	Results
GSM850	128	824.2	-13	See the trace data	PASS
	190	836.6	-13	See the trace data	PASS
	251	848.8	-13	See the trace data	PASS
WCDMA Band V	4132	826.4	-13	See the trace data	PASS
	4183	836.6	-13	See the trace data	PASS
	4233	846.6	-13	See the trace data	PASS



Zacta

**7.4 Trace data
[GSM850]
(Band Edge)**

Channel: 128

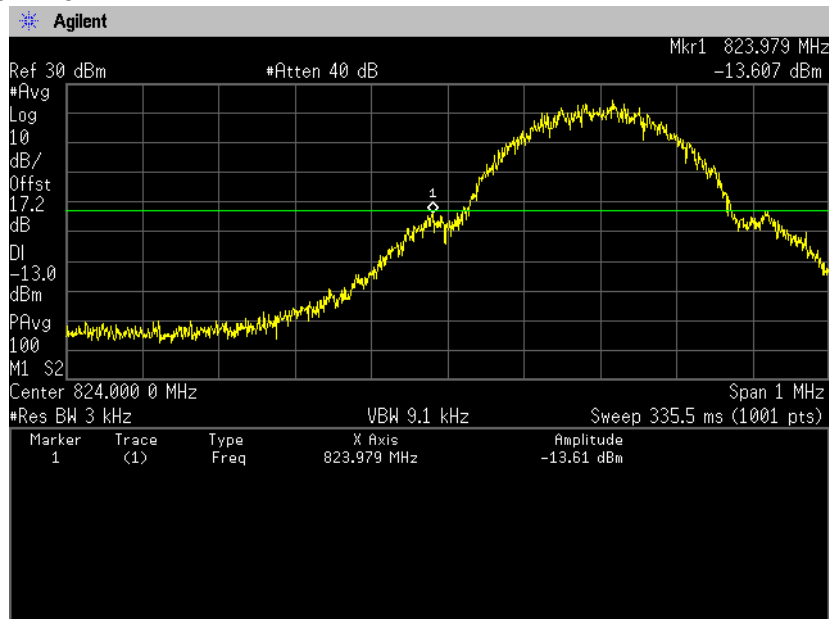

Channel: 251

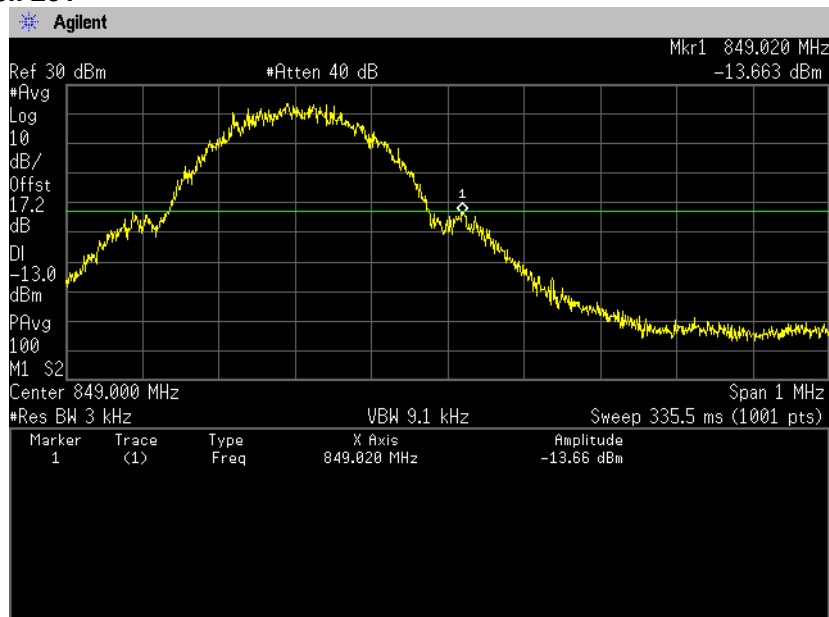



Zacta

(Spurious Emissions)
Channel: 128
30MHz-5GHz

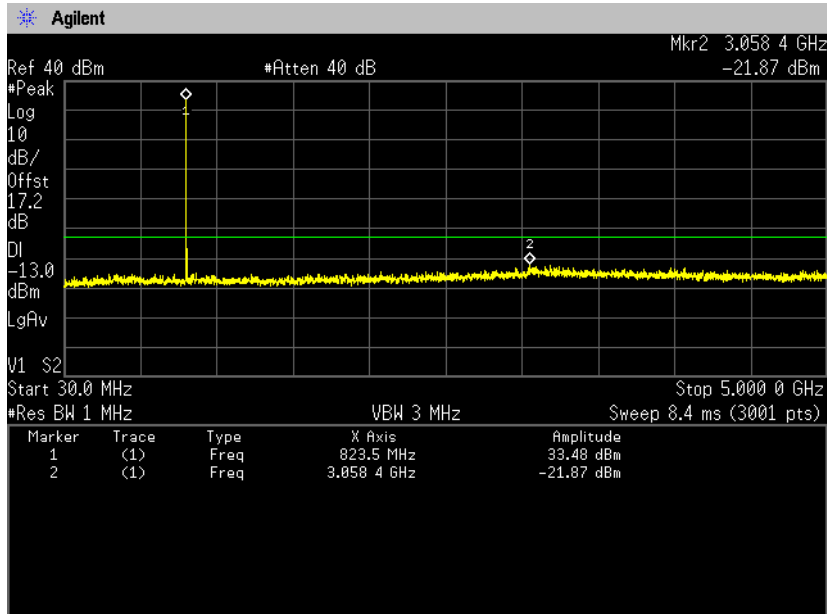

5GHz-10GHz

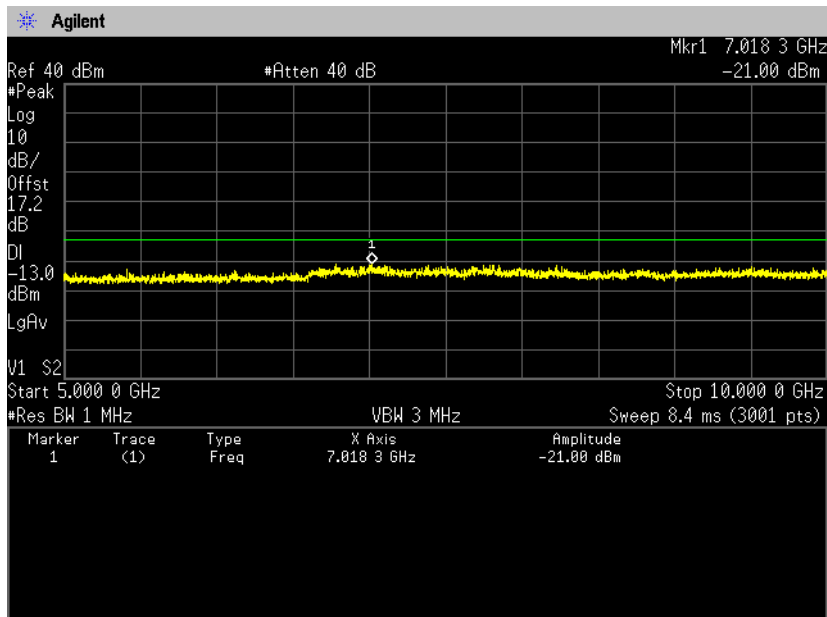



Zacta

**Channel: 190
30MHz-5GHz**

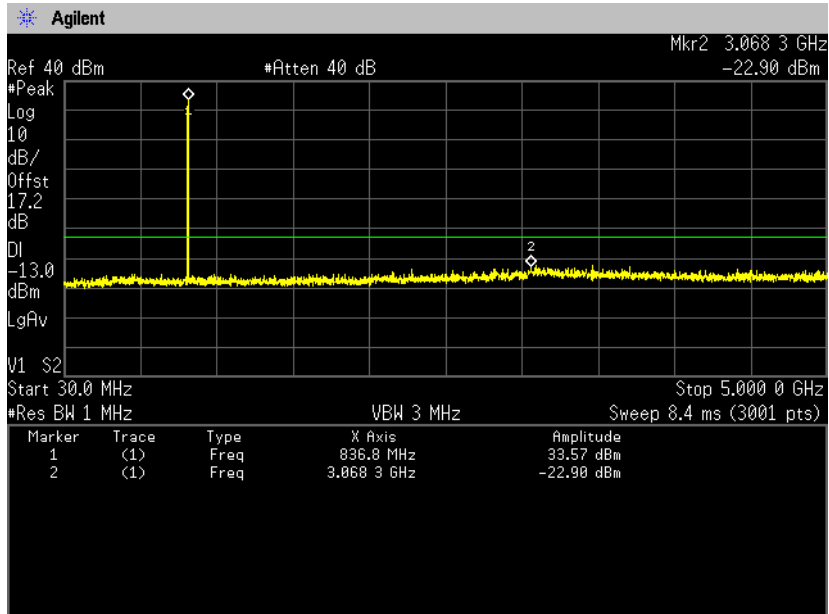

5GHz-10GHz

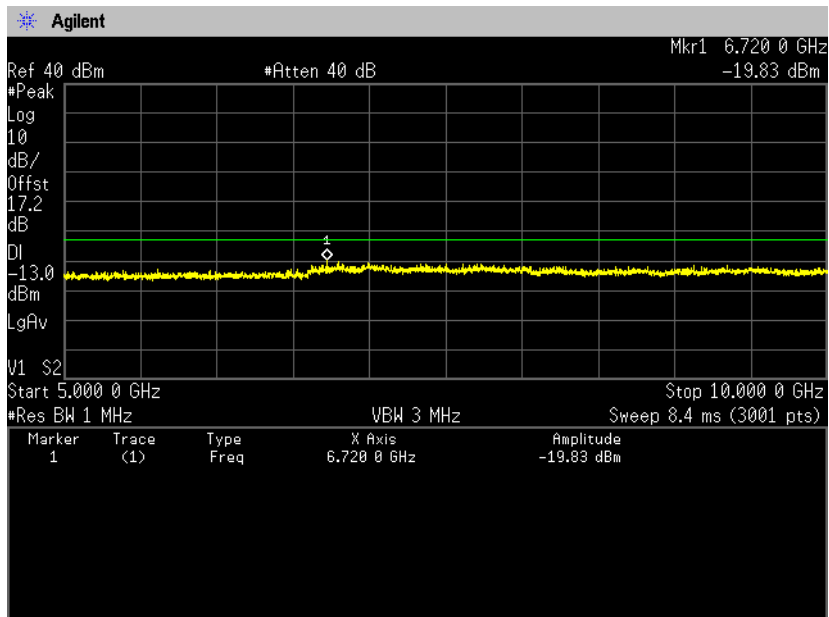



Zacta

**Channel: 251
30MHz-5GHz**

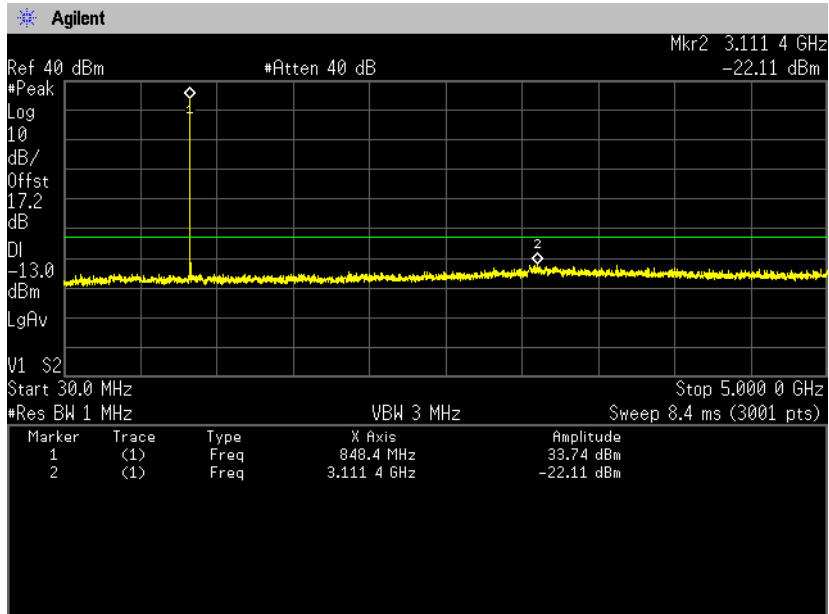

5GHz-10GHz

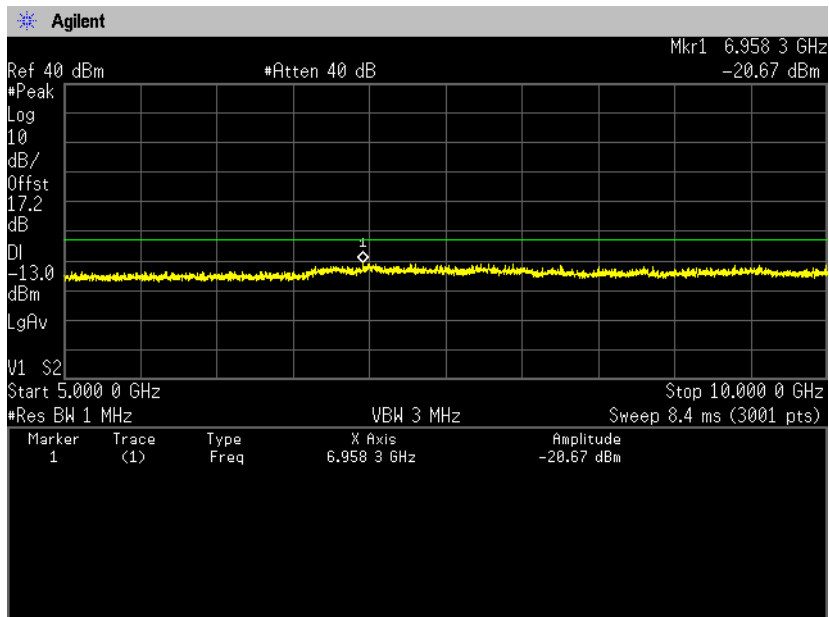



Zacta

**[WCDMA Band V]
(Band Edge)
Channel: 4132**

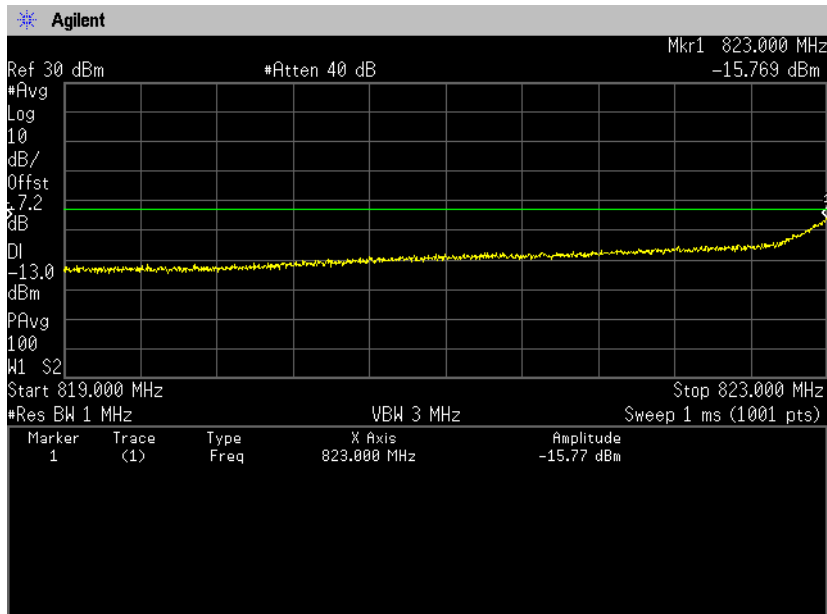
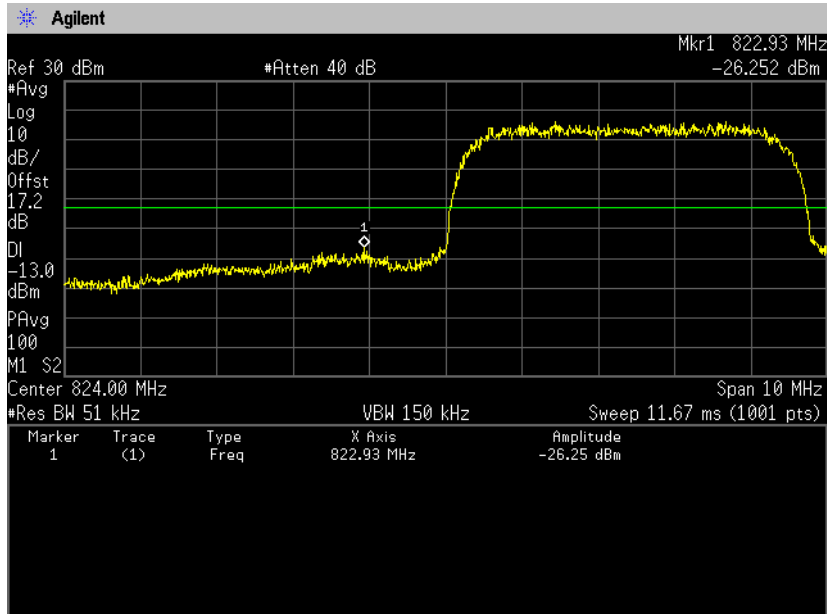



Zacta

Channel: 4233

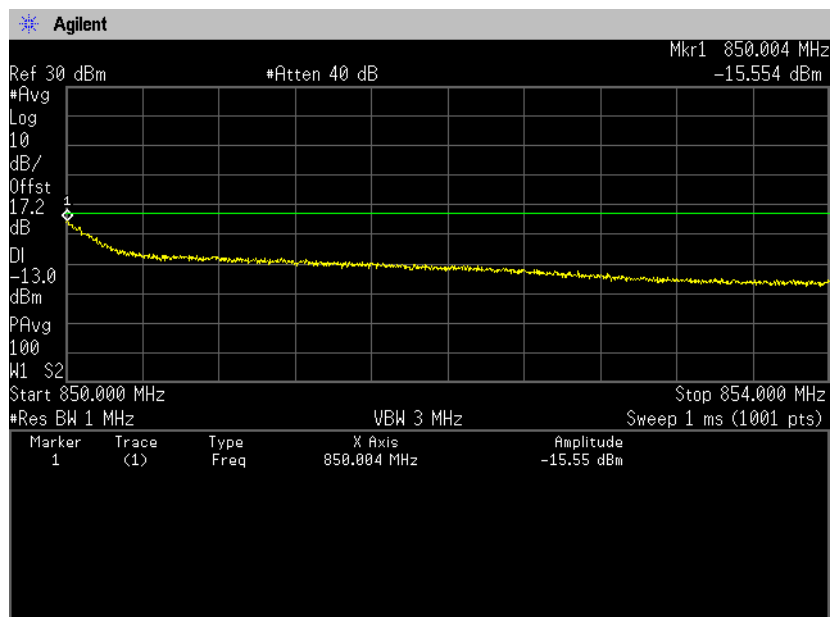
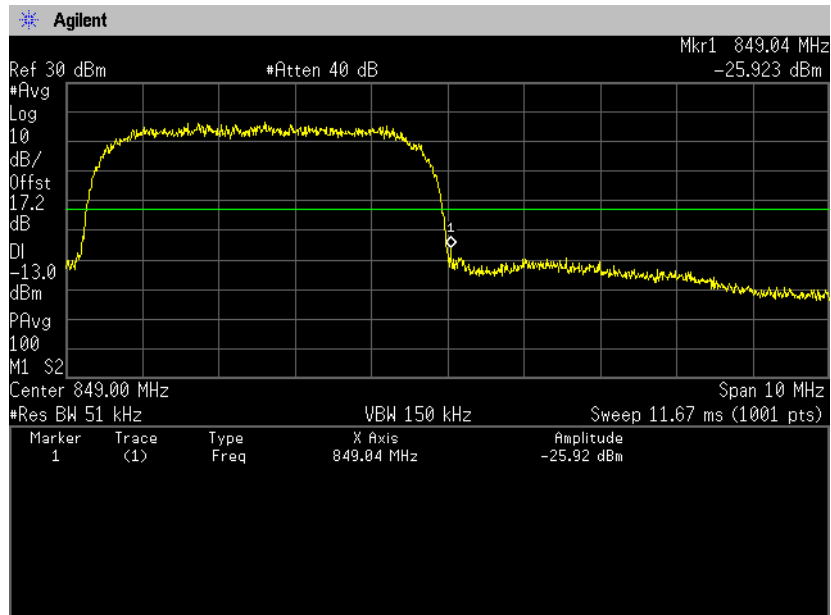



Zacta

(Spurious Emissions)
Channel: 4132
30MHz-5GHz

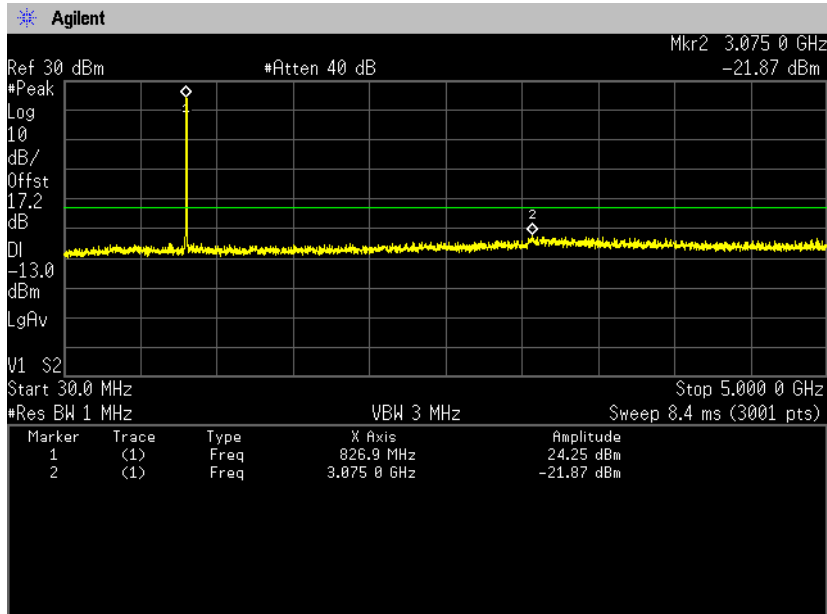

5GHz-10GHz

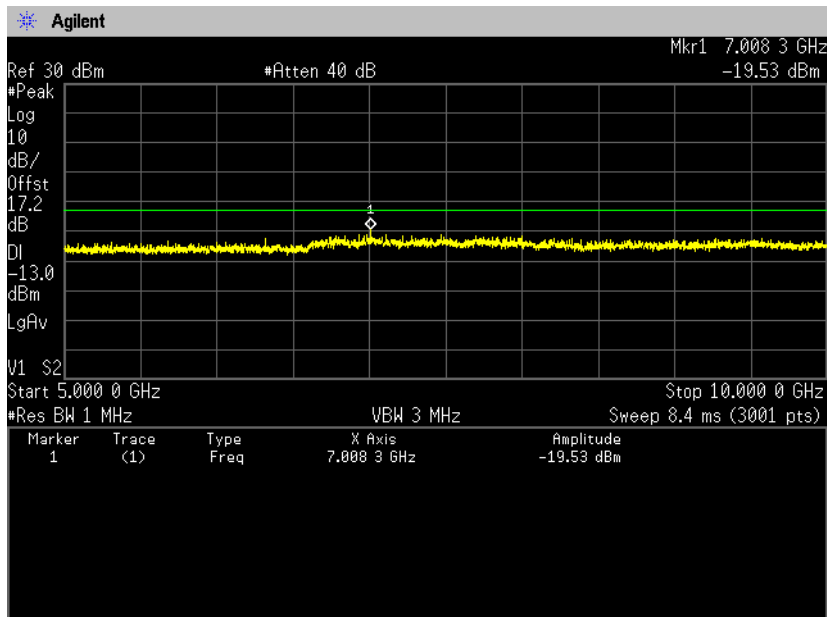



Zacta

**Channel: 4183
30MHz-5GHz**

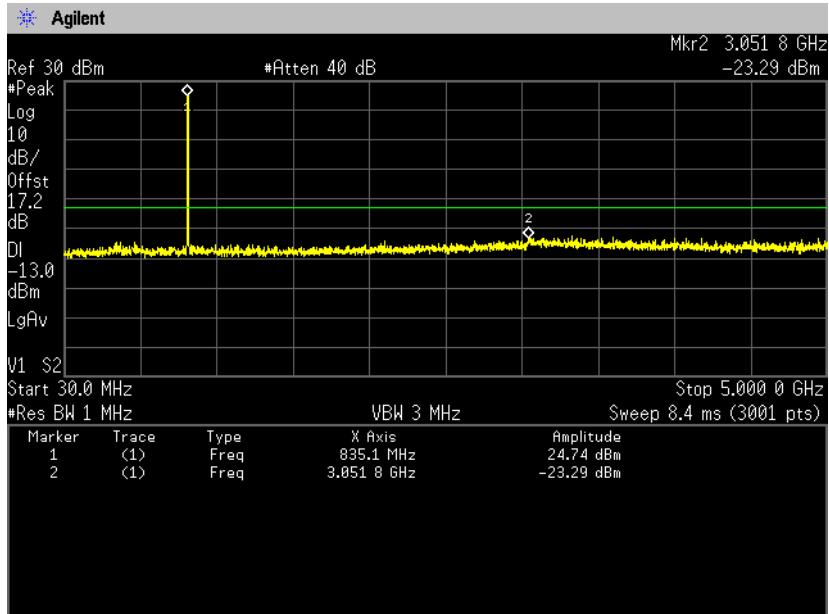

5GHz-10GHz

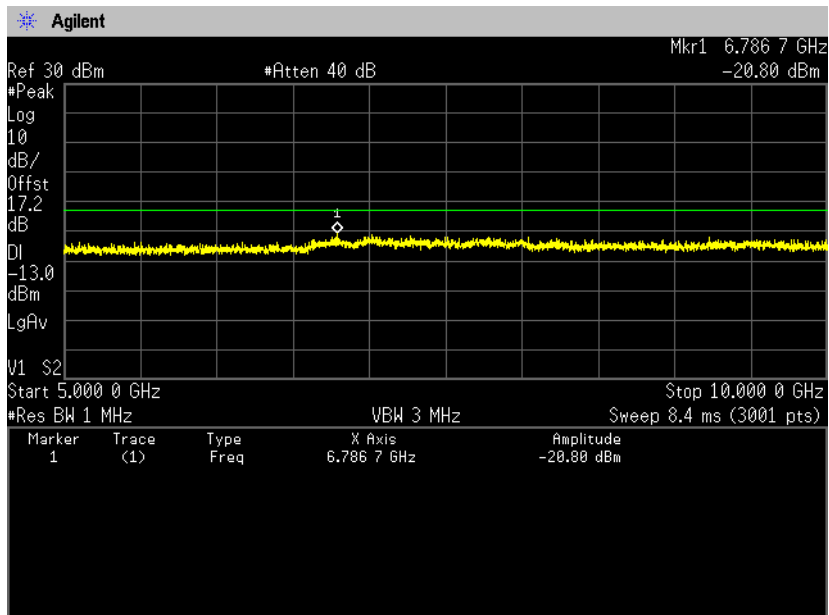



Zacta

**Channel: 4233
30MHz-5GHz**

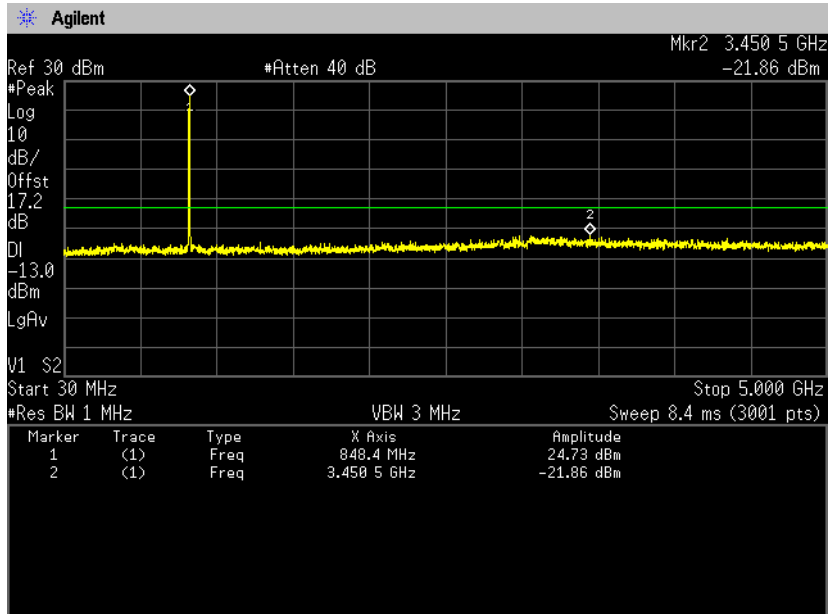

5GHz-10GHz

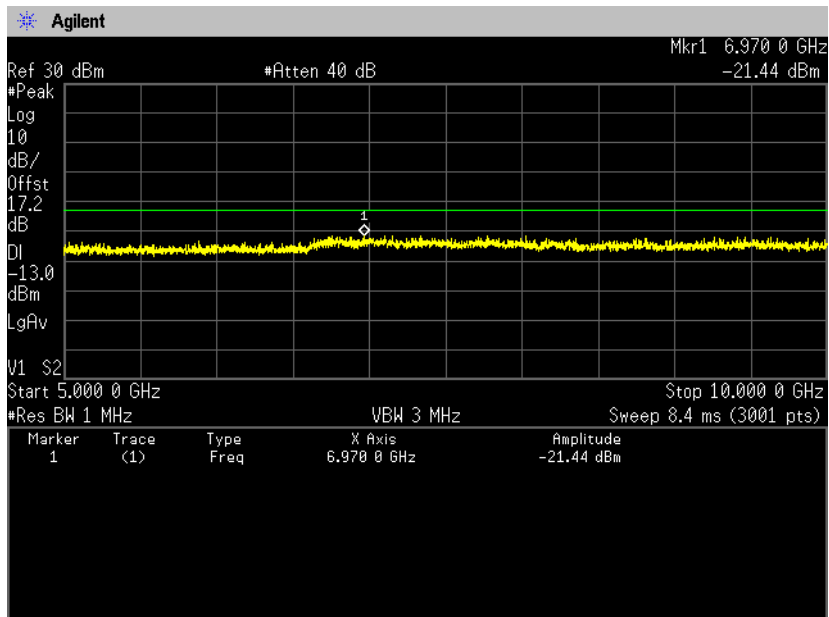

8. Radiated Emissions and Harmonic Emissions

8.1 Measurement procedure [FCC 22.917(a), 2.1053]

<Step 1>

The EUT and support equipment are placed on a 1 meter x 1.5 meter surface, 0.8 meter height FRP table. Radiated emission measurements are performed at 3 meter distance with the broadband antenna (Biconical antenna, Log periodic antenna and double ridged guide antenna). The antenna is positioned both the horizontal and vertical planes of polarization and height is varied 1 to 4 meters and stopped at height producing the maximum emission.

The bandwidth of the spectrum analyzer is set to 1MHz. The turntable is rotated by 360 degrees and stopped at azimuth of producing the maximum emission. The frequency is investigated up to 20GHz.

<Step 2>

The substitution antenna is replaced by the transmitter antenna (EUT).

The frequency of the signal generator is adjusted to the measurement frequency.

Level of the signal generator is adjusted to the level that is obtained from step 1, and record the emission level of signal generator.

Spectrum analyzer setting

- Detector: Peak (RBW: 1MHz, VBW: 3MHz)

- Test configuration

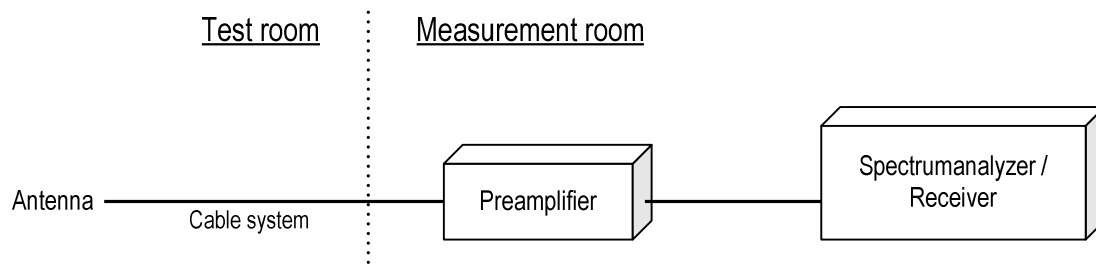

8.2 Calculation method

Result = S.G Reading – Cable loss + Antenna Gain

Margin = Limit – Result (ERP)

8.3 Limit

-13dBm or less

8.4 Test data

Date : Oct. 2, 2014 Test personnel :
 Temperature : 24.3 [°C]
 Humidity : 47.4 [%] Tested by :
 Test place : 3m Semi-anechoic chamber Taiki Watanabe

Date : Oct. 14, 2014 Test personnel :
 Temperature : 24.2 [°C]
 Humidity : 56.3 [%] Tested by :
 Test place : 3m Semi-anechoic chamber Taiki Watanabe

[GSM850] (Channel: 128)

H/V	Frequency [MHz]	S.A Reading [dBm]	S.G Reading [dBm]	Cable loss [dB]	Ant.Gain [dBd]	Result [dBm]	Limit [dBm]	Margin [dB]
H	1648.3	-53.5	-54.1	1.0	6.8	-48.3	-13.0	35.3
V	1648.4	-55.4	-55.3	1.0	6.8	-49.5	-13.0	36.5
H	2472.6	-54.4	-50.0	1.3	7.5	-43.8	-13.0	30.8
V	2472.6	-50.2	-45.2	1.3	7.5	-39.0	-13.0	26.0

(Channel: 190)

H/V	Frequency [MHz]	S.A Reading [dBm]	S.G Reading [dBm]	Cable loss [dB]	Ant.Gain [dBd]	Result [dBm]	Limit [dBm]	Margin [dB]
H	1673.2	-53.8	-53.6	1.0	6.6	-48.0	-13.0	35.0
V	1673.2	-56.0	-55.6	1.0	6.6	-50.0	-13.0	37.0
H	2509.8	-50.1	-45.9	1.3	7.5	-39.7	-13.0	26.7
V	2509.8	-52.8	-43.2	1.3	7.5	-37.0	-13.0	24.0

(Channel: 251)

H/V	Frequency [MHz]	S.A Reading [dBm]	S.G Reading [dBm]	Cable loss [dB]	Ant.Gain [dBd]	Result [dBm]	Limit [dBm]	Margin [dB]
H	1697.6	-54.4	-54.0	1.0	6.4	-48.6	-13.0	35.6
V	1697.6	-54.6	-53.6	1.0	6.4	-48.2	-13.0	35.2
H	2546.4	-53.2	-49.0	1.3	7.6	-42.7	-13.0	29.7
V	2546.4	-55.7	-51.2	1.3	7.6	-44.9	-13.0	31.9



Zacta

**[WCDMA Band V]
(Channel: 4132)**

H/V	Frequency [MHz]	S.A Reading [dBm]	S.G Reading [dBm]	Cable loss [dB]	Ant.Gain [dBd]	Result [dBm]	Limit [dBm]	Margin [dB]
H	1654.4	-57.9	-58.3	1.0	6.8	-52.5	-13.0	39.5
V	1651.1	-58.5	-58.7	1.0	6.8	-52.9	-13.0	39.9

(Channel: 4183)

H/V	Frequency [MHz]	S.A Reading [dBm]	S.G Reading [dBm]	Cable loss [dB]	Ant.Gain [dBd]	Result [dBm]	Limit [dBm]	Margin [dB]
H	1674.6	-58.8	-58.5	1.0	6.6	-52.9	-13.0	39.9
V	1674.6	-56.7	-56.5	1.0	6.6	-50.9	-13.0	37.9

(Channel: 4233)

H/V	Frequency [MHz]	S.A Reading [dBm]	S.G Reading [dBm]	Cable loss [dB]	Ant.Gain [dBd]	Result [dBm]	Limit [dBm]	Margin [dB]
H	1691.8	-56.1	-55.7	1.0	6.5	-50.3	-13.0	37.3
V	1694.7	-57.8	-57.8	1.0	6.4	-52.4	-13.0	39.4

9. Frequency Stability

9.1 Measurement procedure [FCC 22.355, 2.1055]

The EUT was placed inside of a constant temperature chamber as the temperature in the chamber was varied between -30°C and $+50^{\circ}\text{C}$. The temperature was incremented by 10°C intervals and the unit was allowed to stabilize at each measurement. The frequency drift was measured with the normal Temperature and voltage tolerance and it is presented as the ppm unit.

- Test configuration

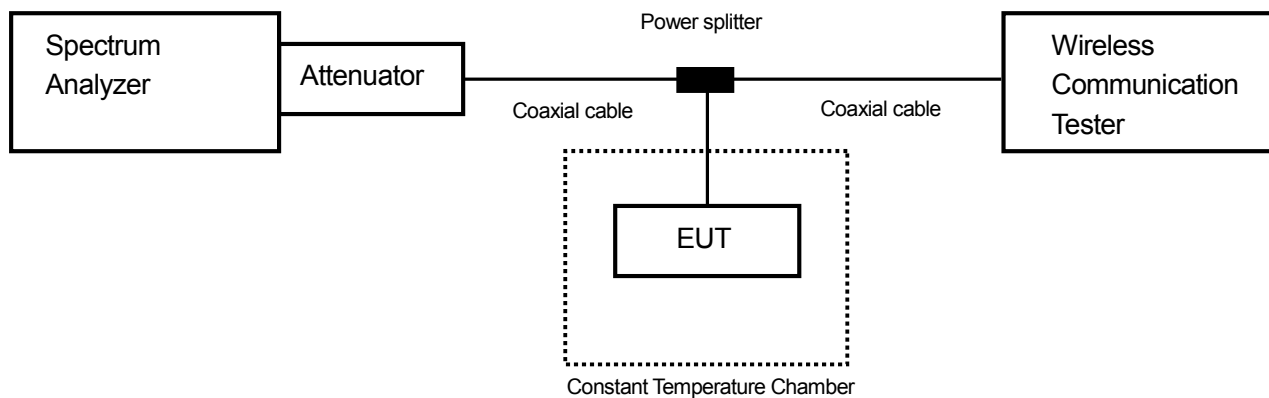

9.2 Limit

$\pm 2.5\text{ppm}$

9.3 Measurement result

Date : Oct. 8, 2014
 Temperature : 25.9 [°C]
 Humidity : 33.8 [%]
 Test place : Shielded room No.4

Test engineer : Taiki Watanabe

[GSM850] (Channel: 190)

Limit: $\pm 0.00025\% = \pm 2.5\text{ppm}$					
Power Supply [V]	Temperature [°C]	Measurements Frequency [Hz]	Frequency Tolerance [ppm]	Limit [ppm]	Result
3.80	25(Ref.)	836,600,026	0.00000	± 2.5	PASS
	50	836,600,010	-0.01945	± 2.5	PASS
	40	836,600,015	-0.01259	± 2.5	PASS
	30	836,600,016	-0.01158	± 2.5	PASS
	20	836,600,018	-0.00996	± 2.5	PASS
	10	836,600,029	0.00378	± 2.5	PASS
	0	836,600,015	-0.01351	± 2.5	PASS
	-10	836,600,013	-0.01513	± 2.5	PASS
	-20	836,600,016	-0.01243	± 2.5	PASS
	-30	836,600,013	-0.01560	± 2.5	PASS
3.230	25	836,600,018	-0.00949	± 2.5	PASS
4.370	25	836,600,015	-0.01255	± 2.5	PASS

[WCDMA Band V] (Channel: 4183)

Limit: $\pm 0.00025\% = \pm 2.5\text{ppm}$					
Power Supply [V]	Temperature [°C]	Measurements Frequency [Hz]	Frequency Tolerance [ppm]	Limit [ppm]	Result
3.80	25(Ref.)	836,599,997	0.00000	± 2.5	PASS
	50	836,600,001	0.00482	± 2.5	PASS
	40	836,599,997	-0.00059	± 2.5	PASS
	30	836,599,997	-0.00018	± 2.5	PASS
	20	836,600,002	0.00510	± 2.5	PASS
	10	836,599,997	-0.00014	± 2.5	PASS
	0	836,599,998	0.00090	± 2.5	PASS
	-10	836,600,003	0.00684	± 2.5	PASS
	-20	836,599,998	0.00010	± 2.5	PASS
	-30	836,599,995	-0.00247	± 2.5	PASS
3.230	25	836,599,997	-0.00042	± 2.5	PASS
4.370	25	836,600,002	0.00519	± 2.5	PASS

Calculation;

$$\text{Frequency Tolerance (ppm)} = \frac{\text{Measurements Frequency (Hz)} - \text{Reference Frequency (Hz)}}{\text{Reference Frequency (Hz)}} \times 1000000$$



Zacta

10. Uncertainty of measurement

Expanded uncertainties stated are calculated with a coverage Factor $k=2$.

Please note that these results are not taken into account when determining compliance or non-compliance with test result.

Test item	Measurement uncertainty
Conducted emission at mains port	$\pm 3.0\text{dB}$
Radiated emission (9kHz – 30MHz)	$\pm 4.4\text{dB}$
Radiated emission (30MHz – 1000MHz)	$\pm 4.5\text{dB}$
Radiated emission (1000MHz – 26GHz)	$\pm 3.9\text{dB}$

11. Laboratory description

1. Location:

TÜV SÜD Zacta Ltd. Yonezawa Testing Center
 4149-7 Hachimanpara 5-chome Yonezawa-shi Yamagata 992-1128 Japan
 Phone: +81-238-28-2880 Fax: +81-238-28-2888

2. Facility filing information:

1) NVLAP accreditation: NVLAP Lab. code: 200306-0

2) VLAC accreditation: Lab. code: VLAC-013

Site name	Radiated emission	Conducted emission for mains port	Conducted emission for telecom port	Radiated emission (CMAD)	Expiry Date
3m Semi-anechoic chamber	VLAC-013	VLAC-013	VLAC-013	-	Jul. 3, 2015
10m Semi-anechoic chamber No.1				VLAC-013	
10m Semi-anechoic chamber No.2					
Shielded room No.1	-	VLAC-013		-	

3) FCC filing:

Site name	Registration Number	Expiry Date
Site 3	91065	Oct.31, 2014
3m Semi-anechoic chamber	540072	Feb. 20, 2017
10m Semi-anechoic chamber No.1		
10m Semi-anechoic chamber No.2		
Shielded room No.1		

4) Industry Canada Oats site filing:

Site name	Sites on file: Oats 3m/10m	Expiry Date
Site 3	4224A-3	Jan. 23, 2015
3m Semi-anechoic chamber	4224A-4	
10m Semi-anechoic chamber No.1	4224A-5	
10m Semi-anechoic chamber No.2	4224A-6	Jan. 15, 2017

5) VCCI site filing:

Site name	Radiated emission	Conducted emission for mains port	Conducted emission for telecom port	Expiry Date
Site 3	R-138	C-134	T-1222	Nov. 16, 2014 Nov. 28, 2014* (*: Telecom port)
3m Semi-anechoic chamber	A-0166	A-0166	A-0166	Jul. 3, 2015
10m Semi-anechoic chamber No.1				
10m Semi-anechoic chamber No.2				
Shielded room No.1	-			

6) TÜV SÜD PS authorization:

Authorized as an EMC test laboratory

7) TÜV Rheinland authorization:

Authorized as an EMC test laboratory



Zacta

Appendix A. Test equipment

Antenna port conducted test

Equipment	Company	Model No.	Serial No.	Cal. due	Cal. date
Spectrum analyzer	Agilent Technologies	E4440A	US44302655	May 31, 2015	May 30, 2014
Microwave cable	RS	YH_13S5	N/A (S403)	May 31, 2015	May 10, 2014
Attenuator	Weinschel	56-10	J4180	Nov. 30, 2014	Nov. 12, 2013
Microwave cable	SUHNER	SUCOFLEX104/1.5m	199121/4	Oct. 31, 2014	Oct. 7, 2013
Microwave cable	SUHNER	SUCOFLEX104/1.5m	322086/4	Jul. 31, 2015	Jul. 30, 2014
Power splitter	ANRITSU	K240B	020205	Mar. 31, 2015	Mar. 17, 2014
Wideband radio frequency tester	ROHDE&SCHWARZ	CMW500	116338	Mar. 31, 2015	Mar. 7, 2014
Operation type temperature controlled bath	Espec	PL1KP	14007261	Dec. 31, 2014	Dec. 27, 2013

Radiated emission

Equipment	Company	Model No.	Serial No.	Cal. Due	Cal. Date
EMI Receiver	ROHDE&SCHWARZ	ECSI	100451	Nov. 30, 2014	Nov. 16, 2013
Preamplifier	ANRITSU	MH648A	M96057	Jun. 30, 2015	Jun. 12, 2014
Biconical antenna	Schwarzbeck	VHA9103/BBA9106	2125	May 31, 2015	May 7, 2014
Log periodic antenna	Schwarzbeck	UHALP9108A	0560	May 31, 2015	May 7, 2014
Attenuator	TME	CFA-01NPJ-6	N/A (S275)	Jun. 30, 2015	Jun. 9, 2014
Attenuator	TME	CFA-01NPJ-3	N/A (S272)	Jun. 30, 2015	Jun. 9, 2014
Spectrum analyzer	Agilent Technologies	E4440A	US44302655	May 31, 2015	May 30, 2014
Preamplifier	Agilent Technologies	8449B	3008A1008	Dec. 31, 2014	Dec. 9, 2013
Dipole antenna	Schwarzbeck	VHAP	1020	Sep. 30, 2015	Sep. 5, 2014
Dipole antenna	Schwarzbeck	UHAP	994	Sep. 30, 2015	Sep. 5, 2014
Double ridged guide antenna	EMCO	3115	5205	Dec. 31, 2014	Dec. 10, 2013
Attenuator	Agilent Technologies	8491B	MY39268633	Jan. 31, 2015	Jan. 15, 2014
Double ridged guide antenna	EMCO	3115	4328	Jan. 31, 2015	Jan. 21, 2014
Signal generator	ROHDE&SCHWARZ	SMB100A	177525	Feb. 28, 2015	Feb. 18, 2014
Microwave cable	SUHNER	SUCOFLEX102/2m	31648/2	Feb. 28, 2015	Feb. 13, 2014
High pass filter	Micro-Tronics	HPM50115	004	Jul. 31, 2015	Jul. 12, 2014
High pass filter	Wainwright	WHKX2.8/18G-6SS	1	Jul. 31, 2015	Jul. 17, 2014
Wideband radio frequency tester	ROHDE&SCHWARZ	CMW500	116338	Mar. 31, 2015	Mar. 7, 2014
Microwave cable	SUHNER	SUCOFLEX104/9m	346316/4	Oct. 31, 2014	Oct. 7, 2013
		SUCOFLEX104/1m	322084/4	Oct. 31, 2014	Oct. 7, 2013
		SUCOFLEX104/1.5m	317226/4	Oct. 31, 2014	Oct. 7, 2013
		SUCOFLEX104/7m	41625/6	Oct. 31, 2014	Oct. 7, 2013
PC	DELL	DIMENSION E521	75465BX	N/A	N/A
Software	TOYO Corporation	EP5/RE-AJ	0611193/V5.3.61	N/A	N/A
3m Semi-anechoic chamber	TOKIN	N/A	N/A (9002-NSA)	May 31, 2015	May 6, 2014
3m Semi-anechoic chamber	TOKIN	N/A	N/A (9002-SVSWR)	May 31, 2015	May 6, 2014

*: The calibrations of the above equipment are traceable to NIST or equivalent standards of the reference organizations.