

Report on the EMC Testing of:

KYOCERA Corporation
Tablet, Model: KC-T302DT

In accordance with FCC Part 15 Subpart B
Class B



Japan

Prepared for: KYOCERA Corporation
Yokohama Office 2-1-1 Kagahara, Tsuzuki-ku,
Yokohama-shi, Kanagawa, 224-8502 Japan
Phone: +81-45-943-6253 Fax: +81-45-943-6314

**Add value.
Inspire trust.**

COMMERCIAL-IN-CONFIDENCE

Document Number: JPX-TR-19155-0

SIGNATURE			
NAME	JOB TITLE	RESPONSIBLE FOR	ISSUE DATE
Eiji Akiba	EMC Lab Manager	Approved Signatory	29 MAY 2019

Signatures in this approval box have checked this document in line with the requirements of TÜV SÜD Japan Ltd. document control rules.

EXECUTIVE SUMMARY

A sample of this product was tested and found to be compliant with FCC Part 15 Subpart B.
(excluding the deviations mentioned in section 1.4 of this document).

 VLAC-013	DISCLAIMER AND COPYRIGHT The results in this report are applicable only to the equipment tested. This report shall not be re-produced except in full without the written approval of TÜV SÜD Japan Ltd.
	ACCREDITATION This test report must not be used by the client to claim product certification, approval, or endorsement by VLAC or ILAC-MRA.

TÜV SÜD Japan Ltd.
Yonezawa Testing Center
5-4149-7 Hachimanpara,
Yonezawa-shi, Yamagata,
992-1128 Japan

Phone: +81 (0) 238 28 2881
Fax: +81 (0) 238 28 2888
www.tuv-sud.jp



Japan

Additional signatures required by FCC 47 CFR Part 2, § 2.938 (b) (10)

Signatures of the individuals responsible for testing the product

ENGINEERING STATEMENT

The measurements shown in this report were made in accordance with the procedures described on test pages. All reported testing was carried out on a sample equipment to demonstrate limited compliance with FCC Part 15 Subpart B. The sample tested was found to be compliant with the requirements defined in the applied rules.

NAME	RESPONSIBLE FOR	SIGNATURE
Yoshiyuki Takahashi	Testing	<i>Yoshiyuki Takahashi</i>
Tsuyoshi Okumura	Testing	<i>Tsuyoshi Okumura</i>

Signatures of an official of the responsible party, as designated in § 2.909

SIGNATURE		
NAME	COMPANY	DATE

Contents

1	Summary of Test	4
1.1	Modification history of the test report	4
1.2	Standards	4
1.3	Measurement standards.....	4
1.4	Deviation from standards.....	4
1.5	List of applied test(s) of the EUT.....	4
1.6	Test information	4
1.7	Test set up.....	4
1.8	Test period.....	4
2	Equipment Under Test	5
2.1	EUT information	5
2.2	Modification to the EUT	5
2.3	Variation of family model(s)	5
2.4	Operation mode	6
3	Configuration of Equipment	7
3.1	Equipment used	7
3.2	Cable(s) used	7
3.3	System configuration.....	8
4	Test Result	9
4.1	Conducted emission at mains port.....	9
4.2	Radiated emission (below 1 GHz)	18
4.3	Radiated emission (above 1 GHz).....	27
5	Measurement Uncertainty	37
6	Laboratory Information	38
	Appendix A. Test Equipment	39

1 Summary of Test

1.1 Modification history of the test report

Document Number	Modification History	Issue Date
JPX-TR-19155-0	First Issue	Refer to the cover page

1.2 Standards

FCC Part 15 Subpart B

1.3 Measurement standards

ANSI C63.4 2014

1.4 Deviation from standards

None

1.5 List of applied test(s) of the EUT

Test Name	Classification of EUT	Test	Worst Point (Margin)	Result	Remark
Conducted emission at mains port	Class B	Applied	USB Read/ with ADP mode L1 0.448 MHz QP 7.7 dB	Pass	-
Radiated emission (below 1 GHz)	Class B	Applied	USB Read/ with ADP mode V 476.214 MHz QP 3.0 dB	Pass	-
Radiated emission (above 1 GHz)	Class B	Applied	USB Read/ with ADP mode V 3000.060 MHz AV 15.5 dB	Pass	-

1.6 Test information

None

1.7 Test set up

Table-top

1.8 Test period

17-April-2019 - 11-May-2019

2 Equipment Under Test

2.1 EUT information

Applicant	KYOCERA Corporation Yokohama Office 2-1-1 Kagahara, Tsuzuki-ku, Yokohama-shi, Kanagawa, 224-8502 Japan Phone: +81-45-943-6253 Fax: +81-45-943-6314
Equipment Under Test (EUT)	Tablet
Model number	KC-T302DT
Serial number	EMC1(KB18K000313)
Trade name	KYOCERA
Authorization	JOYKB18
Number of sample(s)	1
EUT condition	Pre-production
Maximum frequency	1400 MHz
Power rating	AC 100-240 V 50/60 Hz 0.3 A
Size	(W) 180.0 × (D) 10.7 × (H) 270.0 mm

2.2 Modification to the EUT

The table below details modifications made to the EUT during the test project.

Modification State	Description of Modification	Modification fitted by	Date of Modification
KC-T302DT, S/N: EMC1(KB18K000313)			
0	As supplied by the applicant	Not Applicable	Not Applicable

2.3 Variation of family model(s)

2.3.1 List of family model(s)

Not applicable

2.3.2 Reason for selection of EUT

Not applicable



Japan

2.4 Operation mode

1. In Camera/ with ADP mode

- i) Power ON
- ii) Record

2. Out Camera/ with ADP mode

- i) Power ON
- ii) Record

3. MP4/ with ADP mode

- i) Power ON
- ii) Execution of Color Bar moving picture data

4. USB Read/ with ADP mode

- i) Power ON
- ii) EUT connects to PC via USB cable
- iii) Read / write of MP4 moving picture data

3 Configuration of Equipment

Numbers assigned to equipment or cables in "3.1 Equipment(s) used" and "3.2 Cable(s) used" correspond to numbers in "3.3 System configuration".

3.1 Equipment used

No.	Equipment	Company	Model No.	Serial No.	FCC ID /DoC	Remarks
EUT1	Tablet	KYOCERA	KC-T302DT	EMC1(KB18K000313)	JOYKB18	EUT
ACC1	AC adapter	SALOM ELECTRIC	ADT301	JS-MHA	N/A	Accessory
ACC2	Digitizer pen	Wacom	CP-903E-21B-2	N/A	N/A	Accessory
AE1	Personal Computer	hp	HSTNN-I05C	CNU7071D2W	DoC	*1
	Personal Computer	Lenovo	L420	LR-0GDNF 12/02	DoC	*2
AE2	AC adapter	hp	PPP009H	F1-09020465460C	N/A	*1
	AC adapter	Lenovo	42T4418	11S42T4418Z1ZGWWG212MKX	N/A	*2
AE3	Printer	SII	DPU-414	3001288	DoC	*1
AE4	AC Adaptor for Printer	SII	PW-4007-J1-E	0614	N/A	*1
AE5	Earphone	Hosiden	HDH0261	N/A	N/A	-

*1: Used in Radiated emission.

*2: Used in Conducted emission at mains port.

3.2 Cable(s) used

No.	Cable	Length (m)	Shield	EUT accessory Ferrite core	Remarks
a	USB cable	1.0	Yes	-	-
b	DC cable for AC adapter	1.2	No	-	-
c	Earphone cable	1.0	No	-	-
d	DC cable for PC AC adapter	1.8	No	-	*1
	DC cable for PC AC adapter	1.8	No	-	*2
e	AC power cord for PC AC adapter	1.8	No	-	*1
	AC power cord for PC AC adapter	0.85	No	-	*2
f	Serial cable	1.8	Yes	-	*1
g	Parallel cable	2.1	Yes	-	*1
h	DC cable for Printer	1.9	No	-	*1

*1: Used in Radiated emission.

*2: Used in Conducted emission at mains port.

3.3 System configuration

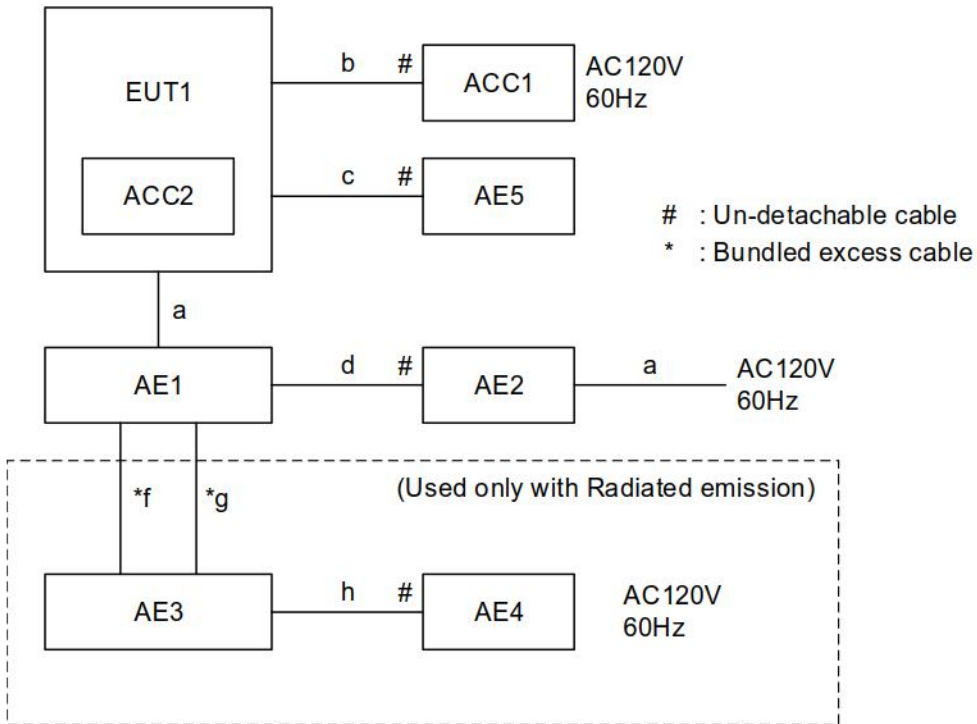

4 Test Result

4.1 Conducted emission at mains port

4.1.1 Measurement condition

Frequency range	0.15 MHz-30 MHz
Test place	10 m Semi-Anechoic Chamber No. 1
EUT was placed on	FRP table (W) 2.0 × (D) 1.0 × (H) 0.8 m
Metal reference plane	Vertical
Test receiver setting	Detector: Quasi-peak, Average Bandwidth: 9 kHz
Line Impedance Stabilization Network (LISN)	Specification: 50 Ω/50 μH Distance from EUT: 0.8 m

EUT is placed on a non-conducting table for table-top equipment or on insulation material for a floor-standing equipment. In addition, a table-top equipment is located 0.4 m to a metal reference plane.

Line Impedance Stabilization Network (LISN) is placed 0.8 m away from the EUT. The power code of the EUT is connected to LISN and its excess part is bundled in the center. The length of bundling is 0.3-0.4 m.

A power code of a peripheral is connected to LISN and terminated into 50 Ω.

Excess cables between equipment are bundled in the center. The length of bundling is 0.3-0.4 m.

Where LISN cannot be applied, the test is performed using a voltage probe.

After overall frequency range is investigated with spectrum analyzer using peak detector, measurements are performed with test receiver in setting to the defined values.

4.1.2 Calculation method

Emission level = Reading + c.f. (correction factor)*

Margin = Limit – Emission level

*Note: c.f. = LISN factor + Cable system loss + Attenuator loss

Example)

Limit @ 6.770 MHz: 60.0 dBμV (Quasi-peak)
50.0 dBμV (Average)

Quasi-peak Reading = 41.2 dBμV c.f. = 10.3 dB
Emission level = 41.2 + 10.3 = 51.5 dBμV
Margin = 60.0 - 51.5 = 8.5 dB

Average Reading = 35.0 dBμV c.f. = 10.3 dB
Emission level = 35.0 + 10.3 = 45.3 dBμV
Margin = 50.0 - 45.3 = 4.7 dB

4.1.3 Test data and Configuration photographs

Operation mode	MP4/ with ADP mode
EUT	KC-T302DT, S/N: EMC1(KB18K000313) - Modification State 0

Date of test: 10-May-2019 Supply voltage: AC 120 V Supply frequency: 60 Hz

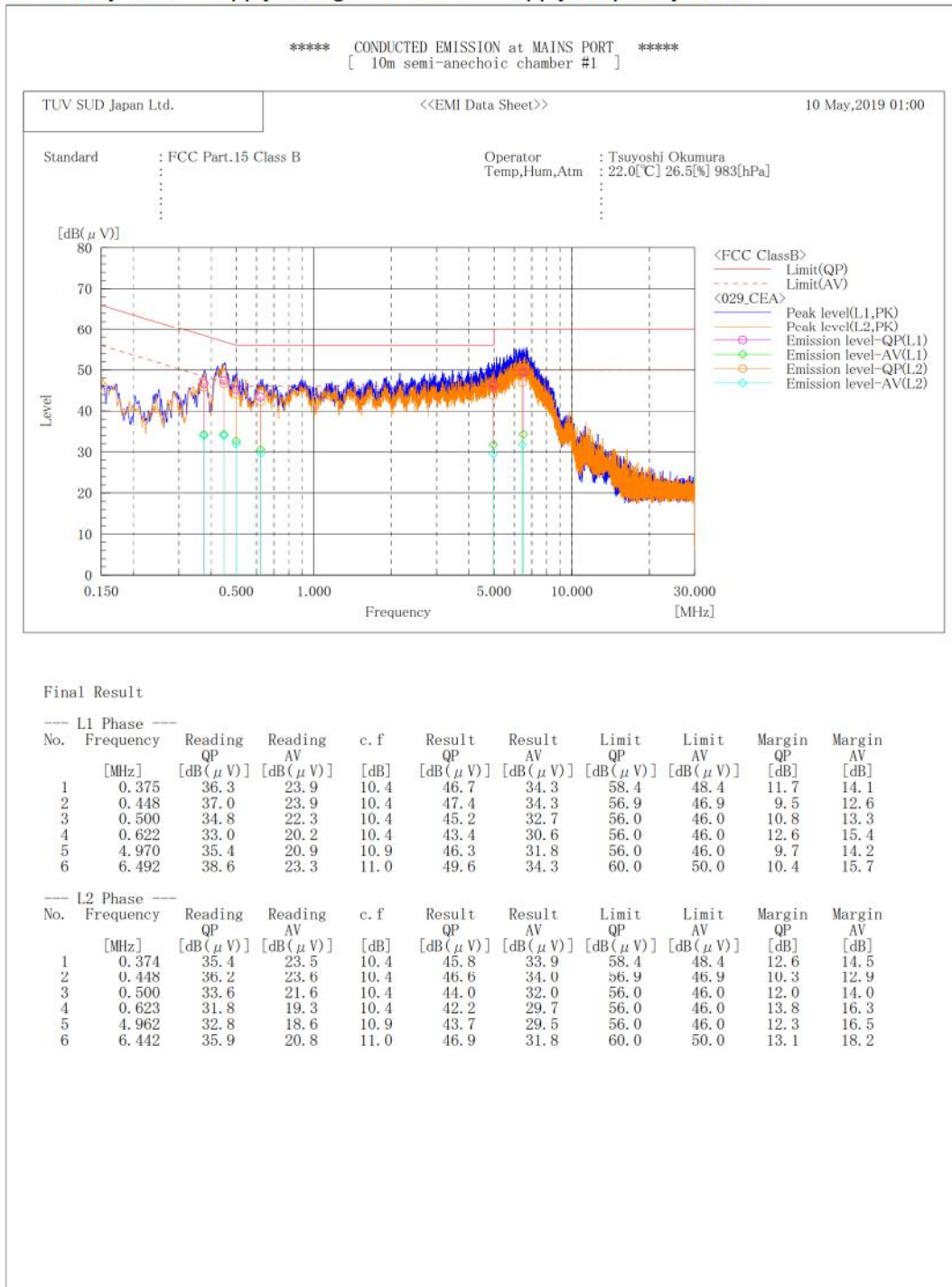



Operation mode	Out Camera/ with ADP mode
EUT	KC-T302DT, S/N: EMC1(KB18K000313) - Modification State 0

Date of test: 10-May-2019 Supply voltage: AC 120 V Supply frequency: 60 Hz

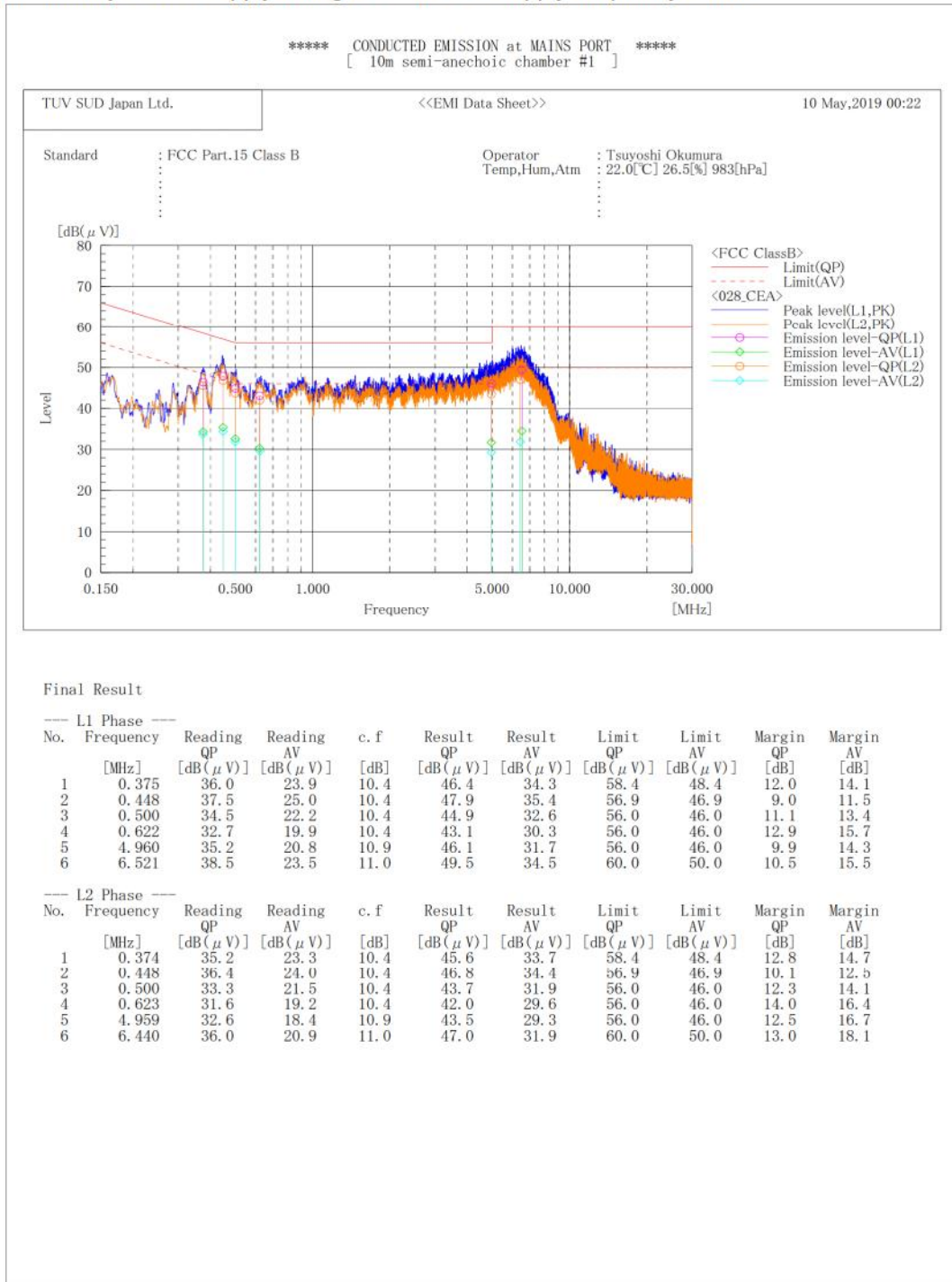



Operation mode	In Camera/ with ADP mode
EUT	KC-T302DT, S/N: EMC1(KB18K000313) - Modification State 0

Date of test: 09-May-2019 Supply voltage: AC 120 V Supply frequency: 60 Hz

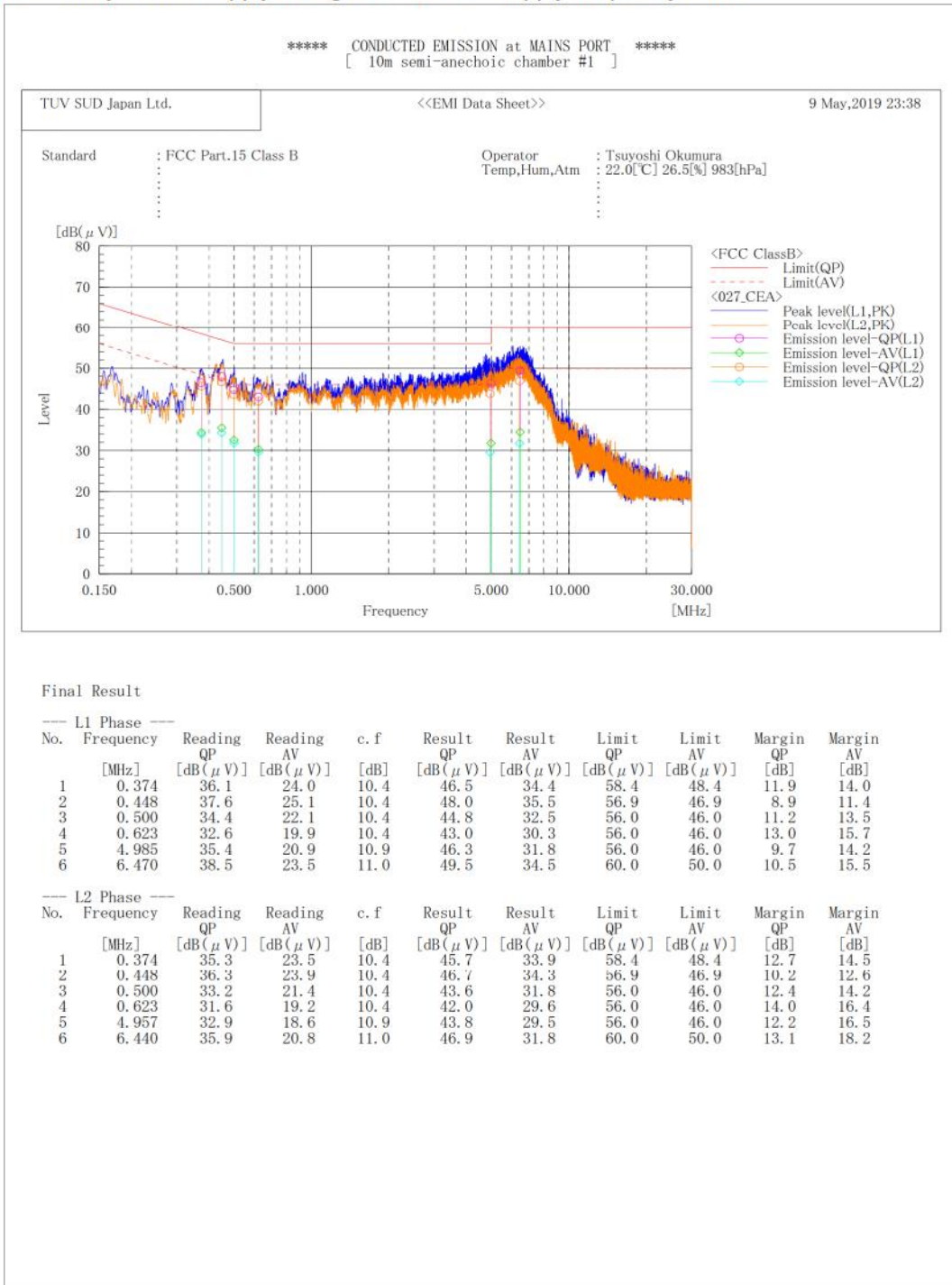



Operation mode	USB Read/ with ADP mode
EUT	KC-T302DT, S/N: EMC1(KB18K000313) - Modification State 0

Date of test: 10-May-2019 Supply voltage: AC 120 V Supply frequency: 60 Hz

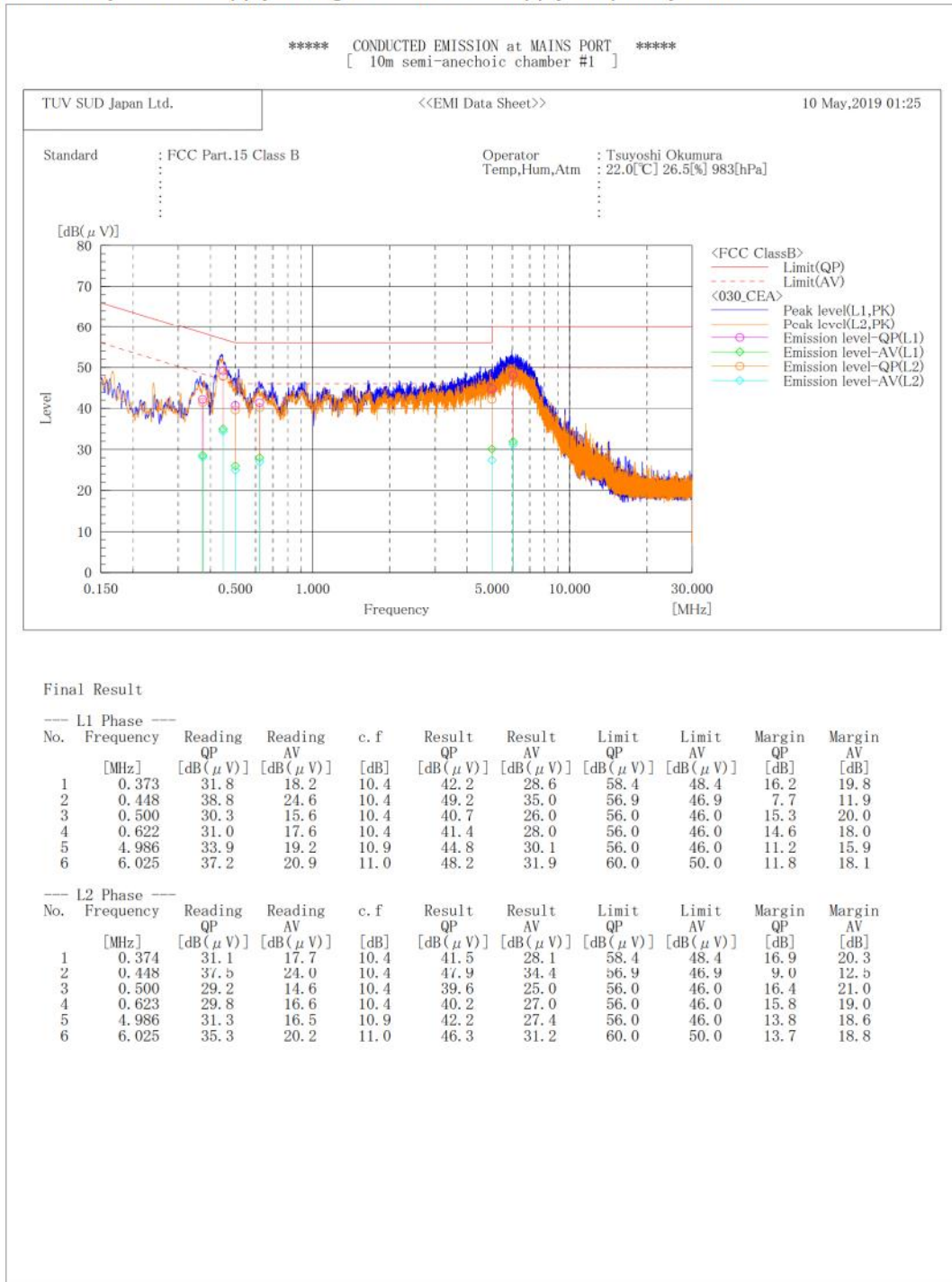

4.2 Radiated emission (below 1 GHz)

4.2.1 Measurement condition

Frequency range	30 MHz-1000 MHz
Test place	10 m Semi-Anechoic Chamber No. 1
EUT was placed on	FRP table (W) 2.0 × (D) 1.0 × (H) 0.8 m
Axis	0°-360°
Antenna	Distance from EUT: 3 m Height: 1-4 m Polarity: Horizontal/Vertical
Test receiver setting	Detector: Quasi-peak Bandwidth: 120 kHz

EUT is placed on a non-conducting table for table-top equipment or on insulation material for a floor-standing equipment. The non-conducting table or the insulation material is placed on a rotating turn table.

Excess cables between equipment are bundled in the center. The length of bundling is 0.3-0.4 m.

An antenna is adjusted between 1-4 m in height and varied its polarization (horizontal and vertical), and the EUT azimuth is varied by the rotating turntable 0 to 360 degrees.

After overall frequency range is investigated with spectrum analyzer using peak detector, measurements are performed with test receiver in setting to the defined values.

4.2.2 Calculation method

Emission level = Reading + c.f. (correction factor)*
Margin = Limit - Emission level

*Note: c.f. = Antenna factor + Cable system loss + Attenuator loss - Amplifier Gain

Example)

Limit @ 350.0 MHz: 37.0 dB μ V/m

Reading = 41.1 dB μ V c.f. = -11.8 dB/m
Emission level = 41.1 - 11.8 = 29.3 dB μ V/m
Margin = 37.0 - 29.3 = 7.7 dB



4.2.3 Test data and Configuration photographs

Operation mode	MP4/ with ADP mode
EUT	KC-T302DT, S/N: EMC1(KB18K000313) - Modification State 0

Date of test: 18-April-2019 Supply voltage: AC 120 V Supply frequency: 60 Hz

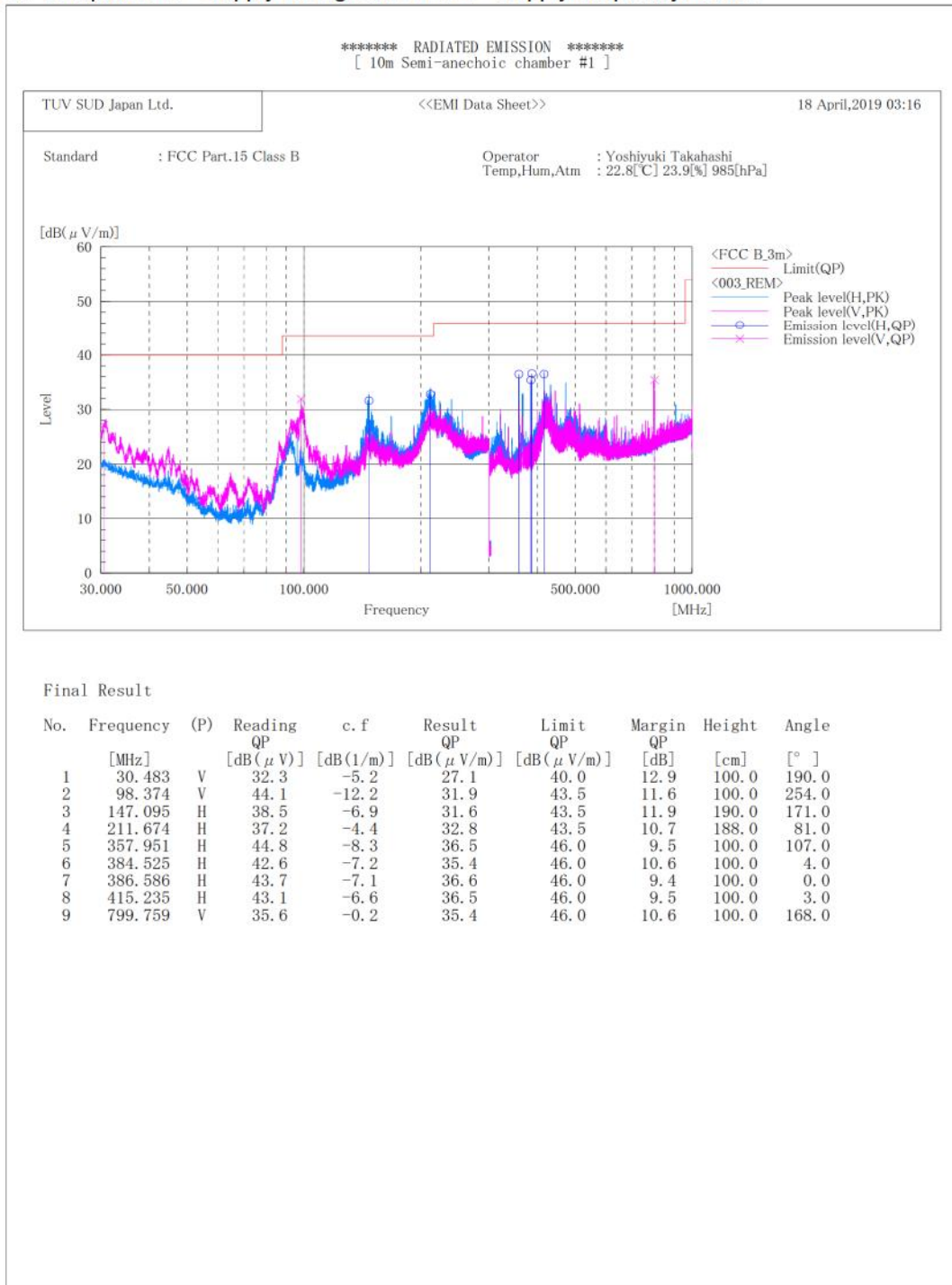



Japan

Operation mode	Out Camera/ with ADP mode
EUT	KC-T302DT, S/N: EMC1(KB18K000313) - Modification State 0

Date of test: 18-April-2019 Supply voltage: AC 120 V Supply frequency: 60 Hz

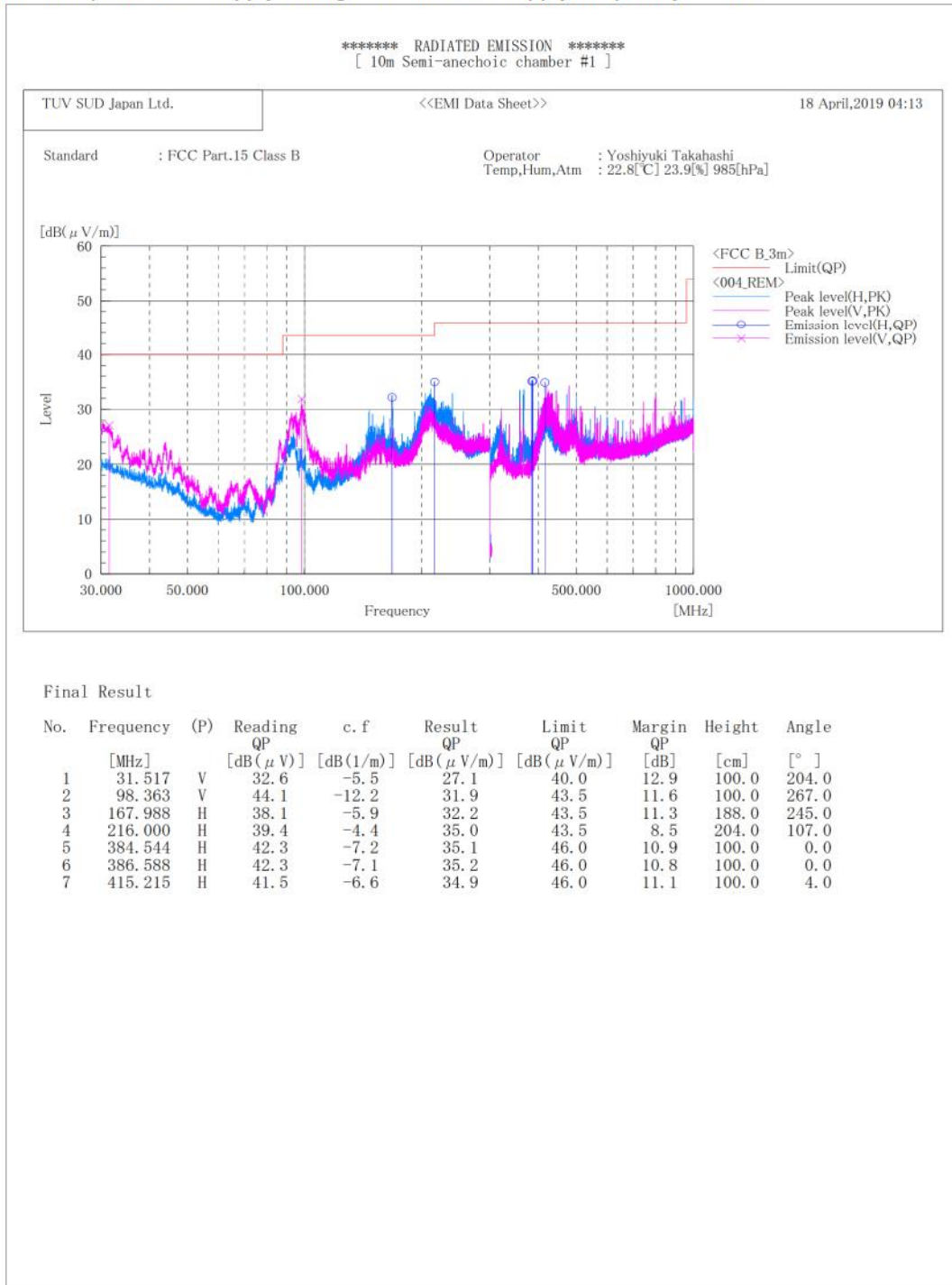



Japan

Operation mode	In Camera/ with ADP mode
EUT	KC-T302DT, S/N: EMC1(KB18K000313) - Modification State 0

Date of test: 18-April-2019 Supply voltage: AC 120 V Supply frequency: 60 Hz

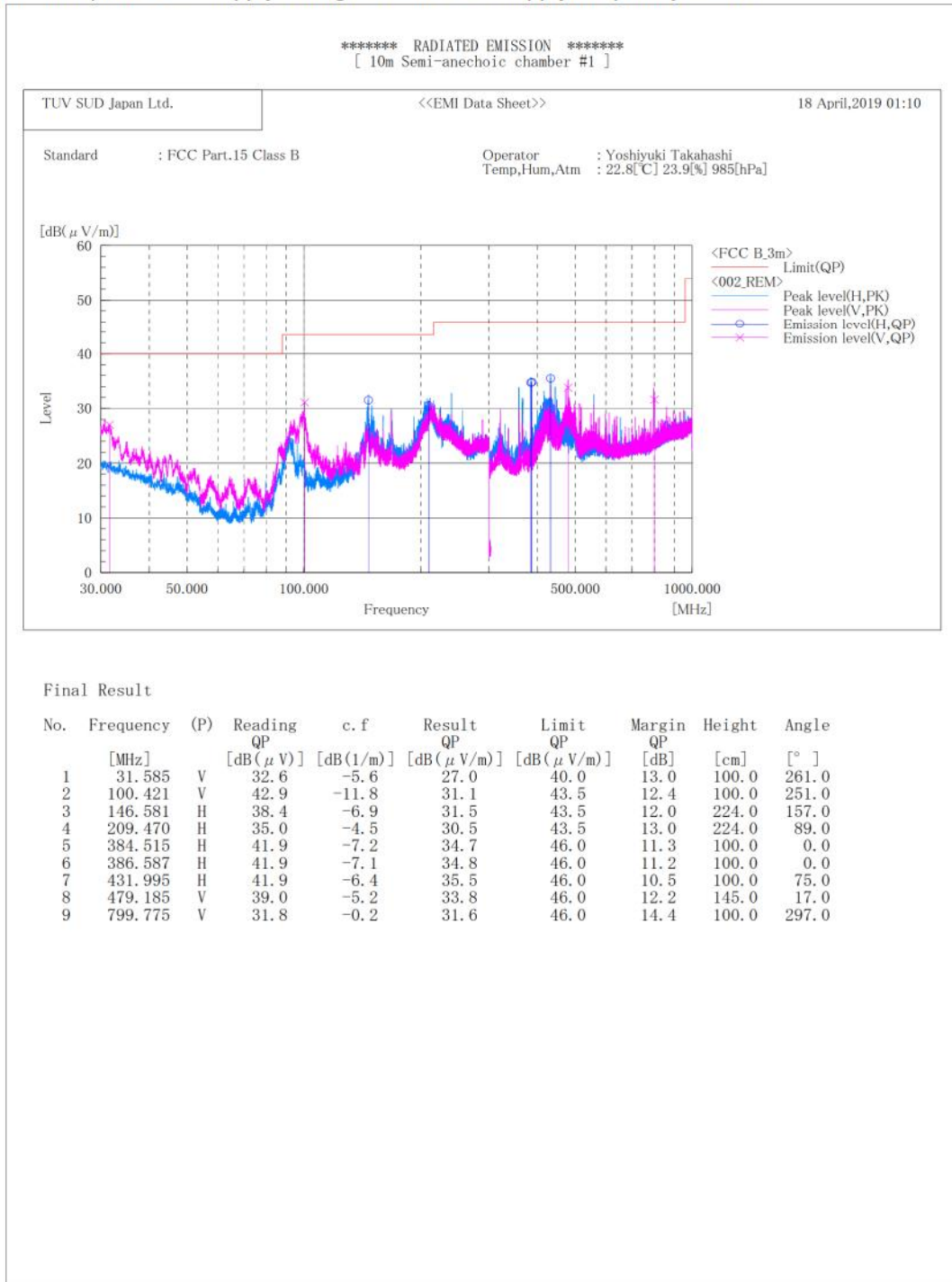



Operation mode	USB Read/ with ADP mode
EUT	KC-T302DT, S/N: EMC1(KB18K000313) - Modification State 0

Date of test: 17-April-2019 Supply voltage: AC 120 V Supply frequency: 60 Hz

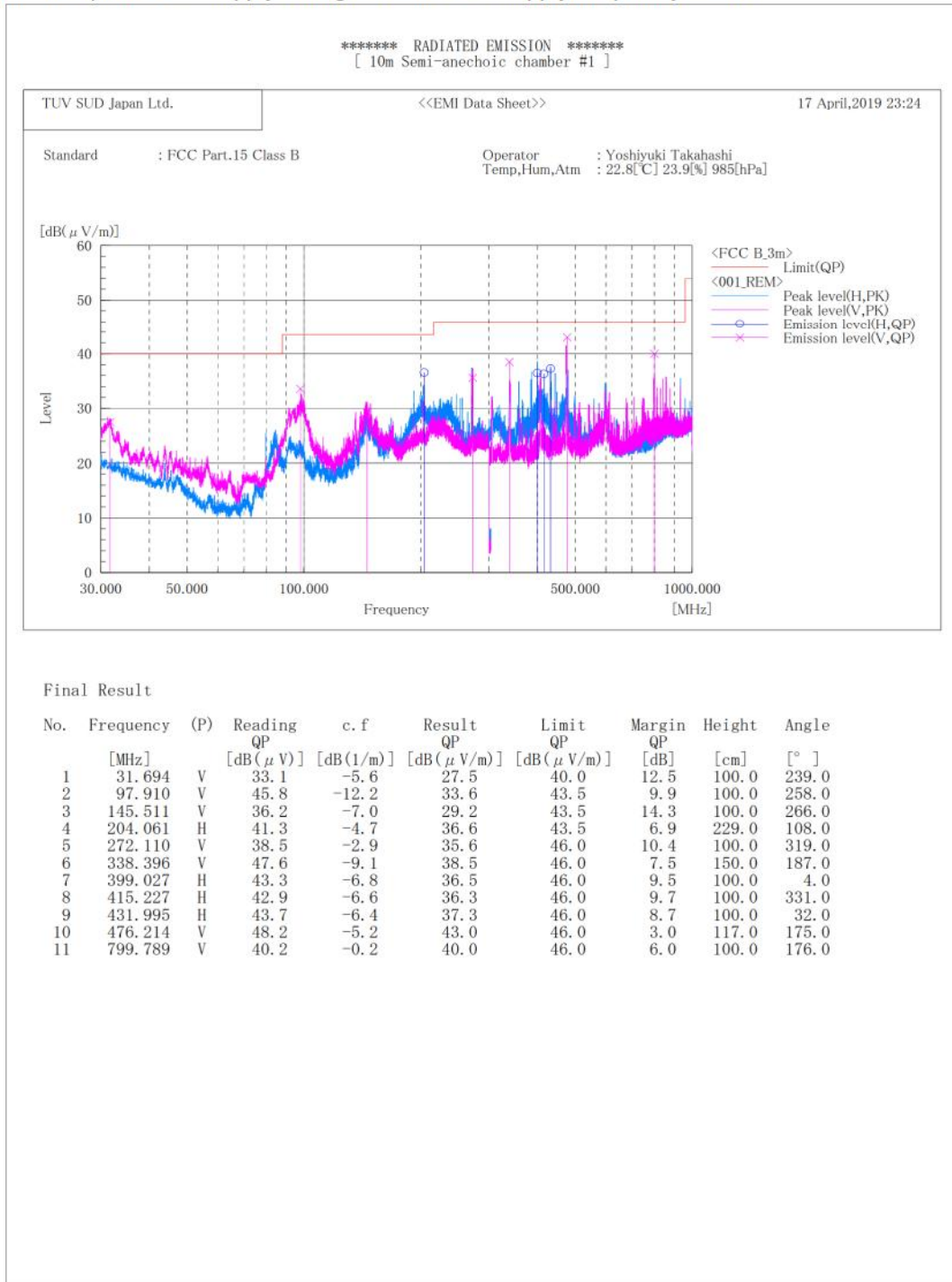

4.3 Radiated emission (above 1 GHz)

4.3.1 Measurement condition

Frequency range	1000 MHz-7000 MHz
Test place	10 m Semi-Anechoic Chamber No. 1
EUT was placed on	Styrene foam table (W) 2.0 × (D) 1.0 × (H) 0.8 m
Axis	0°-360°
Antenna	Distance: 3.75 m Height: 1-4 m Polarity: Horizontal/Vertical
Test receiver setting	Detector: Peak, Average Bandwidth: 1 MHz

EUT is placed on a styrene form table for table-top equipment or on insulation material for a floor-standing equipment. The styrene form table or the insulation material is placed on a rotating turn table.

Excess cables between equipment are bundled in the center. The length of bundling is 0.3-0.4 m.

Absorbers are placed between the EUT and an antenna.

The antenna is adjusted between 1-4 m in height and varied its polarization (horizontal and vertical), and the EUT azimuth is varied by the rotating turntable 0 to 360 degrees. Where height of the antenna is changed, its angle is also adjusted to the position of the EUT.

After overall frequency range is investigated with spectrum analyzer using peak detector, measurements are performed with test receiver in setting to the defined values.

The antenna is positioned from the test volume that was predetermined by the site VSWR measurement. Since this predetermined test volume is different from maximum circumference where the EUT and the peripheral devices are actually placed, the measurement distance conversion factor is added to the measurement data.

Antenna 3 dB beamwidth (antenna used: 3117)

Antenna: 3115

Frequency (GHz)	θ3 dB (°)	3 dB beamwidth w (m)
1.0	63	3.68
2.0	47	2.61
3.0	38	2.07
4.0	36	1.95
5.0	40	2.18
6.0	44	2.42

Antenna: 3117

Frequency (GHz)	θ3 dB (°)	3 dB beamwidth w (m)
1.0	82	5.22
2.0	60	3.46
3.0	76	4.69
4.0	56	3.19
5.0	54	3.06
6.0	50	2.80

Measurement distance: $d = 3.0$ m

$W = 2 \times d \times \tan(0.5 \times \theta_{3\text{ dB}})$

4.3.2 Calculation method

Emission level = Reading + Measurement distance conversion factor + c.f. (correction factor)*

Margin = Limit - Emission level

*Note: c.f. = Antenna factor + Cable system loss + Attenuator loss - Amplifier Gain

Example)

Limit @ 1100.0 MHz: 70.0 dB μ V/m (Peak)
50.0 dB μ V/m (Average)

Measurement distance: 3.25 m

Measurement distance conversion factor: $20 \log (3.25\text{m}/3.0\text{m}) = 0.7 \text{ dB}$

Peak Reading = 50.2 dB μ V, Measurement distance conversion factor = 0.7 dB,
 c.f. = 1.7 dB/m
 Emission level = $50.2 + 0.7 + 1.7 = 52.6 \text{ dB}\mu\text{V/m}$
 Margin = $70.0 - 52.6 = 17.4 \text{ dB}$

Average Reading = 32.0 dB μ V, Measurement distance conversion factor = 0.7 dB,
 c.f. = 1.7 dB/m
 Emission level = $32.0 + 0.7 + 1.7 = 34.4 \text{ dB}\mu\text{V/m}$
 Margin = $50.0 - 34.4 = 15.6 \text{ dB}$

4.3.3 Test data and Configuration photographs

Operation mode	MP4/ with ADP mode
EUT	KC-T302DT, S/N: EMC1(KB18K000313) - Modification State 0

Date of test: 10-May-2019 Supply voltage: AC 120 V Supply frequency: 60 Hz



Operation mode	Out Camera/ with ADP mode
EUT	KC-T302DT, S/N: EMC1(KB18K000313) - Modification State 0

Date of test: 11-May-2019 Supply voltage: AC 120 V Supply frequency: 60 Hz



Operation mode	USB Read/ with ADP mode
EUT	KC-T302DT, S/N: EMC1(KB18K000313) - Modification State 0

Date of test: 10-May-2019 Supply voltage: AC 120 V Supply frequency: 60 Hz



5 Measurement Uncertainty

The reported measurement uncertainty is based on a value obtained by multiplying standard uncertainty by coverage factor of $k=2$, and a level of confidence becomes 95 %.

Item	Parameter	U_{lab}	U_{cispr}
Conducted Emission, AMN	9kHz to 150kHz	± 3.8 dB	± 3.8 dB
Conducted Emission, AMN	150kHz to 30MHz	± 3.3 dB	± 3.4 dB
Conducted Emission, Voltage Probe	9kHz to 30MHz	± 2.8 dB	± 2.9 dB
Conducted Emission, AAN	150kHz to 30MHz	± 4.9 dB	± 5.0 dB
Conducted Emission, Current Probe	150kHz to 30MHz	± 2.9 dB	± 2.9 dB
Disturbance Power	30MHz to 300MHz	± 4.2 dB	± 4.5 dB
Radiated Emission	30MHz to 1000MHz	± 4.9 dB	± 6.3 dB
Radiated Emission	1GHz to 6GHz	± 4.8 dB	± 5.2 dB
Radiated Emission	6GHz to 18GHz	± 5.1 dB	± 5.5 dB
Radiated Emission	9kHz to 30MHz	± 3.1 dB	-
Electromagnetic fields test	10Hz to 400kHz	± 8.9 %	-



Japan

6 Laboratory Information

Testing was performed and the report was issued at:

TÜV SÜD Japan Ltd. Yonezawa Testing Center

Address: 5-4149-7 Hachimanpara, Yonezawa-shi, Yamagata, 992-1128 Japan
Phone: +81-238-28-2881
Fax: +81-238-28-2888

Accreditation and Registration

NVLAP
LAB CODE: 200306-0

VLAC
Accreditation No.: VLAC-013

BSMI
Laboratory Code: SL2-IN-E-6018, SL2-A1-E-6018

VCCI Council

Registration number	Expiration date
A-0166	03-July-2019

Appendix A. Test Equipment

Conducted emission at mains port

Equipment	Company	Model No.	Serial No.	Cal. due	Cal. Date
EMI receiver	ROHDE&SCHWARZ	ESR7	101742	31-Jan-2020	25-Jan-2019
Line impedance stabilization network for EUT	Kyoritsu Technology Corporation	TNW-407F2	12-17-110-2	31-May-2019	18-May-2018
Line impedance stabilization network	Kyoritsu Technology Corporation	TNW-242F2	12-17-109-2	31-May-2019	18-May-2018
Attenuator	HUBER+SUHNER	6810.01.A	N/A(S442)	31-Dec-2019	17-Dec-2018
Coaxial cable	FUJIKURA	5D-2W/4m	N/A(S349)	31-Oct-2019	10-Oct-2018
Microwave cable	HUBER+SUHNER	SUCOFLEX104/2m	317672/4	31-Oct-2019	10-Oct-2018
Coaxial cable	HUBER+SUHNER	RG214/U/25m	N/A(S191)	31-Oct-2019	12-Oct-2018
50Ω terminator	RS	090-0510	N/A(S058)	31-Jan-2020	16-Jan-2019
PC	HP	dc7800small	JPA7450FPJ	N/A	N/A
Software	TOYO Corporation	EP5/CE-AJ	0611193/V5.4.11	N/A	N/A

Radiated emission (below 1 GHz)

Equipment	Company	Model No.	Serial No.	Cal. due	Cal. date
EMI receiver	ROHDE&SCHWARZ	ESR7	101742	31-Jan-2020	25-Jan-2019
Biconical antenna	Schwarzbeck	VHA9103/BBA9106	VHA91032850	31-Oct-2019	17-Oct-2018
Log periodic antenna	Schwarzbeck	UHALP9108A	0992	31-Jul-2019	23-Jul-2018
Attenuator	TDC	TAT-43B-06	N/A(S209)	31-Jul-2019	11-Jul-2018
Attenuator	TAMAGAWA.ELEC	CFA-01NPJ-3	N/A(S270)	31-May-2019	16-May-2018
Microwave cable	HUBER+SUHNER	SUCOFLEX104/9m	MY23758/4	31-Oct-2019	10-Oct-2018
Microwave cable	HUBER+SUHNER	SUCOFLEX104/1m	MY24628/4	31-Oct-2019	10-Oct-2018
Microwave cable	HUBER+SUHNER	SUCOFLEX104/2m	SN MY28398/4	31-Oct-2019	10-Oct-2018
Microwave cable	HUBER+SUHNER	SUCOFLEX106/13m	MY1159/6	31-Oct-2019	12-Oct-2018
Preamplifier	ANRITSU	MH648A	M96057	31-Jan-2020	17-Jan-2019
10m Semi-anechoic Chamber	TOKIN	N/A	N/A(9001-NSA3m)	31-Oct-2019	12-Oct-2018
PC	HP	dc7800small	JPA7450FPJ	N/A	N/A
Software	TOYO Corporation	EP5/RE-AJ	0611193/V5.6.0	N/A	N/A

Radiated emission (above 1 GHz)

Equipment	Company	Model No.	Serial No.	Cal. due	Cal. date
Spectrum analyzer	ROHDE&SCHWARZ	FSV40	101732	31-Jan-2020	15-Jan-2019
Preamplifier	TSJ	MLA-0118-J02-40	14882	31-Oct-2019	10-Oct-2018
Double ridged guide antenna	ETS LINDGREN	3117	00209352	30-Nov-2019	06-Nov-2018
Attenuator	Agilent Technologies	8491B	MY39268632	31-May-2019	08-May-2018
Microwave cable	HUBER+SUHNER	SUCOFLEX104/9m	800693/4	31-May-2019	18-May-2018
Microwave cable	HUBER+SUHNER	SUCOFLEX104/1.5m	SN MY19304/4	31-Oct-2019	10-Oct-2018
Microwave cable	HUBER+SUHNER	SUCOFLEX104/2m	SN MY28398/4	31-Oct-2019	10-Oct-2018
Microwave cable	HUBER+SUHNER	SUCOFLEX106/13m	MY1159/6	31-Oct-2019	12-Oct-2018
Absorber	RIKEN	PFP30	N/A	N/A	N/A
10m Semi-anechoic Chamber	TOKIN	N/A	N/A(9001-SVSWR)	31-Oct-2019	13-Oct-2018
PC	HP	dc7800small	JPA7450FPJ	N/A	N/A
Software	TOYO Corporation	EP5/RE-AJ	0611193/V5.6.0	N/A	N/A