

TEST REPORT

Report number : Z101C-15100

Issue date : October 29, 2015

The device, as described herewith, was tested pursuant to applicable test procedure and complies with the requirements of;

FCC Part 22 Subpart H

The test results are traceable to the international or national standards.

Applicant	: KYOCERA Corporation
Equipment under test (EUT)	: Mobile Phone
Model number	: KA85
FCC ID	: JOYKA85

Date of test : September 24, 26, 28, 29, 2015
October 1, 2, 5, 7, 8, 2015

Test place : TÜV SÜD Zacta Ltd. Yonezawa Testing Center
4149-7 Hachimanpara 5-chome
Yonezawa-shi Yamagata 992-1128 Japan
Phone: +81-238-28-2880 Fax: +81-238-28-2888

Test results : Complied

The results in this report are applicable only to the equipment tested.
This report shall not be re-produced except in full without the written approval of TÜV SÜD Zacta Ltd.
This test report must not be used by the client to claim product certification, approval, or endorsement by NVLAP, NIST, or any agency of the federal government.

Tested by : Taiki Watanabe Tadahiro Seino
Taiki Watanabe Tadahiro Seino

Hikaru Shibata Kazunori Saito
Hikaru Shibata Kazunori Saito

Authorized by : Eiji Akiba
Eiji Akiba
Deputy General Manager of EMC Technical Department



NVLAP LAB CODE 200306-0

Table of contents

	Page
1. Summary of Test	3
1.1 Purpose of test	3
1.2 Standards	3
1.3 List of applied test to the EUT	3
1.4 Modification to the EUT by laboratory	3
2. Equipment Under Test	4
2.1 General Description of equipment	4
2.2 EUT information	4
2.3 Variation of the family model(s)	5
2.4 Description of Test mode	5
3. Configuration of equipment	6
3.1 Equipment(s) used	6
3.2 System configuration	6
4. Conducted Output Power	7
4.1 Measurement procedure	7
4.2 Measurement result	7
5. Effective Radiated Power	11
5.1 Measurement procedure	11
5.2 Calculation method	12
5.3 Limit	12
5.4 Test data	13
6. Occupied Bandwidth	16
6.1 Measurement procedure	16
6.2 Limit	16
6.3 Measurement result	16
6.4 Trace data	18
7. Band Edge Spurious and Harmonic at Antenna Terminals	24
7.1 Measurement procedure	24
7.2 Limit	24
7.3 Measurement result	25
7.4 Trace data	26
8. Radiated Emissions and Harmonic Emissions	57
8.1 Measurement procedure	57
8.2 Calculation method	57
8.3 Limit	57
8.4 Test data	58
9. Frequency Stability	65
9.1 Measurement procedure	65
9.2 Limit	65
9.3 Measurement result	66
10. Uncertainty of measurement	68
11. Laboratory description	69
Appendix A. Test equipment	70

1. Summary of Test

1.1 Purpose of test

It is the original test in order to verify conformance to FCC Part 22 Subpart H.

1.2 Standards

CFR47 FCC Part 22 Subpart H

1.2.1 Test Methods

KDB 971168 D01 Power Meas License Digital Systems v02r02
ANSI/TIA/EIA-603-D-2010

1.2.2 Deviation from standards

None

1.3 List of applied test to the EUT

Test items Section	Test items	Condition	Result
2.1046	Conducted Output Power	Conducted	PASS
22.913(a)	Effective Radiated Power	Radiated	PASS
22.917(a) 2.1049	Occupied Bandwidth	Conducted	PASS
22.917(a) 2.1051	Band Edge Spurious and Harmonic at Antenna Terminal	Conducted	PASS
22.917(a) 2.1053	Radiated emissions and Harmonic Emissions	Radiated	PASS
22.355 2.1055	Frequency Stability	Conducted	PASS

1.3.1 Test set up

Table-Top

1.4 Modification to the EUT by laboratory

None



Zacta

2. Equipment Under Test

2.1 General Description of equipment

EUT is the Mobile Phone.

2.2 EUT information

Applicant	:	KYOCERA Corporation Yokohama Office 2-1-1 Kagahara, Tsuzuki-ku Yokohama-shi, Kanagawa, Japan Phone: +81-45-943-6253 Fax: +81-45-943-6314
Equipment under test	:	Mobile Phone
Trade name	:	Kyocera
Model number	:	KA85
Serial number	:	N/A
EUT condition	:	Pre-Production
Power ratings	:	Battery: DC 3.8V
Size	:	(W) 71.0 × (D) 10.1 × (H) 141.4 mm
Environment	:	Indoor and Outdoor use
Terminal limitation	:	-20°C to 60°C
RF Specification Frequency of Operation	:	Up Link GSM850: 824.2-848.8MHz WCDMA Band V: 826.4-846.6MHz LTE Band V: 824-849MHz Down Link GSM850: 869.20-893.8MHz WCDMA Band V: 871.4-891.6MHz LTE Band V: 869-894MHz
Modulation type	:	GSM850: GMSK WCDMA Band V: QPSK, 16QAM LTE Band V: QPSK, 16QAM
Emission designator	:	GSM850: 245KGXW WCDMA Band V: 4M15F9W LTE Band V: QPSK: 9M02G7D, 16QAM: 9M01W7D
Output power	:	GSM850: 1.858W (32.69dBm) WCDMA Band V: 0.221W (23.44dBm) LTE Band V: QPSK 0.243W (23.85dBm), 16QAM 0.220W (23.43dBm)
Antenna type	:	Internal antenna
Antenna gain	:	GSM850: -1.2dBi WCDMA Band V: -1.2dBi LTE Band V: -1.2dBi

2.3 Variation of the family model(s)

Not applicable

2.4 Description of Test mode

The EUT had been tested under operating condition.
There are three channels have been tested as following:

Band	Channel	Frequency
GSM850	128	824.2MHz
	190	836.6MHz
	251	848.8MHz
WCDMA Band V	4132	826.4MHz
	4183	836.6MHz
	4233	846.6MHz

Band	Modulation	Bandwidth	Channel	Frequency [MHz]
LTE Band V	QPSK	1.4MHz	20407	824.7
			20525	836.5
			20643	848.3
		3MHz	20415	825.5
			20525	836.5
			20635	847.5
		5MHz	20425	826.5
			20525	836.5
			20625	846.5
		10MHz	20450	829.0
			20525	836.5
			20600	844.0
	16QAM	1.4MHz	20407	824.7
			20525	836.5
			20643	848.3
		3MHz	20415	825.5
20525	836.5			
20635	847.5			
5MHz	20425	826.5		
	20525	836.5		
	20625	846.5		
10MHz	20450	829.0		
	20525	836.5		
	20600	844.0		

The field strength of spurious emissions was measured at each position of all three axis X, Y and Z to compare the level, and the maximum noise.

The worst emission was found in Y (WCDMA Band V) and Z (GSM850, LTE Band V) axis and the worst case recorded.



3. Configuration of equipment

3.1 Equipment(s) used

No.	Equipment	Company	Model No.	Serial No.	FCC ID / DoC	Comment
1	Mobile Phone	KYOCERA	KA85	N/A	JOYKA85	EUT

3.2 System configuration

1. Mobile Phone
(EUT)

Note1: Numbers assigned to equipment on this diagram correspond to the list in "3.1 Equipment(s) used".

4. Conducted Output Power

4.1 Measurement procedure [FCC 2.1046]

The conducted output power was measured with a wireless communication tester connected to the antenna terminal. The wireless communication tester parameters were set to produce the maximum power from the EUT.

- Test configuration

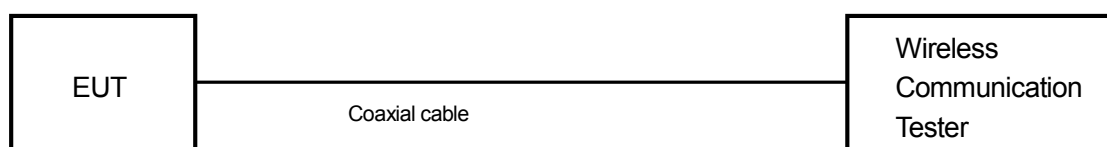

4.2 Measurement result

Date : September 24, 2015

Temperature : 22.0 [°C]

Humidity : 46.0 [%]

Test place : Shielded room No.4

Test engineer :

Tadahiro Seino

Band	Channel	Frequency [MHz]	Maximum Burst-Averaged Output Power [dBm]				
			Voice GSM CS 1slot	GPRS/EDGE(GMSK)Data			
				GPRS 1 TX Slot	GPRS 2 TX Slot	GPRS 3 TX Slot	GPRS 4 TX Slot
GSM 850	128	824.2	32.64	32.62	30.59	28.67	27.53
	190	836.6	32.69	32.68	30.63	28.28	27.43
	251	848.8	32.66	32.64	30.29	28.24	26.98



Zacta

Date : September 24, 2015
 Temperature : 22.0 [°C]
 Humidity : 46.0 [%]
 Test place : Shielded room No.4

Test engineer : Tadahiro Seino

3GPP Release Version	Mode		Sub- Test	Power [dBm]			MPR	Bc	βd	Bc/βd
	Channel			4132	4183	4233				
	Frequency [MHz]			826.4	836.6	846.6				
99	W-CDMA	RMC	-	23.31	23.33	23.35	-	-	-	-
		AMR	-	23.32	23.32	23.26	-	-	-	-
5	HSDPA (Cellular)	1	1	22.28	22.24	22.20	0	2/15	15/15	2/15
5		2	2	21.92	21.90	21.96	0	12/15	15/15	12/15
5		3	3	21.31	21.37	21.29	0.5	15/15	8/15	15/8
5		4	4	21.20	21.30	21.25	0.5	15/15	4/15	15/4
6	HSUPA	1	1	22.37	22.13	22.27	0	11/15	15/15	11/15
6		2	2	20.79	21.21	20.78	2	6/15	15/15	6/15
6		3	3	22.28	21.00	21.35	1	15/15	9/15	15/9
6		4	4	21.40	21.52	21.77	2	2/15	15/15	2/15
6		5	5	22.34	22.28	22.29	0	15/15	15/15	15/15

Date : September 26, 2015
 Temperature : 22.0 [°C]
 Humidity : 46.3 [%]
 Test place : Shielded room No.4

Test engineer : Tadahiro Seino

Band	BW [MHz]	Mode	RB Allocation	RB offset	Target MPR	Avg Power[dBm]		
						20407	20525	20642
						824.7 MHz	836.5 MHz	848.2 MHz
LTE Band 5	1.4	QPSK	1	0	0	23.70	23.52	23.09
			1	3	0	23.85	23.53	23.17
			1	5	0	23.64	23.41	23.11
			3	0	0	23.58	23.53	23.20
			3	1	0	23.61	23.55	23.10
			3	3	0	23.60	23.59	23.10
		16QAM	6	0	1	22.66	22.63	22.34
			1	0	1	23.05	22.75	22.01
			1	3	1	23.06	22.78	22.31
			1	5	1	22.91	22.72	21.99
			3	0	1	22.50	22.61	22.28
			3	1	1	22.46	22.61	22.29
			3	3	1	22.32	22.59	22.17
			6	0	2	21.87	21.46	21.46

Band	BW [MHz]	Mode	RB Allocation	RB offset	Target MPR	Avg Power[dBm]		
						20415	20525	20634
						825.5 MHz	836.5 MHz	847.4 MHz
LTE Band 5	3	QPSK	1	0	0	23.54	23.51	23.05
			1	8	0	23.45	23.47	23.08
			1	14	0	23.70	23.43	23.09
			8	0	1	22.74	22.64	22.20
			8	4	1	22.62	22.66	22.31
			8	7	1	22.71	22.67	22.30
			15	0	1	22.66	22.59	22.16
		16QAM	1	0	1	23.43	22.53	22.10
			1	8	1	23.35	22.20	22.15
			1	14	1	23.40	22.21	22.16
			8	0	2	21.73	21.71	21.04
			8	4	2	21.68	21.72	21.36
			8	7	2	21.73	21.73	21.55
			15	0	2	21.78	21.70	21.27

Band	BW [MHz]	Mode	RB Allocation	RB offset	Target MPR	Avg Power[dBm]		
						20425	20525	20625
						826.5 MHz	836.5 MHz	846.5 MHz
LTE Band 5	5	QPSK	1	0	0	23.72	23.30	23.25
			1	12	0	23.65	23.39	23.25
			1	24	0	23.53	23.17	23.19
			12	0	1	22.56	22.67	22.25
			12	7	1	22.66	22.61	22.25
			12	13	1	22.62	22.53	22.26
		16QAM	25	0	1	22.63	22.61	22.21
			1	0	1	23.07	22.08	22.04
			1	12	1	23.03	22.55	22.50
			1	24	1	23.15	22.38	22.32
			12	0	2	21.55	21.72	21.04
			12	7	2	21.57	21.42	21.09
			12	13	2	21.55	21.68	21.14
			25	0	2	21.59	21.62	21.19

Band	BW [MHz]	Mode	RB Allocation	RB offset	Target MPR	Avg Power[dBm]		
						20450	20525	20600
						829.0 MHz	836.5 MHz	844.0 MHz
LTE Band 5	10	QPSK	1	0	0	23.69	23.63	23.48
			1	25	0	23.54	23.61	23.19
			1	49	0	23.63	23.62	23.27
			25	0	1	22.67	22.72	22.57
			25	12	1	22.63	22.61	22.30
			25	25	1	22.58	22.59	22.29
			50	0	1	22.64	22.67	22.45
		16QAM	1	0	1	23.41	22.52	22.26
			1	25	1	23.31	22.90	22.15
			1	49	1	23.01	22.77	21.96
			25	0	2	21.59	21.62	21.58
			25	12	2	21.66	21.52	21.35
			25	25	2	21.76	21.54	21.30
			50	0	2	21.67	21.48	21.53

5. Effective Radiated Power

5.1 Measurement procedure [FCC 22.913(a)]

<Step 1>

The EUT and support equipment are placed on a 1 meter x 1.5 meter surface, 0.8 meter height FRP table. Radiated emission measurements are performed at 3 meter distance with the broadband antenna (double ridged guide antenna). The antenna is positioned both the horizontal and vertical planes of polarization and height is varied 1 to 4 meters and stopped at height producing the maximum emission. The turntable is rotated by 360 degrees and stopped at azimuth of producing the maximum emission.

<Step 2>

The substitution antenna is replaced by the transmitter antenna (EUT). The frequency of the signal generator is adjusted to the measurement frequency. Level of the signal generator is adjusted to the level that is obtained from step 1, and record the emission level of signal generator.

The spectrum analyzer is set to;

- a) Span = 1.5 times the OBW
- b) RBW = 1-5% of the expected OBW, not to exceed 1MHz
- c) VBW $\geq 3 \times$ RBW
- d) Number of sweep points $\geq 2 \times$ span / RBW
- e) Sweep time = auto-couple
- f) Detector = RMS (power averaging)
- g) If the EUT can be configured to transmit continuously (i.e., burst duty cycle $\geq 98\%$), then set the trigger to free run.
- h) If the EUT cannot be configured to transmit continuously (i.e., burst duty cycle $< 98\%$), then use a sweep trigger with the level set to enable triggering only on full power bursts and configure the EUT to transmit at full power for the entire duration of each sweep. Ensure that the sweep time is less than or equal to the transmission burst duration.
- i) Trace average at least 100 traces in power averaging (i.e., RMS) mode.
- j) Compute the power by integrating the spectrum across the OBW of the signal using the instrument's band power measurement function, with the band limits set equal to the OBW band edges. If the instrument does not have a band power function, then sum the spectrum levels (in linear power units) at intervals equal to the RBW extending across the entire OBW of the spectrum.

- Test configuration

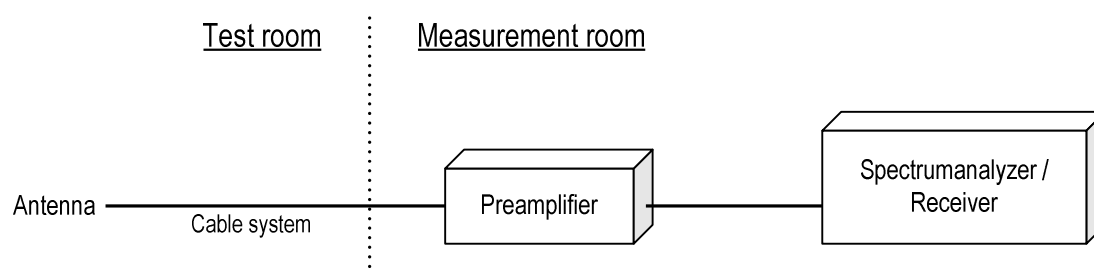



Zacta

5.2 Calculation method

Result (ERP) = S.G Reading – Cable loss + Antenna Gain
Margin = Limit – Result (ERP)

5.3 Limit

7 W (38.45dBm)



Zacta

5.4 Test data

Date	: September 28, 2015	Test engineer	:	<u>Taiki Watanabe</u>
Temperature	: 19.7 [°C]			
Humidity	: 63.4 [%]			
Test place	: 3m Semi-anechoic chamber			
Date	: October 1, 2015	Test engineer	:	<u>Taiki Watanabe</u>
Temperature	: 20.9 [°C]			
Humidity	: 44.9 [%]			
Test place	: 3m Semi-anechoic chamber			
Date	: October 1, 2015	Test engineer	:	<u>Hikaru Shibata</u>
Temperature	: 24.2 [°C]			
Humidity	: 54.1 [%]			
Test place	: 3m Semi-anechoic chamber			
Date	: October 8, 2015	Test engineer	:	<u>Kazunori Saito</u>
Temperature	: 23.4 [°C]			
Humidity	: 31.2 [%]			
Test place	: 3m Semi-anechoic chamber			

[GSM850]

H/V	Frequency [MHz]	S.A Reading [dBm]	S.G Reading [dBm]	Cable loss [dB]	Ant.Gain [dBi]	Result [dBm]	Limit [dBm]	Margin [dB]
H	824.2	-22.7	37.0	0.7	-10.7	25.6	38.4	12.8
H	836.6	-24.7	36.0	0.7	-10.7	24.6	38.4	13.8
H	848.8	-26.1	34.0	0.8	-10.7	22.6	38.4	15.8

[WCDMA Band V]

H/V	Frequency [MHz]	S.A Reading [dBm]	S.G Reading [dBm]	Cable loss [dB]	Ant.Gain [dBi]	Result [dBm]	Limit [dBm]	Margin [dB]
H	826.4	-29.9	30.0	0.7	-10.7	18.6	38.4	19.8
H	836.6	-29.6	32.0	0.7	-10.7	20.6	38.4	17.8
H	846.6	-29.9	32.0	0.8	-10.7	20.6	38.4	17.8

Date : October 1, 2015
 Temperature : 24.2 [°C]
 Humidity : 54.1 [%]
 Test place : 3m Semi-anechoic chamber
 Test engineer : Hikaru Shibata

Date : October 1, 2015
 Temperature : 20.9 [°C]
 Humidity : 44.9 [%]
 Test place : 3m Semi-anechoic chamber
 Test engineer : Kazunori Saito

Date : October 8, 2015
 Temperature : 23.4 [°C]
 Humidity : 31.2 [%]
 Test place : 3m Semi-anechoic chamber
 Test engineer : Kazunori Saito

**[LTE Band V]
 QPSK, BW 1.4MHz**

H/V	Frequency [MHz]	S.A Reading [dBm]	S.G Reading [dBm]	Cable loss [dB]	Ant.Gain [dBi]	Result [dBm]	Limit [dBm]	Margin [dB]
H	824.8	-14.2	29.3	0.7	-10.7	17.9	34.7	16.8
H	836.6	-15.1	29.1	0.7	-10.7	17.7	34.7	17.0
H	848.3	-16.5	29.0	0.8	-10.7	17.6	34.7	17.1

QPSK, BW 3MHz

H/V	Frequency [MHz]	S.A Reading [dBm]	S.G Reading [dBm]	Cable loss [dB]	Ant.Gain [dBi]	Result [dBm]	Limit [dBm]	Margin [dB]
H	826.8	-15.8	29.0	0.7	-10.7	17.6	34.7	17.1
H	837.8	-16.7	28.0	0.7	-10.7	16.6	34.7	18.1
H	848.7	-17.6	27.0	0.8	-10.7	15.6	34.7	19.1

QPSK, BW 5MHz

H/V	Frequency [MHz]	S.A Reading [dBm]	S.G Reading [dBm]	Cable loss [dB]	Ant.Gain [dBi]	Result [dBm]	Limit [dBm]	Margin [dB]
H	824.3	-18.4	25.0	0.7	-10.7	13.6	34.7	21.1
H	834.3	-18.9	26.0	0.7	-10.7	14.6	34.7	20.1
H	844.3	-19.6	26.0	0.7	-10.7	14.6	34.7	20.1

QPSK, BW 10MHz

H/V	Frequency [MHz]	S.A Reading [dBm]	S.G Reading [dBm]	Cable loss [dB]	Ant.Gain [dBi]	Result [dBm]	Limit [dBm]	Margin [dB]
H	824.6	-14.5	29.0	0.7	-10.7	17.6	34.7	17.1
H	832.1	-16.0	29.0	0.7	-10.7	17.6	34.7	17.1
H	839.6	-16.3	29.0	0.7	-10.7	17.6	34.7	17.1

16QAM, BW 1.4MHz

H/V	Frequency [MHz]	S.A Reading [dBm]	S.G Reading [dBm]	Cable loss [dB]	Ant.Gain [dBi]	Result [dBm]	Limit [dBm]	Margin [dB]
H	824.8	-16.2	27.3	0.7	-10.7	15.9	34.7	18.8
H	836.6	-17.9	26.3	0.7	-10.7	14.9	34.7	19.8
H	848.3	-19.4	26.1	0.8	-10.7	14.7	34.7	20.0

16QAM, BW 3MHz

H/V	Frequency [MHz]	S.A Reading [dBm]	S.G Reading [dBm]	Cable loss [dB]	Ant.Gain [dBi]	Result [dBm]	Limit [dBm]	Margin [dB]
H	824.2	-19.6	25.2	0.7	-10.7	13.8	34.7	20.9
H	835.2	-17.2	27.5	0.7	-10.7	16.1	34.7	18.6
H	846.1	-17.2	27.4	0.8	-10.7	16.0	34.7	18.7

16QAM, BW 5MHz

H/V	Frequency [MHz]	S.A Reading [dBm]	S.G Reading [dBm]	Cable loss [dB]	Ant.Gain [dBi]	Result [dBm]	Limit [dBm]	Margin [dB]
H	828.7	-16.4	27.0	0.7	-10.7	15.6	34.7	19.1
H	838.7	-17.6	27.3	0.7	-10.7	15.9	34.7	18.8
H	848.7	-18.9	26.7	0.8	-10.7	15.3	34.7	19.4

16QAM, BW 10MHz

H/V	Frequency [MHz]	S.A Reading [dBm]	S.G Reading [dBm]	Cable loss [dB]	Ant.Gain [dBi]	Result [dBm]	Limit [dBm]	Margin [dB]
H	824.6	-14.9	28.6	0.7	-10.7	17.2	34.7	17.5
H	832.1	-16.8	28.2	0.7	-10.7	16.8	34.7	17.9
H	839.6	-16.5	28.8	0.7	-10.7	17.4	34.7	17.3

6. Occupied Bandwidth

6.1 Measurement procedure [FCC 22.917(a), 2.1049]

The Occupied bandwidth was measured with a spectrum analyzer connected to the antenna terminal. The spectrum analyzer's automatic bandwidth measurement capability was used to perform the 99% occupied bandwidth and the 26dB bandwidth.

The spectrum analyzer is set to;

- a) RBW = 1-5% of the expected OBW & VBW $\geq 3 \times$ RBW
- b) Detector = Peak
- c) Trace mode = Max hold
- d) Sweep time = auto-couple

- Test configuration

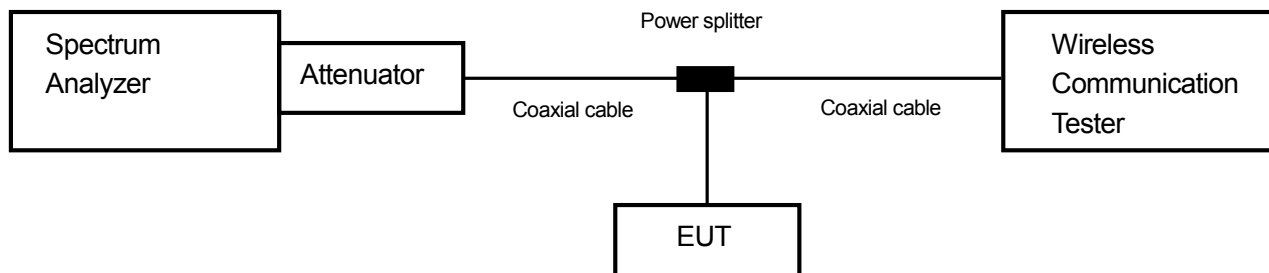

6.2 Limit

None

6.3 Measurement result

Date : October 2, 2015
 Temperature : 24.4 [°C]
 Humidity : 45.6 [%]
 Test place : Shielded room No.4

Test engineer : Kazunori Saito

Date : October 8, 2015
 Temperature : 21.7 [°C]
 Humidity : 48.3 [%]
 Test place : Shielded room No.4

Test engineer : Hikaru Shibata



Zacta

Band	Channel	Frequency (MHz)	Test Result (kHz)
GSM850	128	824.2	244.2948
	190	836.6	245.4160
	251	848.8	242.4205

Band	Channel	Frequency (MHz)	Test Result (MHz)
W-CDMA850	4132	826.4	4.1496
	4183	836.6	4.1449
	4233	846.6	4.1545

[LTE Band V]

BW	Mode	UL RB Allocation	UL RB Start	Frequency [MHz]	26dB Bandwidth [MHz]	99% OBW [MHz]
1.4MHz	QPSK	3	1	836.5	0.924	0.6120
		6	0		1.324	1.1051
1.4MHz	16QAM	3	1	836.5	0.945	0.6260
		6	0		1.310	1.1117
3MHz	QPSK	8	4	836.5	2.232	1.5633
		15	0		3.009	2.7080
3MHz	16QAM	8	4	836.5	2.118	1.5584
		15	0		3.027	2.7213
5MHz	QPSK	12	7	836.5	3.474	2.3241
		25	0		5.021	4.5220
5MHz	16QAM	12	7	836.5	3.464	2.3430
		25	0		5.049	4.5301
10MHz	QPSK	25	12	836.5	6.027	4.6902
		50	0		10.038	9.0249
10MHz	16QAM	25	12	836.5	6.587	4.6924
		50	0		9.978	9.0068

6.4 Trace data
[GSM850]

Channel: 128

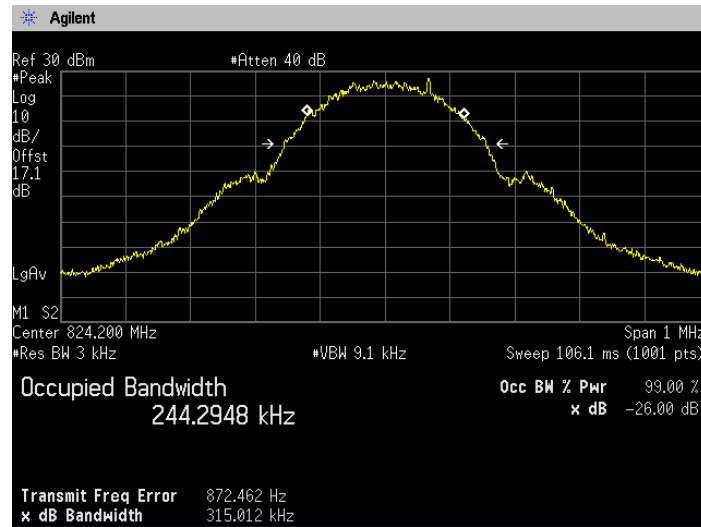

Channel: 190

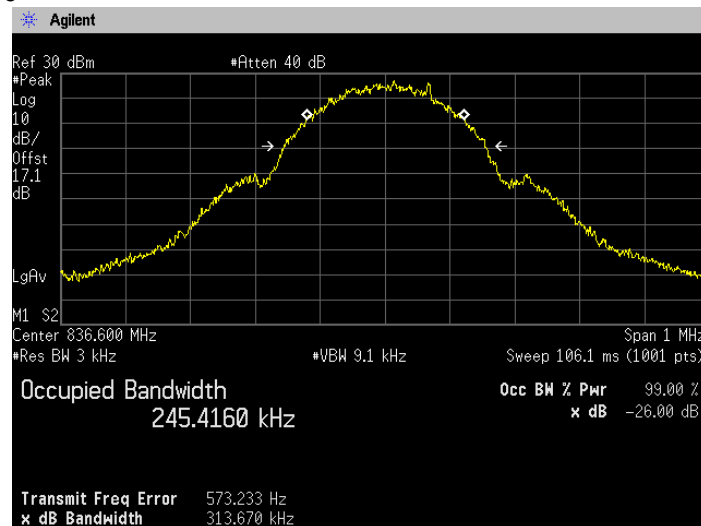

Channel: 251

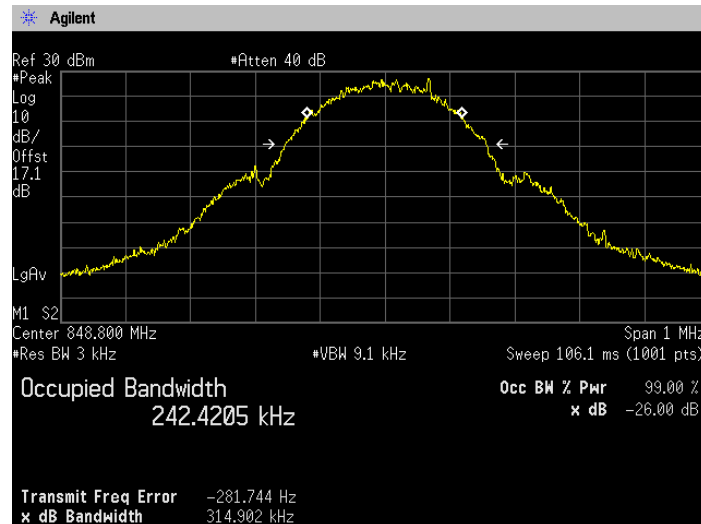



Zacta

**[WCDMA Band V]
Channel: 4132**

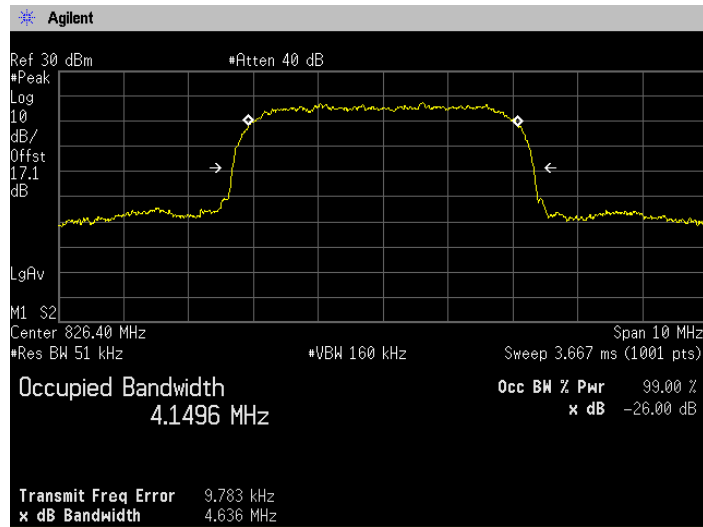

Channel: 4183

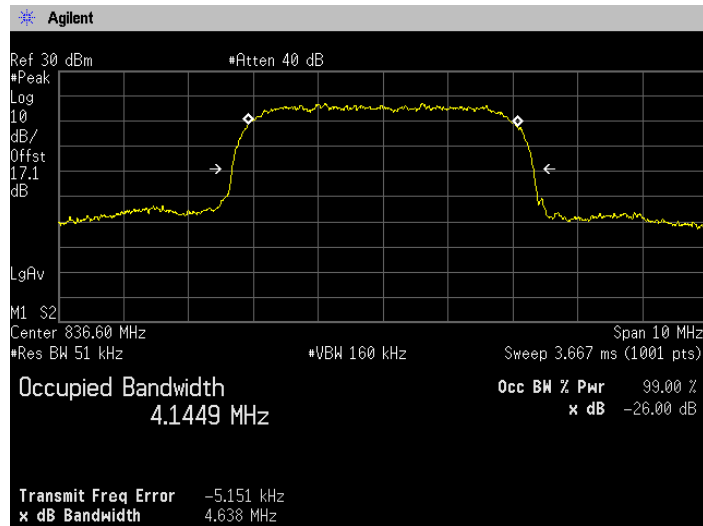

Channel: 4233

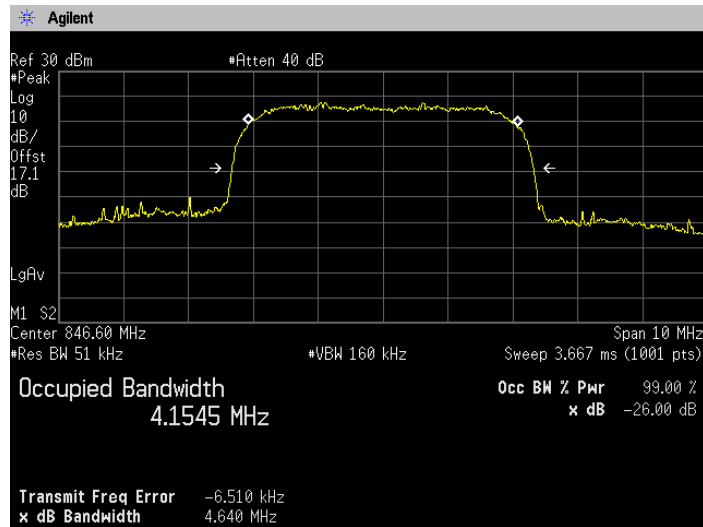



Zacta

**[LTE Band V]
Channel: 20525
QPSK, BW 1.4MHz, RB3-1**

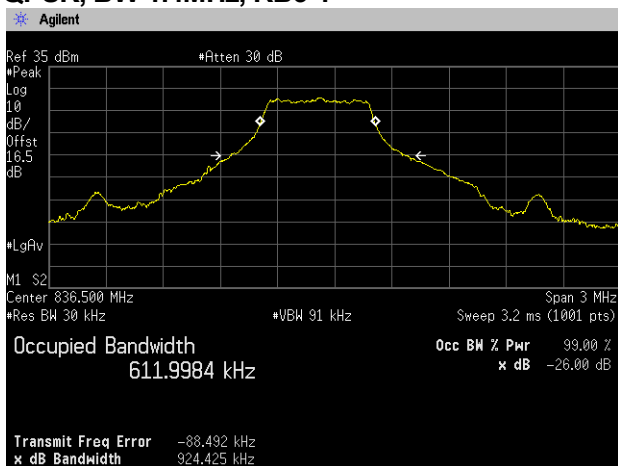

RB6-0

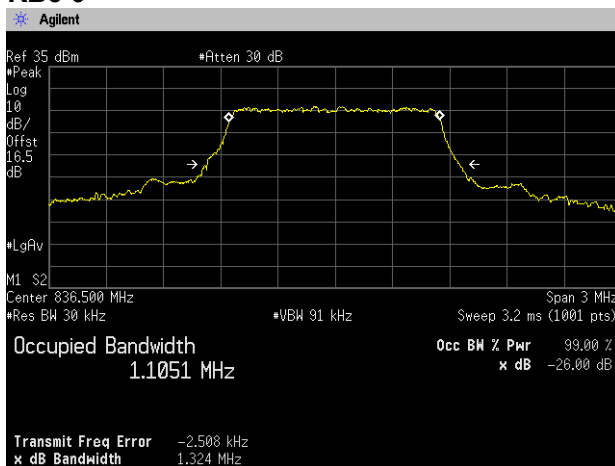

16QAM, BW 1.4MHz, RB3-1

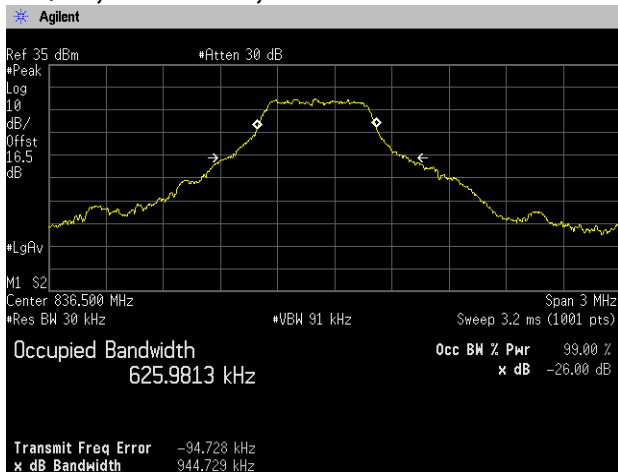

RB6-0

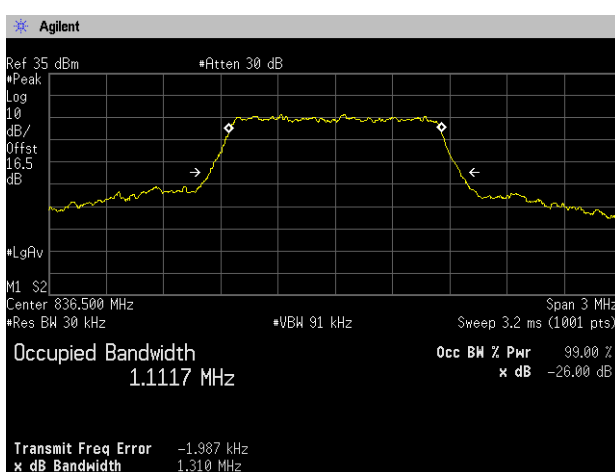



Zacta

QPSK, BW 3MHz, RB8-4

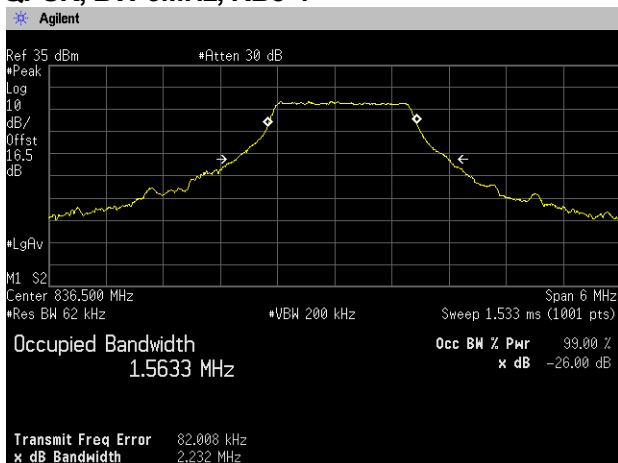

RB15-0

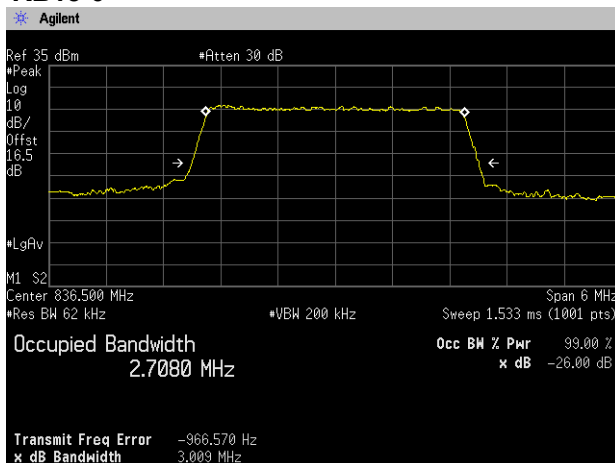

16QAM, BW 3MHz, RB8-4

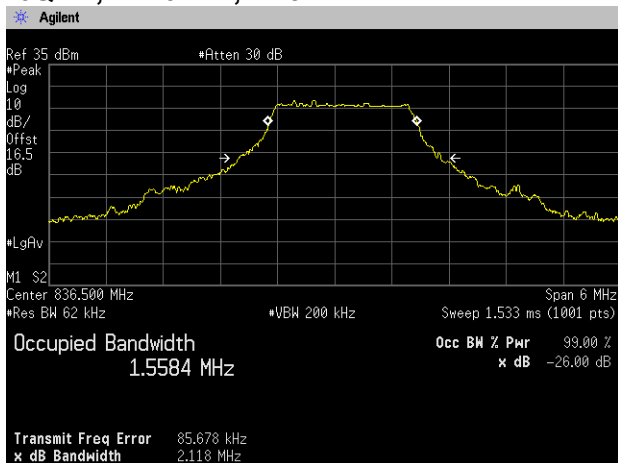

RB15-0

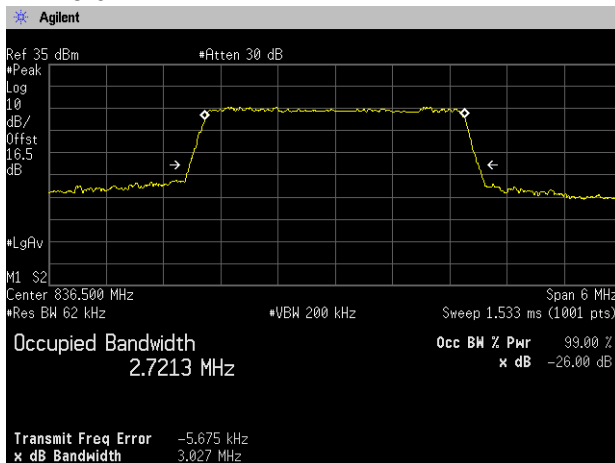



Zacta

QPSK, BW 5MHz, RB12-7

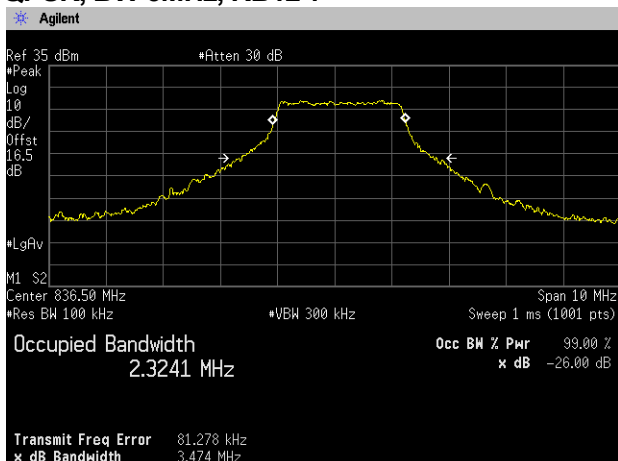

RB25-0

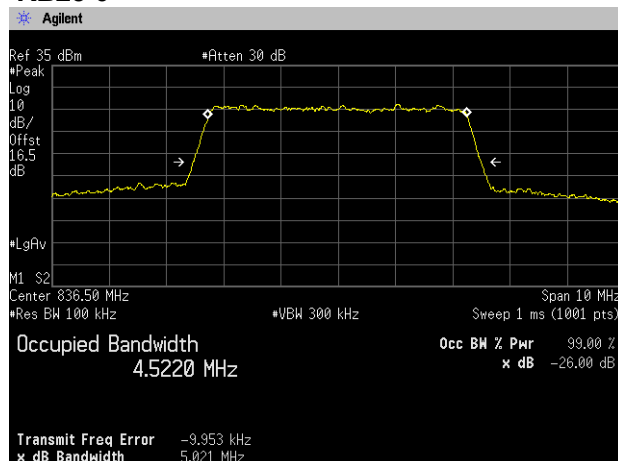

16QAM, BW 5MHz, RB12-7

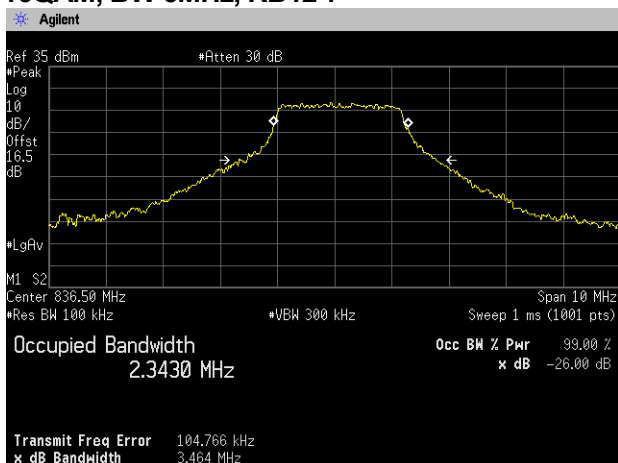

RB25-0

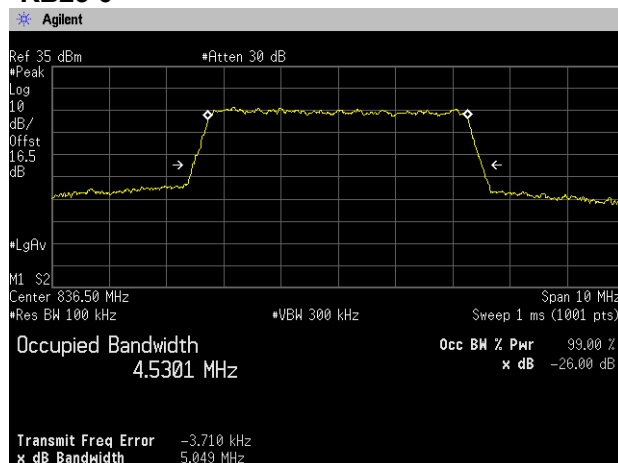



Zacta

QPSK, BW 10MHz, RB25-12

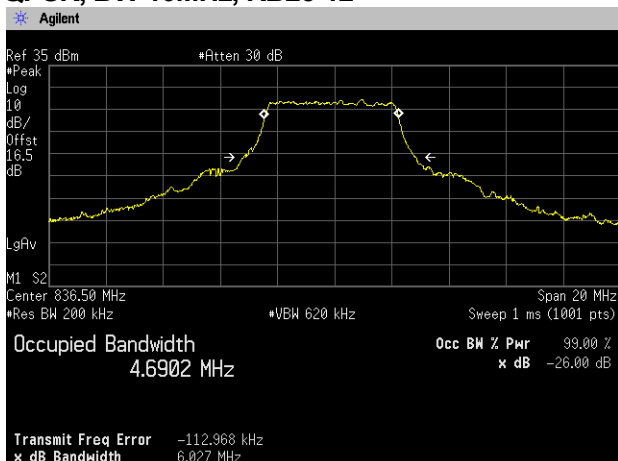

RB50-0

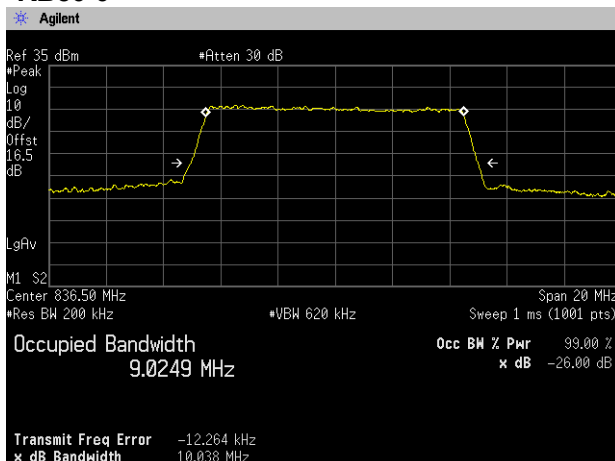

16QAM, BW 10MHz, RB25-12

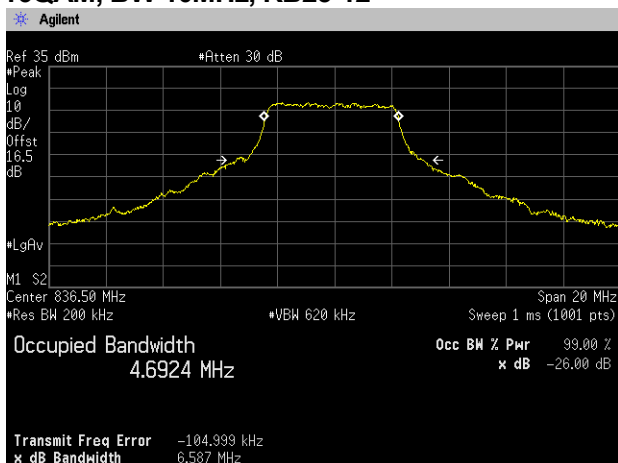

RB50-0

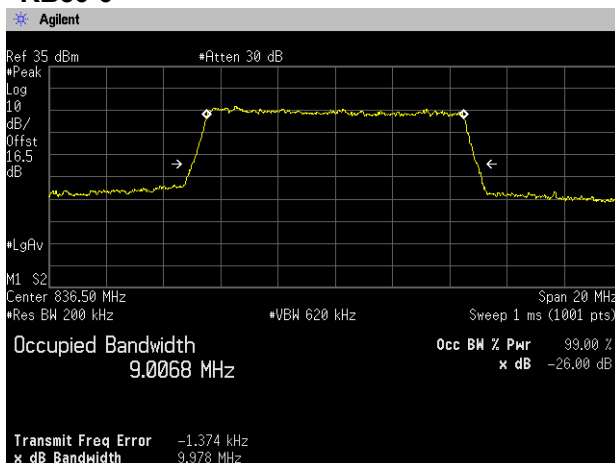

7. Band Edge Spurious and Harmonic at Antenna Terminals

7.1 Measurement procedure [FCC 22.917(a), 2.1051]

The band edge spurious and harmonic was measured with a spectrum analyzer connected to the antenna terminal.

The spectrum analyzer is set to;
<Band Edge>

- a) Span was set large enough so as to capture all out of band emissions near the band edge
- b) RBW \geq 1% of the emission bandwidth or 2% of the emission bandwidth
- c) VBW \geq 3 x RBW
- d) Detector = RMS
- e) Trace mode = Max hold
- f) Sweep time = auto-couple
- g) Number of sweep point \geq 2 x span / RBW

<Spurious Emissions>

- a) RBW = 1MHz & VBW \geq 3 x RBW
- b) Detector = Peak
- c) Trace mode = Max hold
- d) Sweep time = auto-couple
- e) Number of sweep point \geq 2 x span / RBW

- Test configuration

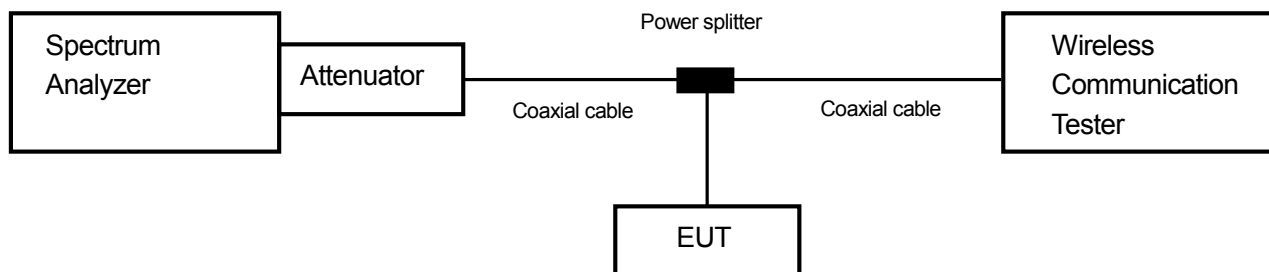

7.2 Limit

-13dBm or less

7.3 Measurement result

Date : October 2, 2015
 Temperature : 24.4 [°C]
 Humidity : 45.6 [%]
 Test place : Shielded room No.4

Test engineer : Kazunori Saito

Band	Channel	Frequency [MHz]	Limit [dB]	Results	
GSM850	128	824.2	-13.0	See the trace data	PASS
	190	836.6	-13.0	See the trace data	PASS
	251	848.8	-13.0	See the trace data	PASS
WCDMA Band V	4132	826.4	-13.0	See the trace data	PASS
	4183	836.6	-13.0	See the trace data	PASS
	4233	846.6	-13.0	See the trace data	PASS

Date : October 8, 2015
 Temperature : 21.7 [°C]
 Humidity : 48.3 [%]
 Test place : Shielded room No.4

Test engineer : Hikaru Shibata

Band	Modulation	Bandwidth	Limit [dB]	Results	
LTE Band V	QPSK	1.4MHz	-13.0	See the trace data	PASS
		3MHz	-13.0	See the trace data	PASS
		5MHz	-13.0	See the trace data	PASS
		10MHz	-13.0	See the trace data	PASS
	16QAM	1.4MHz	-13.0	See the trace data	PASS
		3MHz	-13.0	See the trace data	PASS
		5MHz	-13.0	See the trace data	PASS
		10MHz	-13.0	See the trace data	PASS



Zacta

**7.4 Trace data
[GSM850]
(Band Edge)**

Channel: 128

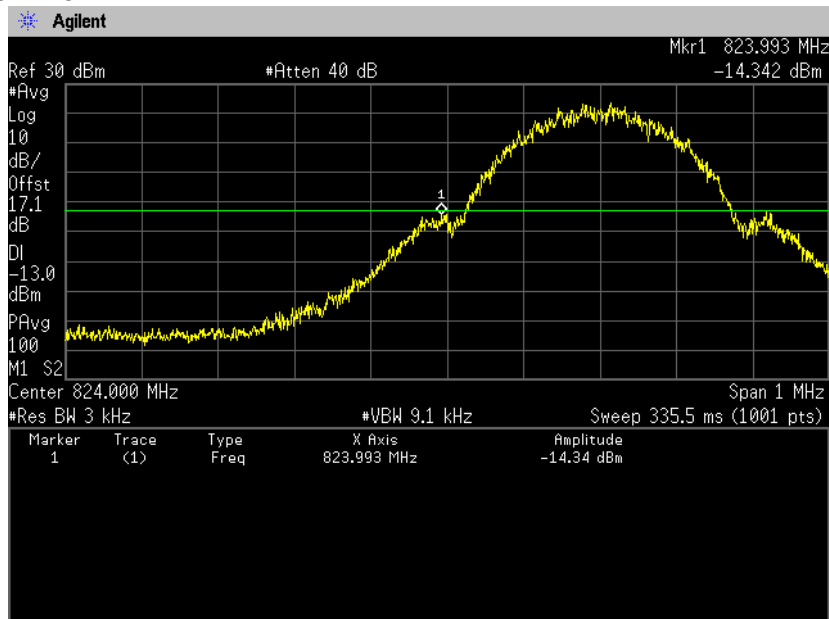

Channel: 251

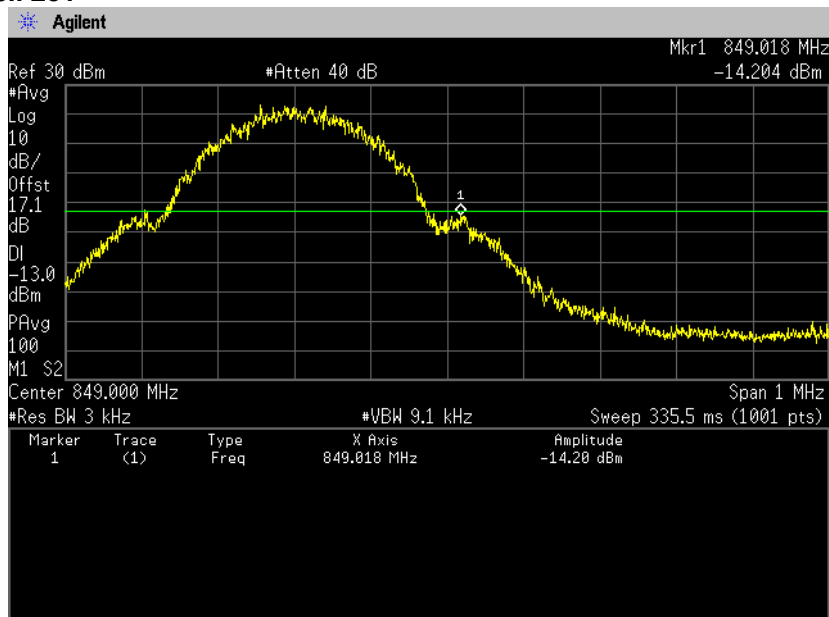

(Spurious Emissions)

Note: Conducted spurious test was measured in the worst case of conducted output power.

**Channel: 128
30MHz-5GHz**

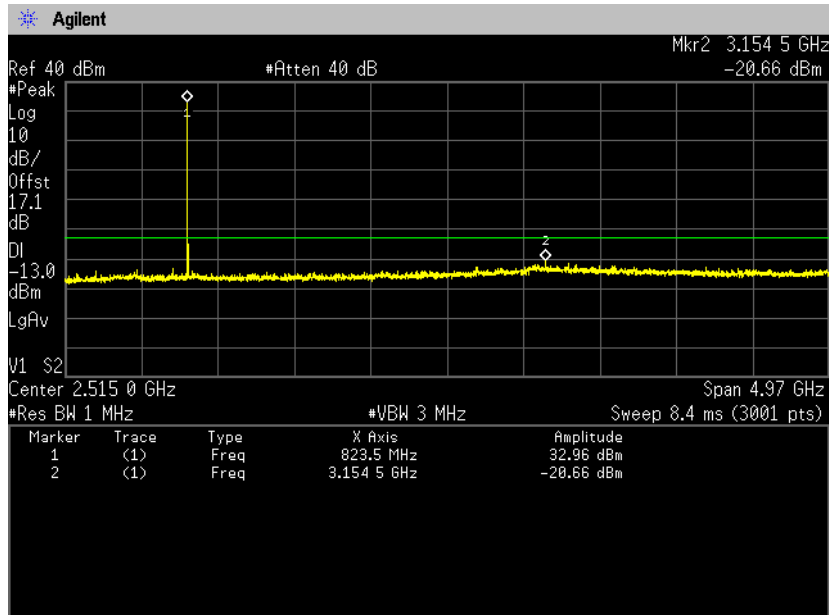

5GHz-10GHz

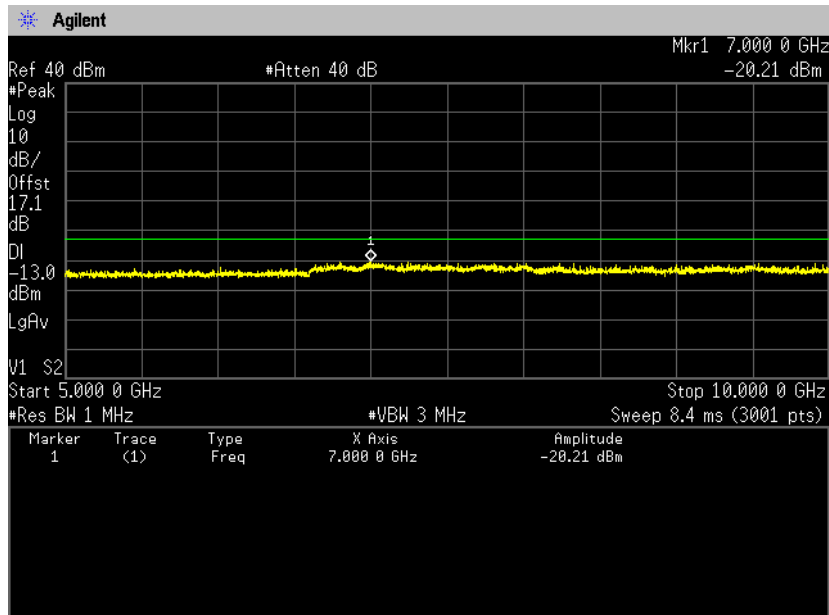



Zacta

**Channel: 190
30MHz-5GHz**

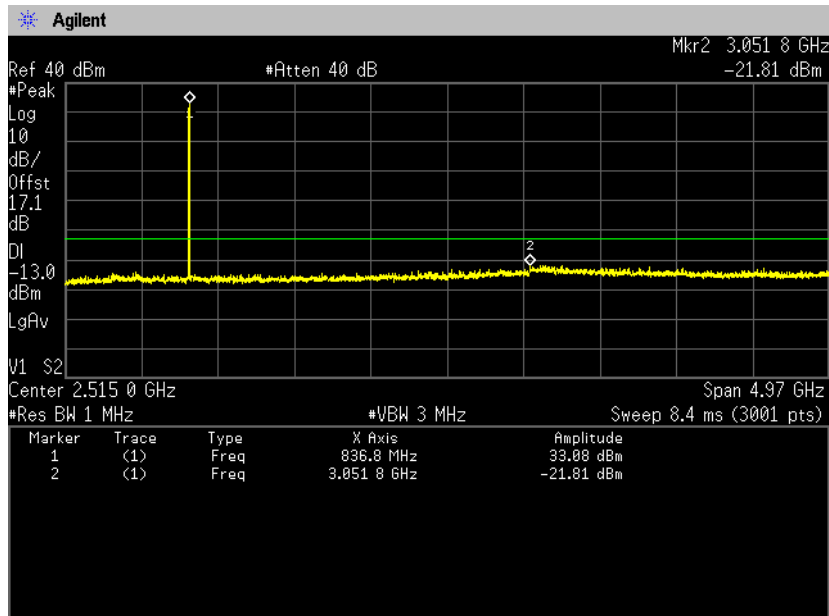

5GHz-10GHz

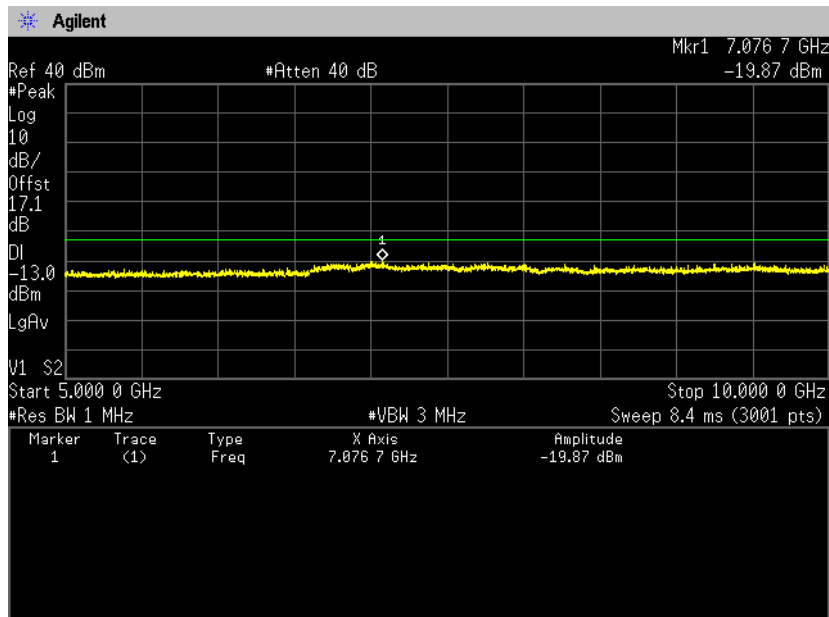



Zacta

Channel: 251 30MHz-5GHz

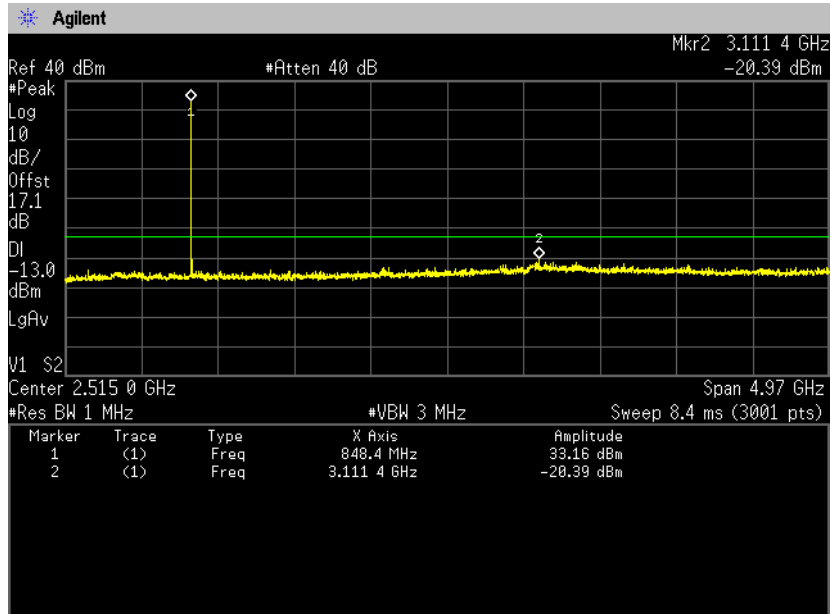

5GHz-10GHz

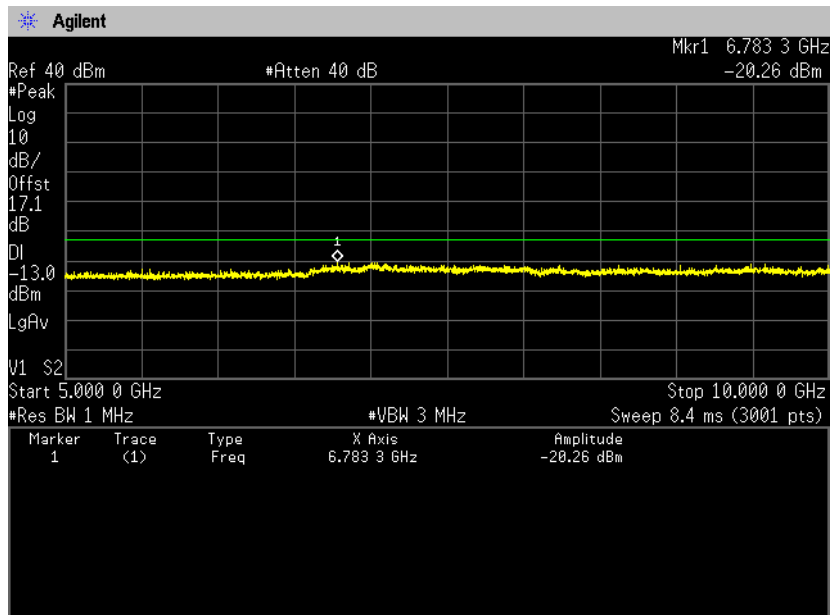



Zacta

**[WCDMA Band V
(Band Edge)
Channel: 4132**

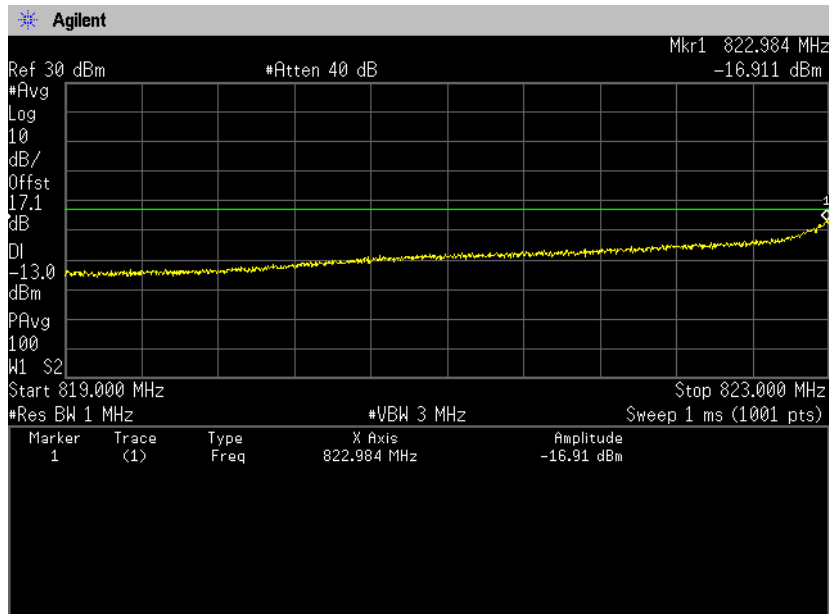
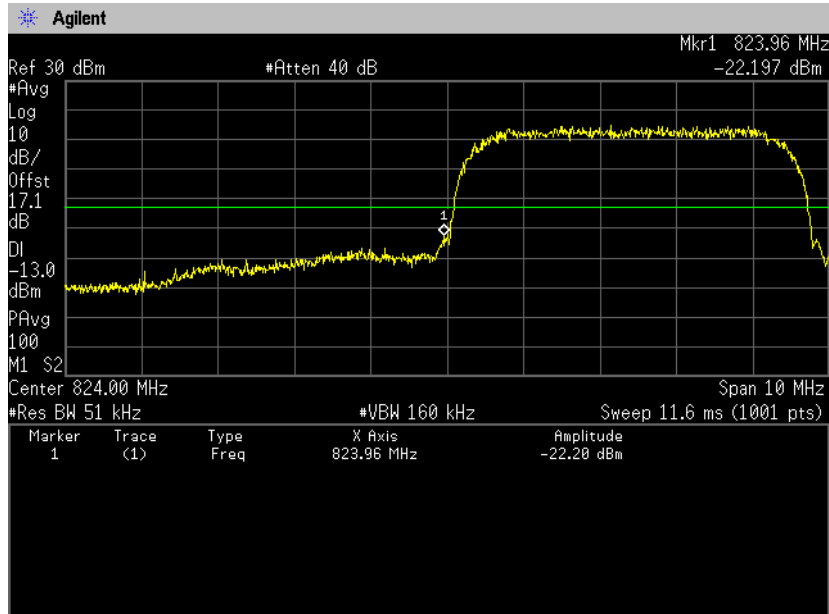

Channel: 4233

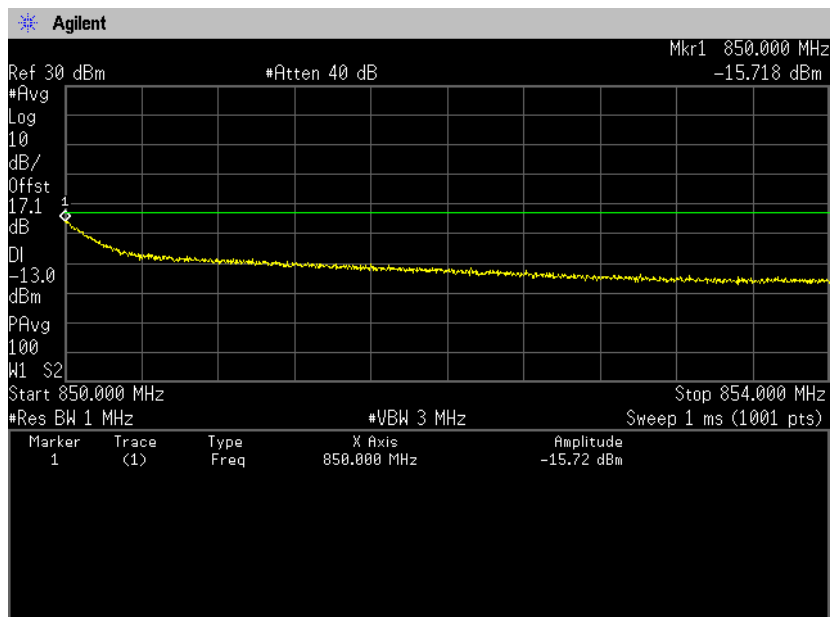
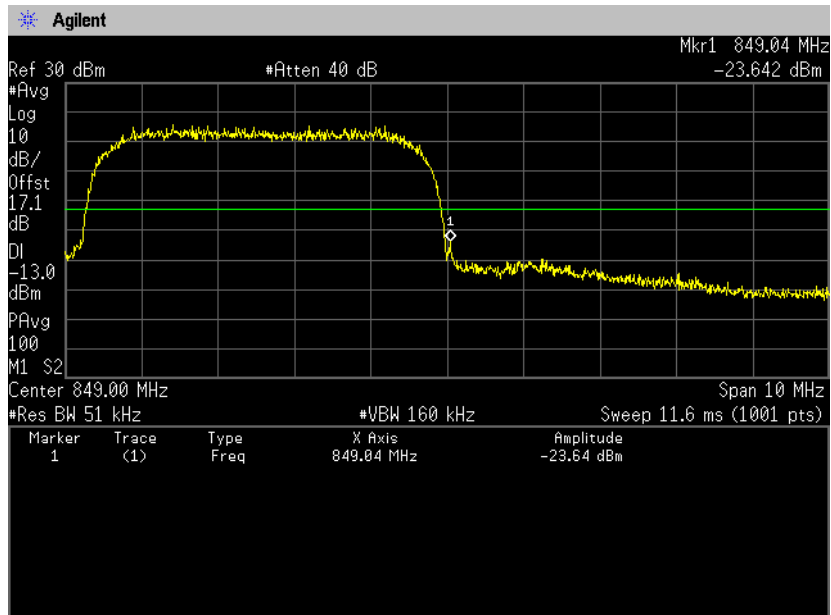

(Spurious Emissions)

Note: Conducted spurious test was measured in the worst case of conducted output power.

**Channel: 4132
30MHz-5GHz**

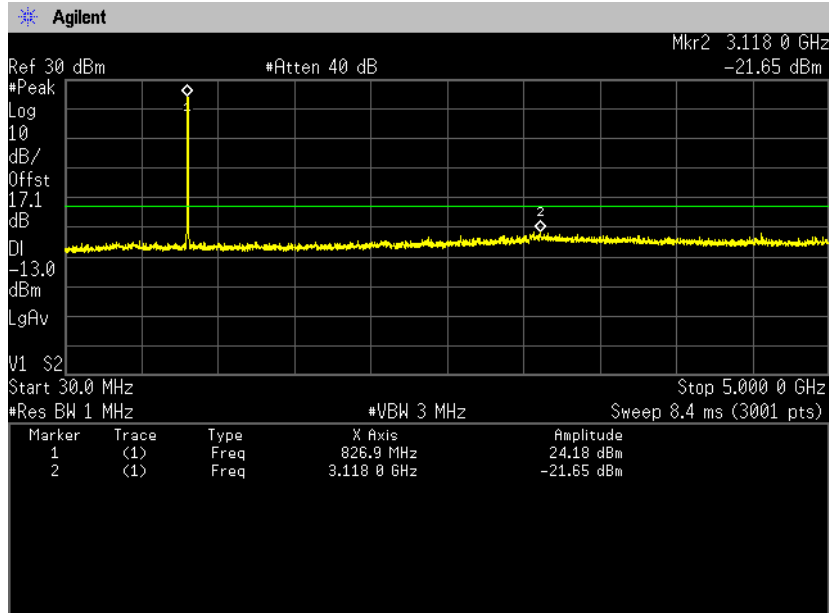

5GHz-10GHz

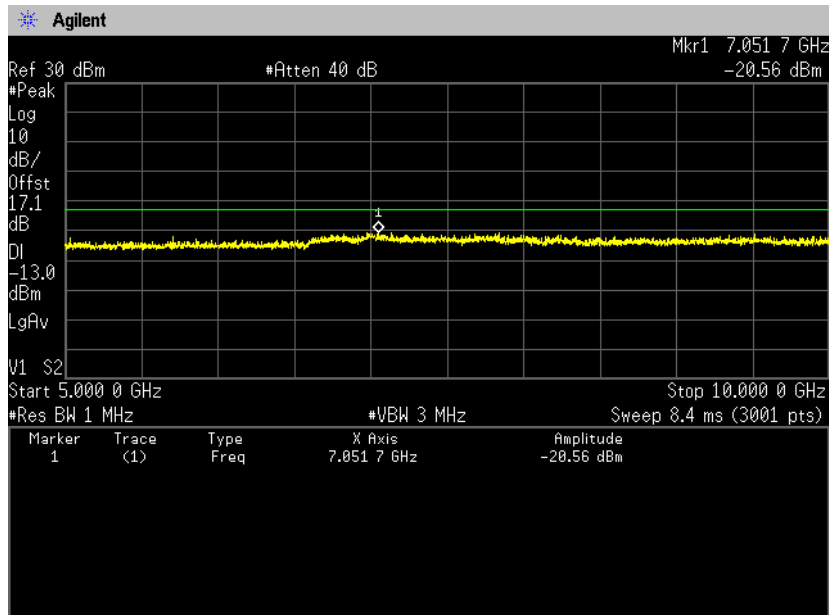



Zacta

**Channel: 4183
30MHz-5GHz**

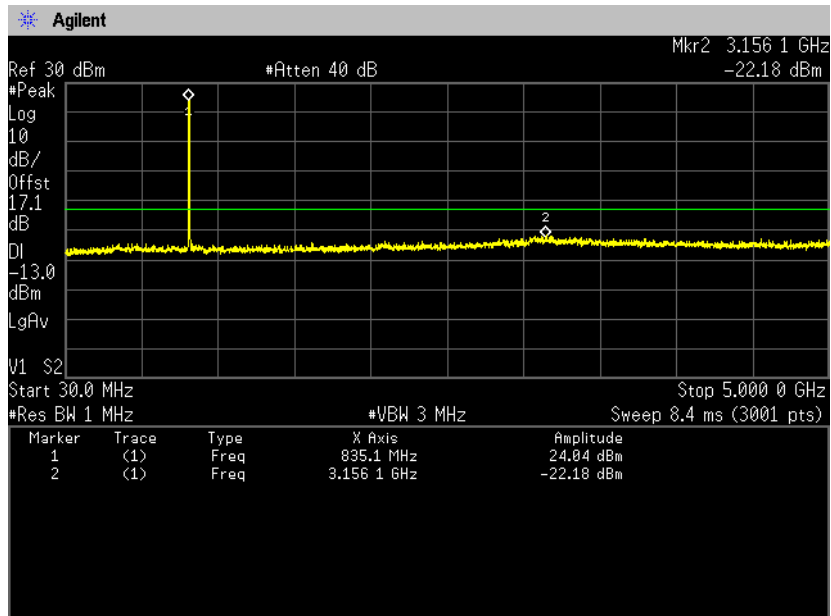

5GHz-10GHz

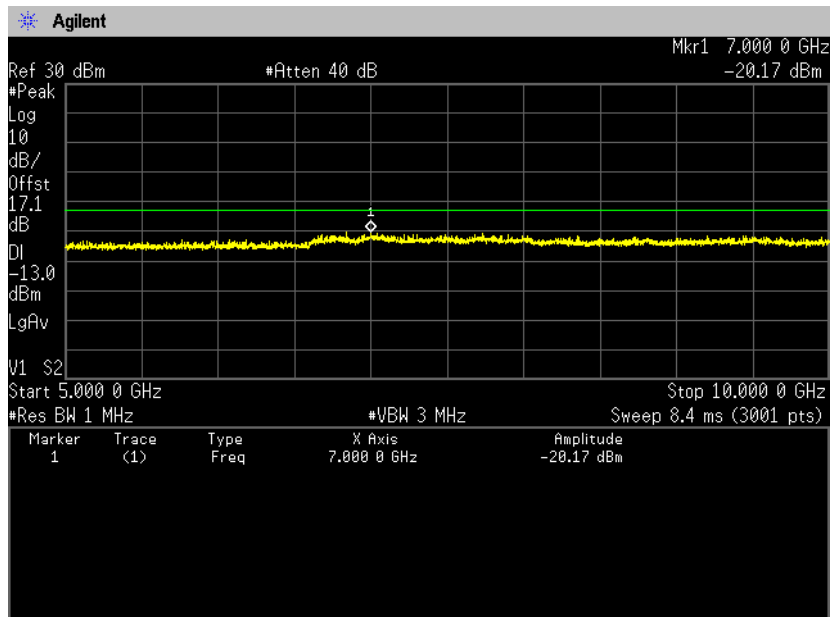



Zacta

**Channel: 4233
30MHz-5GHz**

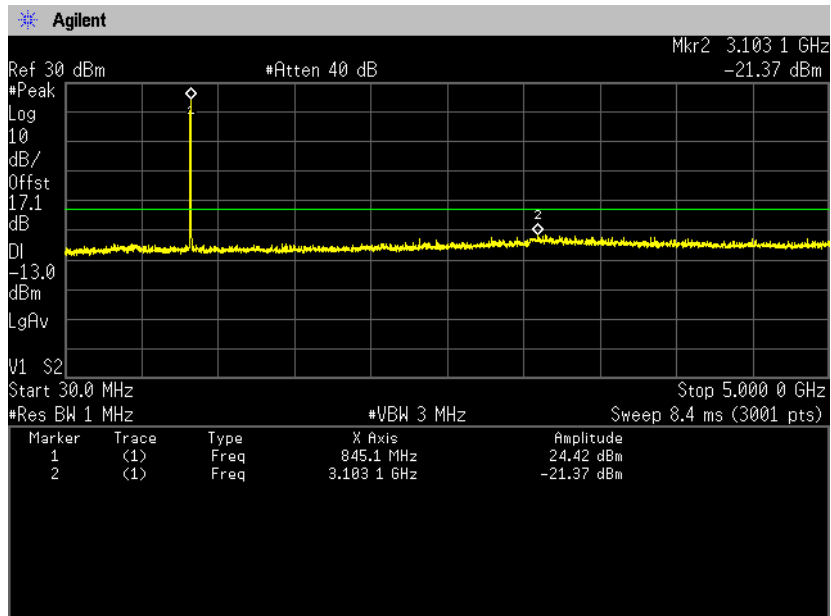

5GHz-10GHz

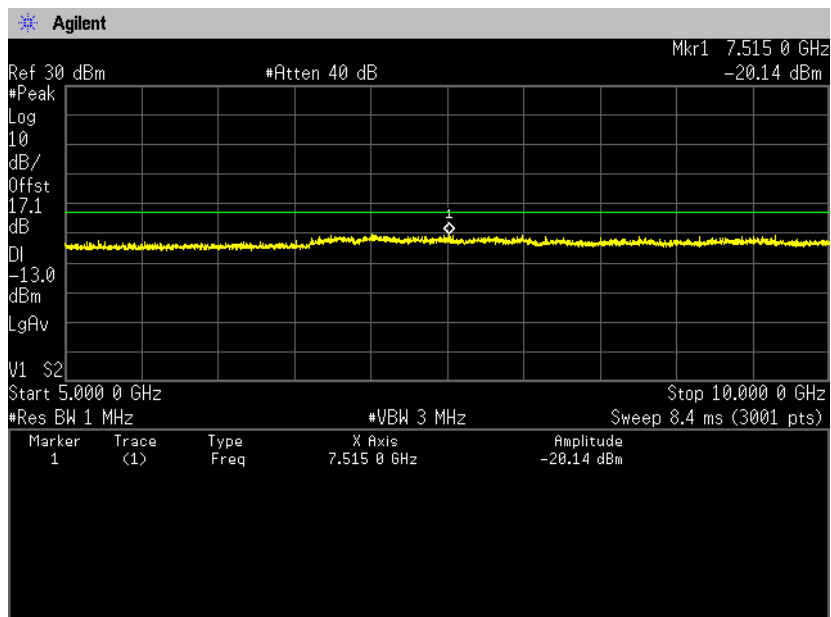

**[LTE Band V]
(Band Edge)
QPSK, BW 1.4MHz, RB1-0
Channel: Low**

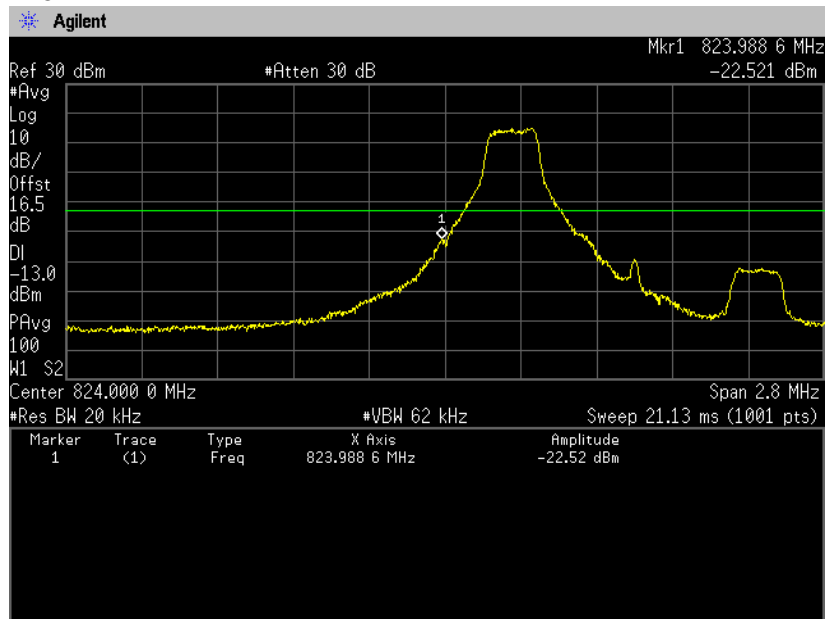

**QPSK, BW 1.4MHz, RB1-5
Channel: High**

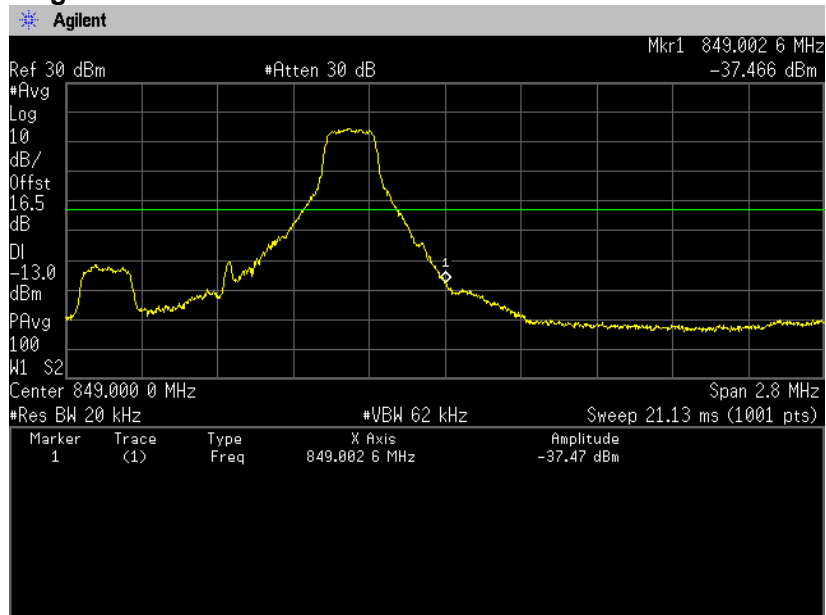



Zacta

QPSK, BW 1.4MHz, RB6-0
Channel: Low

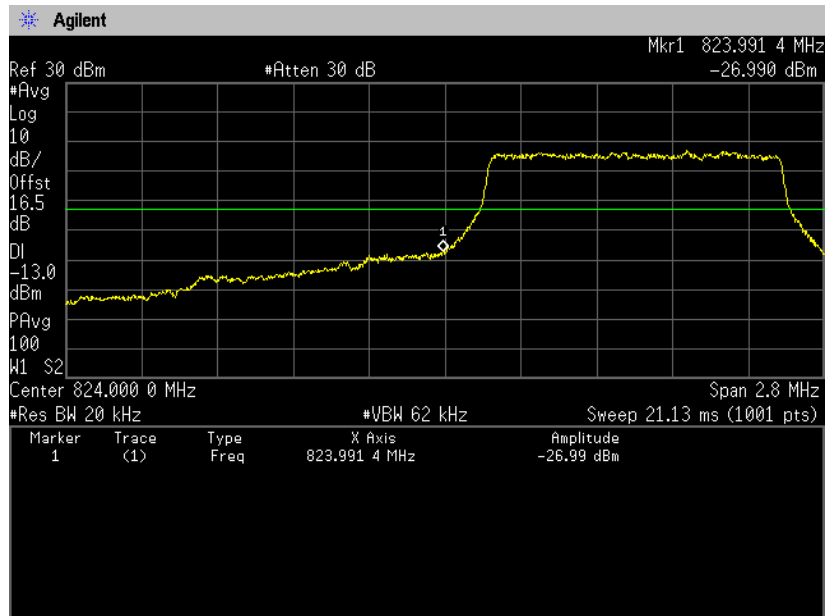

QPSK, BW 1.4MHz, RB6-0
Channel: High

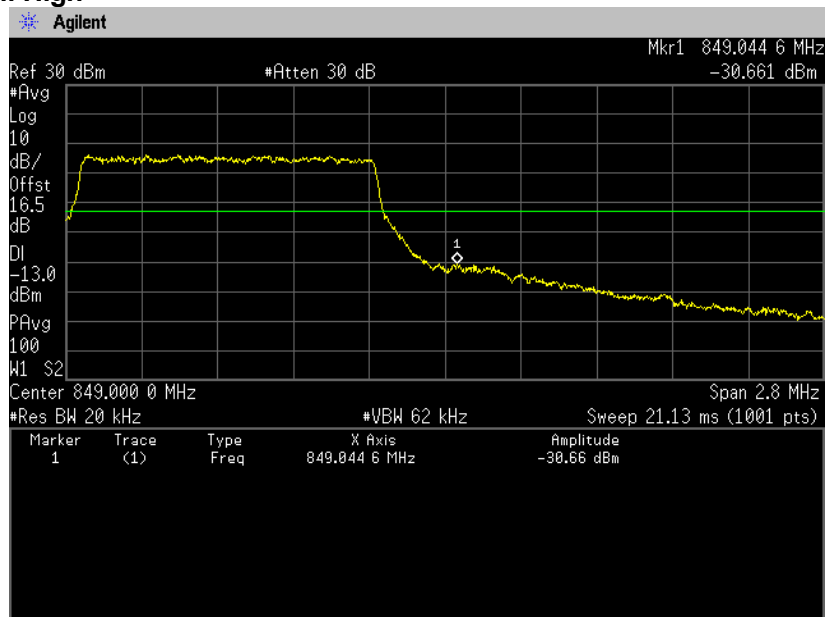



Zacta

16QAM, BW 1.4MHz, RB1-0 Channel: Low

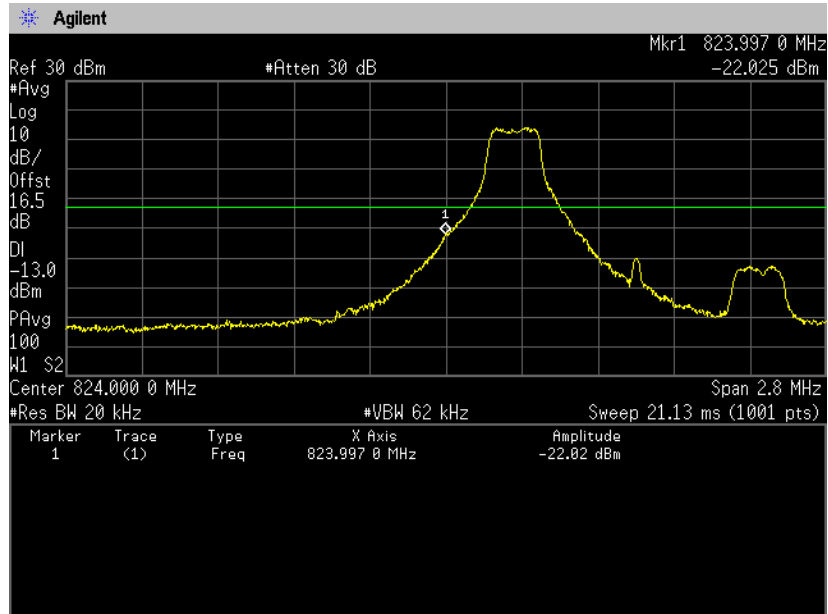

16QAM, BW 1.4MHz, RB1-5 Channel: High

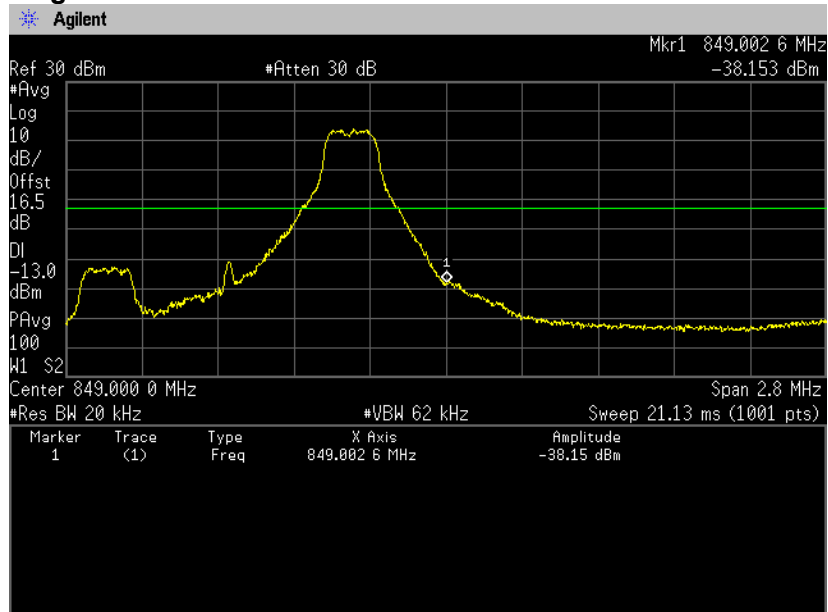



Zacta

16QAM, BW 1.4MHz, RB6-0
Channel: Low

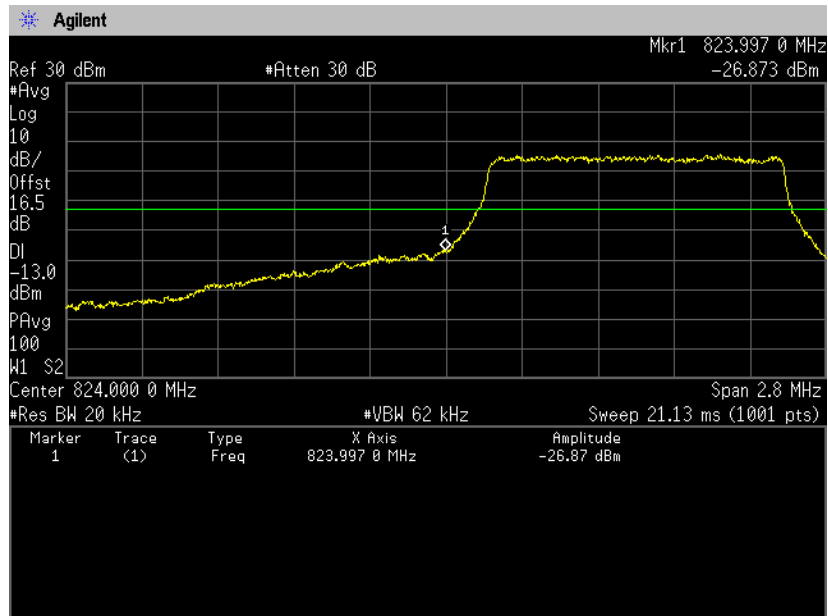

16QAM, BW 1.4MHz, RB6-0
Channel: High

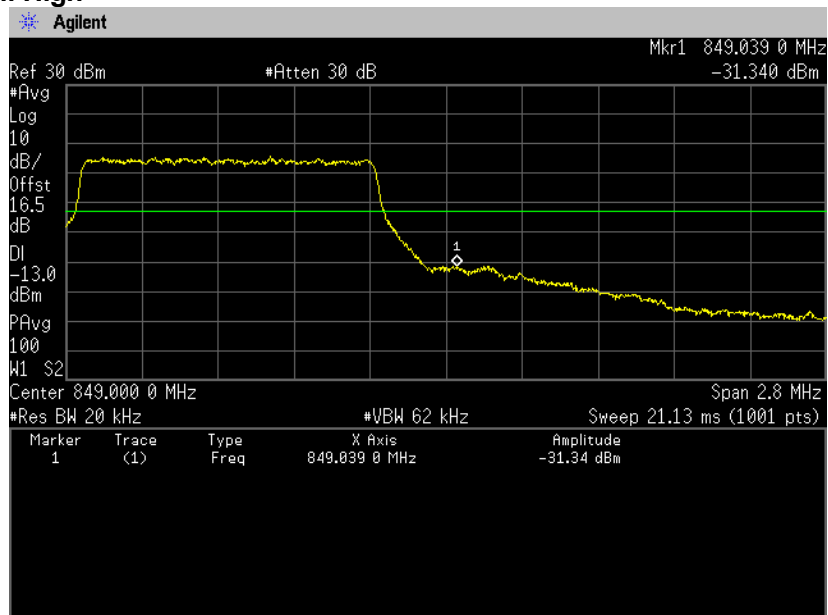



Zacta

QPSK, BW 3MHz, RB1-0
Channel: Low

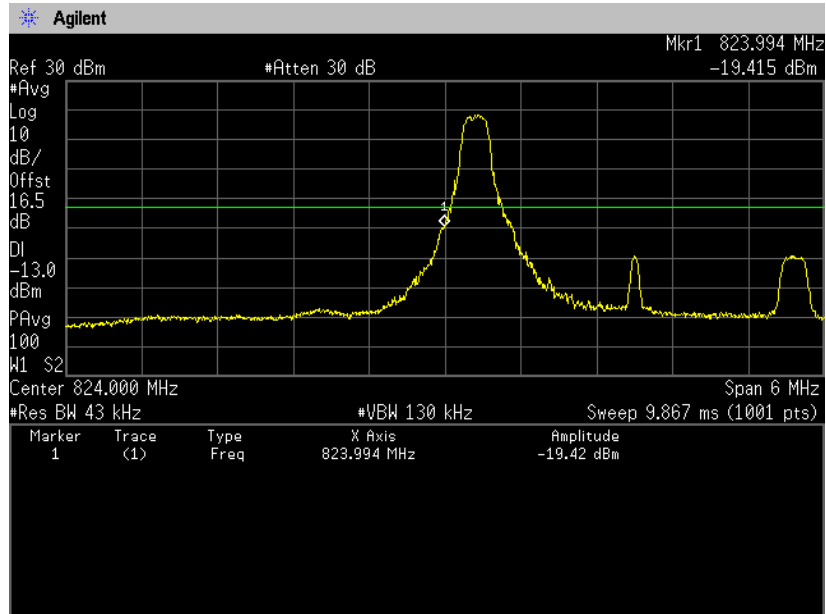

QPSK, BW 3MHz, RB1-14
Channel: High

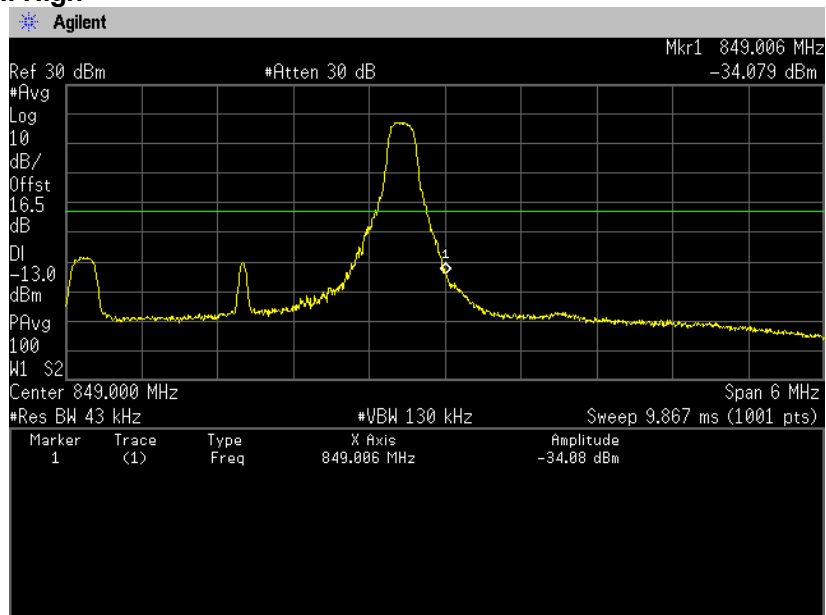

QPSK, BW 3MHz, RB15-0
Channel: Low

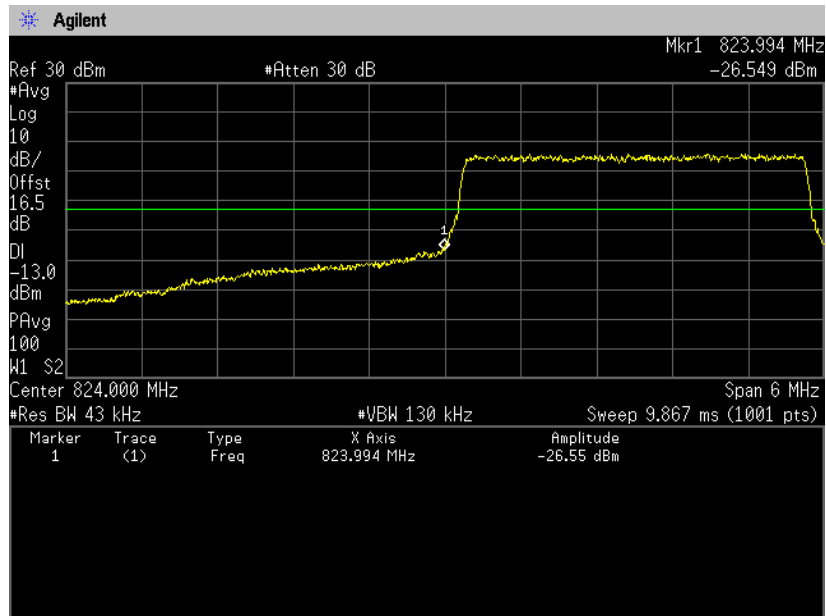

QPSK, BW 3MHz, RB15-0
Channel: High

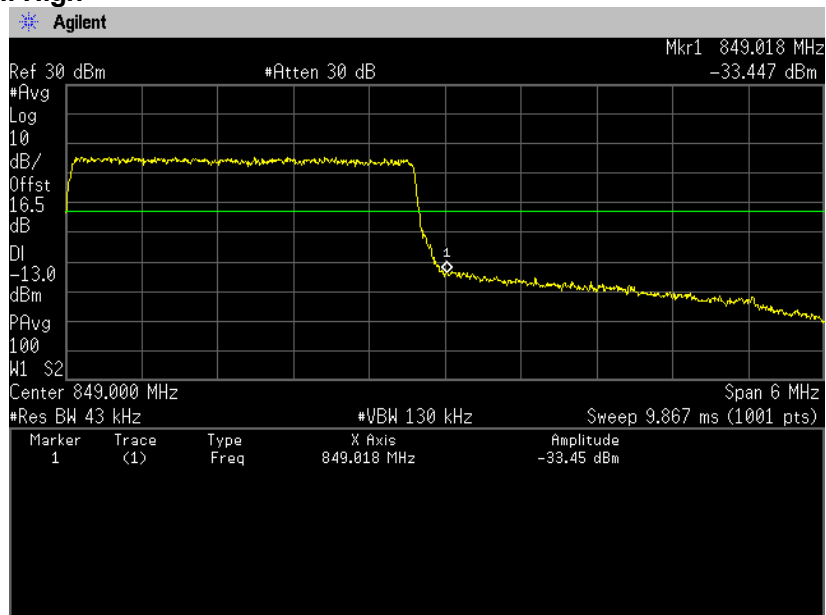



Zacta

16QAM, BW 3MHz, RB1-0
Channel: Low

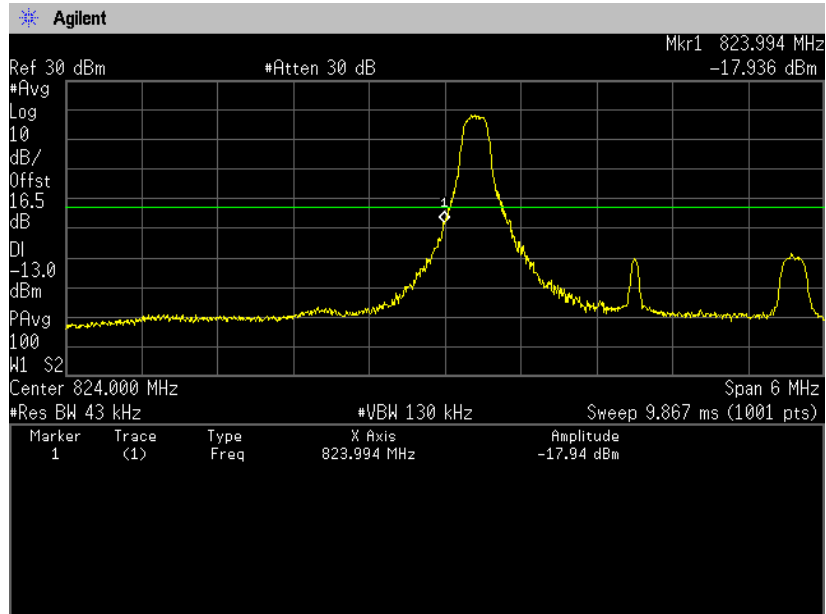

16QAM, BW 3MHz, RB1-14
Channel: High

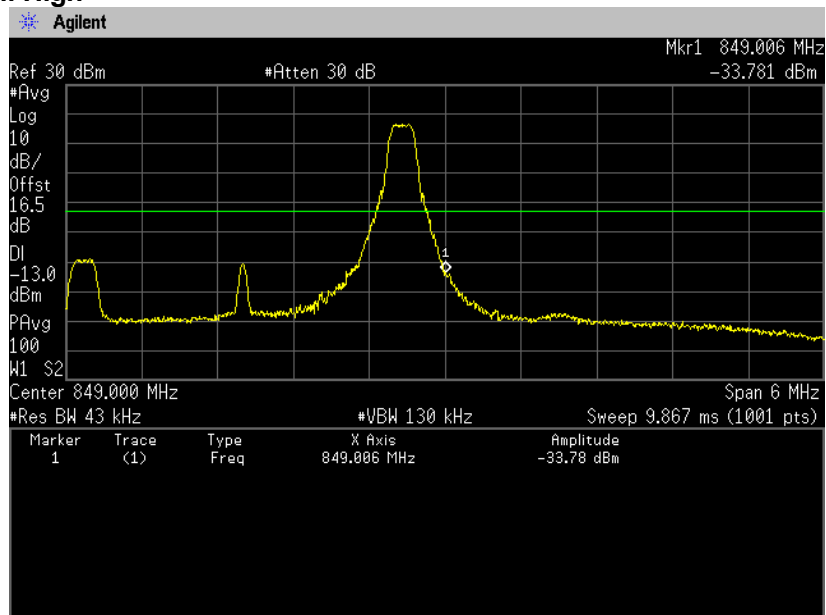

16QAM, BW 3MHz, RB15-0
Channel: Low

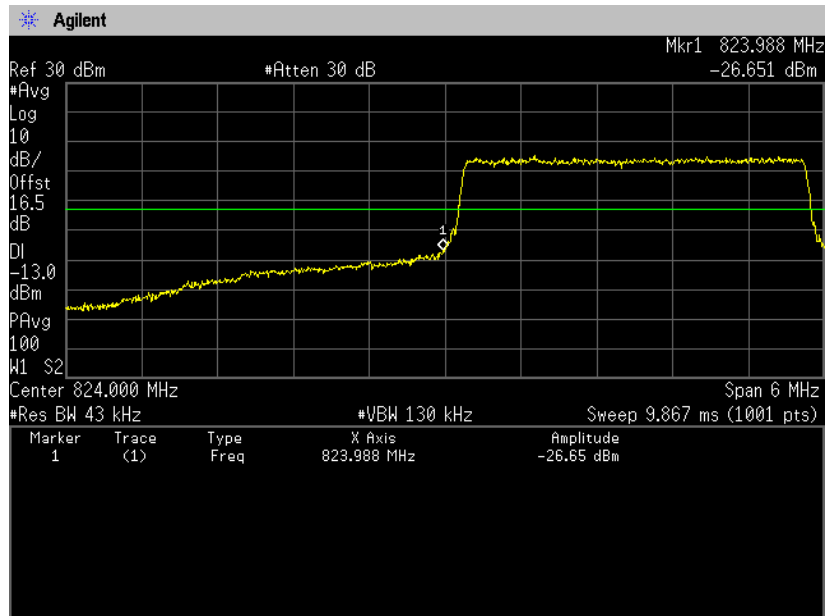

16QAM, BW 3MHz, RB15-0
Channel: High

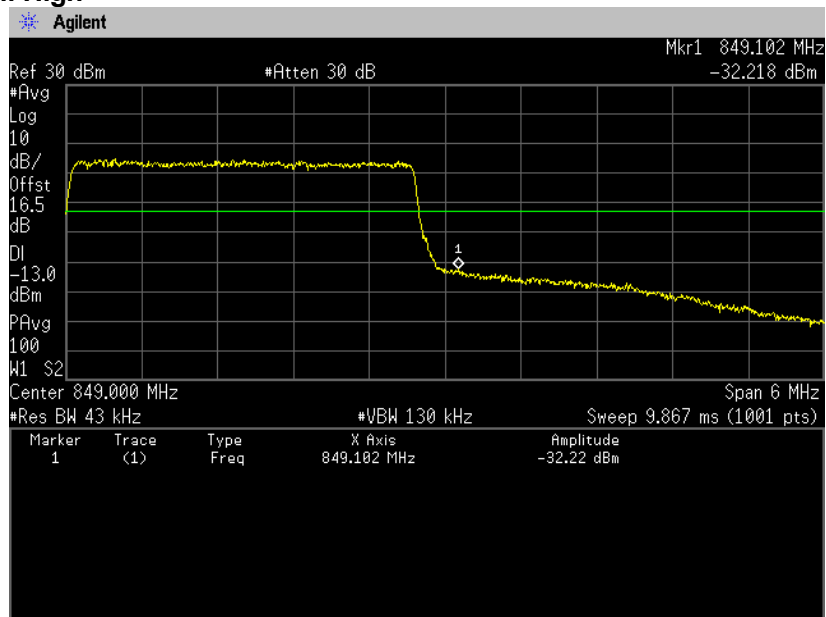



Zacta

QPSK, BW 5MHz, RB1-0
Channel: Low

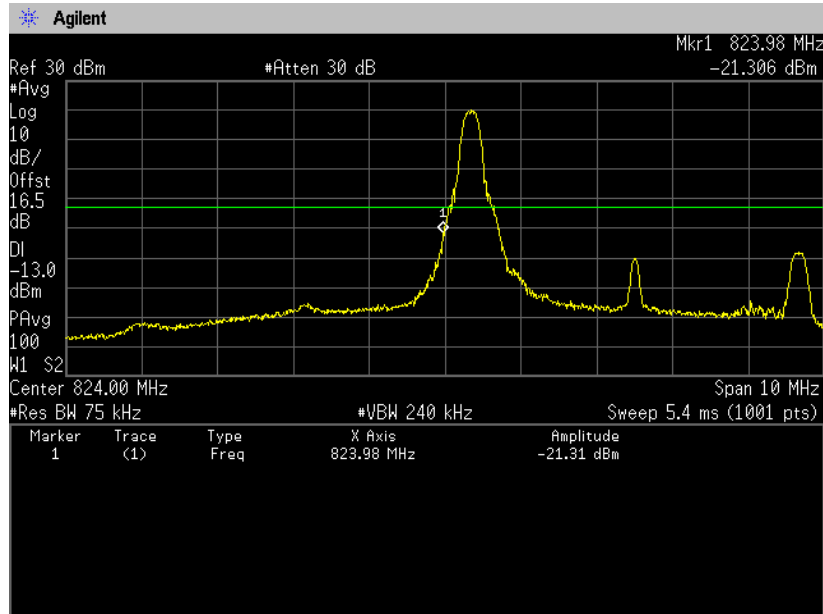

QPSK, BW 5MHz, RB1-24
Channel: High

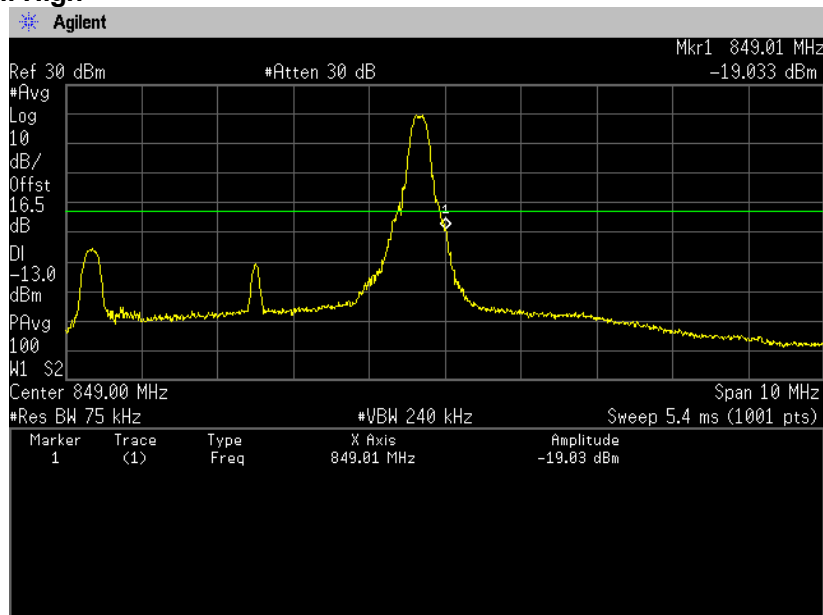

QPSK, BW 5MHz, RB25-0
Channel: Low

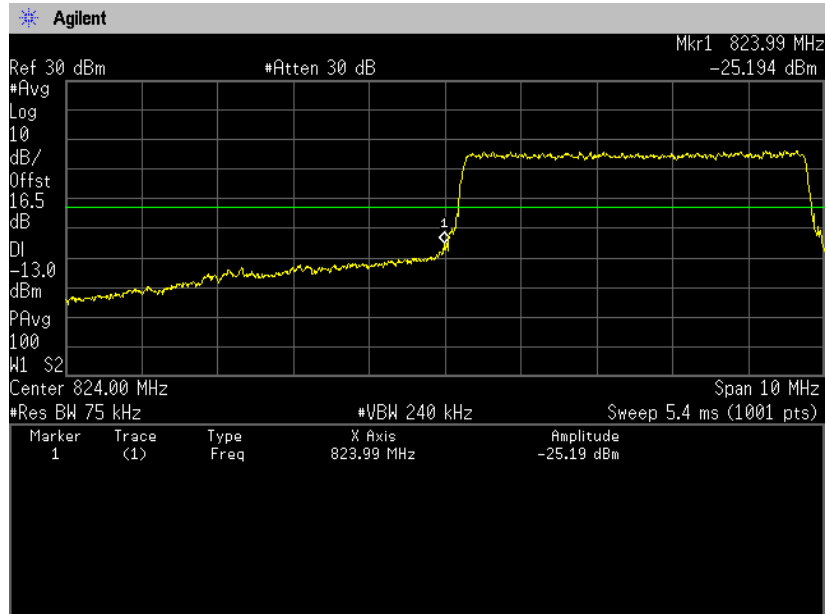

QPSK, BW 5MHz, RB25-0
Channel: High

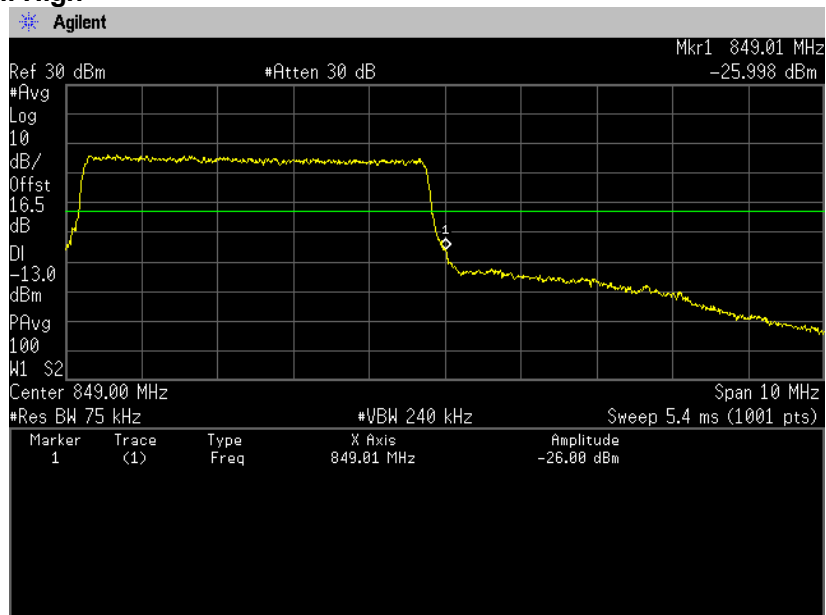



Zacta

16QAM, BW 5MHz, RB1-0
Channel: Low

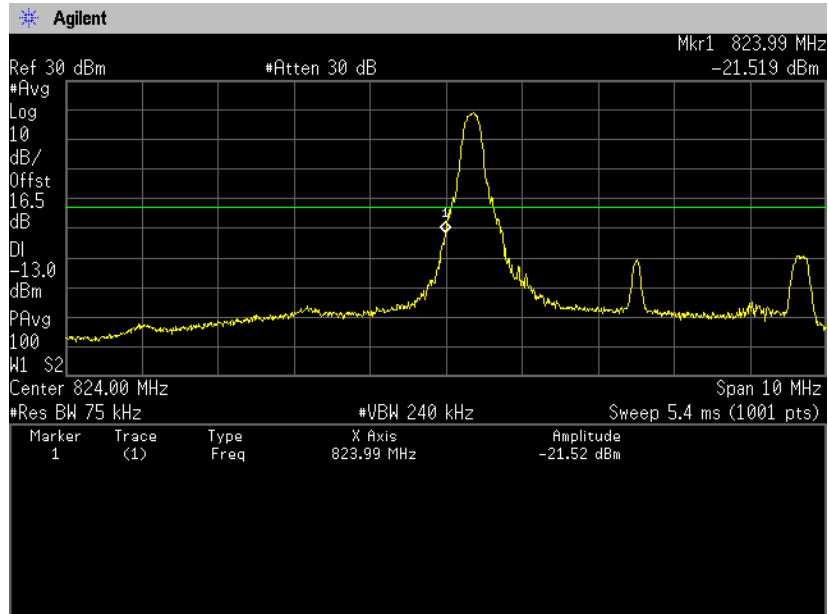

16QAM, BW 5MHz, RB1-24
Channel: High

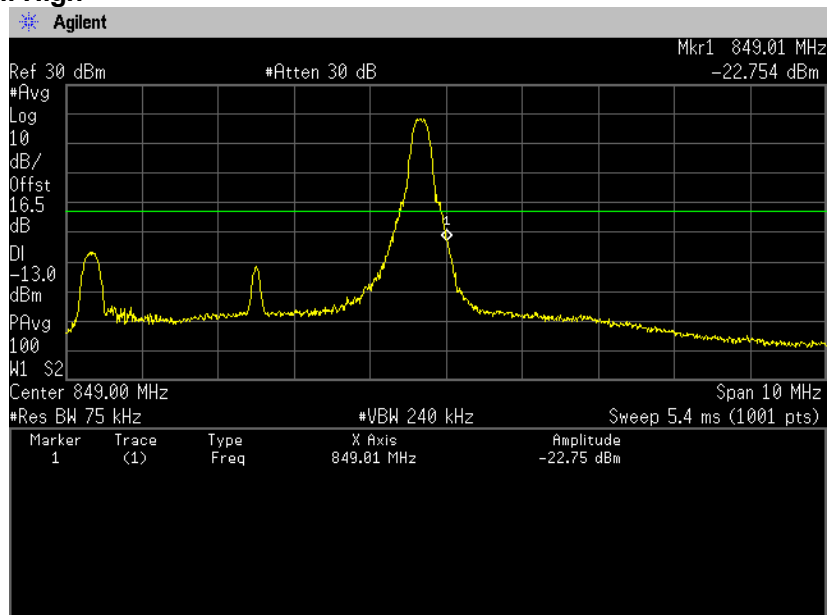



Zacta

16QAM, BW 5MHz, RB25-0
Channel: Low

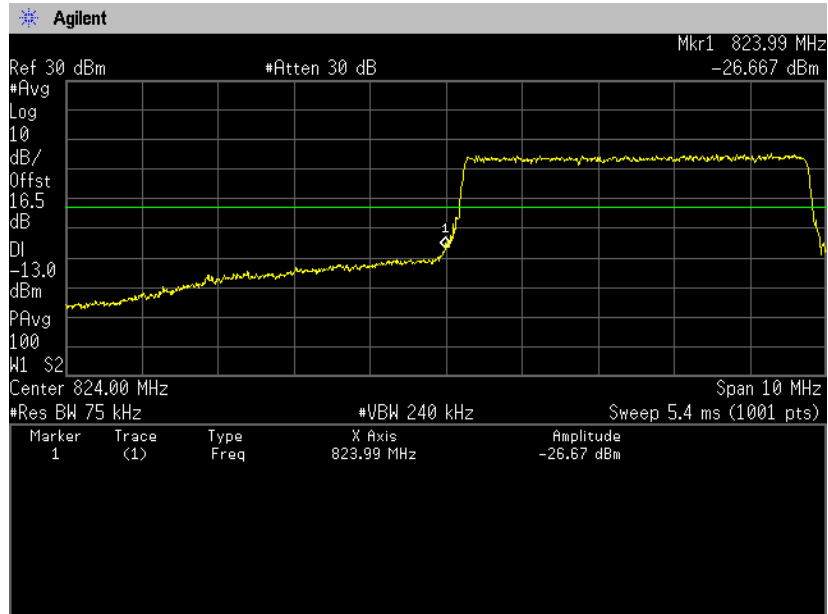

16QAM, BW 5MHz, RB25-0
Channel: High

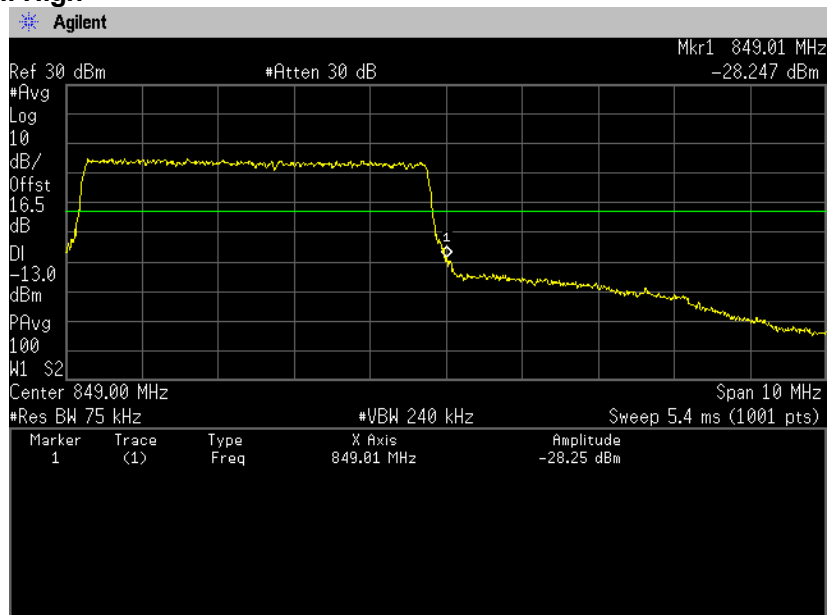



Zacta

QPSK, BW 10MHz, RB1-0
Channel: Low

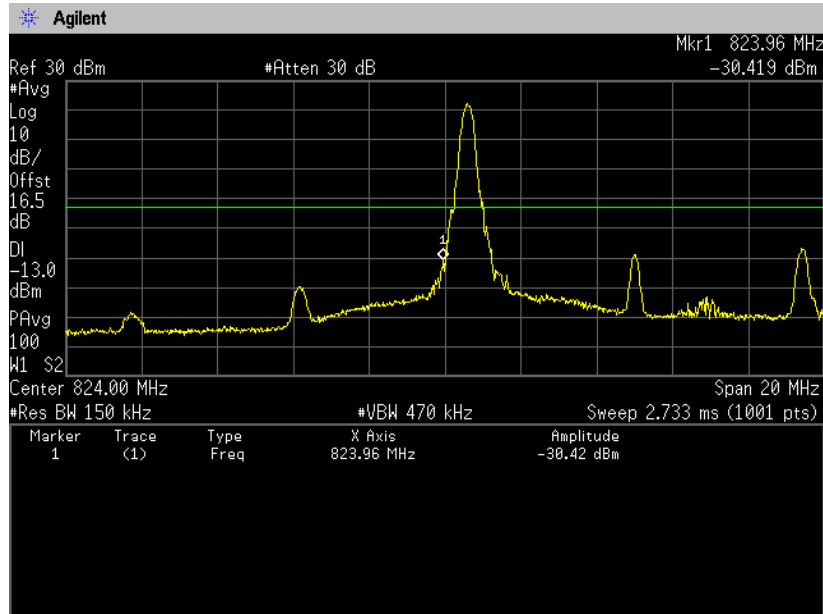

QPSK, BW 10MHz, RB1-49
Channel: High

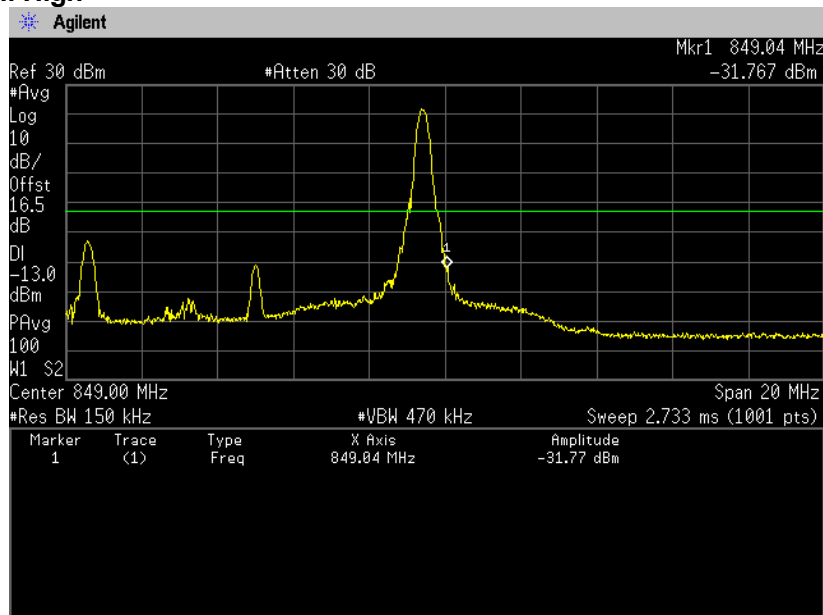



Zacta

QPSK, BW 10MHz, RB50-0
Channel: Low

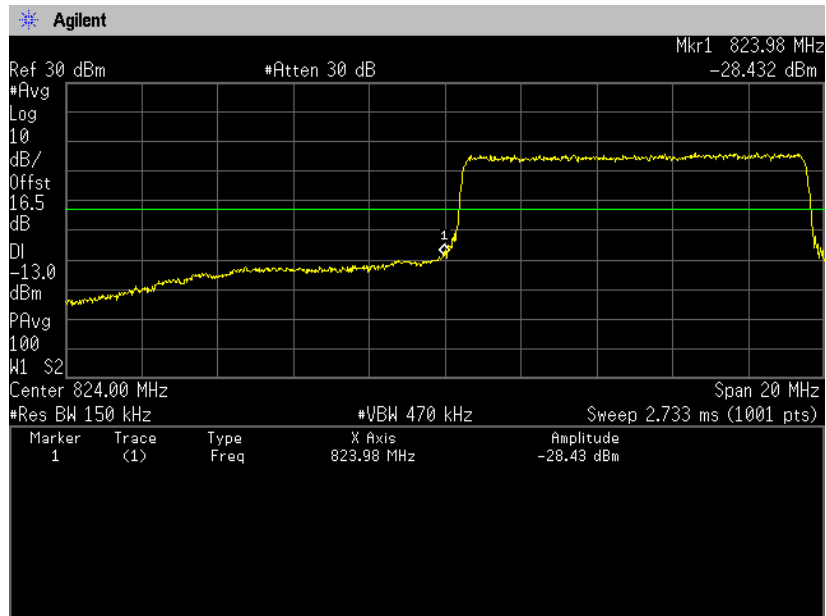

QPSK, BW 10MHz, RB50-0
Channel: High

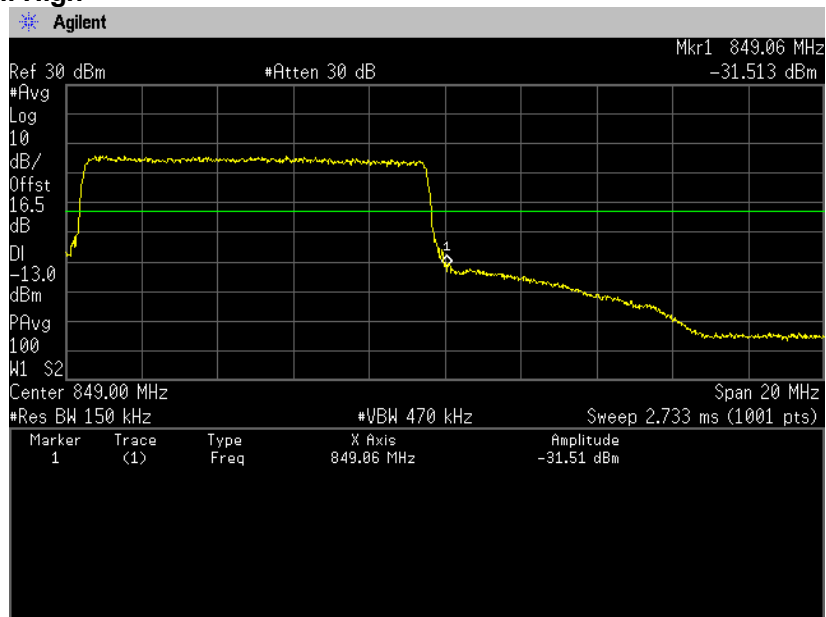



Zacta

16QAM, BW 10MHz, RB1-0
Channel: Low

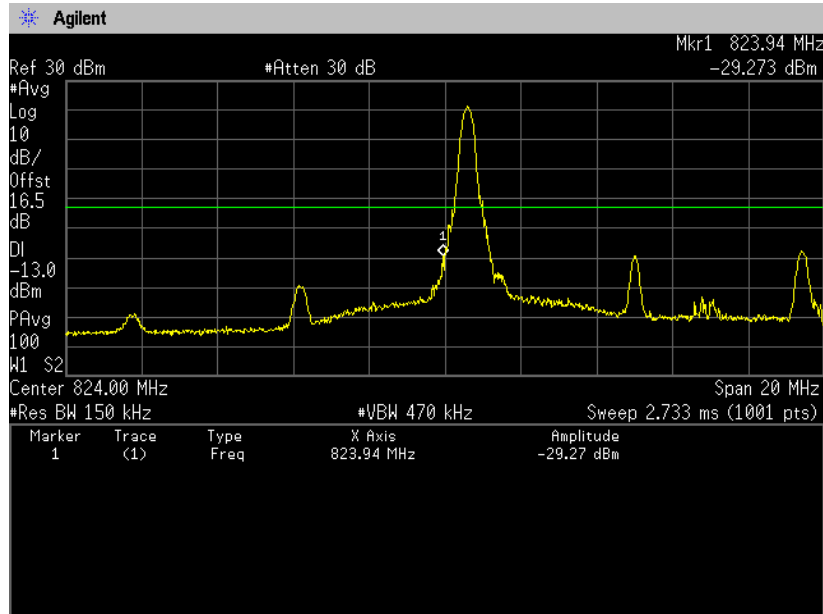

16QAM, BW 10MHz, RB1-49
Channel: High

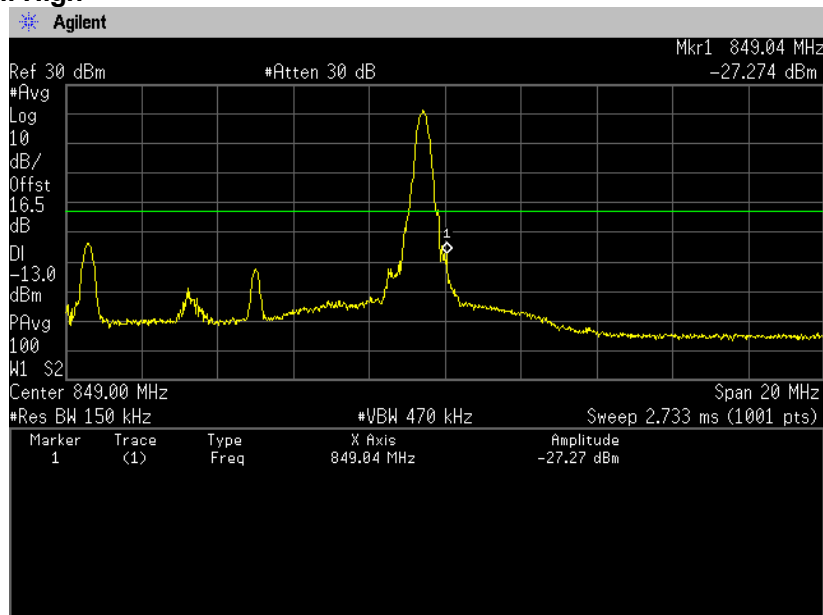



Zacta

16QAM, BW 10MHz, RB50-0
Channel: Low

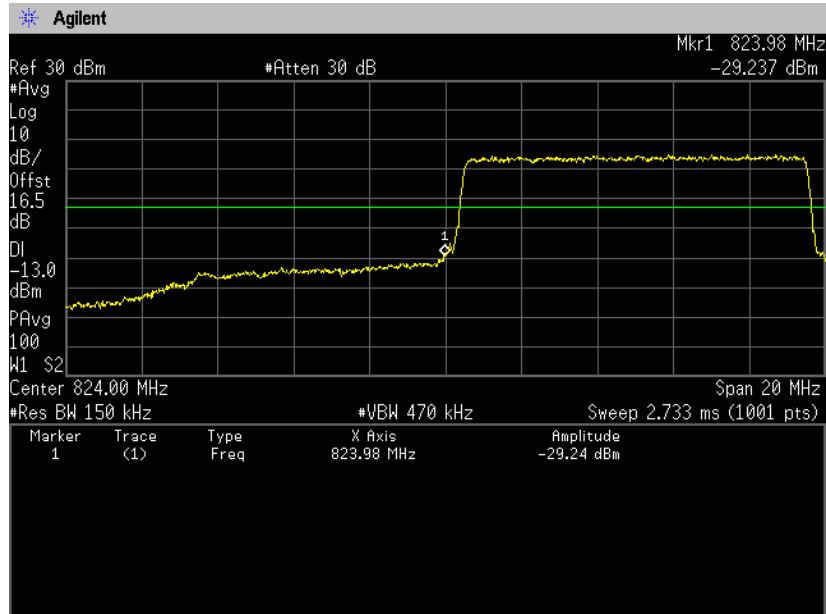

16QAM, BW 10MHz, RB50-0
Channel: High

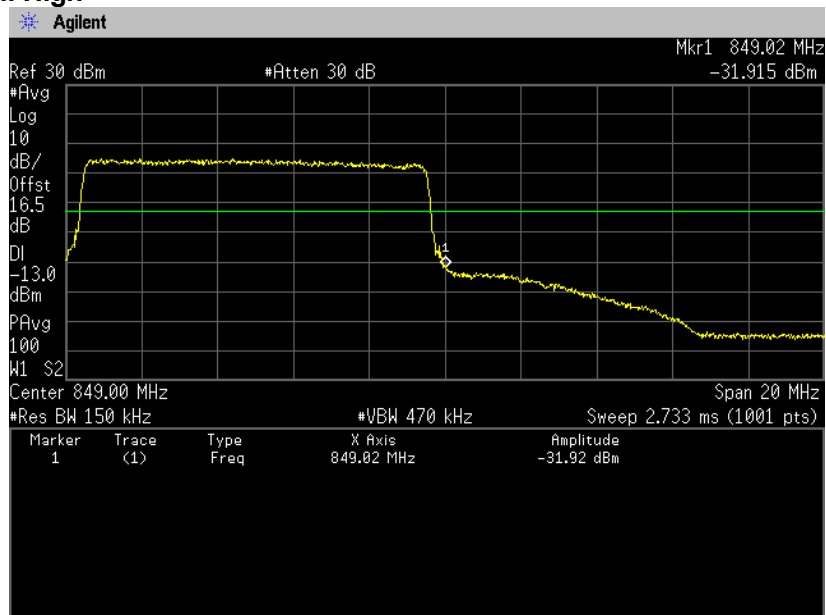

(Spurious Emissions)

Note: Conducted spurious test was measured in the worst case of conducted output power.

**QPSK, BW 1.4MHz, RB1-3
Channel: 23780
30MHz-5GHz**

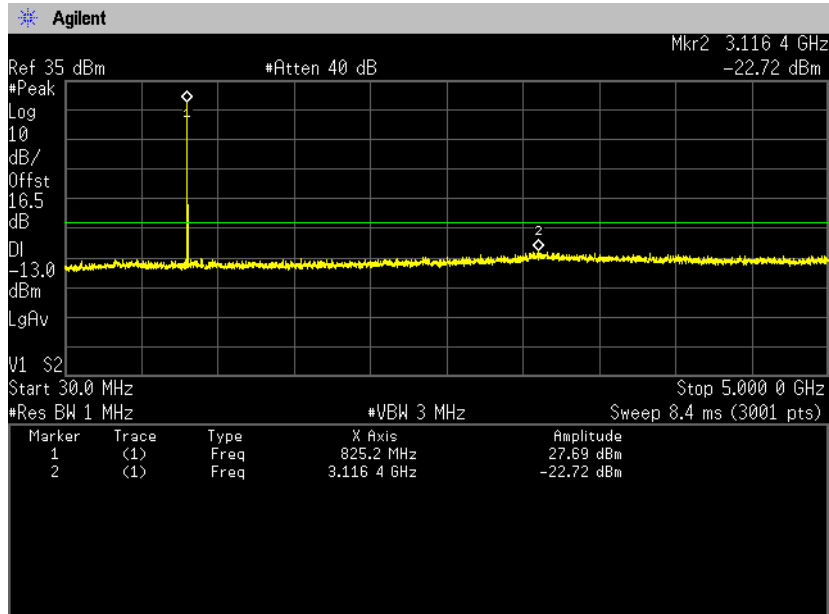

5GHz-10GHz

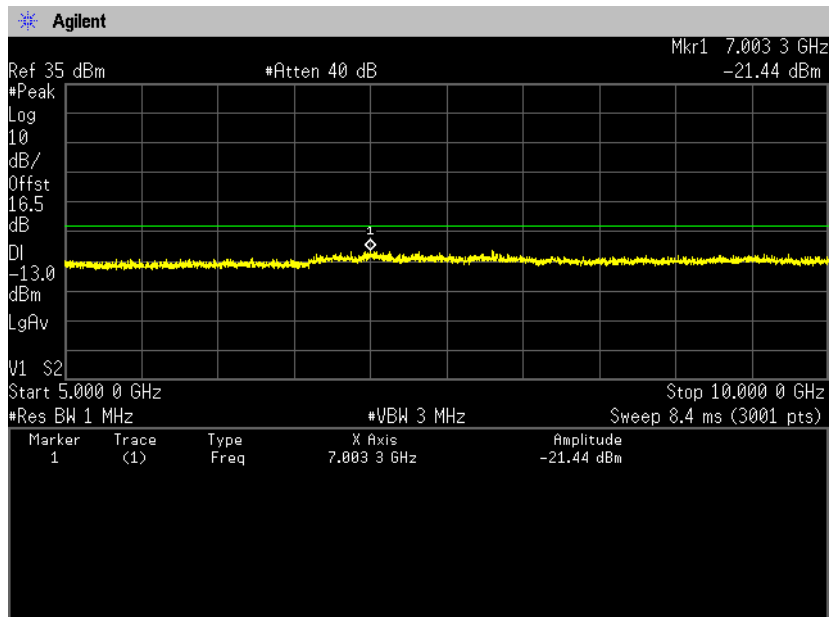

**Channel: 23790
30MHz-5GHz**

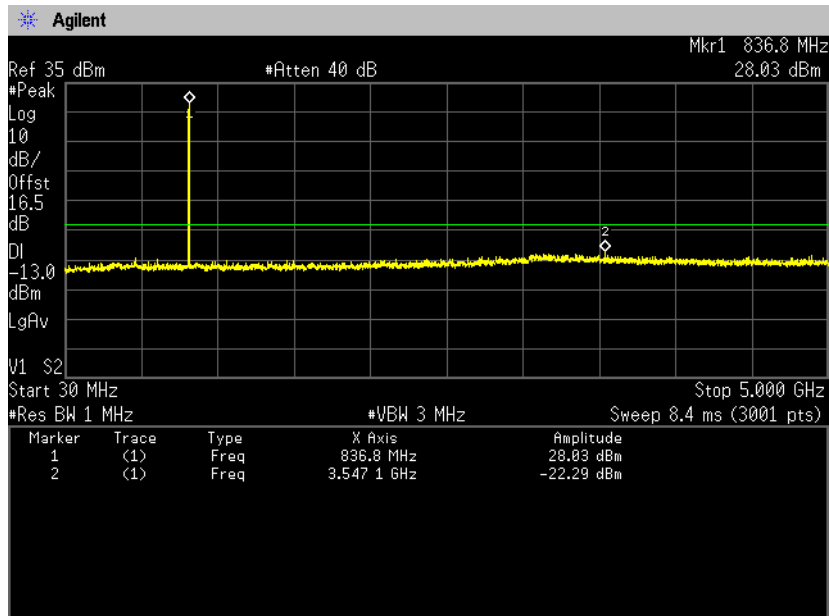

5GHz-10GHz

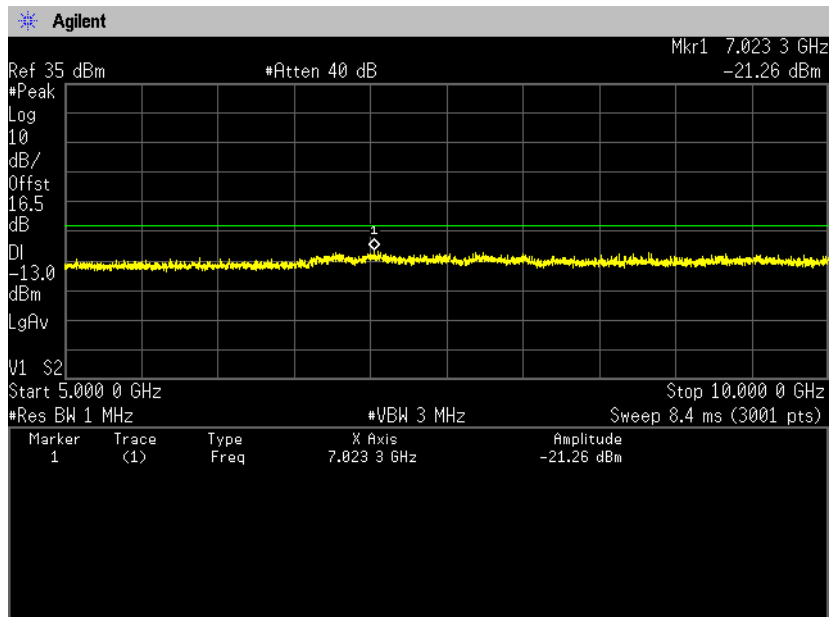



Zacta

**Channel: 23800
30MHz-5GHz**

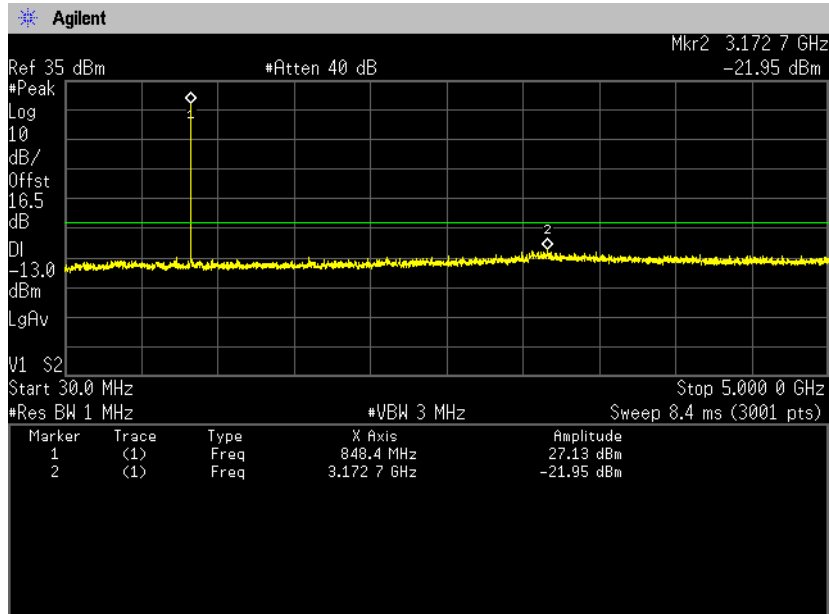

5GHz-10GHz

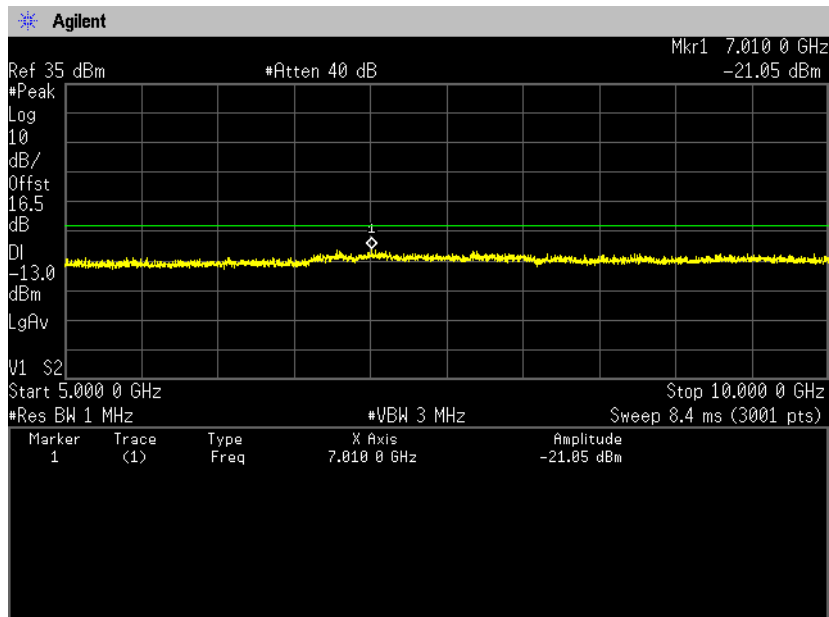

16QAM, BW 3MHz, RB1-0
Channel: 23780
30MHz-5GHz

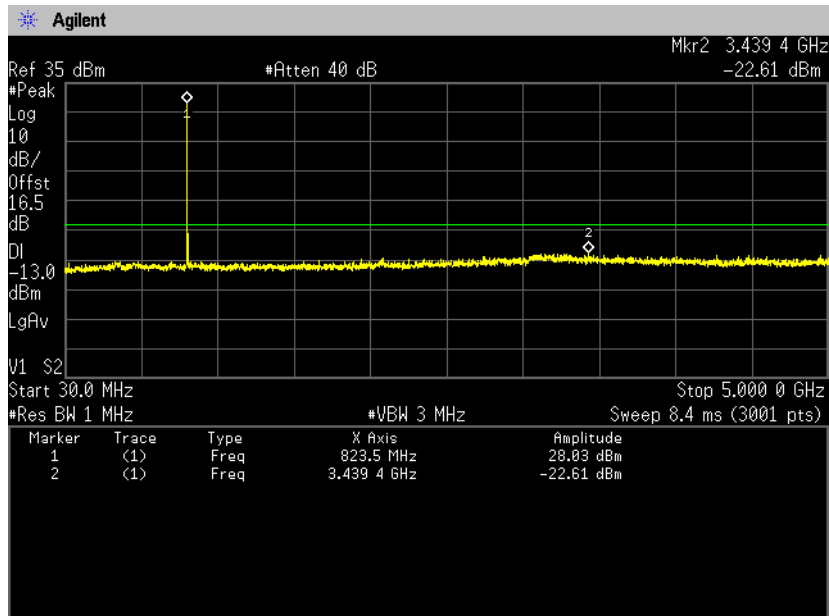

5GHz-10GHz

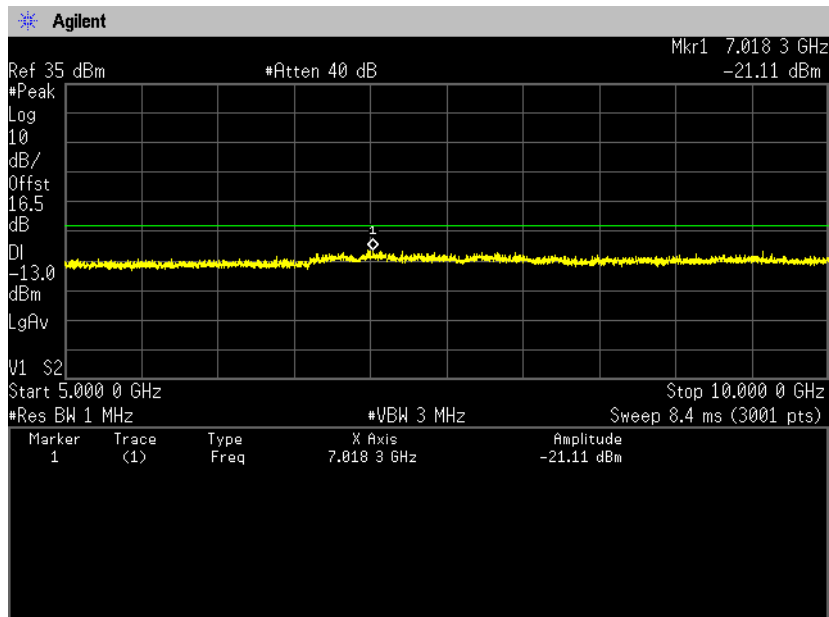



Zacta

**Channel: 23790
30MHz-5GHz**

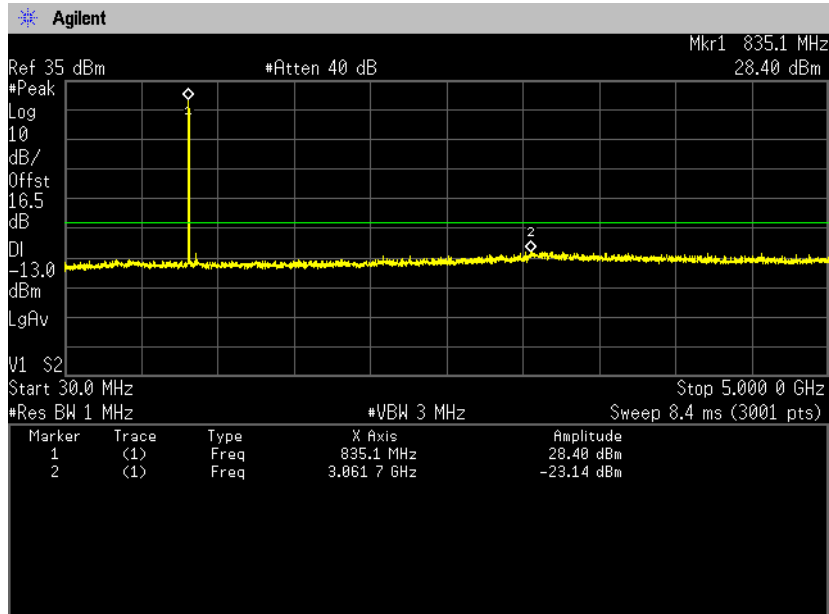

5GHz-10GHz

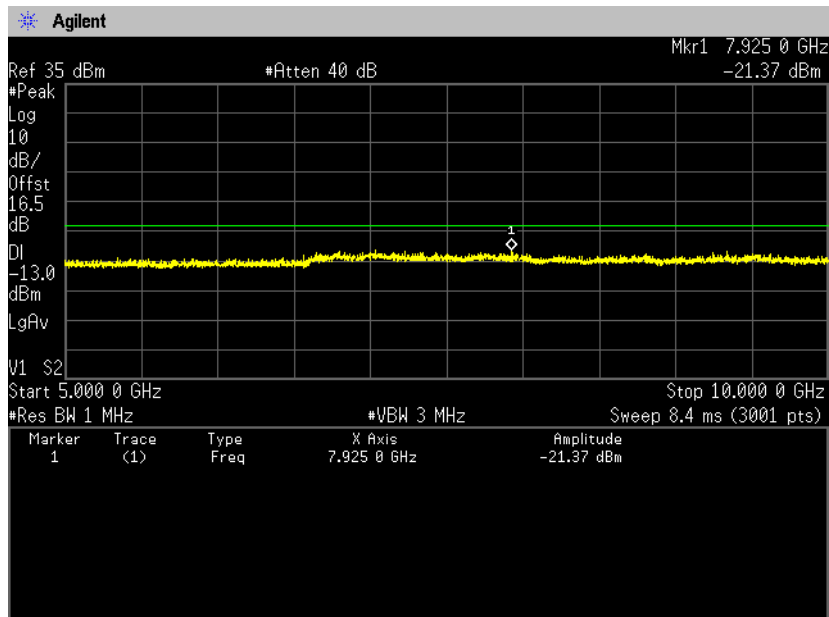



Zacta

**Channel: 23800
30MHz-5GHz**

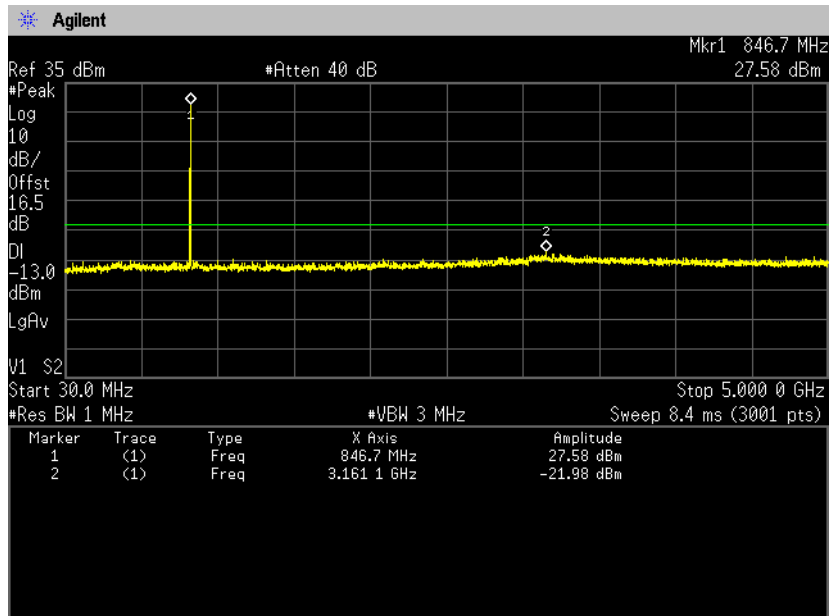

5GHz-10GHz

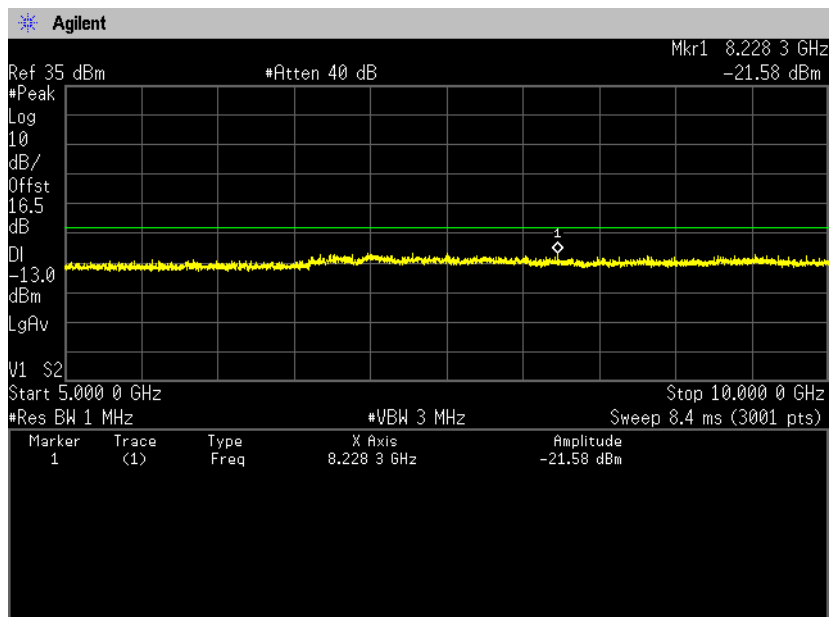

8. Radiated Emissions and Harmonic Emissions

8.1 Measurement procedure [FCC 22.917(a), 2.1053]

<Step 1>

The EUT and support equipment are placed on a 1 meter x 1.5 meter surface, 0.8 meter height FRP table. Radiated emission measurements are performed at 3 meter distance with the broadband antenna (Biconical antenna, Log periodic antenna and double ridged guide antenna). The antenna is positioned both the horizontal and vertical planes of polarization and height is varied 1 to 4 meters and stopped at height producing the maximum emission.

The bandwidth of the spectrum analyzer is set to 1MHz. The turntable is rotated by 360 degrees and stopped at azimuth of producing the maximum emission. The frequency is investigated up to 20GHz.

<Step 2>

The substitution antenna is replaced by the transmitter antenna (EUT).

The frequency of the signal generator is adjusted to the measurement frequency.

Level of the signal generator is adjusted to the level that is obtained from step 1, and record the emission level of signal generator.

The spectrum analyzer is set to;

- RBW = 100kHz for below 1GHz and 1MHz for above 1GHz / VBW \geq 3 x RBW
- Detector = Peak
- Trace mode = Max hold
- Sweep time = auto-couple

- Test configuration

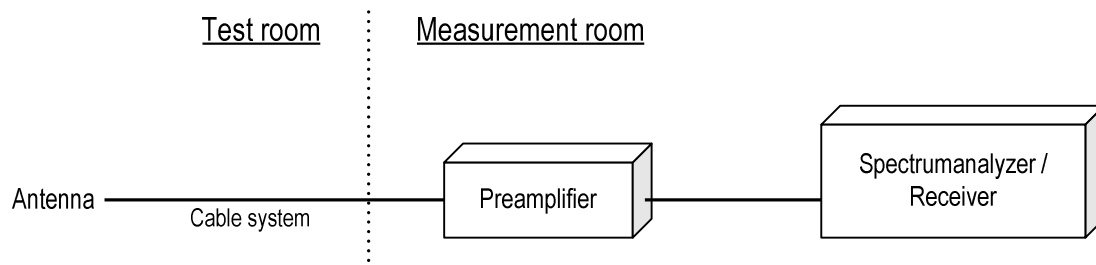

8.2 Calculation method

Result = S.G Reading – Cable loss + Antenna Gain

Margin = Limit – Result (ERP)

8.3 Limit

-13dBm or less



Zacta

8.4 Test data

Date : September 28, 2015
 Temperature : 19.7 [°C]
 Humidity : 63.4 [%]
 Test place : 3m Semi-anechoic chamber
 Test engineer : Taiki Watanabe

Date : September 29, 2015
 Temperature : 24.1 [°C]
 Humidity : 45.8 [%]
 Test place : 3m Semi-anechoic chamber
 Test engineer : Taiki Watanabe

Date : October 8, 2015
 Temperature : 23.4 [°C]
 Humidity : 31.2 [%]
 Test place : 3m Semi-anechoic chamber
 Test engineer : Kazunori Saito

[GSM850] (Channel: 128)

H/V	Frequency [MHz]	S.A Reading [dBm]	S.G Reading [dBm]	Cable loss [dB]	Ant.Gain [dBi]	Result [dBm]	Limit [dBm]	Margin [dB]
H	1648.4	-55.5	-65.5	1.0	6.9	-59.7	-13.0	46.7
V	1648.4	-54.9	-64.8	1.0	6.9	-59.0	-13.0	46.0

(Channel: 190)

H/V	Frequency [MHz]	S.A Reading [dBm]	S.G Reading [dBm]	Cable loss [dB]	Ant.Gain [dBi]	Result [dBm]	Limit [dBm]	Margin [dB]
H	1673.2	-56.2	-66.0	1.1	6.6	-60.4	-13.0	47.4
V	1673.2	-56.0	-65.0	1.1	6.6	-59.4	-13.0	46.4

(Channel: 251)

H/V	Frequency [MHz]	S.A Reading [dBm]	S.G Reading [dBm]	Cable loss [dB]	Ant.Gain [dBi]	Result [dBm]	Limit [dBm]	Margin [dB]
H	1697.6	-54.9	-65.4	1.1	6.3	-60.1	-13.0	47.1
V	1697.6	-55.4	-65.0	1.1	6.3	-59.7	-13.0	46.7



Zacta

Date : October 1, 2015
 Temperature : 24.1 [°C]
 Humidity : 45.8 [%]
 Test place : 3m Semi-anechoic chamber

Test engineer :

Hikaru Shibata

Date : October 8, 2015
 Temperature : 23.4 [°C]
 Humidity : 31.2 [%]
 Test place : 3m Semi-anechoic chamber

Test engineer :

Kazunori Saito

**[WCDMA Band V]
 (Channel: 4132)**

H/V	Frequency [MHz]	S.A Reading [dBm]	S.G Reading [dBm]	Cable loss [dB]	Ant.Gain [dBi]	Result [dBm]	Limit [dBm]	Margin [dB]
H	1652.8	-56.3	-66.6	1.1	6.8	-60.8	-13.0	47.8
V	1652.8	-56.0	-66.0	1.1	6.8	-60.2	-13.0	47.2

(Channel: 4183)

H/V	Frequency [MHz]	S.A Reading [dBm]	S.G Reading [dBm]	Cable loss [dB]	Ant.Gain [dBi]	Result [dBm]	Limit [dBm]	Margin [dB]
H	1673.2	-56.0	-65.8	1.1	6.6	-60.2	-13.0	47.2
V	1673.2	-56.2	-65.2	1.1	6.6	-59.6	-13.0	46.6

(Channel: 4233)

H/V	Frequency [MHz]	S.A Reading [dBm]	S.G Reading [dBm]	Cable loss [dB]	Ant.Gain [dBi]	Result [dBm]	Limit [dBm]	Margin [dB]
H	1693.2	-56.3	-66.2	1.1	6.4	-60.9	-13.0	47.9
V	1693.2	-55.9	-66.2	1.1	6.4	-60.9	-13.0	47.9

Date : October 5, 2015
 Temperature : 18.9 [°C]
 Humidity : 44.6 [%]
 Test place : 3m Semi-anechoic chamber
 Test engineer : Kazunori Saito

Date : October 7, 2015
 Temperature : 22.8 [°C]
 Humidity : 36.9 [%]
 Test place : 3m Semi-anechoic chamber
 Test engineer : Kazunori Saito

Date : October 7, 2015
 Temperature : 24.1 [°C]
 Humidity : 33.1 [%]
 Test place : 3m Semi-anechoic chamber
 Test engineer : Taiki Watanabe

Date : October 8, 2015
 Temperature : 23.4 [°C]
 Humidity : 31.2 [%]
 Test place : 3m Semi-anechoic chamber
 Test engineer : Kazunori Saito

**[LTE Band V]
 QPSK, BW 1.4MHz
 Channel: 20407**

H/V	Frequency [MHz]	S.A Reading [dBm]	S.G Reading [dBm]	Cable loss [dB]	Ant.Gain [dBi]	Result [dBm]	Limit [dBm]	Margin [dB]
H	1649.6	-54.3	-64.2	1.0	6.9	-58.4	-13.0	45.4
V	1649.6	-53.2	-61.5	1.0	6.9	-55.7	-13.0	42.7

Channel: 20525

H/V	Frequency [MHz]	S.A Reading [dBm]	S.G Reading [dBm]	Cable loss [dB]	Ant.Gain [dBi]	Result [dBm]	Limit [dBm]	Margin [dB]
H	1673.2	-54.5	-63.9	1.1	6.6	-58.3	-13.0	45.3
V	1672.0	-52.9	-61.0	1.1	6.6	-55.4	-13.0	42.4

Channel: 20643

H/V	Frequency [MHz]	S.A Reading [dBm]	S.G Reading [dBm]	Cable loss [dB]	Ant.Gain [dBi]	Result [dBm]	Limit [dBm]	Margin [dB]
H	1696.6	-52.2	-62.5	1.1	6.3	-57.2	-13.0	44.2
V	1696.6	-51.6	-59.0	1.1	6.3	-53.7	-13.0	40.7

16QAM, BW 1.4MHz
Channel: 20407

H/V	Frequency [MHz]	S.A Reading [dBm]	S.G Reading [dBm]	Cable loss [dB]	Ant.Gain [dBi]	Result [dBm]	Limit [dBm]	Margin [dB]
H	1649.6	-54.1	-64.0	1.0	6.9	-58.2	-13.0	45.2
V	1649.6	-53.1	-61.4	1.0	6.9	-55.6	-13.0	42.6

Channel: 20525

H/V	Frequency [MHz]	S.A Reading [dBm]	S.G Reading [dBm]	Cable loss [dB]	Ant.Gain [dBi]	Result [dBm]	Limit [dBm]	Margin [dB]
H	1673.2	-53.6	-63.0	1.1	6.6	-57.4	-13.0	44.4
V	1673.2	-52.8	-60.9	1.1	6.6	-55.3	-13.0	42.3

Channel: 20643

H/V	Frequency [MHz]	S.A Reading [dBm]	S.G Reading [dBm]	Cable loss [dB]	Ant.Gain [dBi]	Result [dBm]	Limit [dBm]	Margin [dB]
H	1696.6	-53.2	-63.5	1.1	6.3	-58.2	-13.0	45.2
V	1696.6	-52.8	-60.2	1.1	6.3	-54.9	-13.0	41.9

QPSK, BW 3MHz
Channel: 20415

H/V	Frequency [MHz]	S.A Reading [dBm]	S.G Reading [dBm]	Cable loss [dB]	Ant.Gain [dBi]	Result [dBm]	Limit [dBm]	Margin [dB]
H	1653.6	-54.5	-60.5	1.1	6.8	-54.7	-13.0	41.7
V	1653.6	-53.0	-65.0	1.1	6.8	-59.2	-13.0	46.2

Channel: 20525

H/V	Frequency [MHz]	S.A Reading [dBm]	S.G Reading [dBm]	Cable loss [dB]	Ant.Gain [dBi]	Result [dBm]	Limit [dBm]	Margin [dB]
H	1675.5	-54.0	-60.0	1.1	6.6	-54.5	-13.0	41.5
V	1675.5	-52.2	-60.0	1.1	6.6	-54.5	-13.0	41.5

Channel: 20635

H/V	Frequency [MHz]	S.A Reading [dBm]	S.G Reading [dBm]	Cable loss [dB]	Ant.Gain [dBi]	Result [dBm]	Limit [dBm]	Margin [dB]
H	1697.6	-53.2	-59.0	1.1	6.3	-53.7	-13.0	40.7
V	1697.6	-50.1	-55.0	1.1	6.3	-49.7	-13.0	36.7

16QAM, BW 3MHz
Channel: 20415

H/V	Frequency [MHz]	S.A Reading [dBm]	S.G Reading [dBm]	Cable loss [dB]	Ant.Gain [dBi]	Result [dBm]	Limit [dBm]	Margin [dB]
H	1650.2	-53.7	-63.0	1.1	6.9	-57.2	-13.0	44.2
V	1650.2	-53.2	-63.5	1.1	6.9	-57.7	-13.0	44.7

Channel: 20525

H/V	Frequency [MHz]	S.A Reading [dBm]	S.G Reading [dBm]	Cable loss [dB]	Ant.Gain [dBi]	Result [dBm]	Limit [dBm]	Margin [dB]
H	1672.2	-54.5	-64.6	1.1	6.6	-59.0	-13.0	46.0
V	1672.2	-53.2	-63.5	1.1	6.6	-57.9	-13.0	44.9

Channel: 20635

H/V	Frequency [MHz]	S.A Reading [dBm]	S.G Reading [dBm]	Cable loss [dB]	Ant.Gain [dBi]	Result [dBm]	Limit [dBm]	Margin [dB]
H	1694.2	-54.4	-64.5	1.1	6.4	-59.2	-13.0	46.2
V	1694.2	-53.9	-64.5	1.1	6.4	-59.2	-13.0	46.2

QPSK, BW 5MHz
Channel: 20425

H/V	Frequency [MHz]	S.A Reading [dBm]	S.G Reading [dBm]	Cable loss [dB]	Ant.Gain [dBi]	Result [dBm]	Limit [dBm]	Margin [dB]
H	1648.7	-54.6	-63.0	1.0	6.9	-57.2	-13.0	44.2
V	1648.7	-52.6	-59.0	1.0	6.9	-53.2	-13.0	40.2

Channel: 20525

H/V	Frequency [MHz]	S.A Reading [dBm]	S.G Reading [dBm]	Cable loss [dB]	Ant.Gain [dBi]	Result [dBm]	Limit [dBm]	Margin [dB]
H	1668.7	-54.4	-62.5	1.1	6.7	-56.9	-13.0	43.9
V	1668.7	-53.5	-60.0	1.1	6.7	-54.4	-13.0	41.4

Channel: 20625

H/V	Frequency [MHz]	S.A Reading [dBm]	S.G Reading [dBm]	Cable loss [dB]	Ant.Gain [dBi]	Result [dBm]	Limit [dBm]	Margin [dB]
H	1688.7	-53.9	-62.6	1.1	6.4	-57.2	-13.0	44.2
V	1688.7	-53.5	-59.8	1.1	6.4	-54.4	-13.0	41.4

16QAM, BW 5MHz
Channel: 20425

H/V	Frequency [MHz]	S.A Reading [dBm]	S.G Reading [dBm]	Cable loss [dB]	Ant.Gain [dBi]	Result [dBm]	Limit [dBm]	Margin [dB]
H	1657.4	-54.1	-62.6	1.1	6.8	-56.9	-13.0	43.9
V	1657.4	-52.7	-59.0	1.1	6.8	-53.3	-13.0	40.3

Channel: 20525

H/V	Frequency [MHz]	S.A Reading [dBm]	S.G Reading [dBm]	Cable loss [dB]	Ant.Gain [dBi]	Result [dBm]	Limit [dBm]	Margin [dB]
H	1677.4	-54.5	-64.5	1.1	6.6	-59.0	-13.0	46.0
V	1677.4	-52.2	-58.0	1.1	6.6	-52.5	-13.0	39.5

Channel: 20625

H/V	Frequency [MHz]	S.A Reading [dBm]	S.G Reading [dBm]	Cable loss [dB]	Ant.Gain [dBi]	Result [dBm]	Limit [dBm]	Margin [dB]
H	1697.4	-52.9	-61.5	1.1	6.3	-56.2	-13.0	43.2
V	1697.4	-51.2	-58.0	1.1	6.3	-52.7	-13.0	39.7

QPSK, BW 10MHz
Channel: 20450

H/V	Frequency [MHz]	S.A Reading [dBm]	S.G Reading [dBm]	Cable loss [dB]	Ant.Gain [dBi]	Result [dBm]	Limit [dBm]	Margin [dB]
H	1649.2	-53.8	-60.0	1.0	6.9	-54.2	-13.0	41.2
V	1649.2	-53.9	-60.5	1.0	6.9	-54.7	-13.0	41.7

Channel: 20525

H/V	Frequency [MHz]	S.A Reading [dBm]	S.G Reading [dBm]	Cable loss [dB]	Ant.Gain [dBi]	Result [dBm]	Limit [dBm]	Margin [dB]
H	1664.2	-55.6	-62.2	1.1	6.7	-56.5	-13.0	43.5
V	1664.2	-55.1	-62.0	1.1	6.7	-56.3	-13.0	43.3

Channel: 20600

H/V	Frequency [MHz]	S.A Reading [dBm]	S.G Reading [dBm]	Cable loss [dB]	Ant.Gain [dBi]	Result [dBm]	Limit [dBm]	Margin [dB]
H	1679.2	-53.6	-60.0	1.1	6.5	-54.5	-13.0	41.5
V	1679.2	-53.1	-59.6	1.1	6.5	-54.1	-13.0	41.1

16QAM, BW 10MHz**Channel: 20450**

H/V	Frequency [MHz]	S.A Reading [dBm]	S.G Reading [dBm]	Cable loss [dB]	Ant.Gain [dBi]	Result [dBm]	Limit [dBm]	Margin [dB]
H	1649.2	-55.5	-61.7	1.0	6.9	-55.9	-13.0	42.9
V	1649.2	-54.2	-60.8	1.0	6.9	-55.0	-13.0	42.0

Channel: 20525

H/V	Frequency [MHz]	S.A Reading [dBm]	S.G Reading [dBm]	Cable loss [dB]	Ant.Gain [dBi]	Result [dBm]	Limit [dBm]	Margin [dB]
H	1664.2	-55.2	-61.8	1.1	6.7	-56.1	-13.0	43.1
V	1664.2	-55.2	-62.1	1.1	6.7	-56.4	-13.0	43.4

Channel: 20600

H/V	Frequency [MHz]	S.A Reading [dBm]	S.G Reading [dBm]	Cable loss [dB]	Ant.Gain [dBi]	Result [dBm]	Limit [dBm]	Margin [dB]
H	1679.2	-55.0	-61.4	1.1	6.5	-55.9	-13.0	42.9
V	1678.9	-52.3	-58.8	1.1	6.5	-53.3	-13.0	40.3

9. Frequency Stability

9.1 Measurement procedure [FCC 22.355, 2.1055]

The EUT was placed inside of a constant temperature chamber as the temperature in the chamber was varied between -30°C and $+50^{\circ}\text{C}$. The temperature was incremented by 10°C intervals and the unit was allowed to stabilize at each measurement. The frequency drift was measured with the normal Temperature and voltage tolerance and it is presented as the ppm unit.

- Test configuration

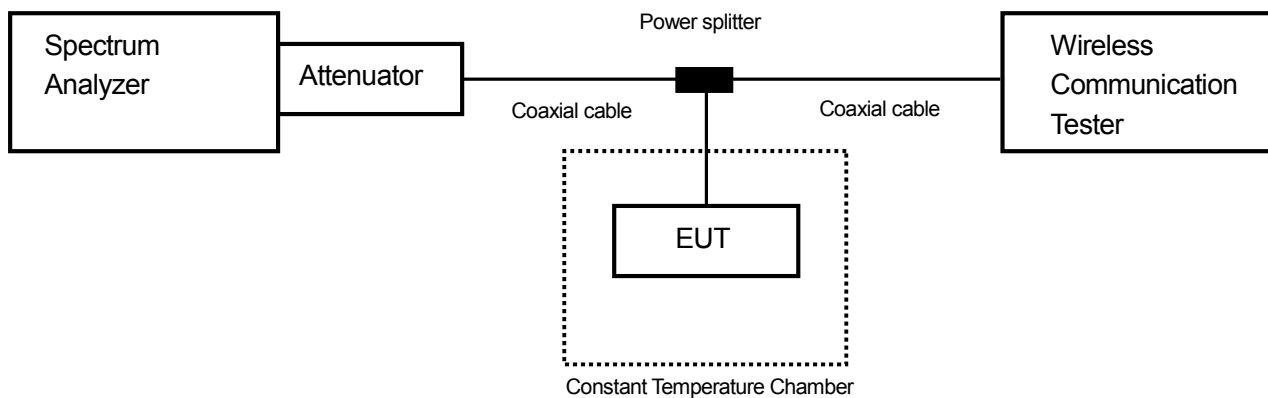

9.2 Limit

$\pm 2.5\text{ppm}$

9.3 Measurement result

Date : October 7, 2015
 Temperature : 19.4 [°C]
 Humidity : 45.5 [%]
 Test place : Shielded room No.4

Test engineer : Hikaru Shibata

[GSM850]

(Channel: 190)

Limit: $\pm 0.00025\% = \pm 2.5\text{ppm}$					
Power Supply [V]	Temperature [°C]	Measurements Frequency [Hz]	Frequency Tolerance [ppm]	Limit [ppm]	Result
3.80	25(Ref.)	836,600,008	0.00000	± 2.5	Pass
	50	836,600,008	-0.00007	± 2.5	Pass
	40	836,600,010	0.00262	± 2.5	Pass
	30	836,600,004	-0.00439	± 2.5	Pass
	20	836,600,009	0.00127	± 2.5	Pass
	10	836,600,008	-0.00022	± 2.5	Pass
	0	836,600,011	0.00349	± 2.5	Pass
	-10	836,600,006	-0.00235	± 2.5	Pass
	-20	836,600,010	0.00268	± 2.5	Pass
	-30	836,600,007	-0.00088	± 2.5	Pass
3.230	25	836,600,007	-0.00155	± 2.5	Pass
4.370	25	836,600,010	0.00243	± 2.5	Pass

[WCDMA Band V]

(Channel: 4183)

Limit: $\pm 0.00025\% = \pm 2.5\text{ppm}$					
Power Supply [V]	Temperature [°C]	Measurements Frequency [Hz]	Frequency Tolerance [ppm]	Limit [ppm]	Result
3.80	25(Ref.)	836,600,002	0.00000	± 2.5	Pass
	50	836,600,003	0.00142	± 2.5	Pass
	40	836,600,004	0.00221	± 2.5	Pass
	30	836,599,998	-0.00567	± 2.5	Pass
	20	836,600,003	0.00092	± 2.5	Pass
	10	836,600,004	0.00219	± 2.5	Pass
	0	836,600,004	0.00224	± 2.5	Pass
	-10	836,600,004	0.00220	± 2.5	Pass
	-20	836,600,004	0.00226	± 2.5	Pass
	-30	836,600,004	0.00224	± 2.5	Pass
3.230	25	836,600,003	0.00033	± 2.5	Pass
4.370	25	836,600,003	0.00082	± 2.5	Pass

Calculation;

$$\text{Frequency Tolerance (ppm)} = \frac{\text{Measurements Frequency (Hz)} - \text{Reference Frequency (Hz)}}{\text{Reference Frequency (Hz)}} \times 1000000$$

Date : October 7, 2015
 Temperature : 19.4 [°C]
 Humidity : 45.5 [%]
 Test place : Shielded room No.4

Test engineer : Hikaru Shibata

**[LTE Band V]
 (Channel: 20525)**

Limit: ±0.00025% = ±2.5ppm					
Power Supply [V]	Temperature [°C]	Measurements Frequency [Hz]	Frequency Tolerance [ppm]	Limit [ppm]	Result
3.80	25(Ref.)	836,500,000	0.00000	±2.5	Pass
	50	836,500,000	0.00036	±2.5	Pass
	40	836,500,002	0.00185	±2.5	Pass
	30	836,499,998	-0.00280	±2.5	Pass
	20	836,500,002	0.00245	±2.5	Pass
	10	836,500,001	0.00142	±2.5	Pass
	0	836,500,003	0.00354	±2.5	Pass
	-10	836,500,002	0.00208	±2.5	Pass
	-20	836,500,002	0.00238	±2.5	Pass
	-30	836,500,001	0.00179	±2.5	Pass
3.230	25	836,500,001	0.00142	±2.5	Pass
4.370	25	836,499,997	-0.00330	±2.5	Pass

Calculation;

$$\text{Frequency Tolerance (ppm)} = \frac{\text{Measurements Frequency (Hz)} - \text{Reference Frequency (Hz)}}{\text{Reference Frequency (Hz)}} \times 1000000$$



Zacta

10. Uncertainty of measurement

Expanded uncertainties stated are calculated with a coverage Factor $k=2$.

Please note that these results are not taken into account when determining compliance or non-compliance with test result.

Test item	Measurement uncertainty
Conducted emission at mains port	$\pm 3.0\text{dB}$
Radiated emission (9kHz – 30MHz)	$\pm 4.4\text{dB}$
Radiated emission (30MHz – 1000MHz)	$\pm 4.5\text{dB}$
Radiated emission (1000MHz – 26GHz)	$\pm 3.9\text{dB}$



Zacta

11. Laboratory description

1. Location:

TÜV SÜD Zacta Ltd. Yonezawa Testing Center
 4149-7 Hachimanpara 5-chome Yonezawa-shi Yamagata 992-1128 Japan
 Phone: +81-238-28-2880 Fax: +81-238-28-2888

2. Facility filing information:

1) NVLAP accreditation: NVLAP Lab. code: 200306-0

2) VLAC accreditation: Lab. code: VLAC-013

Site name	Radiated emission	Conducted emission for mains port	Conducted emission for telecom port	Radiated emission (CMAD)	Expiry Date
3m Semi-anechoic chamber	VLAC-013	-	-	-	Jul. 3, 2017
10m Semi-anechoic chamber No.1				VLAC-013	
10m Semi-anechoic chamber No.2				VLAC-013	
Shielded room No.1	-	VLAC-013	-	-	

3) FCC filing:

Site name	Registration Number	Expiry Date
Site 3	91065	Oct. 1, 2017
3m Semi-anechoic chamber	540072	Feb. 20, 2017
10m Semi-anechoic chamber No.1		
10m Semi-anechoic chamber No.2		
Shielded room No.1		

4) Industry Canada Oats site filing:

Site name	Sites on file: Oats 3m/10m	Expiry Date
Site 3	4224A-3	Dec. 3, 2017
3m Semi-anechoic chamber	4224A-4	
10m Semi-anechoic chamber No.1	4224A-5	
10m Semi-anechoic chamber No.2	4224A-6	Jan. 15, 2017

5) VCCI site filing:

Site name	Radiated emission	Conducted emission for mains port	Conducted emission for telecom port	Expiry Date
Site 3	R-138	C-134	T-1222	Nov. 16, 2017
3m Semi-anechoic chamber	-	A-0166	-	Jul. 3, 2017
10m Semi-anechoic chamber No.1				
10m Semi-anechoic chamber No.2				
Shielded room No.1	-	A-0166	-	

6) TÜV SÜD PS authorization:

Authorized as an EMC test laboratory

7) TÜV Rheinland authorization:

Authorized as an EMC test laboratory

Appendix A. Test equipment

Antenna port conducted test

Equipment	Company	Model No.	Serial No.	Cal. due	Cal. date
Spectrum analyzer	Agilent Technologies	E4440A	US44302655	Jun. 30, 2016	Jun. 11, 2015
Microwave cable	RS	YH_13S5	N/A (S403)	May 31, 2016	May 10, 2015
Attenuator	Weinschel	56-10	J4180	Nov. 30, 2015	Nov. 12, 2014
Microwave cable	SUHNER	SUCOFLEX104/1.5m	199121/4	Oct. 31, 2015	Oct. 7, 2014
Microwave cable	SUHNER	SUCOFLEX104/1.5m	322086/4	May 31, 2016	May 29, 2015
Power splitter	ANRITSU	K240B	020205	Jul. 31, 2016	Jul. 12, 2015
Power meter	ROHDE&SCHWARZ	NRP2	103269	Jun. 20, 2016	Jun. 25, 2015
Power sensor	ROHDE&SCHWARZ	NRP-Z81	102467	Jun. 20, 2016	Jun. 25, 2015
Wideband radio frequency tester	ROHDE&SCHWARZ	CMW500	116338	Apr. 30, 2016	Apr. 2, 2015
Operation type temperature controlled bath	Espec	PL1KP	14007261	Jan. 31, 2016	Jan. 9, 2015

Radiated emission

Equipment	Company	Model No.	Serial No.	Cal. Due	Cal. Date
EMI Receiver	ROHDE&SCHWARZ	ESCI	100764	Aug. 31, 2016	Aug. 21, 2015
Preamplifier	ANRITSU	MH648A	M96057	Jun. 30, 2016	Jun. 30, 2015
Biconical antenna	Schwarzbeck	VHA9103/BBA9106	2125	Jun. 30, 2016	Jun. 4, 2015
Log periodic antenna	Schwarzbeck	UHALP9108A	0560	Jun. 30, 2016	Jun. 4, 2015
Attenuator	TME	CFA-01NPJ-6	N/A (S275)	Jun. 30, 2016	Jun. 23, 2015
Attenuator	TME	CFA-01NPJ-3	N/A (S272)	Jun. 30, 2016	Jun. 23, 2015
Spectrum analyzer	Agilent Technologies	E4440A	US40420937	Jul. 31, 2016	Jul. 23, 2015
Preamplifier	Agilent Technologies	8449B	3008A1008	Dec. 31, 2015	Dec. 5, 2014
Dipole antenna	Schwarzbeck	VHAP	1021	Oct. 31, 2016	Oct. 2, 2015
Dipole antenna	Schwarzbeck	UHAP	993	Oct. 31, 2016	Oct. 2, 2015
Double ridged guide antenna	EMCO	3115	5205	Feb. 29, 2016	Feb. 16, 2015
Attenuator	Agilent Technologies	8491B	MY39268633	Feb. 29, 2016	Feb. 1, 2015
Double ridged guide antenna	EMCO	3115	000058532	Oct. 31, 2015	Oct. 14, 2014
Signal generator	ROHDE&SCHWARZ	SMB100A	177525	Jun. 30, 2016	Jun. 19, 2015
Power amplifier	R&K	CGA020M602-2633R	B40240	Mar. 31, 2016	Mar. 23, 2015
Microwave cable	SUHNER	SUCOFELX102/2m	31648/2	Mar. 31, 2016	Mar. 10, 2015
High pass filter	Micro-Tronics	HPM50115	004	Jul. 31, 2016	Jul. 12, 2015
High pass filter	Wainwright	WHKX2.8/18G-6SS	1	Jul. 31, 2016	Jul. 29, 2015
Wideband radio frequency tester	ROHDE&SCHWARZ	CMW500	126079	Sep. 30, 2016	Sep. 15, 2015
Microwave cable	SUHNER	SUCOFLEX104/9m	346316/4	Oct. 31, 2015	Oct. 31, 2014
		SUCOFLEX104/1m	322084/4	Oct. 31, 2015	Oct. 31, 2014
		SUCOFLEX104/1.5m	317226/4	Oct. 31, 2015	Oct. 31, 2014
		SUCOFLEX104/7m	41625/6	Oct. 31, 2015	Oct. 31, 2014
PC	DELL	DIMENSION E521	75465BX	N/A	N/A
Software	TOYO Corporation	EP5/RE-AJ	0611193/V5.3.61	N/A	N/A
3m Semi-anechoic chamber	TOKIN	N/A	N/A (9002-NSA)	Apr. 30, 2016	Apr. 27, 2015
3m Semi-anechoic chamber	TOKIN	N/A	N/A (9002-SVSWR)	Apr. 30, 2016	Apr. 27, 2015

*: The calibrations of the above equipment are traceable to NIST or equivalent standards of the reference organizations.