

TEST REPORT

Report number : JPD-TR-16018-0

Issue date : June 24, 2016

The device, as described herewith, was tested pursuant to applicable test procedure and complies with the requirements of;

FCC Part 27 Subpart C IC RSS-130

The test results are traceable to the international or national standards.

Applicant	: KYOCERA Corporation
Equipment under test (EUT)	: Module
Model number	: KA36
FCC ID	: JOYKA36
IC Certification Number	: 574B-KA36

Date of test : June 8, 9, 13, 17, 2016

Test place : TÜV SÜD Zacta Ltd. Yonezawa Testing Center
4149-7 Hachimanpara 5-chome
Yonezawa-shi Yamagata 992-1128 Japan
Phone: +81-238-28-2880 Fax: +81-238-28-2888

Test results : Complied

The results in this report are applicable only to the equipment tested.
This report shall not be re-produced except in full without the written approval of TÜV SÜD Zacta Ltd.
This test report must not be used by the client to claim product certification, approval, or endorsement by NVLAP, NIST, or any agency of the federal government.

Tested by : _____
Chiaki Kanno Taiki Watanabe

Authorized by : _____
Hiroaki Suzuki
Manager of EMC Technical Department



Table of contents

	Page
1. Summary of Test	4
1.1 Purpose of test	4
1.2 Standards	4
1.3 List of applied test to the EUT	4
1.4 Modification to the EUT by laboratory	4
2. Equipment Under Test	5
2.1 General Description of equipment	5
2.2 EUT information	5
2.3 Variation of the family model(s)	6
2.4 Description of Test mode	6
3. Configuration of equipment	7
3.1 Equipment(s) used	7
3.2 System configuration	7
3.3 System configuration	7
4. Conducted Output Power	8
4.1 Measurement procedure	8
4.2 Measurement result	8
5. Effective Radiated Power	10
5.1 Measurement procedure	10
5.2 Calculation method	11
5.3 Limit	11
5.4 Test data	12
6. Peak to Average Ratio	13
6.1 Measurement procedure	13
6.2 Limit	13
6.3 Measurement result	13
6.4 Trace data	14
7. Occupied Bandwidth	16
7.1 Measurement procedure	16
7.2 Limit	16
7.3 Measurement result	17
7.4 Trace data	18
8. Band Edge Spurious and Harmonic at Antenna Terminals	22
8.1 Measurement procedure	22
8.2 Limit	22
8.3 Measurement result	23
8.4 Trace data	24
9. Radiated Emissions and Harmonic Emissions	38
9.1 Measurement procedure	38
9.2 Calculation method	38
9.3 Limit	38
9.4 Test data	39
10. Frequency Stability	42



Zacta

10.1 Measurement procedure	42
10.2 Limit	42
10.3 Measurement result	43
11. Uncertainty of measurement	44
12. Laboratory description	45
Appendix A. Test equipment	46



Zacta

1. Summary of Test

1.1 Purpose of test

EUT, FCC ID: JOYKA36, has been granted on September 1, 2015.

EUT, IC Certification Number: 574B-KA36, has been granted on September 15, 2015.

Purpose of test is retest of EUT by changing LTE band. (Change from the band 12 to band 17.)

1.2 Standards

CFR47 FCC Part 27 Subpart C

IC RSS-130

1.2.1 Test Methods

KDB 971168 D01 Power Meas License Digital Systems v02r02

ANSI/TIA/EIA-603-D-2010

1.2.2 Deviation from standards

None

1.3 List of applied test to the EUT

FCC Section	IC Section	Test items	Condition	Result
2.1046	N/A	Conducted Output Power	Conducted	PASS
27.50(c)(10)	RSS-130 4.4	Effective Radiated Power	Radiated	PASS
27.50(d)(5)	N/A	Peak to Average Ratio	Conducted	PASS
2.1049	RSS-130 4.3	Occupied Bandwidth	Conducted	PASS
27.53(g) 2.1051	RSS-130 4.6	Band Edge Spurious and Harmonic at Antenna Terminal	Conducted	PASS
27.53(g) 2.1053	RSS-130 4.6	Radiated emissions and Harmonic Emissions	Radiated	PASS
27.54 2.1055	RSS-130 4.3	Frequency Stability	Conducted	PASS

1.3.1 Test set up

Table-Top

1.4 Modification to the EUT by laboratory

None

2. Equipment Under Test

2.1 General Description of equipment

EUT is the Module.

2.2 EUT information

Applicant	:	KYOCERA Corporation Yokohama Office 2-1-1 Kagahara, Tsuzuki-ku Yokohama-shi, Kanagawa, Japan Phone: +81-45-943-6253 Fax: +81-45-943-6314
Equipment under test	:	Module
Trade name	:	Kyocera
Model number	:	KA36
Serial number	:	N/A
EUT condition	:	Pre-Production
Power ratings	:	DC 3.9V
Size	:	(W) 40.0 × (D) 40.0 × (H) 4.3 mm
Environment	:	Indoor and Outdoor use
Terminal limitation	:	-20°C to 60°C
RF Specification		
Frequency of Operation	:	Up Link LTE Band X VII: 704-716MHz
		Down Link LTE Band X VII: 734-746MHz
Modulation type	:	QPSK, 16QAM
Emission designator	:	BW 5M QPSK: 4M51G7W, 16QAM: 4M53D7W BW 10M QPSK: 9M04G7W, 16QAM: 9M02D7W
Output power	:	QPSK: 0.191W (22.81dBm) 16QAM: 0.153W (21.86dBm)
Antenna type	:	External antenna
Antenna gain	:	2.41 dBi

2.3 Variation of the family model(s)

AL-S5300NA-A2-1

2.4 Description of Test mode

The EUT had been tested under operating condition.
There are three channels have been tested as following:

Band	Modulation	Bandwidth	Channel	Frequency [MHz]
LTE Band X VII	QPSK	5MHz	23775	706.5
			23790	710.0
			23825	713.5
		10MHz	23780	709.0
			23790	710.0
			23800	711.0
	16QAM	5MHz	23775	706.5
			23790	710.0
			23825	713.5
		10MHz	23780	709.0
			23790	710.0
			23800	711.0

The field strength of spurious emissions was measured at each position of two axis X, Y to compare the level, and the maximum noise.

The worst emission was found in Y axis and the worst case recorded.

3. Configuration of equipment

3.1 Equipment(s) used

No.	Equipment	Company	Model No.	Serial No.	FCC ID / DoC	Comment
1	Module	KYOCERA	KA36	N/A	JOYKA36	EUT
2	JOINT BOARD	KYOCERA	N/A	N/A	N/A	-
3	SHARK Antenna	YOKOWO	N/A	N/A	N/A	-
4	Whip Antenna	EAD	PTR7210	N/A	N/A	-
5	GPS Antenna	PASTERNAK	PE51066	N/A	N/A	-

3.2 System configuration

No.	Cable	Length[m]	Shield	Connector	Comment
a	RF cable (MAIN)	0.3	YES	Metal	-
b	RF cable (SUB)	0.3	YES	Metal	-
c	GPS Antenna cable	5.0	YES	Metal	-
d	DC cable	1.3	NO	Plastic	-

3.3 System configuration

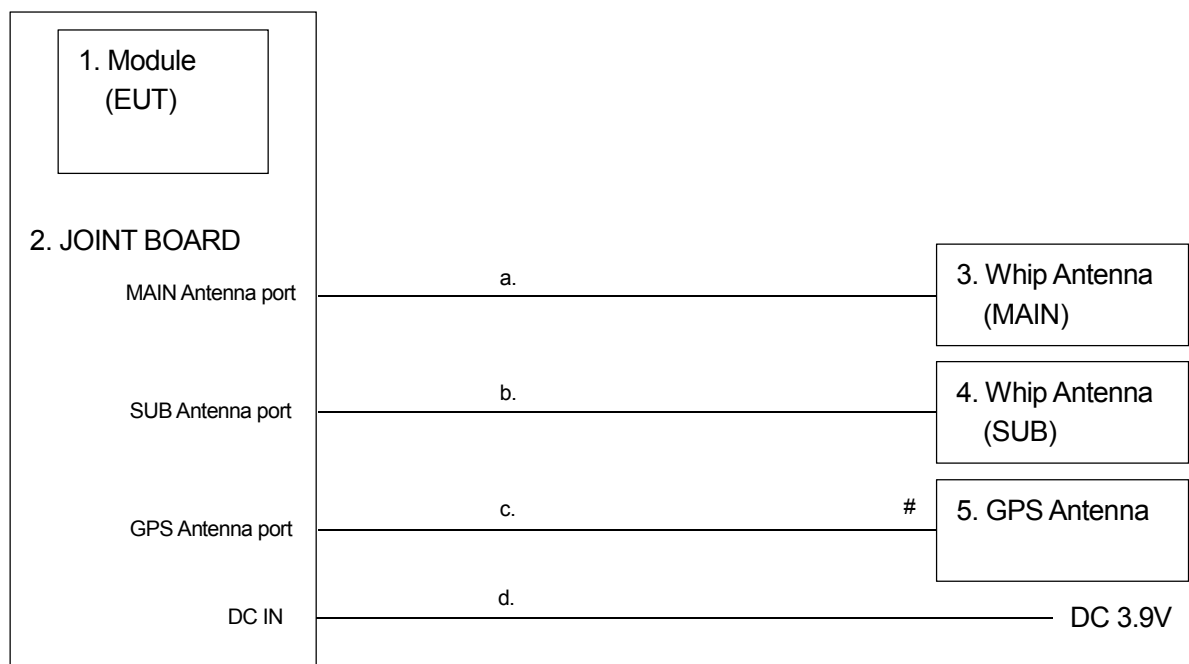

: Un-detachable cable

Note1: Numbers assigned to equipment or cables on this diagram correspond to the list in "3.1 Equipment(s) used" and "3.2 Cable(s) used".

4. Conducted Output Power

4.1 Measurement procedure [FCC 2.1046]

The conducted output power was measured with a wireless communication tester connected to the antenna terminal. The wireless communication tester parameters were set to produce the maximum power from the EUT.

- Test configuration

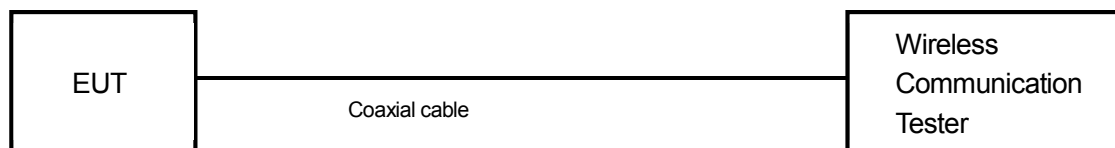

4.2 Measurement result

Date : June 7, 2016
 Temperature : 22.6 [°C]
 Humidity : 48.2 [%]
 Test place : Shielded room No.4

Test engineer : Chiaki Kanno

Band	BW [MHz]	Mode	RB Allocation	RB offset	Target MPR	Avg Power[dBm]		
						23755	23790	23825
						706.5 MHz	710.0 MHz	713.5 MHz
LTE Band 17	5	QPSK	1	0	0	22.41	22.39	22.73
			1	12	0	22.41	22.45	22.71
			1	24	0	22.53	22.62	22.81
			12	0	1	21.32	21.58	21.65
			12	7	1	21.34	21.64	21.73
			12	13	1	21.48	21.73	21.78
			25	0	1	21.36	21.53	21.49
		16QAM	1	0	1	21.49	21.68	21.46
			1	12	1	21.54	21.05	21.46
			1	24	1	21.65	21.23	21.58
			12	0	2	20.47	20.47	20.81
			12	7	2	20.41	20.52	20.80
			12	13	2	20.55	20.69	20.86
			25	0	2	20.41	20.59	20.76



Zacta

Band	BW [MHz]	Mode	RB Allocation	RB offset	Target MPR	Avg Power[dBm]		
						23780	23790	23800
						709.0 MHz	710.0 MHz	711.0 MHz
LTE Band 17	10	QPSK	1	0	0	22.54	22.63	22.51
			1	25	0	22.53	22.52	22.63
			1	49	0	22.74	22.76	22.73
			25	0	1	21.37	21.45	21.40
			25	12	1	21.34	21.51	21.54
			25	25	1	21.51	21.56	21.65
			50	0	1	21.36	21.42	21.39
		16QAM	1	0	1	21.19	21.19	21.68
			1	25	1	21.69	21.15	21.86
			1	49	1	21.85	21.37	21.40
			25	0	2	20.37	20.51	20.47
			25	12	2	20.39	20.54	20.57
			25	25	2	20.58	20.63	20.76
			50	0	2	20.37	20.40	20.45

5. Effective Radiated Power

5.1 Measurement procedure

[FCC 27.50(c)(10), IC RSS-130 4.4]

<Step 1>

The EUT and support equipment are placed on a 1 meter x 1.5 meter surface, 0.8 meter height FRP table. Radiated emission measurements are performed at 3 meter distance with the broadband antenna (double ridged guide antenna). The antenna is positioned both the horizontal and vertical planes of polarization and height is varied 1 to 4 meters and stopped at height producing the maximum emission. The bandwidth of the spectrum analyzer is set to 1MHz. The turntable is rotated by 360 degrees and stopped at azimuth of producing the maximum emission.

<Step 2>

The substitution antenna is replaced by the transmitter antenna (EUT). The frequency of the signal generator is adjusted to the measurement frequency. Level of the signal generator is adjusted to the level that is obtained from step 1, and record the emission level of signal generator.

The spectrum analyzer is set to;

- a) Span = 1.5 times the OBW
- b) RBW = 1-5% of the expected OBW, not to exceed 1MHz
- c) VBW $\geq 3 \times$ RBW
- d) Number of sweep points $\geq 2 \times$ span / RBW
- e) Sweep time = auto-couple
- f) Detector = RMS (power averaging)
- g) If the EUT can be configured to transmit continuously (i.e., burst duty cycle $\geq 98\%$), then set the trigger to free run.
- h) If the EUT cannot be configured to transmit continuously (i.e., burst duty cycle $< 98\%$), then use a sweep trigger with the level set to enable triggering only on full power bursts and configure the EUT to transmit at full power for the entire duration of each sweep. Ensure that the sweep time is less than or equal to the transmission burst duration.
- i) Trace average at least 100 traces in power averaging (i.e., RMS) mode.
- j) Compute the power by integrating the spectrum across the OBW of the signal using the instrument's band power measurement function, with the band limits set equal to the OBW band edges. If the instrument does not have a band power function, then sum the spectrum levels (in linear power units) at intervals equal to the RBW extending across the entire OBW of the spectrum.

- Test configuration

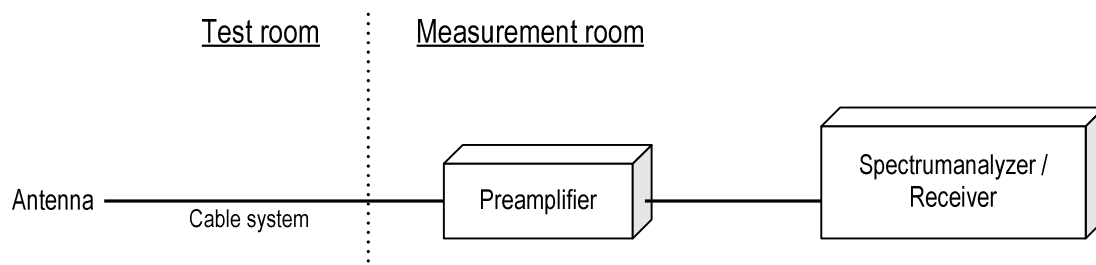



Zacta

5.2 Calculation method

Result (ERP) = S.G Reading – Cable loss + Antenna Gain
Margin = Limit – Result (ERP)

5.3 Limit

3 W (34.7dBm)



Zacta

5.4 Test data

Date : June 13, 2016
 Temperature : 22.5 [°C]
 Humidity : 60.6 [%]
 Test place : 3m Semi-anechoic chamber
 Test engineer : Taiki Watanabe

Date : June 14, 2016
 Temperature : 23.4 [°C]
 Humidity : 41.2 [%]
 Test place : 3m Semi-anechoic chamber
 Test engineer : Taiki Watanabe

[LTE Band X VII]

QPSK, BW 5MHz

H/V	Frequency [MHz]	S.A Reading [dBm]	S.G Reading [dBm]	Cable loss [dB]	Ant.Gain [dBi]	Result [dBm]	Limit [dBm]	Margin [dB]
H	706.5	-9.4	29.5	0.7	-10.3	18.5	34.7	16.2
H	710.0	-11.1	27.8	0.7	-10.3	16.8	34.7	17.9
H	713.5	-10.7	28.2	0.7	-10.4	17.2	34.7	17.5

16QAM, BW 5MHz

H/V	Frequency [MHz]	S.A Reading [dBm]	S.G Reading [dBm]	Cable loss [dB]	Ant.Gain [dBi]	Result [dBm]	Limit [dBm]	Margin [dB]
H	706.5	-10.0	28.9	0.7	-10.3	17.9	34.7	16.8
H	710.0	-10.8	28.1	0.7	-10.3	17.1	34.7	17.6
H	713.5	-11.4	27.5	0.7	-10.4	16.5	34.7	18.2

QPSK, BW 10MHz

H/V	Frequency [MHz]	S.A Reading [dBm]	S.G Reading [dBm]	Cable loss [dB]	Ant.Gain [dBi]	Result [dBm]	Limit [dBm]	Margin [dB]
H	709.0	-10.5	28.4	0.7	-10.3	17.4	34.7	17.3
H	710.0	-9.9	29.0	0.7	-10.3	18.0	34.7	16.7
H	711.0	-9.8	29.1	0.7	-10.3	18.1	34.7	16.6

16QAM, BW 10MHz

H/V	Frequency [MHz]	S.A Reading [dBm]	S.G Reading [dBm]	Cable loss [dB]	Ant.Gain [dBi]	Result [dBm]	Limit [dBm]	Margin [dB]
H	709.0	-10.2	28.7	0.7	-10.3	17.7	34.7	17.0
H	710.0	-10.1	28.8	0.7	-10.3	17.8	34.7	16.9
H	711.0	-10.8	28.1	0.7	-10.3	17.1	34.7	17.6

6. Peak to Average Ratio

6.1 Measurement procedure [FCC 27.50(d)(5)]

The peak to average ratio was measured with a spectrum analyzer connected to the antenna terminal.

The spectrum analyzer is set to;

- a) Power Stat CCDF mode
- b) Set resolution / measurement bandwidth \geq signal's occupied bandwidth.
- c) Set the number of counts to a value that stabilizes the measured CCDF curve.
- d) Set the measurement interval as follows:
 - 1) For continuous transmissions, set to 1ms.
 - 2) For burst transmissions, employ an external trigger that is synchronized with the EUT burst timing sequence, or use the internal burst trigger with a trigger level that allows the burst duration.
- e) Record the maximum PAPR level associated with a probability of 0.1%.

- Test configuration

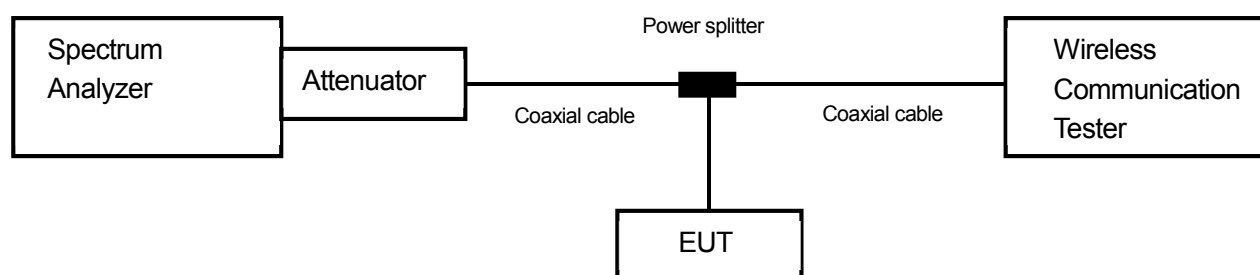

6.2 Limit

13dB or less

6.3 Measurement result

Date : June 8, 2016
 Temperature : 24.0 [°C]
 Humidity : 45.2 [%]
 Test place : Shielded room No.4

Test engineer : Chiaki Kanno

Band	Channel	Frequency [MHz]	Modulation	BW [MHz]	RB	Peak to Average Power Ratio [dB]	Limit [dB]
LTE Band X VII	23790	710.0	QPSK	5	25-0	5.81	13
				10	50-0	4.62	13
			16QAM	5	25-0	6.68	13
				10	50-0	6.28	13



Zacta

6.4 Trace data
[LTE Band X VII]
Channel: 23790
QPSK, BW 5MHz, RB25-0

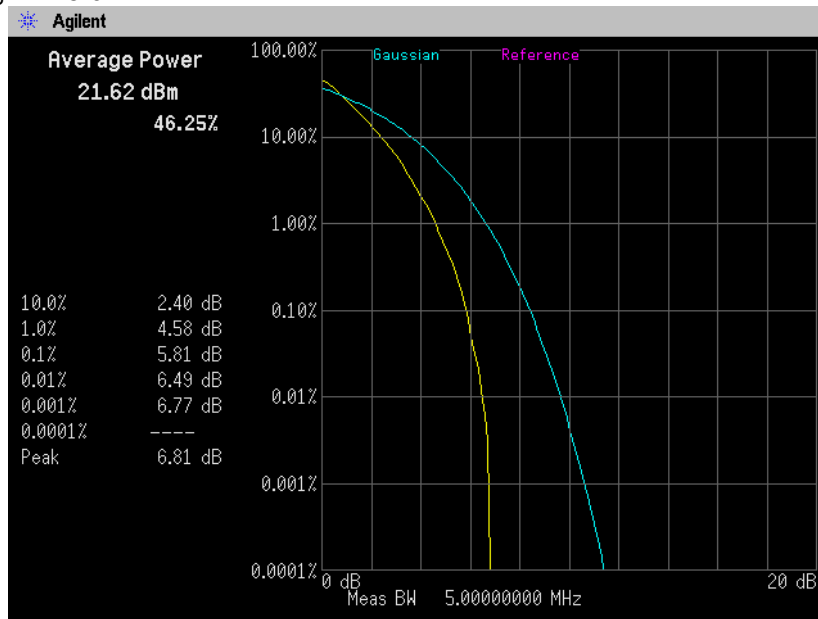

QPSK, BW 10MHz, RB50-0

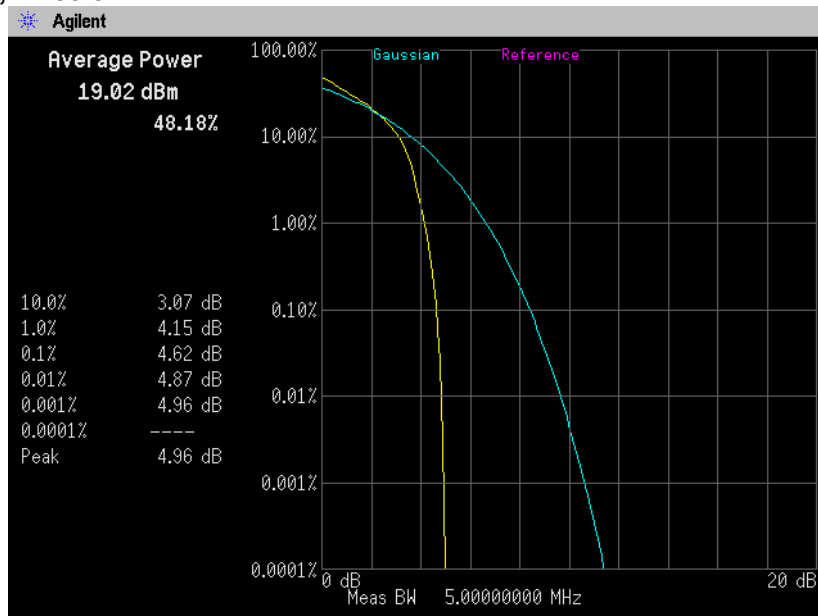



Zacta

16QAM, BW 5MHz, RB25-0

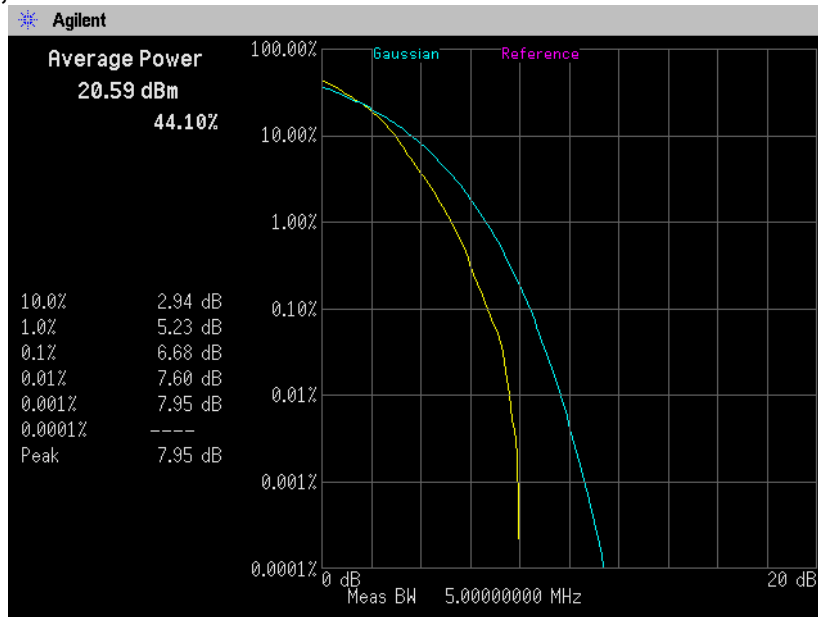

16QAM, BW 10MHz, RB50-0

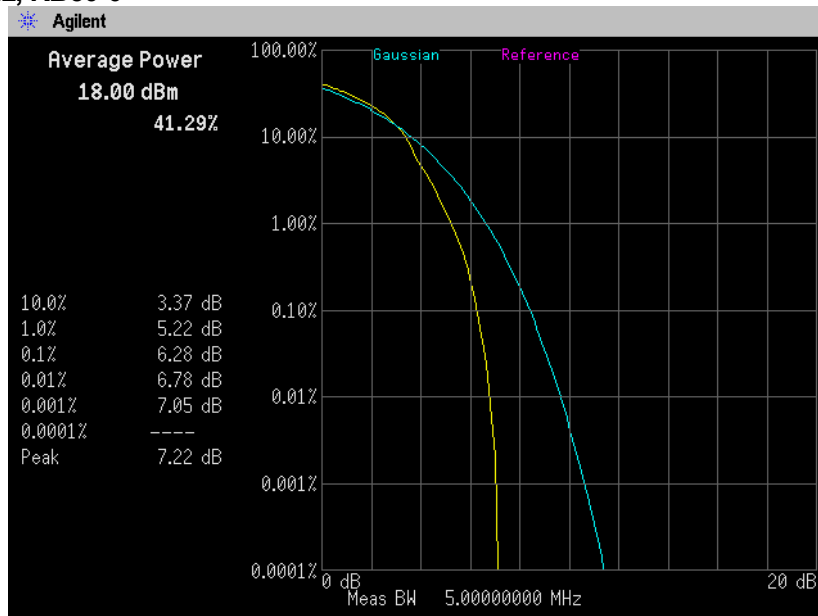

7. Occupied Bandwidth

7.1 Measurement procedure [FCC 2.1049, IC RSS-130 4.3]

The Occupied bandwidth was measured with a spectrum analyzer connected to the antenna terminal.

The spectrum analyzer is set to;

- a) RBW = 1-5% of the expected OBW & VBW $\geq 3 \times$ RBW
- b) Detector = Peak
- c) Trace mode = Max hold
- d) Sweep time = auto-couple

- Test configuration

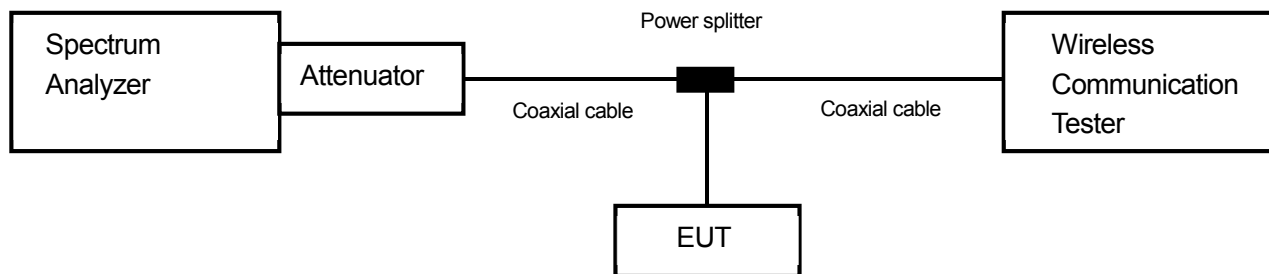

7.2 Limit

None

7.3 Measurement result

Date : June 8, 2016
 Temperature : 24.0 [°C]
 Humidity : 45.2 [%]
 Test place : Shielded room No.4

Test engineer : Chiaki Kanno

BW	Mode	UL RB Allocation	UL RB Start	Frequency [MHz]	26dB Bandwidth [MHz]	99% OBW [MHz]
5MHz	QPSK	1	0	710.0	0.710	0.5044
		1	24		0.714	0.4920
		12	7		3.328	2.3121
		25	0		5.088	4.5152
5MHz	16QAM	1	0	710.0	0.686	0.4793
		1	24		0.704	0.4882
		12	7		3.417	2.3504
		25	0		5.145	4.5349
10MHz	QPSK	1	0	710.0	1.033	0.7528
		1	49		1.002	0.7167
		25	12		6.792	4.7553
		50	0		10.043	9.0446
10MHz	16QAM	1	0	710.0	1.024	0.7447
		1	49		1.011	0.7192
		25	12		6.896	4.8015
		50	0		10.007	9.0270



Zacta

7.4 Trace data
[LTE Band X VII]
Channel: 23790
QPSK, BW 5MHz, RB1-0

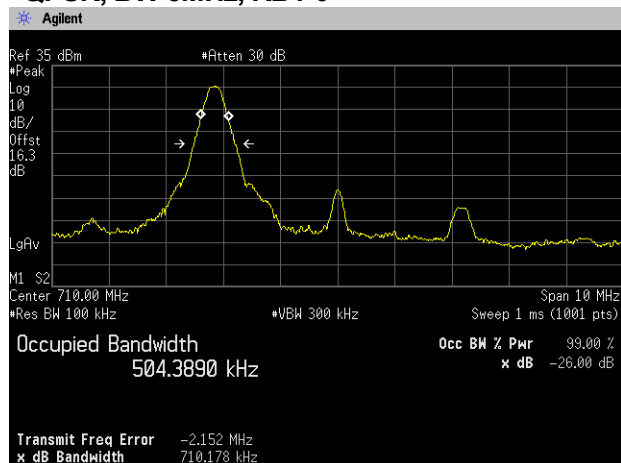

RB1-24

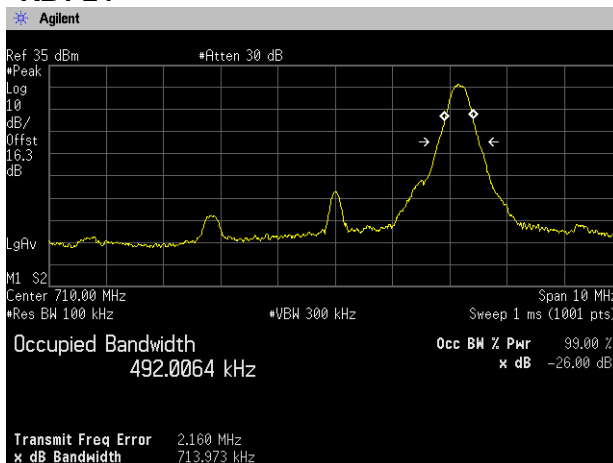

RB12-7

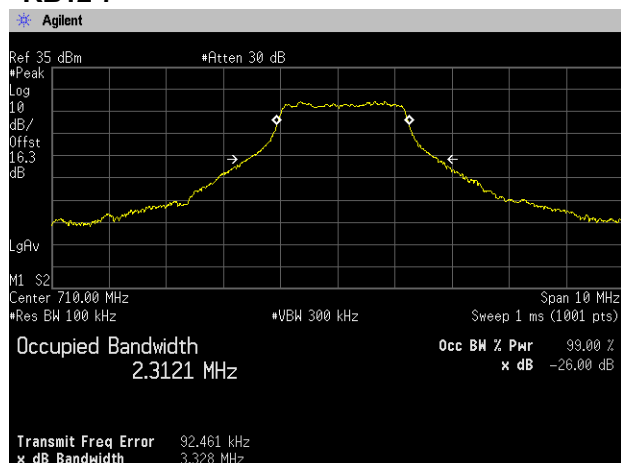

RB25-0

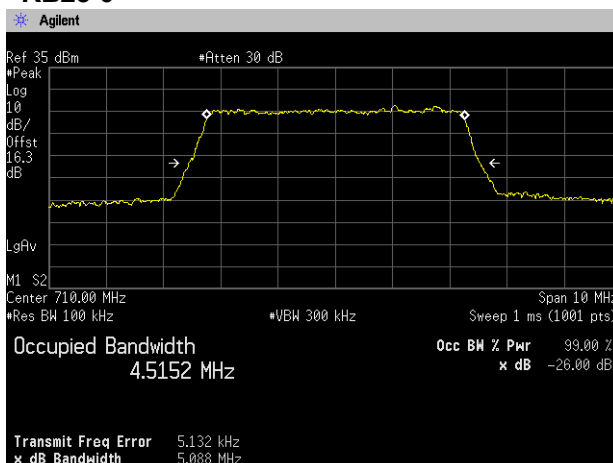



Zacta

16QAM, BW 5MHz, RB1-0

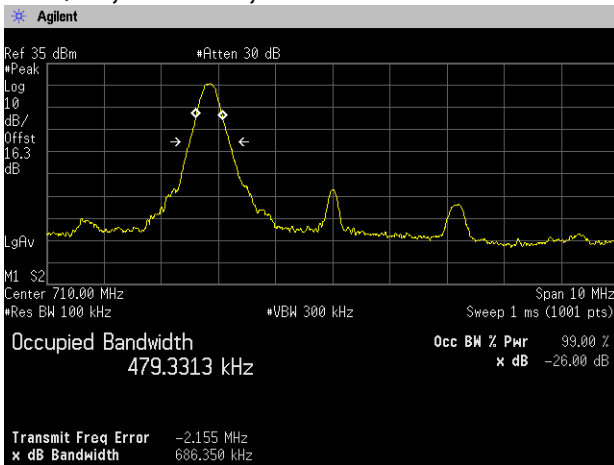

RB1-24

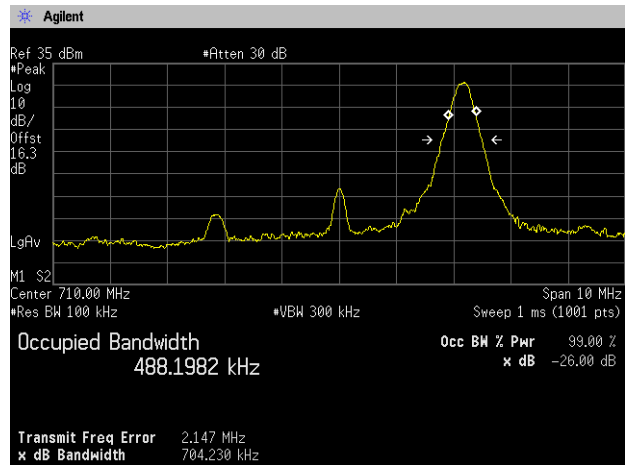

RB12-7

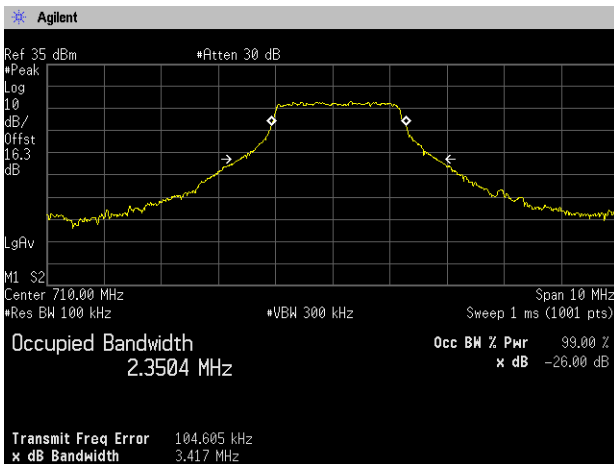

RB25-0

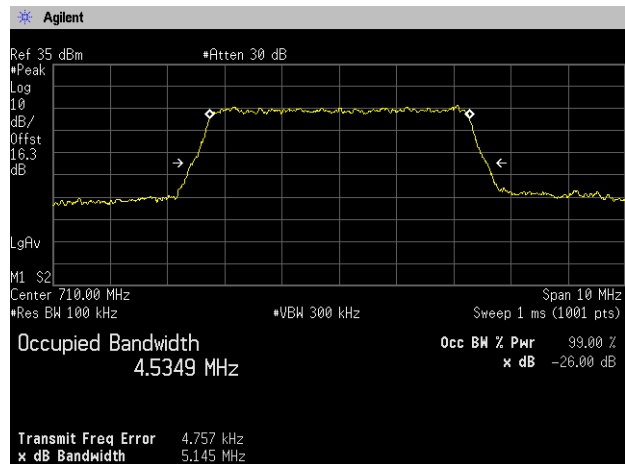



Zacta

QPSK, BW 10MHz, RB1-0

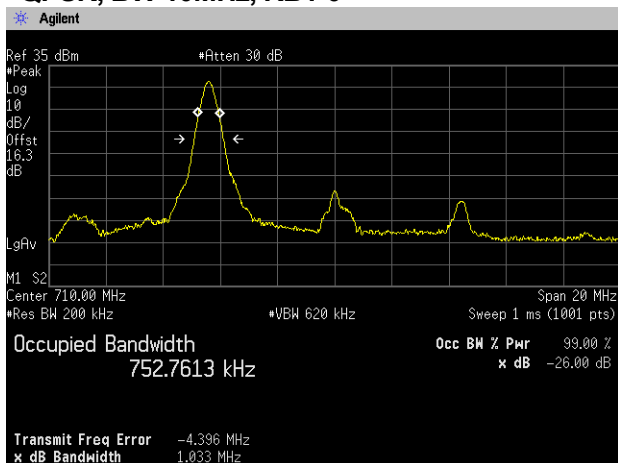

RB1-49

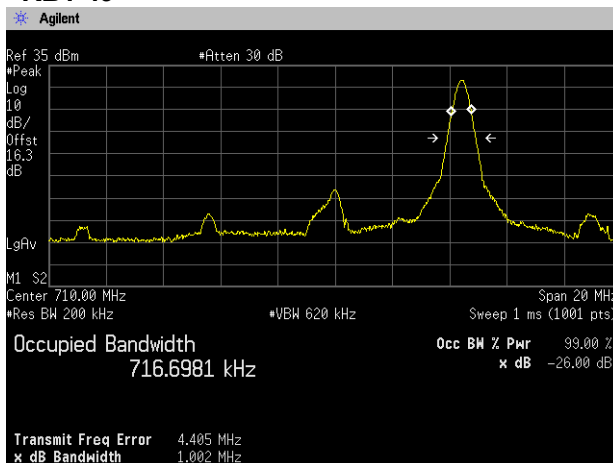

RB25-12

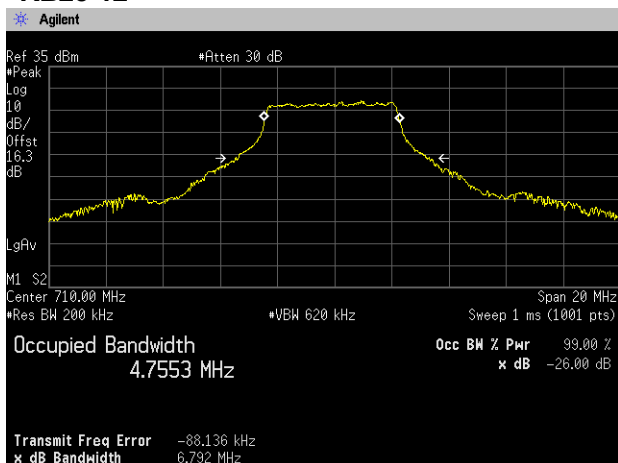

RB50-0

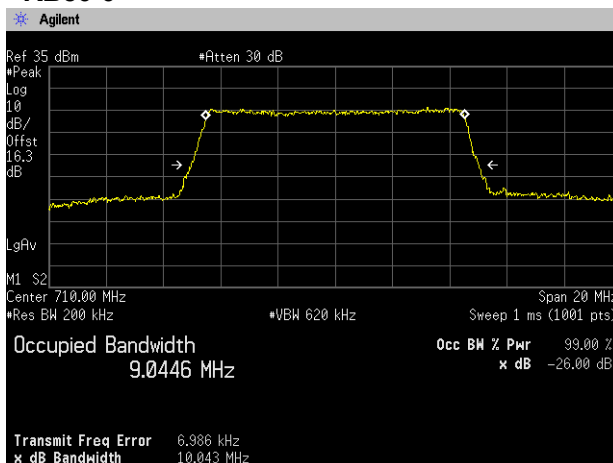



Zacta

16QAM, BW 10MHz, RB1-0

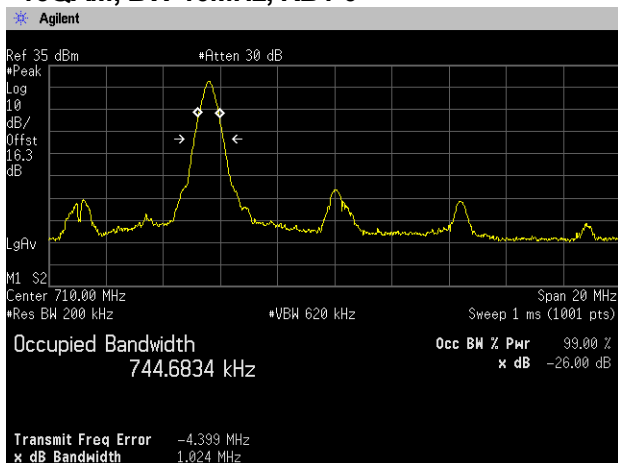

RB1-49

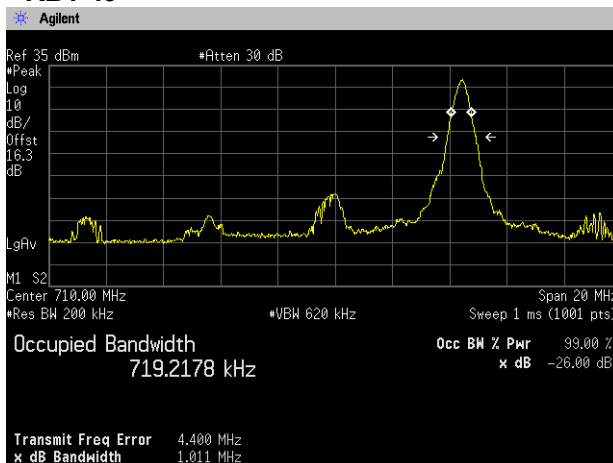

RB25-12

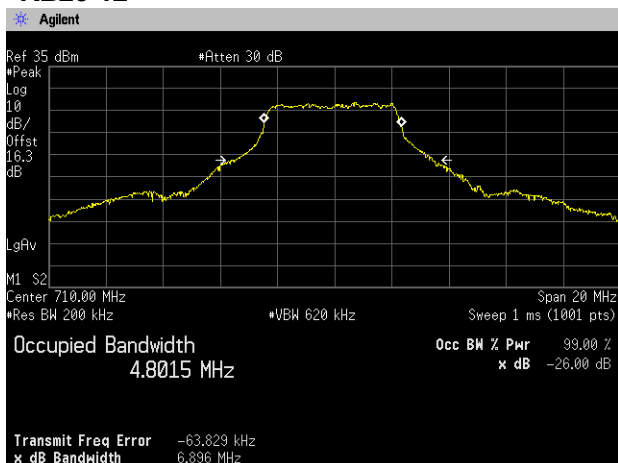

RB50-0

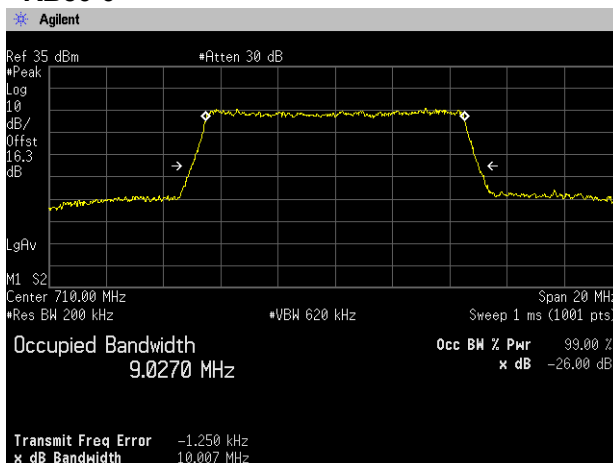

8. Band Edge Spurious and Harmonic at Antenna Terminals

8.1 Measurement procedure

[FCC 27.53(g), 2.1051, IC RSS-130 4.6]

The band edge spurious and harmonic was measured with a spectrum analyzer connected to the antenna terminal.

The spectrum analyzer is set to;

<Band Edge>

- a) Span was set large enough so as to capture all out of band emissions near the band edge
- b) RBW \geq 1% of the emission bandwidth or 2% of the emission bandwidth
- c) VBW \geq 3 x RBW
- d) Detector = RMS
- e) Trace mode = Max hold
- f) Sweep time = auto-couple
- g) Number of sweep point \geq 2 x span / RBW

<Spurious Emissions>

- a) RBW = 1MHz & VBW \geq 3 x RBW
- b) Detector = Peak
- c) Trace mode = Max hold
- d) Sweep time = auto-couple
- e) Number of sweep point \geq 2 x span / RBW

- Test configuration

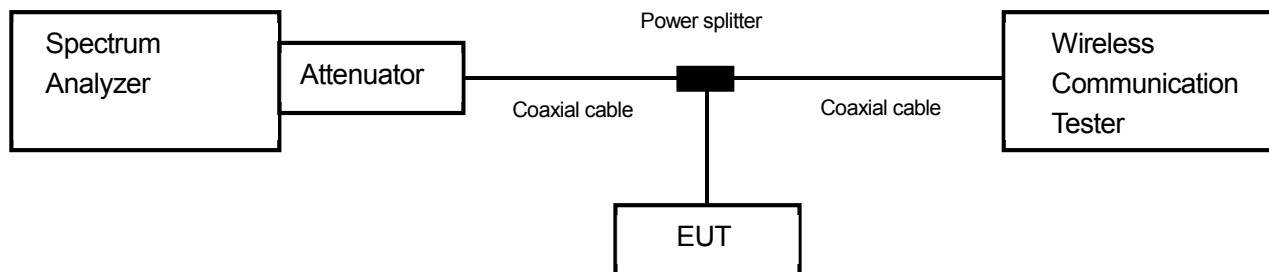

8.2 Limit

-13dBm or less

8.3 Measurement result

Date : June 8, 2016
 Temperature : 24.0 [°C]
 Humidity : 45.2 [%]
 Test place : Shielded room No.4

Test engineer : Chiaki Kanno

Band	Modulation	Bandwidth	Results	
LTE Band X VII	QPSK	5MHz	See the trace data	PASS
		10MHz	See the trace data	PASS
	16QAM	5MHz	See the trace data	PASS
		10MHz	See the trace data	PASS



Zacta

8.4 Trace data
[LTE Band X VII]
(Band Edge)
QPSK, BW 5MHz, RB1-0
Channel: Low

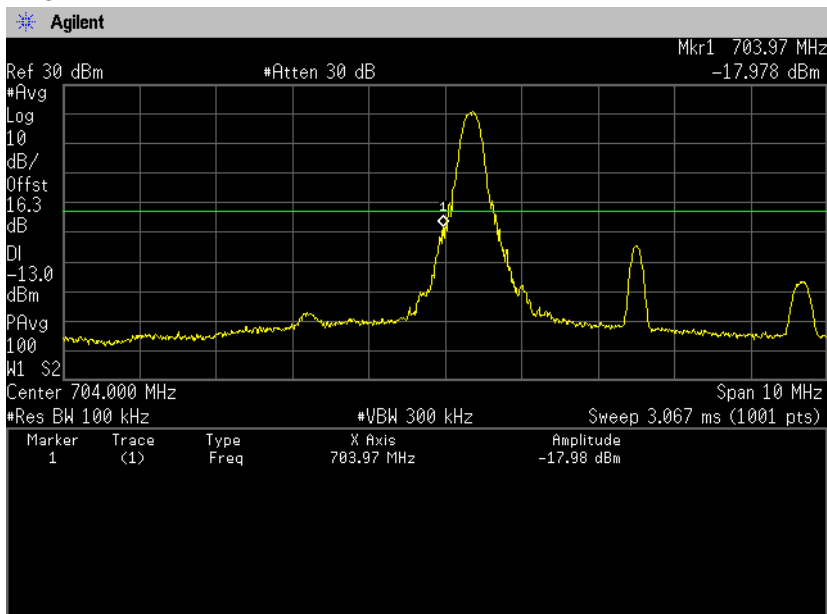

QPSK, BW 5MHz, RB1-24
Channel: High

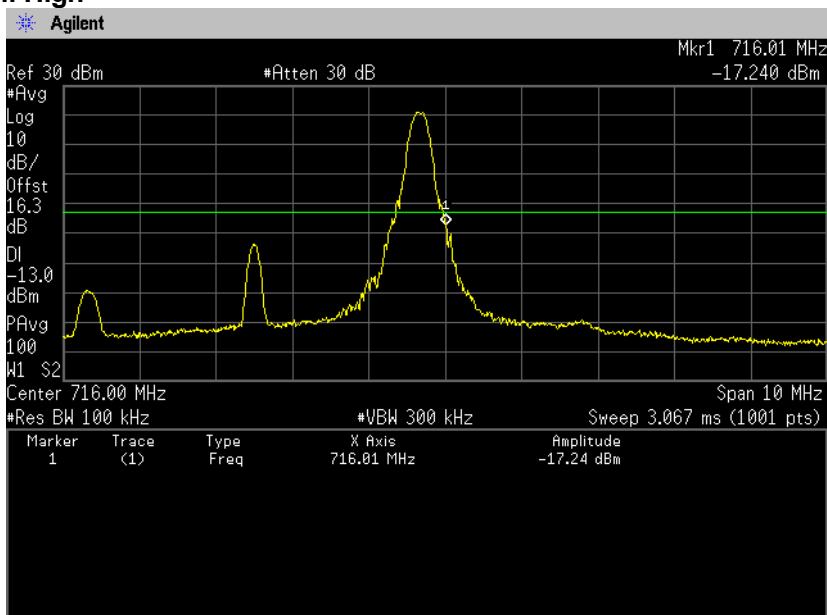



Zacta

QPSK, BW 5MHz, RB25-0
Channel: Low

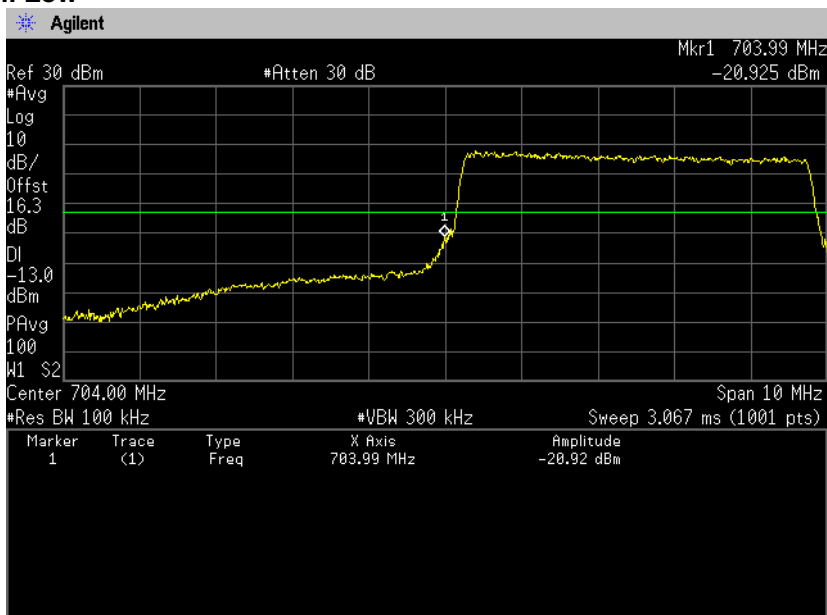

QPSK, BW 5MHz, RB25-0
Channel: High

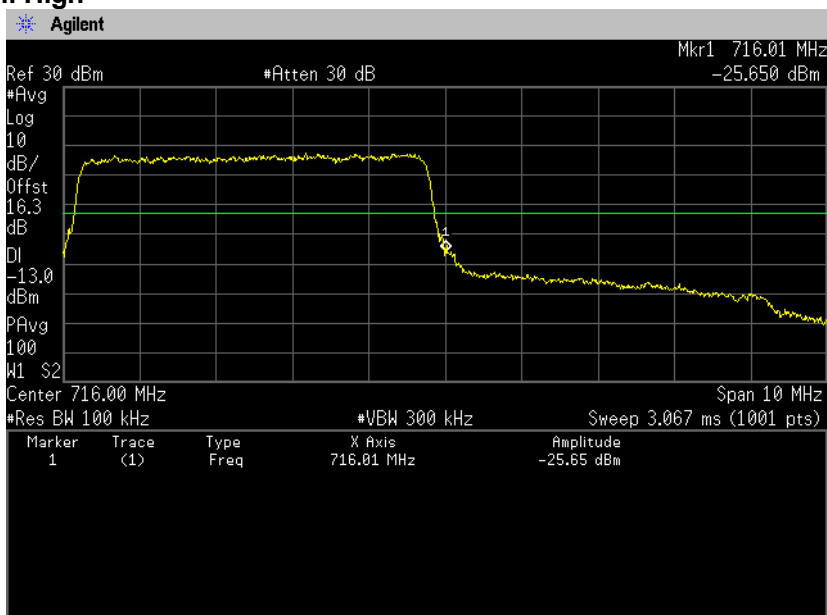

16QAM, BW 5MHz, RB1-0
Channel: Low

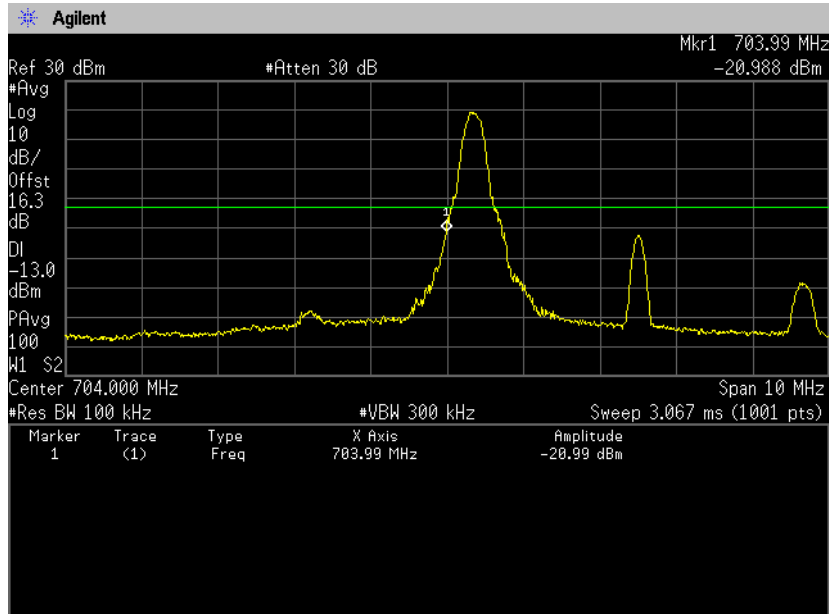

16QAM, BW 5MHz, RB1-24
Channel: High

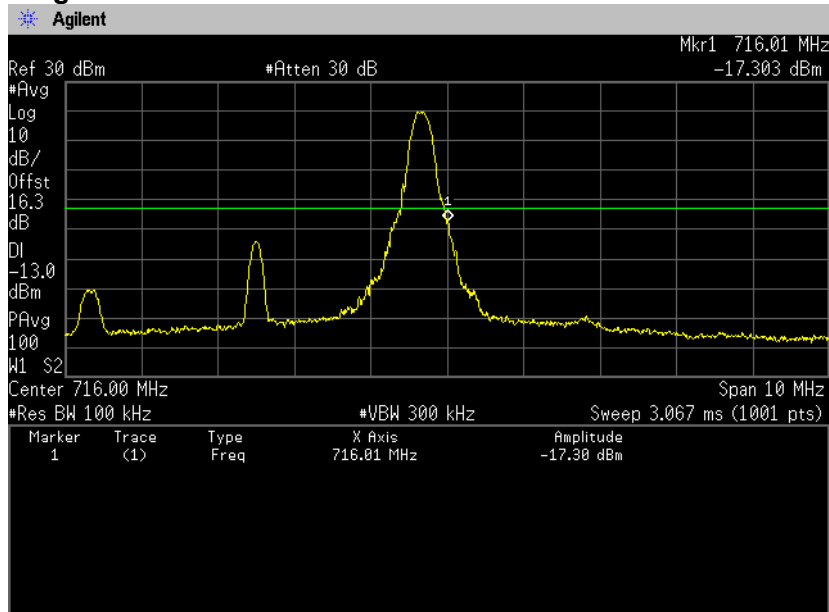



Zacta

16QAM, BW 5MHz, RB25-0
Channel: Low

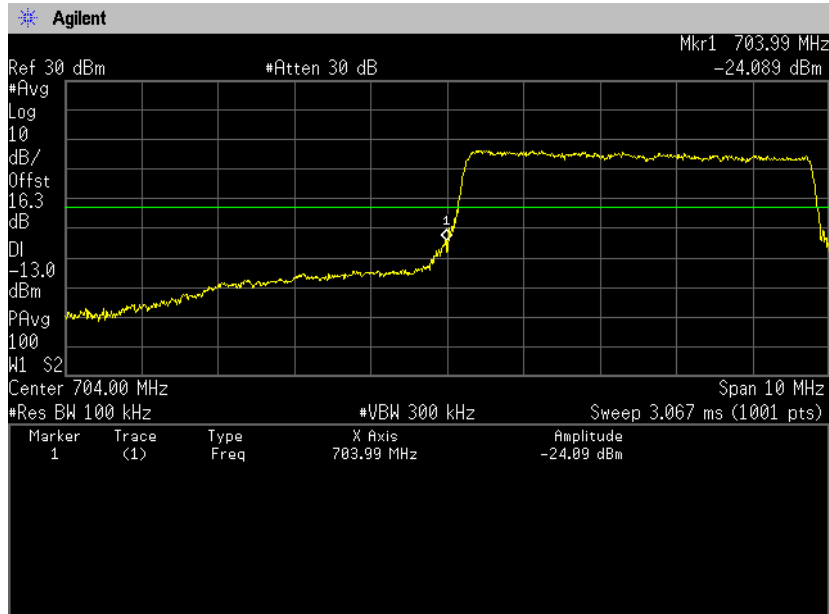

16QAM, BW 5MHz, RB25-0
Channel: High

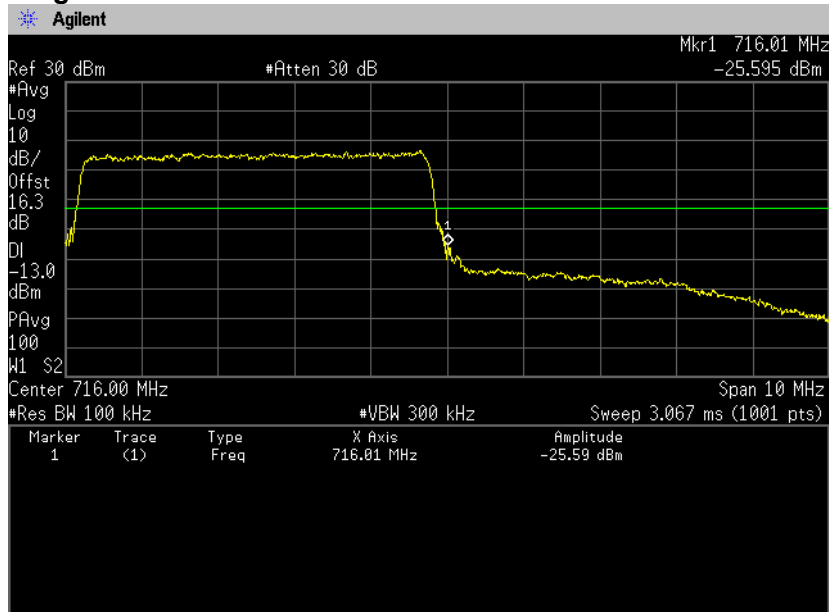



Zacta

QPSK, BW 10MHz, RB1-0
Channel: Low

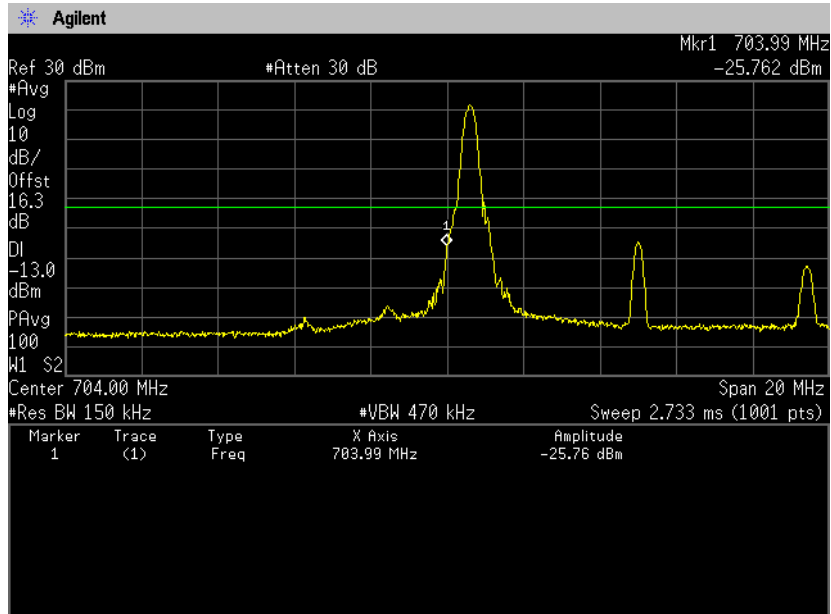

QPSK, BW 10MHz, RB1-49
Channel: High

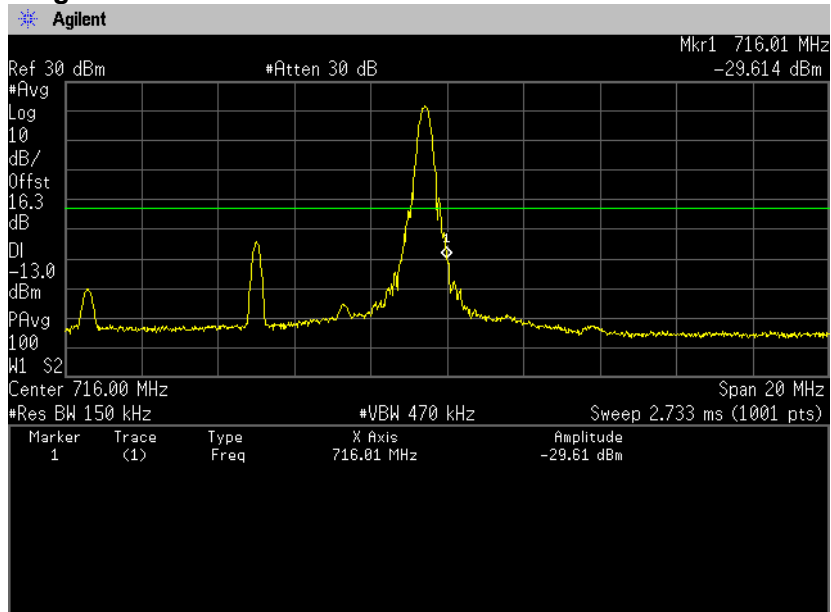



Zacta

QPSK, BW 10MHz, RB50-0
Channel: Low

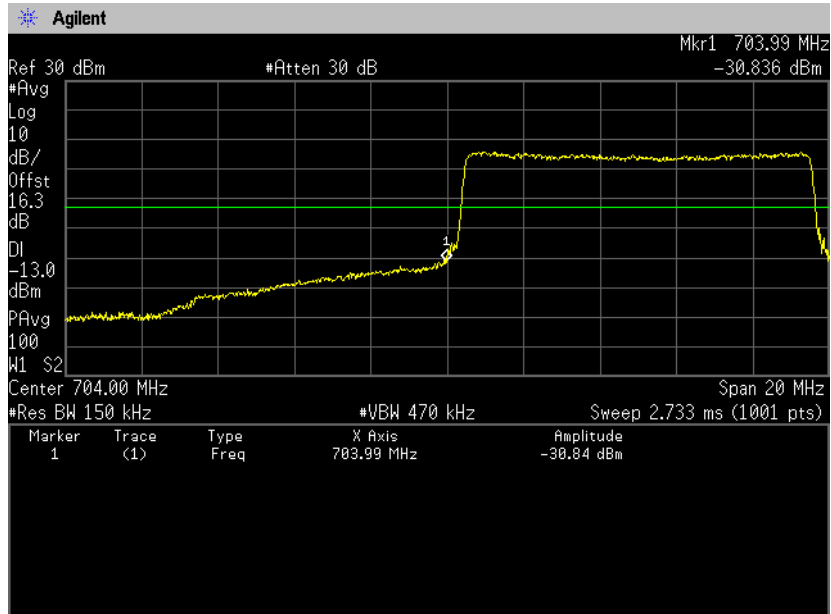

QPSK, BW 10MHz, RB50-0
Channel: High

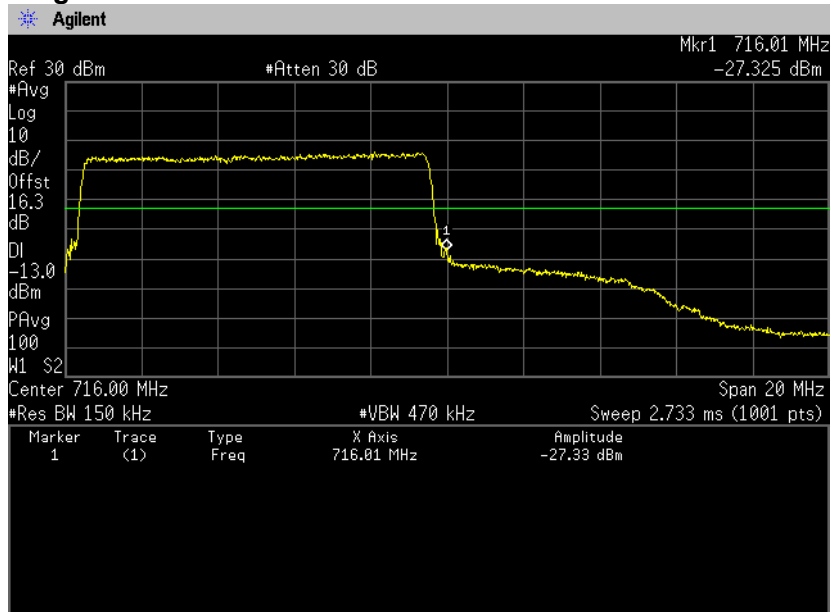



Zacta

16QAM, BW 10MHz, RB1-0
Channel: Low

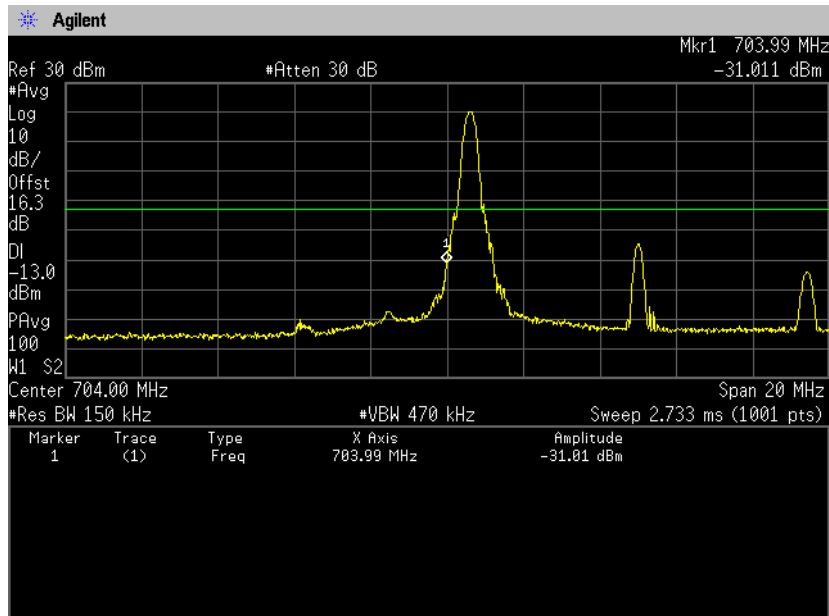

16QAM, BW 10MHz, RB1-49
Channel: High

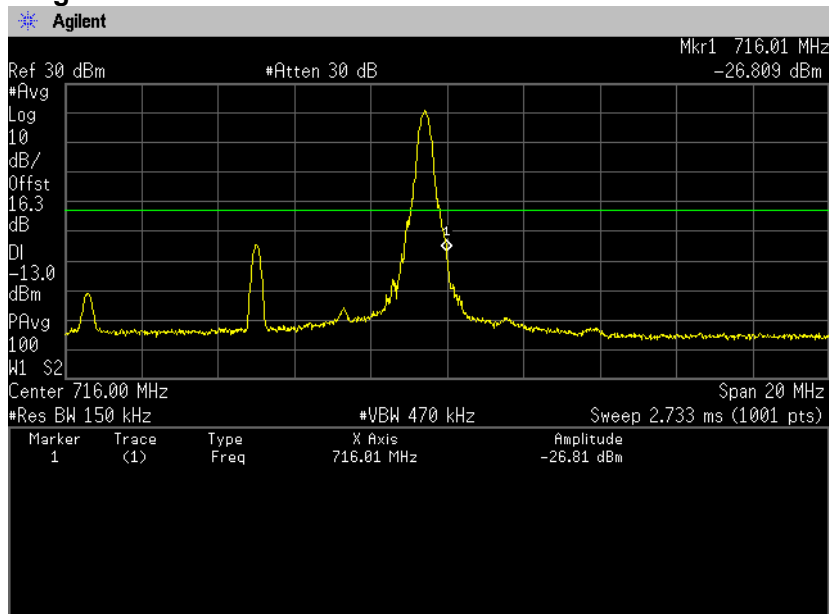

16QAM, BW 10MHz, RB50-0
Channel: Low

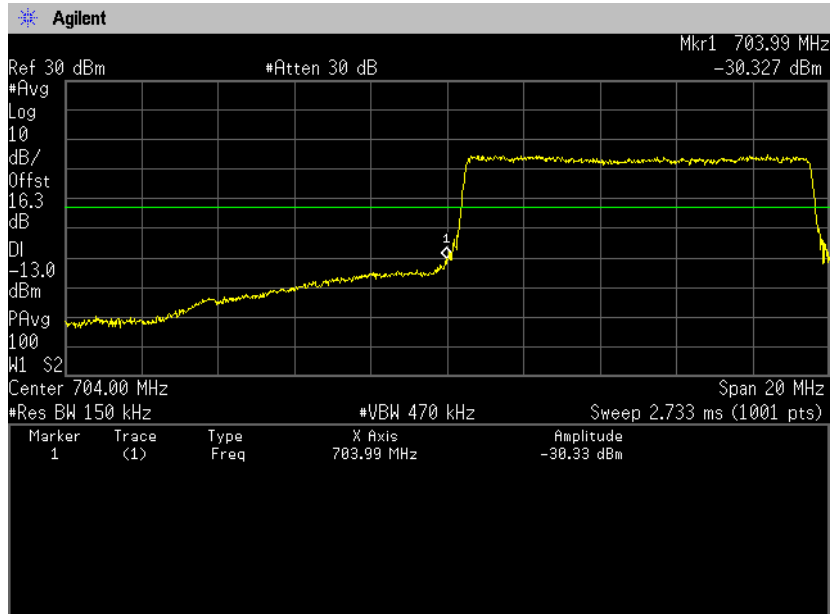

16QAM, BW 10MHz, RB50-0
Channel: High

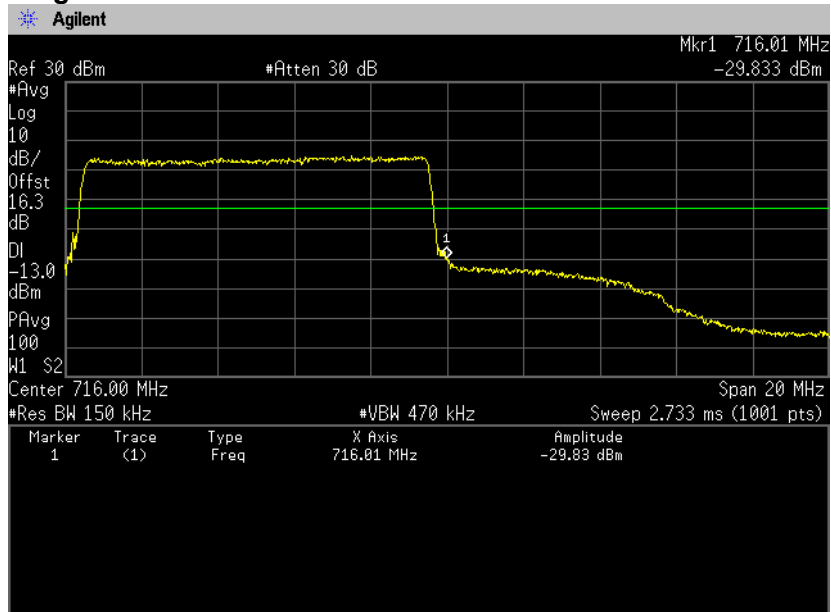

(Spurious Emissions)

Note: Conducted spurious test was measured in the worst case of conducted output power.

**1QPSK, BW 5MHz, RB1-24
Channel: 23755
30MHz-5GHz**

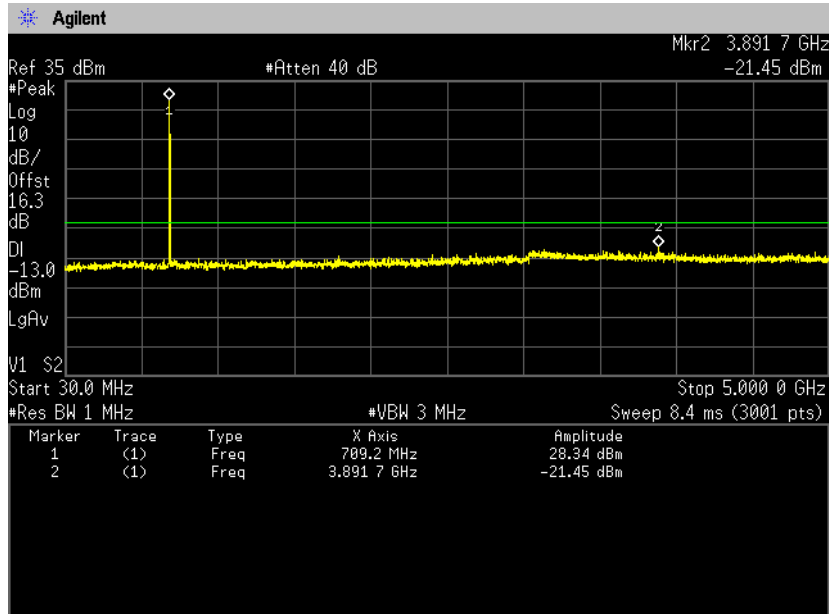

5GHz-10GHz

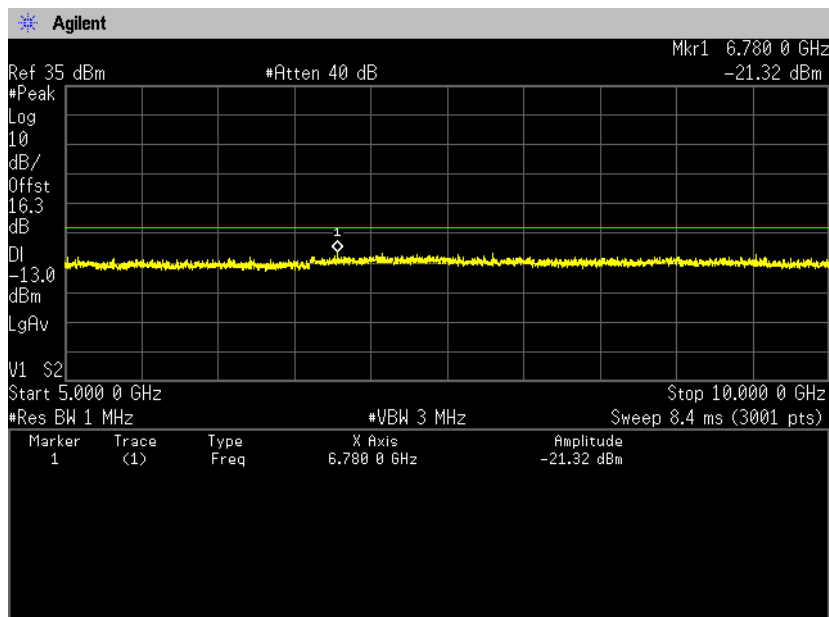



Zacta

**Channel: 23790
30MHz-5GHz**

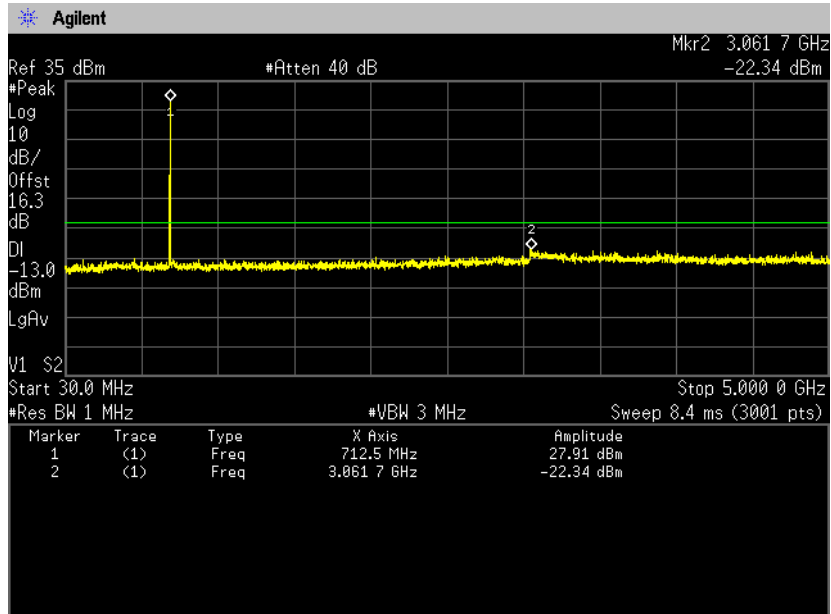

5GHz-10GHz

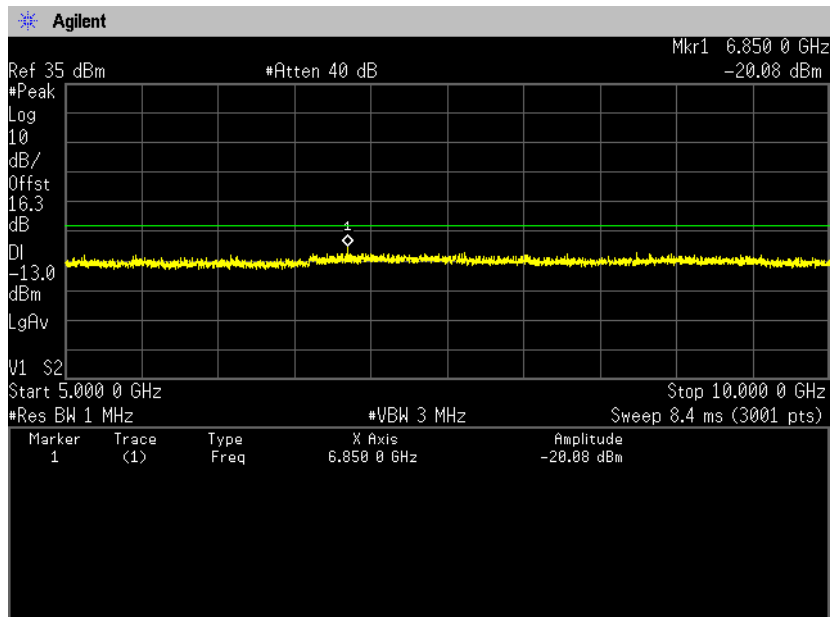



Zacta

**Channel: 23825
30MHz-5GHz**

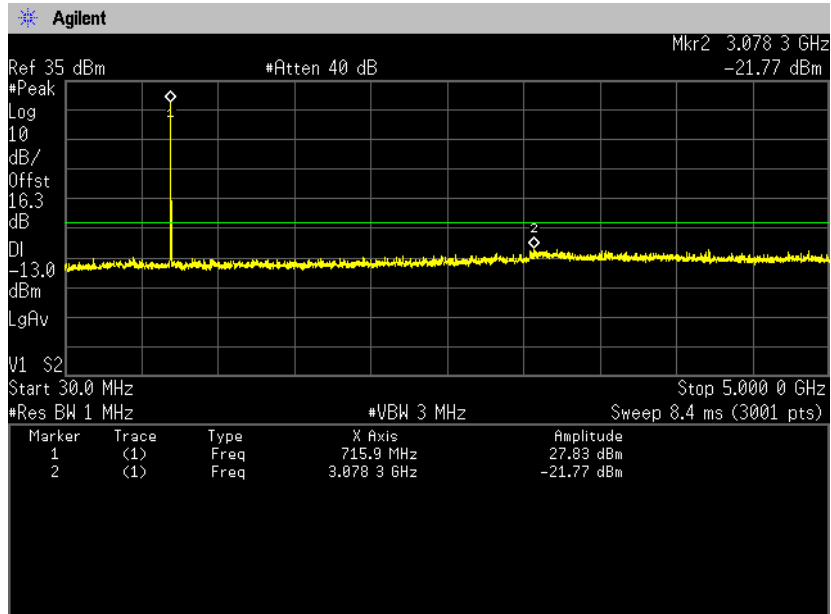

5GHz-10GHz

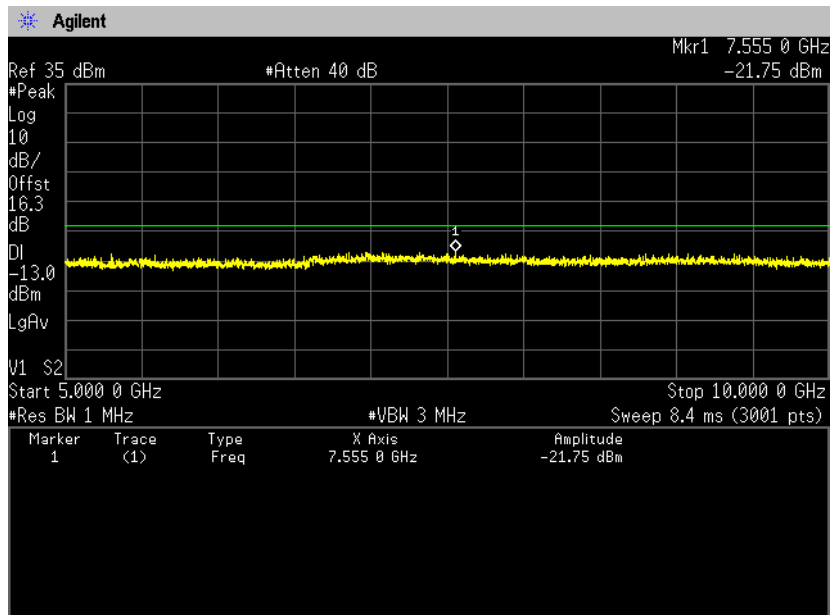



Zacta

16QAM, BW 10MHz, RB1-25
Channel: 23780
30MHz-5GHz

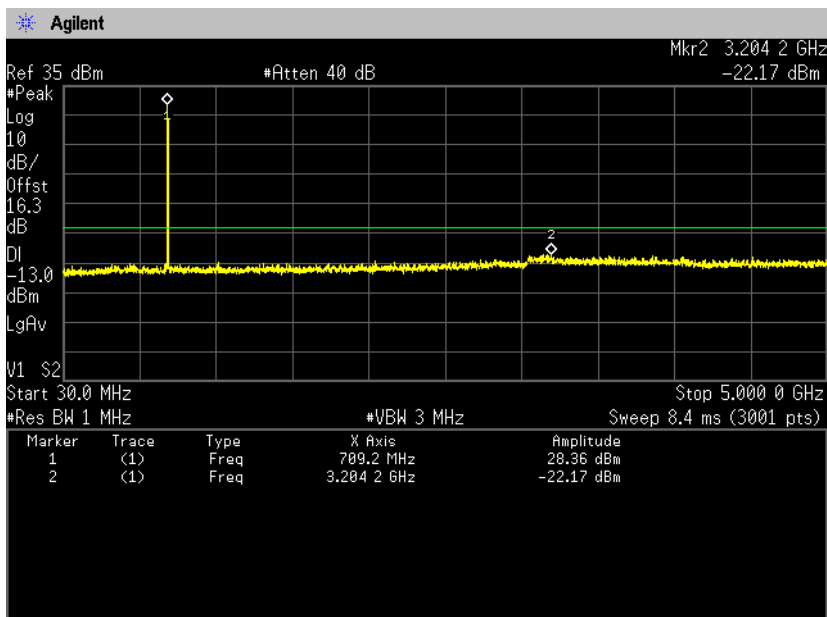

5GHz-10GHz

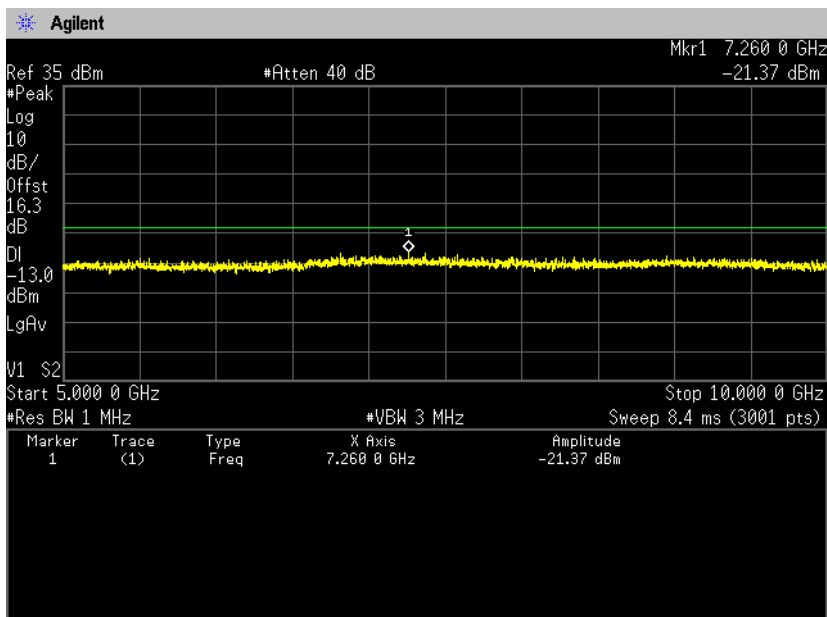



Zacta

**Channel: 23790
30MHz-5GHz**

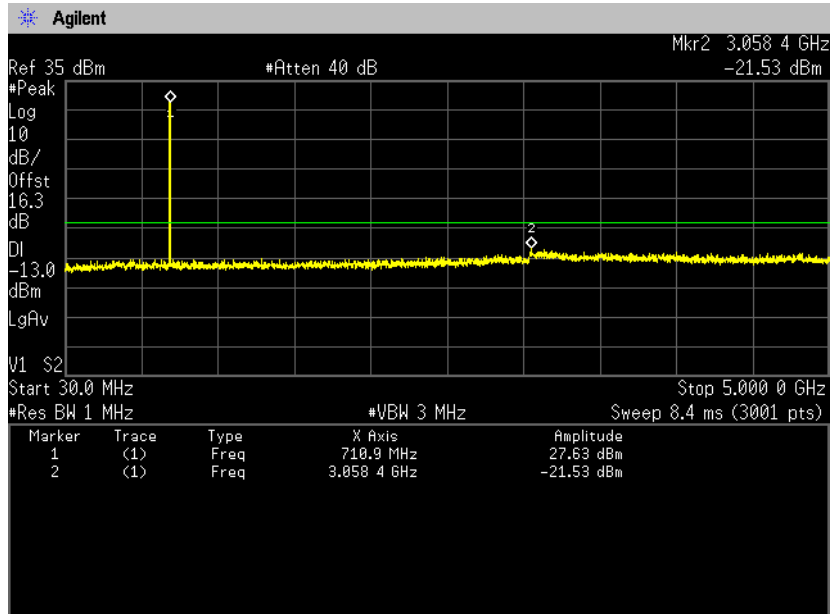

5GHz-10GHz

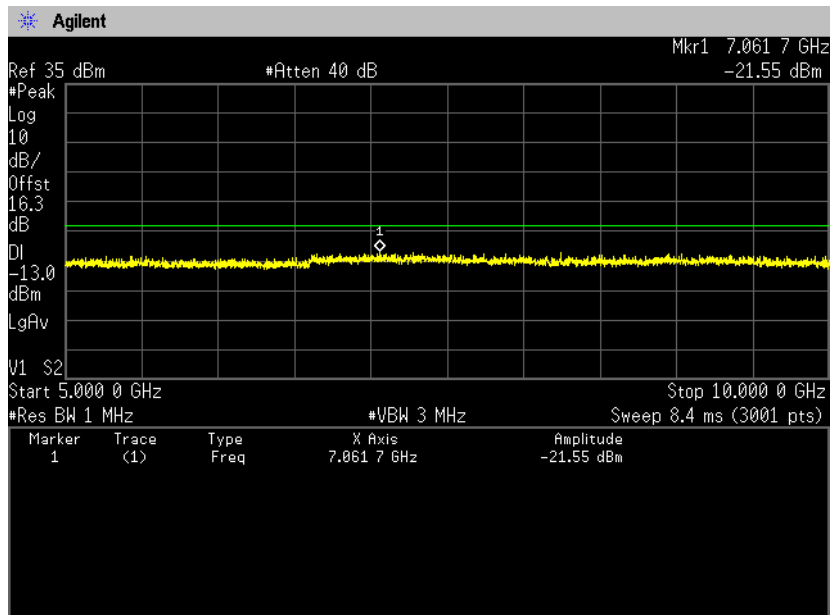



Zacta

**Channel: 23800
30MHz-5GHz**

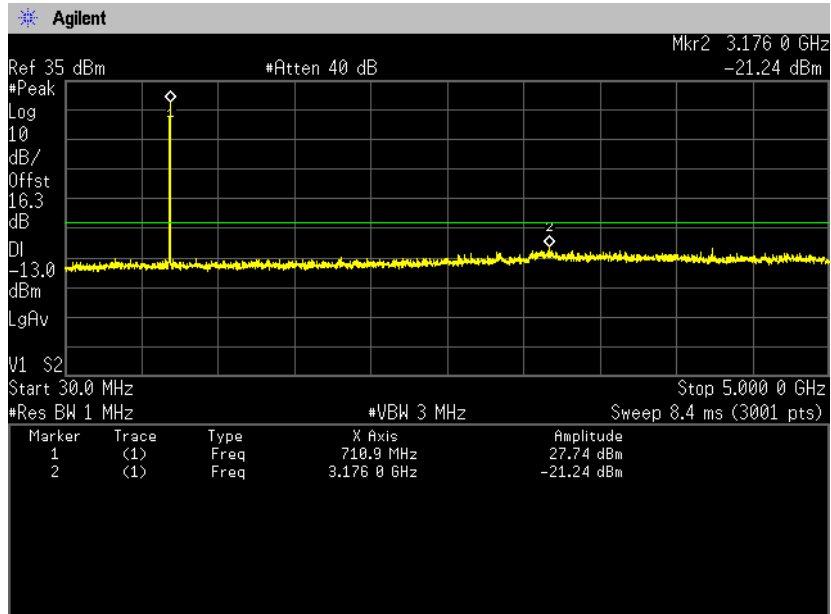

5GHz-10GHz

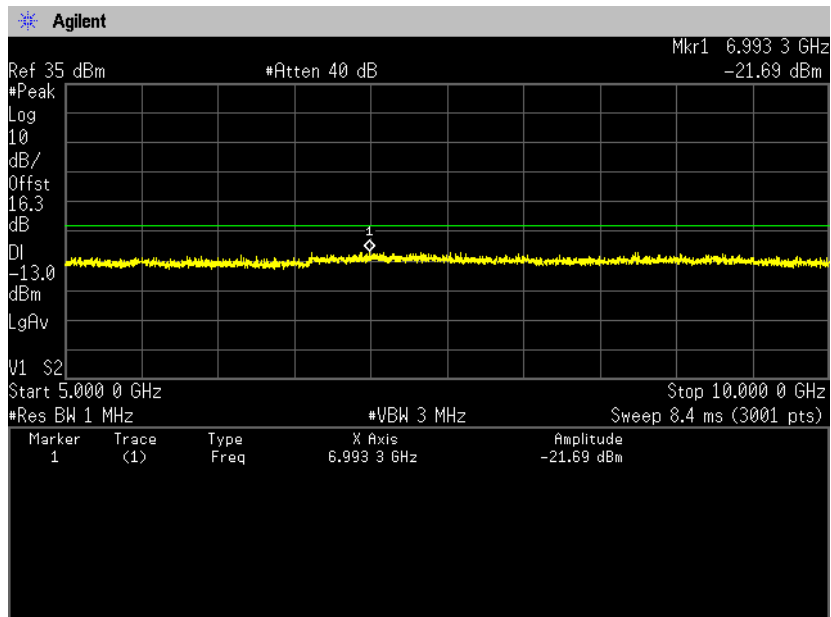

9. Radiated Emissions and Harmonic Emissions

9.1 Measurement procedure

[FCC 27.53(g), 2.1053, IC RSS-130 4.6]

<Step 1>

The EUT and support equipment are placed on a 1 meter x 1.5 meter surface, 0.8 meter height FRP table. Radiated emission measurements are performed at 3 meter distance with the broadband antenna (Biconical antenna, Log periodic antenna and double ridged guide antenna). The antenna is positioned both the horizontal and vertical planes of polarization and height is varied 1 to 4 meters and stopped at height producing the maximum emission.

The bandwidth of the spectrum analyzer is set to 1MHz. The turntable is rotated by 360 degrees and stopped at azimuth of producing the maximum emission. The frequency is investigated up to 20GHz.

<Step 2>

The substitution antenna is replaced by the transmitter antenna (EUT).

The frequency of the signal generator is adjusted to the measurement frequency.

Level of the signal generator is adjusted to the level that is obtained from step 1, and record the emission level of signal generator.

The spectrum analyzer is set to;

- RBW = 100kHz for below 1GHz and 1MHz for above 1GHz / VBW \geq 3 x RBW
- Detector = Peak
- Trace mode = Max hold
- Sweep time = auto-couple

- Test configuration

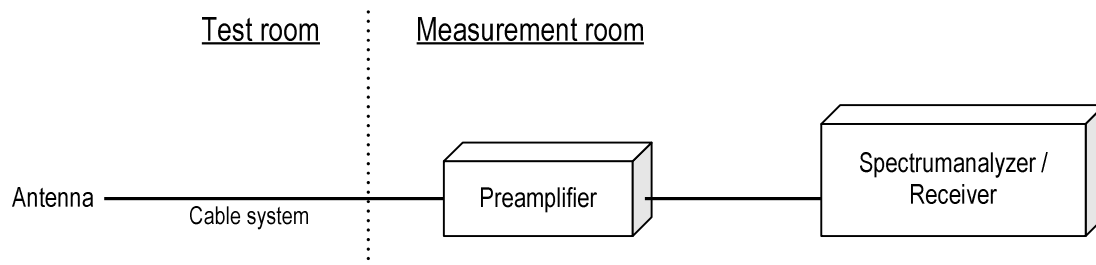

9.2 Calculation method

Result = S.G Reading – Cable loss + Antenna Gain

Margin = Limit – Result (ERP)

9.3 Limit

-13dBm or less



Zacta

9.4 Test data

Date : June 13, 2016
 Temperature : 22.5 [°C]
 Humidity : 60.6 [%]
 Test place : 3m Semi-anechoic chamber
 Test engineer : Taiki Watanabe

Date : June 17, 2016
 Temperature : 21.2 [°C]
 Humidity : 67.4 [%]
 Test place : 3m Semi-anechoic chamber
 Test engineer : Taiki Watanabe

[LTE Band X VII] QPSK, BW 5MHz Channel: 23775

H/V	Frequency [MHz]	S.A Reading [dBm]	S.G Reading [dBm]	Cable loss [dB]	Ant.Gain [dBd]	Result [dBm]	Limit [dBm]	Margin [dB]
H	1417.4	-51.1	-58.0	1.0	6.0	-53.0	-13.0	40.0
V	1417.4	-51.1	-55.1	1.0	6.0	-50.1	-13.0	37.1

Channel: 23790

H/V	Frequency [MHz]	S.A Reading [dBm]	S.G Reading [dBm]	Cable loss [dB]	Ant.Gain [dBd]	Result [dBm]	Limit [dBm]	Margin [dB]
H	1424.4	-54.5	-60.7	1.0	6.0	-55.7	-13.0	42.7
V	1424.4	-52.1	-57.0	1.0	6.0	-52.0	-13.0	39.0

Channel: 23825

H/V	Frequency [MHz]	S.A Reading [dBm]	S.G Reading [dBm]	Cable loss [dB]	Ant.Gain [dBd]	Result [dBm]	Limit [dBm]	Margin [dB]
H	1431.3	-52.8	-58.0	1.0	6.0	-53.0	-13.0	40.0
V	1431.3	-52.5	-58.0	1.0	6.0	-53.0	-13.0	40.0

16QAM, BW 5MHz**Channel: 23775**

H/V	Frequency [MHz]	S.A Reading [dBm]	S.G Reading [dBm]	Cable loss [dB]	Ant.Gain [dBd]	Result [dBm]	Limit [dBm]	Margin [dB]
H	1408.6	-53.3	-59.0	1.0	6.0	-54.0	-13.0	41.0
V	1408.6	-53.8	-60.2	1.0	6.0	-55.2	-13.0	42.2

Channel: 23790

H/V	Frequency [MHz]	S.A Reading [dBm]	S.G Reading [dBm]	Cable loss [dB]	Ant.Gain [dBd]	Result [dBm]	Limit [dBm]	Margin [dB]
H	1415.6	-52.8	-58.5	1.0	6.0	-53.5	-13.0	40.5
V	1415.6	-53.0	-60.0	1.0	6.0	-55.0	-13.0	42.0

Channel: 23825

H/V	Frequency [MHz]	S.A Reading [dBm]	S.G Reading [dBm]	Cable loss [dB]	Ant.Gain [dBd]	Result [dBm]	Limit [dBm]	Margin [dB]
H	1422.6	-53.6	-57.8	1.0	6.0	-52.8	-13.0	39.8
V	1422.6	-54.2	-61.4	1.0	6.0	-56.4	-13.0	43.4

QPSK, BW 10MHz**Channel: 23780**

H/V	Frequency [MHz]	S.A Reading [dBm]	S.G Reading [dBm]	Cable loss [dB]	Ant.Gain [dBd]	Result [dBm]	Limit [dBm]	Margin [dB]
H	1427.0	-53.3	-60.0	1.0	6.0	-55.0	-13.0	42.0
V	1427.0	-52.9	-57.2	1.0	6.0	-52.2	-13.0	39.2

Channel: 23790

H/V	Frequency [MHz]	S.A Reading [dBm]	S.G Reading [dBm]	Cable loss [dB]	Ant.Gain [dBd]	Result [dBm]	Limit [dBm]	Margin [dB]
H	1429.0	-55.0	-62.7	1.0	6.0	-57.7	-13.0	44.7
V	1429.0	-53.9	-61.5	1.0	6.0	-56.5	-13.0	43.5

Channel: 23800

H/V	Frequency [MHz]	S.A Reading [dBm]	S.G Reading [dBm]	Cable loss [dB]	Ant.Gain [dBd]	Result [dBm]	Limit [dBm]	Margin [dB]
H	1430.8	-55.6	-61.4	1.0	6.0	-56.4	-13.0	43.4
V	1430.8	-53.0	-58.5	1.0	6.0	-53.5	-13.0	40.5

16QAM, BW 10MHz**Channel: 23780**

H/V	Frequency [MHz]	S.A Reading [dBm]	S.G Reading [dBm]	Cable loss [dB]	Ant.Gain [dBd]	Result [dBm]	Limit [dBm]	Margin [dB]
H	1417.6	-53.2	-60.7	1.0	6.0	-55.7	-13.0	42.7
V	1417.6	-53.2	-60.0	1.0	6.0	-55.0	-13.0	42.0

Channel: 23790

H/V	Frequency [MHz]	S.A Reading [dBm]	S.G Reading [dBm]	Cable loss [dB]	Ant.Gain [dBd]	Result [dBm]	Limit [dBm]	Margin [dB]
H	1420.0	-51.9	-59.5	1.0	6.0	-54.5	-13.0	41.5
V	1420.0	-51.7	-56.7	1.0	6.0	-51.7	-13.0	38.7

Channel: 23800

H/V	Frequency [MHz]	S.A Reading [dBm]	S.G Reading [dBm]	Cable loss [dB]	Ant.Gain [dBd]	Result [dBm]	Limit [dBm]	Margin [dB]
H	1422.0	-52.3	-59.5	1.0	6.0	-54.5	-13.0	41.5
V	1422.0	-53.8	-58.0	1.0	6.0	-53.0	-13.0	40.0

10. Frequency Stability

10.1 Measurement procedure

[FCC 27.54, 2.1055, IC RSS-130 4.3]

The EUT was placed inside of a constant temperature chamber as the temperature in the chamber was varied between -30°C and $+50^{\circ}\text{C}$. The temperature was incremented by 10°C intervals and the unit was allowed to stabilize at each measurement. The frequency drift was measured with the normal Temperature and voltage tolerance and it is presented as the ppm unit.

- Test configuration

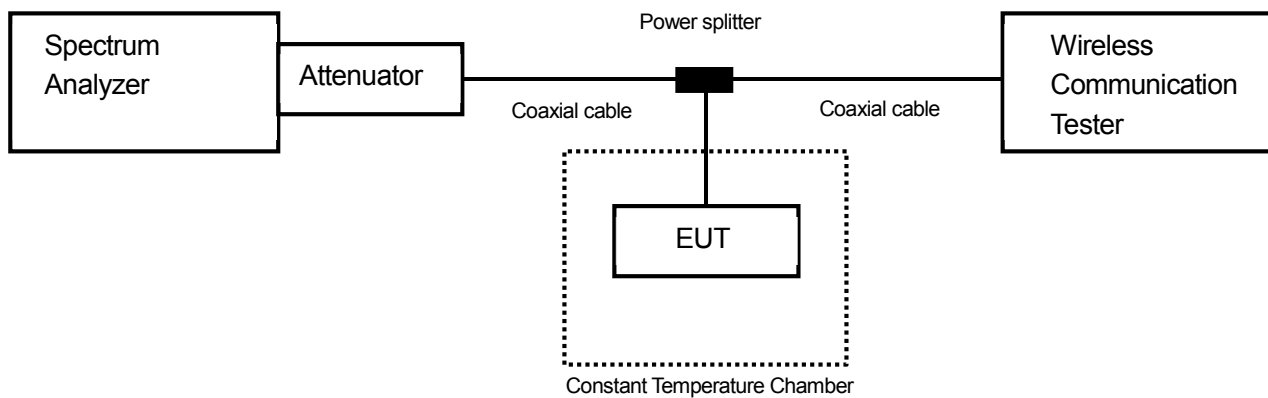

10.2 Limit

$\pm 2.5\text{ppm}$

10.3 Measurement result

Date : June 9, 2016
 Temperature : 19.4 [°C]
 Humidity : 45.5 [%]
 Test place : Shielded room No.4

Test engineer : Chiaki Kanno

[LTE Band X VII] (Channel: 23790)

Limit: $\pm 0.00025\% = \pm 2.5\text{ppm}$					
Power Supply [V]	Temperature [°C]	Measurements Frequency [Hz]	Frequency Tolerance [ppm]	Limit [ppm]	Result
3.90	25(Ref.)	709,999,992	0.00000	± 2.5	Pass
	50	709,999,992	0.00042	± 2.5	Pass
	40	709,999,993	0.00145	± 2.5	Pass
	30	709,999,992	0.00042	± 2.5	Pass
	20	709,999,992	0.00130	± 2.5	Pass
	10	709,999,994	0.00379	± 2.5	Pass
	0	709,999,992	0.00135	± 2.5	Pass
	-10	709,999,994	0.00382	± 2.5	Pass
	-20	709,999,995	0.00439	± 2.5	Pass
	-30	709,999,992	-0.00004	± 2.5	Pass
3.315	25	709,999,992	0.00073	± 2.5	Pass
4.485	25	709,999,992	0.00117	± 2.5	Pass

Calculation;

$$\text{Frequency Tolerance (ppm)} = \frac{\text{Measurements Frequency (Hz)} - \text{Reference Frequency (Hz)}}{\text{Reference Frequency (Hz)}} \times 1000000$$

11. Uncertainty of measurement

Expanded uncertainties stated are calculated with a coverage Factor $k=2$.

Please note that these results are not taken into account when determining compliance or non-compliance with test result.

Test item	Measurement uncertainty
Conducted emission at mains port	$\pm 3.0\text{dB}$
Radiated emission (9kHz – 30MHz)	$\pm 4.4\text{dB}$
Radiated emission (30MHz – 1000MHz)	$\pm 4.5\text{dB}$
Radiated emission (1000MHz – 26GHz)	$\pm 3.9\text{dB}$

12. Laboratory description

1. Location:

TÜV SÜD Zacta Ltd. Yonezawa Testing Center
 4149-7 Hachimanpara 5-chome Yonezawa-shi Yamagata 992-1128 Japan
 Phone: +81-238-28-2880 Fax: +81-238-28-2888

2. Facility filing information:

1) NVLAP accreditation: NVLAP Lab. code: 200306-0

2) VLAC accreditation: Lab. code: VLAC-013

Site name	Radiated emission	Conducted emission for mains port	Conducted emission for telecom port	Radiated emission (CMAD)	Expiry Date
3m Semi-anechoic chamber	VLAC-013	VLAC-013	VLAC-013	-	Jul. 3, 2017
10m Semi-anechoic chamber No.1				VLAC-013	
10m Semi-anechoic chamber No.2				VLAC-013	
Shielded room No.1	-	VLAC-013	-	-	

3) FCC filing:

Site name	Registration Number	Expiry Date
Site 3	91065	Oct. 1, 2017
3m Semi-anechoic chamber	540072	Feb. 20, 2017
10m Semi-anechoic chamber No.1		
10m Semi-anechoic chamber No.2		
Shielded room No.1		

4) Industry Canada Oats site filing:

Site name	Sites on file: Oats 3m/10m	Expiry Date
Site 3	4224A-3	Dec. 3, 2017
3m Semi-anechoic chamber	4224A-4	
10m Semi-anechoic chamber No.1	4224A-5	
10m Semi-anechoic chamber No.2	4224A-6	Jan. 15, 2017

5) VCCI site filing:

Site name	Radiated emission	Conducted emission for mains port	Conducted emission for telecom port	Expiry Date
Site 3	R-138	C-134	T-1222	Nov. 16, 2017
3m Semi-anechoic chamber	-	A-0166	A-0166	Jul. 3, 2017
10m Semi-anechoic chamber No.1				
10m Semi-anechoic chamber No.2				
Shielded room No.1	-	A-0166		

6) TÜV SÜD PS authorization:

Authorized as an EMC test laboratory

7) TÜV Rheinland authorization:

Authorized as an EMC test laboratory

Appendix A. Test equipment

Antenna port conducted test

Equipment	Company	Model No.	Serial No.	Cal. due	Cal. date
Spectrum analyzer	Agilent Technologies	E4440A	US40420937	Jul. 31, 2016	Jul. 23, 2015
Attenuator	Weinschel	56-10	J4180	Nov. 30, 2016	Nov. 12, 2015
Microwave cable	SUHNER	SUCOFLEX104	199119/4	Feb. 28, 2017	Feb. 29, 2016
Microwave cable	SUHNER	SUCOFLEX104	322087/4	Jul. 31, 2016	Jul. 29, 2015
Power splitter	ANRITSU	K240B	1301239	Jul. 31, 2016	Jul. 12, 2015
Wideband radio frequency tester	ROHDE&SCHWARZ	CMW500	116338	May 31, 2017	May 18, 2016
Operation type temperature controlled bath	Espec	PL1KP	14007261	Jan. 31, 2017	Jan. 22, 2016

Radiated emission

Equipment	Company	Model No.	Serial No.	Cal. Due	Cal. Date
EMI Receiver	ROHDE&SCHWARZ	ESCI	100764	Aug. 31, 2016	Aug. 21, 2015
Preamplifier	ANRITSU	MH648A	M96057	May 31, 2017	May 10, 2016
Biconical antenna	Schwarzbeck	VHA9103/BBA9106	2155	Jun. 30, 2017	Jun. 2, 2016
Log periodic antenna	Schwarzbeck	UHALP9108A	0560	Jun. 30, 2017	Jun. 2, 2016
Attenuator	TME	CFA-01NPJ-6	N/A (S275)	May 31, 2017	May 10, 2016
Attenuator	TME	CFA-01NPJ-3	N/A (S272)	May 31, 2017	May 10, 2016
Spectrum analyzer	Agilent Technologies	E4440A	US44302655	May 31, 2017	May 24, 2016
Preamplifier	TSJ	MLA-100M18-B02-40	1929118	May 31, 2017	May 11, 2016
Dipole antenna	Schwarzbeck	VHAP	1021	Oct. 31, 2016	Oct. 2, 2015
Dipole antenna	Schwarzbeck	UHAP	993	Oct. 31, 2016	Oct. 2, 2015
Double ridged guide antenna	EMCO	3115	5205	Mar. 31, 2017	Mar. 3, 2016
Attenuator	Agilent Technologies	8491B	MY39268633	Feb. 28, 2017	Feb. 23, 2016
Double ridged guide antenna	EMCO	3115	000058532	Nov. 30, 2016	Nov. 6, 2015
Signal generator	ROHDE&SCHWARZ	SMB100A	177525	Jun. 30, 2016	Jun. 19, 2015
Power amplifier	R&K	CGA020M602-2633R	B40240	May 31, 2017	May 10, 2016
Microwave cable	SUHNER	SUCOFELX102/2m	31648/2	Mar. 31, 2017	Mar. 29, 2016
High pass filter	Micro-Tronics	HPM50115	004	Jul. 31, 2016	Jul. 12, 2015
Wideband radio frequency tester	ROHDE&SCHWARZ	CMW500	126079	Sep. 30, 2016	Sep. 15, 2015
Microwave cable	SUHNER	SUCOFLEX104/9m	MY30037/4	May 31, 2017	May 10, 2016
		SUCOFLEX104/1m	MY24610/4	May 31, 2017	May 10, 2016
		SUCOFLEX104/1.5m	317226/4	May 31, 2017	May 10, 2016
		SUCOFLEX104/7m	41625/6	May 31, 2017	May 10, 2016
PC	DELL	DIMENSION E521	75465BX	N/A	N/A
Software	TOYO Corporation	EP5/RE-AJ	0611193/V5.4.011	N/A	N/A
3m Semi-anechoic chamber	TOKIN	N/A	N/A (9002-NSA)	May 31, 2017	May 11, 2016
3m Semi-anechoic chamber	TOKIN	N/A	N/A (9002-SVSWR)	May 31, 2017	May 12, 2016

*: The calibrations of the above equipment are traceable to NIST or equivalent standards of the reference organizations.