



Zacta

TEST REPORT

Report number : Z101C-15079

Issue date : August 24, 2015

The device, as described herewith, was tested pursuant to applicable test procedure and complies with the requirements of;

FCC Part 27 Subpart C IC RSS-139

The test results are traceable to the international or national standards.

Applicant	: KYOCERA Corporation
Equipment under test (EUT)	: Module
Model number	: J79
FCC ID	: JOYJ79
IC Certification Number	: 574B-J79

Date of test : June 18, 19, 23, 24, 25, 29, 30, July 2, 4, 2015

Test place : TÜV SÜD Zacta Ltd. Yonezawa Testing Center
4149-7 Hachimanpara 5-chome
Yonezawa-shi Yamagata 992-1128 Japan
Phone: +81-238-28-2880 Fax: +81-238-28-2888

Test results : Complied

The results in this report are applicable only to the equipment tested.

This report shall not be re-produced except in full without the written approval of TÜV SÜD Zacta Ltd.

This test report must not be used by the client to claim product certification, approval, or endorsement by NVLAP, NIST, or any agency of the federal government.

Tested by : Taiki Watanabe
Taiki Watanabe

Tested by : Hikaru Shibata
Hikaru Shibata

Authorized by : Hiroaki Suzuki
Hiroaki Suzuki
Manager of EMC Technical Department



Table of contents

	Page
1. Summary of Test	4
1.1 Purpose of test	4
1.2 Standards	4
1.3 List of applied test to the EUT	4
1.4 Modification to the EUT by laboratory	4
2. Equipment Under Test	5
2.1 General Description of equipment	5
2.2 EUT information	5
2.3 Variation of the family model(s)	6
2.4 Description of Test mode	6
3. Configuration of equipment	7
3.1 Equipment(s) used	7
3.2 Cable(s) used	7
3.3 System configuration	7
4. Conducted Output Power	8
4.1 Measurement procedure	8
4.2 Measurement result	8
5. Equivalent Isotropic Radiated Power	12
5.1 Measurement procedure	12
5.2 Calculation method	12
5.3 Limit	12
5.4 Test data	13
6. Peak to Average Ratio	16
6.1 Measurement procedure	16
6.2 Limit	16
6.3 Measurement result	16
6.4 Trace data	17
7. Occupied Bandwidth	23
7.1 Measurement procedure	23
7.2 Limit	23
7.3 Measurement result	24
7.4 Trace data	25
8. Band Edge Spurious and Harmonic at Antenna Terminals	37
8.1 Measurement procedure	37
8.2 Limit	37
8.3 Measurement result	37
8.4 Trace data	38
9. Radiated Emissions and Harmonic Emissions	74
9.1 Measurement procedure	74
9.2 Calculation method	74
9.3 Limit	74
9.4 Test data	75
10. Frequency Stability	86



Zacta

10.1 Measurement procedure	86
10.2 Limit	86
10.3 Measurement result	87
11. Uncertainty of measurement	88
12. Laboratory description	89
Appendix A. Test equipment	90



Zacta

1. Summary of Test

1.1 Purpose of test

It is the original test in order to verify conformance to FCC Part 27 Subpart C, IC RSS-139.

1.2 Standards

CFR47 FCC Part 27 Subpart C
IC RSS-139

1.2.1 Test Methods

KDB 971168 D01 Power Meas License Digital Systems v02r02
ANSI/TIA/EIA-603-D-2010

1.2.2 Deviation from standards

None

1.3 List of applied test to the EUT

FCC Section	IC Section	Test items	Condition	Result
2.1046	N/A	Conducted Output Power	Conducted	PASS
27.50(d)(4)	RSS-139 6.4	Equivalent Isotropic Radiated Power	Radiated	PASS
27.50(d)(5)	RSS-139 6.4	Peak to Average Ratio	Conducted	PASS
2.1049	RSS-139 2.3	Occupied Bandwidth	Conducted	PASS
27.53(h) 2.1051	RSS-139 6.5	Band Edge Spurious and Harmonic at Antenna Terminal	Conducted	PASS
27.53(h) 2.1053	RSS-139 6.5, 6.6	Radiated emissions and Harmonic Emissions	Radiated	PASS
27.54 2.1055	RSS-139 6.3	Frequency Stability	Conducted	PASS

1.3.1 Test set up

Table-Top

1.4 Modification to the EUT by laboratory

None



Zacta

2. Equipment Under Test

2.1 General Description of equipment

EUT is the Module.

2.2 EUT information

Applicant : KYOCERA Corporation
Yokohama Office 2-1-1 Kagahara, Tsuzuki-ku Yokohama-shi, Kanagawa,
Japan
Phone: +81-45-943-6253 Fax: +81-45-943-6314

Equipment under test : Module

Trade name : Kyocera

Model number : J79

Serial number : N/A

EUT condition : Pre-Production

Power ratings : DC 3.9V

Size : (W) 40.0 × (D) 40.0 × (H) 4.3 mm

Environment : Indoor and Outdoor use

Terminal limitation : -20°C to 60°C

RF Specification
Frequency of Operation : Up Link
LTE Band IV: 1710-1755MHz
Down Link
LTE Band IV: 2110-2155MHz

Modulation type : QPSK, 16QAM

Emission designator : BW 1.4M QPSK: 1M11G7D, 16QAM: 1M11W7D
BW 3M QPSK: 2M71G7D, 16QAM: 2M73W7D
BW 5M QPSK: 4M52G7D, 16QAM: 4M52W7D
BW 10M QPSK: 8M99G7D, 16QAM: 9M00W7D
BW 15M QPSK: 13M46G7D, 16QAM: 13M44W7D
BW 20M QPSK: 17M91G7D, 16QAM: 17M91W7D

Conducted
Output power : QPSK: 0.188W (22.74dBm)
16QAM: 0.150W (21.75dBm)

Antenna type : External antenna

Antenna gain : 4.0dBi

2.3 Variation of the family model(s)

Not applicable

2.4 Description of Test mode

The EUT had been tested under operating condition.
There are three channels have been tested as following:

Band	Modulation	Bandwidth	Channel	Frequency [MHz]
LTE Band IV	QPSK	1.4MHz	19957	1710.7
			20175	1732.5
			20393	1754.3
		3MHz	19965	1711.5
			20175	1732.5
			20385	1753.5
	5MHz	19975	1712.5	
		20175	1732.5	
	10MHz	20000	1715.0	
		20175	1732.5	
	15MHz	20350	1750.0	
		20025	1717.5	
	20MHz	20175	1732.5	
		20325	1747.5	
LTE Band IV	16QAM	1.4MHz	20050	1720.0
			20175	1732.5
			20300	1745.0
		3MHz	19957	1710.7
			20175	1732.5
			20393	1754.3
	5MHz	19965	1711.5	
		20175	1732.5	
		20385	1753.5	
	10MHz	19975	1712.5	
		20175	1732.5	
	15MHz	20375	1752.5	
		20000	1715.0	
	20MHz	20175	1732.5	
20350		1750.0		
20MHz	20025	1717.5		
	20175	1732.5		
20MHz	20325	1747.5		
	20050	1720.0		
20MHz	20175	1732.5		
	20300	1745.0		

The field strength of spurious emissions was measured at each position of all three axis X, Y and Z to compare the level, and the maximum noise.

The worst emission was found in Z axis and the worst case recorded.

3. Configuration of equipment

3.1 Equipment(s) used

No.	Equipment	Company	Model No.	Serial No.	FCC ID / DoC	Comment
1	Module	KYOCERA	J79	N/A	JOYJ79	EUT
2	JOINT BOARD	KYOCERA	N/A	N/A	N/A	-
3	SHARK Antenna	YOKOWO	N/A	N/A	N/A	-
4	Whip Antenna	EAD	PTR7210	N/A	N/A	-
5	GPS Antenna	PASTERNAK	PE51066	N/A	N/A	-

3.2 Cable(s) used

No.	Cable	Length[m]	Shield	Connector	Comment
a	RF cable (MAIN)	0.3	YES	Metal	-
b	RF cable (SUB)	0.3	YES	Metal	-
c	GPS Antenna cable	5.0	YES	Metal	-
d	DC cable	1.3	NO	Plastic	-
e	RF cable	0.9	YES	Metal	-

3.3 System configuration

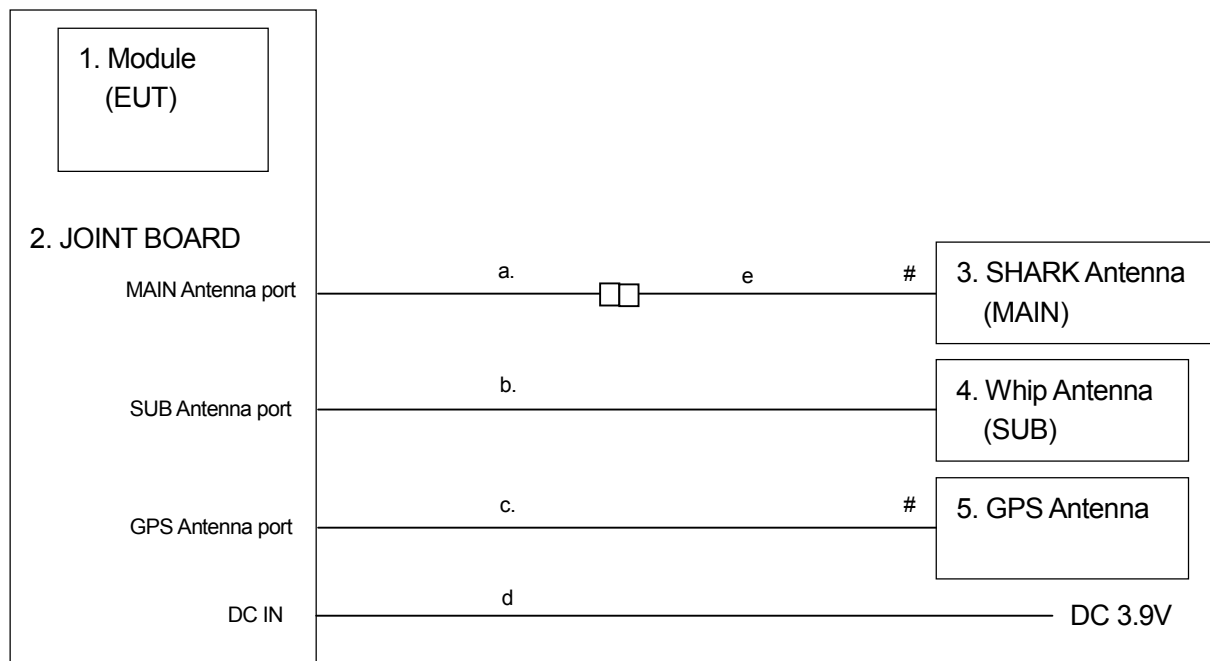

: Un-detachable cable

 : Connector

Note1: Numbers assigned to equipment or cables on this diagram correspond to the list in "3.1 Equipment(s) used" and "3.2 Cable(s) used".

4. Conducted Output Power

4.1 Measurement procedure [FCC 2.1046]

The conducted output power was measured with a wireless communication tester connected to the antenna terminal. The wireless communication tester parameters were set to produce the maximum power from the EUT.

- Test configuration

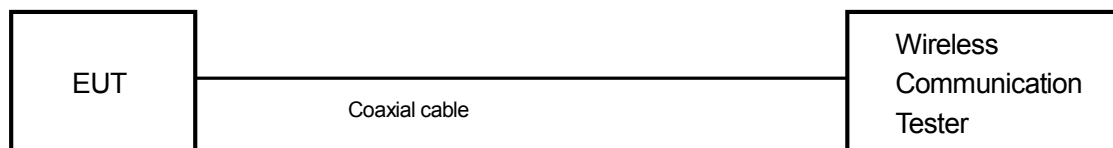

4.2 Measurement result

Date : June 16, 2015
 Temperature : 24.0 [°C]
 Humidity : 45.0 [%]
 Test place : Shielded room No.4

Test engineer :

Hikaru Shibata

Band	BW [MHz]	Mode	RB Allocation	RB offset	Target MPR	Avg Power[dBm]		
						19957	20175	20393
						1710.7 MHz	1732.5 MHz	1754.3 MHz
LTE Band 4	1.4	QPSK	1	0	0	22.61	22.47	22.63
			1	3	0	22.64	22.45	22.69
			1	5	0	22.58	22.46	22.71
			3	0	0	22.68	22.43	22.58
			3	1	0	22.68	22.43	22.67
			3	3	0	22.64	22.44	22.70
		16QAM	6	0	1	21.67	21.47	21.67
			1	0	1	21.39	21.34	21.52
			1	3	1	21.37	21.39	21.62
			1	5	1	21.37	21.39	21.66
			3	0	1	21.74	21.45	21.49
			3	1	1	21.75	21.45	21.58
			3	3	1	21.74	21.46	21.60
			6	0	2	20.76	20.50	20.74



Zacta

Band	BW [MHz]	Mode	RB Allocation	RB offset	Target MPR	Avg Power[dBm]		
						19965	20175	20385
						1711.5 MHz	1732.5 MHz	1753.5 MHz
LTE Band 4	3	QPSK	1	0	0	22.60	22.53	22.43
			1	8	0	22.67	22.44	22.59
			1	14	0	22.60	22.36	22.70
			8	0	1	21.69	21.46	21.57
			8	4	1	21.71	21.52	21.57
			8	7	1	21.71	21.52	21.59
			15	0	1	21.76	21.54	21.56
		16QAM	1	0	1	21.40	21.50	21.48
			1	8	1	21.41	21.36	21.54
			1	14	1	21.41	21.26	21.67
			8	0	2	20.71	20.60	20.57
			8	4	2	20.80	20.58	20.54
			8	7	2	20.73	20.58	20.54
			15	0	2	20.78	20.57	20.65

Band	BW [MHz]	Mode	RB Allocation	RB offset	Target MPR	Avg Power[dBm]		
						19975	20175	20375
						1712.5 MHz	1732.5 MHz	1752.5 MHz
LTE Band 4	5	QPSK	1	0	0	22.70	22.44	22.39
			1	12	0	22.72	22.46	22.52
			1	24	0	22.74	22.41	22.70
			12	0	1	21.78	21.58	21.48
			12	7	1	21.73	21.51	21.55
			12	13	1	21.67	21.50	21.64
			25	0	1	21.74	21.54	21.53
		16QAM	1	0	1	21.66	21.24	21.48
			1	12	1	21.64	21.32	21.50
			1	24	1	21.64	21.19	21.75
			12	0	2	20.80	20.66	20.53
			12	7	2	20.75	20.68	20.56
			12	13	2	20.70	20.60	20.68
			25	0	2	20.72	20.64	20.60



Zacta

Band	BW [MHz]	Mode	RB Allocation	RB offset	Target MPR	Avg Power[dBm]		
						20000	20175	20350
						1715 MHz	1732.5 MHz	1750 MHz
LTE Band 4	10	QPSK	1	0	0	22.67	22.54	22.29
			1	25	0	22.60	22.44	22.32
			1	49	0	22.61	22.42	22.66
			25	0	1	21.60	21.49	21.36
			25	12	1	21.62	21.40	21.34
			25	25	1	21.72	21.24	21.45
			50	0	1	21.55	21.28	21.32
		16QAM	1	0	1	21.44	21.46	21.26
			1	25	1	21.44	21.32	21.34
			1	49	1	21.43	21.30	21.69
			25	0	2	20.72	20.60	20.43
			25	12	2	20.72	20.53	20.39
			25	25	2	20.86	20.37	20.51
			50	0	2	20.72	20.31	20.26

Band	BW [MHz]	Mode	RB Allocation	RB offset	Target MPR	Avg Power[dBm]		
						20025	20175	20325
						1717.5 MHz	1732.5 MHz	1747.5 MHz
LTE Band 4	15	QPSK	1	0	0	22.67	22.47	22.19
			1	37	0	22.64	22.39	22.26
			1	74	0	22.56	22.30	22.54
			36	0	1	21.62	21.48	21.01
			36	20	1	21.70	21.34	21.23
			36	39	1	21.51	21.26	21.40
			75	0	1	21.46	21.29	21.23
		16QAM	1	0	1	21.45	21.44	21.13
			1	37	1	21.51	21.36	21.33
			1	74	1	21.38	21.23	21.59
			36	0	2	20.68	20.52	20.18
			36	20	2	20.65	20.50	20.39
			36	39	2	20.58	20.45	20.54
			75	0	2	20.53	20.36	20.28



Zacta

Band	BW [MHz]	Mode	RB Allocation	RB offset	Target MPR	Avg Power[dBm]		
						20050	20175	20300
						1720 MHz	1732.5 MHz	1745 MHz
LTE Band 4	20	QPSK	1	0	0	22.74	22.55	22.24
			1	49	0	22.66	22.47	22.24
			1	99	0	22.46	22.20	22.51
			50	0	1	21.60	21.47	21.09
			50	24	1	21.54	21.33	20.94
			50	50	1	21.56	21.16	21.21
			100	0	1	21.55	21.26	21.15
		16QAM	1	0	1	21.70	21.48	21.19
			1	49	1	21.68	21.38	21.19
			1	99	1	21.46	21.07	21.53
			50	0	2	20.74	20.49	20.12
			50	24	2	20.66	20.35	20.07
			50	50	2	20.59	20.18	20.31
			100	0	2	20.60	20.27	20.29

5. Equivalent Isotropic Radiated Power

5.1 Measurement procedure

[FCC 27.50(d)(4), IC RSS-139 6.4]

<Step 1>

The EUT and support equipment are placed on a 1 meter x 1.5 meter surface, 0.8 meter height FRP table. Radiated emission measurements are performed at 3 meter distance with the broadband antenna (double ridged guide antenna). The antenna is positioned both the horizontal and vertical planes of polarization and height is varied 1 to 4 meters and stopped at height producing the maximum emission. The bandwidth of the spectrum analyzer is set to 1MHz. The turntable is rotated by 360 degrees and stopped at azimuth of producing the maximum emission.

<Step 2>

The substitution antenna is replaced by the transmitter antenna (EUT). The frequency of the signal generator is adjusted to the measurement frequency. Level of the signal generator is adjusted to the level that is obtained from step 1, and record the emission level of signal generator.

Spectrum analyzer setting

- Detector: RMS Average (RBW: 430kHz, VBW: 1.5MHz)

- Test configuration

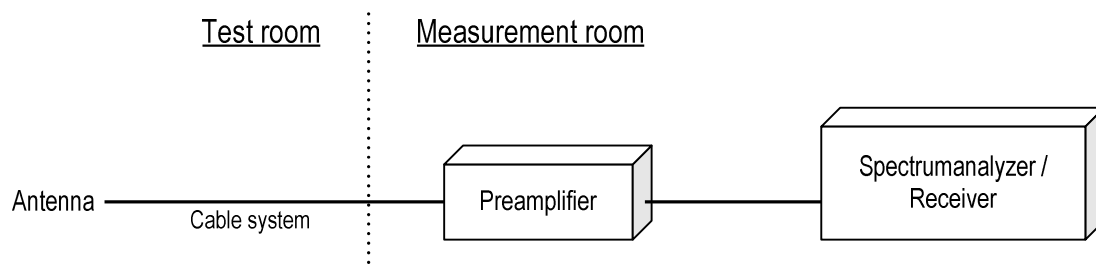

5.2 Calculation method

Result (EIRP) = S.G Reading – Cable loss + Antenna Gain

Margin = Limit – Result (EIRP)

Example:

Limit @ 1732.5MHz : 30.0dBm

S.G Reading = 21.5dBm Cable loss = 1.1dB Ant. Gain = 8.5dBi

Result = 21.5 – 1.1 + 8.5 = 28.9dBm

Margin = 30.0 - 28.9 = 1.1dB

5.3 Limit

1 W (30.0dBm)

5.4 Test data

Date : June 23, 2015
 Temperature : 24.8 [°C]
 Humidity : 53.2 [%]
 Test place : 3m Semi-anechoic chamber
 Test engineer : Taiki Watanabe

Date : June 30, 2015
 Temperature : 23.2 [°C]
 Humidity : 60.4 [%]
 Test place : 3m Semi-anechoic chamber
 Test engineer : Hikaru Shibata

Date : July 2, 2015
 Temperature : 24.1 [°C]
 Humidity : 59.5 [%]
 Test place : 3m Semi-anechoic chamber
 Test engineer : Hikaru Shibata

[LTE Band IV] QPSK, BW 1.4MHz

H/V	Frequency [MHz]	S.A Reading [dBm]	S.G Reading [dBm]	Cable loss [dB]	Ant.Gain [dBi]	Result [dBm]	Limit [dBm]	Margin [dB]
H	1710.7	-15.5	20.7	1.1	8.5	28.1	30.0	1.9
H	1732.5	-14.3	21.5	1.1	8.5	28.9	30.0	1.1
H	1754.3	-15.9	20.6	1.1	8.5	28.0	30.0	2.0

16QAM, BW 1.4MHz

H/V	Frequency [MHz]	S.A Reading [dBm]	S.G Reading [dBm]	Cable loss [dB]	Ant.Gain [dBi]	Result [dBm]	Limit [dBm]	Margin [dB]
H	1710.7	-15.9	20.3	1.1	8.5	27.7	30.0	2.3
H	1732.5	-15.1	20.7	1.1	8.5	28.1	30.0	1.9
H	1754.3	-16.4	20.1	1.1	8.5	27.5	30.0	2.5

QPSK, BW 3MHz

H/V	Frequency [MHz]	S.A Reading [dBm]	S.G Reading [dBm]	Cable loss [dB]	Ant.Gain [dBi]	Result [dBm]	Limit [dBm]	Margin [dB]
H	1711.5	-17.0	19.2	1.1	8.5	26.6	30.0	3.4
H	1732.5	-15.6	20.2	1.1	8.5	27.6	30.0	2.4
H	1753.5	-17.8	18.6	1.1	8.5	26.0	30.0	4.0

16QAM, BW 3MHz

H/V	Frequency [MHz]	S.A Reading [dBm]	S.G Reading [dBm]	Cable loss [dB]	Ant.Gain [dBi]	Result [dBm]	Limit [dBm]	Margin [dB]
H	1711.5	-16.9	19.3	1.1	8.5	26.7	30.0	3.3
H	1732.5	-16.3	19.5	1.1	8.5	26.9	30.0	3.1
H	1753.5	-17.6	18.8	1.1	8.5	26.2	30.0	3.8

QPSK, BW 5MHz

H/V	Frequency [MHz]	S.A Reading [dBm]	S.G Reading [dBm]	Cable loss [dB]	Ant.Gain [dBi]	Result [dBm]	Limit [dBm]	Margin [dB]
H	1712.5	-16.5	19.7	1.1	8.5	27.1	30.0	2.9
H	1732.5	-16.2	19.6	1.1	8.5	27.0	30.0	3.0
H	1752.5	-18.1	18.3	1.1	8.5	25.7	30.0	4.3

16QAM, BW 5MHz

H/V	Frequency [MHz]	S.A Reading [dBm]	S.G Reading [dBm]	Cable loss [dB]	Ant.Gain [dBi]	Result [dBm]	Limit [dBm]	Margin [dB]
H	1712.5	-16.8	19.4	1.1	8.5	26.8	30.0	3.2
H	1732.5	-16.7	19.1	1.1	8.5	26.5	30.0	3.5
H	1752.5	-17.8	18.6	1.1	8.5	26.0	30.0	4.0

QPSK, BW 10MHz

H/V	Frequency [MHz]	S.A Reading [dBm]	S.G Reading [dBm]	Cable loss [dB]	Ant.Gain [dBi]	Result [dBm]	Limit [dBm]	Margin [dB]
H	1715.0	-16.4	19.8	1.1	8.5	27.2	30.0	2.8
H	1732.5	-15.6	20.2	1.1	8.5	27.6	30.0	2.4
H	1750.0	-16.3	20.1	1.1	8.5	27.5	30.0	2.5

16QAM, BW 10MHz

H/V	Frequency [MHz]	S.A Reading [dBm]	S.G Reading [dBm]	Cable loss [dB]	Ant.Gain [dBi]	Result [dBm]	Limit [dBm]	Margin [dB]
H	1715.0	-15.9	20.3	1.1	8.5	27.7	30.0	2.3
H	1732.5	-16.3	19.5	1.1	8.5	26.9	30.0	3.1
H	1750.0	-17.7	18.7	1.1	8.5	26.1	30.0	3.9

QPSK, BW 15MHz

H/V	Frequency [MHz]	S.A Reading [dBm]	S.G Reading [dBm]	Cable loss [dB]	Ant.Gain [dBi]	Result [dBm]	Limit [dBm]	Margin [dB]
H	1717.5	-16.6	19.6	1.1	8.5	27.0	30.0	3.0
H	1732.5	-15.7	20.1	1.1	8.5	27.5	30.0	2.5
H	1747.5	-16.4	20.0	1.1	8.5	27.4	30.0	2.6

16QAM, BW 15MHz

H/V	Frequency [MHz]	S.A Reading [dBm]	S.G Reading [dBm]	Cable loss [dB]	Ant.Gain [dBi]	Result [dBm]	Limit [dBm]	Margin [dB]
H	1717.5	-15.7	20.5	1.1	8.5	27.9	30.0	2.1
H	1732.5	-16.7	19.1	1.1	8.5	26.5	30.0	3.5
H	1747.5	-17.5	18.9	1.1	8.5	26.3	30.0	3.7



Zacta

QPSK, BW 20MHz

H/V	Frequency [MHz]	S.A Reading [dBm]	S.G Reading [dBm]	Cable loss [dB]	Ant.Gain [dBi]	Result [dBm]	Limit [dBm]	Margin [dB]
H	1720.0	-16.6	19.6	1.1	8.5	27.0	30.0	3.0
H	1732.5	-16.0	19.8	1.1	8.5	27.2	30.0	2.8
H	1745.0	-16.4	20.0	1.1	8.5	27.4	30.0	2.6

16QAM, BW 20MHz

H/V	Frequency [MHz]	S.A Reading [dBm]	S.G Reading [dBm]	Cable loss [dB]	Ant.Gain [dBi]	Result [dBm]	Limit [dBm]	Margin [dB]
H	1720.0	-16.4	19.8	1.1	8.5	27.2	30.0	2.8
H	1732.5	-15.7	20.1	1.1	8.5	27.5	30.0	2.5
H	1745.0	-17.9	18.5	1.1	8.5	25.9	30.0	4.1

6. Peak to Average Ratio

6.1 Measurement procedure

[FCC 27.50(d)(5), IC RSS-139 6.4]

The peak to average ratio was measured with a spectrum analyzer connected to the antenna terminal.

The spectrum analyzer is set to;

- Power Stat CCDF mode

- Test configuration

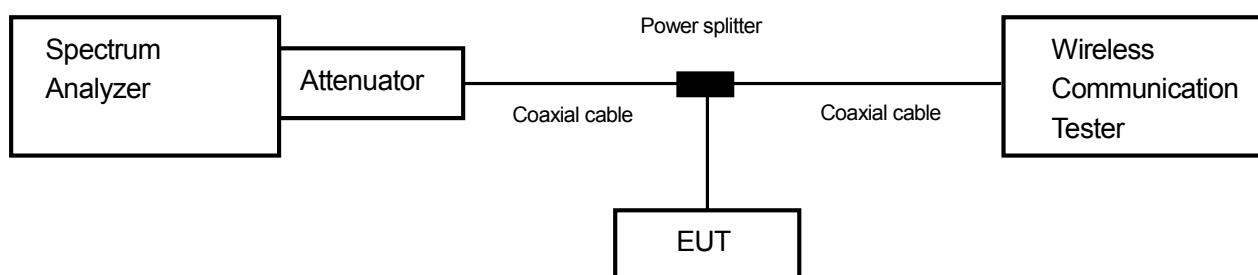

6.2 Limit

13.0dB or less

6.3 Measurement result

Date : June 19, 2015

Temperature : 24.9 [°C]

Humidity : 49.6 [%]

Test place : Shielded room No.4

Test engineer :

Hikaru Shibata

Band	Channel	Frequency [MHz]	Modulation	BW [MHz]	RB	Peak to Average Power Ratio [dB]	Limit [dB]
LTE Band IV	20175	1732.5	QPSK	1.4	6-0	5.64	13.0
				3	15-0	5.63	13.0
				5	25-0	5.55	13.0
				10	50-0	4.50	13.0
				15	75-0	5.80	13.0
				20	100-0	6.58	13.0
			16QAM	1.4	6-0	6.62	13.0
				3	15-0	6.57	13.0
				5	25-0	6.38	13.0
				10	50-0	6.24	13.0
				15	75-0	6.98	13.0
				20	100-0	7.23	13.0



Zacta

6.4 Trace data
[LTE Band IV]
Channel: 20175
QPSK, BW 1.4MHz, RB6-0

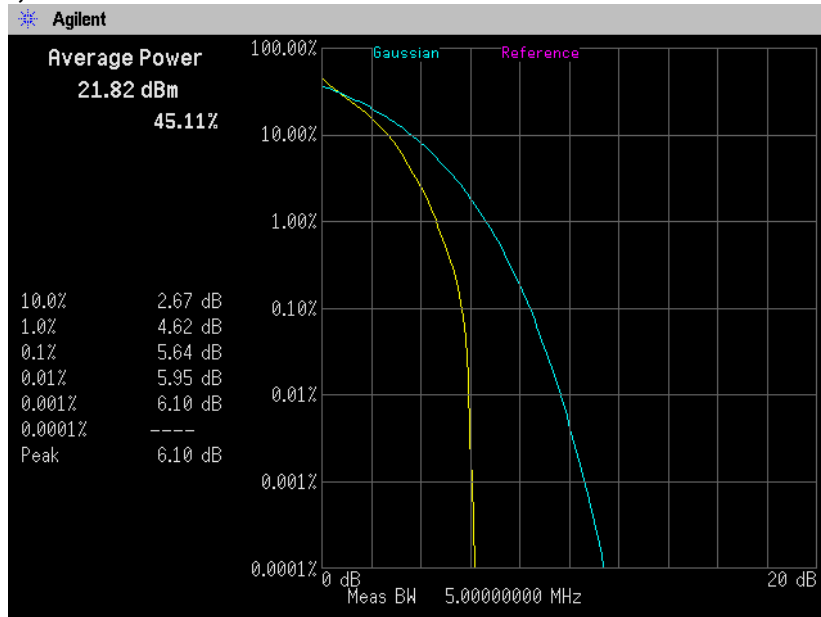

QPSK, BW 3MHz, RB15-0



QPSK, BW 5MHz, RB25-0



QPSK, BW 10MHz, RB50-0

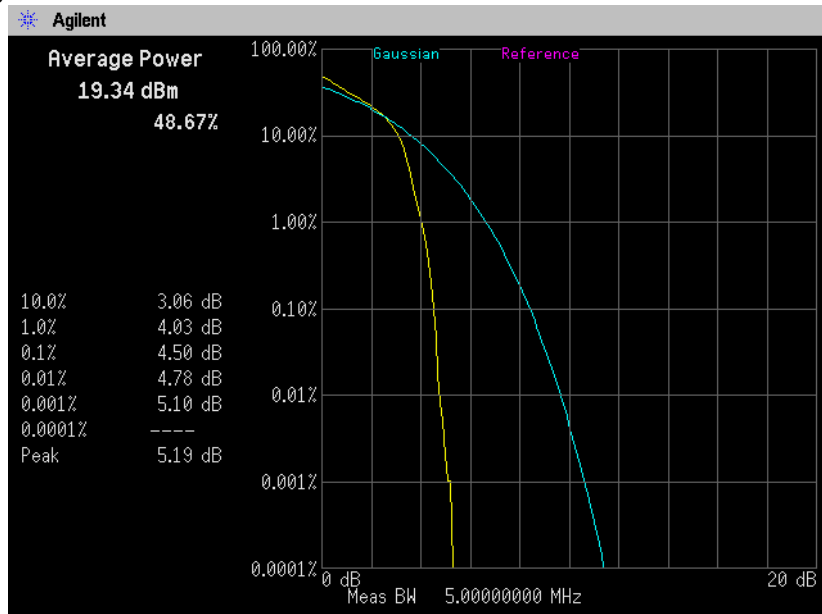

QPSK, BW 15MHz, RB75-0

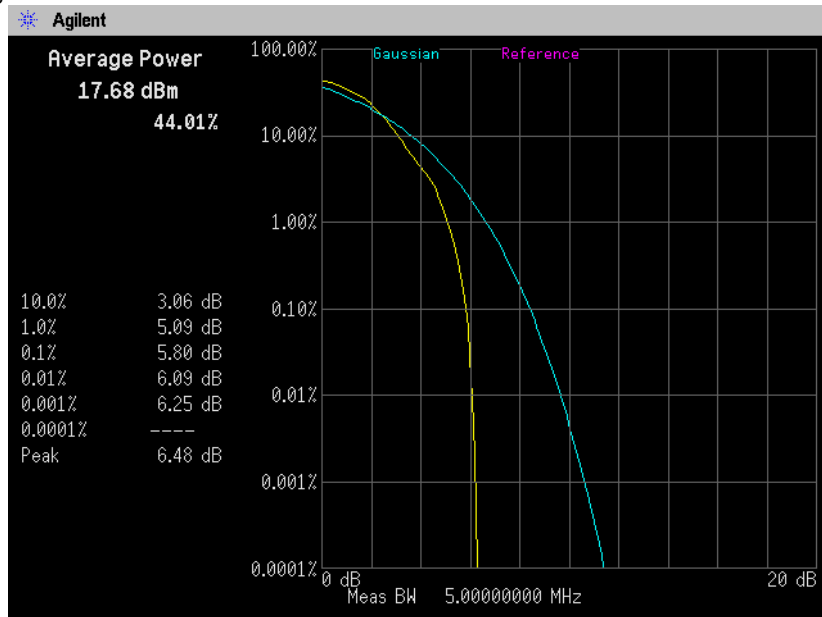

QPSK, BW 20MHz, RB100-0

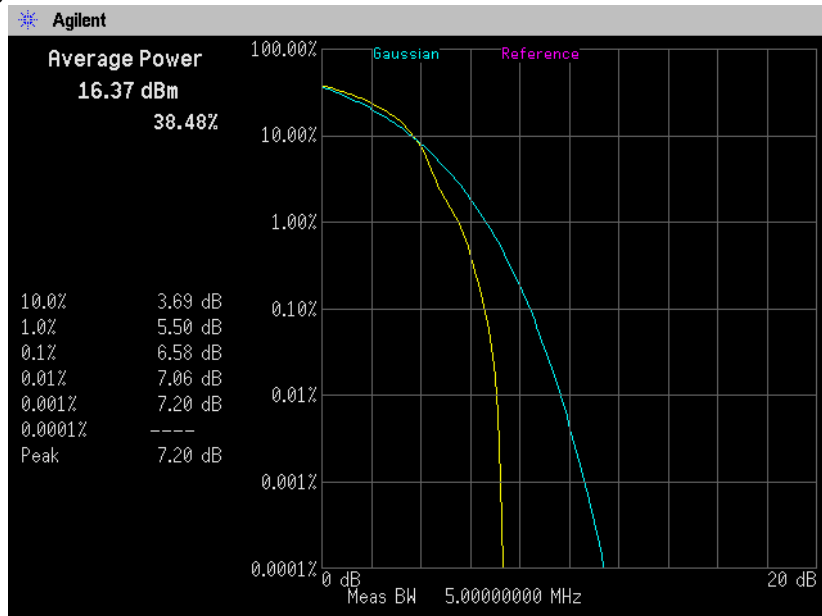



Zacta

16QAM, BW 1.4MHz, RB6-0

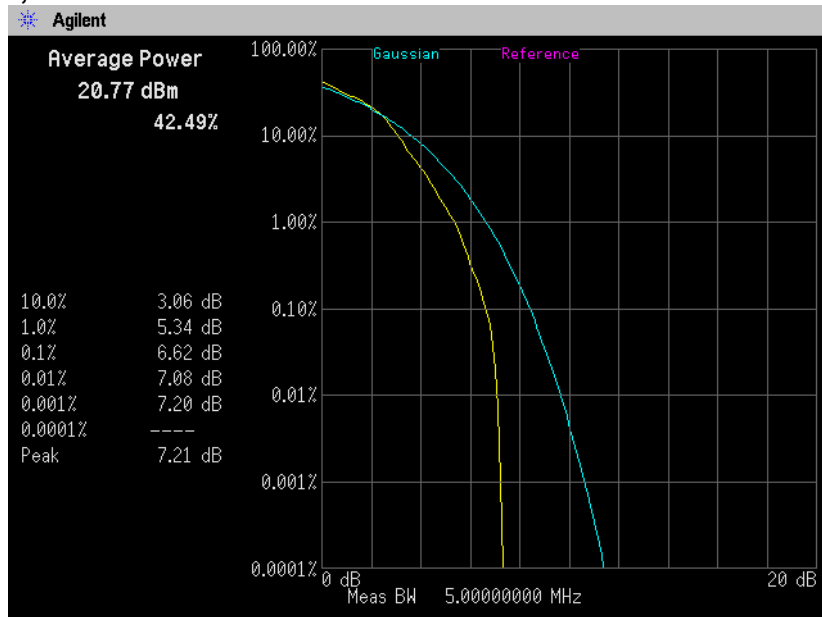

16QAM, BW 3MHz, RB15-0

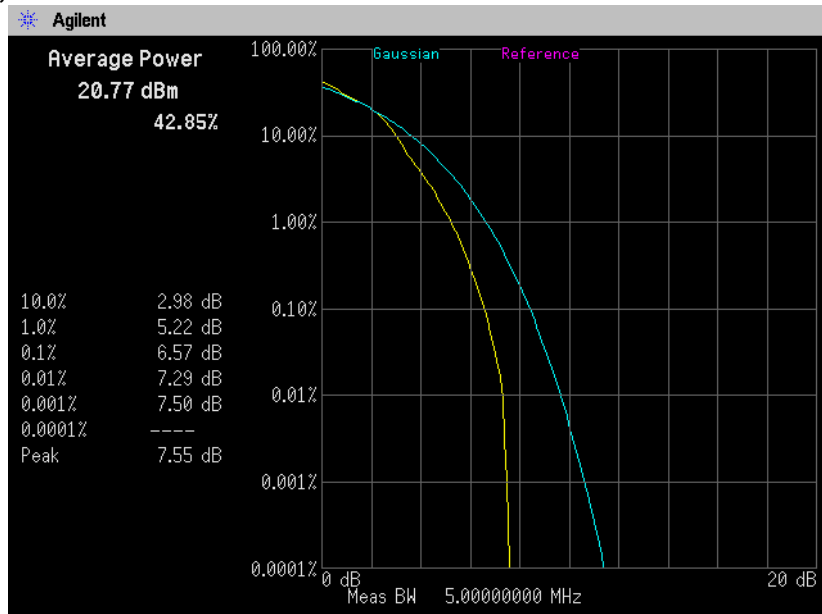



Zacta

16QAM, BW 5MHz, RB25-0

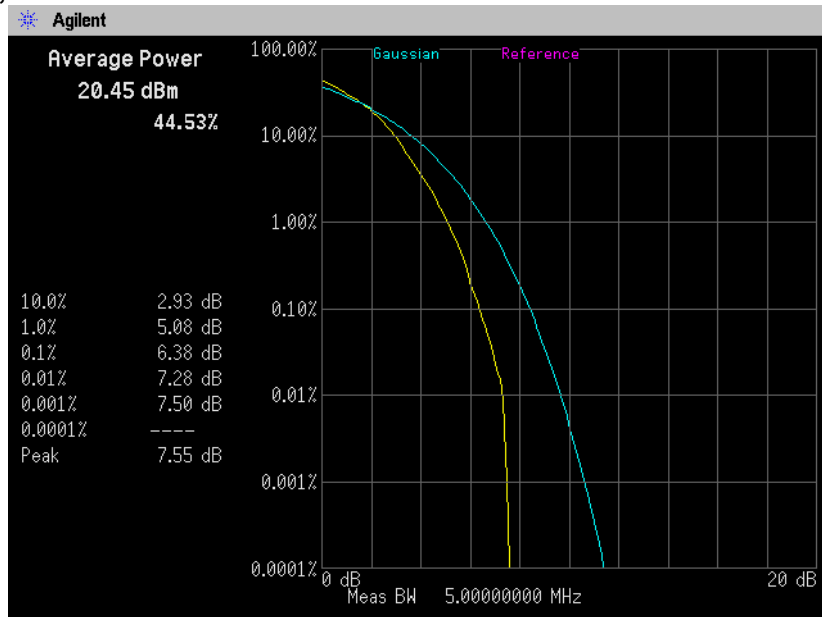

16QAM, BW 10MHz, RB50-0

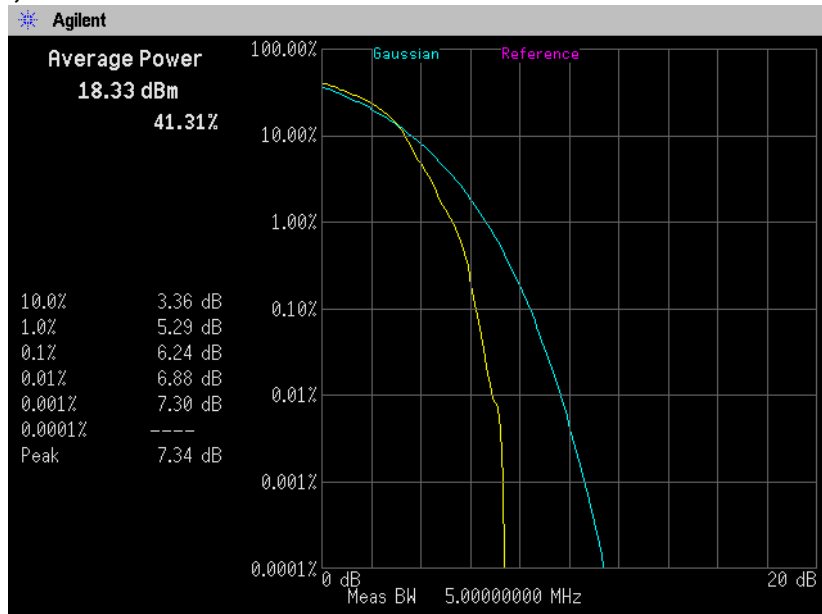



Zacta

16QAM, BW 15MHz, RB75-0

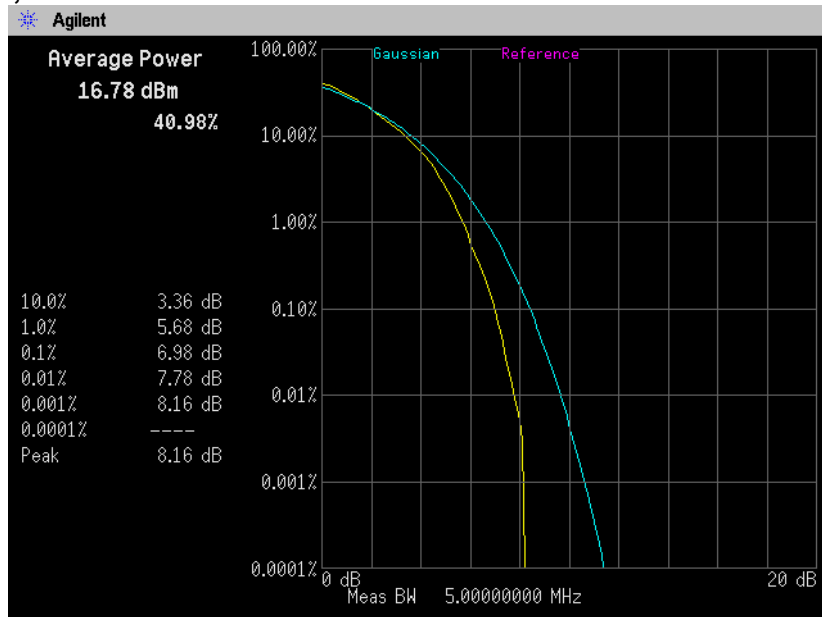

16QAM, BW 20MHz, RB100-0

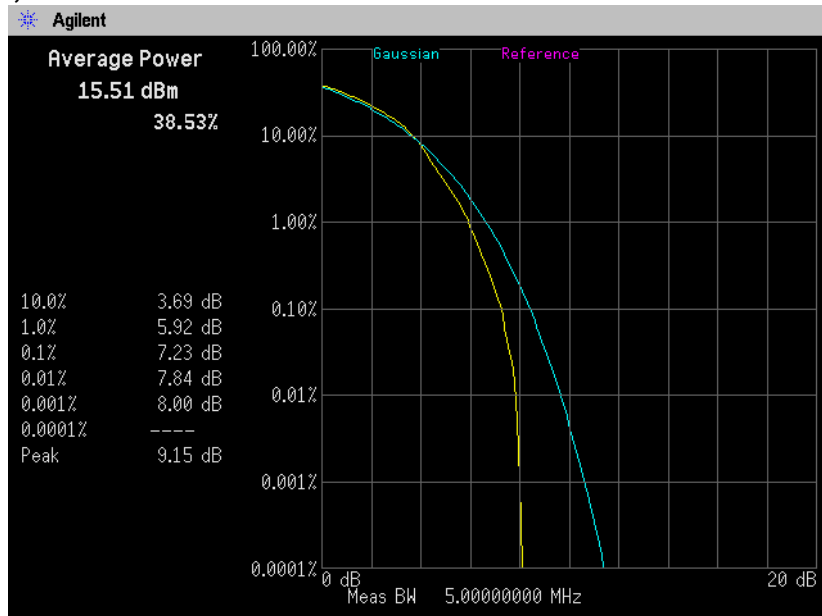

7. Occupied Bandwidth

7.1 Measurement procedure [FCC 2.1049, IC RSS-139 2.3]

The Occupied bandwidth was measured with a spectrum analyzer connected to the antenna terminal.

The spectrum analyzer is set to;

- RBW=30kHz, VBW=91kHz, Span=3MHz, Sweep=auto, Detector=Peak, Trace mode=Max hold
- RBW=62kHz, VBW=100kHz, Span=6MHz, Sweep=auto, Detector=Peak, Trace mode=Max hold
- RBW=100kHz, VBW=300kHz, Span=10MHz, Sweep=auto, Detector=Peak, Trace mode=Max hold
- RBW=200kHz, VBW=620kHz, Span=20MHz, Sweep=auto, Detector=Peak, Trace mode=Max hold
- RBW=300kHz, VBW=910kHz, Span=30MHz, Sweep=auto, Detector=Peak, Trace mode=Max hold
- RBW=390kHz, VBW=1.2MHz, Span=40MHz, Sweep=auto, Detector=Peak, Trace mode=Max hold

- Test configuration

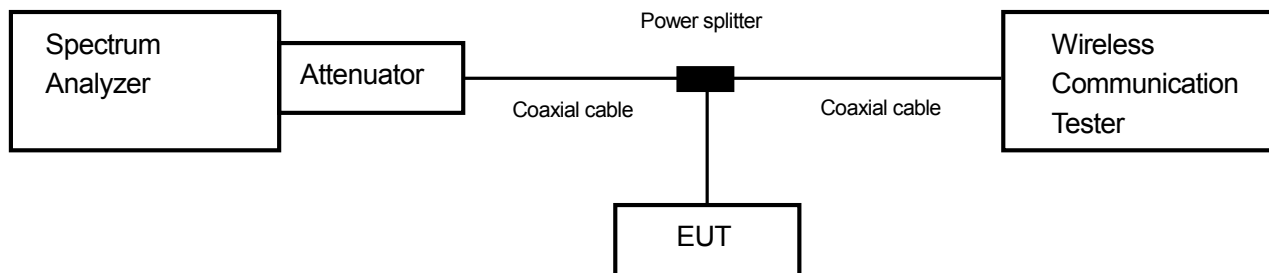

7.2 Limit

None

7.3 Measurement result

Date : June 18, 2015
 Temperature : 25.9 [°C]
 Humidity : 54.8 [%]
 Test place : Shielded room No.4

Test engineer : Hikaru Shibata

BW	Mode	UL RB Allocation	UL RB Start	Frequency [MHz]	26dB Bandwidth [MHz]	99% OBW [MHz]
1.4MHz	QPSK	1	0	1732.5	0.432	0.2841
		1	5		0.434	0.2859
		3	1		0.922	0.6148
		6	0		1.350	1.1057
1.4MHz	16QAM	1	0	1732.5	0.435	0.2799
		1	5		0.452	0.2814
		3	1		0.965	0.6267
		6	0		1.327	1.1124
3MHz	QPSK	1	0	1732.5	0.545	0.3714
		1	14		0.493	0.3498
		8	4		2.177	1.5577
		15	0		3.100	2.7136
3MHz	16QAM	1	0	1732.5	0.523	0.3677
		1	14		0.520	0.3608
		8	4		2.183	1.5624
		15	0		3.107	2.7254
5MHz	QPSK	1	0	1732.5	0.742	0.5123
		1	24		0.749	0.5148
		12	7		3.269	2.3127
		25	0		5.088	4.5170
5MHz	16QAM	1	0	1732.5	0.701	0.4856
		1	24		0.716	0.5005
		12	7		3.379	2.3456
		25	0		5.147	4.5198
10MHz	QPSK	1	0	1732.5	1.050	0.7488
		1	49		1.018	0.7196
		25	12		6.712	4.7224
		50	0		10.091	8.9924
10MHz	16QAM	1	0	1732.5	0.997	0.7296
		1	49		0.972	0.7134
		25	12		6.780	4.7365
		50	0		10.030	9.0048
15MHz	QPSK	1	0	1732.5	1.613	1.1445
		1	74		1.584	1.1296
		36	20		9.093	6.8234
		75	0		14.876	13.4583
15MHz	16QAM	1	0	1732.5	1.646	1.1378
		1	74		1.561	1.1394
		36	20		9.344	6.7823
		75	0		14.806	13.4438
20MHz	QPSK	1	0	1732.5	2.022	1.4451
		1	99		1.978	1.4294
		50	24		11.572	9.2424
		100	0		19.529	17.9055
20MHz	16QAM	1	0	1732.5	2.008	1.4738
		1	99		1.974	1.4067
		50	24		11.920	9.2717
		100	0		19.695	17.9068



Zacta

7.4 Trace data
[LTE Band IV]
Channel: 20175
QPSK, BW 1.4MHz, RB1-0

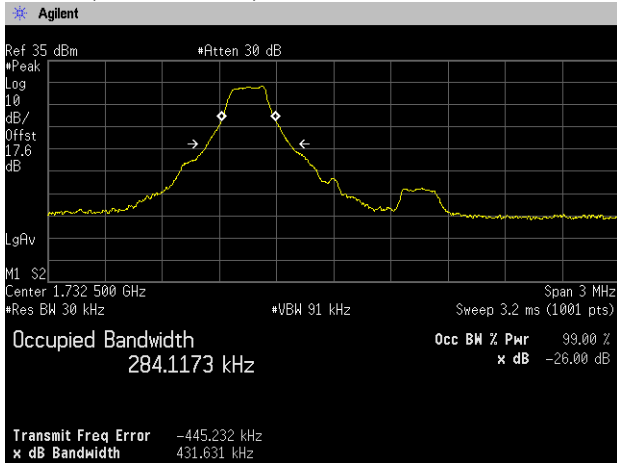

RB1-5

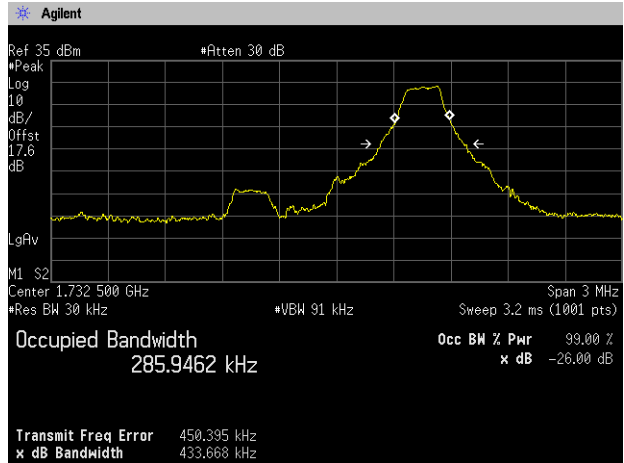

RB3-1

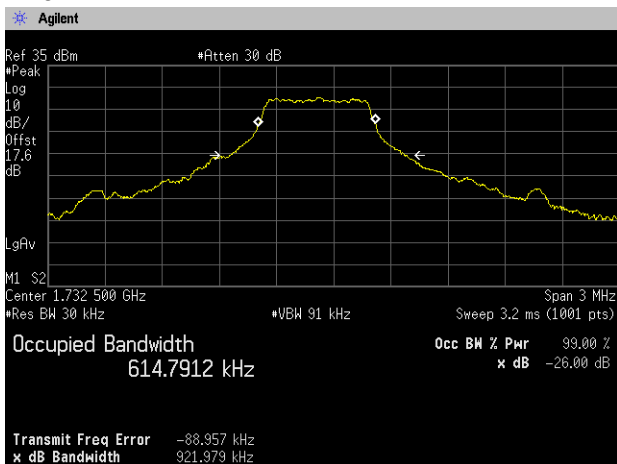

RB6-0

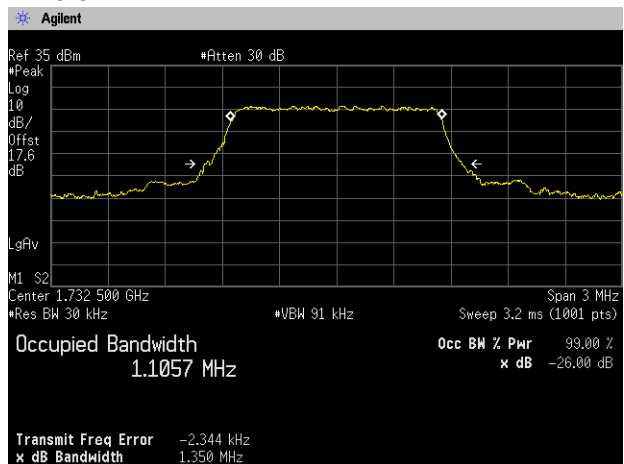



Zacta

16QAM, BW 1.4MHz, RB1-0

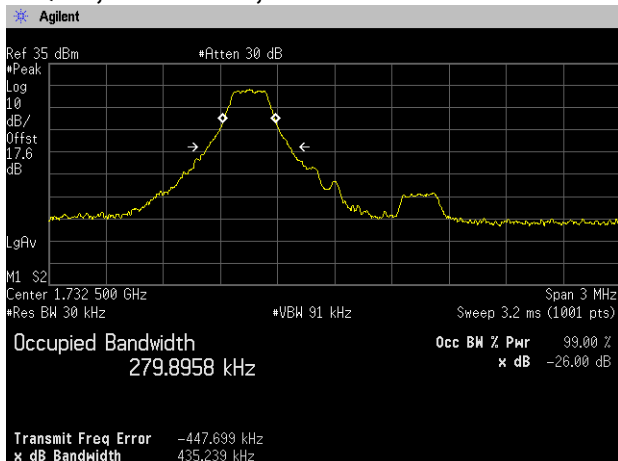

RB1-5

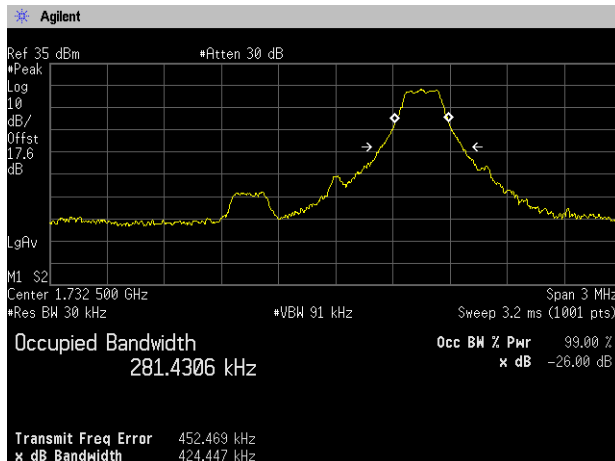

RB3-1

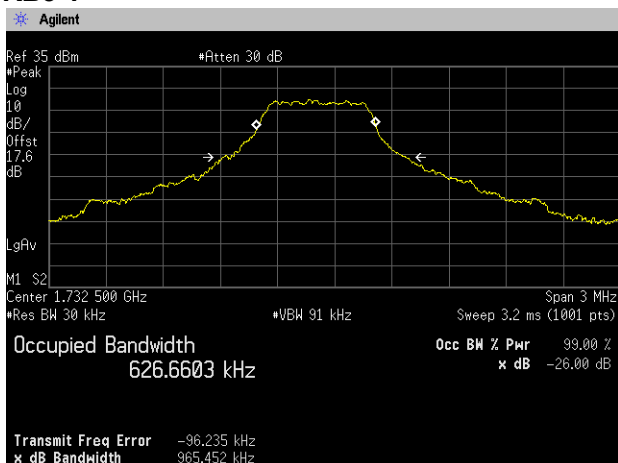

RB6-0

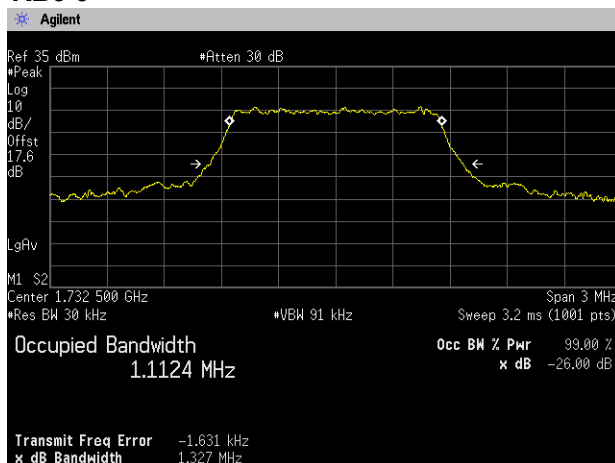



Zacta

QPSK, BW 3MHz, RB1-0

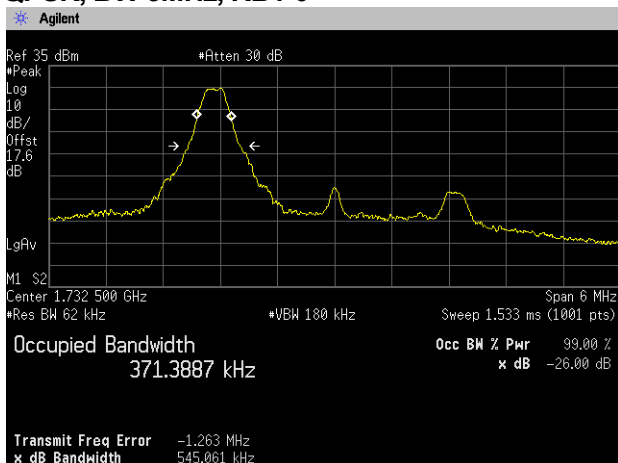

RB1-14

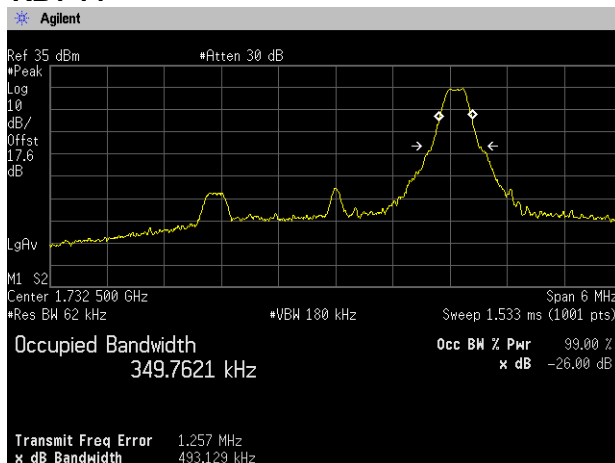

RB8-4

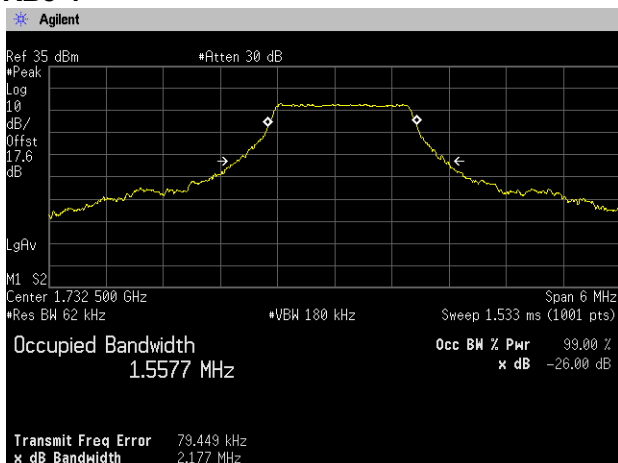

RB15-0

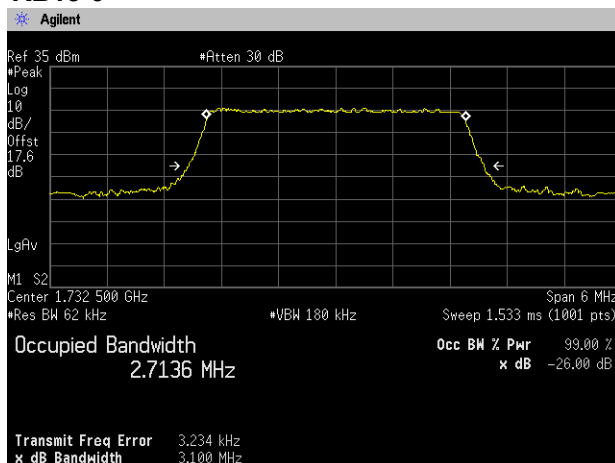



Zacta

16QAM, BW 3MHz, RB1-0

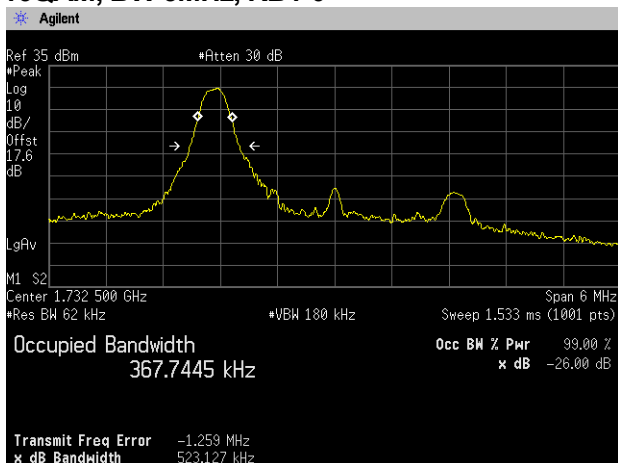

RB1-14

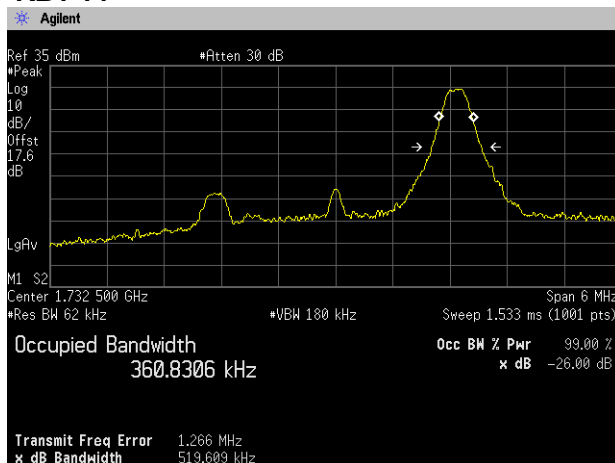

RB8-4

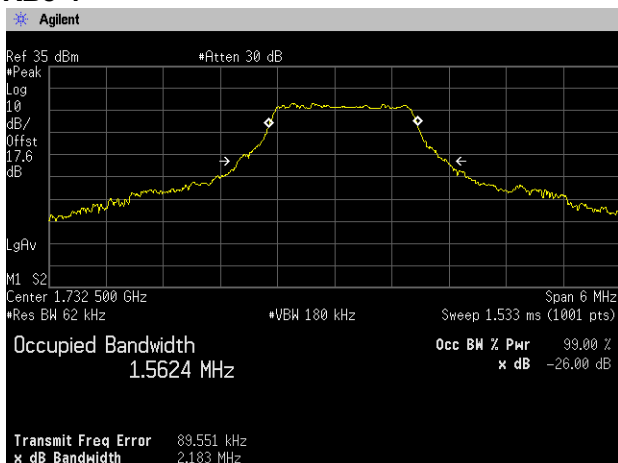

RB15-0

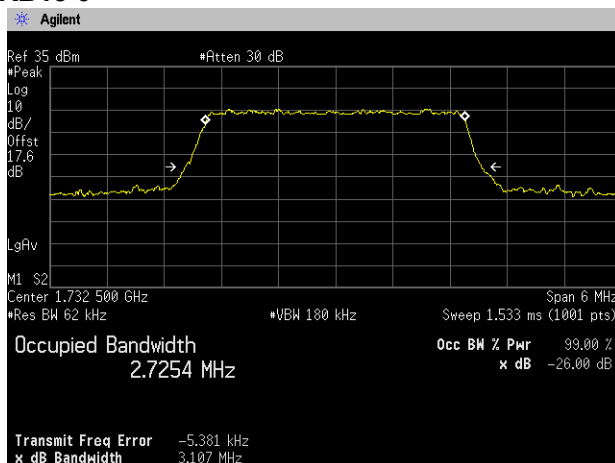



Zacta

QPSK, BW 5MHz, RB1-0

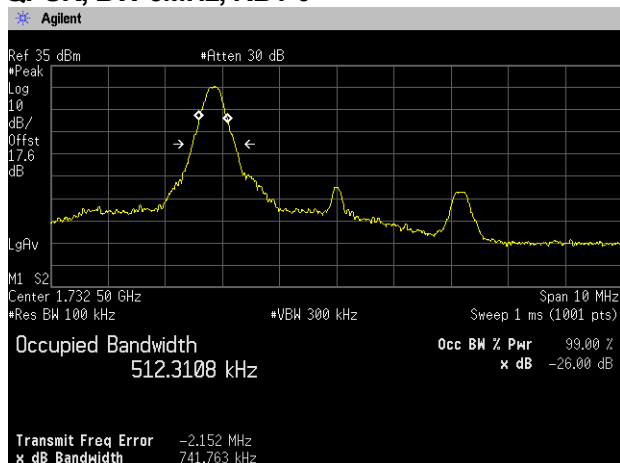

RB1-24

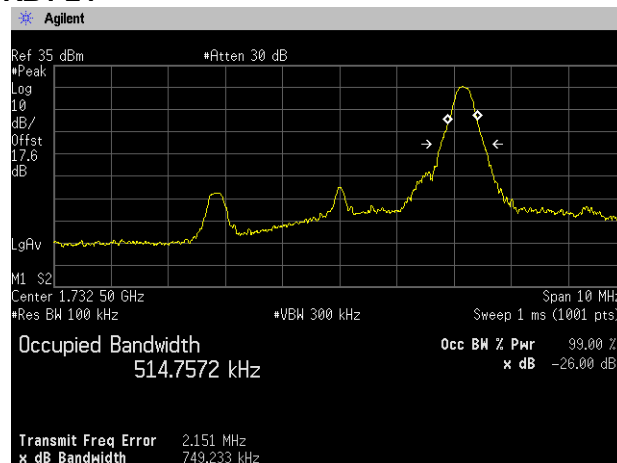

RB12-7

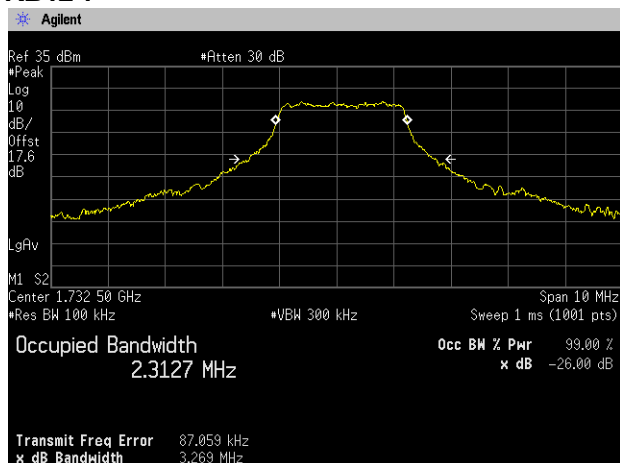

RB25-0

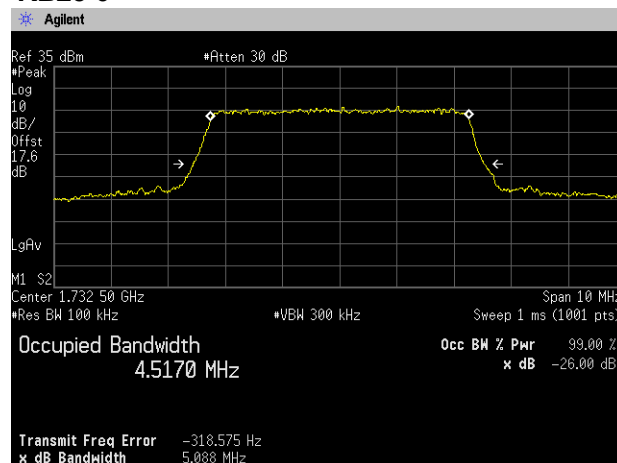



Zacta

16QAM, BW 5MHz, RB1-0

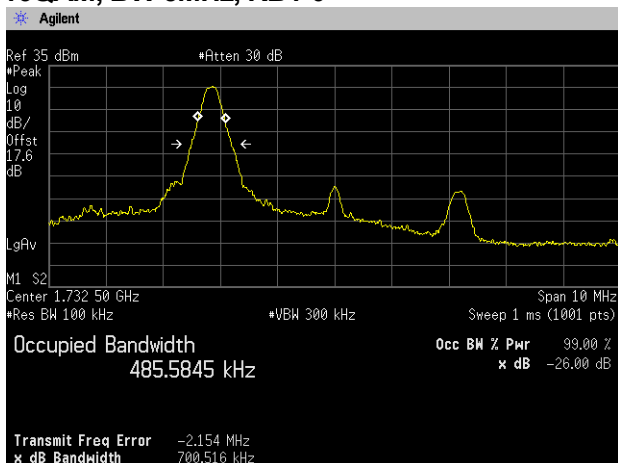

RB1-24

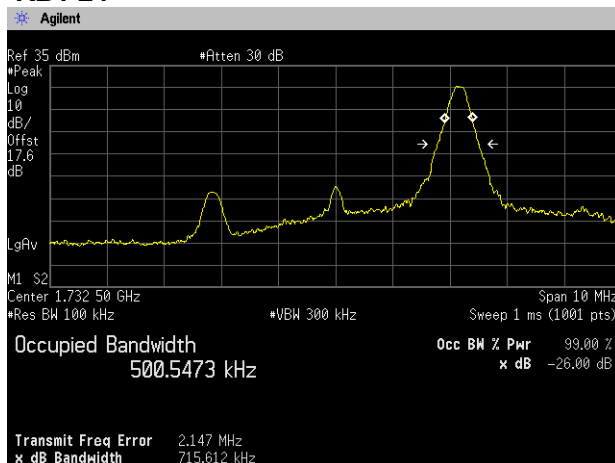

RB12-7

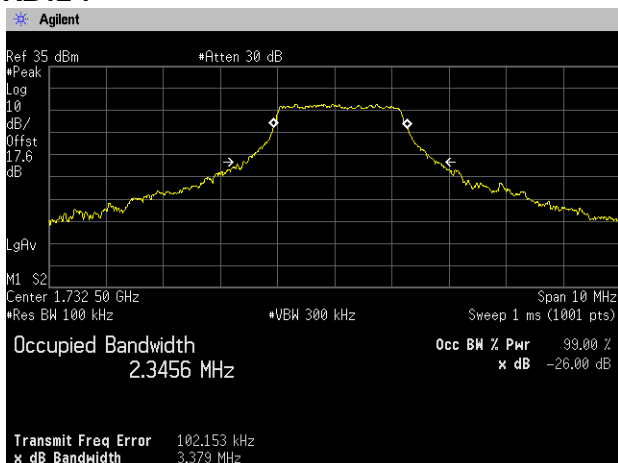

RB25-0

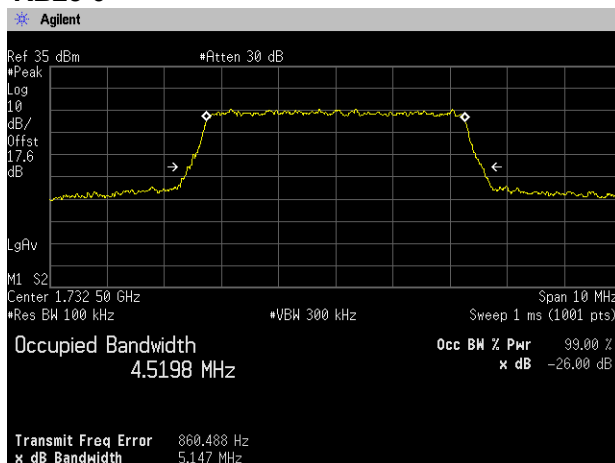



Zacta

QPSK, BW 10MHz, RB1-0

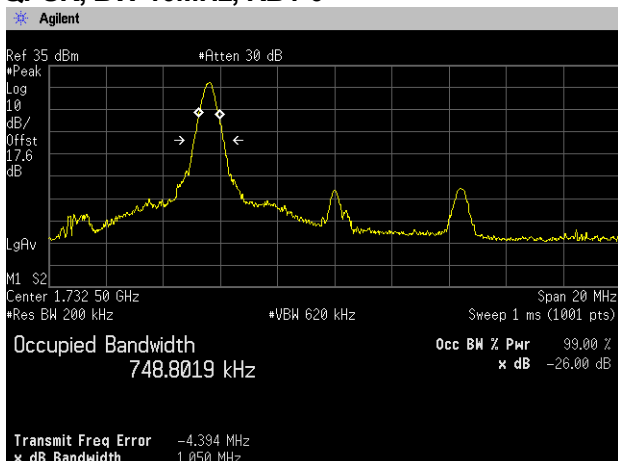

RB1-49

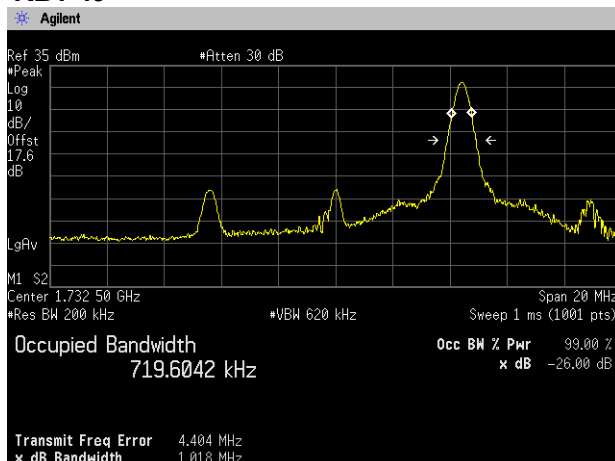

RB25-12

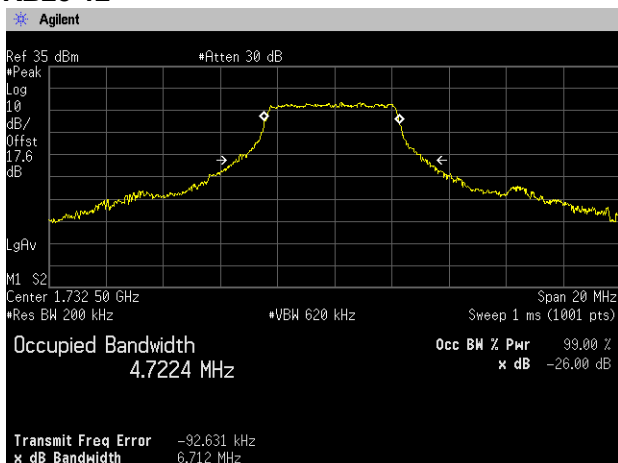

RB50-0

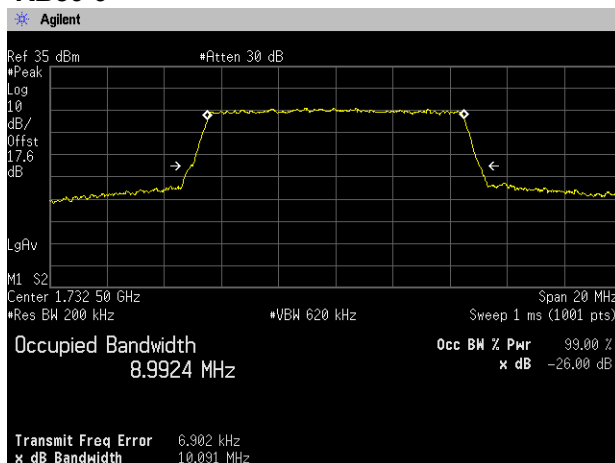



Zacta

16QAM, BW 10MHz, RB1-0

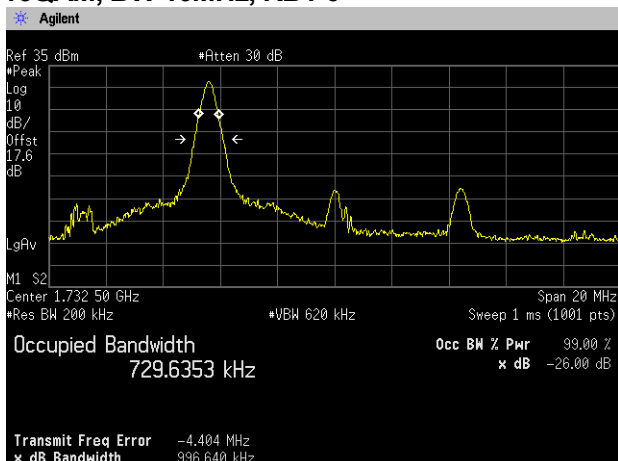

RB1-49

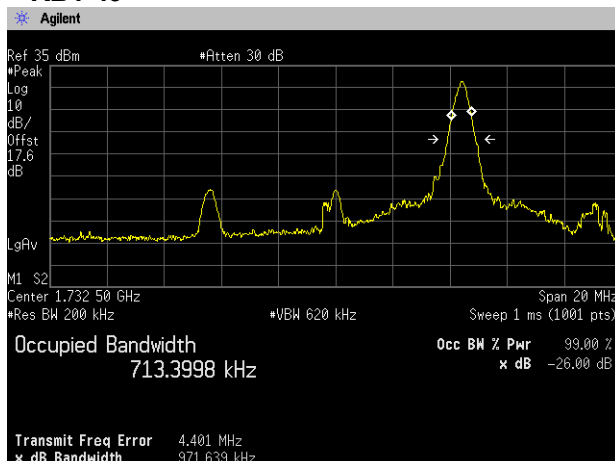

RB25-12

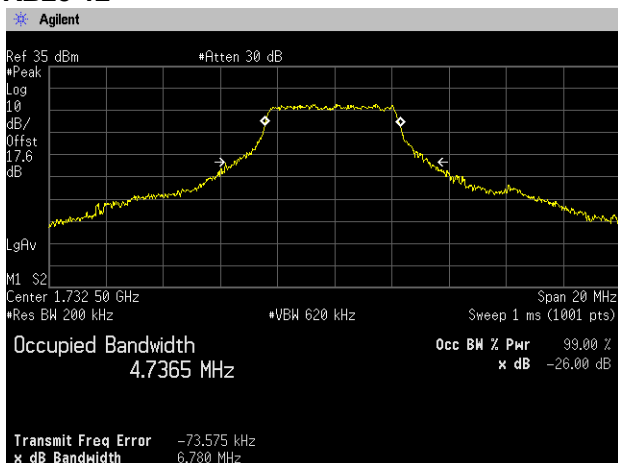

RB50-0

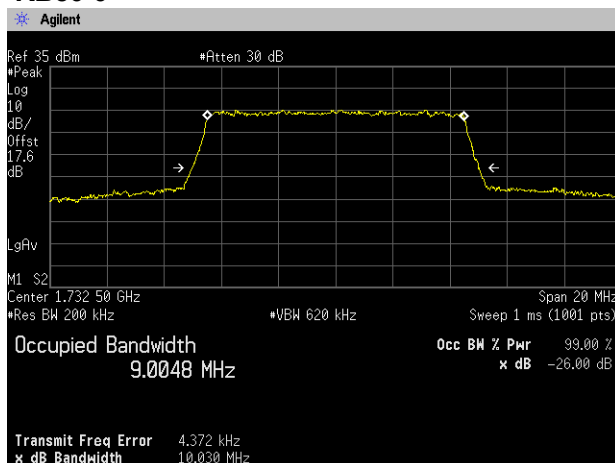



Zacta

QPSK, BW 15MHz, RB1-0

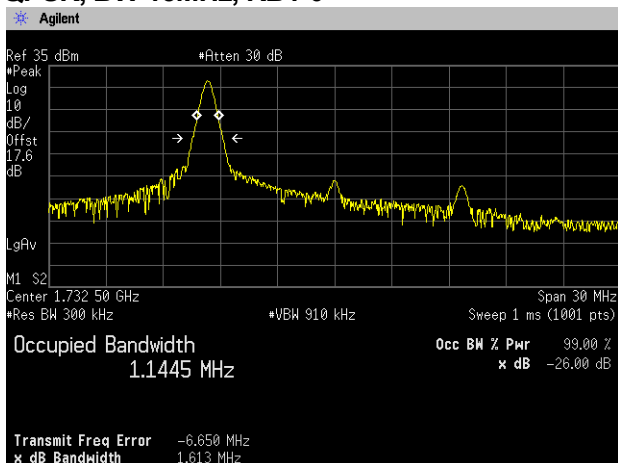

RB1-74

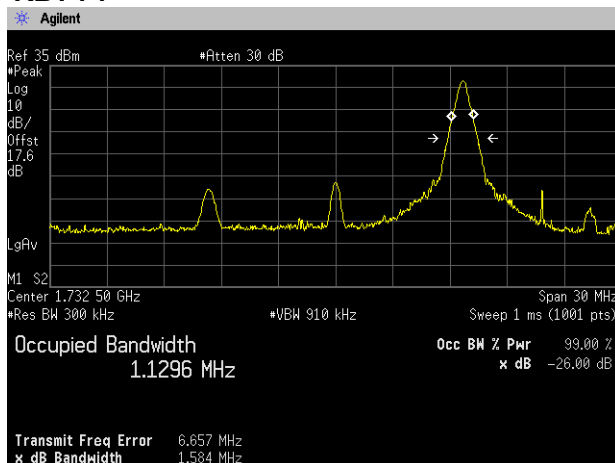

RB36-20

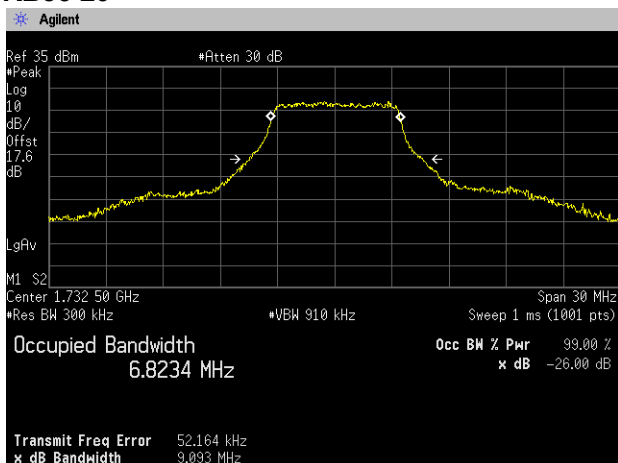

RB75-0

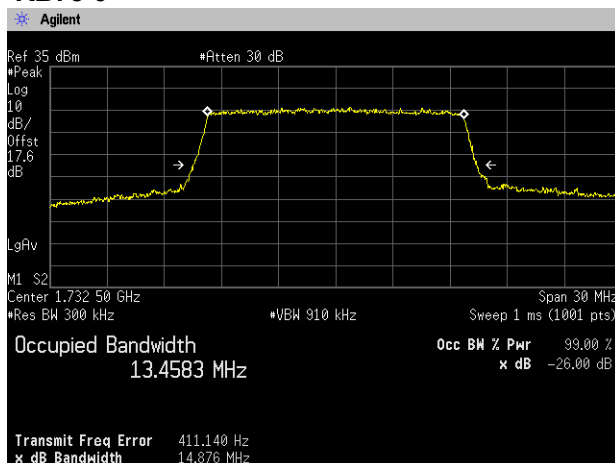



Zacta

16QAM, BW 15MHz, RB1-0

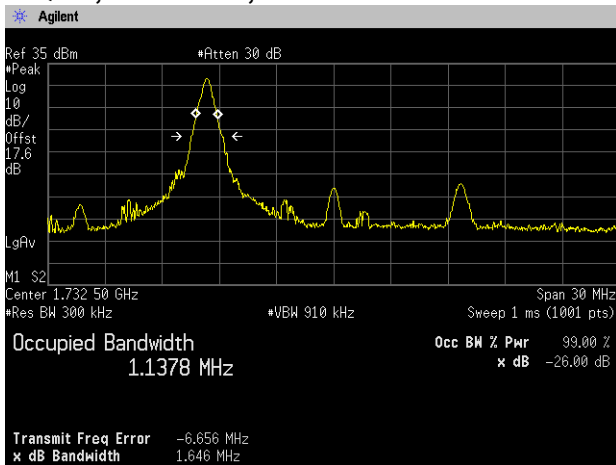

RB1-74

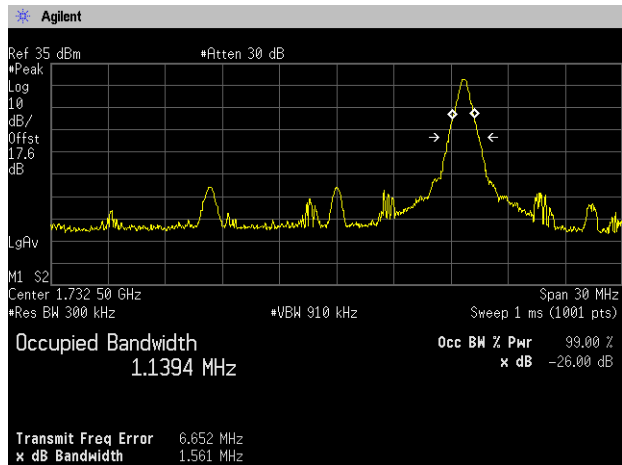

RB36-20

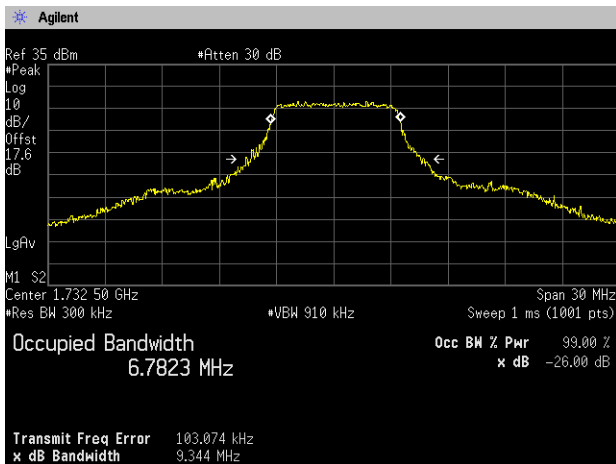

RB75-0

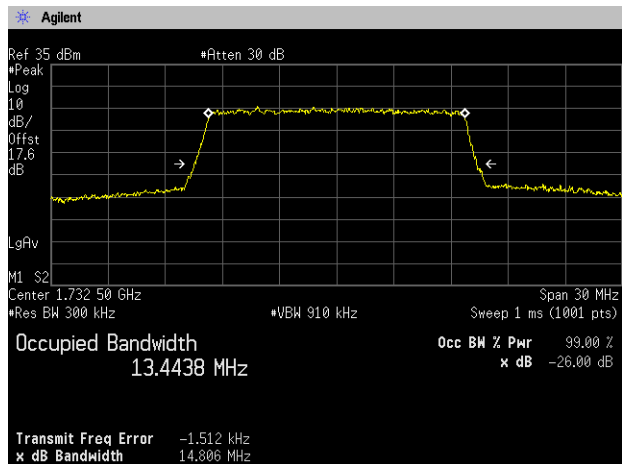



Zacta

QPSK, BW 20MHz, RB1-0

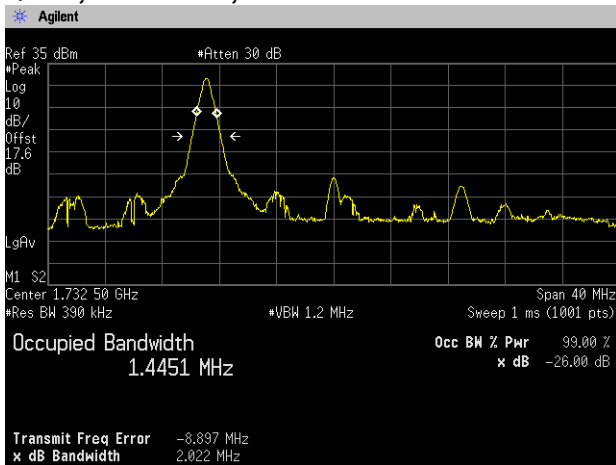

RB1-99

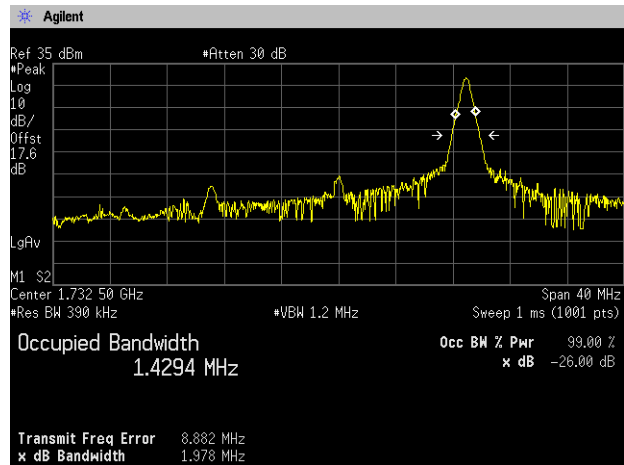

RB50-24

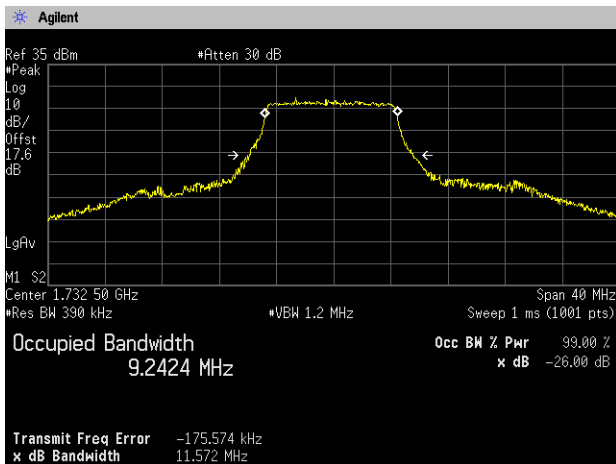

RB100-0

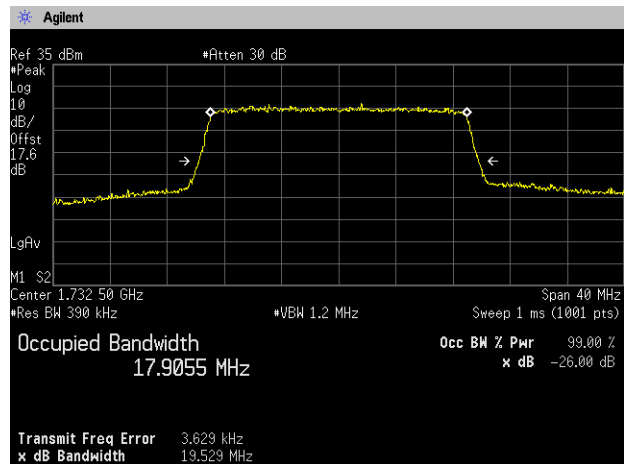



Zacta

16QAM, BW 20MHz, RB1-0

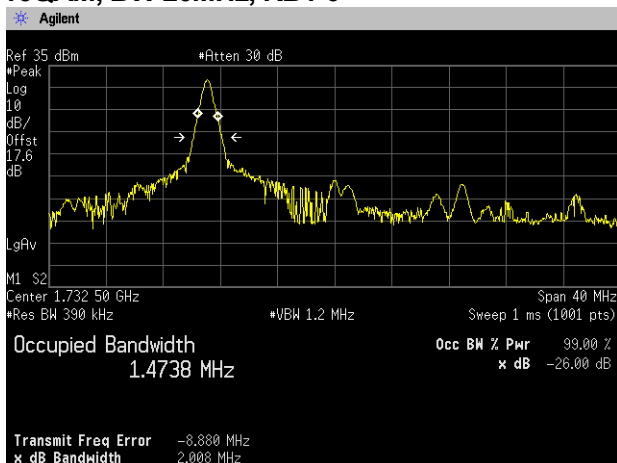

RB1-99

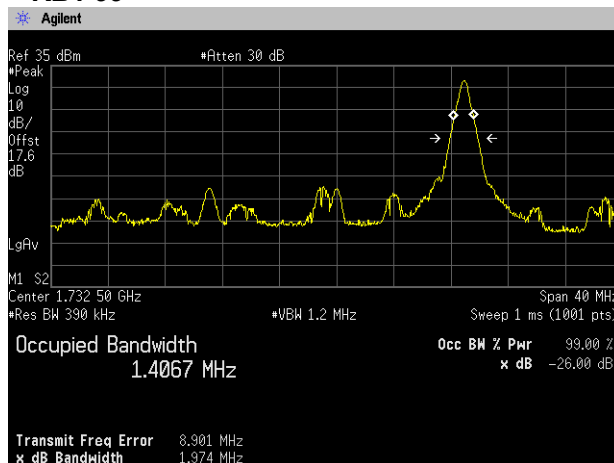

RB50-24

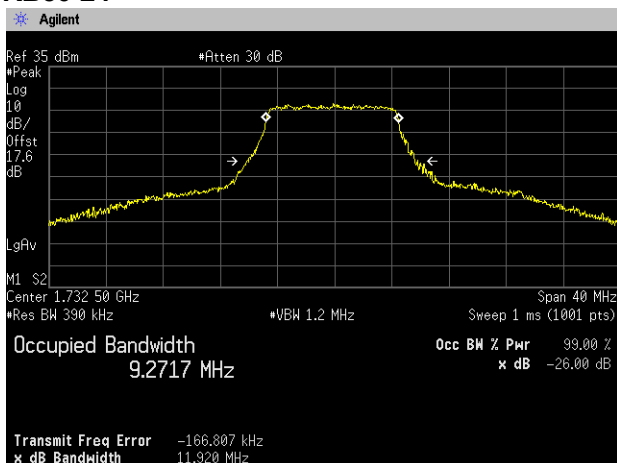

RB100-0

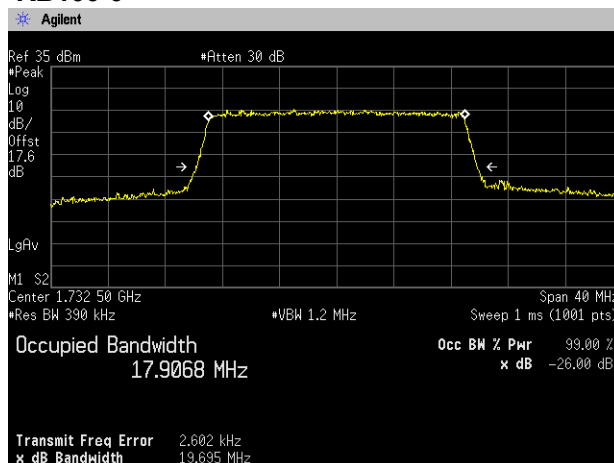

8. Band Edge Spurious and Harmonic at Antenna Terminals

8.1 Measurement procedure

[FCC 27.53(h), 2.1051, IC RSS-139 6.5]

The band edge spurious and harmonic was measured with a spectrum analyzer connected to the antenna terminal.

The spectrum analyzer is set to;

<Band Edge>

- RBW=20kHz, VBW=62kHz, Span=2.8MHz, Sweep=auto, Detector=RMS, Trace mode=Max hold
- RBW=43kHz, VBW=130kHz, Span=6MHz, Sweep=auto, Detector=RMS, Trace mode=Max hold
- RBW=75kHz, VBW=220kHz, Span=10MHz, Sweep=auto, Detector=RMS, Trace mode=Max hold
- RBW=150kHz, VBW=430kHz, Span=20MHz, Sweep=auto, Detector=RMS, Trace mode=Max hold
- RBW=220kHz, VBW=680kHz, Span=30MHz, Sweep=auto, Detector=RMS, Trace mode=Max hold
- RBW=300kHz, VBW=910kHz, Span=40MHz, Sweep=auto, Detector=RMS, Trace mode=Max hold

<Spurious Emissions>

- RBW=1MHz, VBW=3MHz, Span=Arbitrary setting, Sweep=auto, Detector=Peak, Trace mode=Max hold

- Test configuration

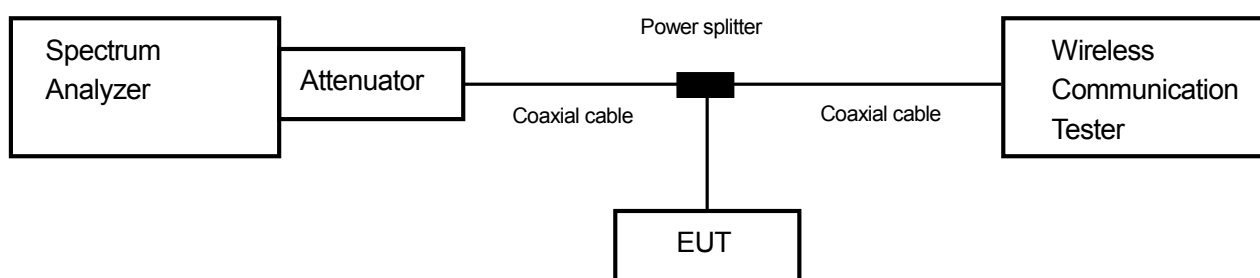

8.2 Limit

-13dBm or less

8.3 Measurement result

Date : June 19, 2015

Temperature : 24.9 [°C]

Humidity : 49.6 [%]

Test place : Shielded room No.4

Test engineer :

Hikaru Shibata

Band	Modulation	Bandwidth	Results	
LTE Band IV	QPSK	1.4MHz, 3MHz 5MHz, 10MHz 15MHz, 20MHz	See the trace data	PASS
	16QAM	1.4MHz, 3MHz 5MHz, 10MHz 15MHz, 20MHz	See the trace data	PASS

8.4 Trace data
[LTE Band IV]
(Band Edge)
QPSK, BW 1.4MHz, RB1-0
Channel: Low

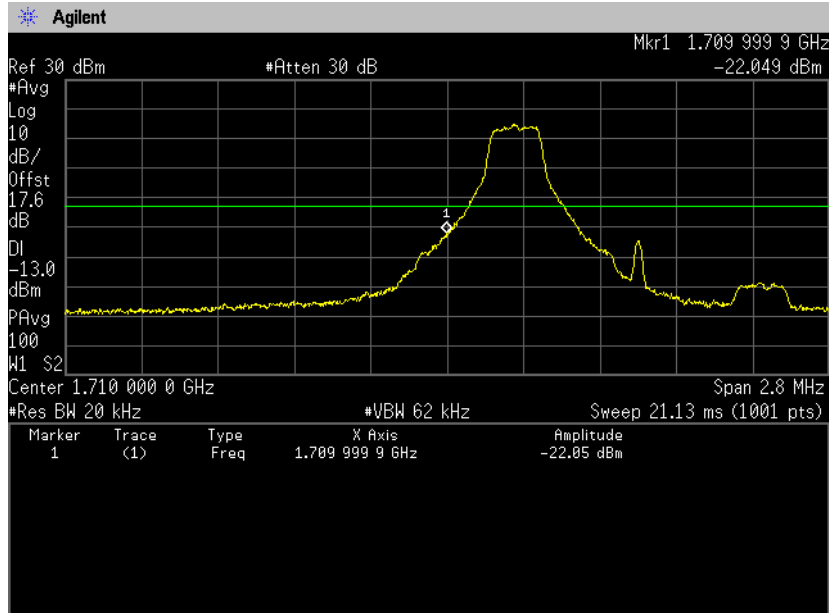

QPSK, BW 1.4MHz, RB1-5
Channel: High

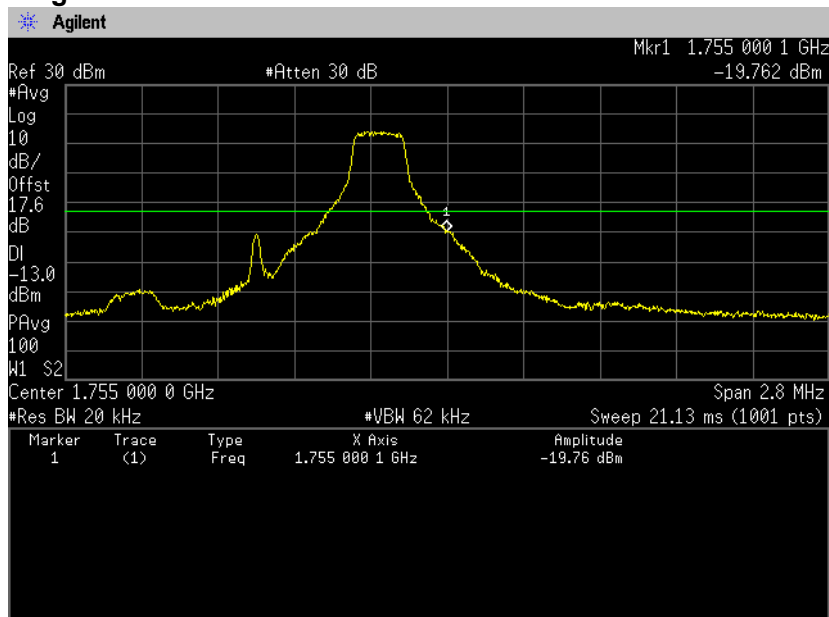

QPSK, BW 1.4MHz, RB6-0
Channel: Low

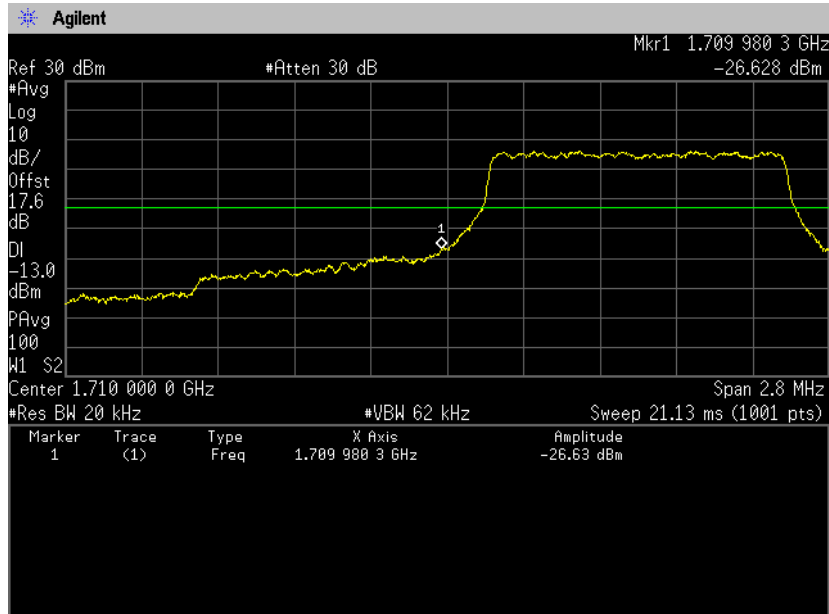

QPSK, BW 1.4MHz, RB6-0
Channel: High

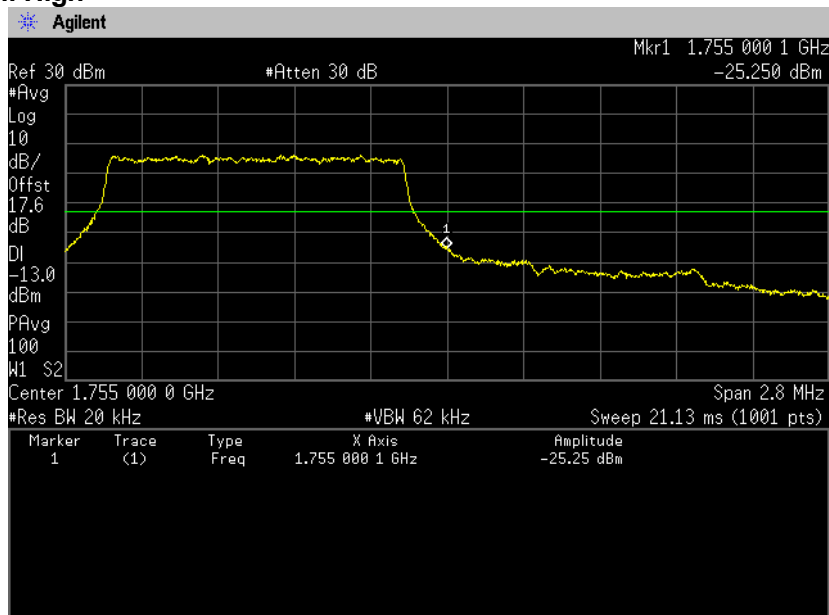

16QAM, BW 1.4MHz, RB1-0
Channel: Low

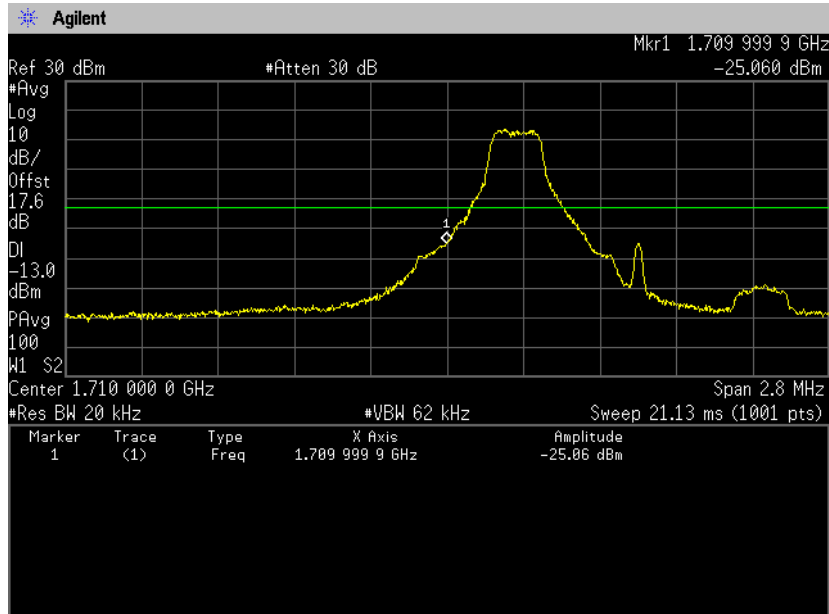

16QAM, BW 1.4MHz, RB1-5
Channel: High

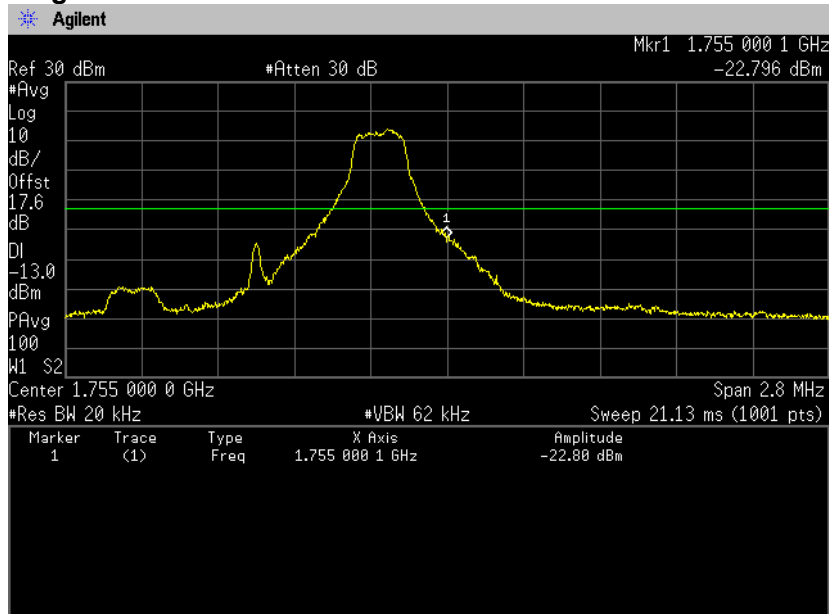



Zacta

16QAM, BW 1.4MHz, RB6-0
Channel: Low

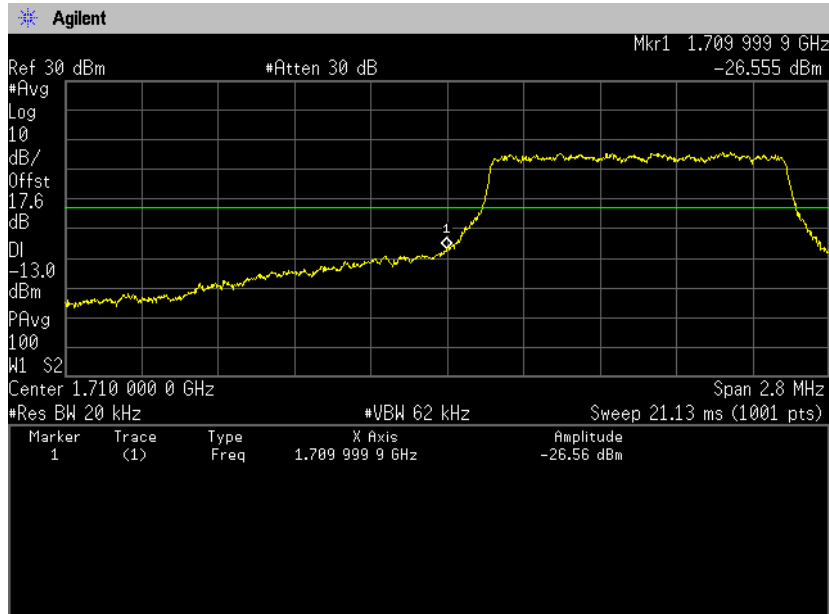

16QAM, BW 1.4MHz, RB6-0
Channel: High

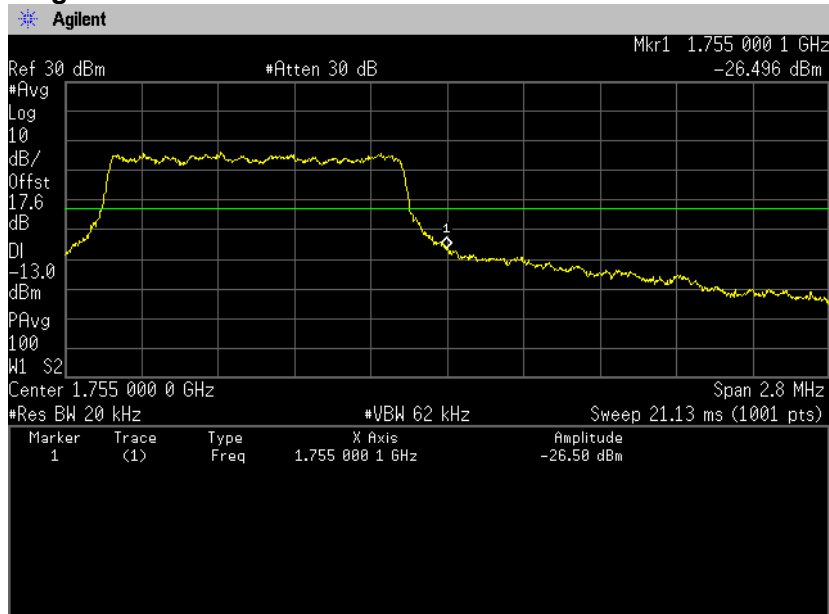

QPSK, BW 3MHz, RB1-0
Channel: Low

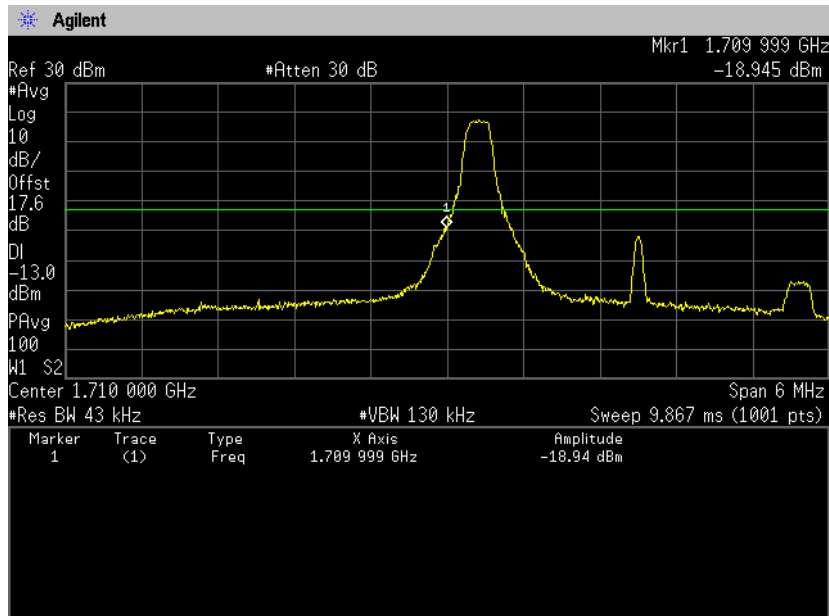

QPSK, BW 3MHz, RB1-14
Channel: High

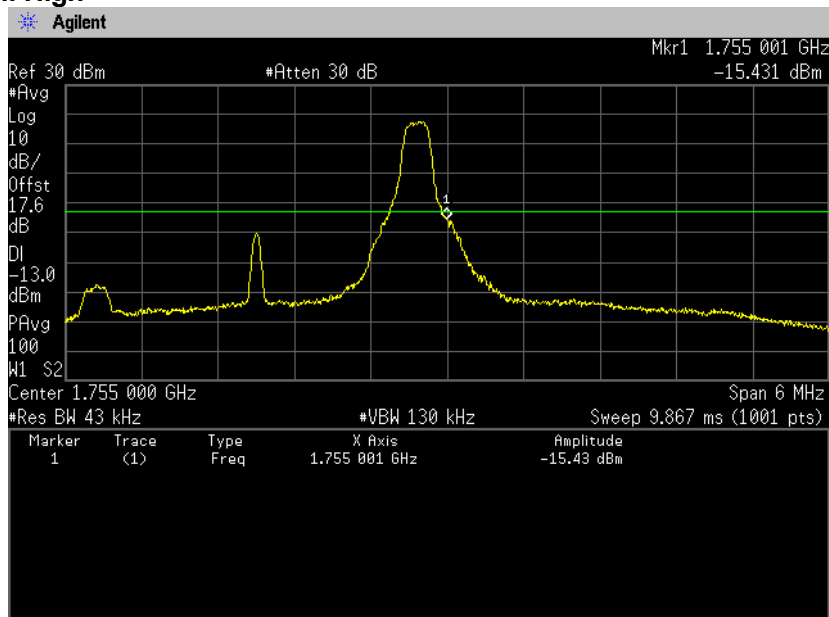



Zacta

QPSK, BW 3MHz, RB15-0
Channel: Low

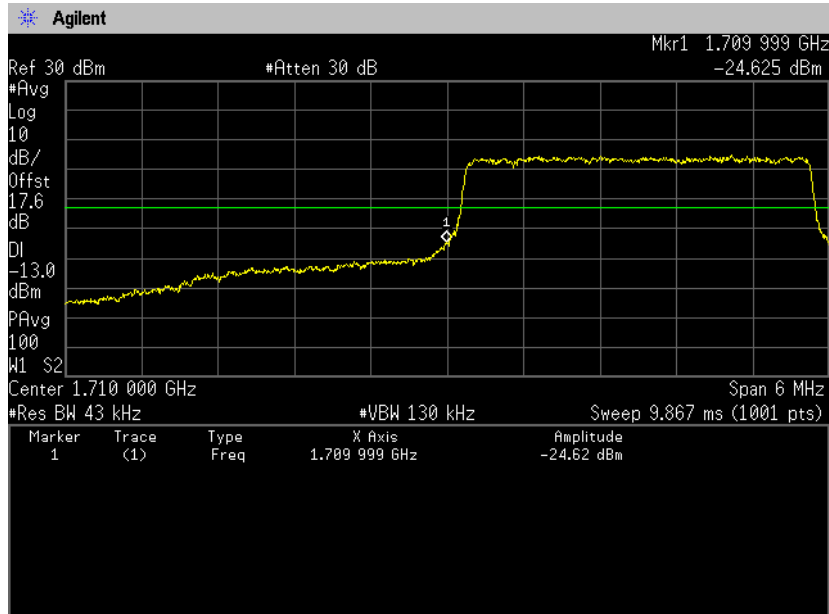

QPSK, BW 3MHz, RB15-0
Channel: High

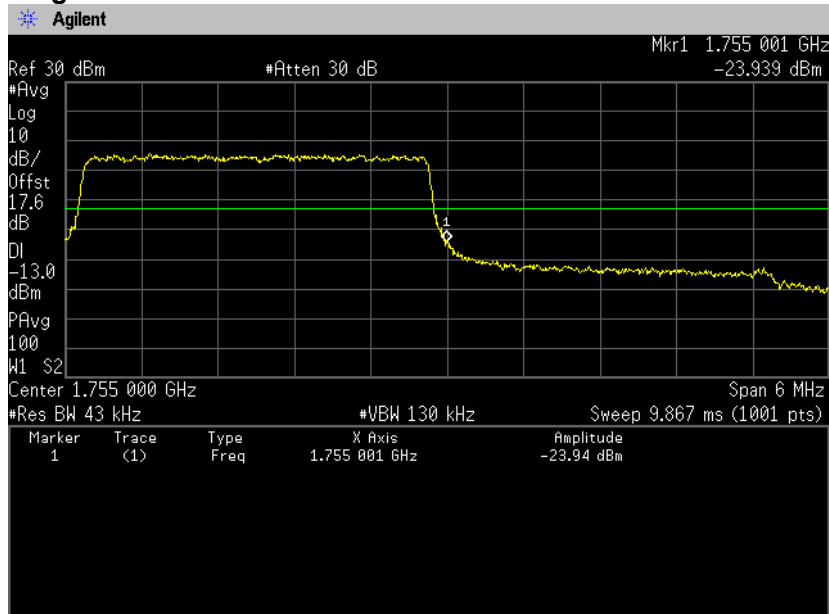



Zacta

16QAM, BW 3MHz, RB1-0
Channel: Low

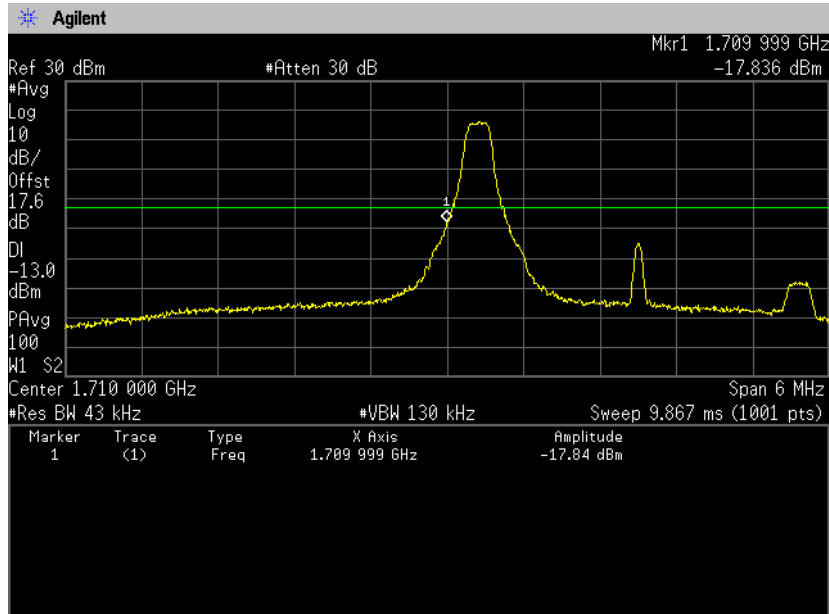

16QAM, BW 3MHz, RB1-14
Channel: High

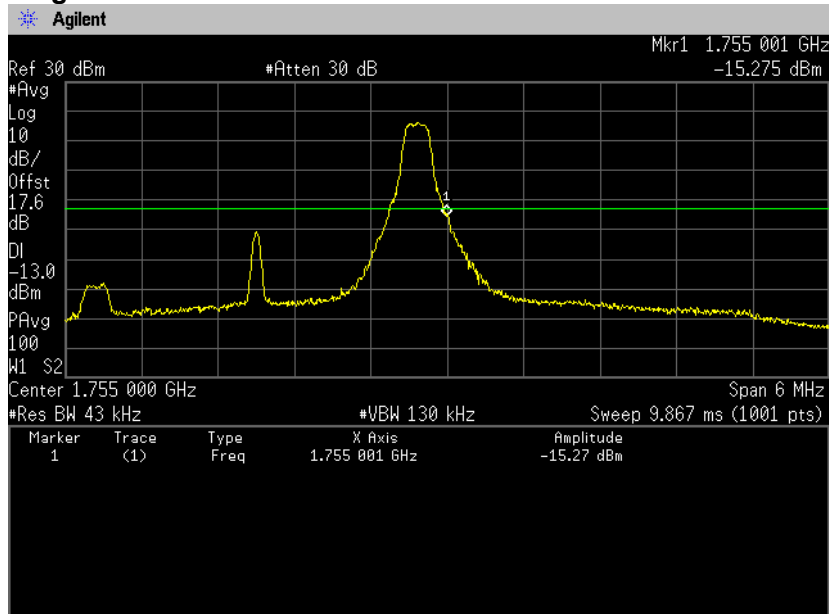



Zacta

16QAM, BW 3MHz, RB15-0
Channel: Low

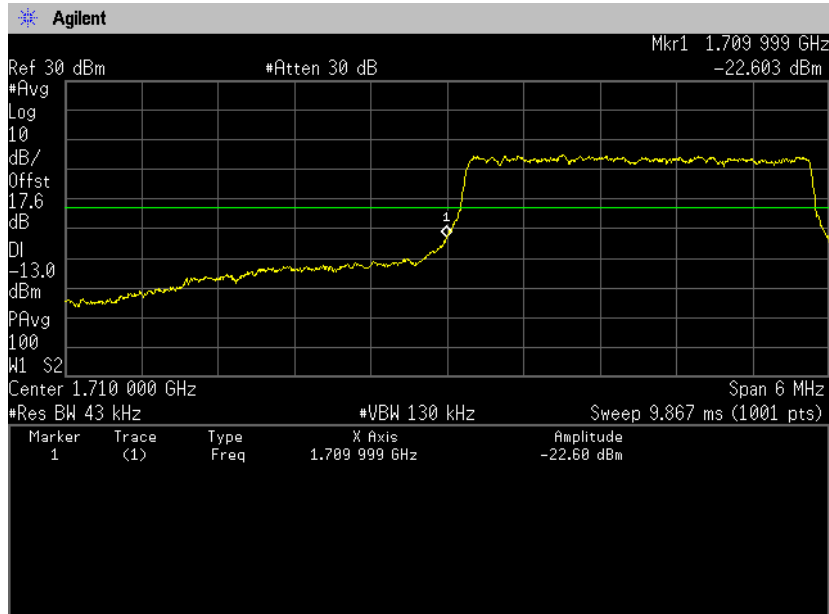

16QAM, BW 3MHz, RB15-0
Channel: High

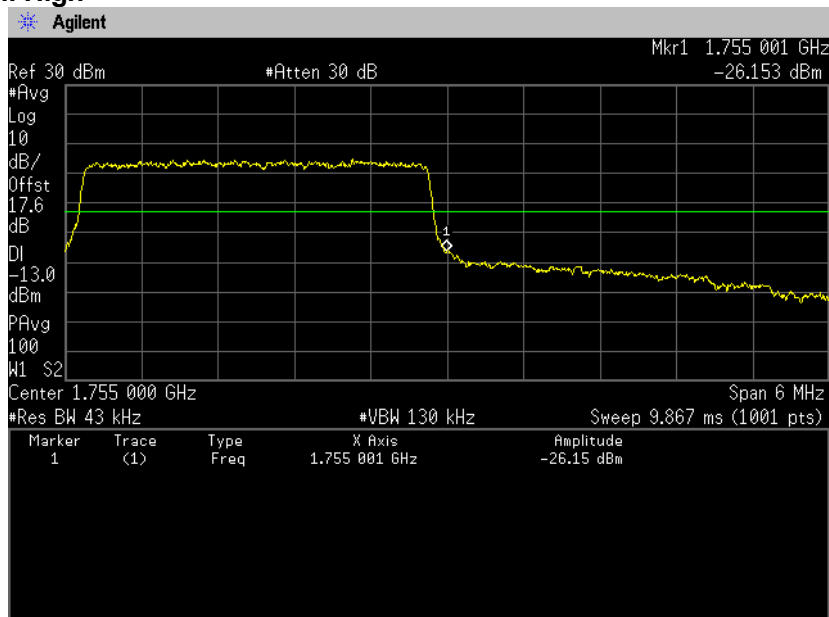



Zacta

QPSK, BW 5MHz, RB1-0
Channel: Low

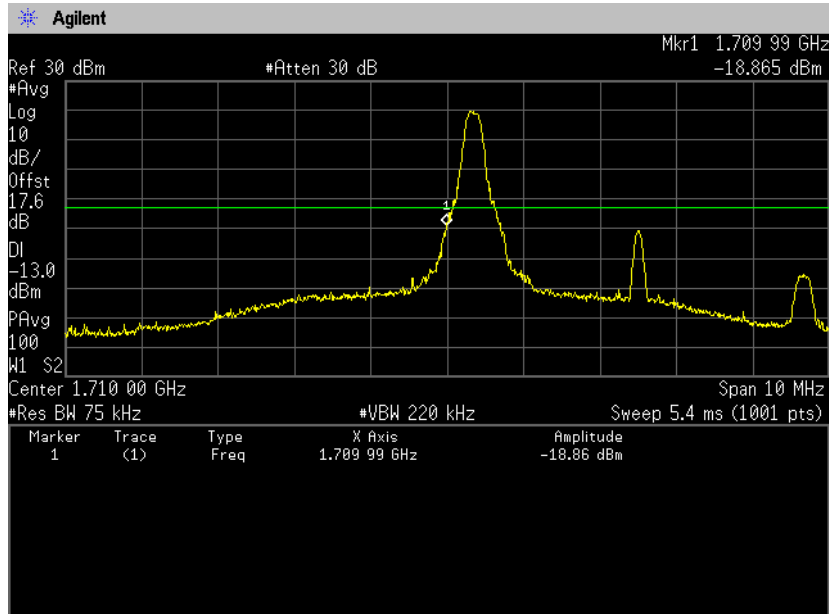

QPSK, BW 5MHz, RB1-24
Channel: High

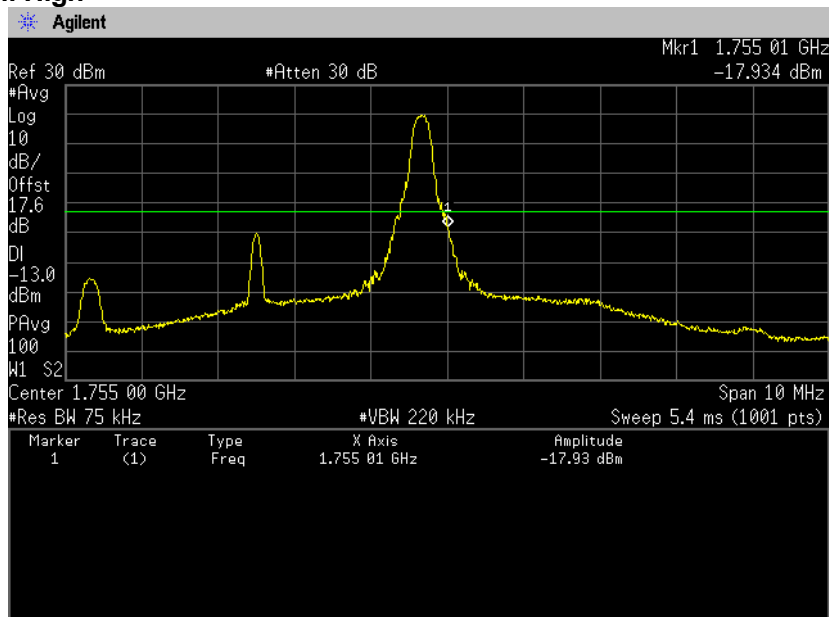



Zacta

QPSK, BW 5MHz, RB25-0 Channel: Low

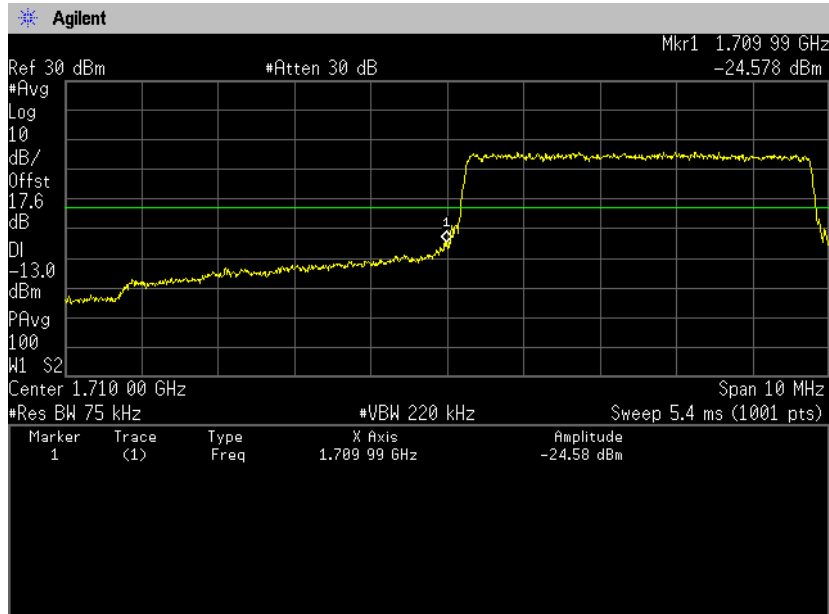

QPSK, BW 5MHz, RB25-0 Channel: High

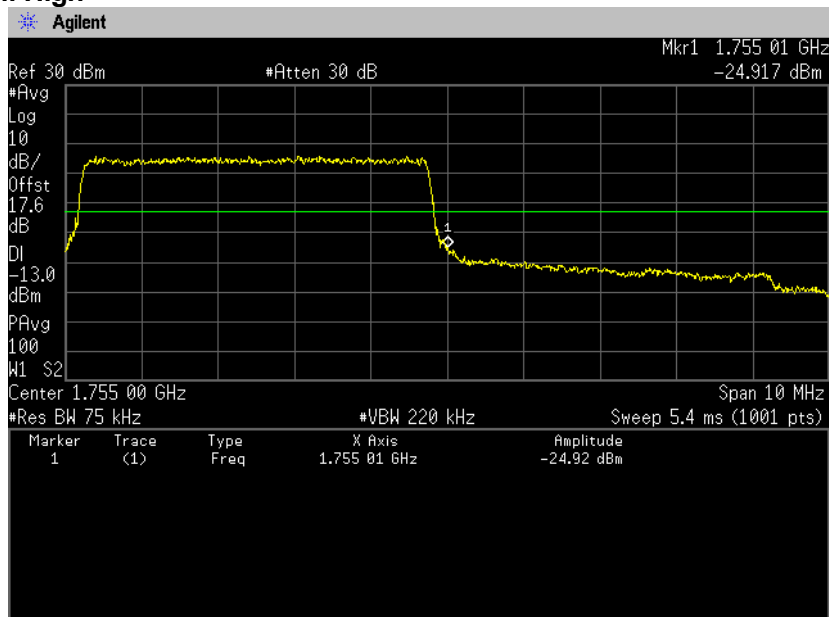



Zacta

16QAM, BW 5MHz, RB1-0
Channel: Low

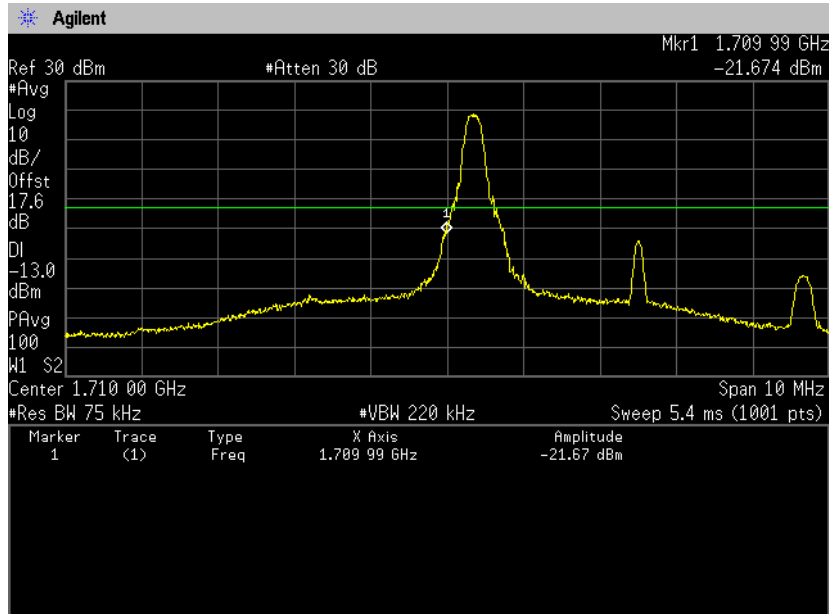

16QAM, BW 5MHz, RB1-24
Channel: High

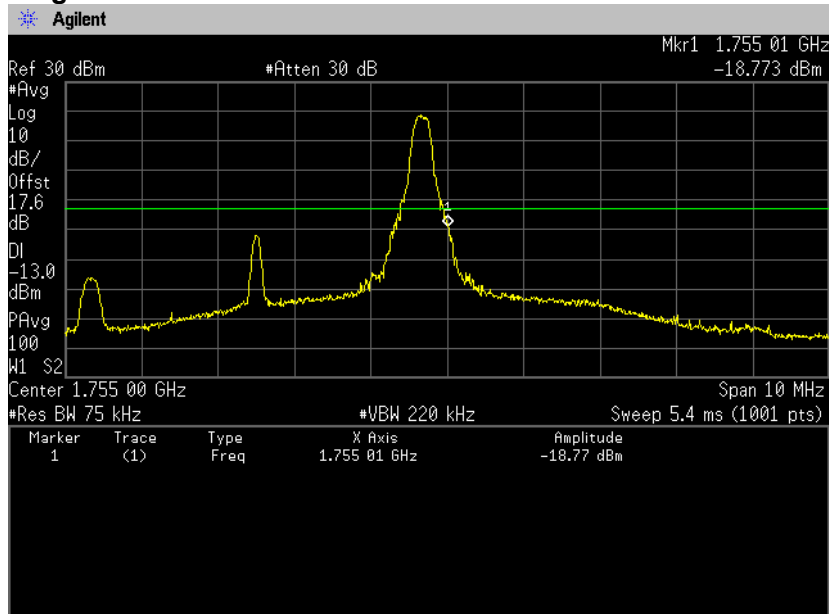



Zacta

16QAM, BW 5MHz, RB25-0
Channel: Low

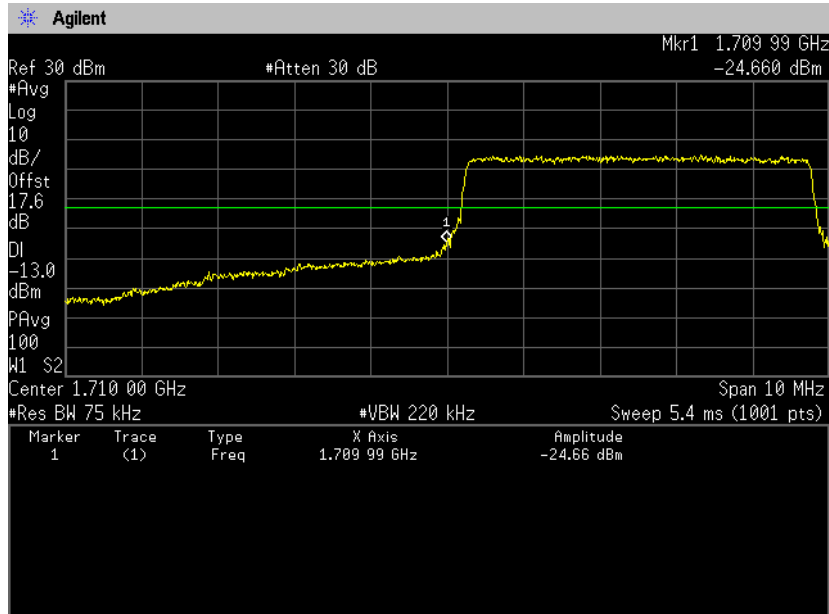

16QAM, BW 5MHz, RB25-0
Channel: High

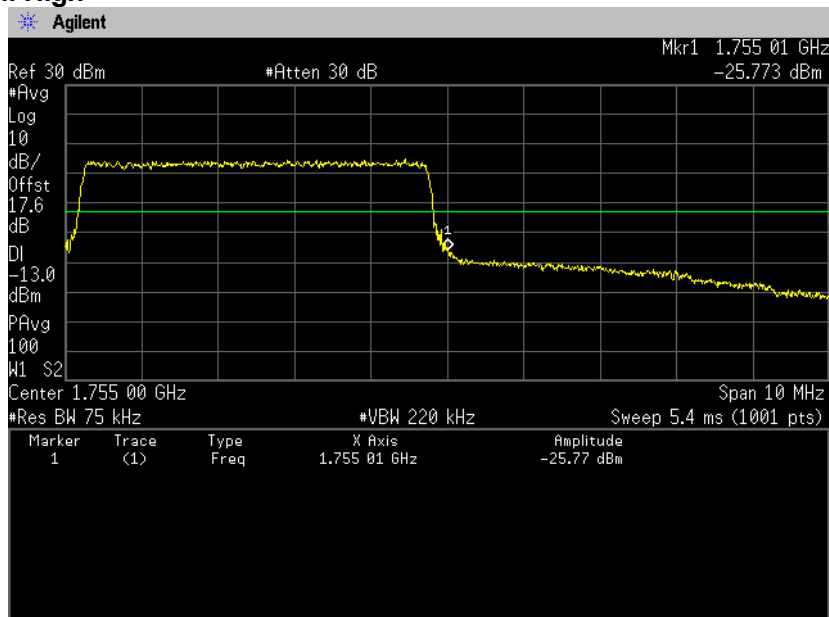

QPSK, BW 10MHz, RB1-0
Channel: Low

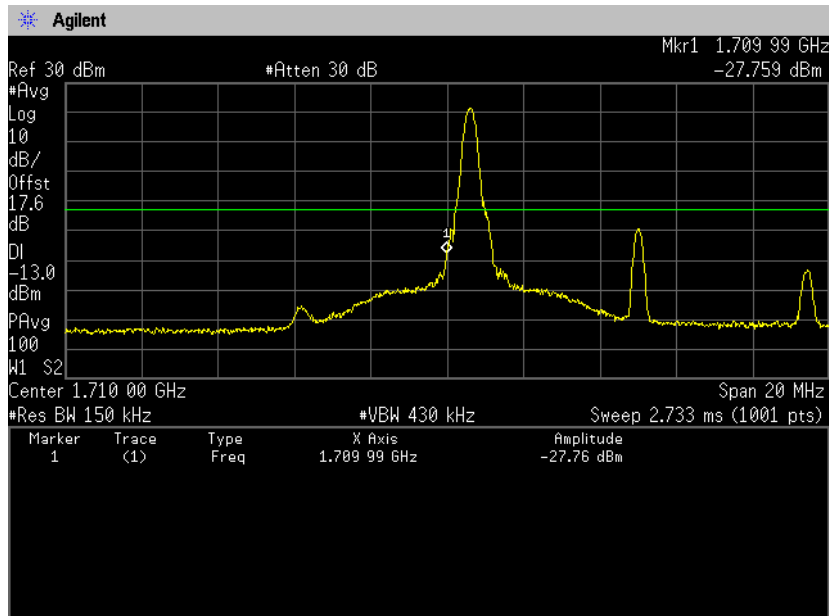

QPSK, BW 10MHz, RB1-49
Channel: High

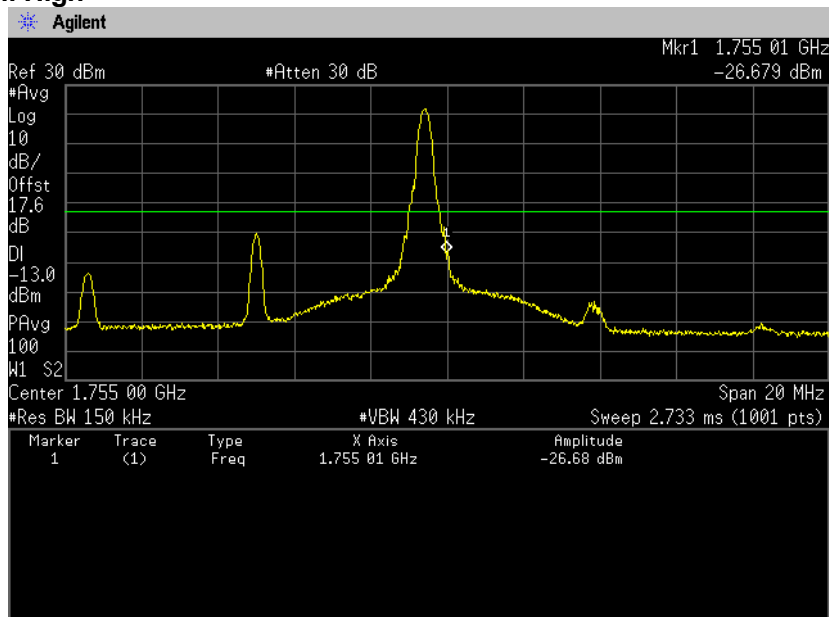



Zacta

QPSK, BW 10MHz, RB50-0
Channel: Low

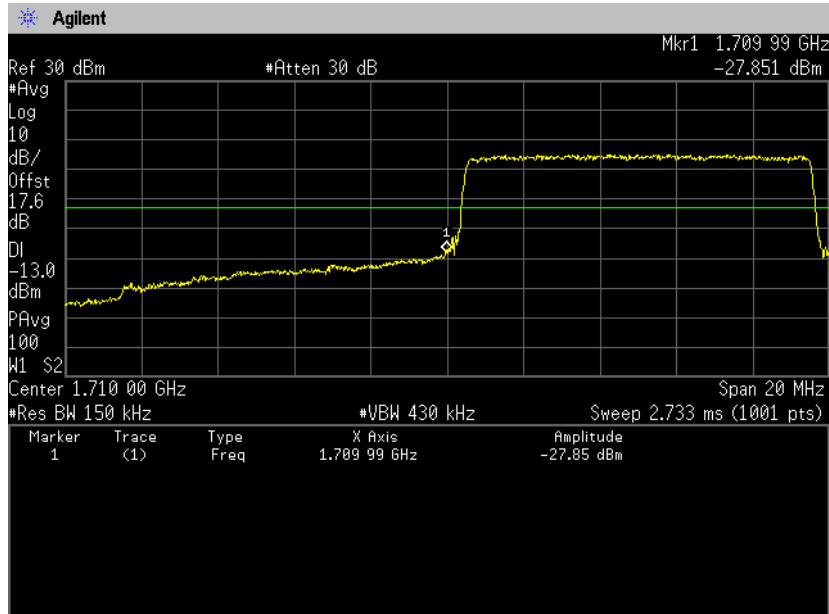

QPSK, BW 10MHz, RB50-0
Channel: High

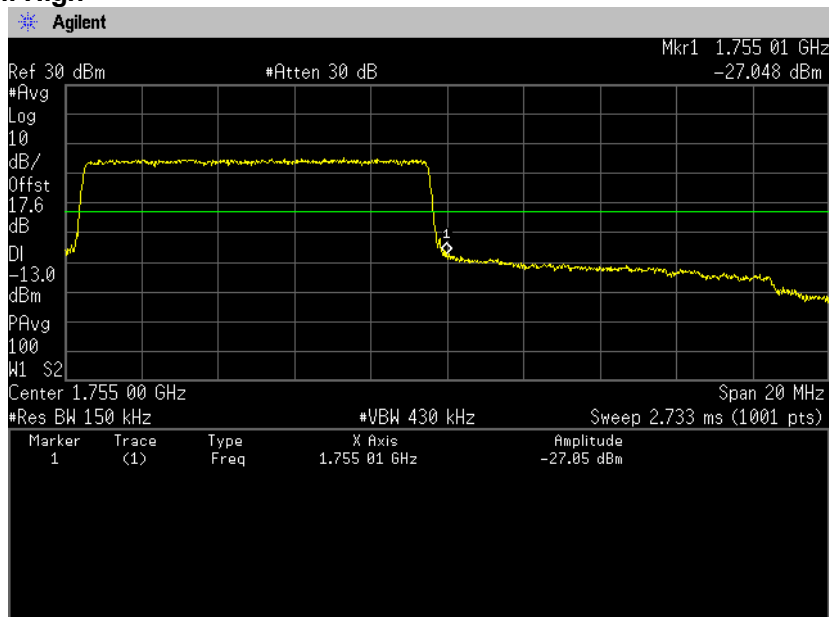



Zacta

16QAM, BW 10MHz, RB1-0
Channel: Low

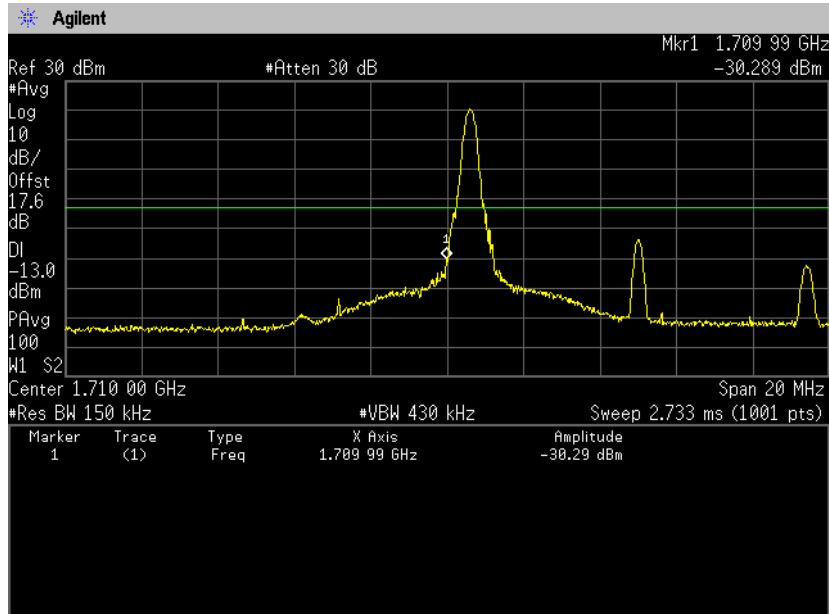

16QAM, BW 10MHz, RB1-49
Channel: High

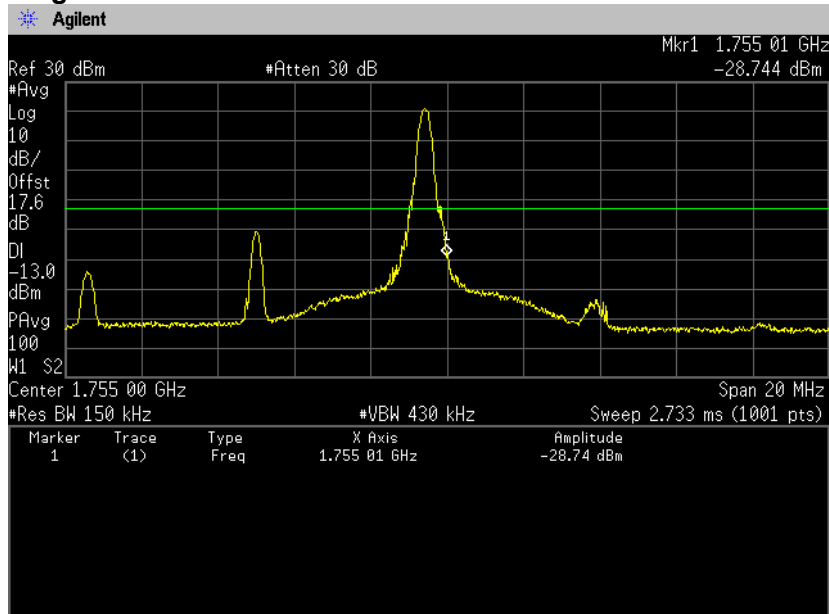



Zacta

16QAM, BW 10MHz, RB50-0
Channel: Low

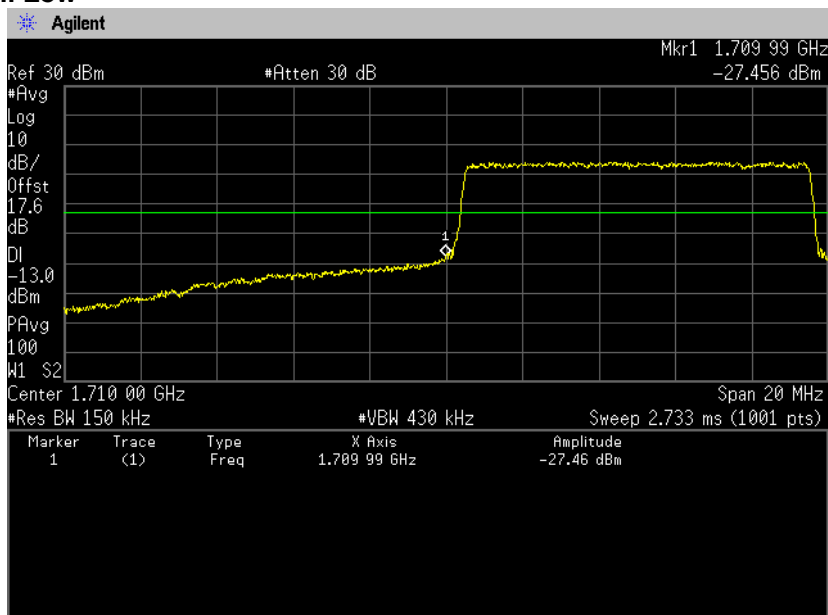

16QAM, BW 10MHz, RB50-0
Channel: High

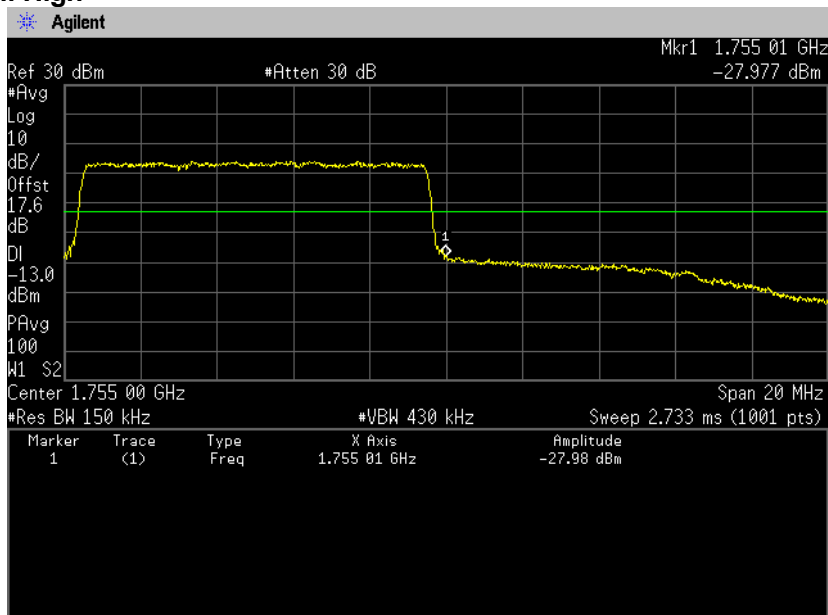



Zacta

QPSK, BW 15MHz, RB1-0
Channel: Low

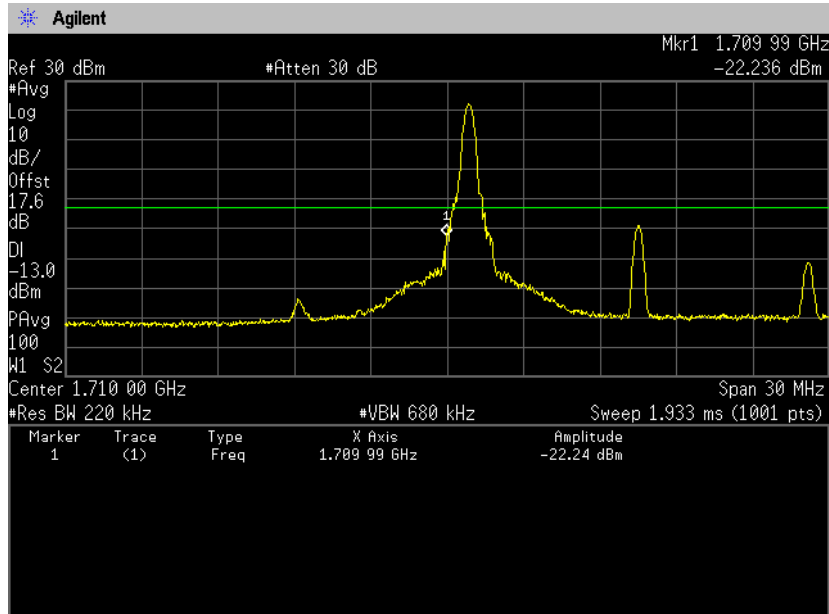

QPSK, BW 15MHz, RB1-74
Channel: High

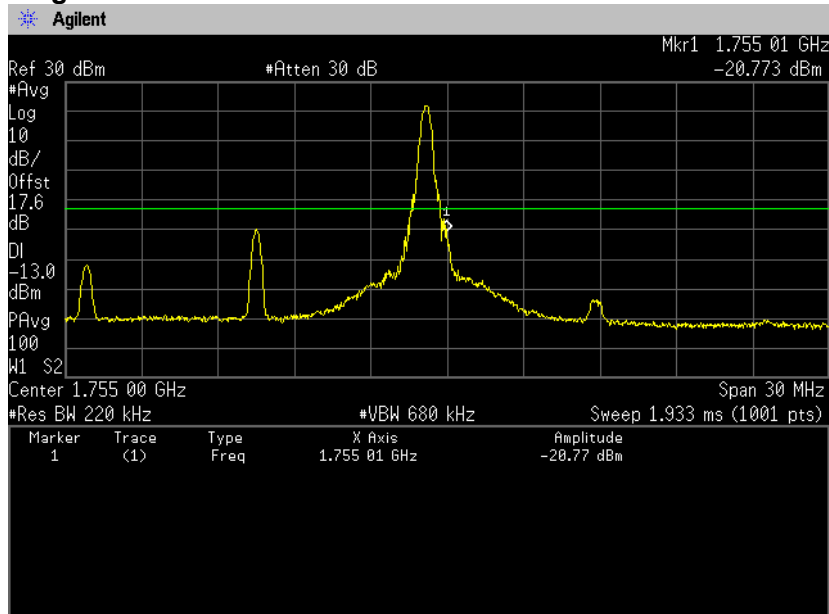



Zacta

QPSK, BW 15MHz, RB75-0
Channel: Low

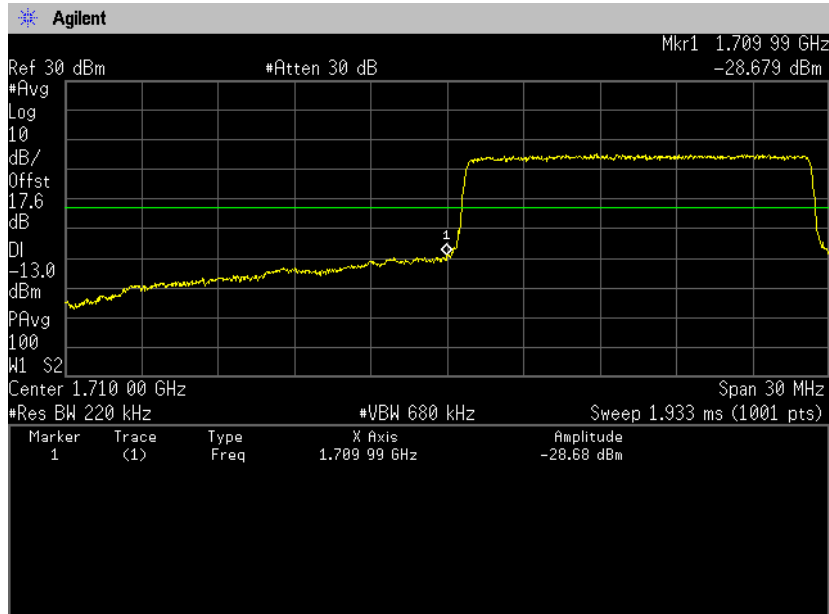

QPSK, BW 15MHz, RB75-0
Channel: High

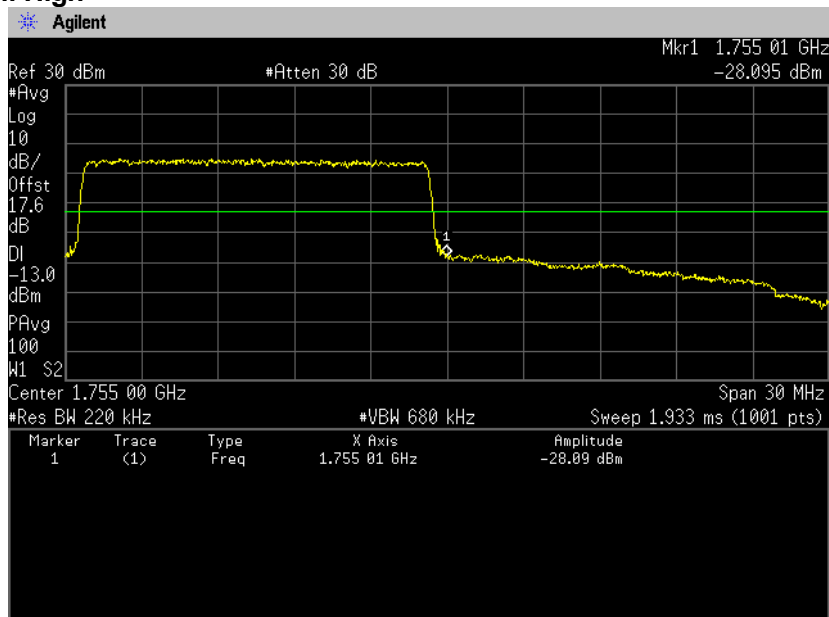



Zacta

16QAM, BW 15MHz, RB1-0
Channel: Low

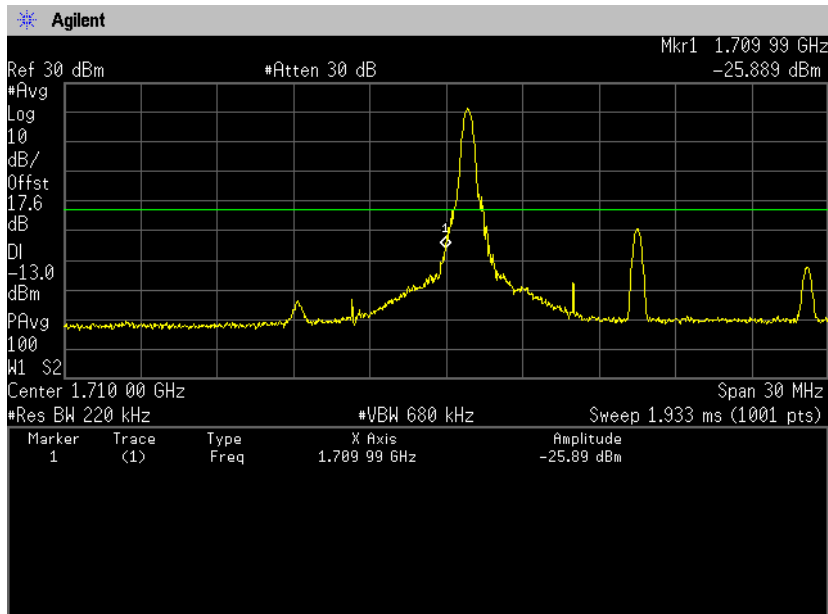

16QAM, BW 15MHz, RB1-74
Channel: High

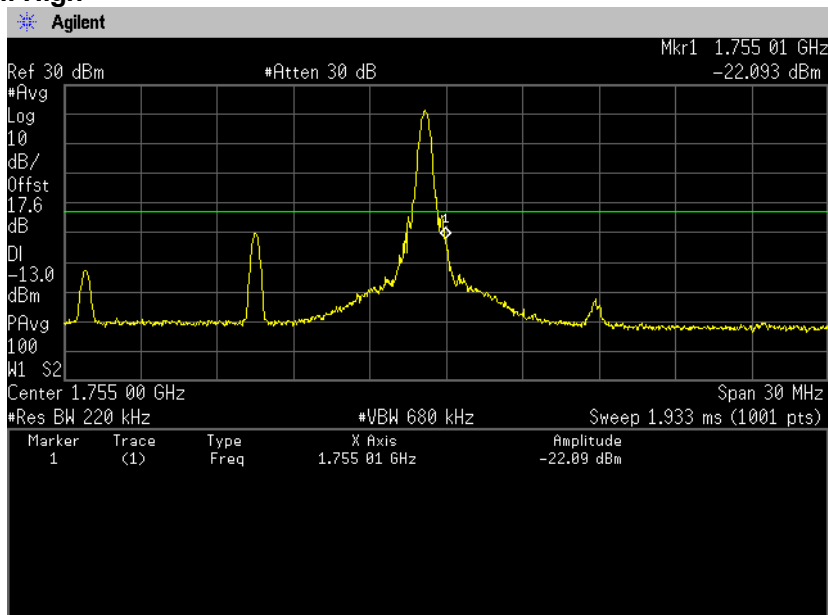



Zacta

16QAM, BW 15MHz, RB75-0
Channel: Low

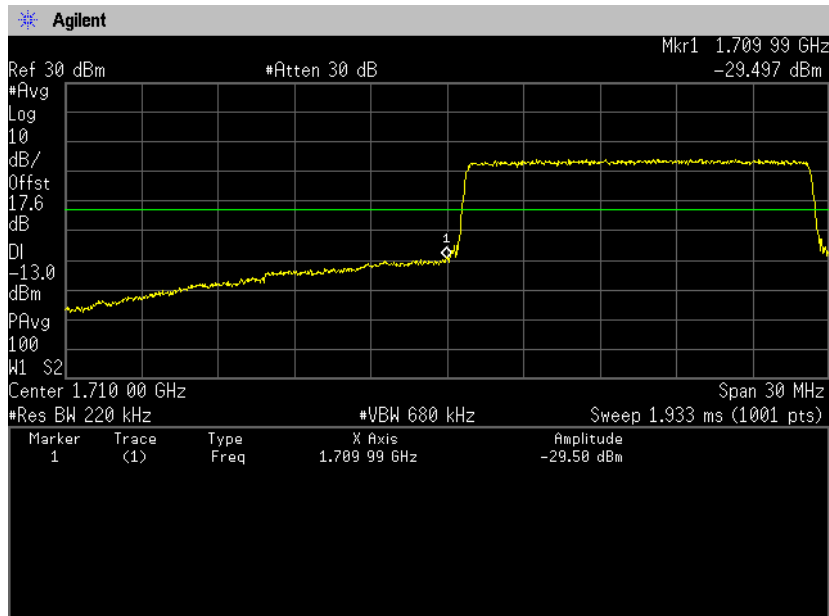

16QAM, BW 15MHz, RB75-0
Channel: High

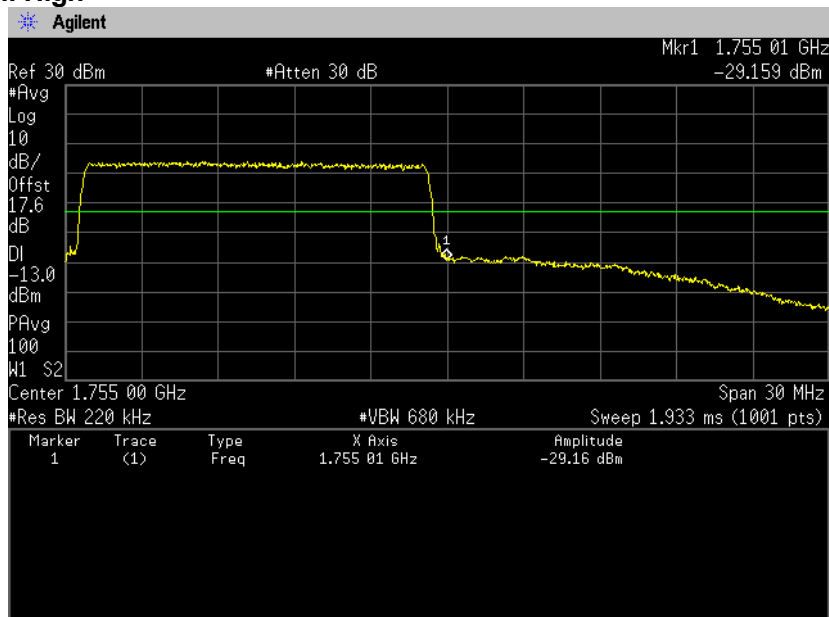

QPSK, BW 20MHz, RB1-0
Channel: Low

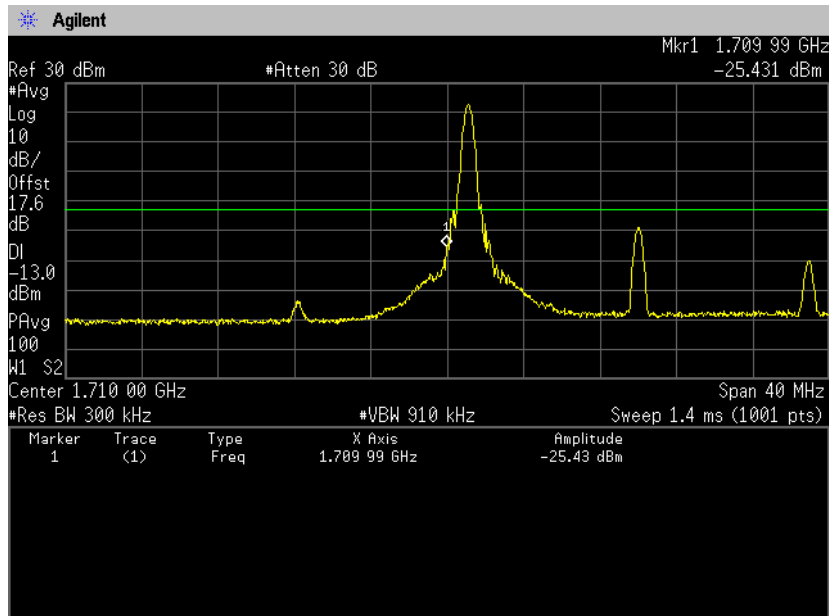

QPSK, BW 20MHz, RB1-99
Channel: High

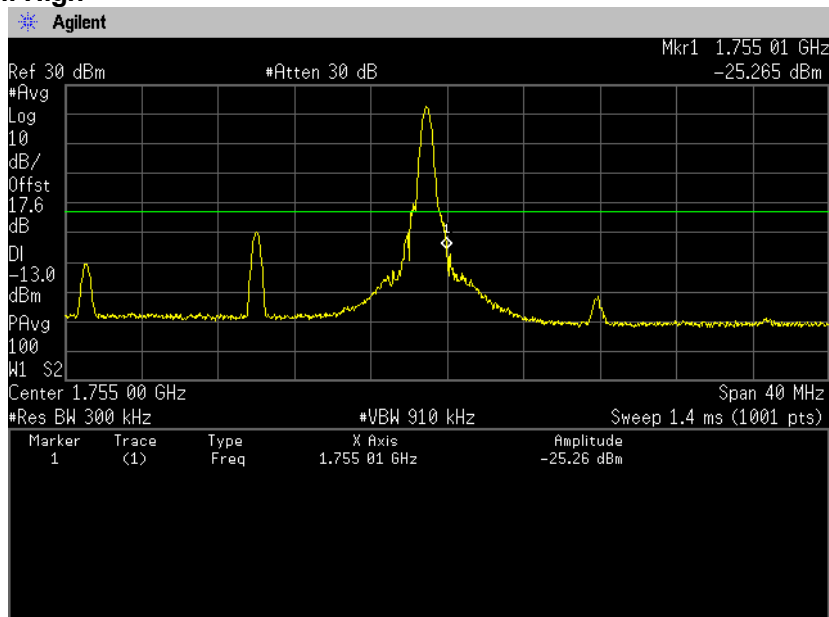



Zacta

QPSK, BW 20MHz, RB100-0
Channel: Low

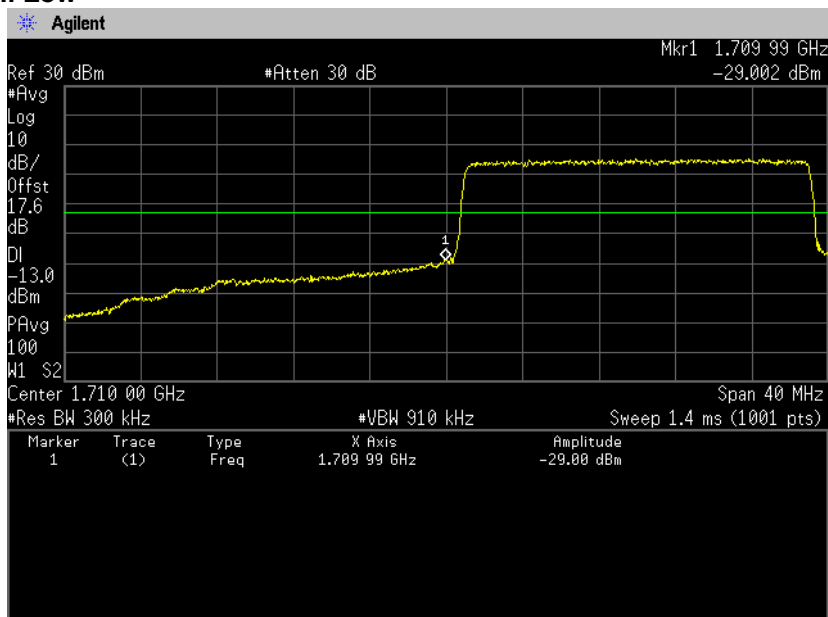

QPSK, BW 20MHz, RB100-0
Channel: High

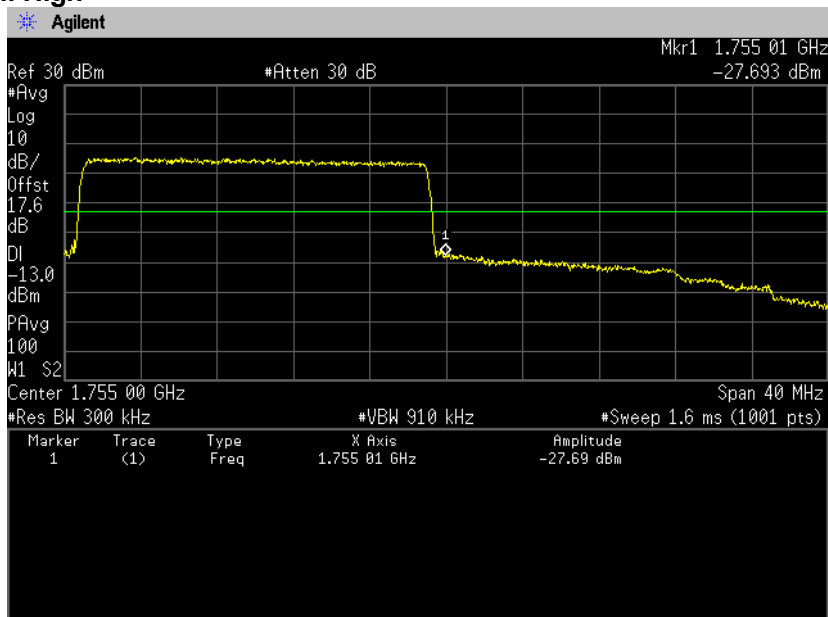



Zacta

16QAM, BW 20MHz, RB1-0
Channel: Low

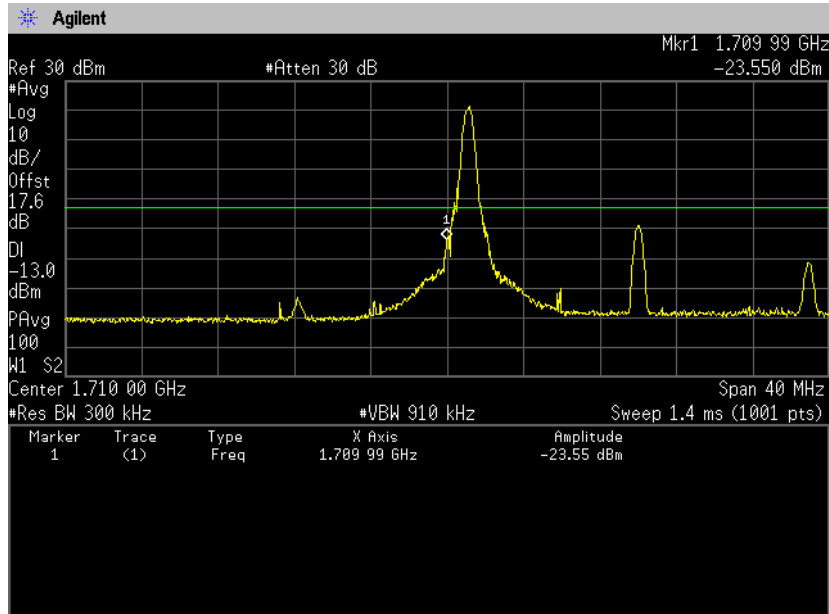

16QAM, BW 20MHz, RB1-99
Channel: High

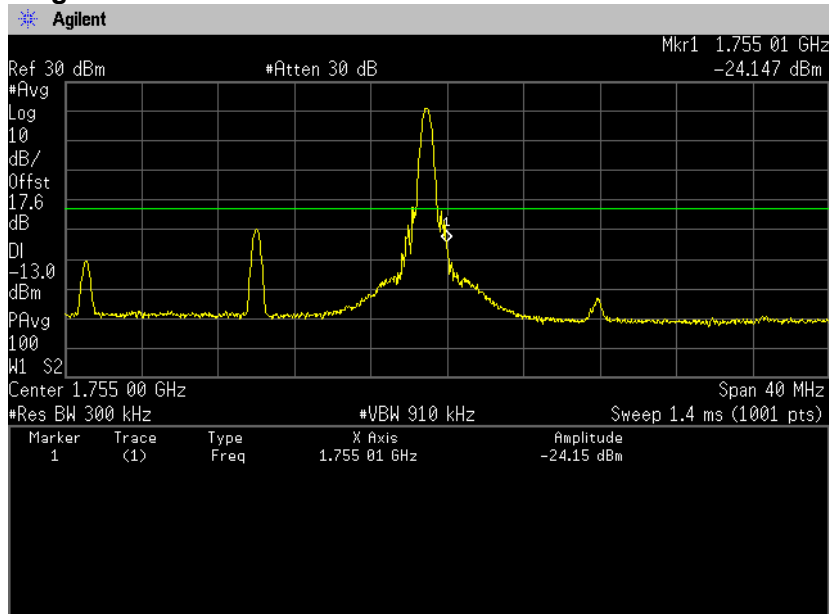

16QAM, BW 20MHz, RB100-0
Channel: Low

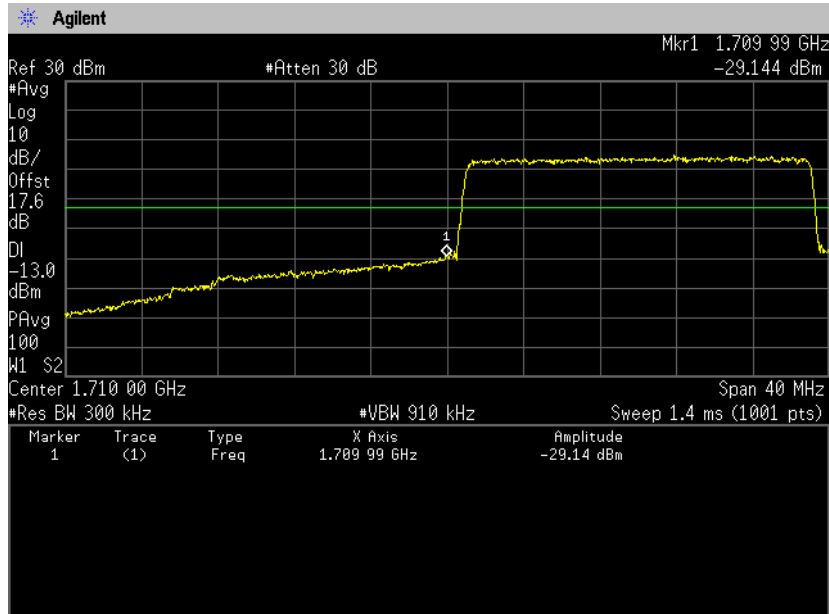

16QAM, BW 20MHz, RB100-0
Channel: High

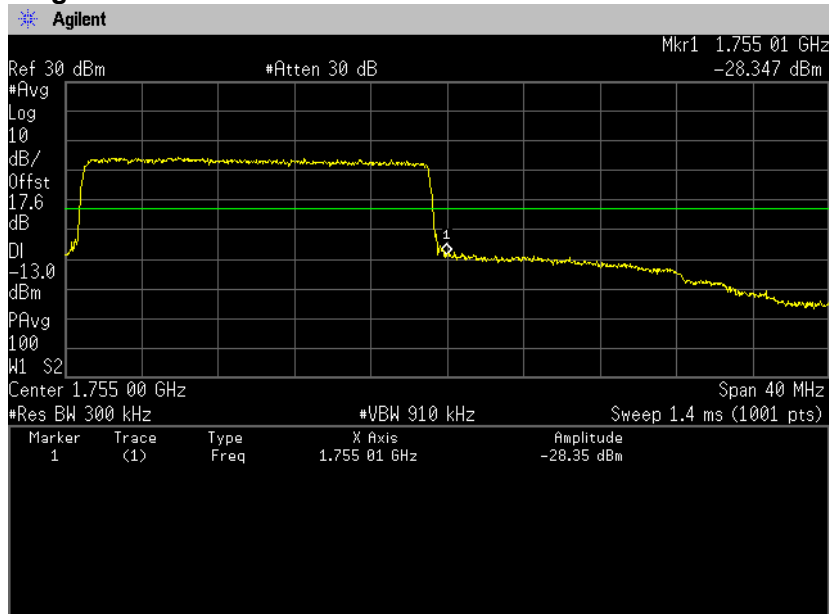

(Spurious Emissions)

Note: Conducted spurious test was measured in the worst case of conducted output power.

**QPSK, BW 20MHz, RB1-0
Channel: 20050
30MHz-5GHz**

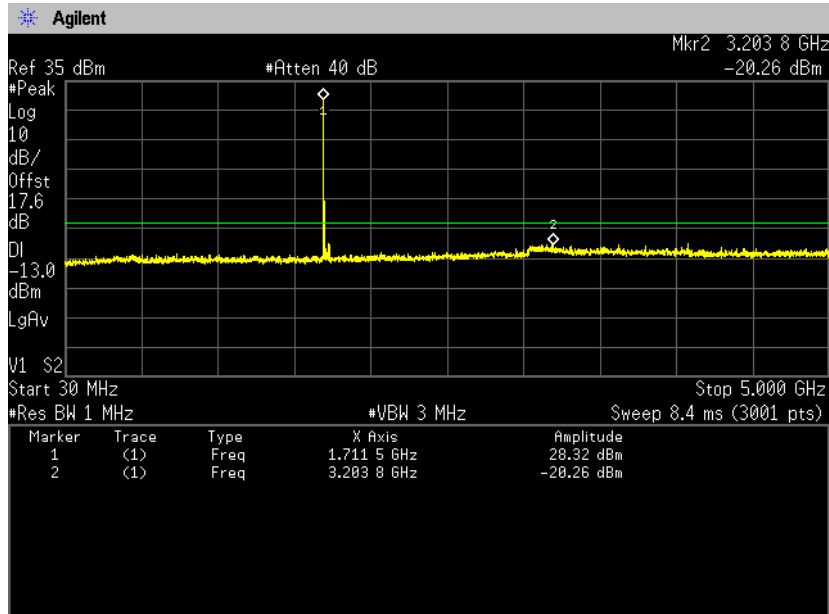

5GHz-10GHz

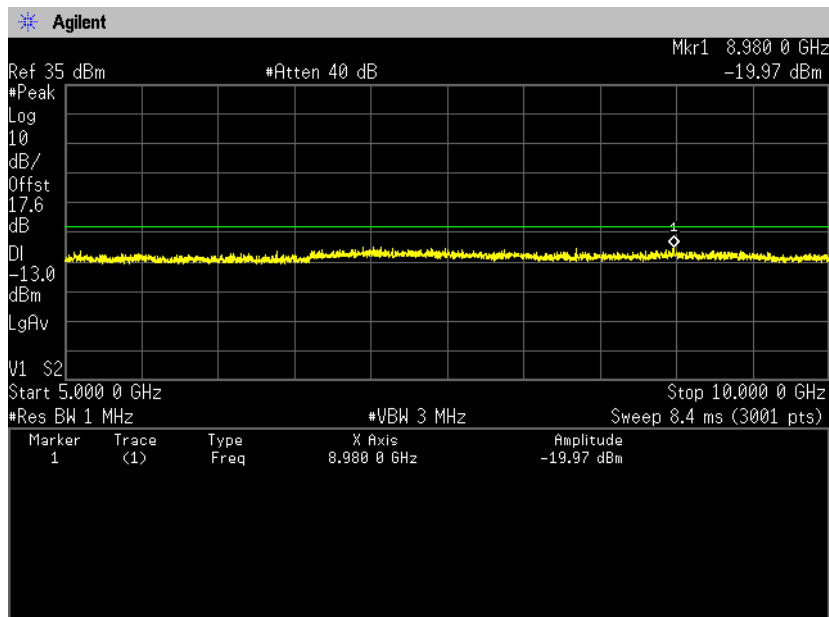



Zacta

10GHz-15GHz

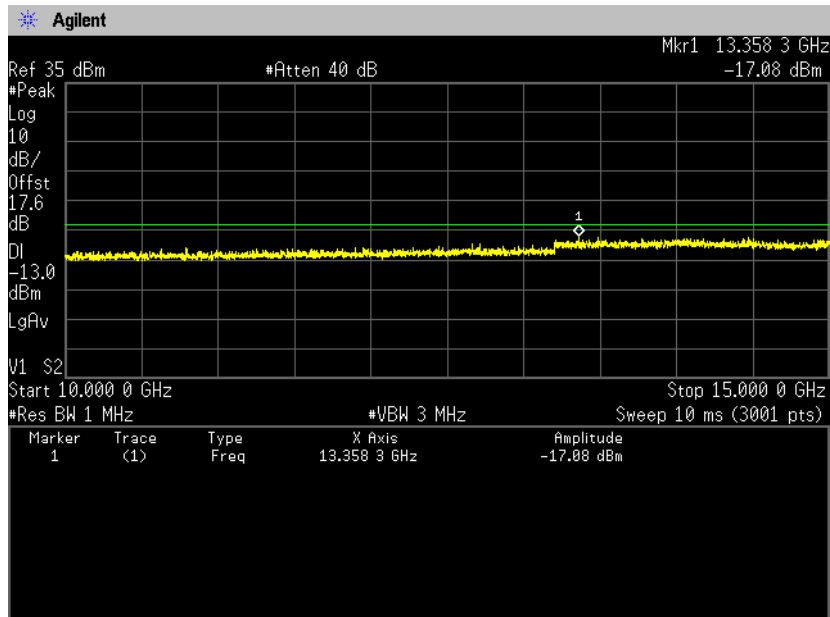

15GHz-20GHz

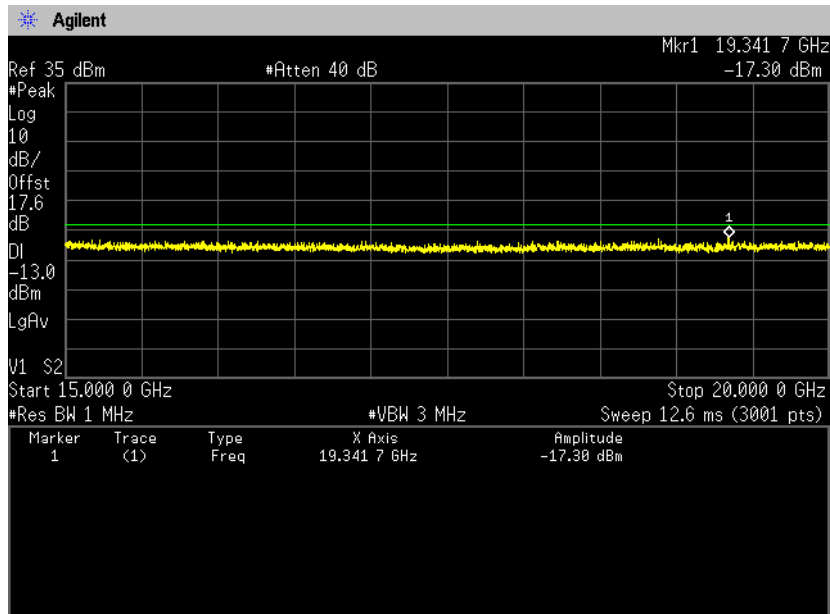



Zacta

**Channel: 20175
30MHz-5GHz**

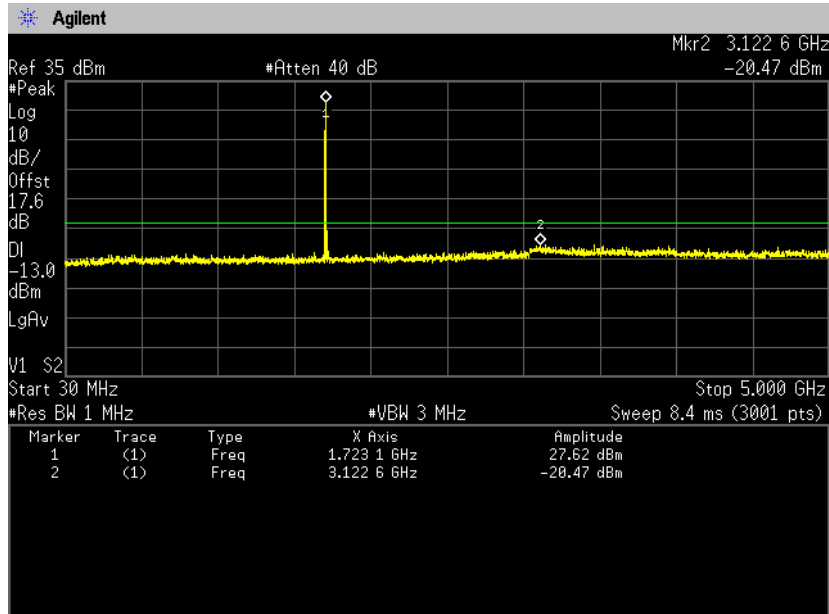

5GHz-10GHz

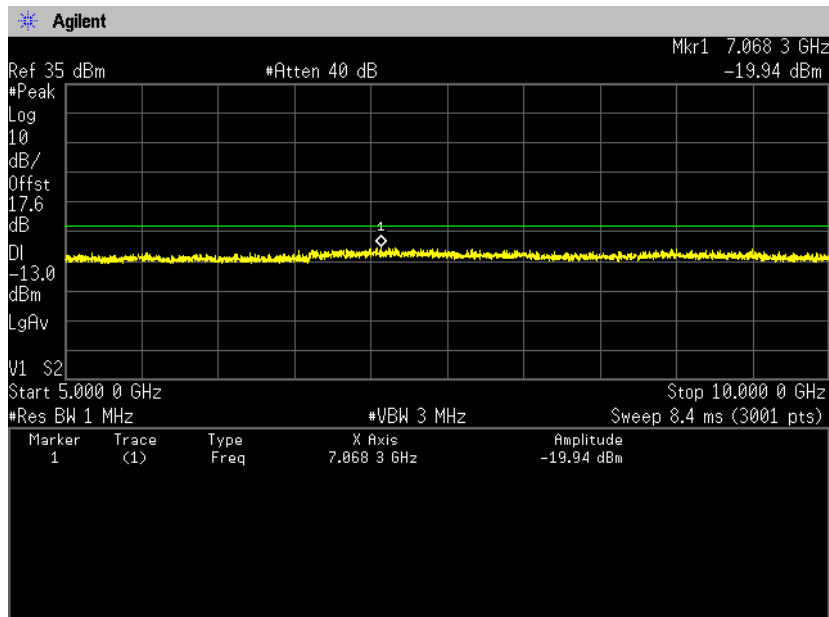



Zacta

10GHz-15GHz

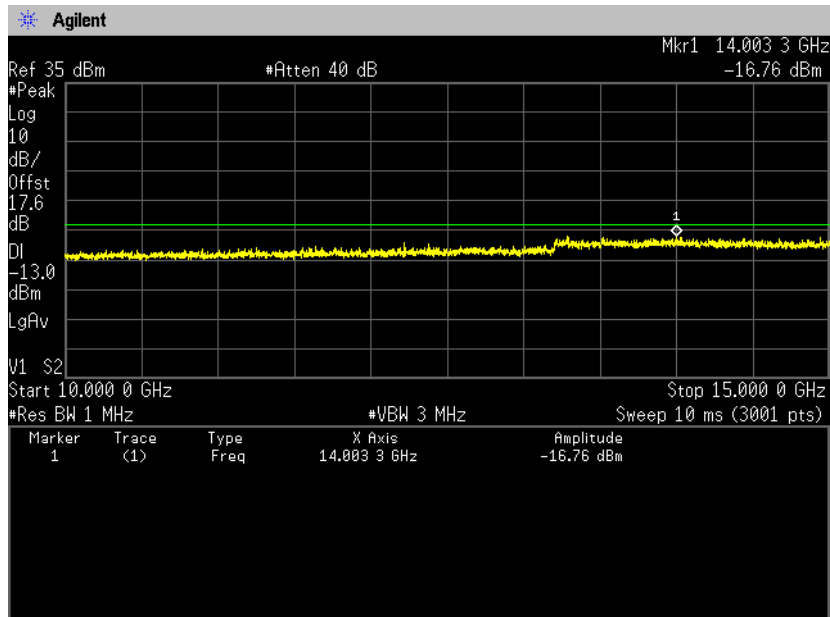

15GHz-20GHz

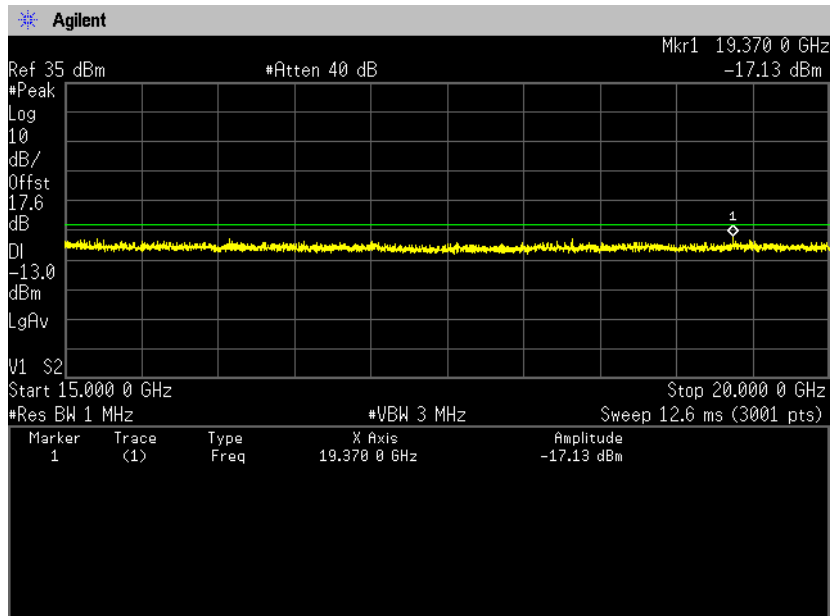



Zacta

**Channel: 20300
30MHz-5GHz**

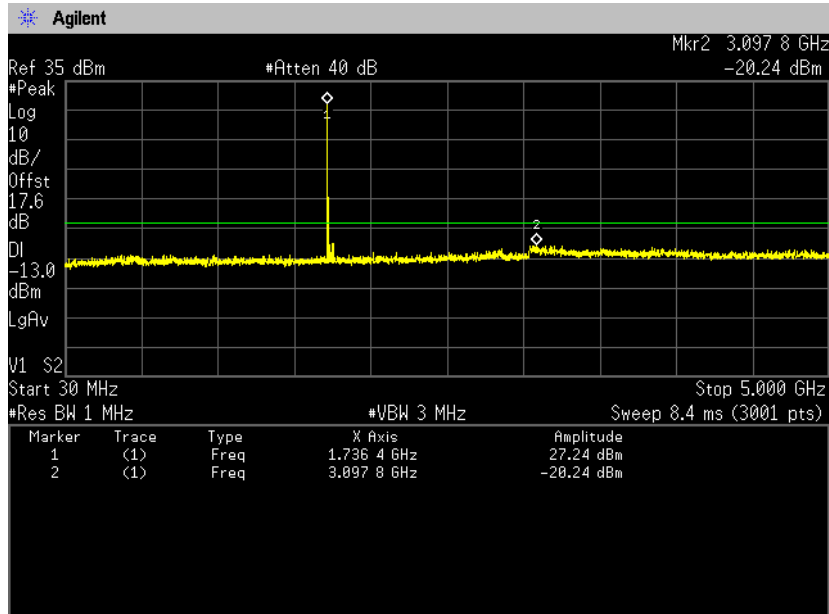

5GHz-10GHz

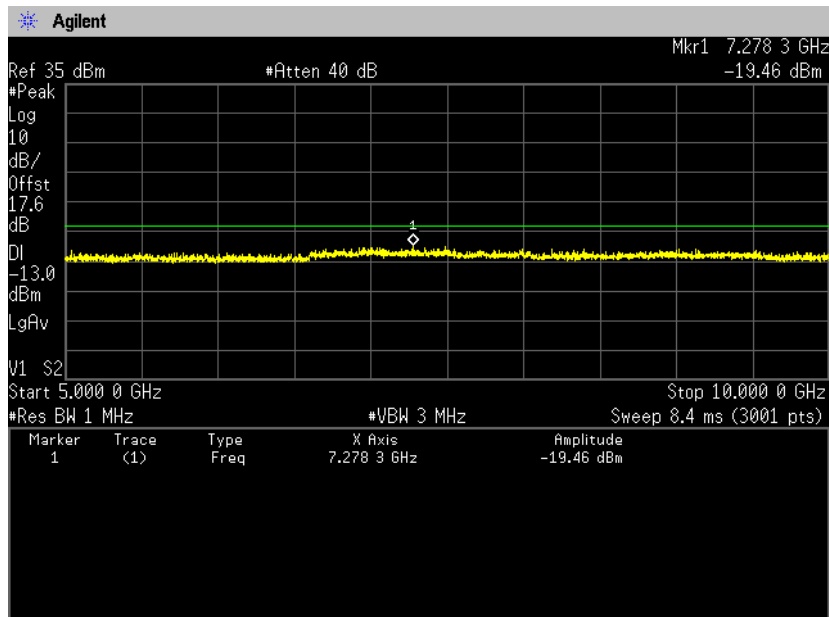



Zacta

10GHz-15GHz

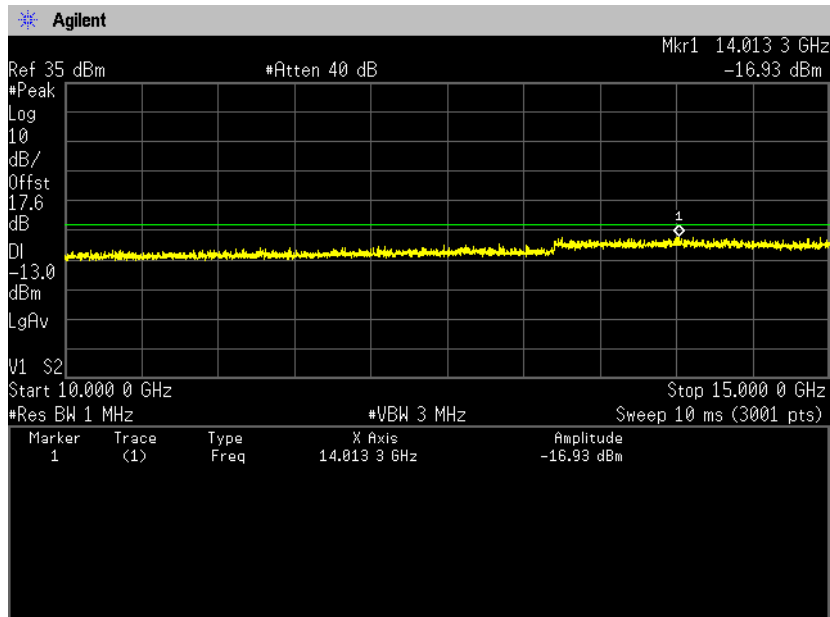

15GHz-20GHz

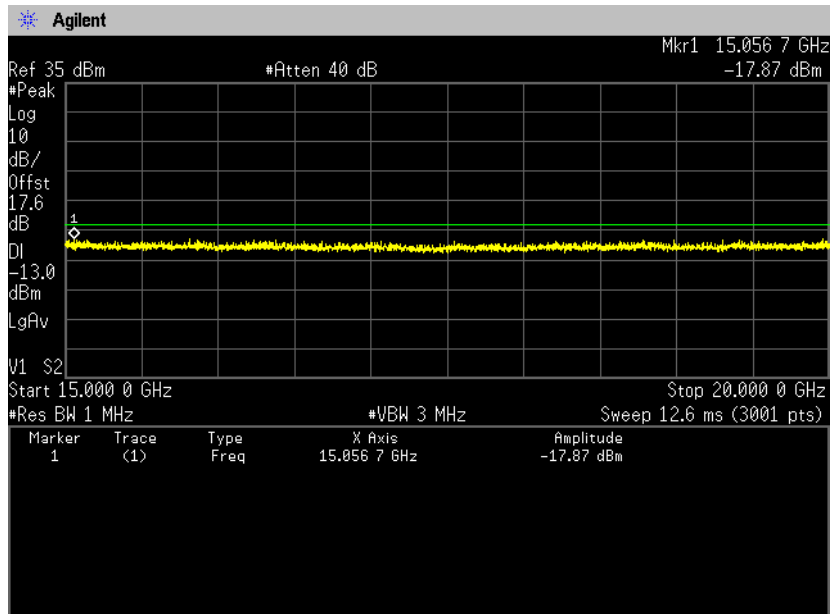



Zacta

16QAM, BW 5MHz, RB1-24
Channel: 19975
30MHz-5GHz

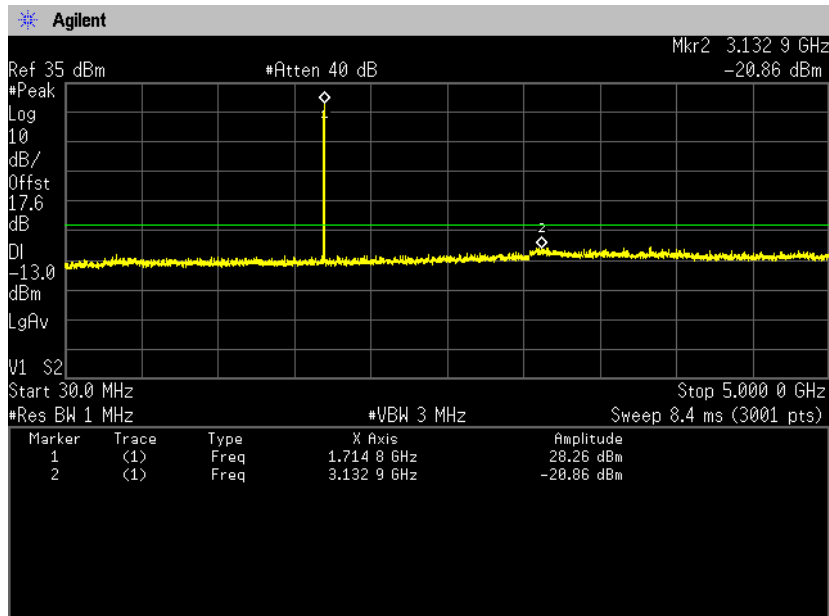

5GHz-10GHz

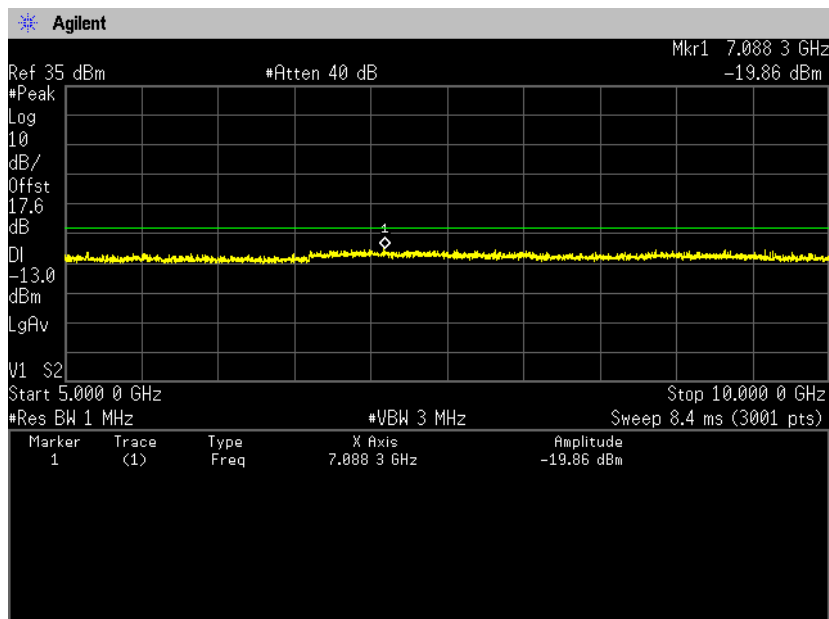



Zacta

10GHz-15GHz

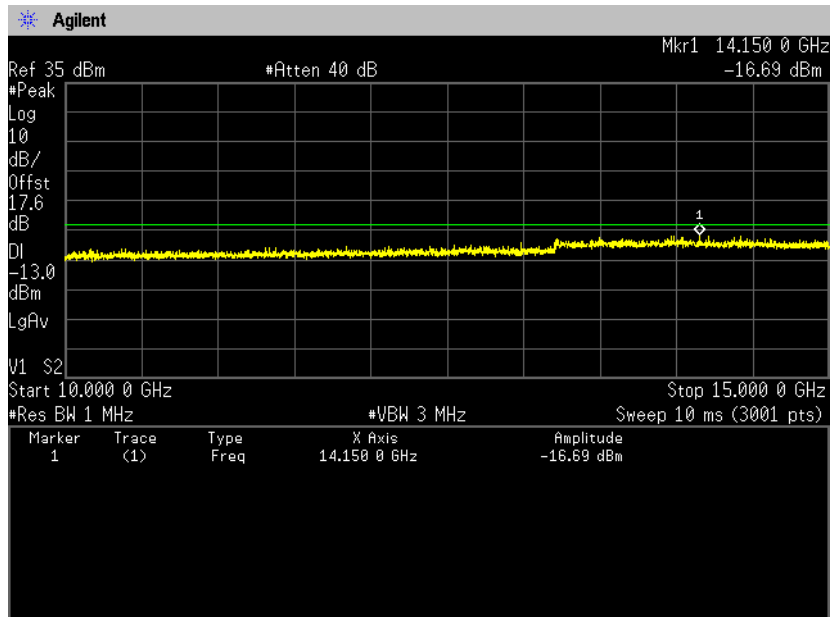

15GHz-20GHz

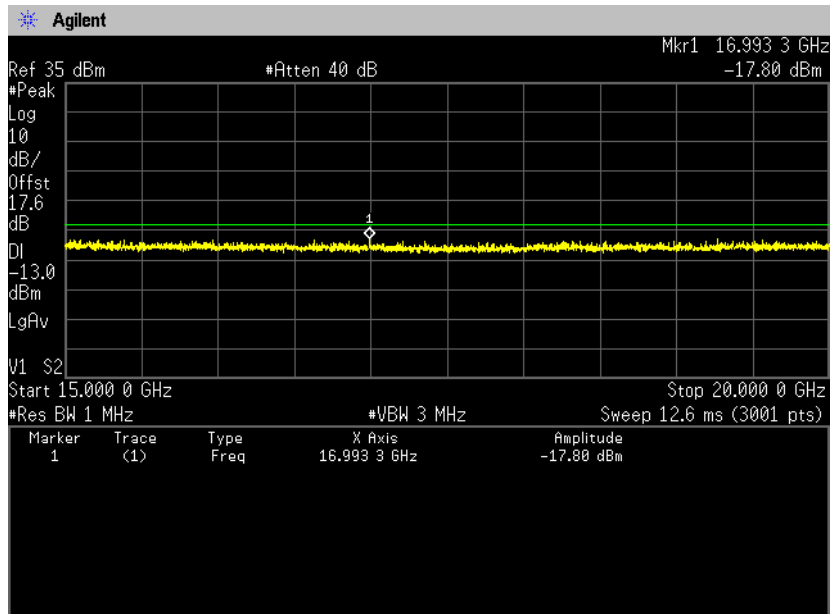



Zacta

**Channel: 20175
30MHz-5GHz**

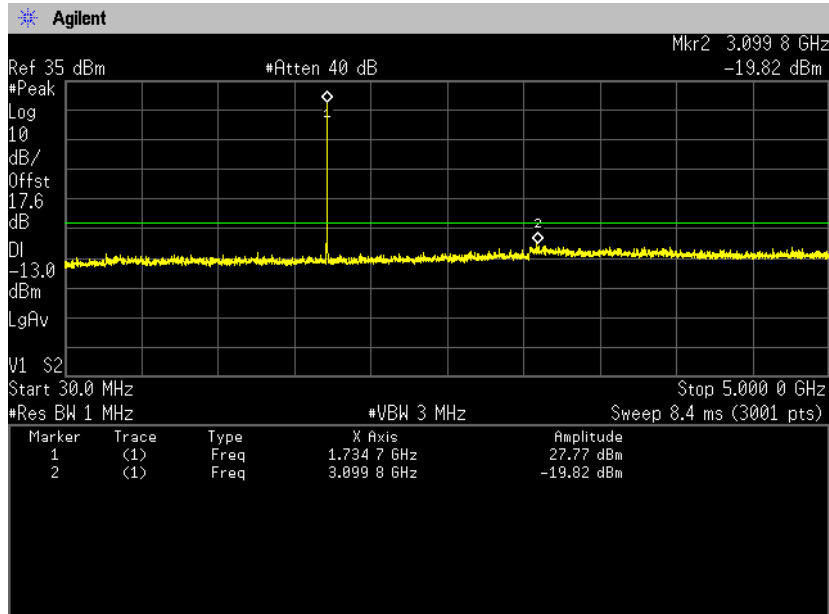

5GHz-10GHz

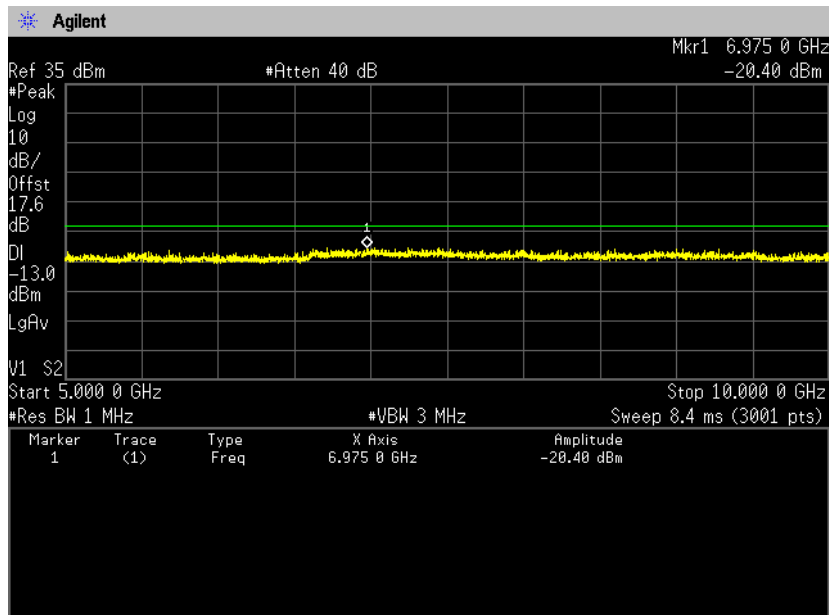



Zacta

10GHz-15GHz

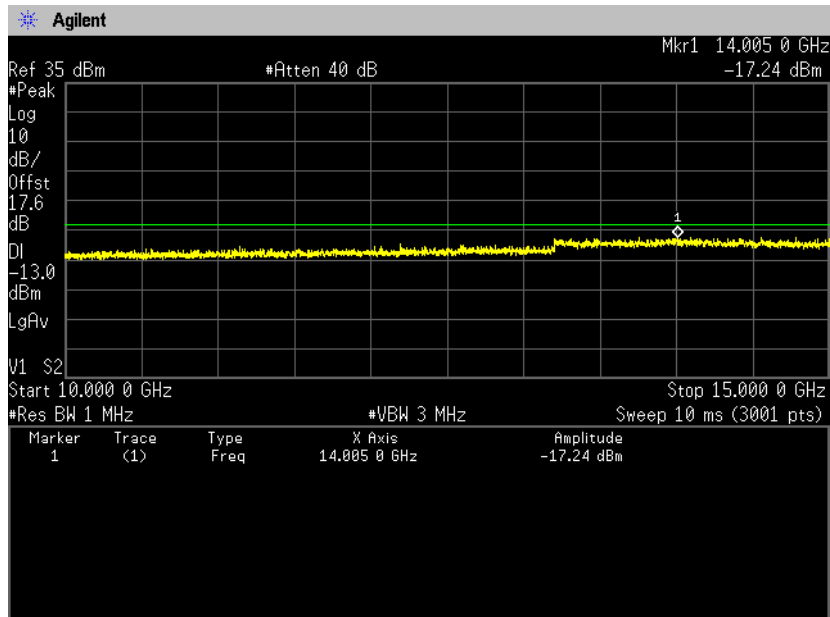

15GHz-20GHz

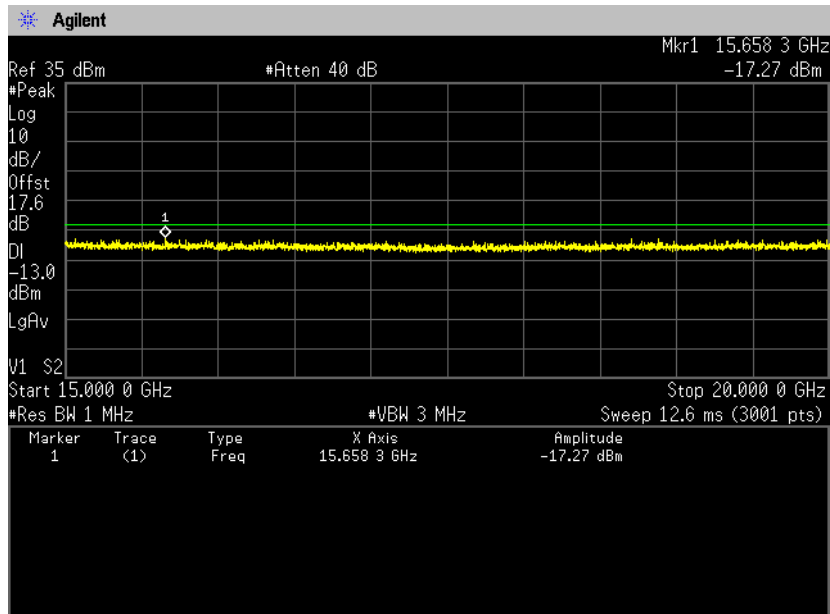



Zacta

**Channel: 20375
30MHz-5GHz**

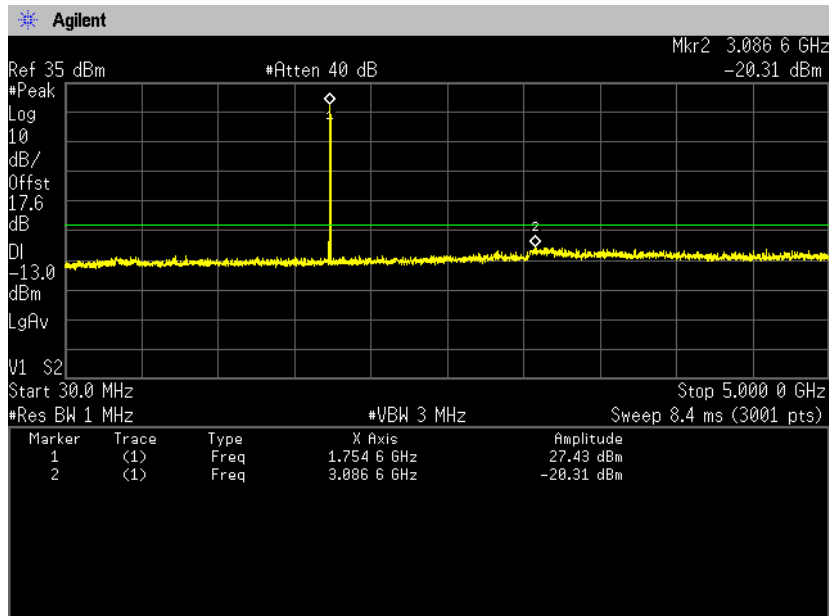

5GHz-10GHz

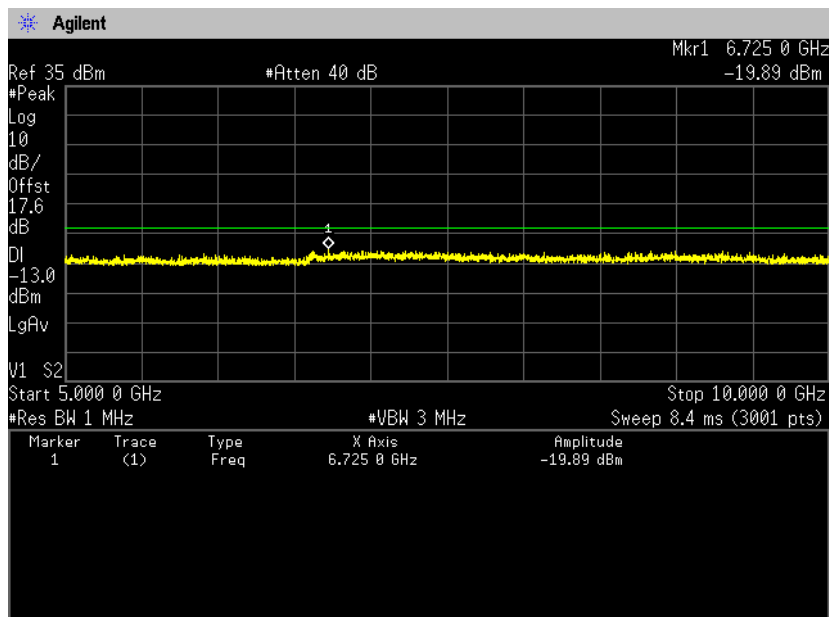



Zacta

10GHz-15GHz

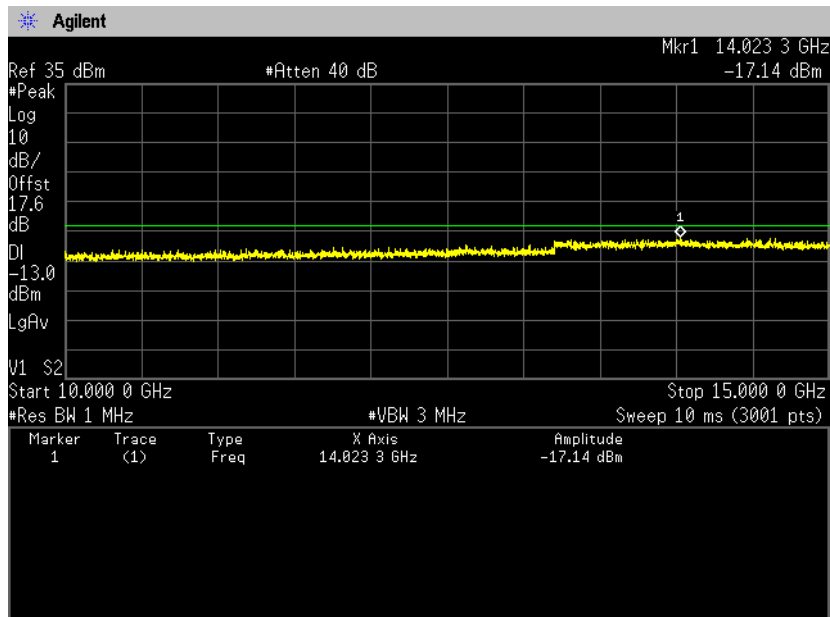

15GHz-20GHz

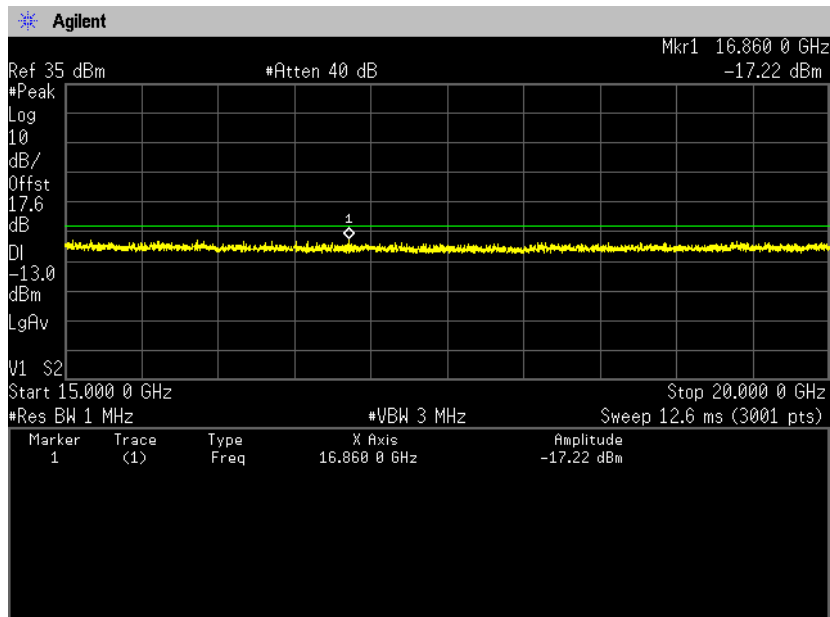

9. Radiated Emissions and Harmonic Emissions

9.1 Measurement procedure

[FCC 27.53(h), 2.1053, IC RSS-139 6.5, 6.6]

<Step 1>

The EUT and support equipment are placed on a 1 meter x 1.5 meter surface, 0.8 meter height FRP table. Radiated emission measurements are performed at 3 meter distance with the broadband antenna (Biconical antenna, Log periodic antenna and double ridged guide antenna). The antenna is positioned both the horizontal and vertical planes of polarization and height is varied 1 to 4 meters and stopped at height producing the maximum emission.

The bandwidth of the spectrum analyzer is set to 1MHz. The turntable is rotated by 360 degrees and stopped at azimuth of producing the maximum emission. The frequency is investigated up to 20GHz.

<Step 2>

The substitution antenna is replaced by the transmitter antenna (EUT).

The frequency of the signal generator is adjusted to the measurement frequency.

Level of the signal generator is adjusted to the level that is obtained from step 1, and record the emission level of signal generator.

Spectrum analyzer setting

- Detector: Peak (RBW: 1MHz, VBW: 3MHz)

- Test configuration

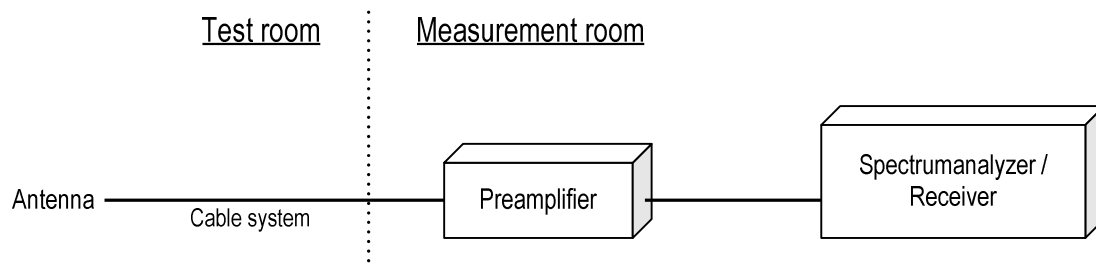

9.2 Calculation method

Result = S.G Reading – Cable loss + Antenna Gain

Margin = Limit – Result (EIRP)

Example:

Limit @ 3422.3MHz : -13.0dBm

S.G Reading = -48.7dBm Cable loss = 1.5dB Ant. Gain = 9.8dBi

Result = -48.7 – 1.5 + 9.8 = -40.4dBm

Margin = -13.0 – (-40.4) = 27.4dB

9.3 Limit

-13dBm or less



Zacta

9.4 Test data

Date	: June 25, 2015	Test engineer	:	Hikaru Shibata
Temperature	: 25.3 [°C]			
Humidity	: 59.5 [%]			
Test place	: 3m Semi-anechoic chamber			
Date	: June 29, 2015	Test engineer	:	Hikaru Shibata
Temperature	: 22.1 [°C]			
Humidity	: 61.7 [%]			
Test place	: 3m Semi-anechoic chamber			
Date	: June 30, 2015	Test engineer	:	Taiki Watanabe
Temperature	: 22.9 [°C]			
Humidity	: 59.4 [%]			
Test place	: 3m Semi-anechoic chamber			
Date	: July 2, 2015	Test engineer	:	Hikaru Shibata
Temperature	: 24.1 [°C]			
Humidity	: 59.5 [%]			
Test place	: 3m Semi-anechoic chamber			
Date	: July 4, 2015	Test engineer	:	Hikaru Shibata
Temperature	: 24.8 [°C]			
Humidity	: 63.6 [%]			
Test place	: 3m Semi-anechoic chamber			

[LTE Band IV] QPSK, BW 1.4MHz Channel: 19957

H/V	Frequency [MHz]	S.A Reading [dBm]	S.G Reading [dBm]	Cable loss [dB]	Ant.Gain [dBi]	Result [dBm]	Limit [dBm]	Margin [dB]
H	3422.3	-48.8	-48.7	1.5	9.8	-40.4	-13.0	27.4
V	3422.3	-42.8	-41.0	1.5	9.8	-32.7	-13.0	19.7
H	5133.0	-61.3	-55.9	1.9	10.7	-47.0	-13.0	34.0
V	5134.0	-57.8	-52.6	1.9	10.7	-43.8	-13.0	30.8
H	6845.0	-63.7	-53.2	2.2	11.6	-43.7	-13.0	30.7
V	6845.0	-59.8	-48.4	2.2	11.6	-38.9	-13.0	25.9

Channel: 20175

H/V	Frequency [MHz]	S.A Reading [dBm]	S.G Reading [dBm]	Cable loss [dB]	Ant.Gain [dBi]	Result [dBm]	Limit [dBm]	Margin [dB]
H	3466.0	-50.2	-49.9	1.5	9.8	-41.7	-13.0	28.7
V	3466.0	-46.8	-45.0	1.5	9.8	-36.8	-13.0	23.8
H	5199.0	-60.8	-55.6	1.9	10.8	-46.7	-13.0	33.7
V	5199.0	-58.8	-53.4	1.9	10.8	-44.5	-13.0	31.5
H	6932.0	-65.0	-51.8	2.2	11.8	-42.2	-13.0	29.2
V	6932.0	-61.9	-50.3	2.2	11.8	-40.7	-13.0	27.7

Channel: 20395

H/V	Frequency [MHz]	S.A Reading [dBm]	S.G Reading [dBm]	Cable loss [dB]	Ant.Gain [dBi]	Result [dBm]	Limit [dBm]	Margin [dB]
H	3510.0	-51.7	-51.6	1.5	9.8	-43.4	-13.0	30.4
V	3510.0	-48.9	-48.0	1.5	9.8	-39.8	-13.0	26.8
H	5264.0	-61.8	-56.5	1.9	10.8	-47.5	-13.0	34.5
V	5264.0	-59.7	-54.4	1.9	10.8	-45.5	-13.0	32.5
H	7019.0	-66.4	-53.0	2.2	11.7	-43.5	-13.0	30.5
V	7019.0	-64.0	-51.7	2.2	11.7	-42.2	-13.0	29.2

16QAM, BW 1.4MHz**Channel: 19957**

H/V	Frequency [MHz]	S.A Reading [dBm]	S.G Reading [dBm]	Cable loss [dB]	Ant.Gain [dBi]	Result [dBm]	Limit [dBm]	Margin [dB]
H	3421.4	-47.8	-47.7	1.5	9.8	-39.4	-13.0	26.4
V	3421.4	-43.8	-42.0	1.5	9.8	-33.7	-13.0	20.7
H	5132.0	-63.6	-58.2	1.9	10.7	-49.4	-13.0	36.4
V	5132.0	-58.7	-53.5	1.9	10.7	-44.7	-13.0	31.7
H	6843.0	-61.8	-51.3	2.2	11.6	-41.9	-13.0	28.9
V	6843.0	-62.7	-51.3	2.2	11.6	-41.9	-13.0	28.9

Channel: 20175

H/V	Frequency [MHz]	S.A Reading [dBm]	S.G Reading [dBm]	Cable loss [dB]	Ant.Gain [dBi]	Result [dBm]	Limit [dBm]	Margin [dB]
H	3464.8	-51.8	-51.5	1.5	9.8	-43.3	-13.0	30.3
V	3464.8	-47.8	-46.0	1.5	9.8	-37.8	-13.0	24.8
H	5197.0	-62.5	-57.3	1.9	10.8	-48.4	-13.0	35.4
V	5197.0	-61.8	-56.4	1.9	10.8	-47.5	-13.0	34.5
H	6930.0	-64.9	-51.7	2.2	11.8	-42.1	-13.0	29.1
V	6930.0	-63.7	-52.1	2.2	11.8	-42.5	-13.0	29.5

Channel: 20393

H/V	Frequency [MHz]	S.A Reading [dBm]	S.G Reading [dBm]	Cable loss [dB]	Ant.Gain [dBi]	Result [dBm]	Limit [dBm]	Margin [dB]
H	3508.2	-52.8	-52.7	1.5	9.7	-44.5	-13.0	31.5
V	3508.2	-49.9	-49.0	1.5	9.7	-40.8	-13.0	27.8
H	5262.0	-62.1	-56.8	1.9	10.8	-47.9	-13.0	34.9
V	5262.0	-59.9	-54.6	1.9	10.8	-45.7	-13.0	32.7
H	7016.0	-66.1	-52.7	2.2	11.7	-43.2	-13.0	30.2
V	7016.0	-64.2	-51.9	2.2	11.7	-42.4	-13.0	29.4

QPSK, BW 3MHz
Channel: 19965

H/V	Frequency [MHz]	S.A Reading [dBm]	S.G Reading [dBm]	Cable loss [dB]	Ant.Gain [dBi]	Result [dBm]	Limit [dBm]	Margin [dB]
H	3425.6	-49.2	-49.1	1.5	9.8	-40.8	-13.0	27.8
V	3425.6	-47.6	-45.8	1.5	9.8	-37.5	-13.0	24.5
H	5138.0	-64.2	-58.8	1.9	10.7	-50.0	-13.0	37.0
V	5138.0	-60.4	-55.2	1.9	10.7	-46.4	-13.0	33.4
H	6851.0	-63.2	-52.7	2.2	11.6	-43.3	-13.0	30.3
V	6851.0	-60.9	-49.5	2.2	11.6	-40.1	-13.0	27.1

Channel: 20175

H/V	Frequency [MHz]	S.A Reading [dBm]	S.G Reading [dBm]	Cable loss [dB]	Ant.Gain [dBi]	Result [dBm]	Limit [dBm]	Margin [dB]
H	3467.6	-55.4	-55.1	1.5	9.8	-46.9	-13.0	33.9
V	3467.7	-47.9	-46.1	1.5	9.8	-37.9	-13.0	24.9
H	5201.0	-61.9	-56.7	1.9	10.8	-47.8	-13.0	34.8
V	5201.0	-60.4	-55.0	1.9	10.8	-46.1	-13.0	33.1
V	6935.0	-65.0	-53.4	2.2	11.8	-43.8	-13.0	30.8

Channel: 20385

H/V	Frequency [MHz]	S.A Reading [dBm]	S.G Reading [dBm]	Cable loss [dB]	Ant.Gain [dBi]	Result [dBm]	Limit [dBm]	Margin [dB]
H	3509.6	-53.2	-53.1	1.5	9.7	-44.9	-13.0	31.9
V	3509.6	-50.4	-49.5	1.5	9.7	-41.3	-13.0	28.3
H	5264.0	-59.0	-53.7	1.9	10.8	-44.8	-13.0	31.8
V	5264.0	-56.0	-50.7	1.9	10.8	-41.8	-13.0	28.8
H	7019.0	-64.3	-50.9	2.2	11.7	-41.4	-13.0	28.4
V	7019.0	-65.5	-53.2	2.2	11.7	-43.7	-13.0	30.7

16QAM, BW 3MHz
Channel: 19965

H/V	Frequency [MHz]	S.A Reading [dBm]	S.G Reading [dBm]	Cable loss [dB]	Ant.Gain [dBi]	Result [dBm]	Limit [dBm]	Margin [dB]
H	3425.5	-45.6	-45.5	1.5	9.8	-37.2	-13.0	24.2
V	3425.6	-41.8	-40.0	1.5	9.8	-31.7	-13.0	18.7
H	5138.0	-60.2	-54.8	1.9	10.7	-46.0	-13.0	33.0
V	5138.0	-57.4	-52.2	1.9	10.7	-43.4	-13.0	30.4
H	6851.0	-63.3	-52.8	2.2	11.6	-43.4	-13.0	30.4
V	6851.0	-63.3	-51.9	2.2	11.6	-42.5	-13.0	29.5

Channel: 20175

H/V	Frequency [MHz]	S.A Reading [dBm]	S.G Reading [dBm]	Cable loss [dB]	Ant.Gain [dBi]	Result [dBm]	Limit [dBm]	Margin [dB]
H	3467.6	-52.9	-52.6	1.5	9.8	-44.4	-13.0	31.4
V	3467.5	-49.5	-47.7	1.5	9.8	-39.5	-13.0	26.5
H	5201.0	-59.5	-54.3	1.9	10.8	-45.4	-13.0	32.4
V	5201.0	-57.4	-52.0	1.9	10.8	-43.1	-13.0	30.1
H	6935.0	-66.2	-53.0	2.2	11.8	-43.4	-13.0	30.4
V	6935.0	-65.0	-53.4	2.2	11.8	-43.8	-13.0	30.8

Channel: 20385

H/V	Frequency [MHz]	S.A Reading [dBm]	S.G Reading [dBm]	Cable loss [dB]	Ant.Gain [dBi]	Result [dBm]	Limit [dBm]	Margin [dB]
H	3509.5	-53.1	-53.0	1.5	9.7	-44.8	-13.0	31.8
V	3509.6	-50.2	-49.3	1.5	9.7	-41.1	-13.0	28.1
H	5264.0	-58.6	-53.3	1.9	10.8	-44.4	-13.0	31.4
V	5264.0	-54.7	-49.4	1.9	10.8	-40.5	-13.0	27.5
H	7019.0	-66.9	-53.5	2.2	11.7	-44.0	-13.0	31.0
V	7019.0	-63.1	-50.8	2.2	11.7	-41.3	-13.0	28.3

QPSK, BW 5MHz**Channel: 19975**

H/V	Frequency [MHz]	S.A Reading [dBm]	S.G Reading [dBm]	Cable loss [dB]	Ant.Gain [dBi]	Result [dBm]	Limit [dBm]	Margin [dB]
H	3429.4	-39.8	-39.7	1.5	9.8	-31.4	-13.0	18.4
V	3429.4	-44.8	-43.0	1.5	9.8	-34.7	-13.0	21.7
H	5144.0	-63.3	-57.9	1.9	10.7	-49.1	-13.0	36.1
V	5144.0	-60.0	-54.8	1.9	10.7	-46.0	-13.0	33.0
H	6859.0	-64.4	-53.9	2.2	11.6	-44.4	-13.0	31.4
V	6859.0	-62.9	-51.5	2.2	11.6	-42.0	-13.0	29.0
H	13720.0	-63.5	-51.2	3.2	12.0	-42.4	-13.0	29.4
V	13720.0	-55.3	-38.1	3.2	12.0	-29.3	-13.0	16.3

Channel: 20175

H/V	Frequency [MHz]	S.A Reading [dBm]	S.G Reading [dBm]	Cable loss [dB]	Ant.Gain [dBi]	Result [dBm]	Limit [dBm]	Margin [dB]
H	3469.4	-53.4	-53.1	1.5	9.8	-44.9	-13.0	31.9
V	3469.4	-49.3	-47.5	1.5	9.8	-39.3	-13.0	26.3
H	5204.0	-64.2	-59.0	1.9	10.8	-50.1	-13.0	37.1
V	5204.0	-61.8	-56.4	1.9	10.8	-47.5	-13.0	34.5
V	13880.0	-60.4	-41.8	3.2	11.7	-33.3	-13.0	20.3

Channel: 20375

H/V	Frequency [MHz]	S.A Reading [dBm]	S.G Reading [dBm]	Cable loss [dB]	Ant.Gain [dBi]	Result [dBm]	Limit [dBm]	Margin [dB]
H	3509.4	-51.2	-51.1	1.5	9.7	-42.9	-13.0	29.9
V	3509.4	-50.0	-49.1	1.5	9.7	-40.9	-13.0	27.9
H	5264.0	-58.3	-53.0	1.9	10.8	-44.1	-13.0	31.1
V	5264.0	-56.8	-51.5	1.9	10.8	-42.6	-13.0	29.6

16QAM, BW 5MHz**Channel: 19975**

H/V	Frequency [MHz]	S.A Reading [dBm]	S.G Reading [dBm]	Cable loss [dB]	Ant.Gain [dBi]	Result [dBm]	Limit [dBm]	Margin [dB]
H	3429.4	-39.5	-39.4	1.5	9.8	-31.1	-13.0	18.1
V	3429.4	-36.1	-34.3	1.5	9.8	-26.0	-13.0	13.0
H	5144.0	-63.9	-58.5	1.9	10.7	-49.7	-13.0	36.7
V	5144.0	-63.0	-57.8	1.9	10.7	-49.0	-13.0	36.0
H	13720.0	-62.5	-50.2	3.2	12.0	-41.4	-13.0	28.4
V	13720.0	-59.7	-42.5	3.2	12.0	-33.7	-13.0	20.7

Channel: 20175

H/V	Frequency [MHz]	S.A Reading [dBm]	S.G Reading [dBm]	Cable loss [dB]	Ant.Gain [dBi]	Result [dBm]	Limit [dBm]	Margin [dB]
H	3469.4	-51.0	-50.7	1.5	9.8	-42.5	-13.0	29.5
V	3469.4	-46.0	-44.2	1.5	9.8	-36.0	-13.0	23.0
H	5204.0	-63.9	-58.7	1.9	10.8	-49.8	-13.0	36.8
V	5204.0	-59.8	-54.4	1.9	10.8	-45.5	-13.0	32.5
V	13880.0	-60.3	-41.7	3.2	11.7	-33.2	-13.0	20.2

Channel: 20375

H/V	Frequency [MHz]	S.A Reading [dBm]	S.G Reading [dBm]	Cable loss [dB]	Ant.Gain [dBi]	Result [dBm]	Limit [dBm]	Margin [dB]
H	3509.4	-52.9	-52.8	1.5	9.7	-44.6	-13.0	31.6
V	3509.4	-47.8	-46.9	1.5	9.7	-38.7	-13.0	25.7
H	5264.0	-57.1	-51.8	1.9	10.8	-42.9	-13.0	29.9
V	5264.0	-55.6	-50.3	1.9	10.8	-41.4	-13.0	28.4

QPSK, BW 10MHz
Channel: 20000

H/V	Frequency [MHz]	S.A Reading [dBm]	S.G Reading [dBm]	Cable loss [dB]	Ant.Gain [dBi]	Result [dBm]	Limit [dBm]	Margin [dB]
H	3421.2	-36.2	-34.9	1.5	9.8	-26.6	-13.0	13.6
V	3421.2	-37.9	-36.1	1.5	9.8	-27.8	-13.0	14.8
H	5132.0	-55.4	-50.0	1.9	10.7	-41.2	-13.0	28.2
V	5132.0	-56.3	-51.1	1.9	10.7	-42.3	-13.0	29.3
H	6842.0	-61.5	-51.0	2.2	11.6	-41.6	-13.0	28.6
V	6842.0	-62.0	-50.6	2.2	11.6	-41.2	-13.0	28.2
V	13690.0	-53.8	-36.4	3.2	12.0	-27.5	-13.0	14.5

Channel: 20175

H/V	Frequency [MHz]	S.A Reading [dBm]	S.G Reading [dBm]	Cable loss [dB]	Ant.Gain [dBi]	Result [dBm]	Limit [dBm]	Margin [dB]
H	3456.2	-46.6	-46.3	1.5	9.8	-38.0	-13.0	25.0
V	3456.2	-46.9	-45.1	1.5	9.8	-36.8	-13.0	23.8
H	5184.0	-61.8	-56.6	1.9	10.8	-47.7	-13.0	34.7
V	5184.0	-58.8	-53.4	1.9	10.8	-44.5	-13.0	31.5
V	13830.0	-59.9	-42.2	3.2	11.8	-33.6	-13.0	20.6

Channel: 20350

H/V	Frequency [MHz]	S.A Reading [dBm]	S.G Reading [dBm]	Cable loss [dB]	Ant.Gain [dBi]	Result [dBm]	Limit [dBm]	Margin [dB]
H	3491.2	-52.6	-52.5	1.5	9.7	-44.3	-13.0	31.3
V	3491.2	-50.1	-49.2	1.5	9.7	-41.0	-13.0	28.0
H	5237.0	-64.1	-58.8	1.9	10.9	-49.9	-13.0	36.9
V	5237.0	-61.3	-56.0	1.9	10.9	-47.1	-13.0	34.1
V	13970.0	-59.8	-42.7	3.2	11.5	-34.5	-13.0	21.5

16QAM, BW 10MHz**Channel: 20000**

H/V	Frequency [MHz]	S.A Reading [dBm]	S.G Reading [dBm]	Cable loss [dB]	Ant.Gain [dBi]	Result [dBm]	Limit [dBm]	Margin [dB]
H	3438.9	-38.5	-38.4	1.5	9.8	-30.1	-13.0	17.1
V	3438.9	-47.4	-45.6	1.5	9.8	-37.3	-13.0	24.3
H	5158.0	-62.9	-57.5	1.9	10.7	-48.7	-13.0	35.7
V	5158.0	-60.2	-55.0	1.9	10.7	-46.2	-13.0	33.2
V	13760.0	-60.0	-42.8	3.2	11.9	-34.1	-13.0	21.1

Channel: 20175

H/V	Frequency [MHz]	S.A Reading [dBm]	S.G Reading [dBm]	Cable loss [dB]	Ant.Gain [dBi]	Result [dBm]	Limit [dBm]	Margin [dB]
H	3473.9	-50.4	-50.1	1.5	9.8	-41.9	-13.0	28.9
V	3473.9	-50.6	-48.8	1.5	9.8	-40.6	-13.0	27.6
H	5211.0	-63.9	-58.7	1.9	10.8	-49.8	-13.0	36.8
V	5211.0	-62.9	-56.4	1.9	10.8	-47.5	-13.0	34.5

Channel: 20393

H/V	Frequency [MHz]	S.A Reading [dBm]	S.G Reading [dBm]	Cable loss [dB]	Ant.Gain [dBi]	Result [dBm]	Limit [dBm]	Margin [dB]
H	3509.0	-51.2	-51.1	1.5	9.7	-42.9	-13.0	29.9
V	3509.0	-50.0	-49.1	1.5	9.7	-40.9	-13.0	27.9
H	5263.0	-58.3	-53.0	1.9	10.8	-44.1	-13.0	31.1
V	5263.0	-56.8	-51.5	1.9	10.8	-42.6	-13.0	29.6

QPSK, BW 15MHz
Channel: 20025

H/V	Frequency [MHz]	S.A Reading [dBm]	S.G Reading [dBm]	Cable loss [dB]	Ant.Gain [dBi]	Result [dBm]	Limit [dBm]	Margin [dB]
H	3421.6	-39.8	-39.2	1.5	9.8	-30.9	-13.0	17.9
V	3421.6	-37.9	-36.1	1.5	9.8	-27.8	-13.0	14.8
H	5132.0	-61.9	-56.5	1.9	10.7	-47.7	-13.0	34.7
V	5133.0	-60.7	-55.5	1.9	10.7	-46.7	-13.0	33.7
H	6843.0	-62.9	-52.4	2.2	11.6	-43.0	-13.0	30.0
V	6843.0	-62.4	-51.0	2.2	11.6	-41.6	-13.0	28.6
H	13690.0	-63.1	-50.8	3.2	12.0	-41.9	-13.0	28.9
V	13690.0	-54.9	-37.5	3.2	12.0	-28.6	-13.0	15.6

Channel: 20175

H/V	Frequency [MHz]	S.A Reading [dBm]	S.G Reading [dBm]	Cable loss [dB]	Ant.Gain [dBi]	Result [dBm]	Limit [dBm]	Margin [dB]
H	3451.7	-49.1	-48.8	1.5	9.8	-40.5	-13.0	27.5
V	3451.7	-45.1	-43.6	1.5	9.8	-35.3	-13.0	22.3
H	5178.0	-62.8	-57.4	1.9	10.8	-48.5	-13.0	35.5
V	5178.0	-57.3	-52.2	1.9	10.8	-43.3	-13.0	30.3
H	6903.0	-51.9	-40.1	2.2	11.7	-30.6	-13.0	17.6
V	6903.0	-63.9	-52.6	2.2	11.7	-43.1	-13.0	30.1
V	13810.0	-60.8	-43.1	3.2	11.8	-34.5	-13.0	21.5

Channel: 20350

H/V	Frequency [MHz]	S.A Reading [dBm]	S.G Reading [dBm]	Cable loss [dB]	Ant.Gain [dBi]	Result [dBm]	Limit [dBm]	Margin [dB]
H	3481.7	-53.3	-52.8	1.5	9.7	-44.6	-13.0	31.6
V	3481.7	-51.3	-50.5	1.5	9.7	-42.3	-13.0	29.3
H	5223.0	-64.0	-58.4	1.9	10.8	-49.5	-13.0	36.5
V	5223.0	-59.4	-54.0	1.9	10.8	-45.1	-13.0	32.1
H	6963.0	-63.7	-51.6	2.2	11.8	-42.0	-13.0	29.0
V	6963.0	-65.3	-53.1	2.2	11.8	-43.5	-13.0	30.5
V	13930.0	-59.5	-41.9	3.2	11.6	-33.5	-13.0	20.5

16QAM, BW 15MHz**Channel: 20025**

H/V	Frequency [MHz]	S.A Reading [dBm]	S.G Reading [dBm]	Cable loss [dB]	Ant.Gain [dBi]	Result [dBm]	Limit [dBm]	Margin [dB]
H	3448.3	-47.3	-47.4	1.5	9.8	-39.1	-13.0	26.1
V	3448.3	-43.0	-43.6	1.5	9.8	-35.3	-13.0	22.3
H	5173.0	-61.6	-56.2	1.9	10.7	-47.4	-13.0	34.4
V	5173.0	-58.5	-53.4	1.9	10.7	-44.6	-13.0	31.6
H	6897.0	-62.6	-51.7	2.2	11.7	-42.2	-13.0	29.2
V	6897.0	-62.2	-51.2	2.2	11.7	-41.7	-13.0	28.7
V	13790.0	-60.3	-43.4	3.2	11.9	-34.7	-13.0	21.7

Channel: 20175

H/V	Frequency [MHz]	S.A Reading [dBm]	S.G Reading [dBm]	Cable loss [dB]	Ant.Gain [dBi]	Result [dBm]	Limit [dBm]	Margin [dB]
H	3478.3	-52.9	-52.5	1.5	9.8	-44.3	-13.0	31.3
V	3478.3	-51.3	-50.6	1.5	9.8	-42.4	-13.0	29.4
H	5218.0	-60.5	-55.6	1.9	10.8	-46.7	-13.0	33.7
V	5218.0	-59.9	-54.5	1.9	10.8	-45.6	-13.0	32.6
V	6957.0	-64.9	-53.6	2.2	11.8	-44.0	-13.0	31.0
V	13910.0	-60.2	-44.7	3.2	11.6	-36.3	-13.0	23.3

Channel: 20325

H/V	Frequency [MHz]	S.A Reading [dBm]	S.G Reading [dBm]	Cable loss [dB]	Ant.Gain [dBi]	Result [dBm]	Limit [dBm]	Margin [dB]
H	3508.4	-51.1	-51.0	1.5	9.7	-42.8	-13.0	29.8
V	3508.3	-51.5	-50.6	1.5	9.7	-42.4	-13.0	29.4
H	5263.0	-59.9	-54.6	1.9	10.8	-45.6	-13.0	32.6
V	5263.0	-57.0	-51.7	1.9	10.8	-42.8	-13.0	29.8
H	7017.0	-63.7	-51.2	2.2	11.7	-41.6	-13.0	28.6
V	7017.0	-64.6	-50.9	2.2	11.7	-41.4	-13.0	28.4
V	14030.0	-62.2	-45.0	3.2	11.3	-36.9	-13.0	23.9

QPSK, BW 20MHz
Channel: 20050

H/V	Frequency [MHz]	S.A Reading [dBm]	S.G Reading [dBm]	Cable loss [dB]	Ant.Gain [dBi]	Result [dBm]	Limit [dBm]	Margin [dB]
H	3422.2	-40.3	-40.2	1.5	9.8	-31.9	-13.0	18.9
V	3422.2	-38.5	-36.7	1.5	9.8	-28.4	-13.0	15.4
H	5133.0	-59.0	-53.6	1.9	10.7	-44.7	-13.0	31.7
V	5133.0	-60.0	-54.8	1.9	10.7	-46.0	-13.0	33.0
H	6844.0	-63.4	-52.9	2.2	11.6	-43.5	-13.0	30.5
V	6844.0	-61.9	-50.5	2.2	11.6	-41.1	-13.0	28.1
H	13690.0	-60.5	-48.2	3.2	12.0	-39.3	-13.0	26.3
V	13690.0	-54.5	-37.1	3.2	12.0	-28.2	-13.0	15.2

Channel: 20175

H/V	Frequency [MHz]	S.A Reading [dBm]	S.G Reading [dBm]	Cable loss [dB]	Ant.Gain [dBi]	Result [dBm]	Limit [dBm]	Margin [dB]
H	3447.1	-46.4	-46.1	1.5	9.8	-37.8	-13.0	24.8
V	3447.2	-43.4	-41.6	1.5	9.8	-33.3	-13.0	20.3
H	5171.0	-61.4	-56.2	1.9	10.7	-47.4	-13.0	34.4
V	5171.0	-58.0	-52.6	1.9	10.7	-43.8	-13.0	30.8
H	6894.0	-62.8	-49.6	2.2	11.7	-40.1	-13.0	27.1
V	6894.0	-63.3	-51.7	2.2	11.7	-42.2	-13.0	29.2
V	13790.0	-59.4	-41.7	3.2	11.9	-33.0	-13.0	20.0

Channel: 20300

H/V	Frequency [MHz]	S.A Reading [dBm]	S.G Reading [dBm]	Cable loss [dB]	Ant.Gain [dBi]	Result [dBm]	Limit [dBm]	Margin [dB]
H	3472.3	-52.9	-52.8	1.5	9.8	-44.6	-13.0	31.6
V	3472.2	-48.8	-47.9	1.5	9.8	-39.7	-13.0	26.7
H	5208.0	-60.2	-54.9	1.9	10.8	-46.0	-13.0	33.0
V	5208.0	-59.8	-54.5	1.9	10.8	-45.6	-13.0	32.6
H	6995.0	-64.2	-50.8	2.2	11.7	-41.3	-13.0	28.3
V	6994.0	-64.5	-52.2	2.2	11.7	-42.7	-13.0	29.7
H	13890.0	-60.1	-47.8	3.2	11.6	-39.4	-13.0	26.4
V	13890.0	-60.5	-46.3	3.2	11.6	-37.9	-13.0	24.9

16QAM, BW 20MHz**Channel: 20050**

H/V	Frequency [MHz]	S.A Reading [dBm]	S.G Reading [dBm]	Cable loss [dB]	Ant.Gain [dBi]	Result [dBm]	Limit [dBm]	Margin [dB]
H	3422.3	-38.4	-38.3	1.5	9.8	-30.0	-13.0	17.0
V	3442.2	-35.5	-33.7	1.5	9.8	-25.4	-13.0	12.4
H	5133.0	-62.7	-57.3	1.9	10.7	-48.4	-13.0	35.4
V	5133.0	-60.9	-55.7	1.9	10.7	-46.9	-13.0	33.9
H	6844.0	-61.8	-51.3	2.2	11.6	-41.9	-13.0	28.9
V	6844.0	-62.9	-51.5	2.2	11.6	-42.1	-13.0	29.1
H	13690.0	-60.7	-48.4	3.2	12.0	-39.5	-13.0	26.5
V	13690.0	-54.5	-37.1	3.2	12.0	-28.2	-13.0	15.2

Channel: 20175

H/V	Frequency [MHz]	S.A Reading [dBm]	S.G Reading [dBm]	Cable loss [dB]	Ant.Gain [dBi]	Result [dBm]	Limit [dBm]	Margin [dB]
H	3447.2	-48.3	-48.0	1.5	9.8	-39.7	-13.0	26.7
V	3447.2	-47.2	-45.4	1.5	9.8	-37.1	-13.0	24.1
H	5171.0	-62.5	-57.3	1.9	10.7	-48.5	-13.0	35.5
V	5171.0	-59.8	-54.4	1.9	10.7	-45.6	-13.0	32.6
H	6895.0	-63.9	-50.7	2.2	11.7	-41.2	-13.0	28.2
V	6895.0	-63.2	-51.6	2.2	11.7	-42.1	-13.0	29.1
V	13790.0	-60.3	-42.6	3.2	11.9	-33.9	-13.0	20.9

Channel: 20300

H/V	Frequency [MHz]	S.A Reading [dBm]	S.G Reading [dBm]	Cable loss [dB]	Ant.Gain [dBi]	Result [dBm]	Limit [dBm]	Margin [dB]
H	3472.2	-53.2	-53.1	1.5	9.8	-44.9	-13.0	31.9
V	3472.2	-53.2	-52.3	1.5	9.8	-44.1	-13.0	31.1
H	5208.0	-61.7	-56.4	1.9	10.8	-47.5	-13.0	34.5
V	5208.0	-59.2	-53.9	1.9	10.8	-45.0	-13.0	32.0
H	6945.0	-64.2	-50.8	2.2	11.8	-41.2	-13.0	28.2
V	6944.0	-64.8	-52.5	2.2	11.8	-42.9	-13.0	29.9
V	13890.0	-59.9	-45.7	3.2	11.6	-37.3	-13.0	24.3

10. Frequency Stability

10.1 Measurement procedure

[FCC 27.54, 2.1055, IC RSS-139 6.3]

The EUT was placed inside of a constant temperature chamber as the temperature in the chamber was varied between -30°C and $+50^{\circ}\text{C}$. The temperature was incremented by 10°C intervals and the unit was allowed to stabilize at each measurement. The frequency drift was measured with the normal Temperature and voltage tolerance and it is presented as the ppm unit.

- Test configuration

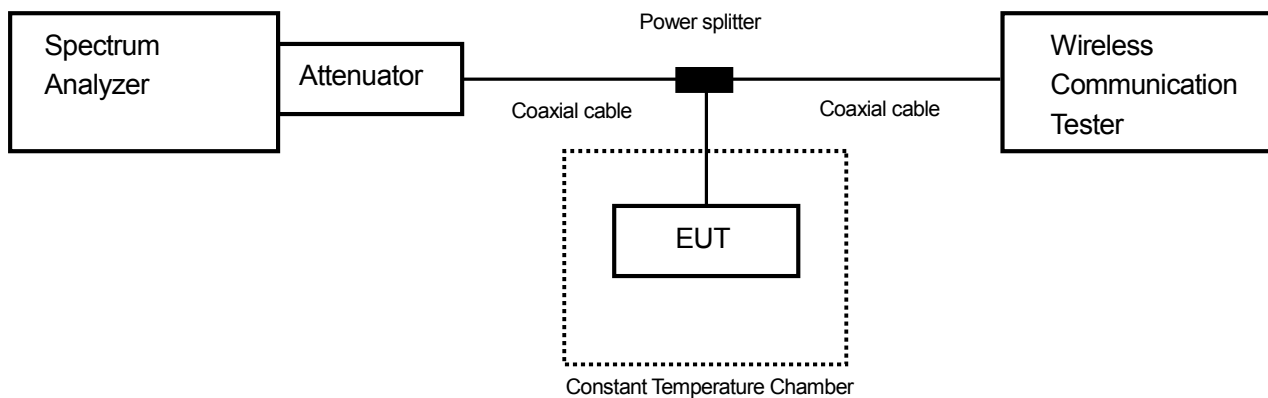

10.2 Limit

$\pm 2.5\text{ppm}$

10.3 Measurement result

Date : June 25, 2015
 Temperature : 24.7 [°C]
 Humidity : 52.3 [%]
 Test place : Shielded room No.4

Test engineer : Hikaru Shibata

[LTE Band IV] (Channel: 20175)

Limit: $\pm 0.00025\% = \pm 2.5\text{ppm}$					
Power Supply [V]	Temperature [°C]	Measurements Frequency [Hz]	Frequency Tolerance [ppm]	Limit [ppm]	Result
3.90	25(Ref.)	1,732,498,191	0.00000	± 2.5	Pass
	50	1,732,497,027	-0.67186	± 2.5	Pass
	40	1,732,496,643	-0.89351	± 2.5	Pass
	30	1,732,499,797	0.92727	± 2.5	Pass
	20	1,732,498,725	0.30823	± 2.5	Pass
	10	1,732,500,480	1.32139	± 2.5	Pass
	0	1,732,498,901	0.40981	± 2.5	Pass
	-10	1,732,500,456	1.30743	± 2.5	Pass
	-20	1,732,498,651	0.26551	± 2.5	Pass
	-30	1,732,501,931	2.15873	± 2.5	Pass
3.315	25	1,732,497,381	-0.46753	± 2.5	Pass
4.485	25	1,732,497,540	-0.37576	± 2.5	Pass

Calculation;

$$\text{Frequency Tolerance (ppm)} = \frac{\text{Measurements Frequency (Hz)} - \text{Reference Frequency (Hz)}}{\text{Reference Frequency (Hz)}} \times 1000000$$



Zacta

11. Uncertainty of measurement

Expanded uncertainties stated are calculated with a coverage Factor $k=2$.

Please note that these results are not taken into account when determining compliance or non-compliance with test result.

Test item	Measurement uncertainty
Conducted emission at mains port	$\pm 3.0\text{dB}$
Radiated emission (9kHz – 30MHz)	$\pm 4.4\text{dB}$
Radiated emission (30MHz – 1000MHz)	$\pm 4.5\text{dB}$
Radiated emission (1000MHz – 26GHz)	$\pm 3.9\text{dB}$



Zacta

12. Laboratory description

1. Location:

TÜV SÜD Zacta Ltd. Yonezawa Testing Center
 4149-7 Hachimanpara 5-chome Yonezawa-shi Yamagata 992-1128 Japan
 Phone: +81-238-28-2880 Fax: +81-238-28-2888

2. Facility filing information:

1) NVLAP accreditation: NVLAP Lab. code: 200306-0

2) VLAC accreditation: Lab. code: VLAC-013

Site name	Radiated emission	Conducted emission for mains port	Conducted emission for telecom port	Radiated emission (CMAD)	Expiry Date
3m Semi-anechoic chamber	VLAC-013	VLAC-013	VLAC-013	-	Jul. 3, 2017
10m Semi-anechoic chamber No.1				VLAC-013	
10m Semi-anechoic chamber No.2					
Shielded room No.1	-	VLAC-013		-	

3) FCC filing:

Site name	Registration Number	Expiry Date
Site 3	91065	Oct. 1, 2017
3m Semi-anechoic chamber	540072	Feb. 20, 2017
10m Semi-anechoic chamber No.1		
10m Semi-anechoic chamber No.2		
Shielded room No.1		

4) Industry Canada Oats site filing:

Site name	Sites on file: Oats 3m/10m	Expiry Date
Site 3	4224A-3	Dec. 3, 2017
3m Semi-anechoic chamber	4224A-4	
10m Semi-anechoic chamber No.1	4224A-5	
10m Semi-anechoic chamber No.2	4224A-6	Jan. 15, 2017

5) VCCI site filing:

Site name	Radiated emission	Conducted emission for mains port	Conducted emission for telecom port	Expiry Date
Site 3	R-138	C-134	T-1222	Nov. 16, 2017
3m Semi-anechoic chamber	A-0166	A-0166	A-0166	Jul. 3, 2017
10m Semi-anechoic chamber No.1				
10m Semi-anechoic chamber No.2				
Shielded room No.1	-	A-0166		

6) TÜV SÜD PS authorization:

Authorized as an EMC test laboratory

7) TÜV Rheinland authorization:

Authorized as an EMC test laboratory



Appendix A. Test equipment

Antenna port conducted test

Equipment	Company	Model No.	Serial No.	Cal. due	Cal. date
Spectrum analyzer	Agilent Technologies	E4440A	US44302655	Jun. 30, 2016	Jun. 11, 2015
Microwave cable	RS	YH20_S1	N/A (S389)	Aug. 31, 2015	Aug. 30, 2014
Attenuator	Weinschel	56-10	J4180	Nov. 30, 2015	Nov. 12, 2014
Microwave cable	SUHNER	SUCOFLEX104/1.5m	199121/4	Oct. 31, 2015	Oct. 7, 2014
Microwave cable	SUHNER	SUCOFLEX104/1.5m	322086/4	Jul. 31, 2015	Jul. 30, 2014
Power splitter	ANRITSU	K240B	020205	Jul. 31, 2015	Jul. 12, 2014
Wideband radio frequency tester	ROHDE&SCHWARZ	CMW500	116338	Apr. 30, 2016	Apr. 2, 2015
Operation type temperature controlled bath	Espec	PL1KP	14007261	Jan. 31, 2016	Jan. 9, 2015

Radiated emission

Equipment	Company	Model No.	Serial No.	Cal. Due	Cal. Date
EMI Receiver	ROHDE&SCHWARZ	ESCI	100451	Dec. 31, 2015	Dec. 25, 2014
Preamplifier	ANRITSU	MH648A	M96057	Jun. 30, 2016	Jun. 12, 2015
Biconical antenna	Schwarzbeck	VHA9103/BBA9106	2125	Jun. 30, 2016	Jun. 4, 2015
Log periodic antenna	Schwarzbeck	UHALP9108A	0560	Jun. 30, 2016	Jun. 4, 2015
Attenuator	TME	CFA-01NPJ-6	N/A (S275)	Jun. 30, 2016	Jun. 23, 2015
Attenuator	TME	CFA-01NPJ-3	N/A (S272)	Jun. 30, 2016	Jun. 23, 2015
Spectrum analyzer	Agilent Technologies	E4440A	US44302655	Jun. 30, 2016	Jun. 11, 2015
Preamplifier	TSJ	MLA-100M18-B02-40	1929118	May 31, 2016	May 1, 2015
Attenuator	AEROFLEX	26A-10	081217-08	Mar. 31, 2016	Mar. 12, 2015
Dipole antenna	Schwarzbeck	VHAP	1020	Sep. 30, 2015	Sep. 5, 2014
Dipole antenna	Schwarzbeck	UHAP	994	Sep. 30, 2015	Sep. 5, 2014
Double ridged guide antenna	EMCO	3115	5205	Feb. 29, 2016	Feb. 16, 2015
Attenuator	Agilent Technologies	8491B	MY39268633	Feb. 29, 2016	Feb. 1, 2015
Double ridged guide antenna	EMCO	3115	000058532	Oct. 31, 2015	Oct. 14, 2014
Signal generator	ROHDE&SCHWARZ	SMB100A	177525	Jun. 30, 2016	Jun. 19, 2015
Power amplifier	R&K	CGA020M602-2633R	B40240	Mar.31, 2016	Mar. 23, 2015
Microwave cable	SUHNER	SUCOFELX102/2m	31648/2	Mar. 28, 2016	Mar. 10, 2015
High pass filter	Micro-Tronics	HPM50115	004	Jul. 31, 2015	Jul. 12, 2014
High pass filter	Wainwright	WHKX2.8/18G-6SS	1	Jul. 31, 2015	Jul. 17, 2014
Wideband radio frequency tester	ROHDE&SCHWARZ	CMW500	126079	Aug. 31, 2015	Aug. 28, 2014
Microwave cable	SUHNER	SUCOFLEX104/9m	346316/4	Oct. 31, 2015	Oct. 31, 2014
		SUCOFLEX104/1m	322084/4	Oct. 31, 2015	Oct. 31, 2014
		SUCOFLEX104/1.5m	317226/4	Oct. 31, 2015	Oct. 31, 2014
		SUCOFLEX104/7m	41625/6	Oct. 31, 2015	Oct. 31, 2014
PC	DELL	DIMENSION E521	75465BX	N/A	N/A
Software	TOYO Corporation	EP5/RE-AJ	0611193/V5.3.61	N/A	N/A
3m Semi-anechoic chamber	TOKIN	N/A	N/A (9002-NSA)	Apr. 30, 2016	Apr. 27, 2015
3m Semi-anechoic chamber	TOKIN	N/A	N/A (9002-SVSWR)	Apr. 30, 2016	Apr. 27, 2015

*: The calibrations of the above equipment are traceable to NIST or equivalent standards of the reference organizations.