



Zacta

TEST REPORT

Report number : Z101C-15078

Issue date : August 24, 2015

The device, as described herewith, was tested pursuant to applicable test procedure and complies with the requirements of;

FCC Part 24 Subpart E IC RSS-133

The test results are traceable to the international or national standards.

Applicant	: KYOCERA Corporation
Equipment under test (EUT)	: Module
Model number	: J79
FCC ID	: JOYJ79
IC Certification Number	: 574B-J79

Date of test : June 17, 19, 20, 22, 23, 24, 25, July 1,2, 3, 2015
 Test place : TÜV SÜD Zacta Ltd. Yonezawa Testing Center
 4149-7 Hachimanpara 5-chome
 Yonezawa-shi Yamagata 992-1128 Japan
 Phone: +81-238-28-2880 Fax: +81-238-28-2888
 Test results : Complied

The results in this report are applicable only to the equipment tested.
 This report shall not be re-produced except in full without the written approval of TÜV SÜD Zacta Ltd.
 This test report must not be used by the client to claim product certification, approval, or endorsement by NVLAP, NIST, or any agency of the federal government.

Tested by : Taiki Watanabe
 Taiki Watanabe

Hikaru Shibata
 Hikaru Shibata

Authorized by : Hiroaki Suzuki
 Hiroaki Suzuki
 Manager of EMC Technical Department



Table of contents

	Page
1. Summary of Test	4
1.1 Purpose of test	4
1.2 Standards	4
1.3 List of applied test to the EUT	4
1.4 Modification to the EUT by laboratory	4
2. Equipment Under Test	5
2.1 General Description of equipment	5
2.2 EUT information	5
2.3 Variation of the family model(s)	6
2.4 Description of Test mode	6
3. Configuration of equipment	8
3.1 Equipment(s) used	8
3.2 Cable(s) used	8
3.3 System configuration	8
4. Conducted Output Power	9
4.1 Measurement procedure	9
4.2 Measurement result	9
5. Equivalent Isotropic Radiated Power	13
5.1 Measurement procedure	13
5.2 Calculation method	13
5.3 Limit	13
5.4 Test data	14
6. Peak to Average Ratio	17
6.1 Measurement procedure	17
6.2 Limit	17
6.3 Measurement result	17
6.4 Trace data	19
7. Occupied Bandwidth	26
7.1 Measurement procedure	26
7.2 Limit	26
7.3 Measurement result	26
7.4 Trace data	29
8. Band Edge Spurious and Harmonic at Antenna Terminals	42
8.1 Measurement procedure	42
8.2 Limit	42
8.3 Measurement result	42
8.4 Trace data	44
9. Radiated Emissions and Harmonic Emissions	85
9.1 Measurement procedure	85
9.2 Calculation method	85
9.3 Limit	85
9.4 Test data	86
10. Frequency Stability	99



Zacta

10.1 Measurement procedure	99
10.2 Limit	99
10.3 Measurement result	100
11. Uncertainty of measurement	102
12. Laboratory description	103
Appendix A. Test equipment	104



Zacta

1. Summary of Test

1.1 Purpose of test

It is the original test in order to verify conformance to FCC Part 24 Subpart E, IC RSS-133.

1.2 Standards

CFR47 FCC Part 24 Subpart E
IC RSS-133

1.2.1 Test Methods

KDB 971168 D01 Power Meas License Digital Systems v02r02
ANSI/TIA/EIA-603-D-2010

1.2.2 Deviation from standards

None

1.3 List of applied test to the EUT

FCC Section	IC Section	Test items	Condition	Result
2.1046	N/A	Conducted Output Power	Conducted	PASS
24.232(c)	RSS-133 6.4	Equivalent Isotropic Radiated Power	Radiated	PASS
24.232(d)	N/A	Peak to Average Ratio	Conducted	PASS
24.238(a) 2.1049	N/A	Occupied Bandwidth	Conducted	PASS
24.238(a) 2.1051	RSS-133 6.5.1	Band Edge Spurious and Harmonic at Antenna Terminal	Conducted	PASS
24.238(a) 2.1053	RSS-133 6.5.1	Radiated emissions and Harmonic Emissions	Radiated	PASS
24.235 2.1055	RSS-133 6.3	Frequency Stability	Conducted	PASS

1.3.1 Test set up

Table-Top

1.4 Modification to the EUT by laboratory

None



Zacta

2. Equipment Under Test

2.1 General Description of equipment

EUT is the Module.

2.2 EUT information

Applicant	:	KYOCERA Corporation Yokohama Office 2-1-1 Kagahara, Tsuzuki-ku Yokohama-shi, Kanagawa, Japan Phone: +81-45-943-6253 Fax: +81-45-943-6314
Equipment under test	:	Module
Trade name	:	Kyocera
Model number	:	J79
Serial number	:	N/A
EUT condition	:	Pre-Production
Power ratings	:	DC 3.9V
Size	:	(W) 40.0 × (D) 40.0 × (H) 4.3 mm
Environment	:	Indoor and Outdoor use
Terminal limitation	:	-20°C to 60°C
RF Specification Frequency of Operation	:	Up Link WCDMA Band II: 1852.4-1907.6MHz LTE Band II: 1850-1910MHz
		Down Link WCDMA Band II: 1932.4-1987.6MHz LTE Band II: 1930-1990MHz
Modulation type	:	WCDMA Band II: QPSK, 16QAM LTE Band II: QPSK, 16QAM
Emission designator	:	WCDMA Band II: 4M16F9W LTE Band II: QPSK: 17M95G7D, 16QAM: 17M97W7D
Conducted Output power	:	WCDMA Band II: 0.258W (24.12dBm) LTE Band II: QPSK: 0.205W (23.11dBm), 16QAM: 0.163W (22.13dBm)
Antenna type	:	External antenna
Antenna gain	:	WCDMA Band II: 4.9dBi LTE Band II: 4.9dBi

2.3 Variation of the family model(s)

Not applicable

2.4 Description of Test mode

The EUT had been tested under operating condition.
There are three channels have been tested as following:

Band	Channel	Frequency
WCDMA Band II	9262	1852.4MHz
	9400	1880.0MHz
	9538	1907.6MHz

The field strength of spurious emissions was measured at each position of all three axis X, Y and Z to compare the level, and the maximum noise.
The worst emission was found in Y axis and the worst case recorded.

Band	Modulation	Bandwidth	Channel	Frequency [MHz]
LTE Band II	QPSK	1.4MHz	18607	1850.7
			18900	1880.0
			19193	1909.3
		3MHz	18615	1851.5
			18900	1880.0
			19185	1908.5
	5MHz	18625	1852.5	
		18900	1880.0	
	10MHz	18650	1855.0	
		18900	1880.0	
	15MHz	19150	1905.0	
		18675	1857.5	
	20MHz	18900	1880.0	
		19125	1902.5	
16QAM	1.4MHz	18700	1860.0	
		18900	1880.0	
		19100	1900.0	
	3MHz	18607	1850.7	
		18900	1880.0	
		19193	1909.3	
5MHz	18615	1851.5		
	18900	1880.0		
	19185	1908.5		
10MHz	18625	1852.5		
	18900	1880.0		
15MHz	19175	1907.5		
	18650	1855.0		
20MHz	18900	1880.0		
	19150	1905.0		
15MHz	18675	1857.5		
	18900	1880.0		
20MHz	19125	1902.5		
	18700	1860.0		
			18900	1880.0
			19100	1900.0

The field strength of spurious emissions was measured at each position of all three axis X, Y and Z to compare the level, and the maximum noise.

The worst emission was found in Y axis and the worst case recorded.

3. Configuration of equipment

3.1 Equipment(s) used

No.	Equipment	Company	Model No.	Serial No.	FCC ID / DoC	Comment
1	Module	KYOCERA	J79	N/A	JOYJ79	EUT
2	JOINT BOARD	KYOCERA	N/A	N/A	N/A	-
3	SHARK Antenna	YOKOWO	N/A	N/A	N/A	-
4	Whip Antenna	EAD	PTR7210	N/A	N/A	-
5	GPS Antenna	PASTERNAK	PE51066	N/A	N/A	-

3.2 Cable(s) used

No.	Cable	Length[m]	Shield	Connector	Comment
a	RF cable (MAIN)	0.3	YES	Metal	-
b	RF cable (SUB)	0.3	YES	Metal	-
c	GPS Antenna cable	5.0	YES	Metal	-
d	DC cable	1.3	NO	Plastic	-
e	RF cable	0.9	YES	Metal	-

3.3 System configuration

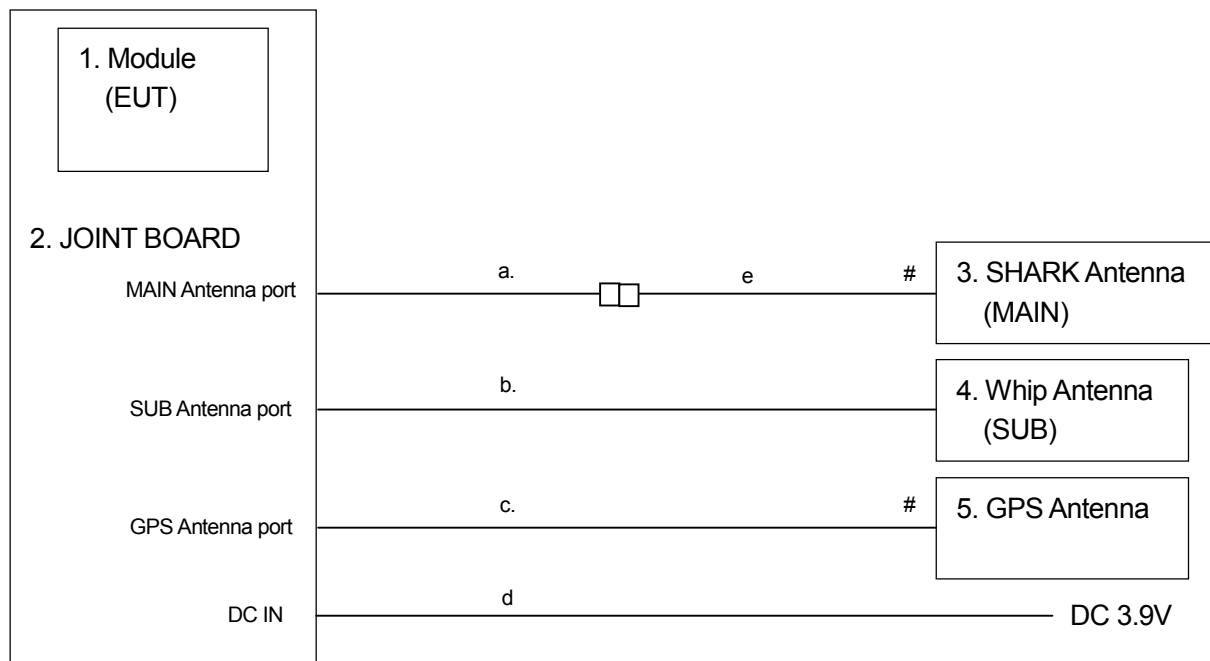

: Un-detachable cable

□ : Connector

Note1: Numbers assigned to equipment or cables on this diagram correspond to the list in "3.1 Equipment(s) used" and "3.2 Cable(s) used".

4. Conducted Output Power

4.1 Measurement procedure [FCC 2.1046]

The conducted output power was measured with a wireless communication tester connected to the antenna terminal. The wireless communication tester parameters were set to produce the maximum power from the EUT.

- Test configuration

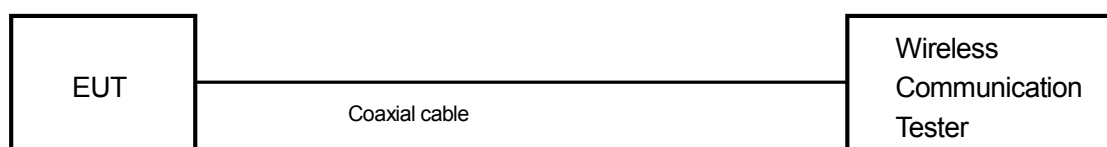

4.2 Measurement result

Date : June 17, 2015
 Temperature : 22.5 [°C]
 Humidity : 51.2 [%]
 Test place : Shielded room No.4

Test engineer : Hikaru Shibata

3GPP Release Version	Mode		Sub-Test	Cellular Band [dBm]			MPR	Bc	βd	Bc/βd
	Channel			9262	9400	9538				
	Frequency [MHz]			1852.4	1880.0	1907.6				
99	W-CDMA	RMC	-	<u>24.12</u>	23.84	23.68	-	-	-	-
		AMR	-	-	-	-	-	-	-	-
5	HSDPA	1	1	22.76	22.40	22.33	0	2/15	15/15	2/15
5		2	22.74	22.38	22.16	0	12/15	15/15	12/15	
5		3	22.69	22.31	22.38	0.5	15/15	8/15	15/8	
5		4	22.72	22.40	22.31	0.5	15/15	4/15	15/4	
6	HSUPA	1	1	23.02	22.77	22.74	0	11/15	15/15	11/15
6		2	21.87	21.49	21.50	2	6/15	15/15	6/15	
6		3	21.65	21.34	21.47	1	15/15	9/15	15/9	
6		4	22.18	22.37	22.38	2	2/15	15/15	2/15	
6		5	22.77	22.81	22.85	0	15/15	15/15	15/15	

Band	BW [MHz]	Mode	RB Allocation	RB offset	Target MPR	Avg Power[dBm]		
						18607	18900	19193
						1850.7 MHz	1880.0 MHz	1909.3 MHz
LTE Band II	1.4	QPSK	1	0	0	22.91	22.59	22.50
			1	3	0	22.93	22.63	22.42
			1	5	0	22.99	22.59	22.41
			3	0	0	22.96	22.62	22.45
			3	1	0	22.92	22.64	22.44
			3	3	0	22.96	22.64	22.39
			6	0	1	22.08	21.68	21.51
		16QAM	1	0	1	21.93	21.49	21.25
			1	3	1	22.01	21.51	21.23
			1	5	1	22.08	21.54	21.13
			3	0	1	21.92	21.67	21.60
			3	1	1	21.97	21.69	21.51
			3	3	1	22.01	21.58	21.56
			6	0	2	21.07	20.75	20.59

Band	BW [MHz]	Mode	RB Allocation	RB offset	Target MPR	Avg Power[dBm]		
						18615	18900	19185
						1851.5 MHz	1880.0 MHz	1908.5 MHz
LTE Band II	3	QPSK	1	0	0	22.88	22.58	22.53
			1	8	0	23.08	22.57	22.47
			1	14	0	23.09	22.54	22.38
			8	0	1	22.04	21.64	21.59
			8	4	1	22.14	21.67	21.53
			8	7	1	22.16	21.67	21.54
			15	0	1	22.15	21.66	21.56
		16QAM	1	0	1	21.87	21.48	21.33
			1	8	1	22.07	21.52	21.23
			1	14	1	22.10	21.50	21.16
			8	0	2	20.98	20.79	20.70
			8	4	2	21.09	20.73	20.63
			8	7	2	21.19	20.75	20.59
			15	0	2	21.15	20.77	20.68

Band	BW [MHz]	Mode	RB Allocation	RB offset	Target MPR	Avg Power[dBm]		
						18625	18900	19175
						1852.5 MHz	1880.0 MHz	1907.5 MHz
LTE Band II	5	QPSK	1	0	0	22.93	22.40	22.63
			1	12	0	23.04	22.58	22.56
			1	24	0	23.06	22.43	22.43
			12	0	1	22.07	21.69	21.60
			12	7	1	22.11	21.69	21.56
			12	13	1	22.22	21.61	21.58
			25	0	1	22.16	21.60	21.60
		16QAM	1	0	1	21.90	21.15	21.52
			1	12	1	22.10	21.36	21.51
			1	24	1	22.10	21.25	21.36
			12	0	2	21.08	20.70	20.71
			12	7	2	21.22	20.70	20.68
			12	13	2	21.33	20.75	20.64
			25	0	2	21.26	20.72	20.62

Band	BW [MHz]	Mode	RB Allocation	RB offset	Target MPR	Avg Power[dBm]		
						18650	18900	19150
						1855.0 MHz	1880.0 MHz	1905.0 MHz
LTE Band II	10	QPSK	1	0	0	22.93	22.68	22.38
			1	25	0	23.11	22.63	22.51
			1	49	0	23.00	22.52	22.36
			25	0	1	22.14	21.63	21.44
			25	12	1	22.11	21.57	21.53
			25	25	1	22.00	21.46	21.57
			50	0	1	21.94	21.50	21.45
		16QAM	1	0	1	22.02	21.56	21.11
			1	25	1	22.13	21.50	21.33
			1	49	1	21.96	21.43	21.18
			25	0	2	21.13	20.75	20.55
			25	12	2	21.12	20.69	20.65
			25	25	2	21.10	20.59	20.58
			50	0	2	20.97	20.60	20.55

Band	BW [MHz]	Mode	RB Allocation	RB offset	Target MPR	Avg Power[dBm]		
						18675	18900	19125
						1857.5 MHz	1880.0 MHz	1902.5 MHz
LTE Band II	15	QPSK	1	0	0	22.97	22.65	22.46
			1	37	0	22.99	22.59	22.38
			1	74	0	22.97	22.48	22.40
			36	0	1	22.05	21.56	21.39
			36	20	1	21.93	21.56	21.38
			36	39	1	21.87	21.48	21.43
			75	0	1	21.84	21.46	21.37
		16QAM	1	0	1	22.02	21.59	21.27
			1	37	1	22.00	21.43	21.27
			1	74	1	21.97	21.40	21.26
			36	0	2	21.09	20.76	20.48
			36	20	2	21.03	20.65	20.48
			36	39	2	21.01	20.56	20.52
			75	0	2	20.92	20.55	20.46

Band	BW [MHz]	Mode	RB Allocation	RB offset	Target MPR	Avg Power[dBm]		
						18700	18900	1910
						1860.0 MHz	1880.0 MHz	1900.0 MHz
LTE Band II	20	QPSK	1	0	0	23.02	22.84	22.45
			1	49	0	22.96	22.61	22.39
			1	99	0	22.87	22.52	22.48
			50	0	1	21.88	21.46	21.32
			50	24	1	21.82	21.44	21.25
			50	50	1	21.82	21.45	21.36
			100	0	1	21.91	21.49	21.40
		16QAM	1	0	1	21.91	21.76	21.38
			1	49	1	21.84	21.58	21.42
			1	99	1	21.72	21.48	21.43
			50	0	2	20.96	20.64	20.49
			50	24	2	20.91	20.62	20.39
			50	50	2	20.91	20.56	20.44
			100	0	2	20.89	20.62	20.47

5. Equivalent Isotropic Radiated Power

5.1 Measurement procedure

[FCC 24.232(c), IC RSS-133 6.4]

<Step 1>

The EUT and support equipment are placed on a 1 meter x 1.5 meter surface, 0.8 meter height FRP table. Radiated emission measurements are performed at 3 meter distance with the broadband antenna (double ridged guide antenna). The antenna is positioned both the horizontal and vertical planes of polarization and height is varied 1 to 4 meters and stopped at height producing the maximum emission. The bandwidth of the spectrum analyzer is set to 1MHz. The turntable is rotated by 360 degrees and stopped at azimuth of producing the maximum emission.

<Step 2>

The substitution antenna is replaced by the transmitter antenna (EUT). The frequency of the signal generator is adjusted to the measurement frequency. Level of the signal generator is adjusted to the level that is obtained from step 1, and record the emission level of signal generator.

Spectrum analyzer setting

- Detector: Peak (RBW: 5MHz, VBW: 8MHz)
- Test configuration

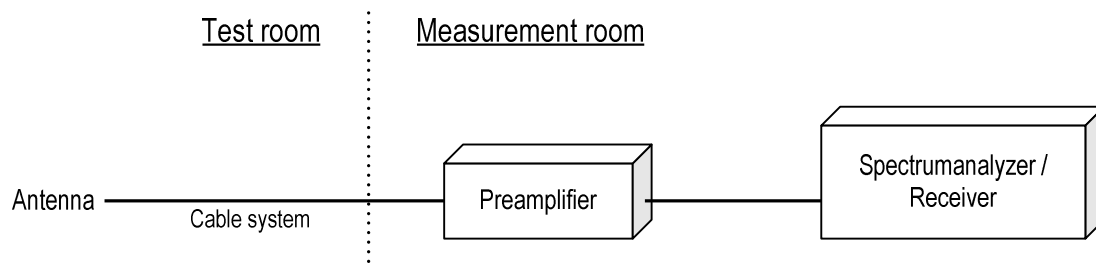

5.2 Calculation method

Result (EIRP) = S.G Reading – Cable loss + Antenna Gain

Margin = Limit – Result (EIRP)

Example:

Limit @ 1880MHz : 33.0dBm

S.G Reading = 18.9dBm Cable loss = 1.1dB Ant. Gain = 8.3dBi

Result = 18.9 – 1.1 + 8.3 = 26.1dBm

Margin = 33.0 - 26.1 = 6.9dB

5.3 Limit

2 W (33dBm)



Zacta

5.4 Test data

Date : June 22, 2015
 Temperature : 24.8 [°C]
 Humidity : 53.2 [%]
 Test place : 3m Semi-anechoic chamber
 Test engineer : Taiki Watanabe

Date : June 23, 2015
 Temperature : 24.4 [°C]
 Humidity : 62.1 [%]
 Test place : 3m Semi-anechoic chamber
 Test engineer : Taiki Watanabe

Date : June 30, 2015
 Temperature : 24.2 [°C]
 Humidity : 59.4 [%]
 Test place : 3m Semi-anechoic chamber
 Test engineer : Hikaru Shibata

Date : July 2, 2015
 Temperature : 24.1 [°C]
 Humidity : 59.5 [%]
 Test place : 3m Semi-anechoic chamber
 Test engineer : Hikaru Shibata

Date : July 3, 2015
 Temperature : 24.8 [°C]
 Humidity : 63.6 [%]
 Test place : 3m Semi-anechoic chamber
 Test engineer : Hikaru Shibata

[WCDMA Band II]

H/V	Frequency [MHz]	S.A Reading [dBm]	S.G Reading [dBm]	Cable loss [dB]	Ant.Gain [dBi]	Result [dBm]	Limit [dBm]	Margin [dB]
H	1852.4	-14.7	19.0	1.1	8.2	26.0	33.0	7.0
H	1880.0	-14.8	18.9	1.1	8.3	26.1	33.0	6.9
H	1907.6	-16.1	18.4	1.1	8.4	25.7	33.0	7.3

[LTE Band II] QPSK, BW 1.4MHz

H/V	Frequency [MHz]	S.A Reading [dBm]	S.G Reading [dBm]	Cable loss [dB]	Ant.Gain [dBi]	Result [dBm]	Limit [dBm]	Margin [dB]
H	1850.7	-9.7	23.7	1.1	8.2	30.7	33.0	2.3
H	1880.0	-8.7	25.0	1.1	8.3	32.1	33.0	0.9
H	1909.3	-9.6	25.3	1.1	8.4	32.6	33.0	0.4

16QAM, BW 1.4MHz

H/V	Frequency [MHz]	S.A Reading [dBm]	S.G Reading [dBm]	Cable loss [dB]	Ant.Gain [dBi]	Result [dBm]	Limit [dBm]	Margin [dB]
H	1850.7	-9.1	24.3	1.1	8.2	31.3	33.0	1.7
H	1880.0	-9.4	24.3	1.1	8.3	31.4	33.0	1.6
H	1909.3	-9.8	25.1	1.1	8.4	32.4	33.0	0.6

QPSK, BW 3MHz

H/V	Frequency [MHz]	S.A Reading [dBm]	S.G Reading [dBm]	Cable loss [dB]	Ant.Gain [dBi]	Result [dBm]	Limit [dBm]	Margin [dB]
H	1851.5	-9.7	23.7	1.1	8.2	30.7	33.0	2.3
H	1880.0	-9.5	24.2	1.1	8.3	31.3	33.0	1.7
H	1908.5	-9.9	25.0	1.1	8.4	32.3	33.0	0.7

16QAM, BW 3MHz

H/V	Frequency [MHz]	S.A Reading [dBm]	S.G Reading [dBm]	Cable loss [dB]	Ant.Gain [dBi]	Result [dBm]	Limit [dBm]	Margin [dB]
H	1851.5	-10.1	23.3	1.1	8.2	30.3	33.0	2.7
H	1880.0	-9.0	24.7	1.1	8.3	31.8	33.0	1.2
H	1908.5	-9.8	25.1	1.1	8.4	32.4	33.0	0.6

QPSK, BW 5MHz

H/V	Frequency [MHz]	S.A Reading [dBm]	S.G Reading [dBm]	Cable loss [dB]	Ant.Gain [dBi]	Result [dBm]	Limit [dBm]	Margin [dB]
H	1852.5	-10.3	23.4	1.1	8.2	30.4	33.0	2.6
H	1880.0	-9.7	24.0	1.1	8.3	31.1	33.0	1.9
H	1907.5	-11.8	22.7	1.1	8.4	30.0	33.0	3.0

16QAM, BW 5MHz

H/V	Frequency [MHz]	S.A Reading [dBm]	S.G Reading [dBm]	Cable loss [dB]	Ant.Gain [dBi]	Result [dBm]	Limit [dBm]	Margin [dB]
H	1852.5	-10.4	23.0	1.1	8.2	30.1	33.0	2.9
H	1880.0	-9.9	23.8	1.1	8.3	30.9	33.0	2.1
H	1907.5	-11.0	23.9	1.1	8.4	31.2	33.0	1.8

QPSK, BW 10MHz

H/V	Frequency [MHz]	S.A Reading [dBm]	S.G Reading [dBm]	Cable loss [dB]	Ant.Gain [dBi]	Result [dBm]	Limit [dBm]	Margin [dB]
H	1855.0	-10.5	23.2	1.1	8.2	30.2	33.0	2.8
H	1880.0	-9.4	24.3	1.1	8.3	31.4	33.0	1.6
H	1905.0	-10.3	24.2	1.1	8.4	31.4	33.0	1.6

16QAM, BW 10MHz

H/V	Frequency [MHz]	S.A Reading [dBm]	S.G Reading [dBm]	Cable loss [dB]	Ant.Gain [dBi]	Result [dBm]	Limit [dBm]	Margin [dB]
H	1855.0	-10.5	23.2	1.1	8.2	30.2	33.0	2.8
H	1880.0	-10.5	23.2	1.1	8.3	30.3	33.0	2.7
H	1905.0	-10.4	24.1	1.1	8.4	31.3	33.0	1.7

QPSK, BW 15MHz

H/V	Frequency [MHz]	S.A Reading [dBm]	S.G Reading [dBm]	Cable loss [dB]	Ant.Gain [dBi]	Result [dBm]	Limit [dBm]	Margin [dB]
H	1857.5	-10.1	23.6	1.1	8.2	30.6	33.0	2.4
H	1880.0	-9.6	24.1	1.1	8.3	31.2	33.0	1.8
H	1902.5	-10.7	23.8	1.1	8.4	31.0	33.0	2.0

16QAM, BW 15MHz

H/V	Frequency [MHz]	S.A Reading [dBm]	S.G Reading [dBm]	Cable loss [dB]	Ant.Gain [dBi]	Result [dBm]	Limit [dBm]	Margin [dB]
H	1857.5	-10.6	22.8	1.1	8.2	29.9	33.0	3.1
H	1880.0	-9.2	24.5	1.1	8.3	31.6	33.0	1.4
H	1902.5	-10.4	24.5	1.1	8.4	31.7	33.0	1.3

QPSK, BW 20MHz

H/V	Frequency [MHz]	S.A Reading [dBm]	S.G Reading [dBm]	Cable loss [dB]	Ant.Gain [dBi]	Result [dBm]	Limit [dBm]	Margin [dB]
H	1860.0	-10.7	24.1	1.1	8.2	31.2	33.0	1.8
H	1880.0	-9.4	24.4	1.1	8.3	31.5	33.0	1.5
H	1900.0	-10.1	23.4	1.1	8.3	30.6	33.0	2.4

16QAM, BW 20MHz

H/V	Frequency [MHz]	S.A Reading [dBm]	S.G Reading [dBm]	Cable loss [dB]	Ant.Gain [dBi]	Result [dBm]	Limit [dBm]	Margin [dB]
H	1860.0	-10.5	24.1	1.1	8.2	31.2	33.0	1.8
H	1880.0	-9.3	24.4	1.1	8.3	31.5	33.0	1.5
H	1900.0	-10.3	23.4	1.1	8.3	30.6	33.0	2.4

6. Peak to Average Ratio

6.1 Measurement procedure [FCC 24.232(d)]

The peak to average ratio was measured with a spectrum analyzer connected to the antenna terminal.

The spectrum analyzer is set to;

- RBW=1MHz, VBW=3MHz, Span=5MHz, Sweep=auto, Detector=Peak/average, Trace mode=Max hold
- Power Start CCDF

- Test configuration

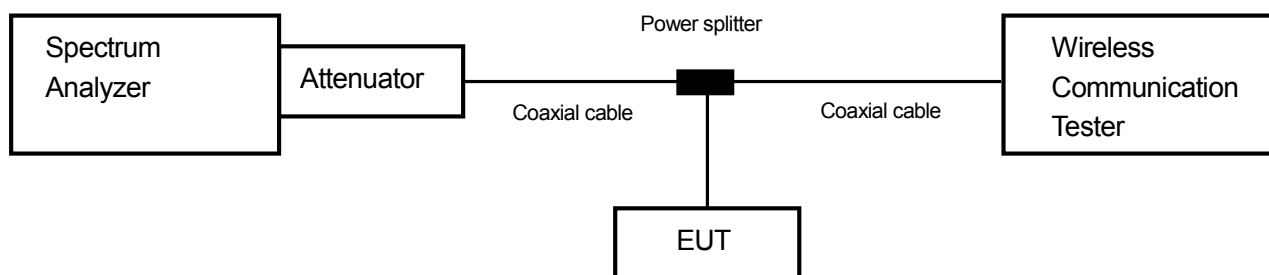

6.2 Limit

13dB or less

6.3 Measurement result

Date : June 19, 2015
 Temperature : 24.9 [°C]
 Humidity : 49.1 [%]
 Test place : Shielded room No.4

Test engineer : Hikaru Shibata



Zacta

Mode	Channel	Frequency [MHz]	Peak to Average Power Ratio [dB]	Limit [dB]
WCDMA Band II	9262	1852.4	2.89	13.0
	9400	1880.0	3.09	
	9538	1907.6	3.08	

Band	Channel	Frequency [MHz]	Modulation	BW [MHz]	RB	Peak to Average Power Ratio [dB]	Limit [dB]
LTE Band II	18900	1880.0	QPSK	1.4	6-0	5.35	13
				3	15-0	5.33	13
				5	25-0	5.33	13
				10	50-0	4.53	13
				15	75-0	5.78	13
				20	100-0	6.57	13
			16QAM	1.4	6-0	6.33	13
				3	15-0	6.3	13
				5	25-0	6.11	13
				10	50-0	6.06	13
				15	75-0	6.82	13
				20	100-0	7.17	13



Zacta

6.4 Trace data
[WCDMA Band II]
Channel: 9262

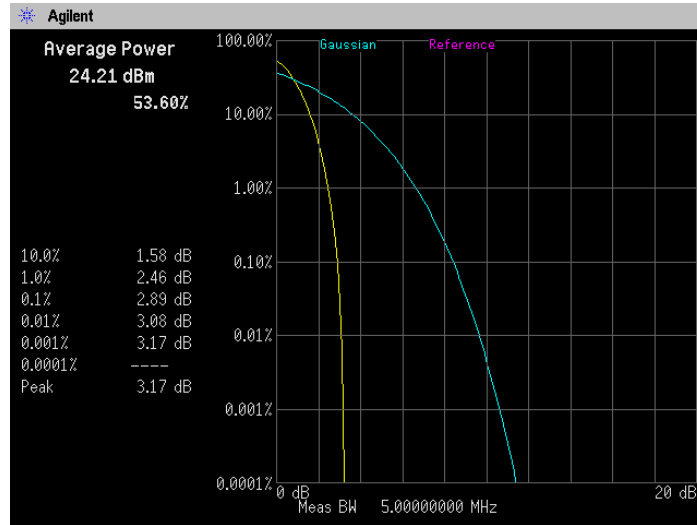

Channel: 9400

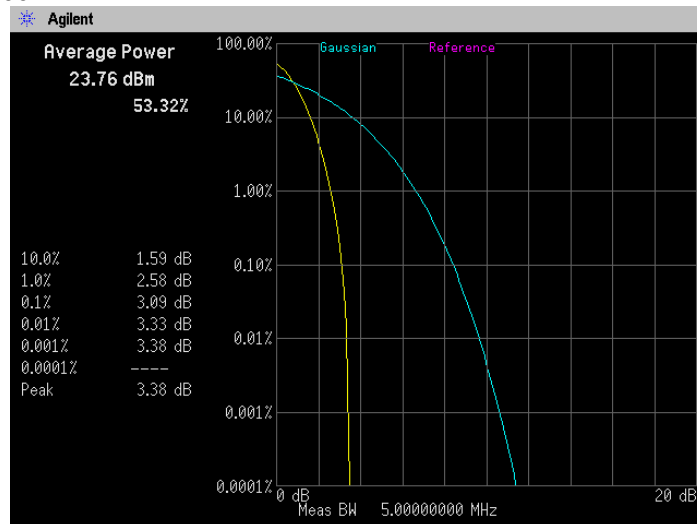

Channel: 9538

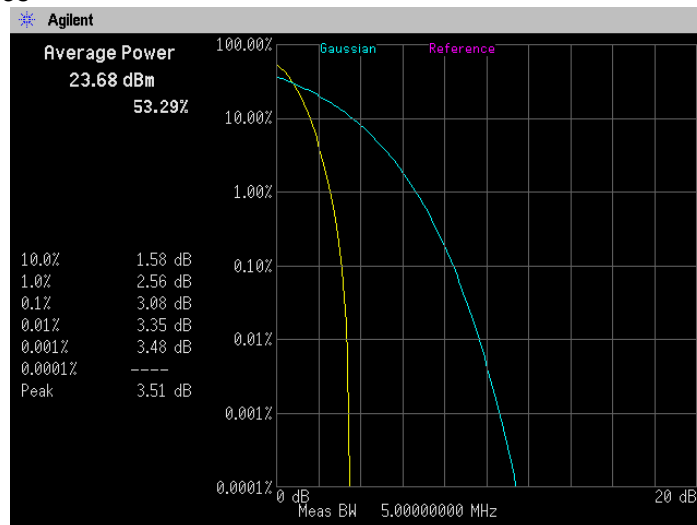



Zacta

[LTE Band II]
Channel: 18900
QPSK, BW 1.4MHz, RB6-0

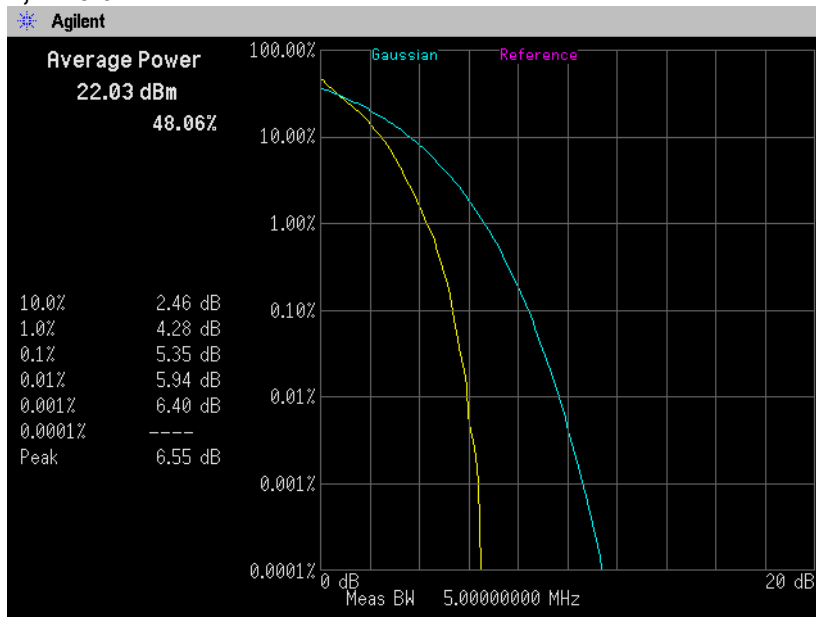

QPSK, BW 3MHz, RB15-0

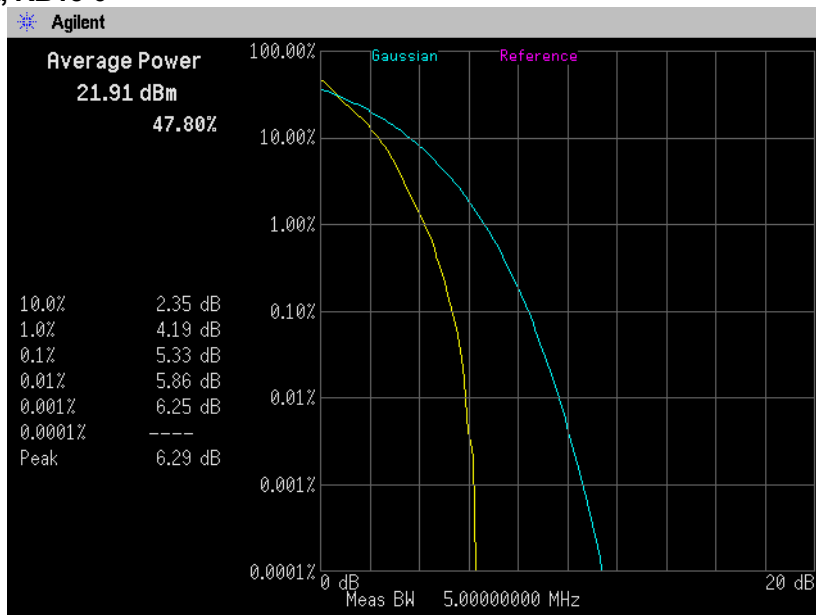



Zacta

QPSK, BW 5MHz, RB25-0

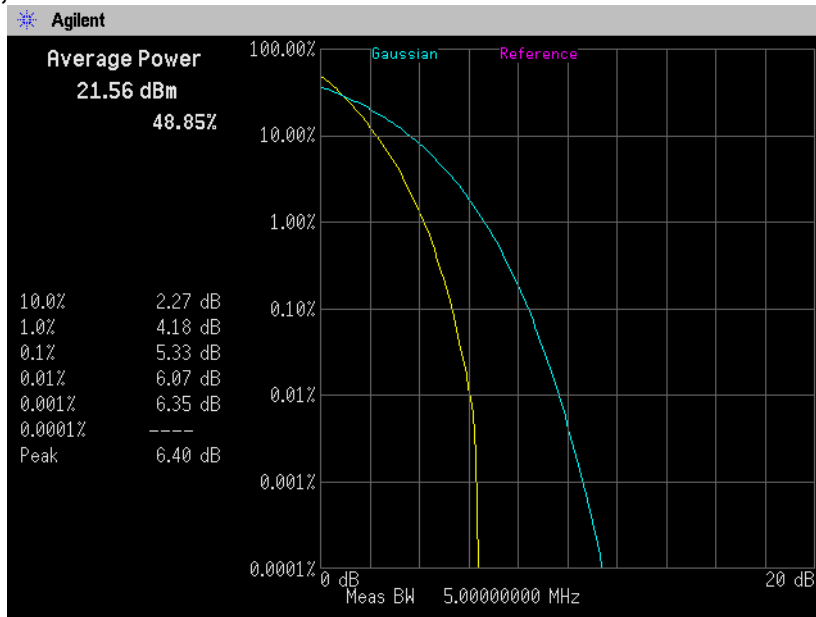

QPSK, BW 10MHz, RB50-0

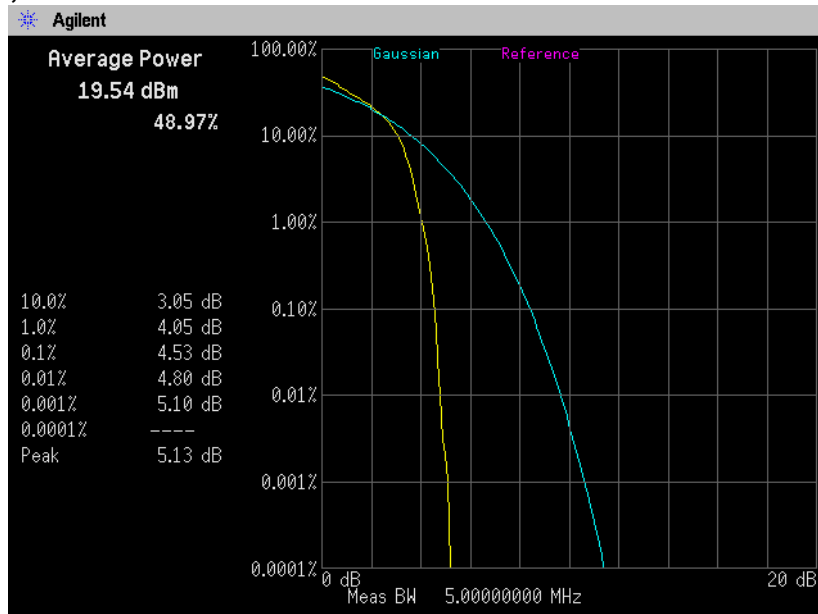



Zacta

QPSK, BW 15MHz, RB75-0

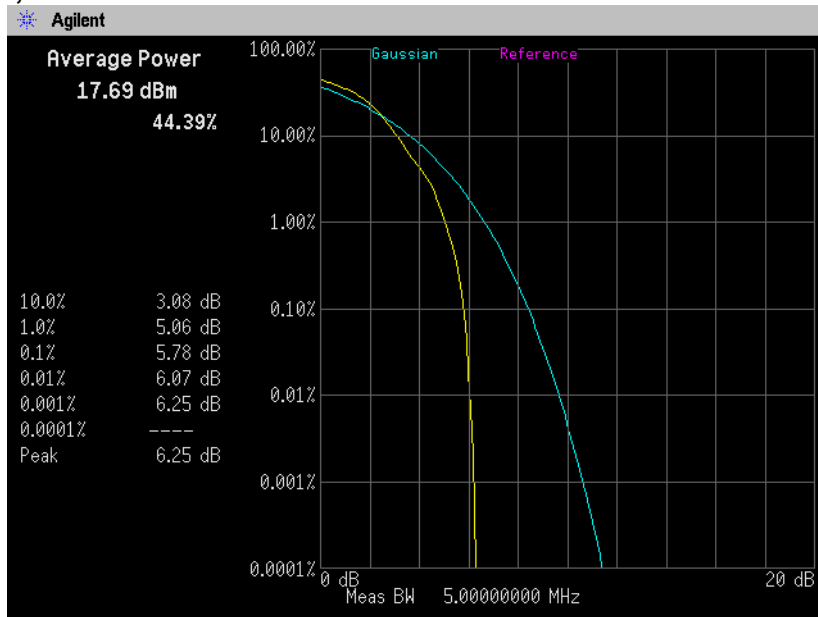

QPSK, BW 20MHz, RB100-0

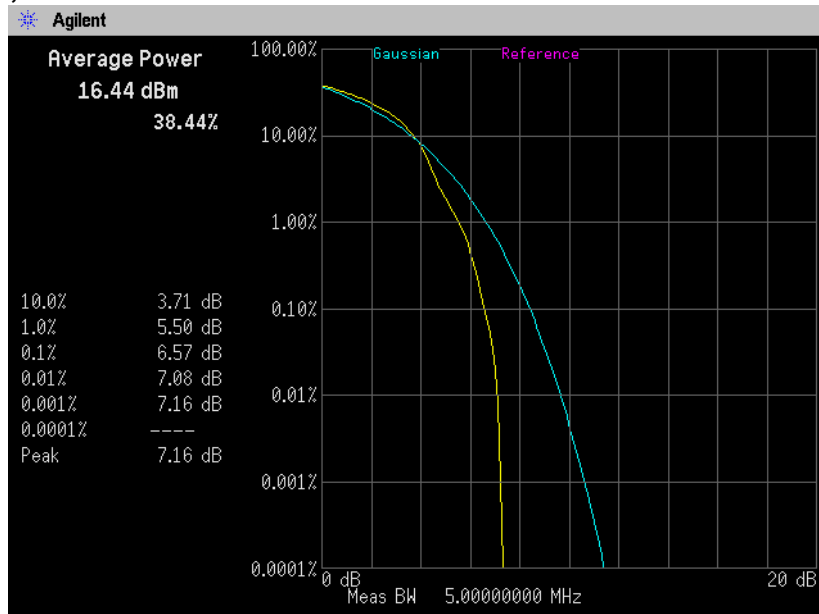



Zacta

16QAM, BW 1.4MHz, RB6-0

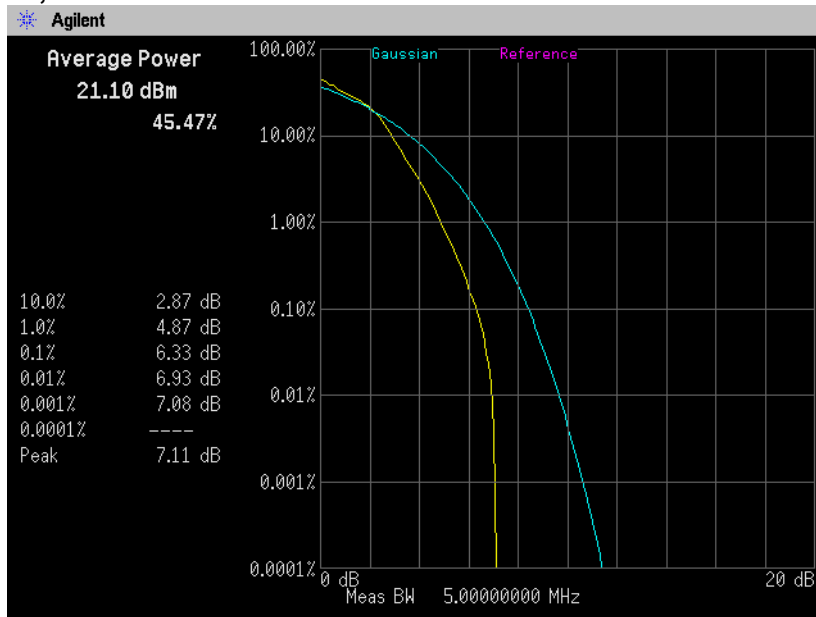

16QAM, BW 3MHz, RB15-0

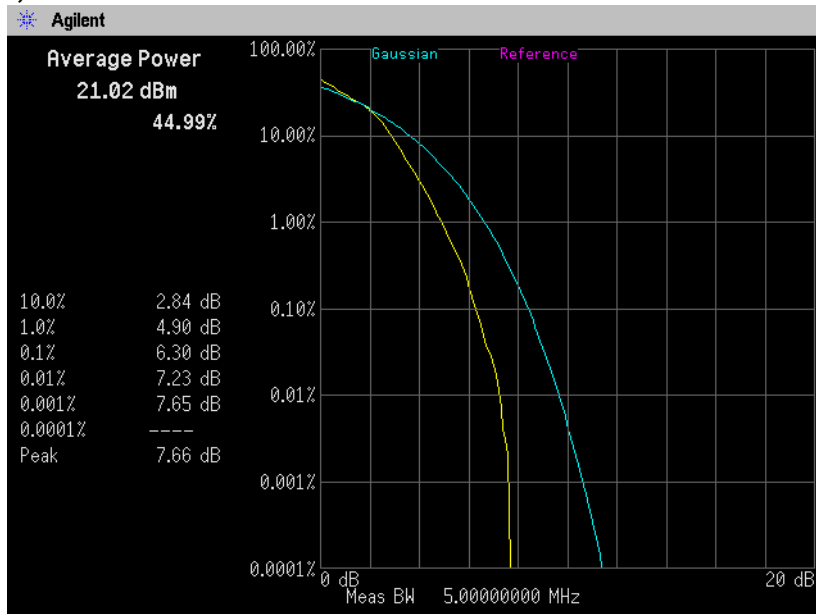



Zacta

16QAM, BW 5MHz, RB25-0

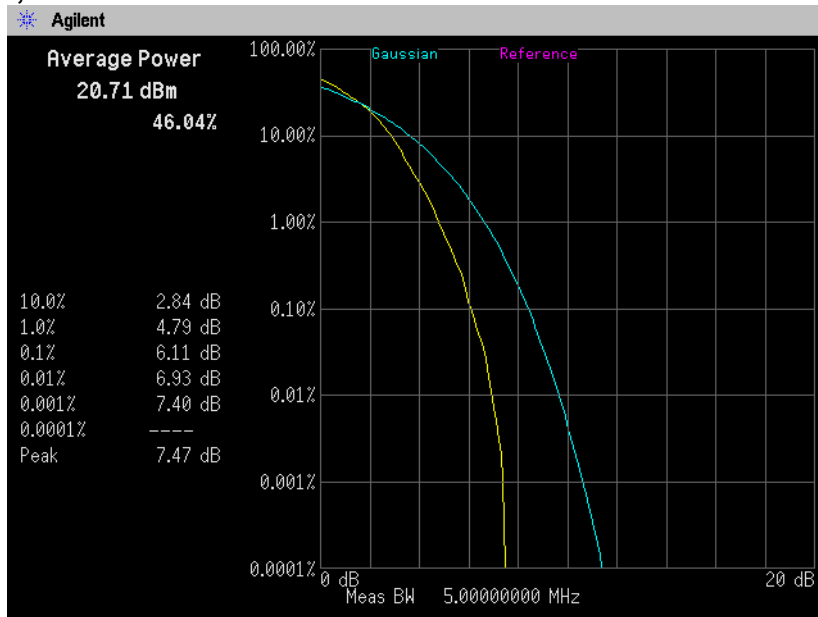

16QAM, BW 10MHz, RB50-0

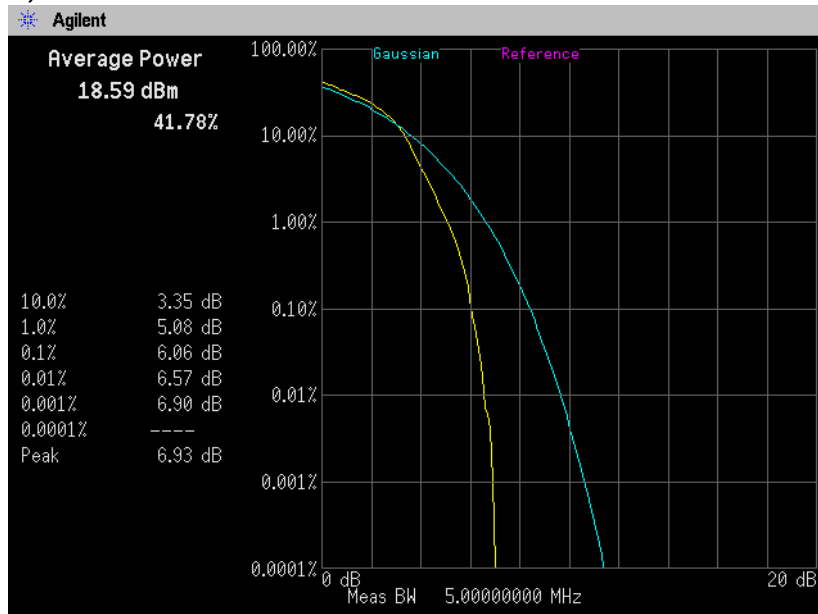



Zacta

16QAM, BW 15MHz, RB75-0



16QAM, BW 20MHz, RB100-0



7. Occupied Bandwidth

7.1 Measurement procedure

[FCC 24.238(a), 2.1049]

The Occupied bandwidth was measured with a spectrum analyzer connected to the antenna terminal.

The spectrum analyzer is set to;

[WCDMA Band II]

- RBW=51kHz, VBW=150kHz, Span=10MHz, Sweep=auto, Detector=Peak, Trace mode=Max hold

[LTE Band II]

- RBW=30kHz, VBW=91kHz, Span=3MHz, Sweep=auto, Detector=Peak, Trace mode=Max hold (1.4MHz)

- RBW=62kHz, VBW=180kHz, Span=6MHz, Sweep=auto, Detector=Peak, Trace mode=Max hold (3MHz)

- RBW=100kHz, VBW=300kHz, Span=10MHz, Sweep=auto, Detector=Peak, Trace mode=Max hold (5MHz)

- RBW=200kHz, VBW=620kHz, Span=20MHz, Sweep=auto, Detector=Peak, Trace mode=Max hold (10MHz)

- RBW=300kHz, VBW=910kHz, Span=30MHz, Sweep=auto, Detector=Peak, Trace mode=Max hold (15MHz)

- RBW=390kHz, VBW=1.2MHz, Span=40MHz, Sweep=auto, Detector=Peak, Trace mode=Max hold (20MHz)

- Test configuration

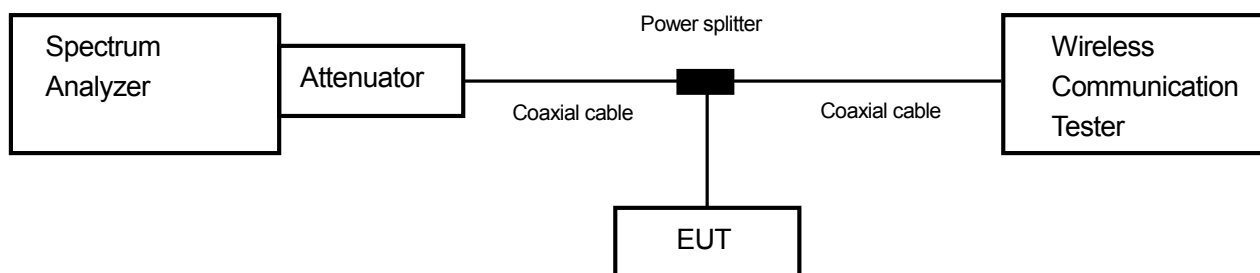

7.2 Limit

None

7.3 Measurement result

Date : June 19, 2015

Temperature : 24.9 [°C]

Humidity : 49.1 [%]

Test place : Shielded room No.4

Test engineer :

Hikaru Shibata

Band	Channel	Frequency (MHz)	Test Result (MHz)
WCDMA Band II	9262	1852.4	4.1628
	9400	1880.0	4.1609
	9538	1907.6	4.1601

[LTE Band II]

Mode	UL RB Allocation	UL RB Start	Frequency [MHz]	26dB Bandwidth [MHz]	99% OBW [MHz]
QPSK	1	0	1880.0	0.419	0.2779
	1	5		0.446	0.2856
	3	1		0.908	0.6108
	6	0		1.330	1.1051
16QAM	1	0	1880.0	0.427	0.2776
	1	5		0.427	0.2828
	3	1		0.923	0.6255
	6	0		1.339	1.1098
QPSK	1	0	1880.0	0.524	0.3717
	1	14		0.510	0.3520
	8	4		2.156	1.5533
	15	0		3.102	2.7115
16QAM	1	0	1880.0	0.530	0.3686
	1	14		0.511	0.3589
	8	4		2.151	1.5605
	15	0		3.105	2.7214
QPSK	1	0	1880.0	0.737	0.5127
	1	24		0.740	0.5129
	12	7		3.352	2.3164
	25	0		5.083	4.5163
16QAM	1	0	1880.0	0.706	0.4888
	1	24		0.713	0.4976
	12	7		3.337	2.3434
	25	0		5.122	4.5252
QPSK	1	0	1880.0	1.014	0.7385
	1	49		1.040	0.7489
	25	12		6.609	4.7157
	50	0		10.034	8.9884
16QAM	1	0	1880.0	0.984	0.7177
	1	49		0.998	0.7199
	25	12		6.689	4.7063
	50	0		10.011	8.9815



Zacta

[LTE Band II]

Mode	UL RB Allocation	UL RB Start	Frequency [MHz]	26dB Bandwidth [MHz]	99% OBW [MHz]
QPSK	1	0	1880.0	1.544	1.1177
	1	74		1.616	1.1558
	36	20		9.093	6.8423
	75	0		14.968	13.4781
16QAM	1	0	1880.0	1.620	1.1294
	1	74		1.568	1.1182
	36	20		9.460	6.8112
	75	0		14.982	13.4688
QPSK	1	0	1880.0	2.009	1.4147
	1	99		2.006	1.4392
	50	24		11.876	9.2877
	100	0		19.884	17.9533
16QAM	1	0	1880.0	2.020	1.4612
	1	99		1.974	1.4364
	50	24		11.963	9.2628
	100	0		19.857	17.9716



Zacta

7.4 Trace data
[WCDMA]

Channel: 9262

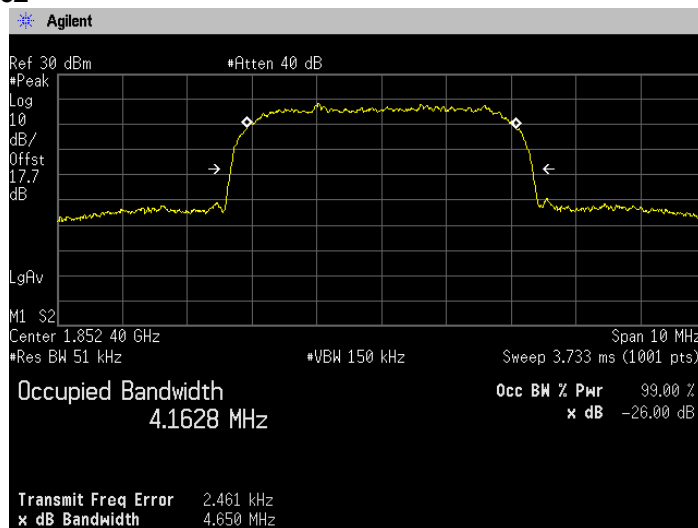

Channel: 9400

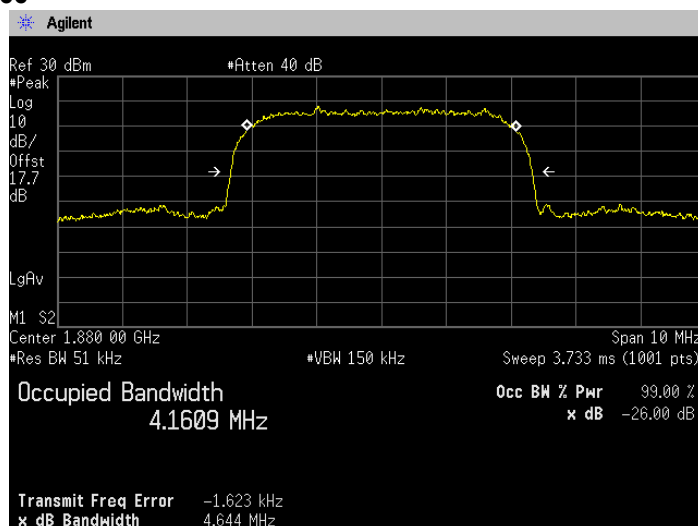

Channel: 9538

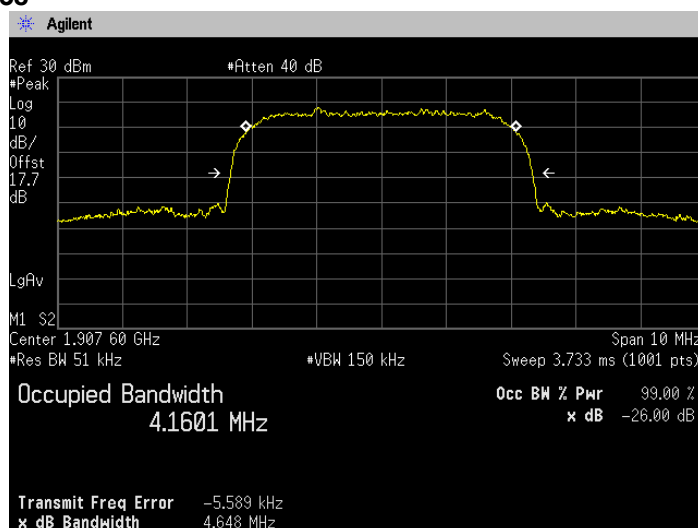



Zacta

**[LTE Band II]
Channel: 18900
QPSK, BW 1.4MHz, RB1-0**

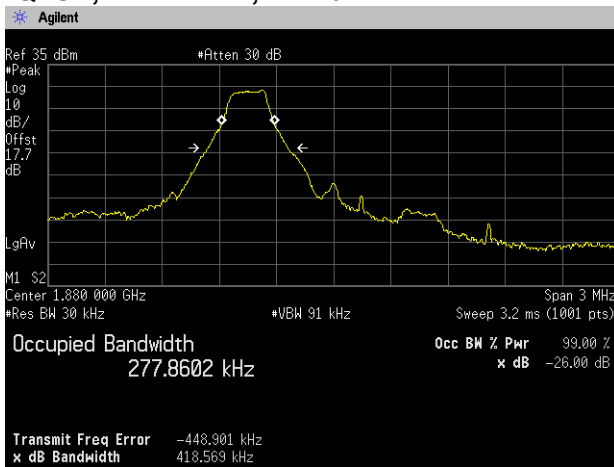

RB1-5

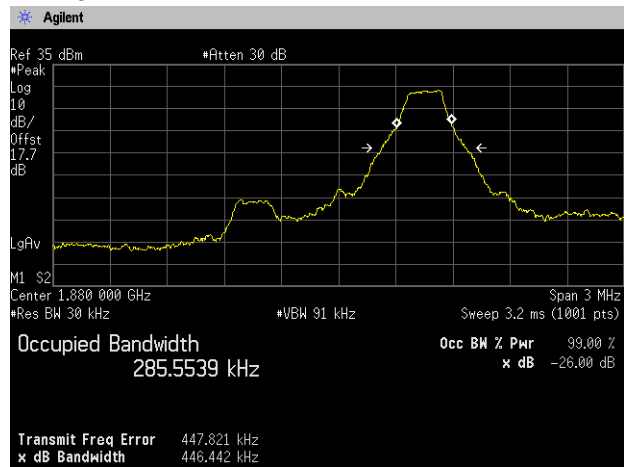

RB3-1

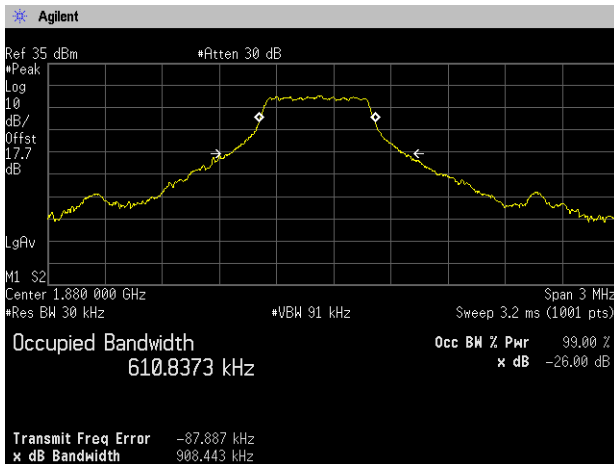

RB6-0

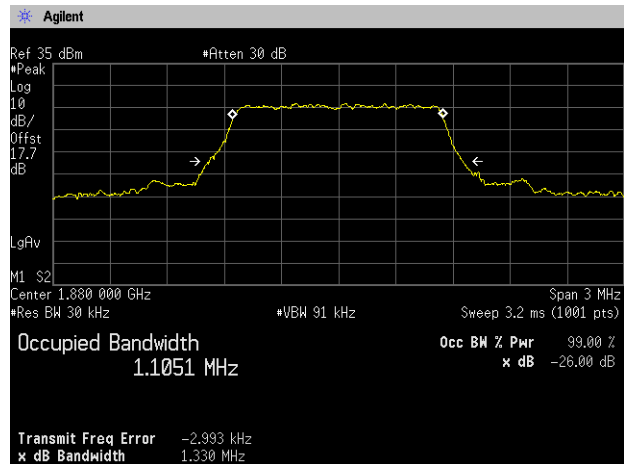



Zacta

16QAM, BW 1.4MHz, RB1-0

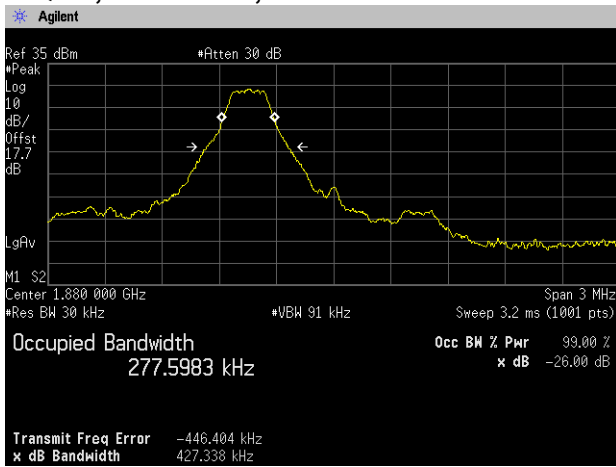

RB1-5

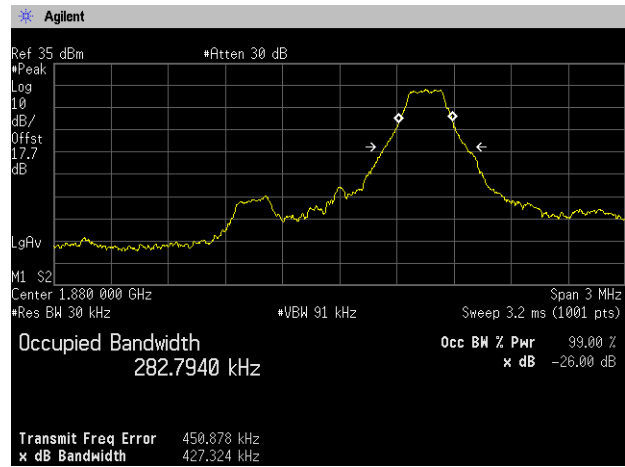

RB3-1

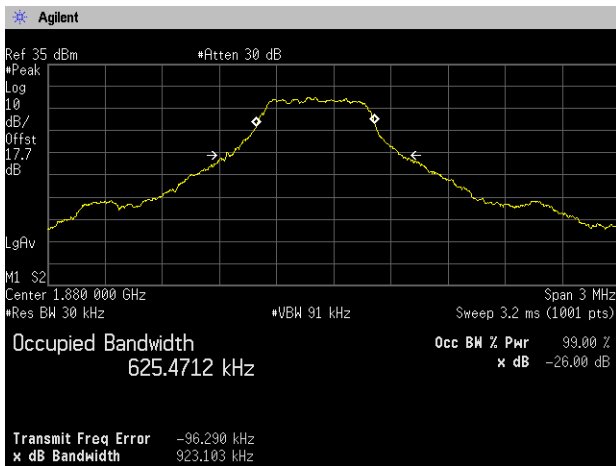

RB6-0

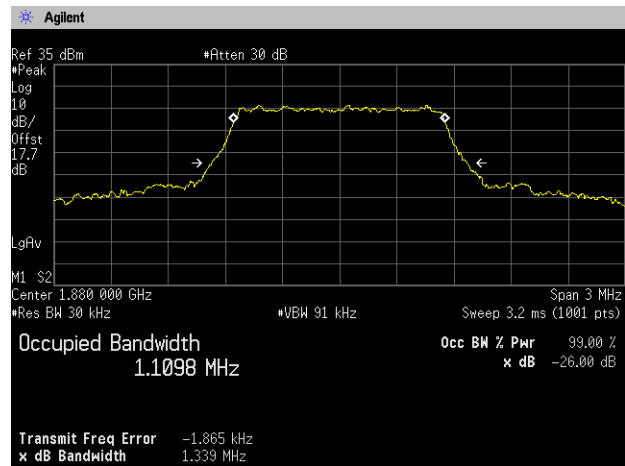



Zacta

QPSK, BW 3MHz, RB1-0

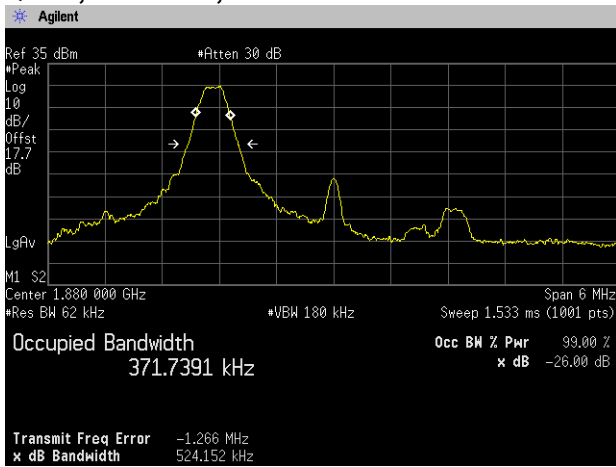

RB1-14

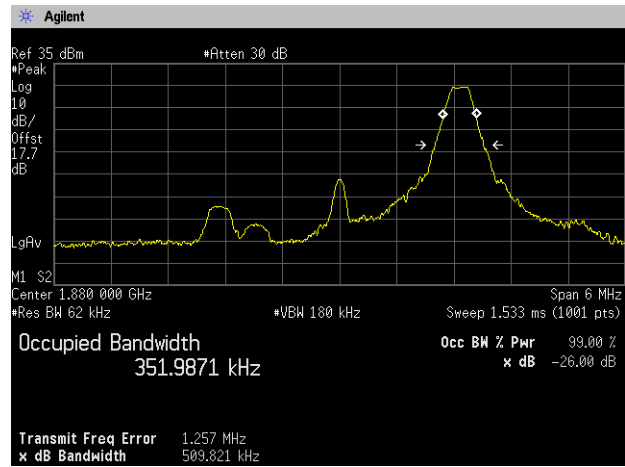

RB8-4

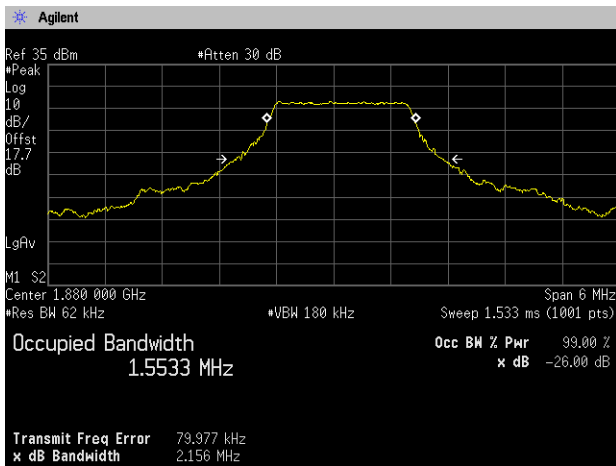

RB15-0

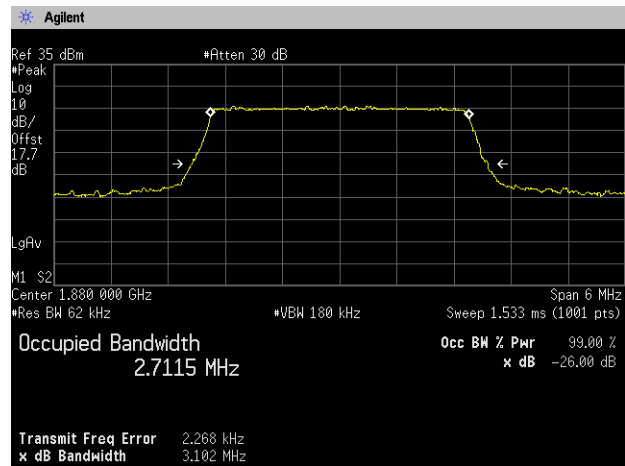



Zacta

16QAM, BW 3MHz, RB1-0

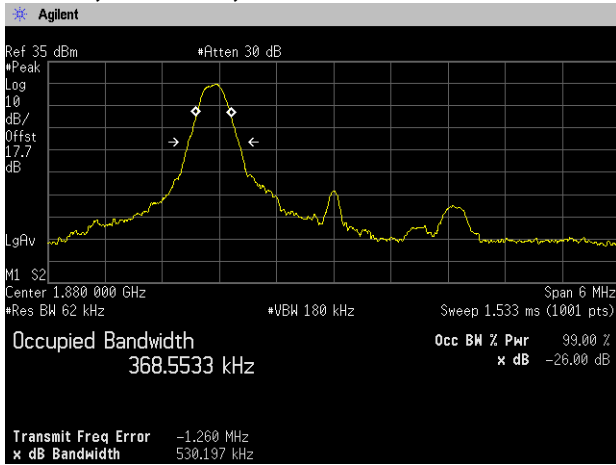

RB1-14

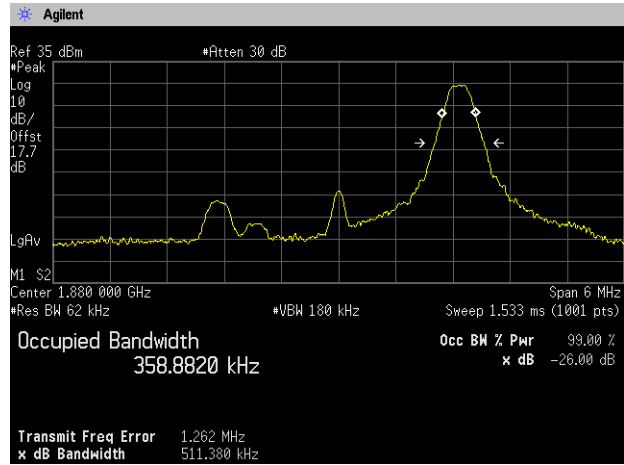

RB8-4

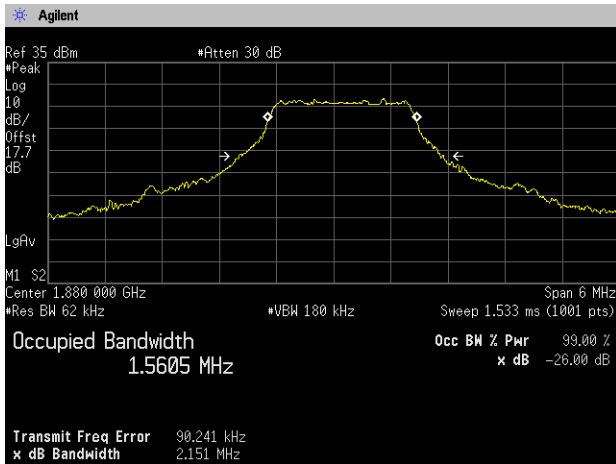

RB15-0

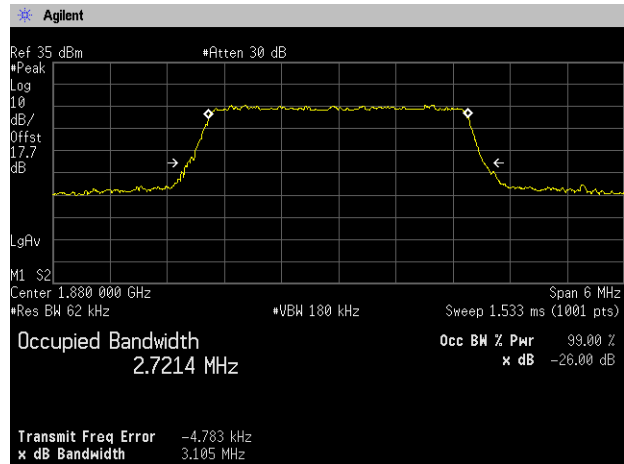



Zacta

QPSK, BW 5MHz, RB1-0

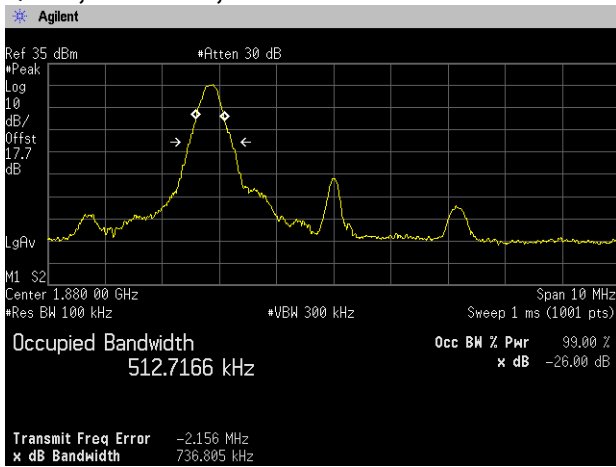

RB1-24

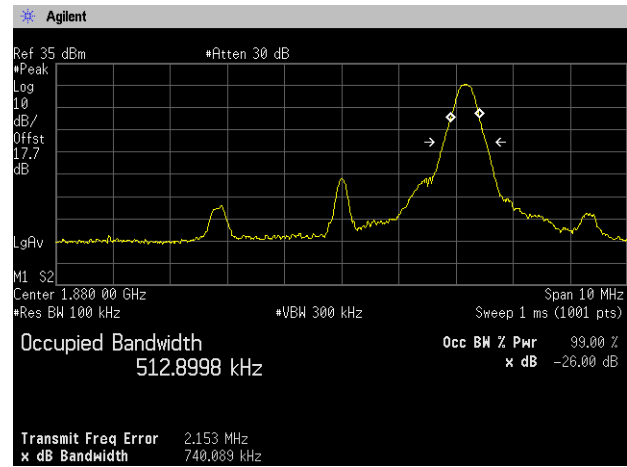

RB12-7

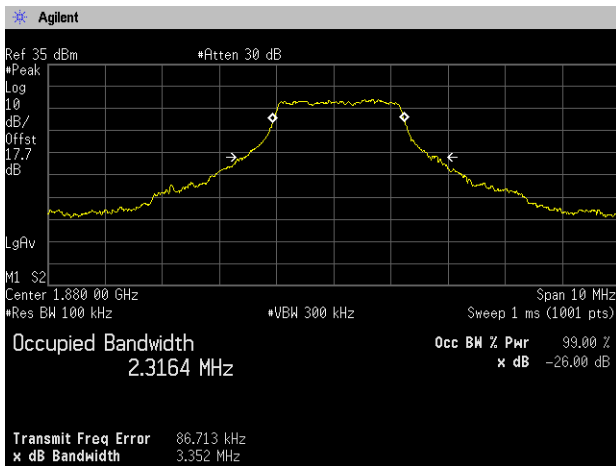

RB25-0

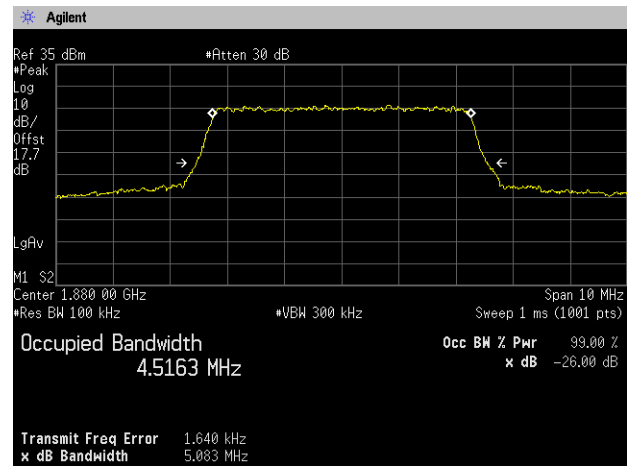



Zacta

16QAM, BW 5MHz, RB1-0

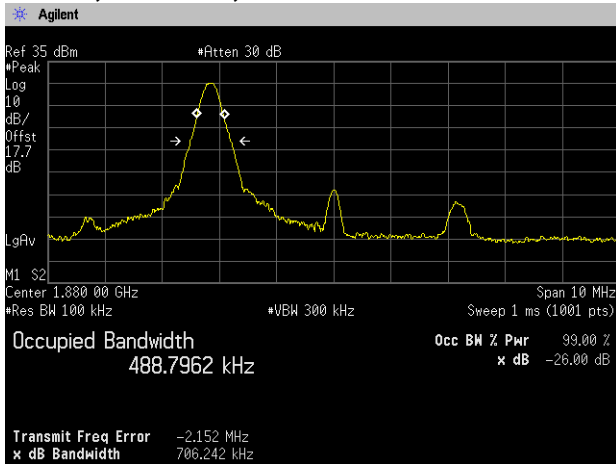

RB1-24

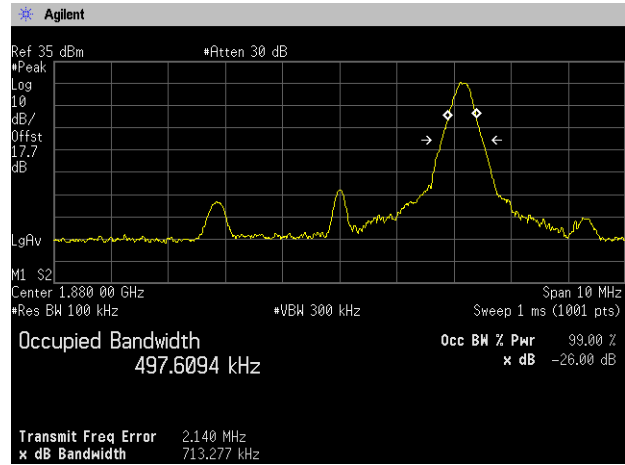

RB12-7

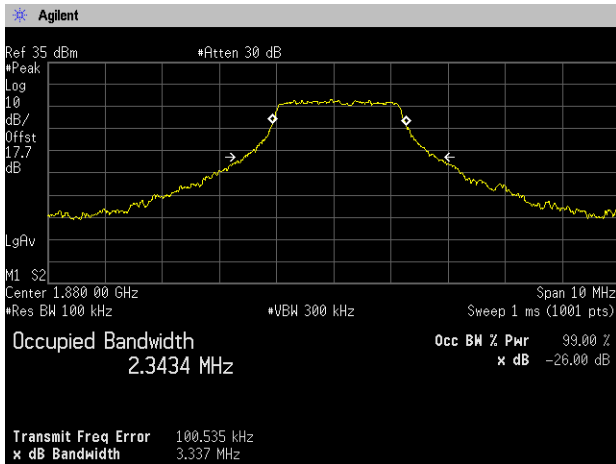

RB25-0

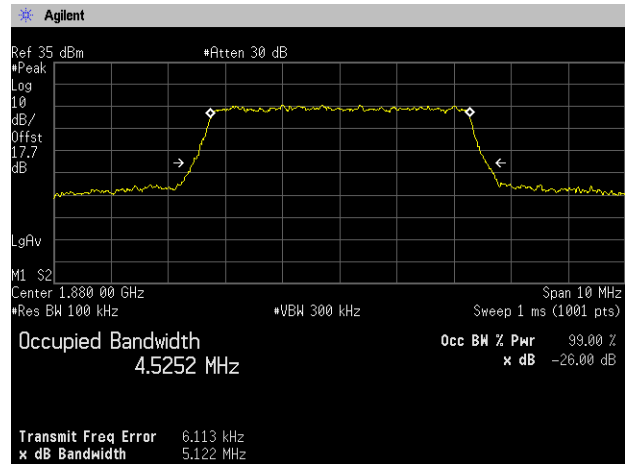



Zacta

QPSK, BW 10MHz, RB1-0

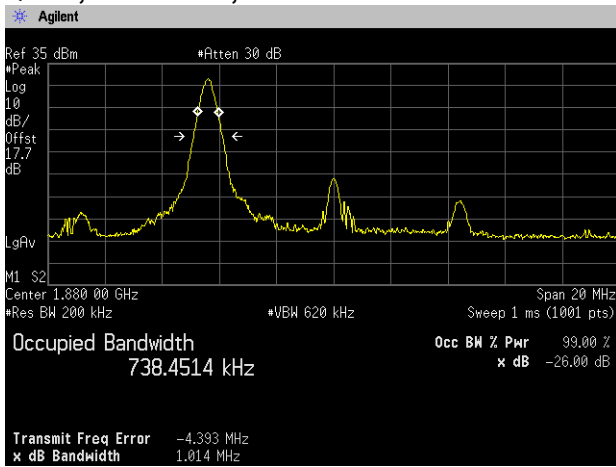

RB1-49

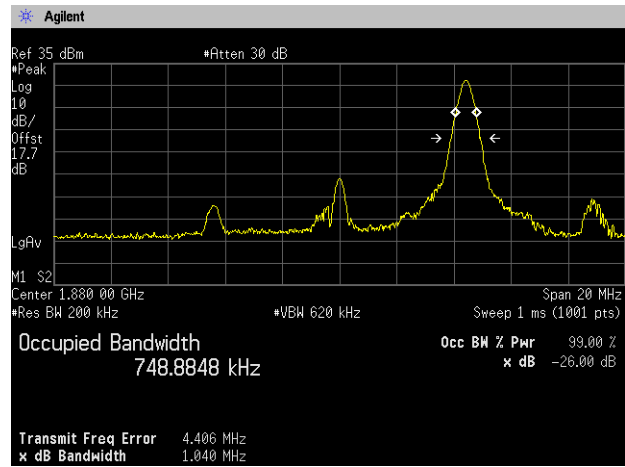

RB25-12

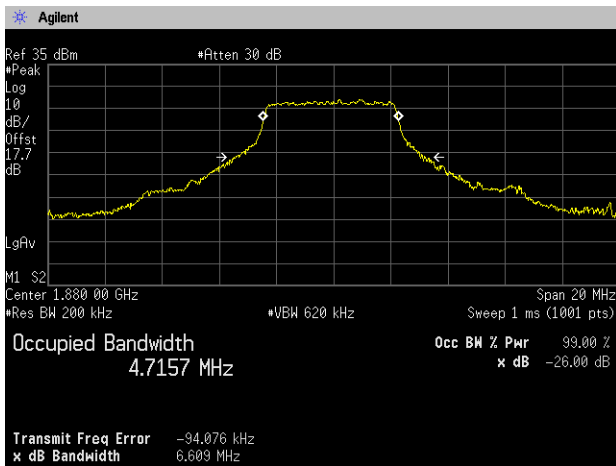

RB50-0

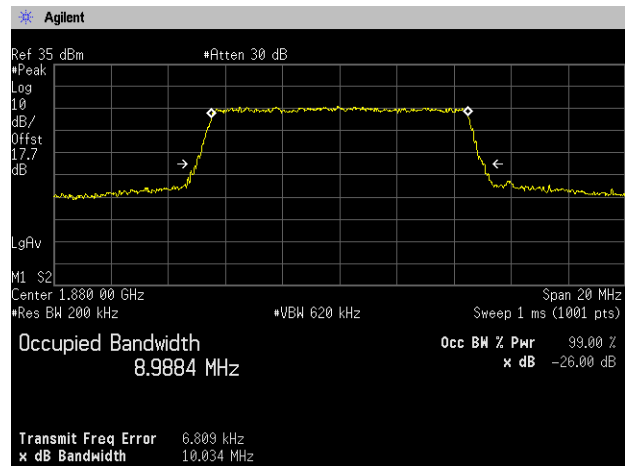



Zacta

16QAM, BW 10MHz, RB1-0

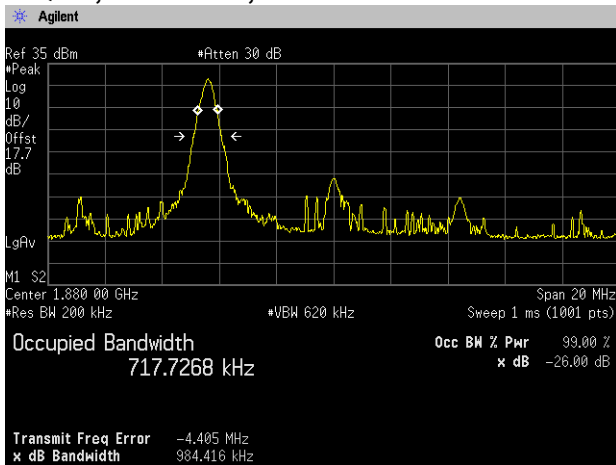

RB1-49

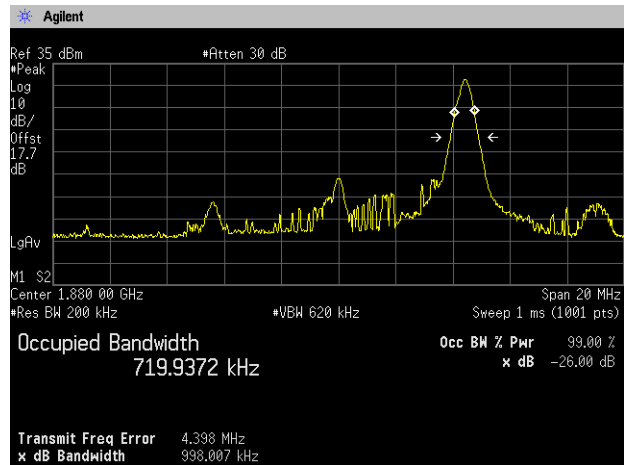

RB25-12

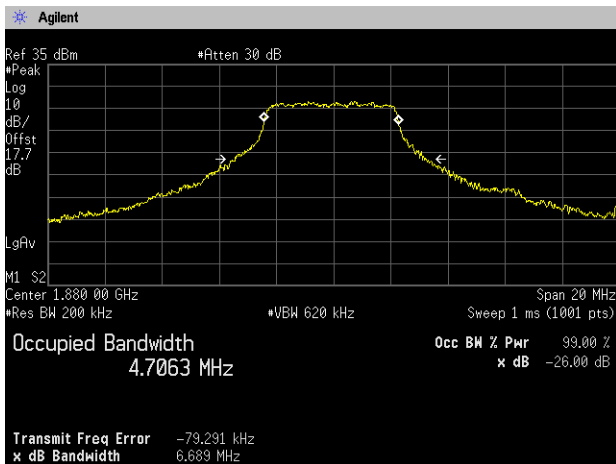

RB50-0

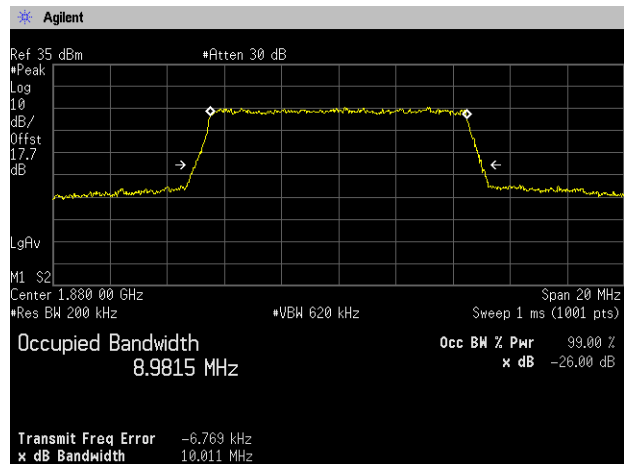



Zacta

QPSK, BW 15MHz, RB1-0

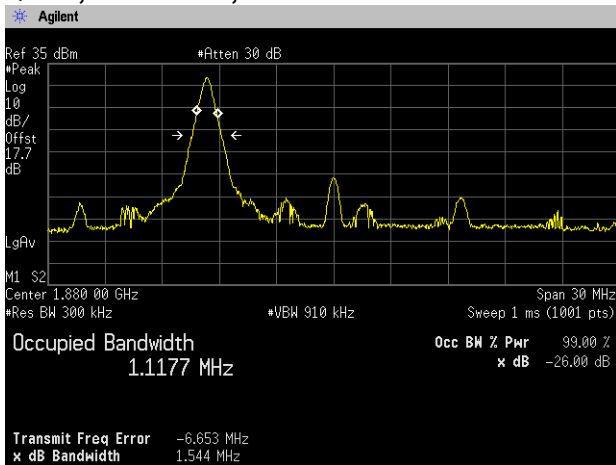

RB1-74

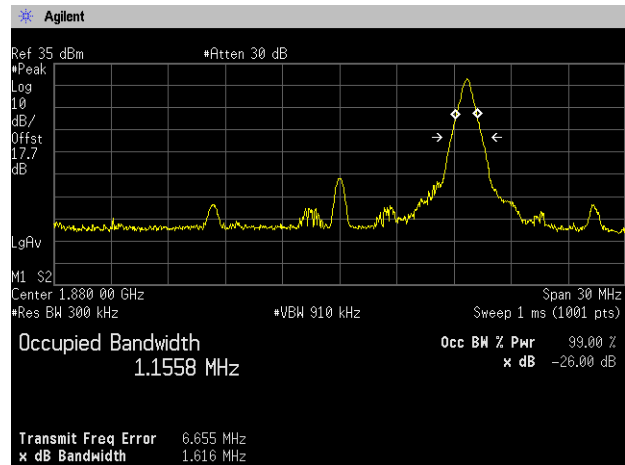

RB36-20

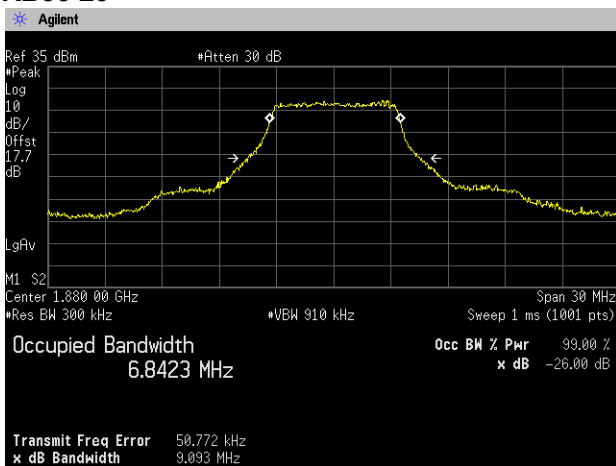

RB75-0

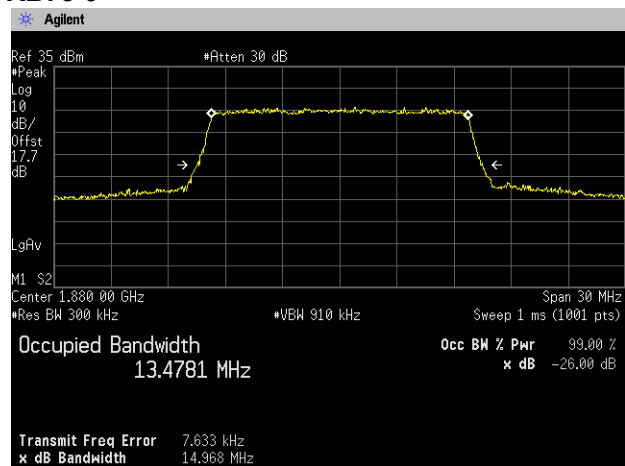



Zacta

16QAM, BW 15MHz, RB1-0

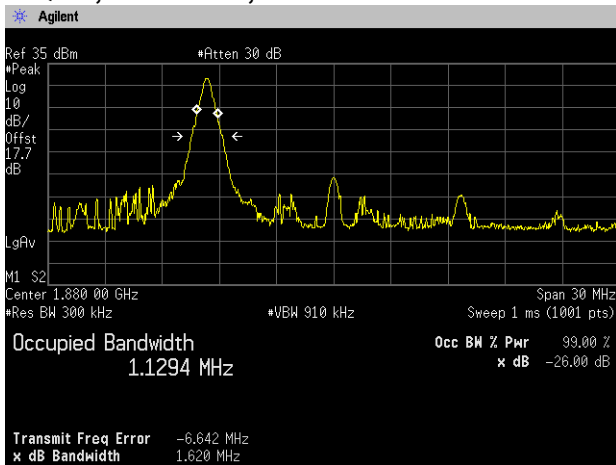

RB1-74

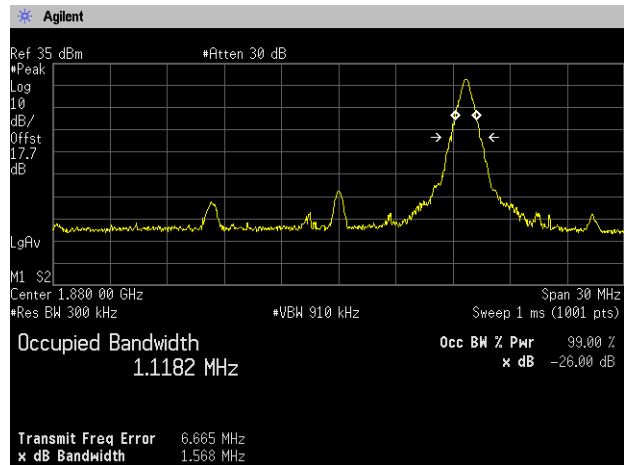

RB36-20

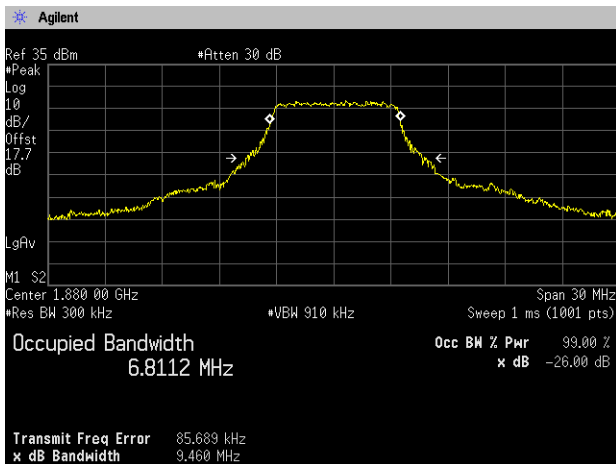

RB75-0

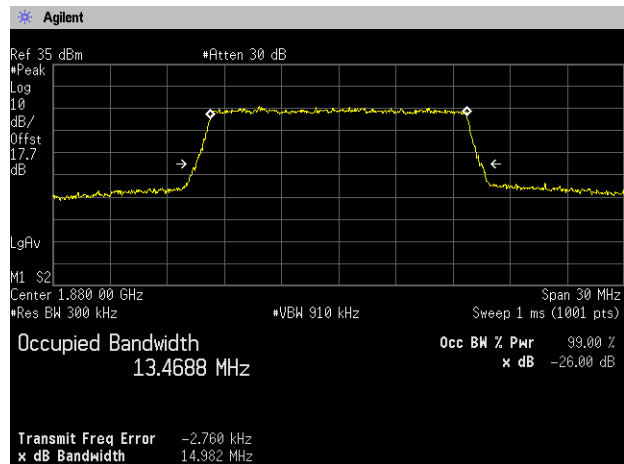



Zacta

QPSK, BW 20MHz, RB1-0

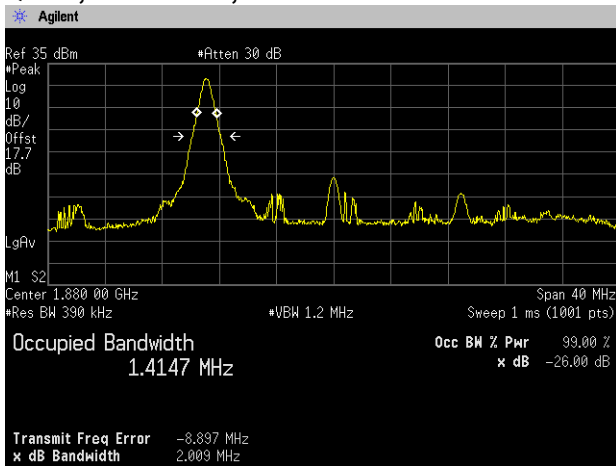

RB1-99

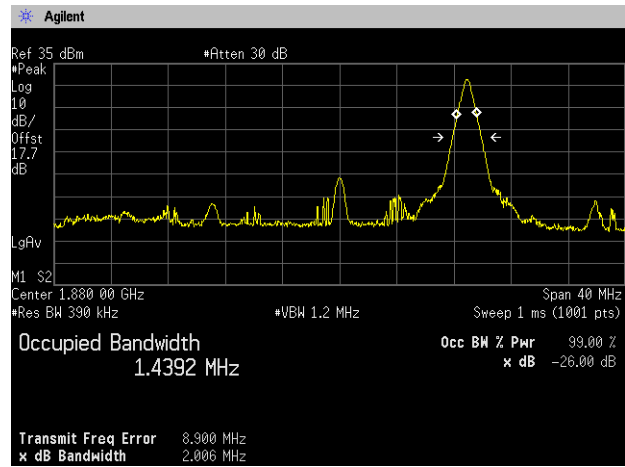

RB50-24

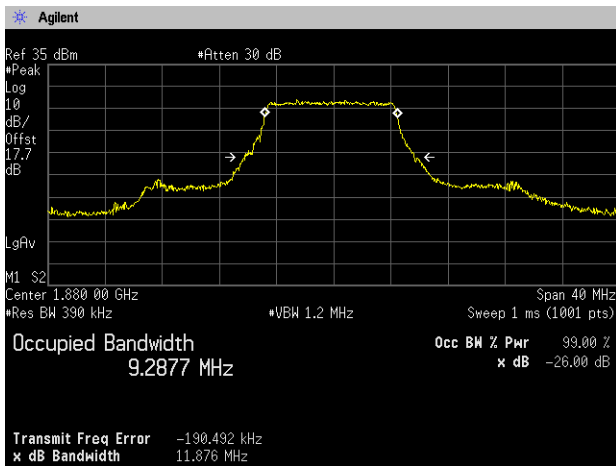

RB100-0

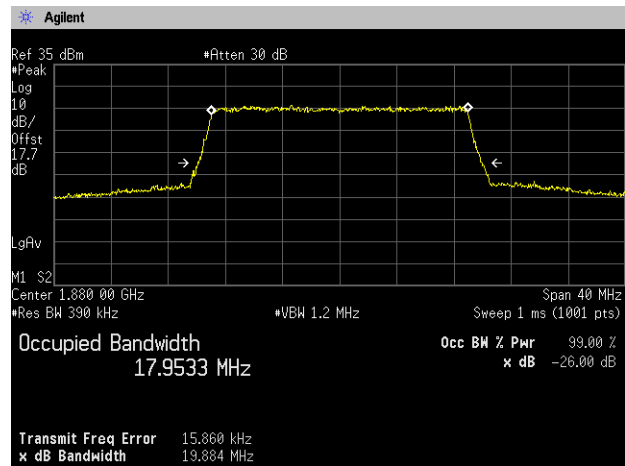



Zacta

16QAM, BW 20MHz, RB1-0

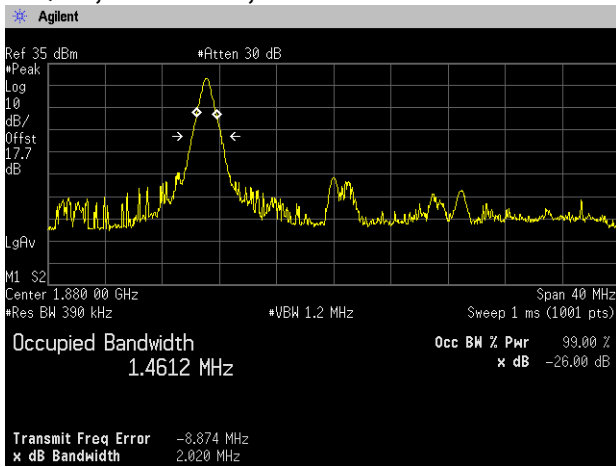

RB1-99

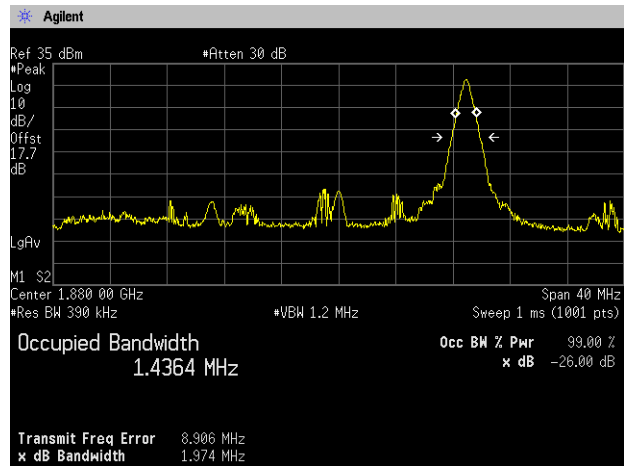

RB50-24

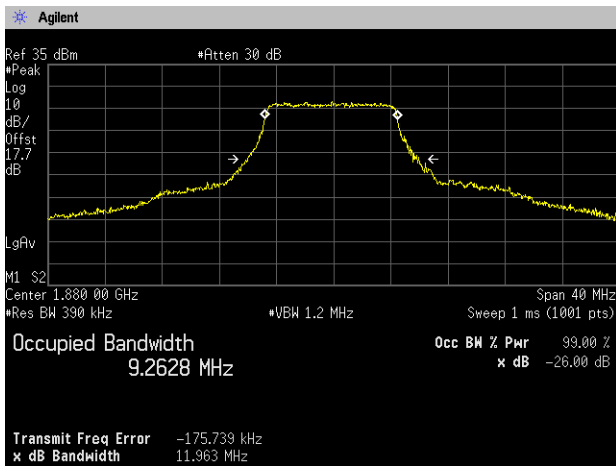

RB100-0

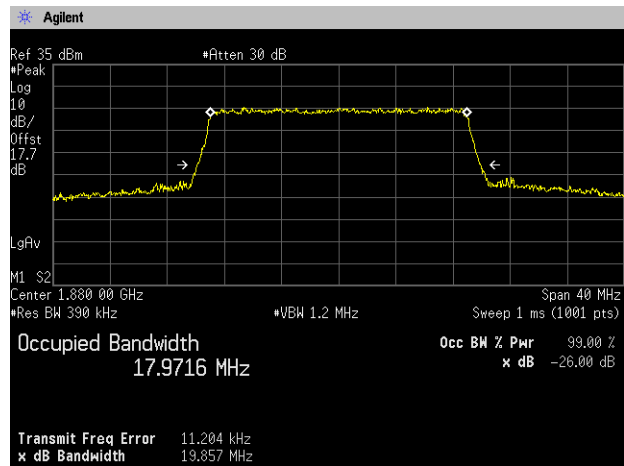

8. Band Edge Spurious and Harmonic at Antenna Terminals

8.1 Measurement procedure

[FCC 24.238(a), 2.1051, IC RSS-133 6.5.1]

The band edge spurious and harmonic was measured with a spectrum analyzer connected to the antenna terminal.

The spectrum analyzer is set to;

<Band Edge>

[WCDMA Band II]

- RBW=51kHz, VBW=150kHz, Span=10MHz, Sweep=auto, Detector=Peak, Trace mode=Max hold

[LTE Band II]

- RBW=20kHz, VBW=62kHz, Span=2.8MHz, Sweep=auto, Detector=Peak, Trace mode=Max hold (1.4MHz)

- RBW=43kHz, VBW=130kHz, Span=6MHz, Sweep=auto, Detector=Peak, Trace mode=Max hold (3MHz)

- RBW=75kHz, VBW=220kHz, Span=10MHz, Sweep=auto, Detector=Peak, Trace mode=Max hold (5MHz)

- RBW=150kHz, VBW=430kHz, Span=20MHz, Sweep=auto, Detector=Peak, Trace mode=Max hold (10MHz)

- RBW=220kHz, VBW=680kHz, Span=30MHz, Sweep=auto, Detector=Peak, Trace mode=Max hold (15MHz)

- RBW=300kHz, VBW=910kHz, Span=40MHz, Sweep=auto, Detector=Peak, Trace mode=Max hold (20MHz)

<Spurious Emissions>

- RBW=1MHz, VBW=3MHz, Span=Arbitrary setting, Sweep=auto, Detector=Peak, Trace mode=Max hold

- Test configuration

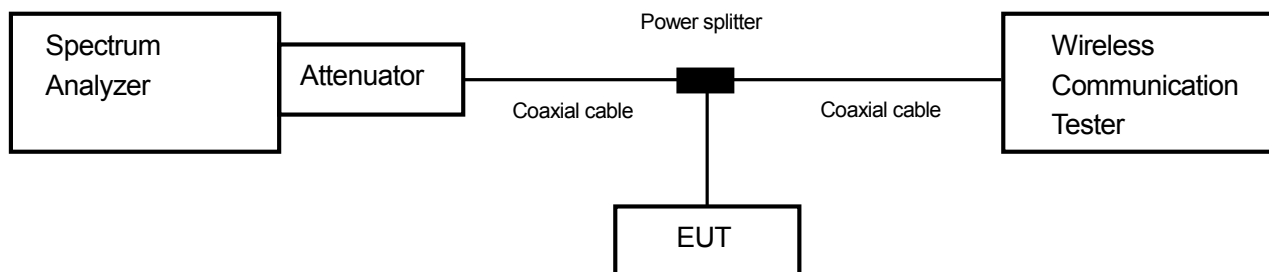

8.2 Limit

-13dBm or less

8.3 Measurement result

Date : June 20, 2015

Temperature : 24.2 [°C]

Humidity : 53.7 [%]

Test place : Shielded room No.4

Test engineer :

Hikaru Shibata

Band	Channel	Frequency [MHz]	Limit [dB]	Results	Results
WCDMA Band II	9262	1852.4	-13.0	See the trace data	PASS
	9538	1907.6	-13.0	See the trace data	PASS



Zacta

Band	Modulation	Bandwidth	Results	
LTE Band II	QPSK	1.4MHz	See the trace data	PASS
		3MHz	See the trace data	PASS
		5MHz	See the trace data	PASS
		10MHz	See the trace data	PASS
		15MHz	See the trace data	PASS
		20MHz	See the trace data	PASS
	16QAM	1.4MHz	See the trace data	PASS
		3MHz	See the trace data	PASS
		5MHz	See the trace data	PASS
		10MHz	See the trace data	PASS
		15MHz	See the trace data	PASS
		20MHz	See the trace data	PASS



Zacta

8.4 Trace data [WCDMA Band II] (Band Edge)

Channel: 9262

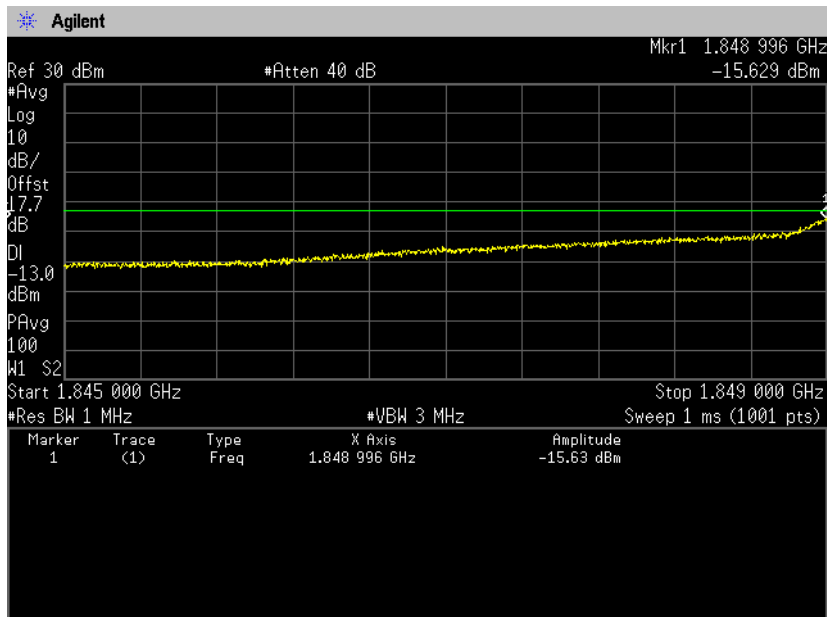
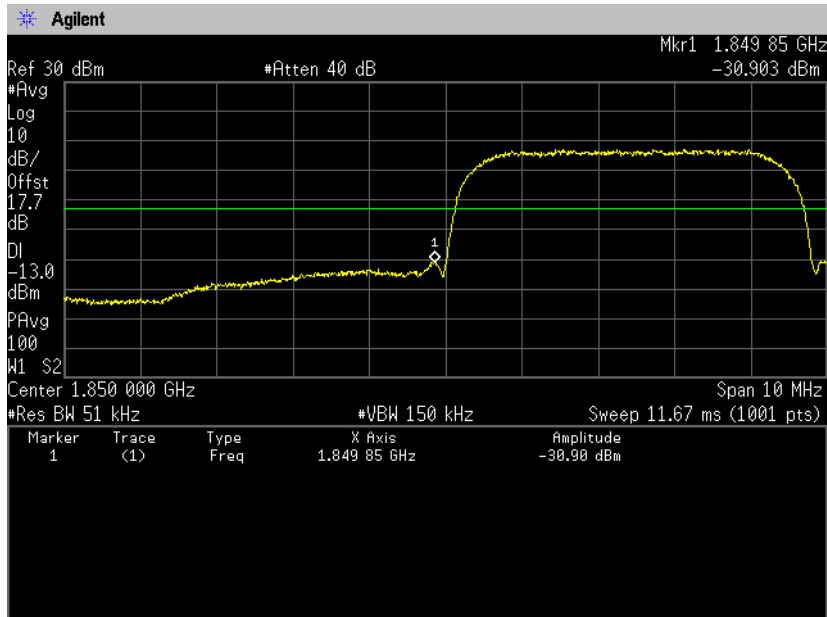



Zacta

Channel: 9538

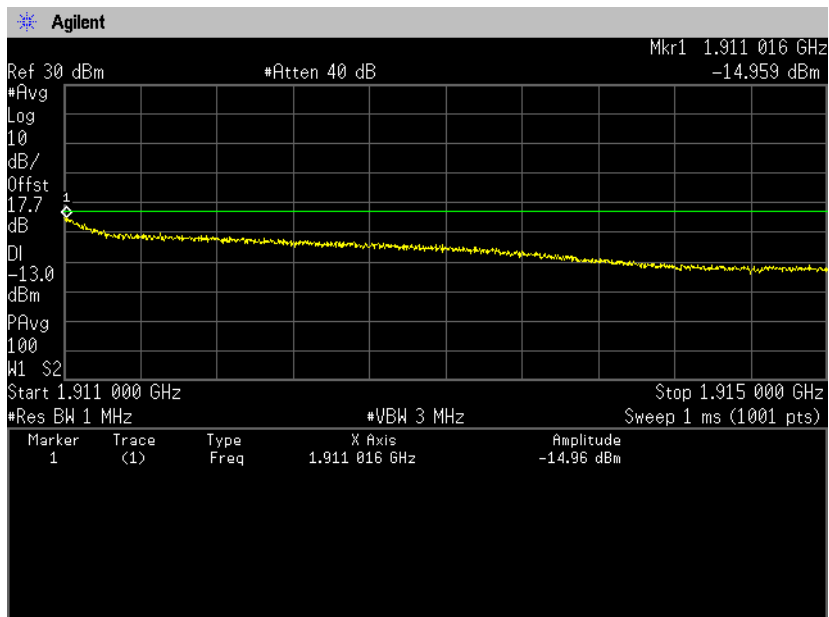
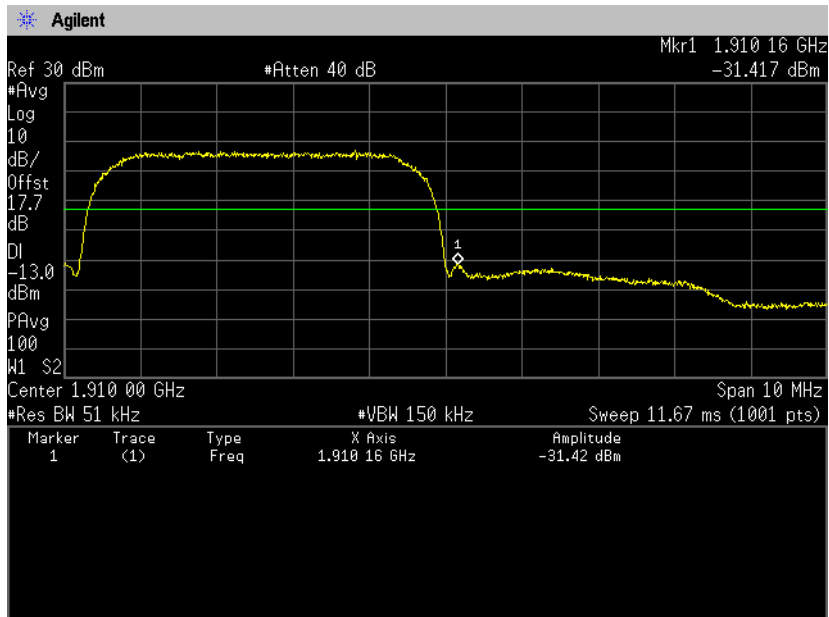



Zacta

(Spurious Emissions)

Note: Conducted spurious test was measured in the worst case of conducted output power.

Channel: 9262
30MHz-5GHz

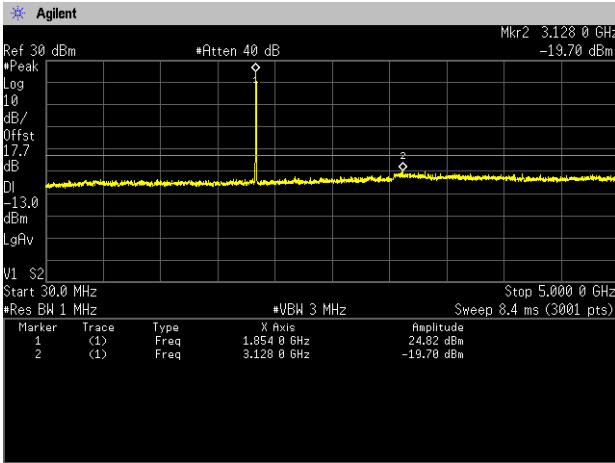

5GHz-10GHz

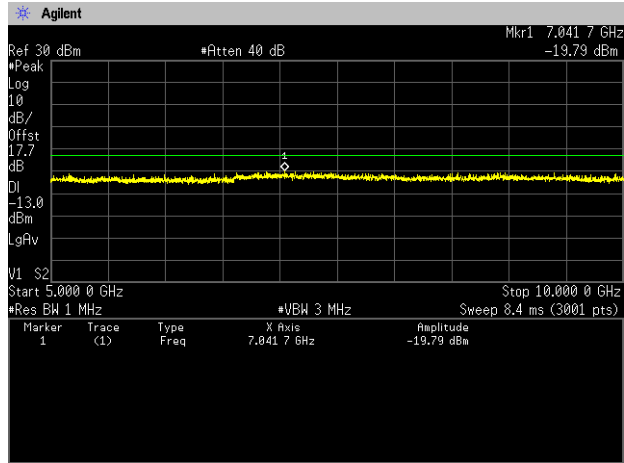

10GHz-15GHz

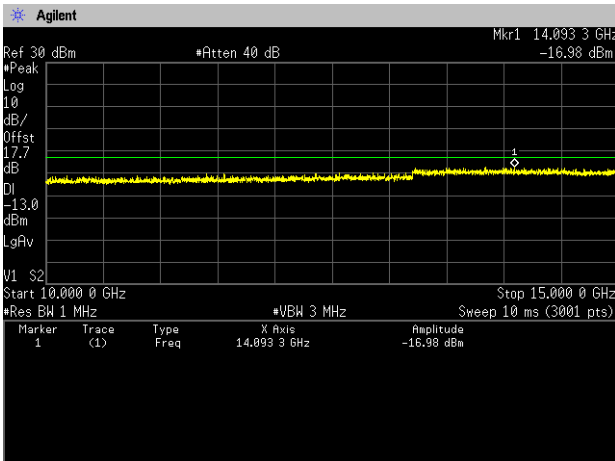

15GHz-20GHz

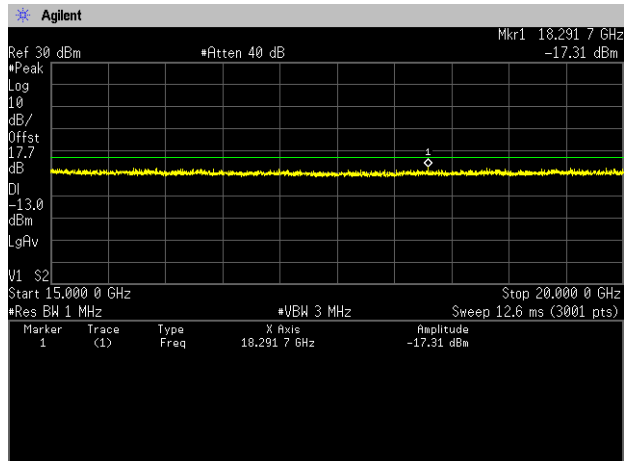



Zacta

Channel: 9400
30MHz-5GHz

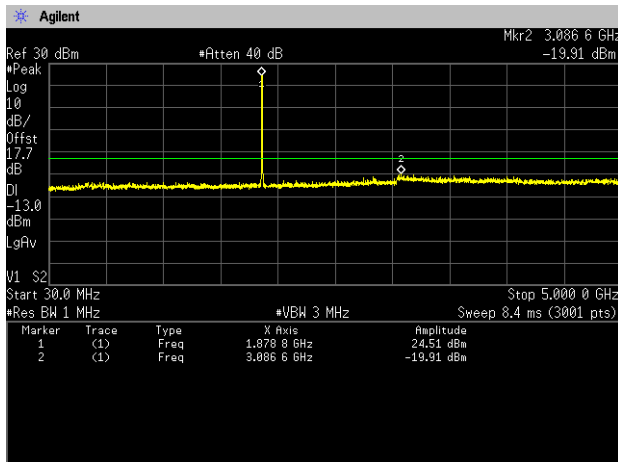

5GHz-10GHz

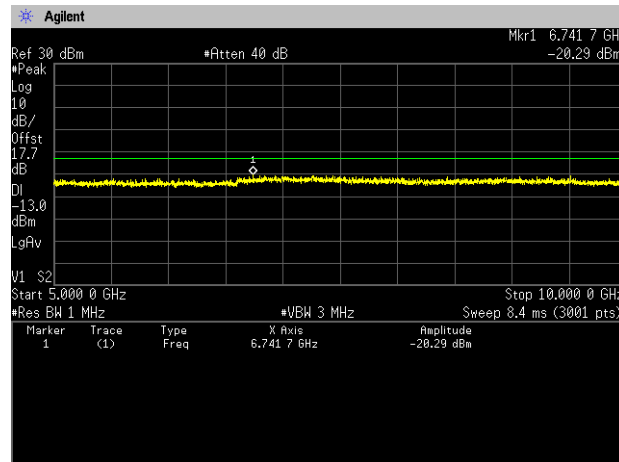

10GHz-15GHz

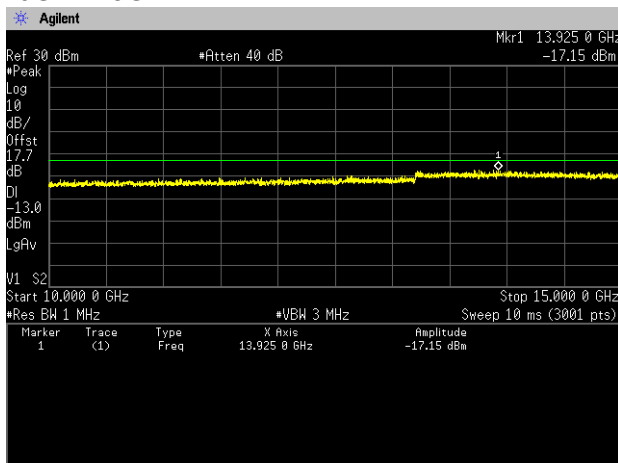

15GHz-20GHz

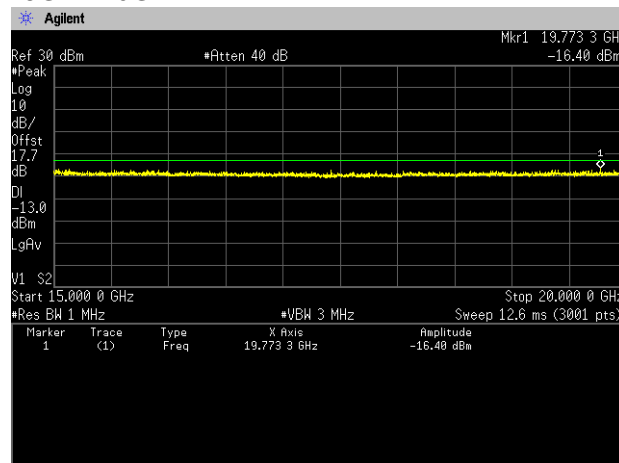



Zacta

Channel: 9538 30MHz-5GHz

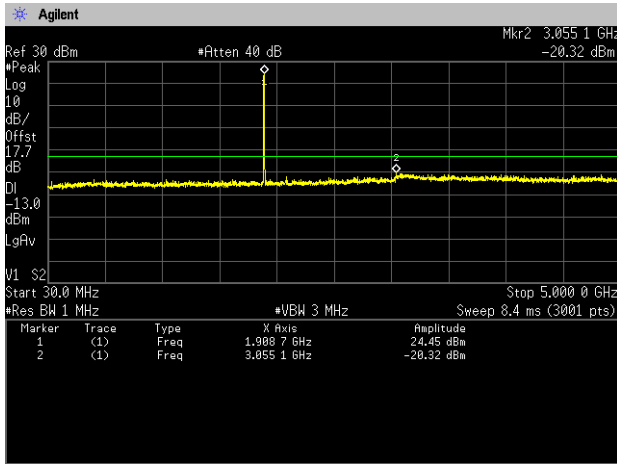

5GHz-10GHz

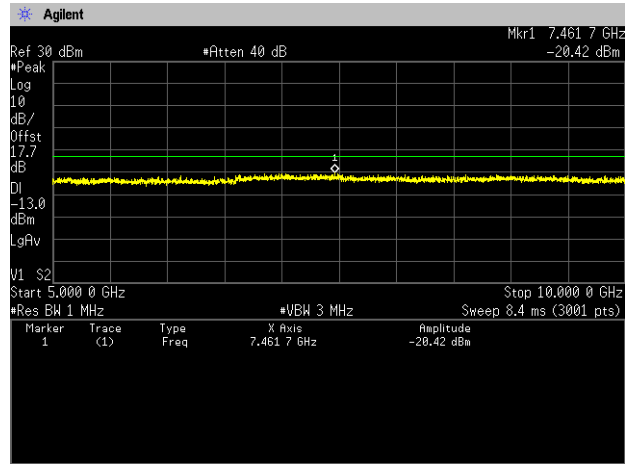

10GHz-15GHz

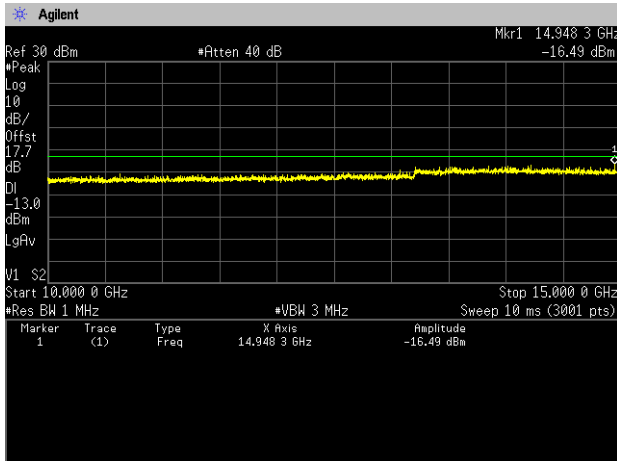

15GHz-20GHz

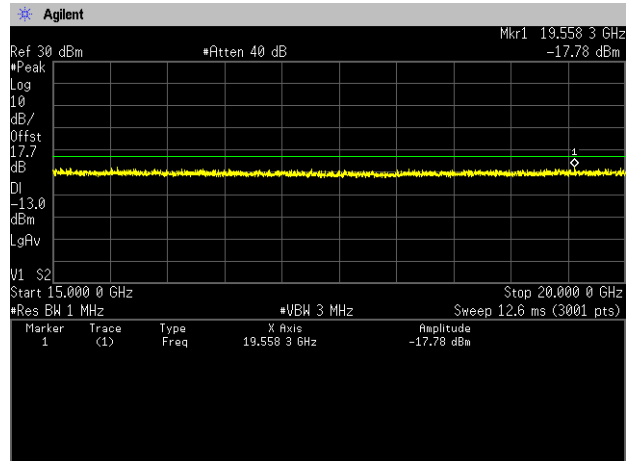

**[LTE Band II]
(Band Edge)
QPSK, BW 1.4MHz, RB1-0
Channel: Low**

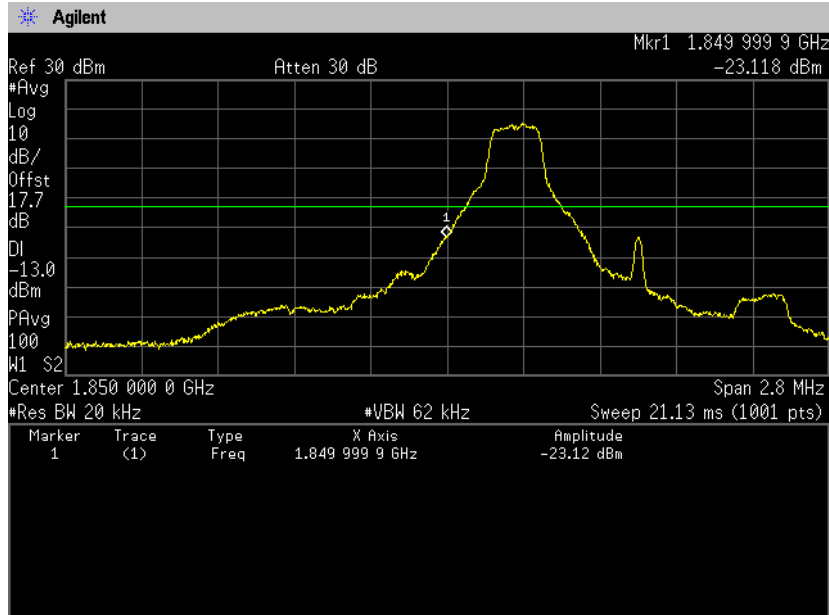

**QPSK, BW 1.4MHz, RB1-5
Channel: High**

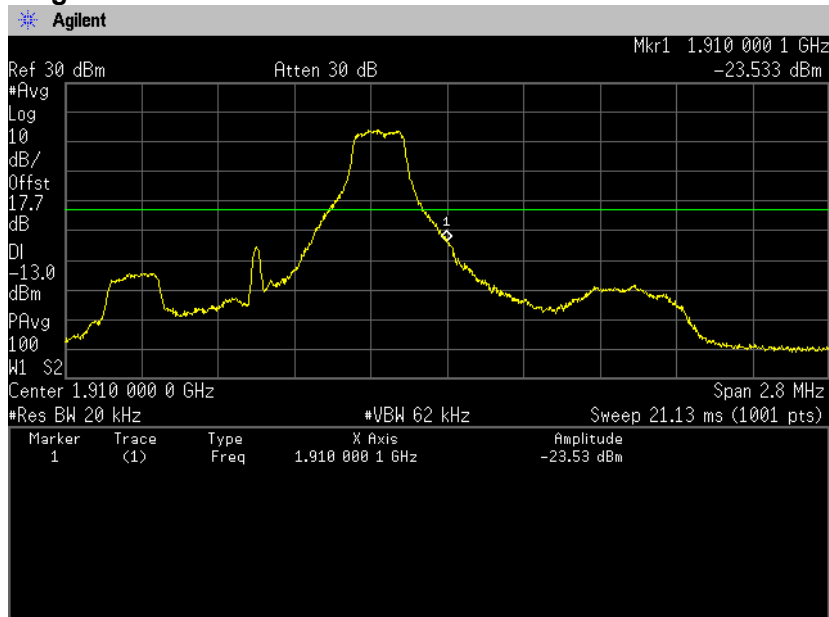



Zacta

QPSK, BW 1.4MHz, RB6-0 Channel: Low

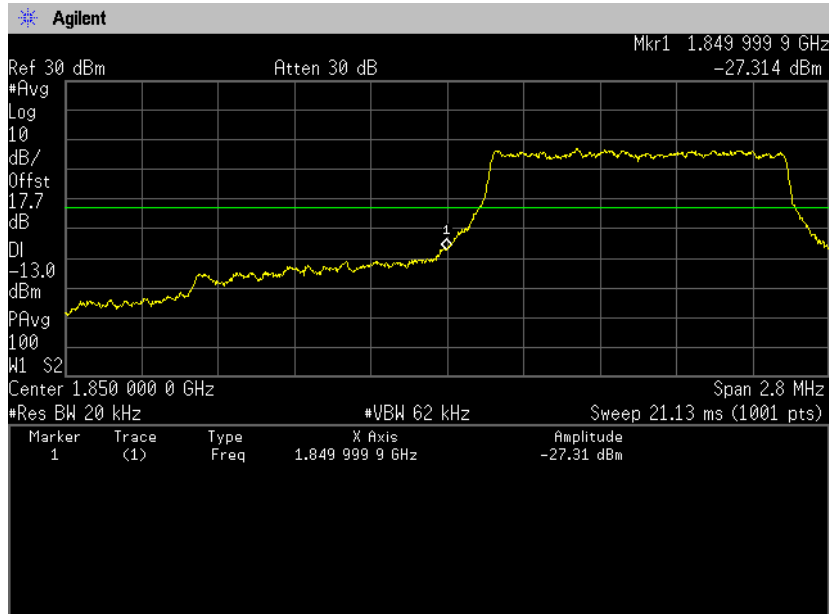

QPSK, BW 1.4MHz, RB6-0 Channel: High

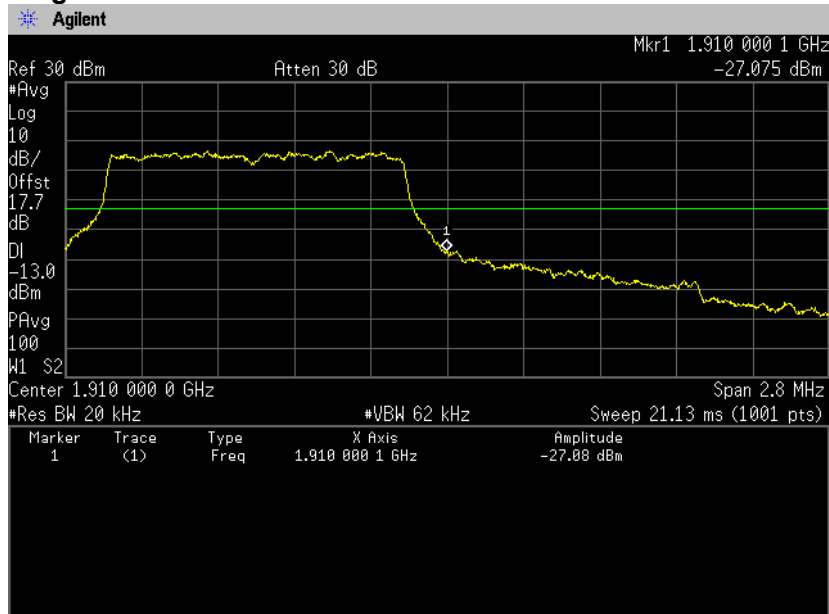



Zacta

16QAM, BW 1.4MHz, RB1-0 Channel: Low

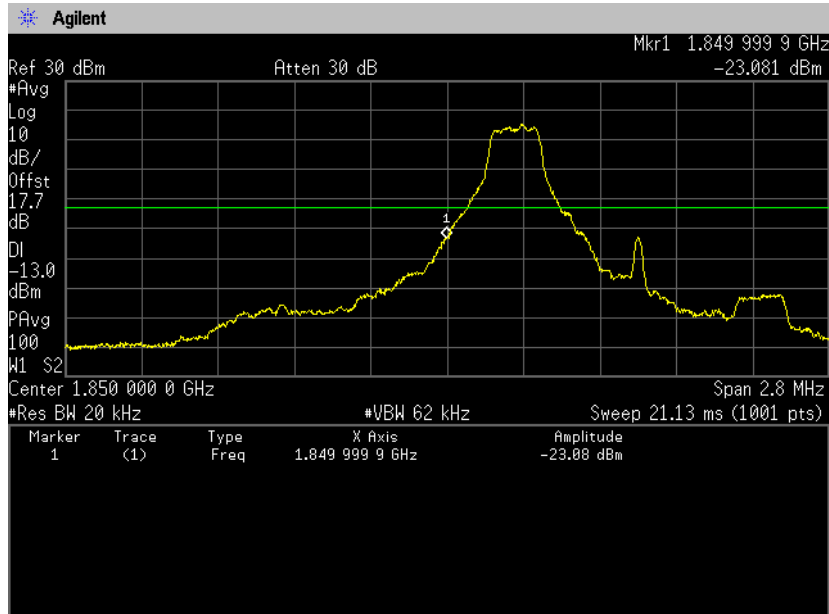

16QAM, BW 1.4MHz, RB1-5 Channel: High

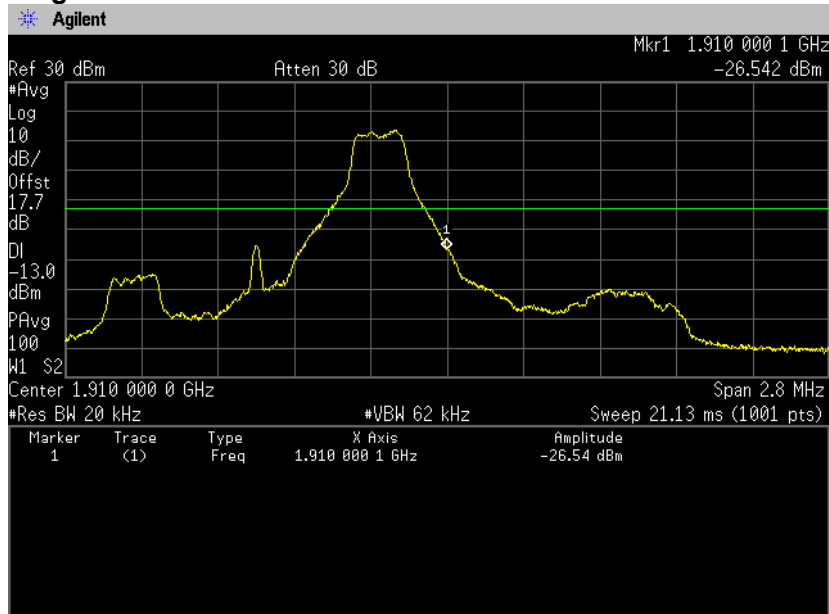



Zacta

16QAM, BW 1.4MHz, RB6-0 Channel: Low

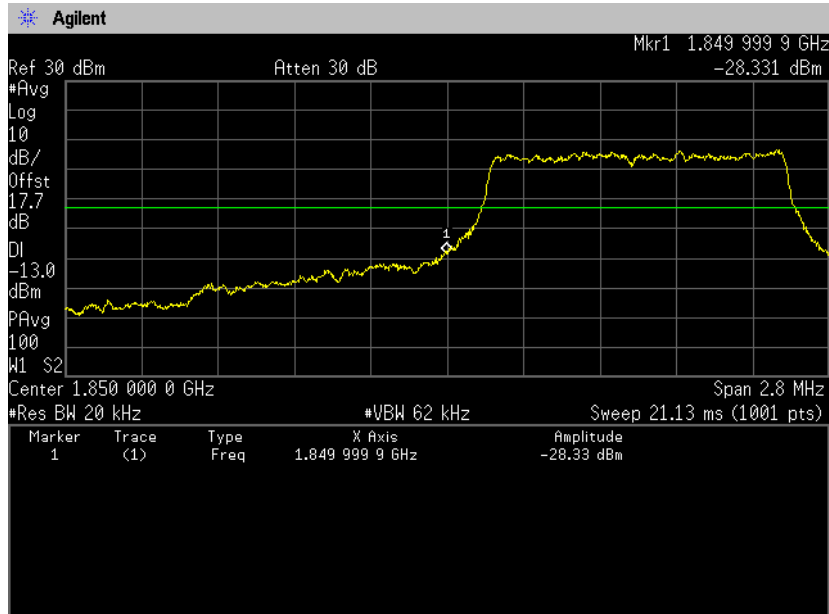

16QAM, BW 1.4MHz, RB6-0 Channel: High

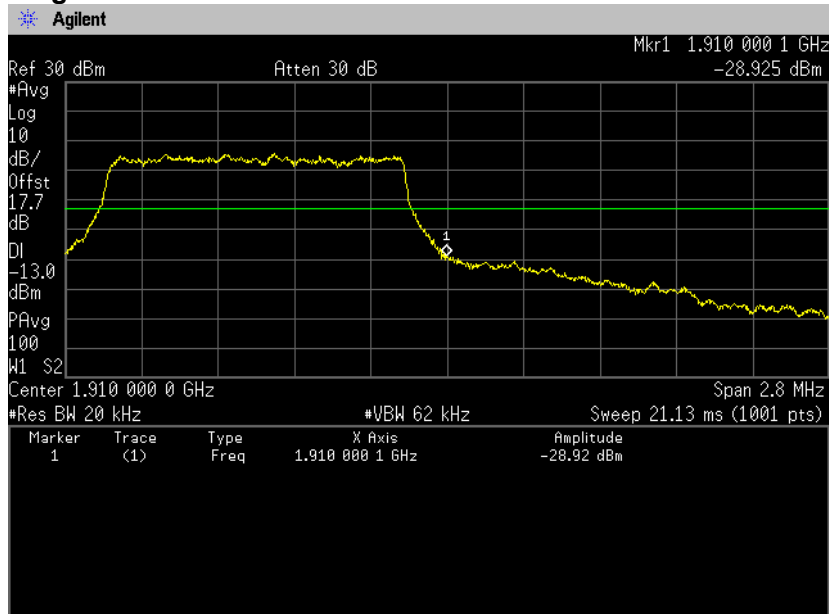

QPSK, BW 3MHz, RB1-0
Channel: Low

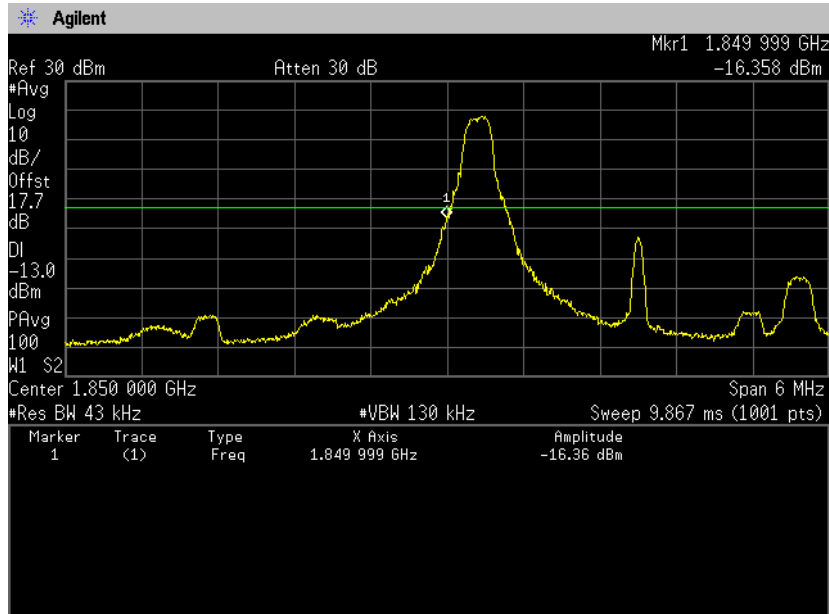

QPSK, BW 3MHz, RB1-14
Channel: High

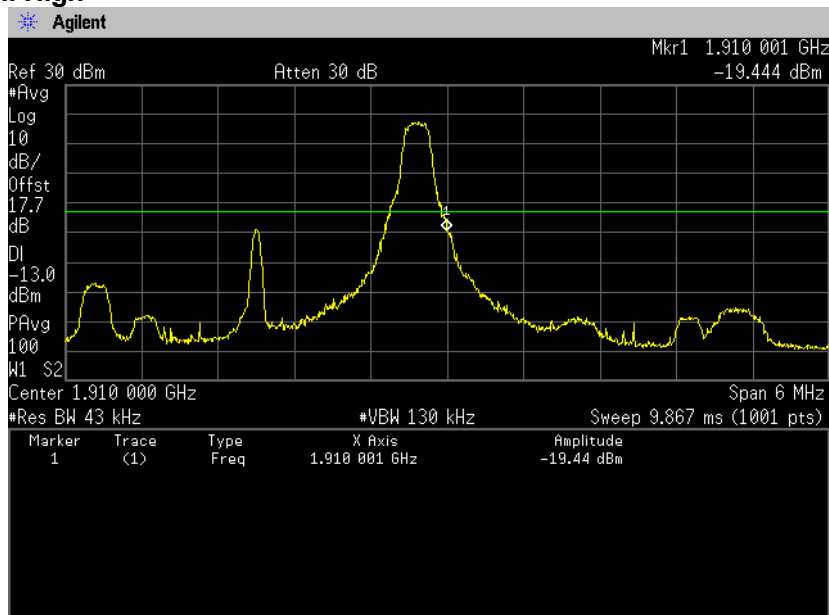



Zacta

QPSK, BW 3MHz, RB15-0
Channel: Low

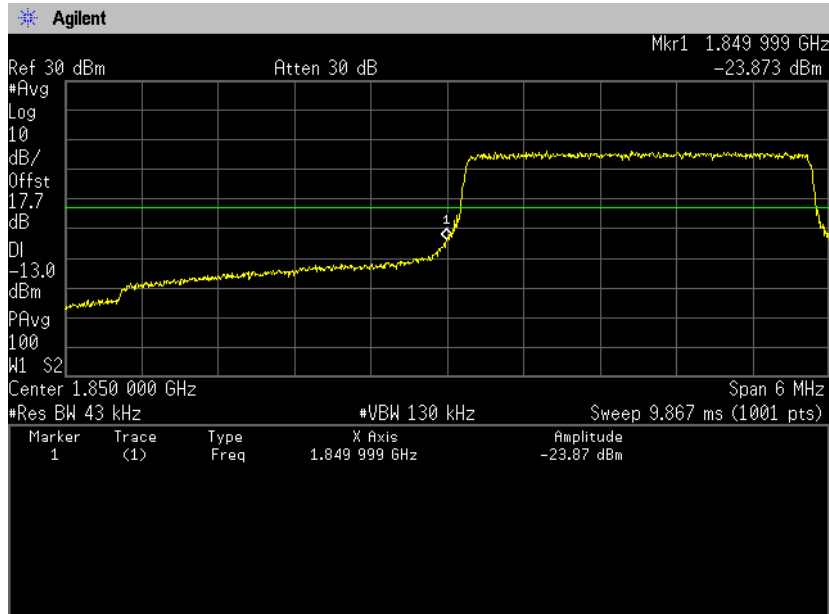

QPSK, BW 3MHz, RB15-0
Channel: High

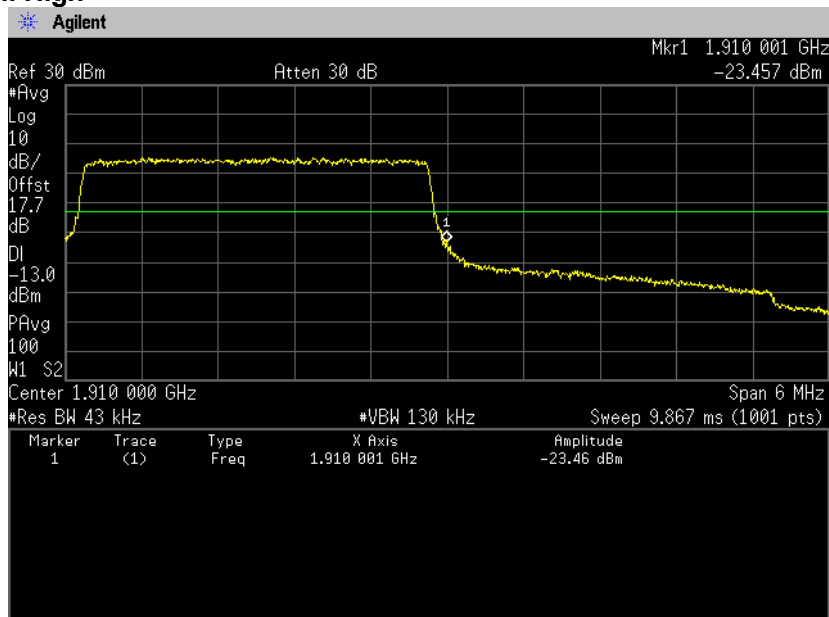



Zacta

16QAM, BW 3MHz, RB1-0
Channel: Low

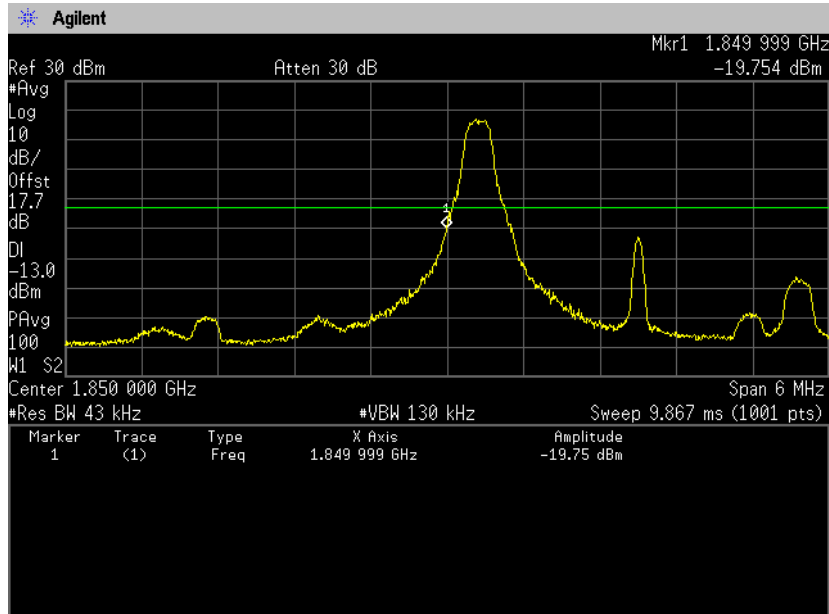

16QAM, BW 3MHz, RB1-14
Channel: High

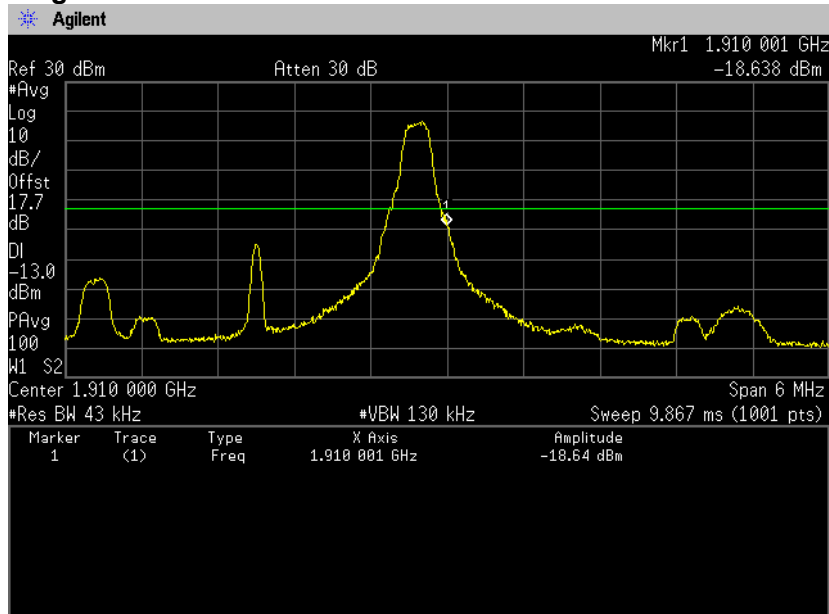



Zacta

16QAM, BW 3MHz, RB15-0
Channel: Low

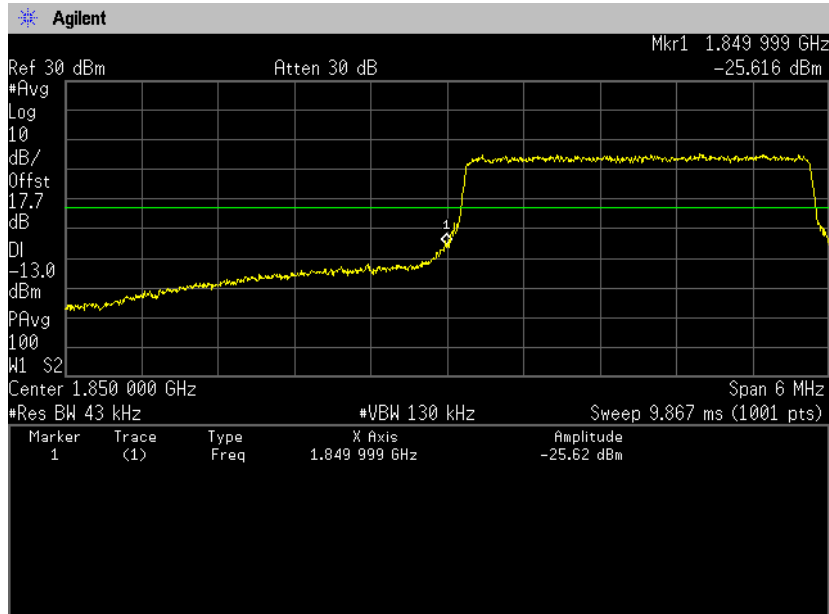

16QAM, BW 3MHz, RB15-0
Channel: High

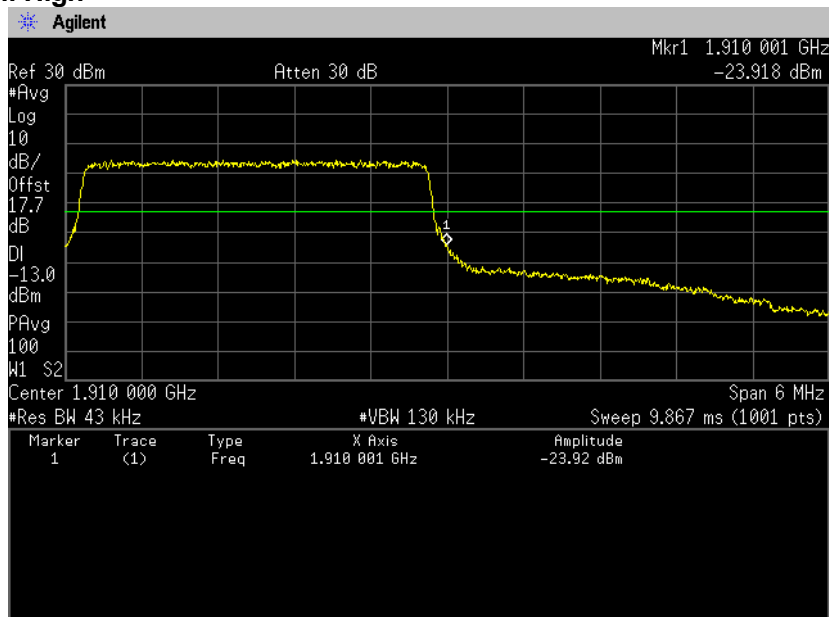



Zacta

QPSK, BW 5MHz, RB1-0 Channel: Low

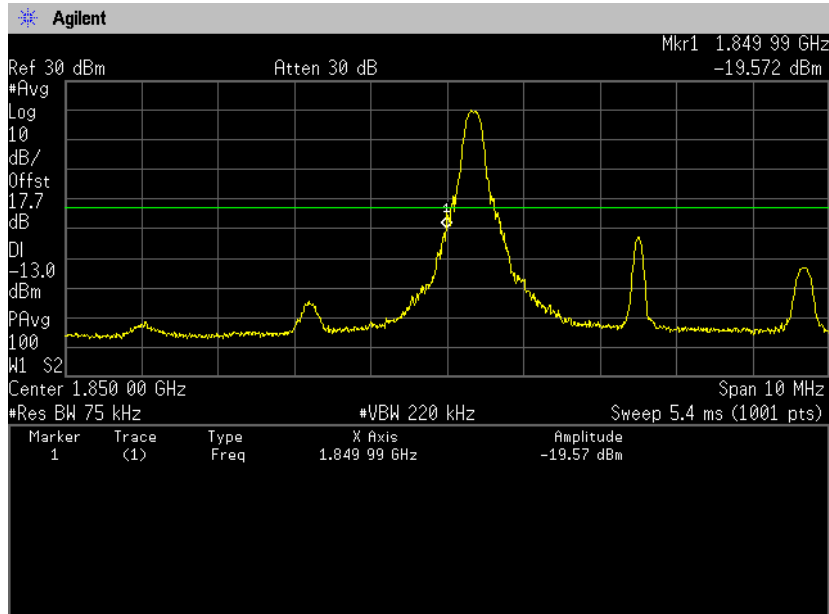

QPSK, BW 5MHz, RB1-24 Channel: High

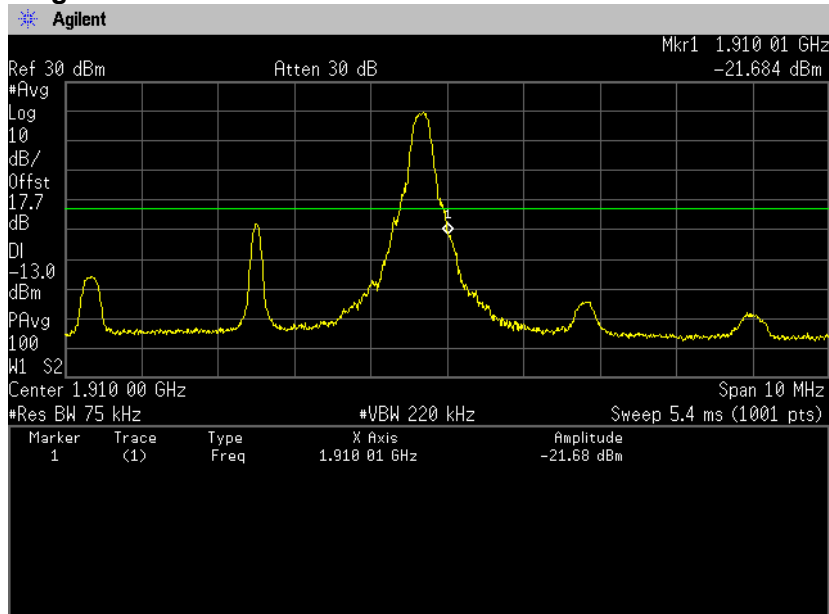



Zacta

QPSK, BW 5MHz, RB25-0 Channel: Low

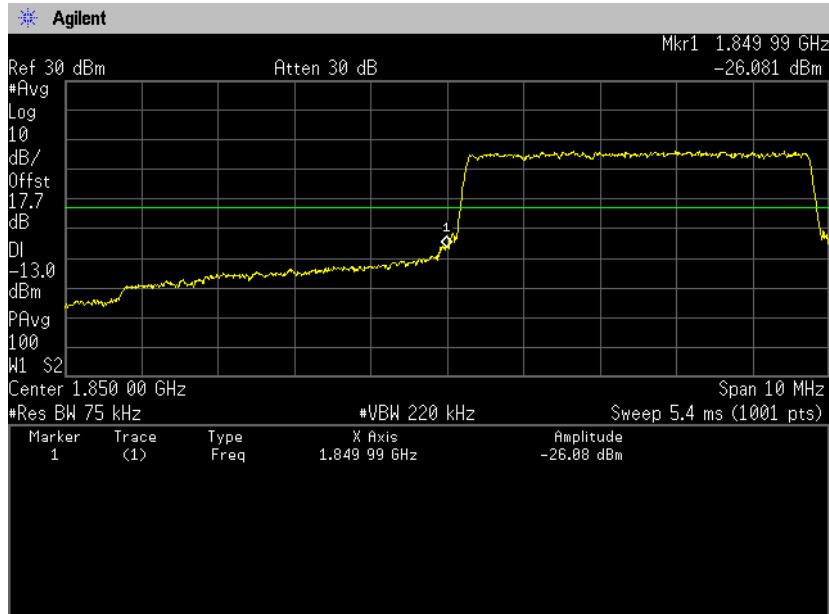

QPSK, BW 5MHz, RB25-0 Channel: High

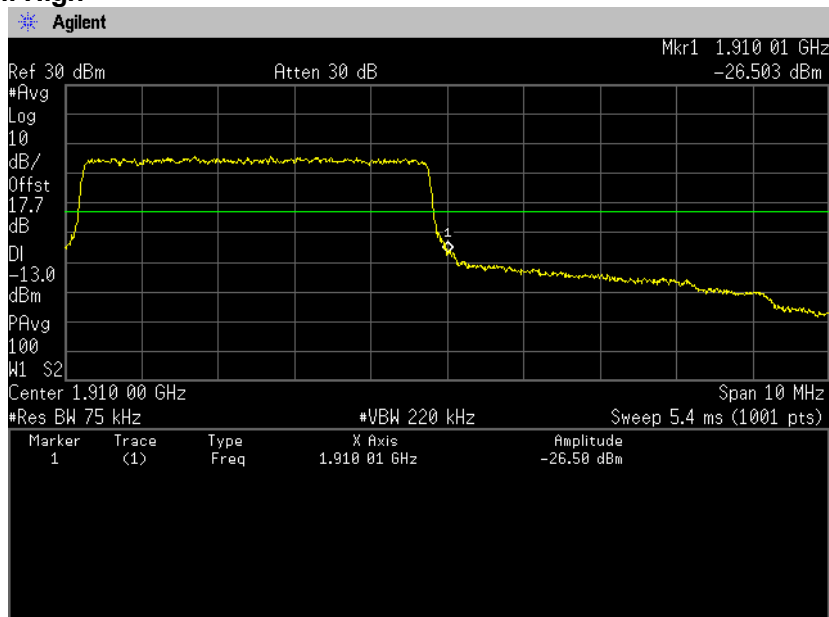

16QAM, BW 5MHz, RB1-0
Channel: Low

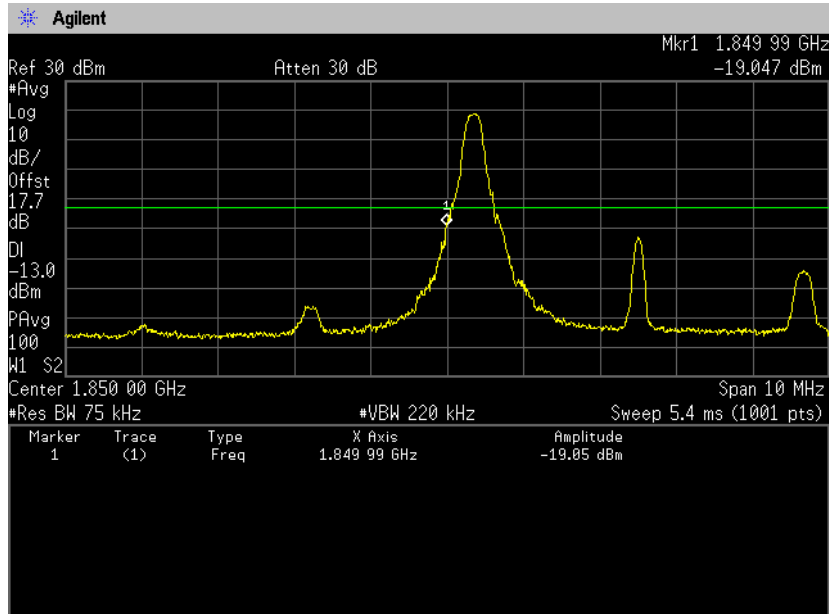

16QAM, BW 5MHz, RB1-24
Channel: High

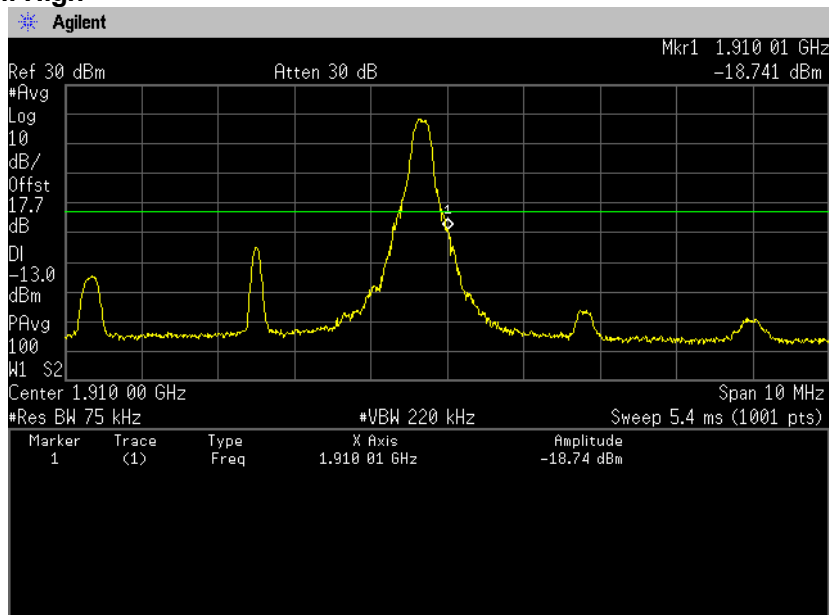



Zacta

16QAM, BW 5MHz, RB25-0 Channel: Low

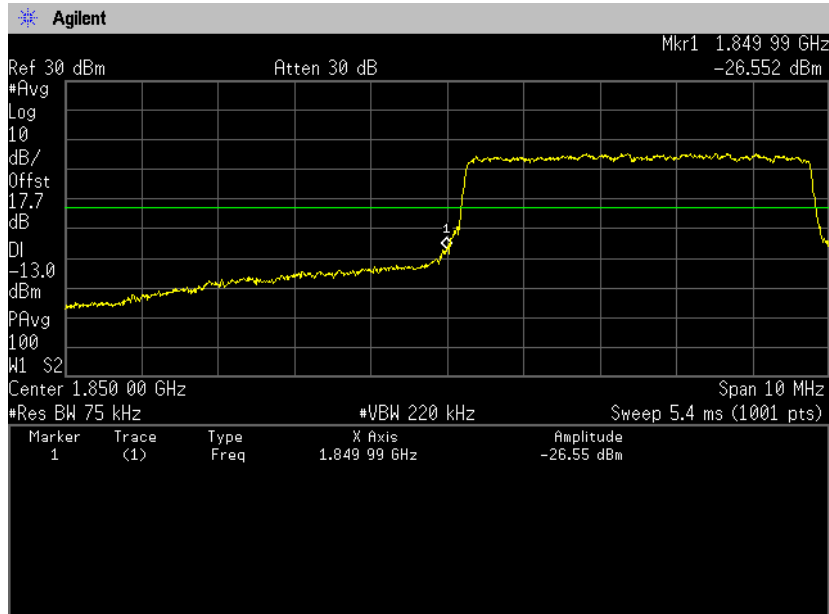

16QAM, BW 5MHz, RB25-0 Channel: High

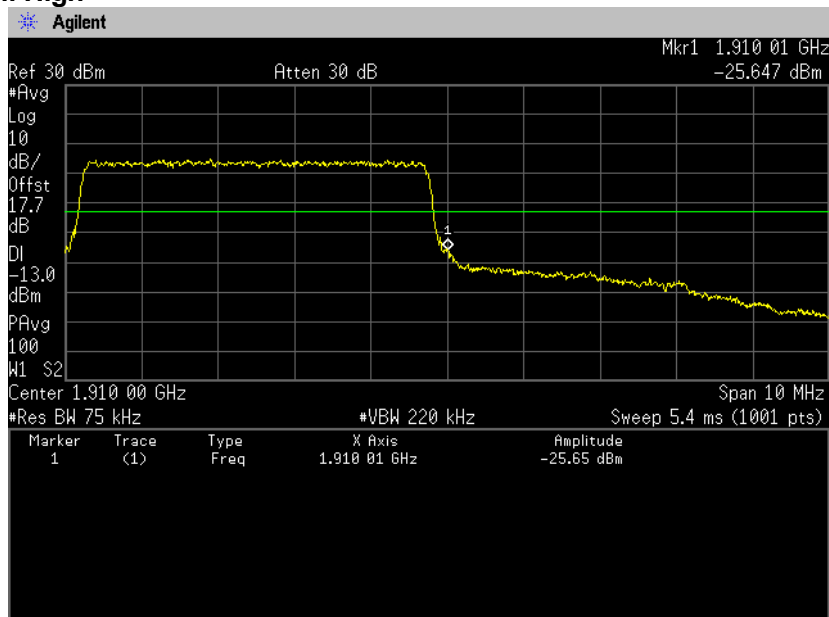



Zacta

QPSK, BW 10MHz, RB1-0
Channel: Low

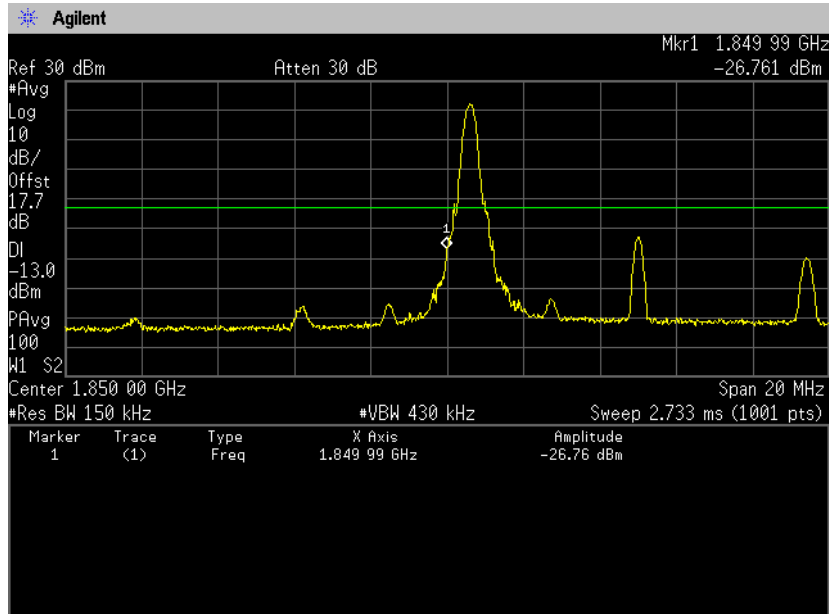

QPSK, BW 10MHz, RB1-49
Channel: High

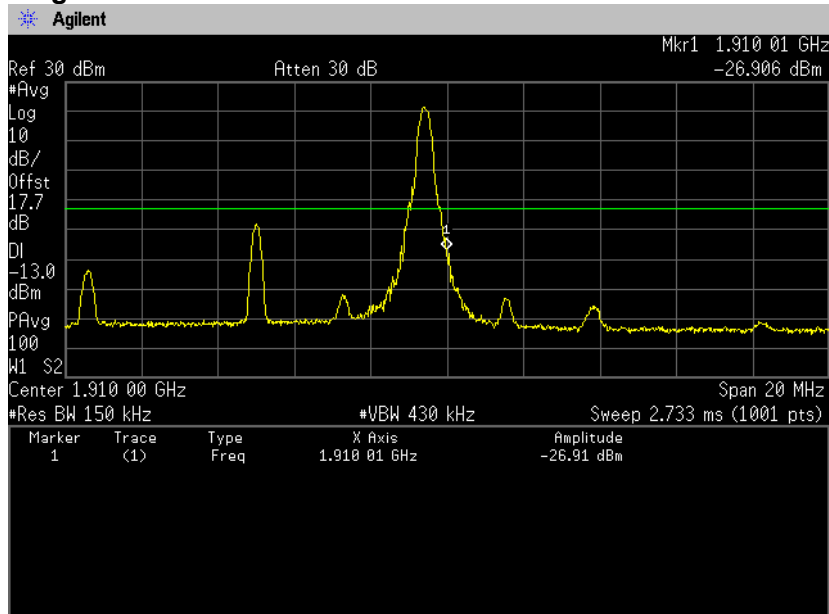

QPSK, BW 10MHz, RB50-0
Channel: Low

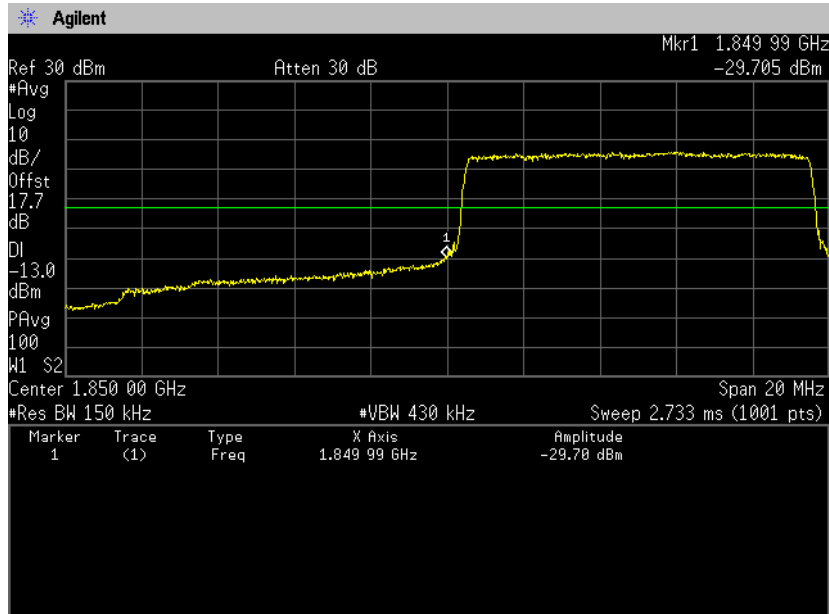

QPSK, BW 10MHz, RB50-0
Channel: High

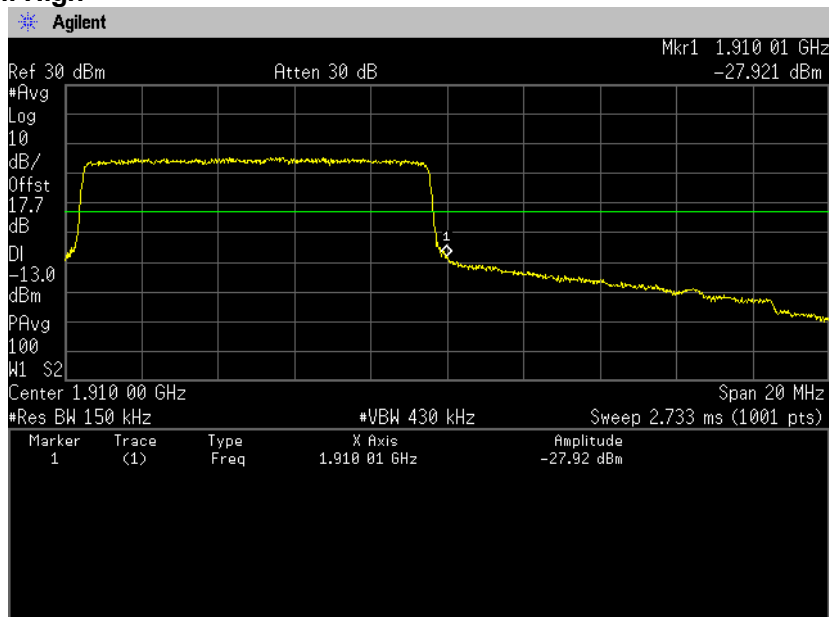



Zacta

16QAM, BW 10MHz, RB1-0 Channel: Low

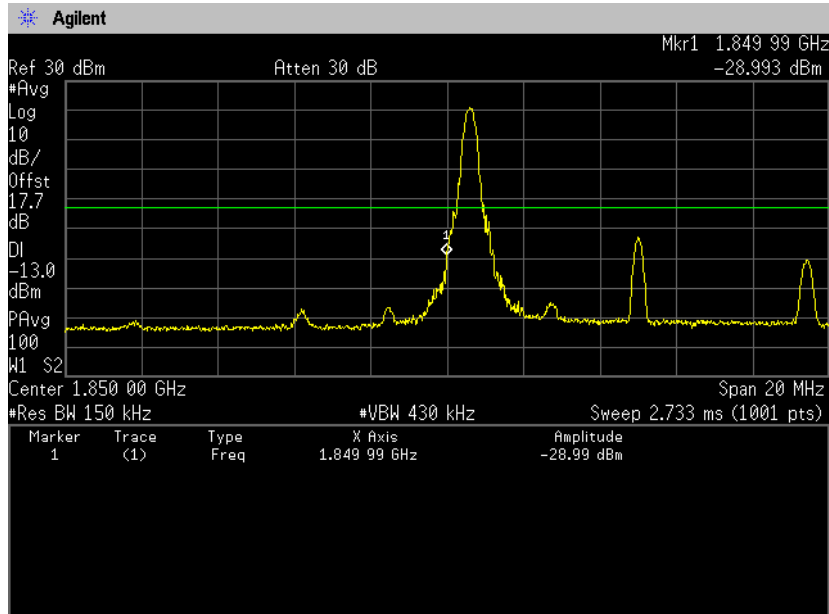

16QAM, BW 10MHz, RB1-49 Channel: High

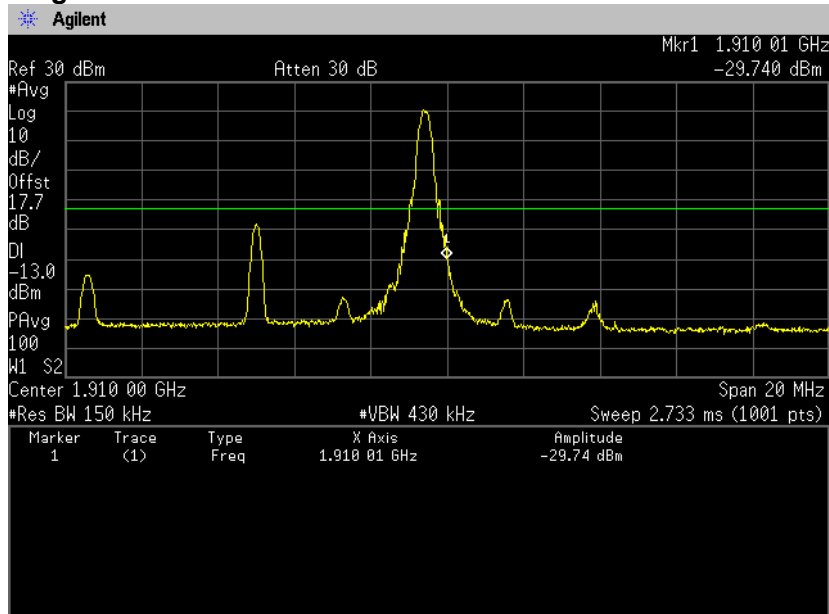



Zacta

16QAM, BW 10MHz, RB50-0
Channel: Low

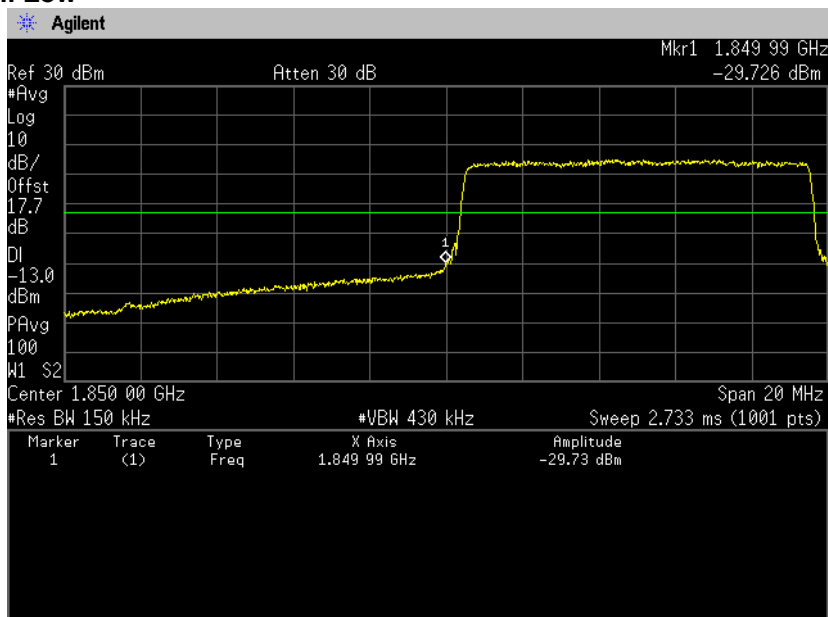

16QAM, BW 10MHz, RB50-0
Channel: High

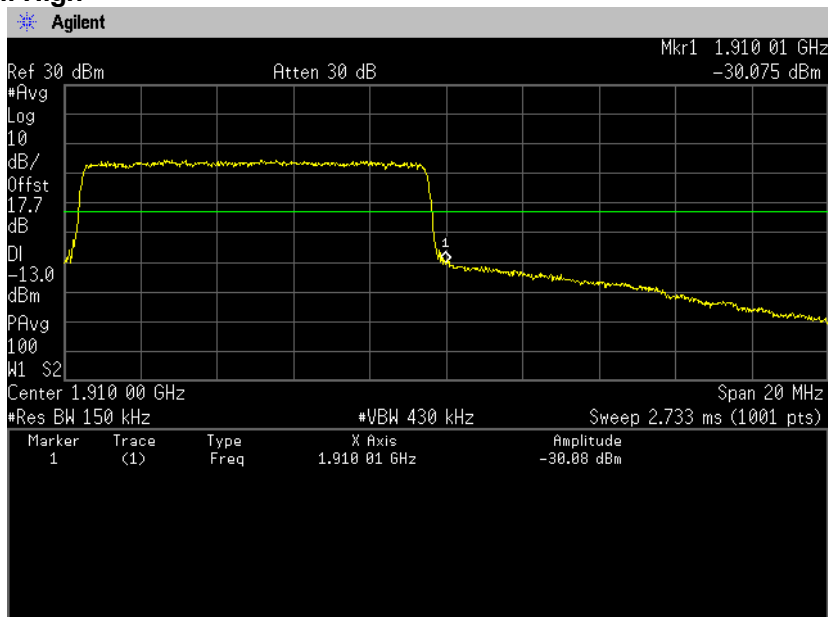



Zacta

QPSK, BW 15MHz, RB1-0 Channel: Low

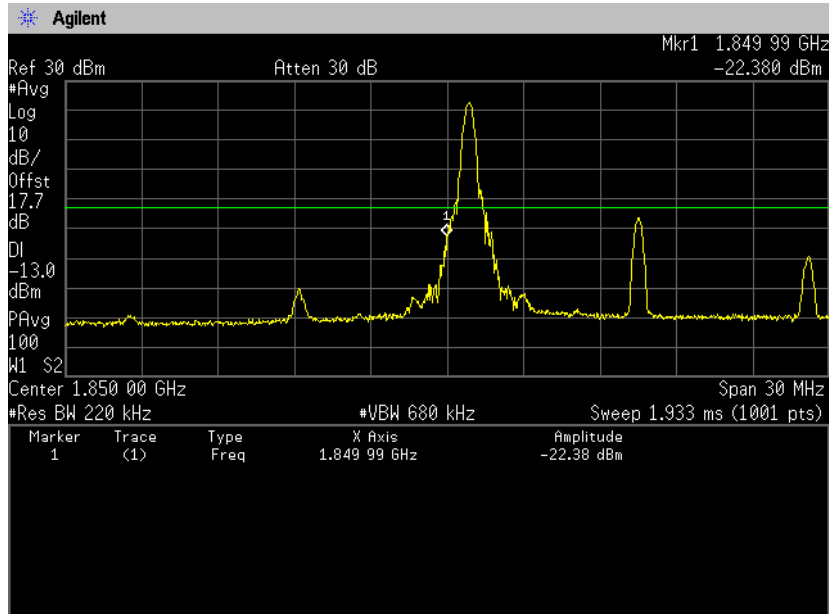

QPSK, BW 15MHz, RB1-74 Channel: High

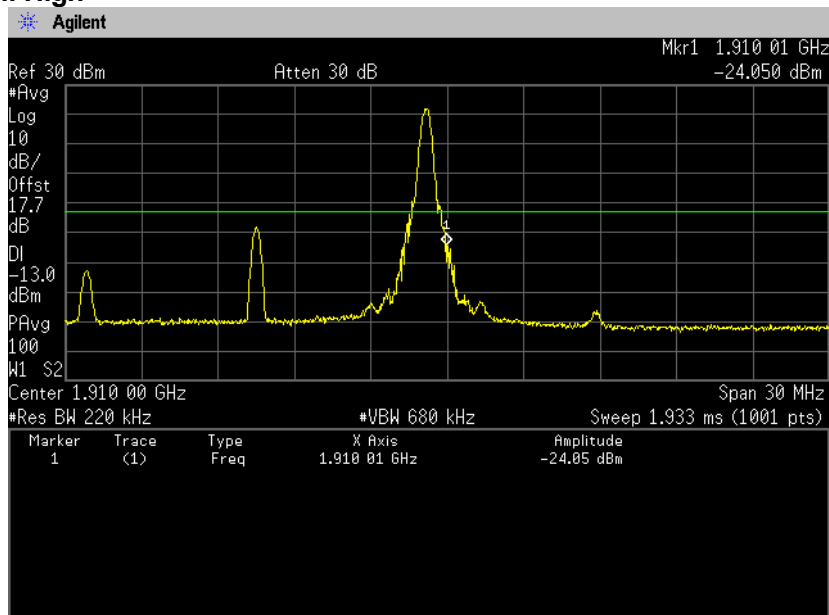



Zacta

QPSK, BW 15MHz, RB75-0 Channel: Low

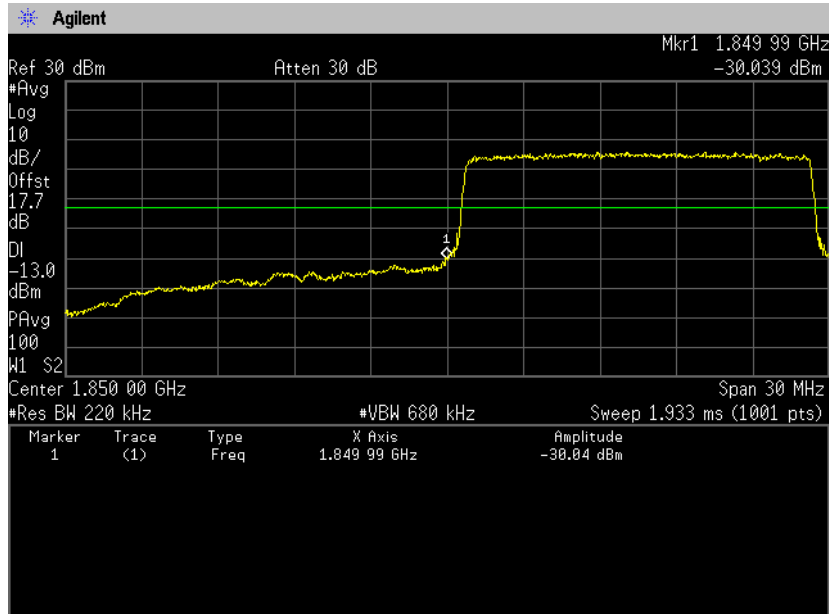

QPSK, BW 15MHz, RB75-0 Channel: High

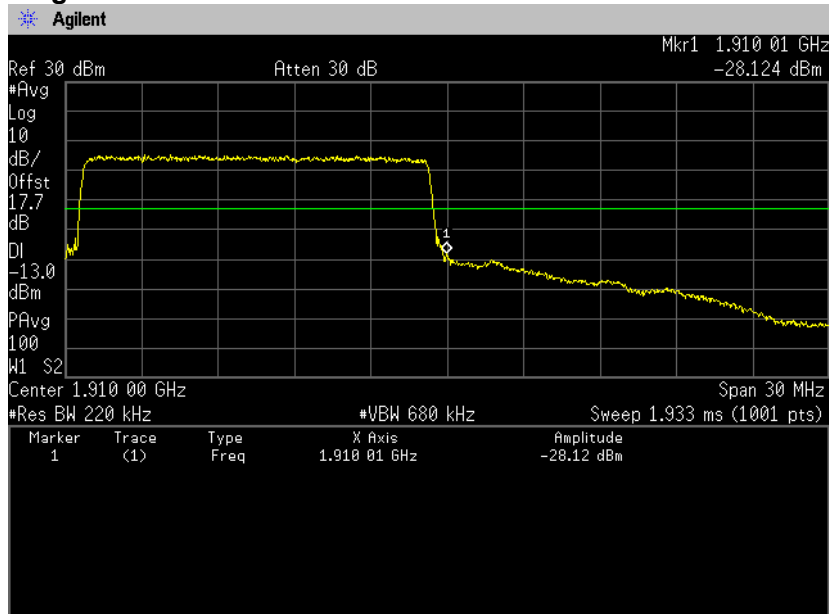



Zacta

16QAM, BW 15MHz, RB1-0 Channel: Low

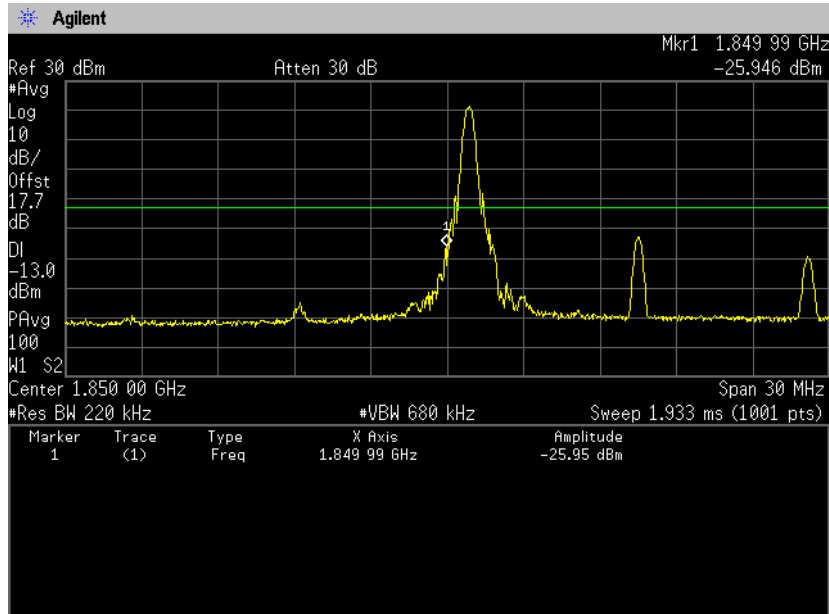

16QAM, BW 15MHz, RB1-74 Channel: High

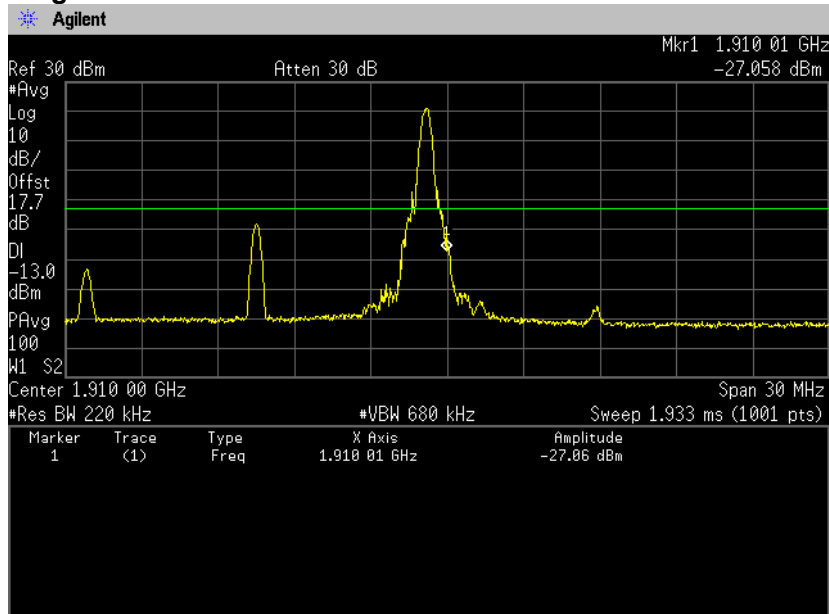



Zacta

16QAM, BW 15MHz, RB75-0
Channel: Low

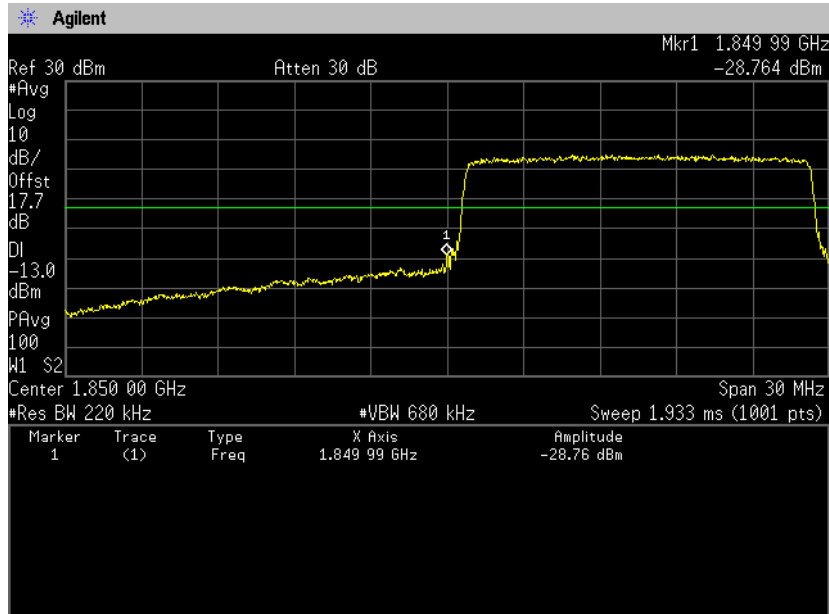

16QAM, BW 15MHz, RB75-0
Channel: High

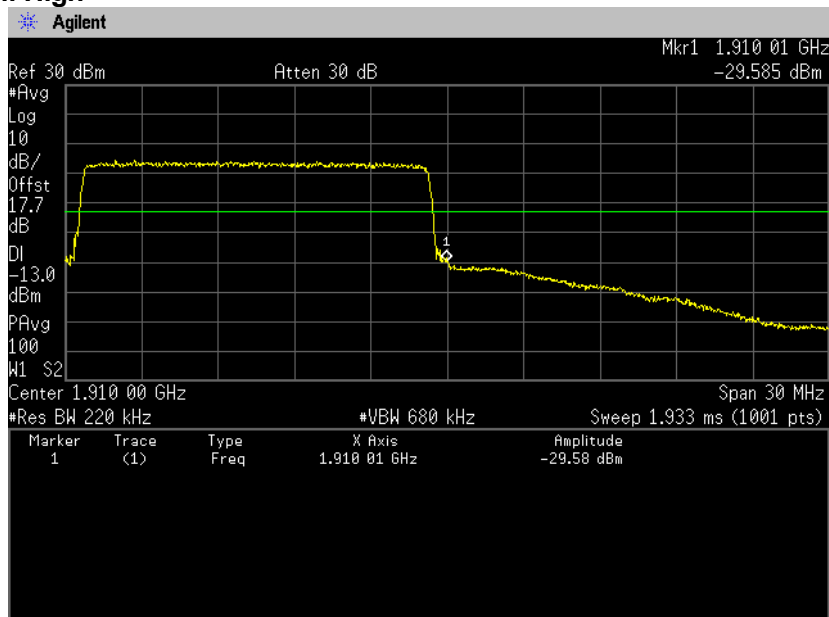



Zacta

QPSK, BW 20MHz, RB1-0
Channel: Low

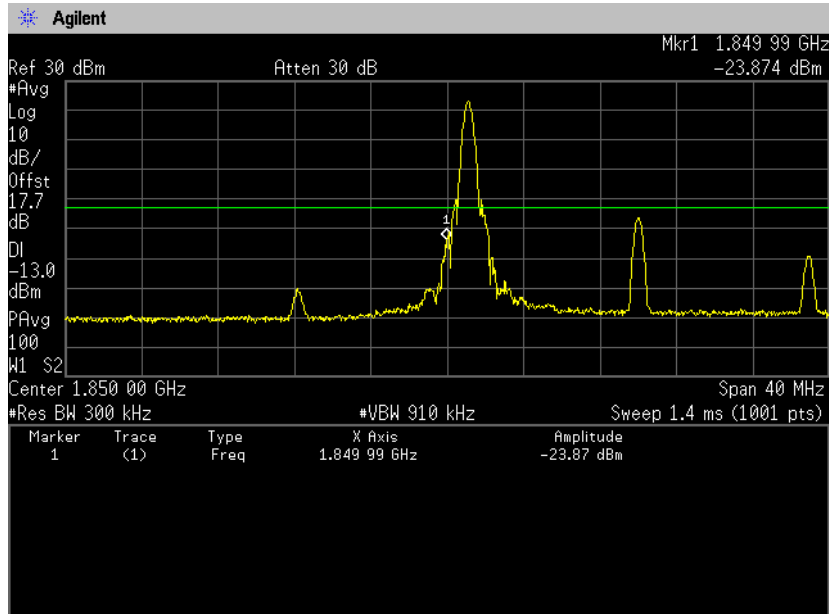

QPSK, BW 20MHz, RB1-99
Channel: High

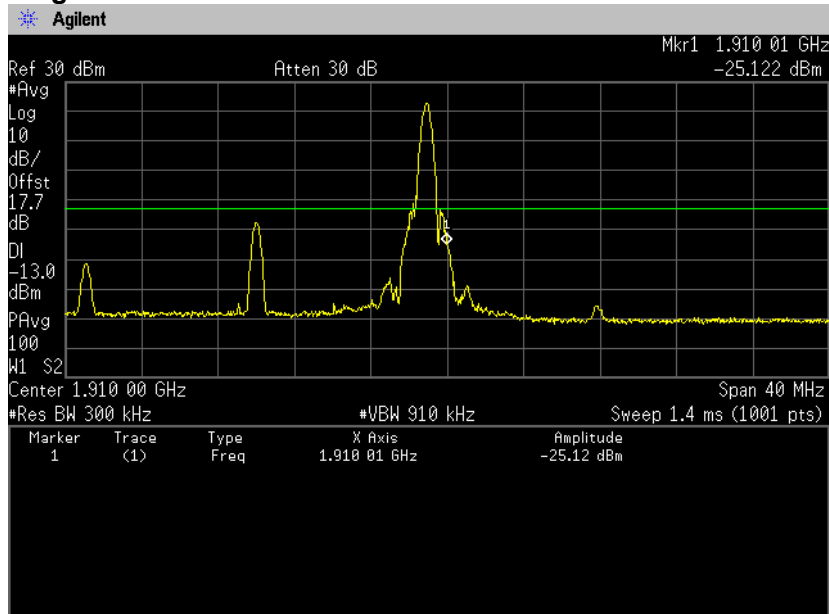

QPSK, BW 20MHz, RB100-0
Channel: Low

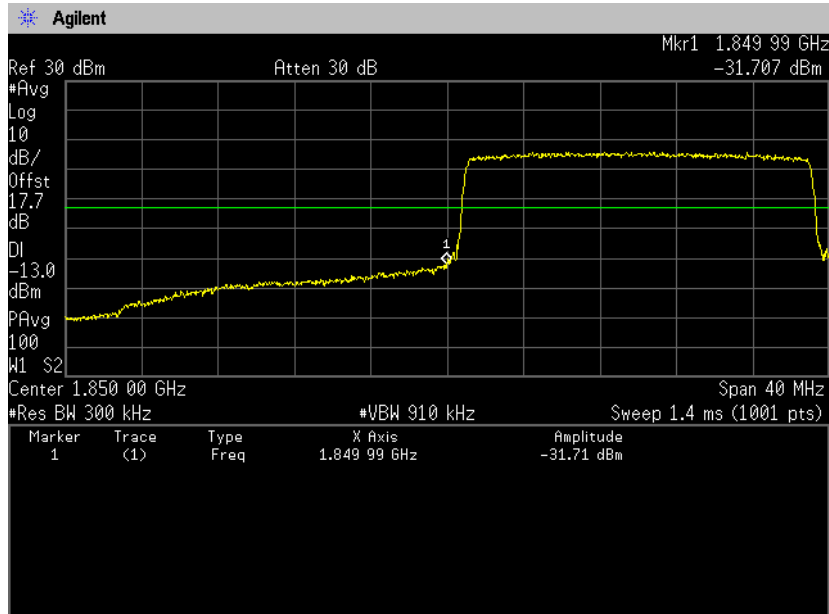

QPSK, BW 20MHz, RB100-0
Channel: High

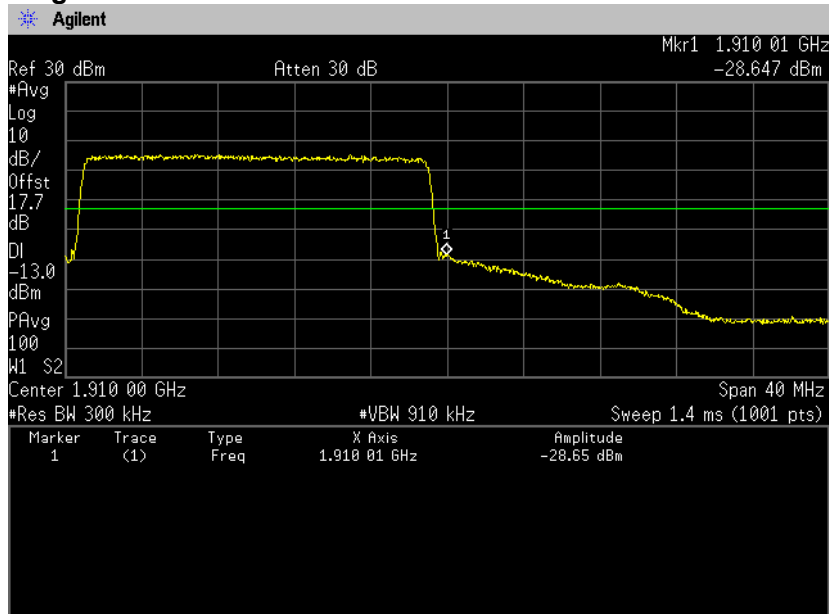



Zacta

16QAM, BW 20MHz, RB1-0 Channel: Low

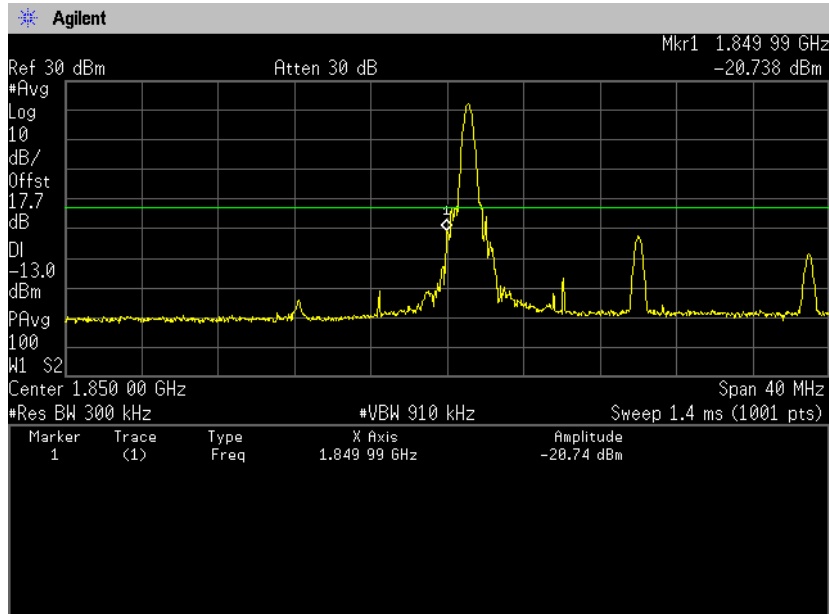

16QAM, BW 20MHz, RB1-99 Channel: High

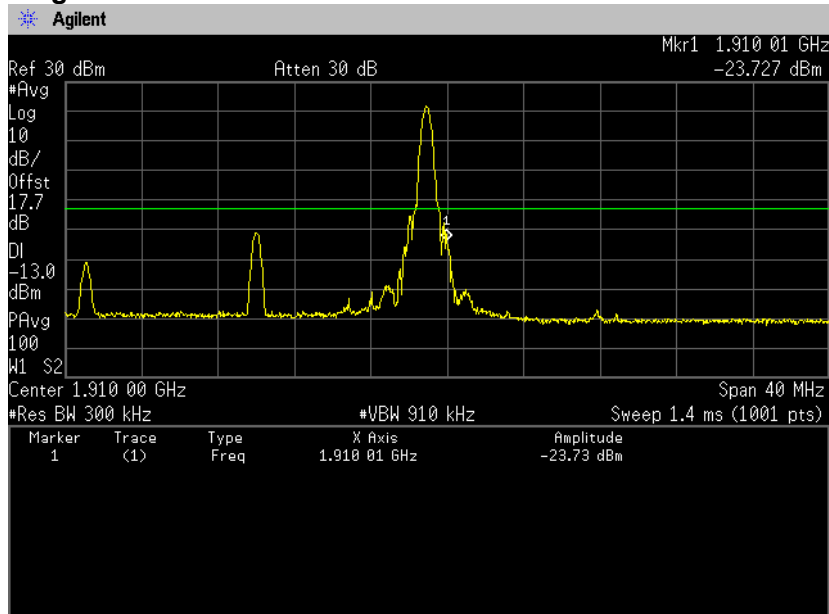



Zacta

16QAM, BW 20MHz, RB100-0 Channel: Low

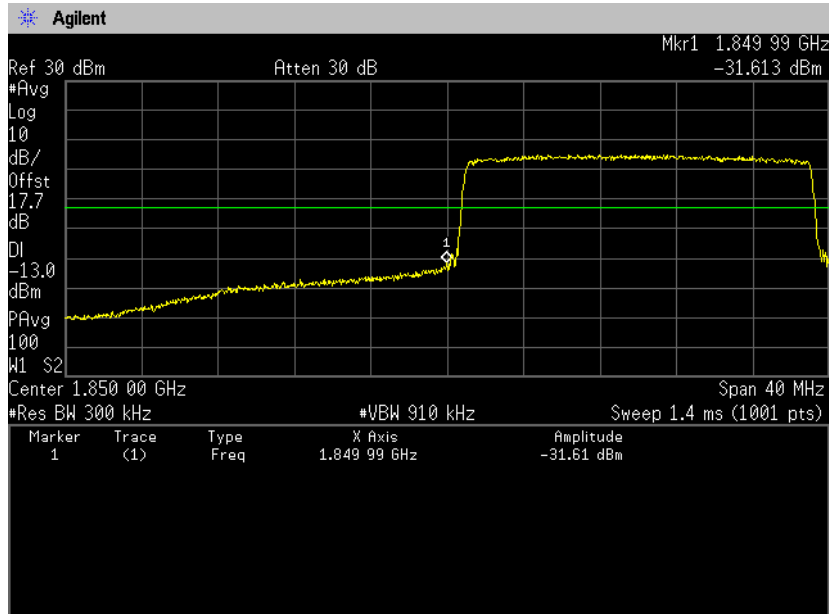

16QAM, BW 20MHz, RB100-0 Channel: High

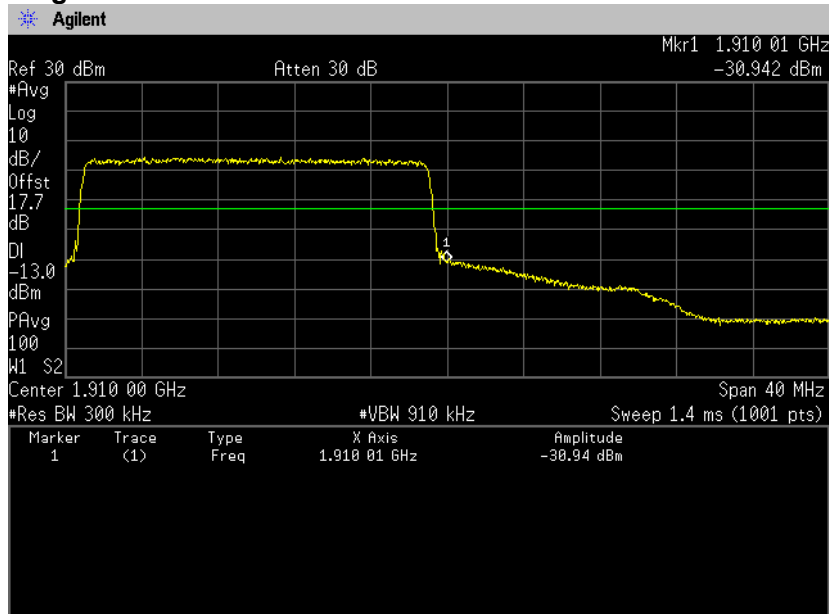

(Spurious Emissions)

Note: Conducted spurious test was measured in the worst case of conducted output power.

**QPSK, BW 10MHz, RB1-25
Channel: 18650
30MHz-5GHz**

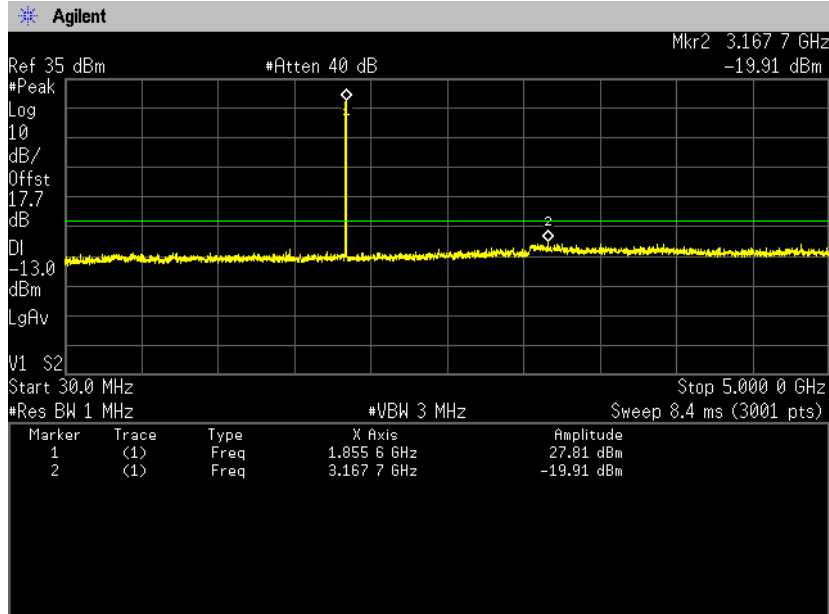

5GHz-10GHz

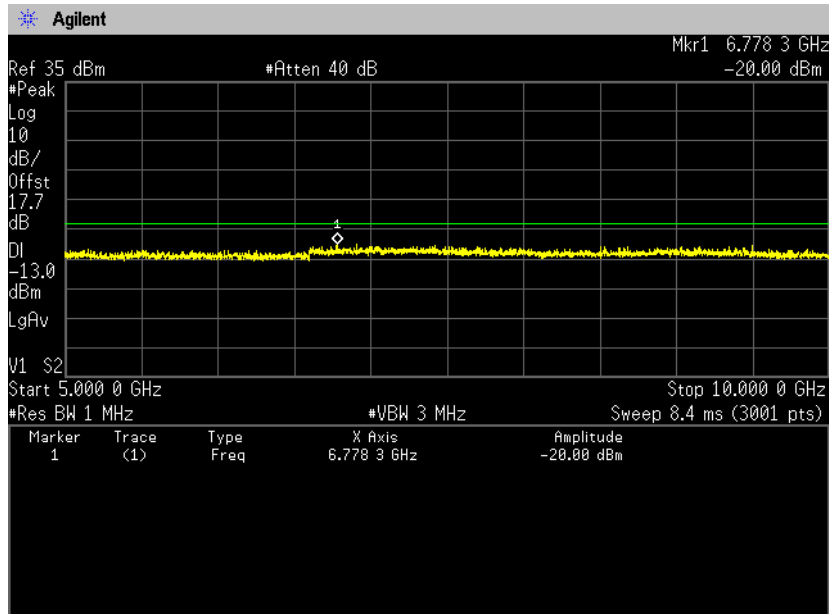



Zacta

10GHz-15GHz

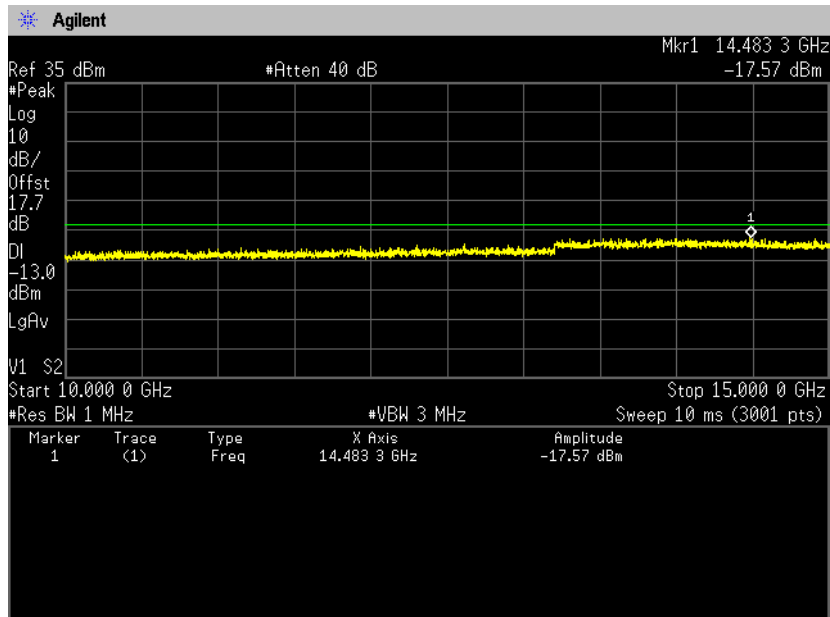

15GHz-20GHz

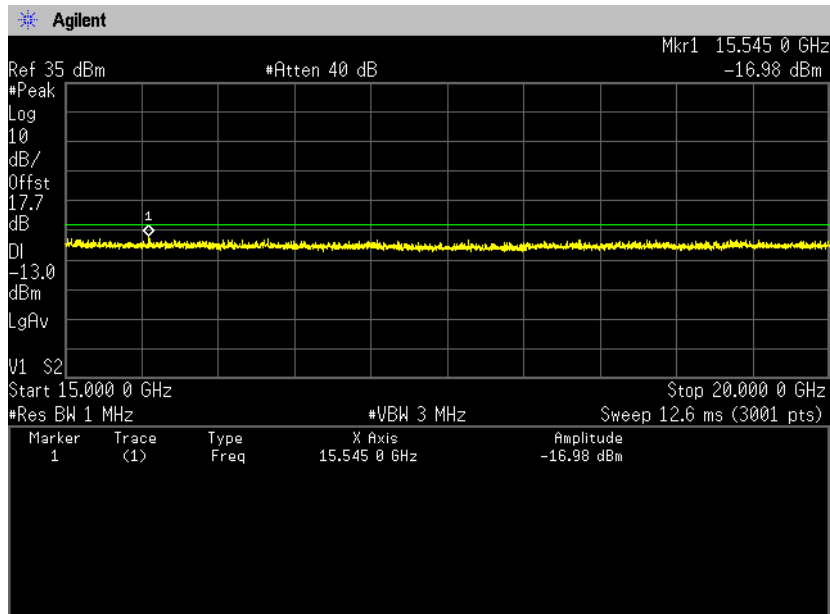



Zacta

**Channel: 18900
30MHz-5GHz**

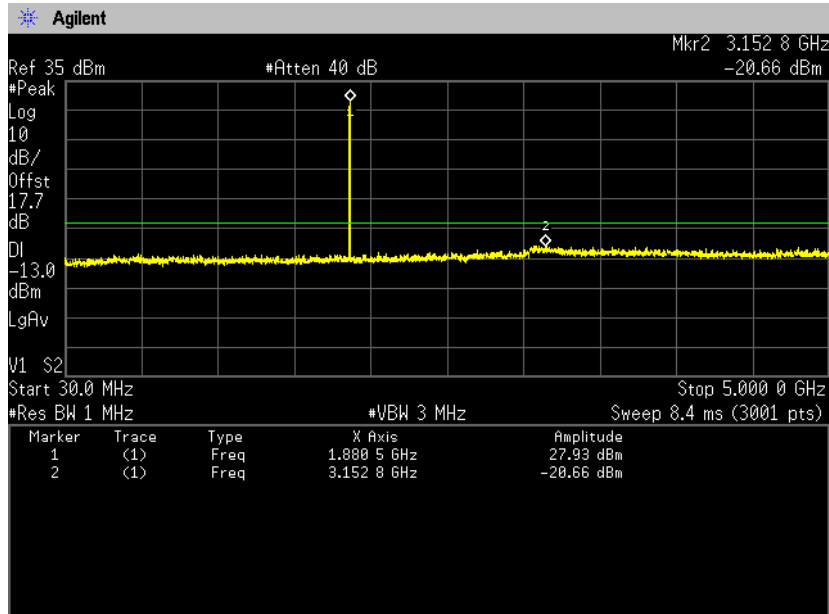

5GHz-10GHz

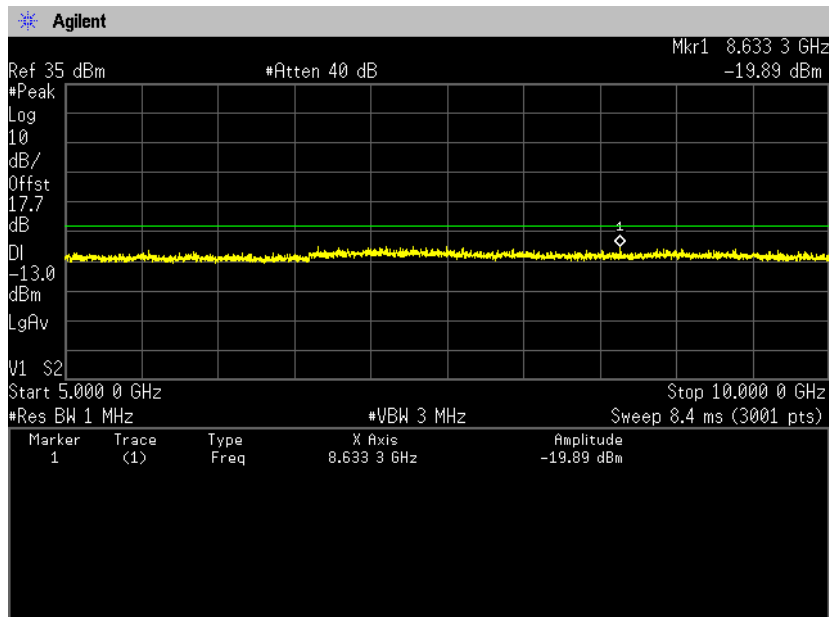



Zacta

10GHz-15GHz

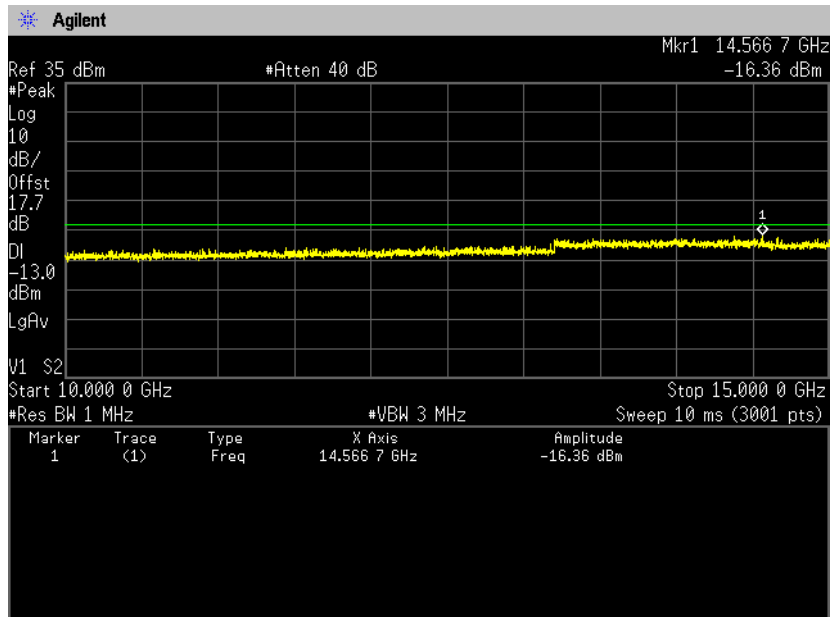

15GHz-20GHz

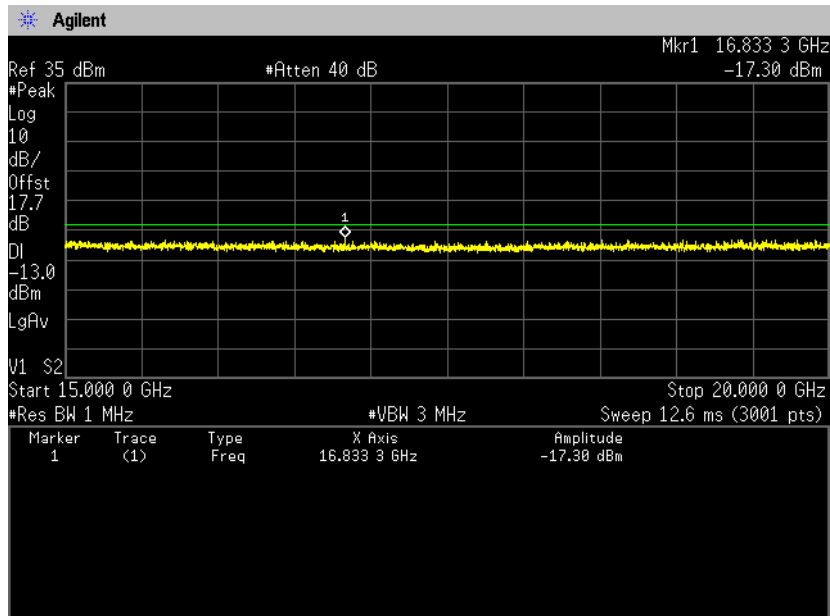



Zacta

**Channel: 19150
30MHz-5GHz**

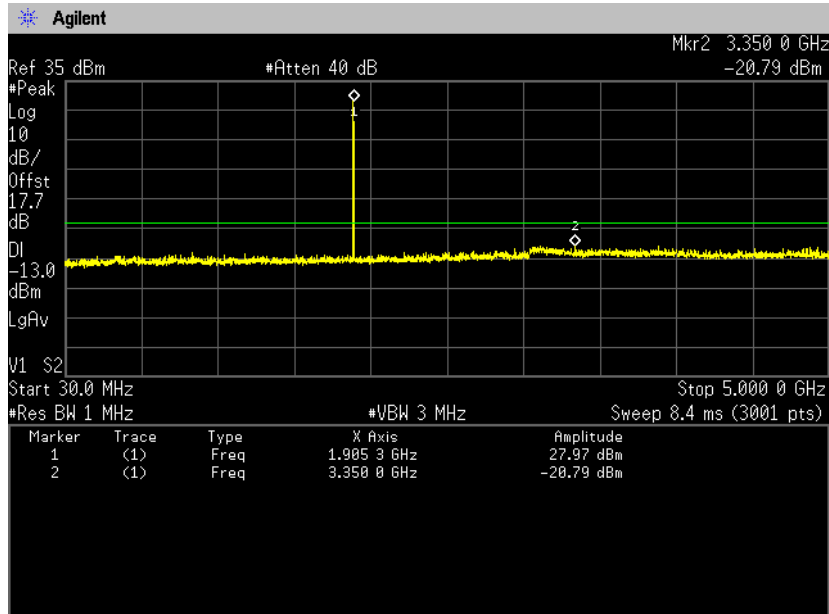

5GHz-10GHz

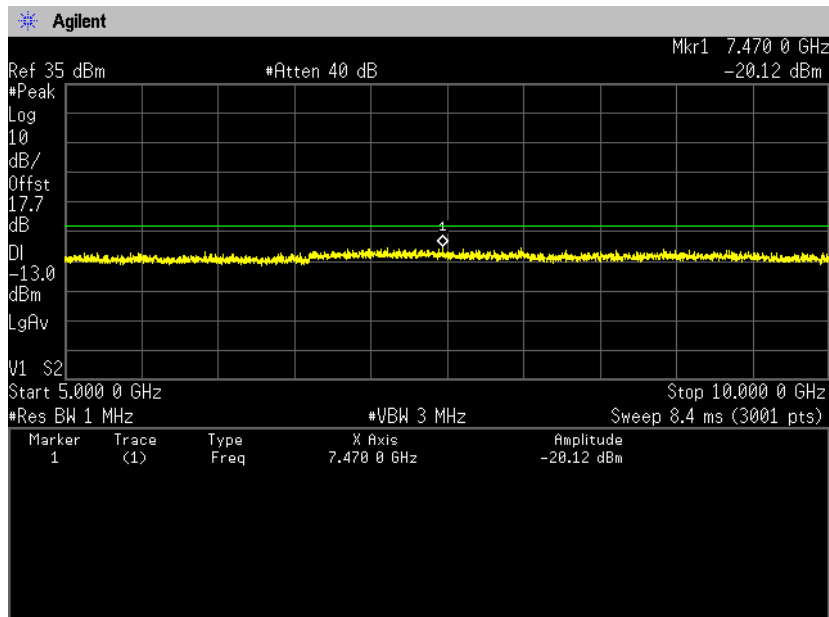



Zacta

10GHz-15GHz

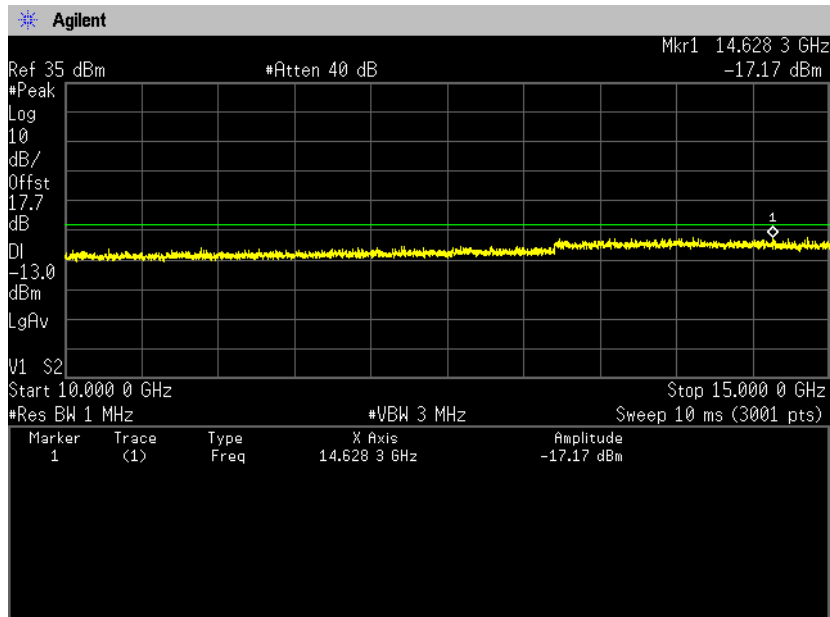

15GHz-20GHz

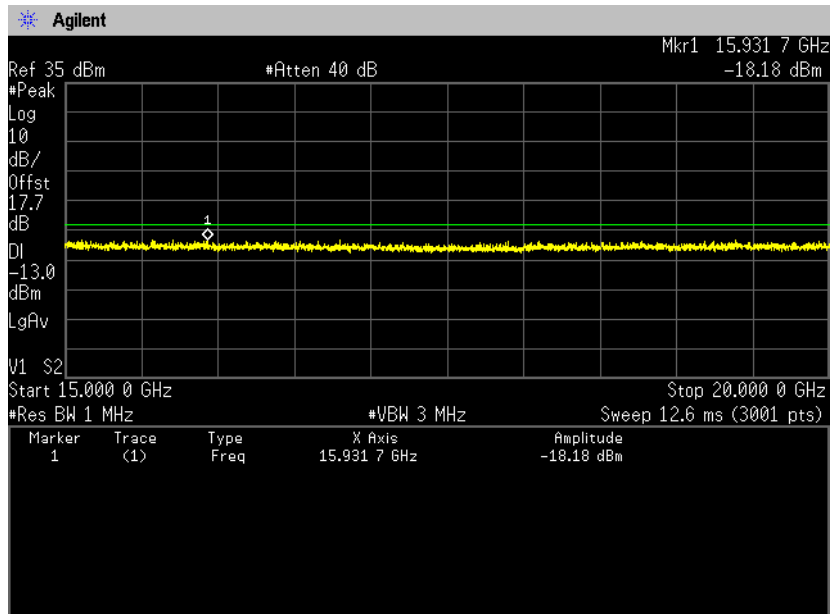



Zacta

16QAM, BW 5MHz, RB1-24
Channel: 18625
30MHz-5GHz

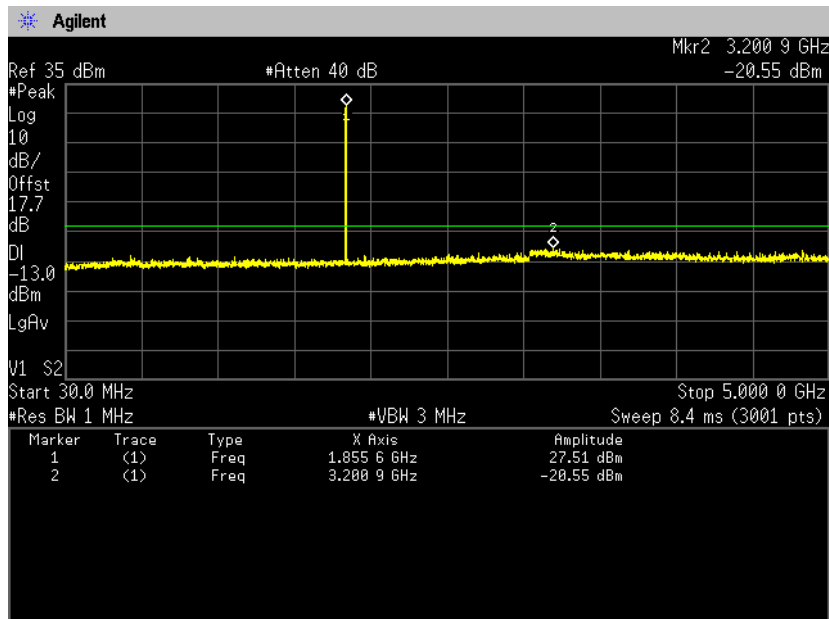

5GHz-10GHz

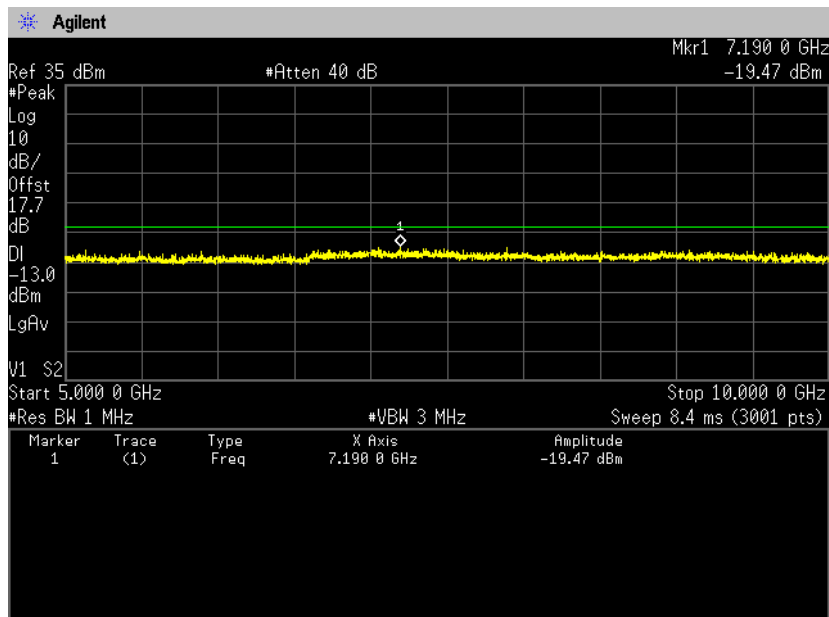



Zacta

10GHz-15GHz

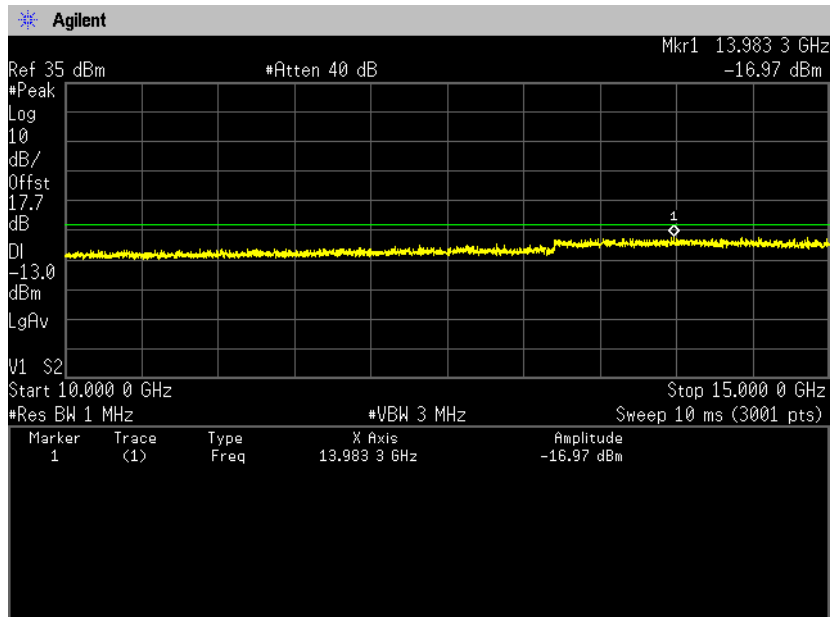

15GHz-20GHz

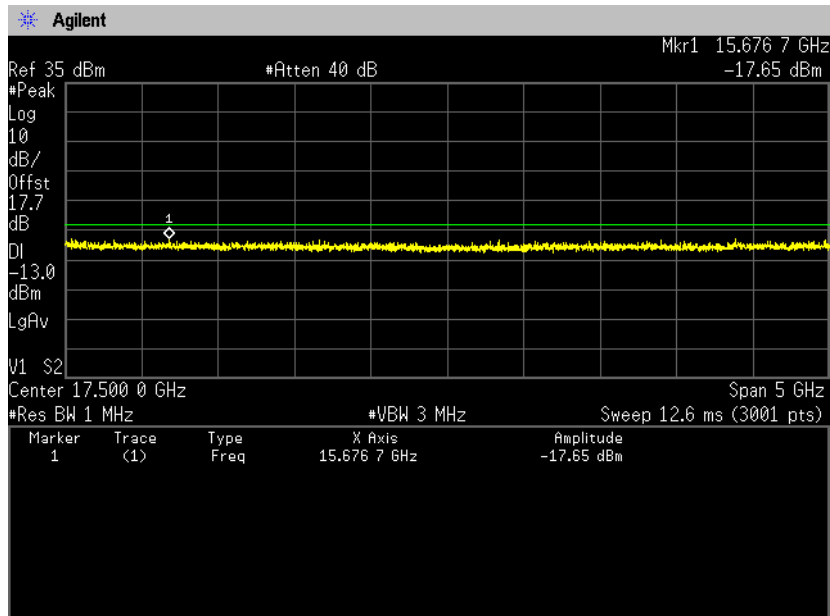

**Channel: 18900
30MHz-5GHz**

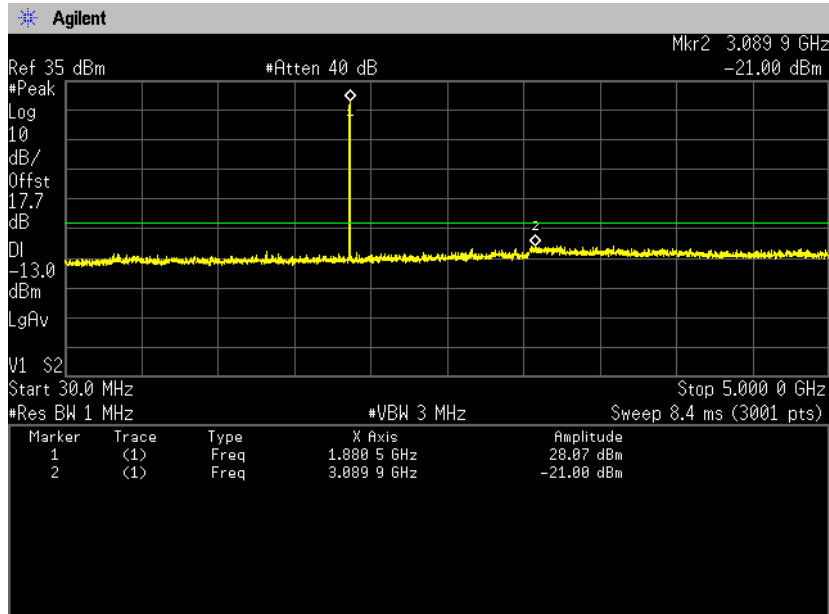

5GHz-10GHz

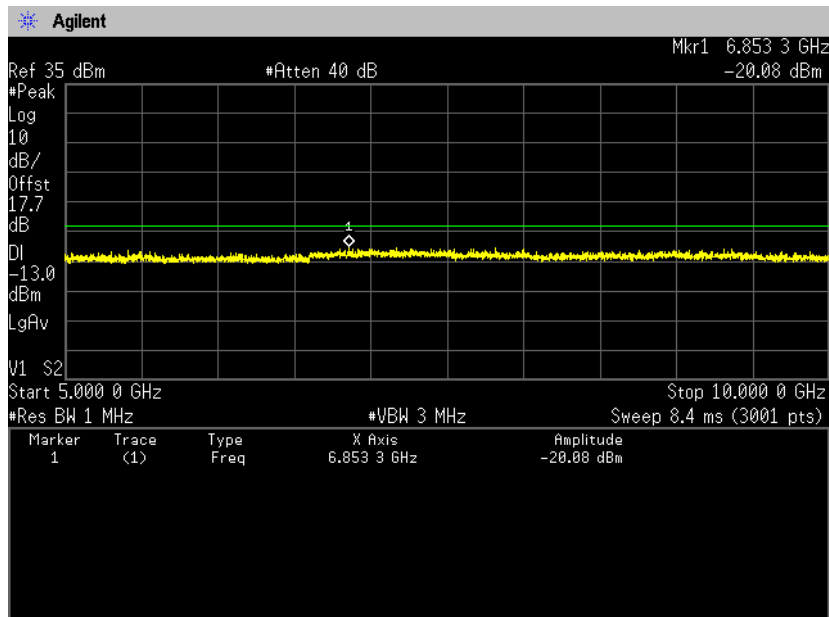



Zacta

10GHz-15GHz

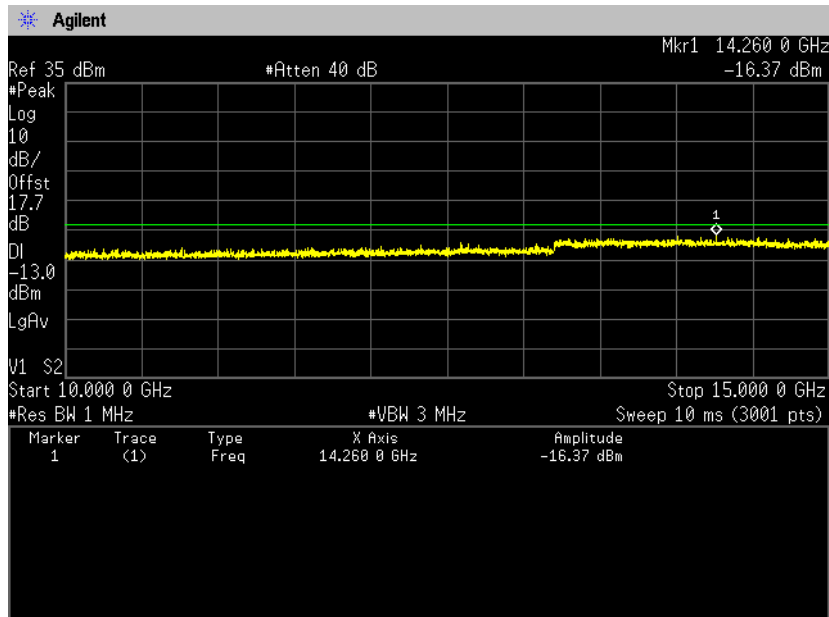

15GHz-20GHz

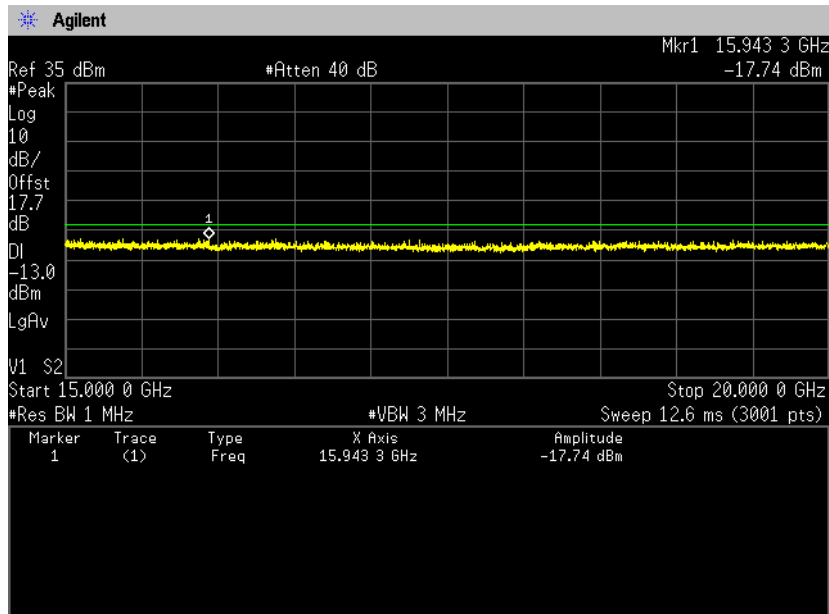



Zacta

**Channel: 19175
30MHz-5GHz**

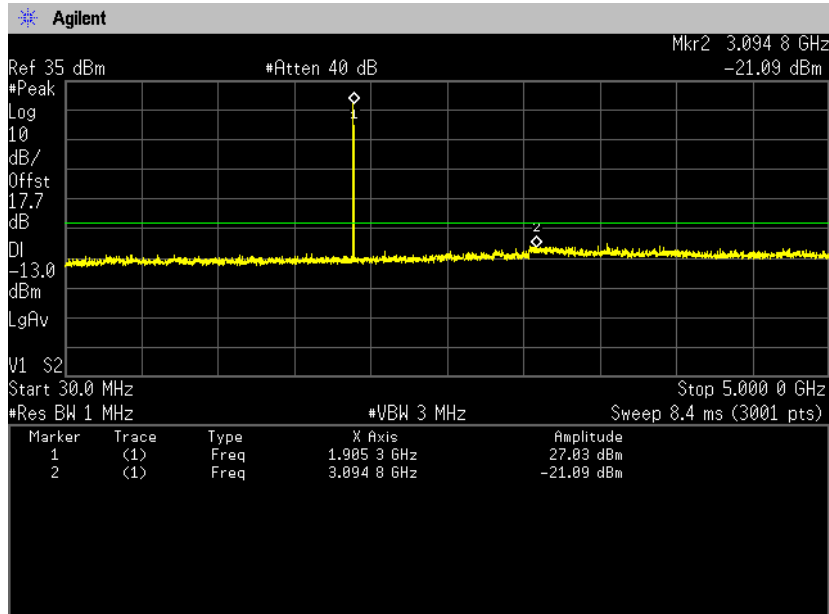

5GHz-10GHz

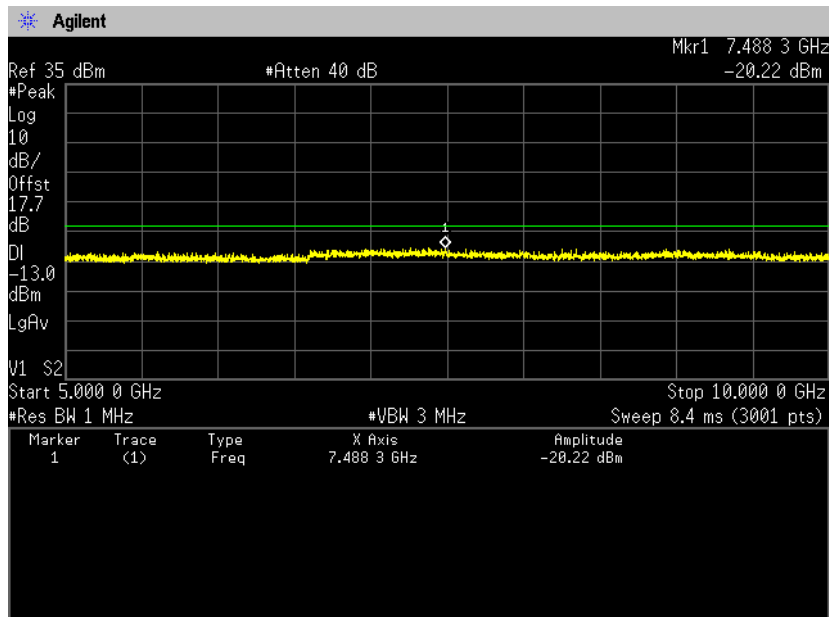



Zacta

10GHz-15GHz

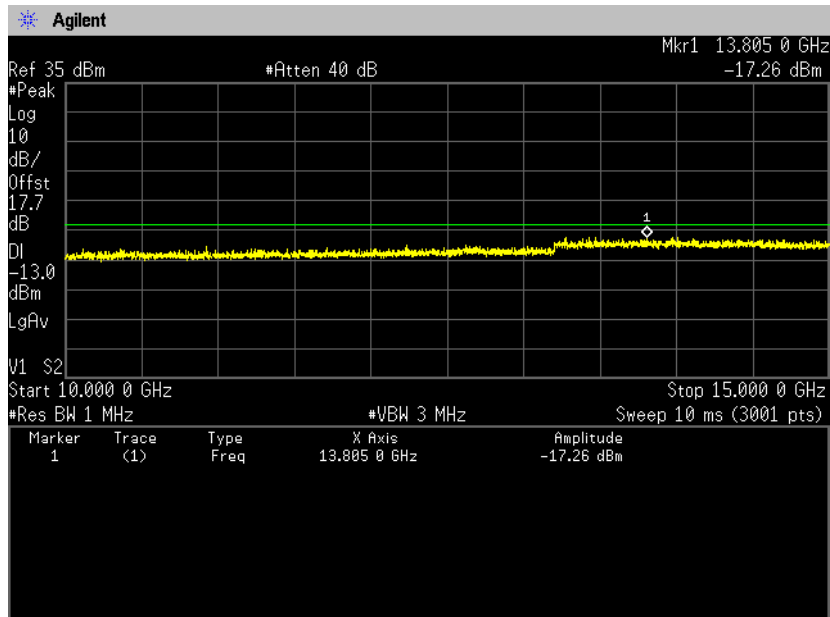

15GHz-20GHz

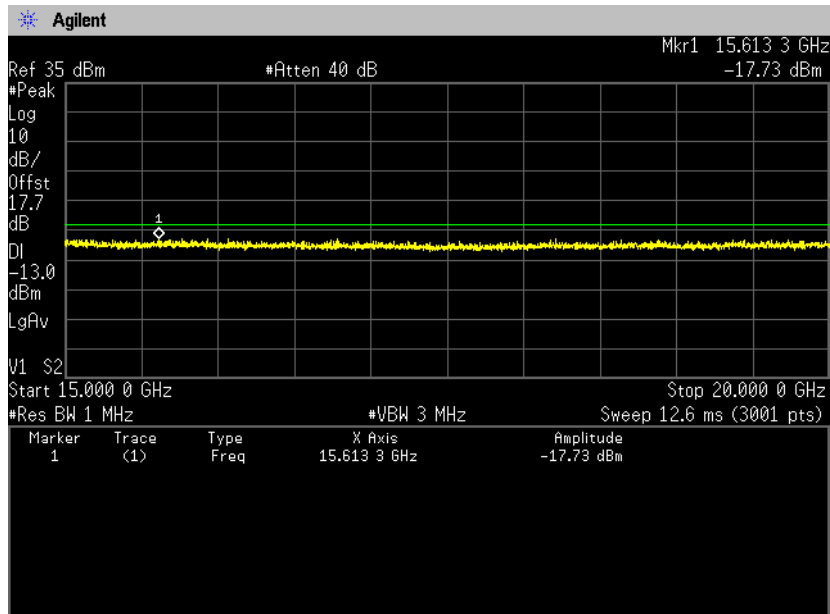

9. Radiated Emissions and Harmonic Emissions

9.1 Measurement procedure

[FCC 24.238(a), 2.1053, IC RSS-133 6.5.1]

<Step 1>

The EUT and support equipment are placed on a 1 meter x 1.5 meter surface, 0.8 meter height FRP table. Radiated emission measurements are performed at 3 meter distance with the broadband antenna (Biconical antenna, Log periodic antenna and double ridged guide antenna). The antenna is positioned both the horizontal and vertical planes of polarization and height is varied 1 to 4 meters and stopped at height producing the maximum emission.

The bandwidth of the spectrum analyzer is set to 1MHz. The turntable is rotated by 360 degrees and stopped at azimuth of producing the maximum emission. The frequency is investigated up to 20GHz.

<Step 2>

The substitution antenna is replaced by the transmitter antenna (EUT).

The frequency of the signal generator is adjusted to the measurement frequency.

Level of the signal generator is adjusted to the level that is obtained from step 1, and record the emission level of signal generator.

Spectrum analyzer setting

- Detector: Peak (RBW: 1MHz, VBW: 3MHz)

- Test configuration

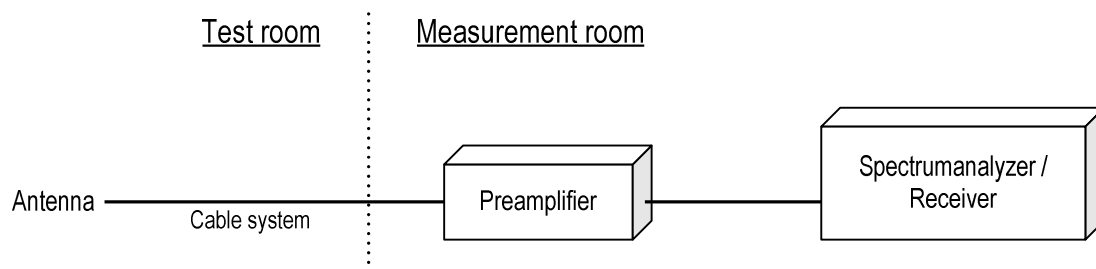

9.2 Calculation method

Result = S.G Reading – Cable loss + Antenna Gain

Margin = Limit – Result (EIRP)

Example:

Limit @ 3757.5MHz : -13.0dBm

S.G Reading = -54.3dBm Cable loss = 1.6dB Ant. Gain = 9.2dBi

Result = -54.3 – 1.6 + 9.2 = -46.7dBm

Margin = -13.0 - (-46.7) = 33.7dB

9.3 Limit

-13dBm or less

9.4 Test data

Date	: June 23, 2015	Test engineer	:	
Temperature	: 24.4 [°C]			
Humidity	: 62.1 [%]			
Test place	: 3m Semi-anechoic chamber			
			:	<u>Taiki Watanabe</u>
Date	: June 24, 2015	Test engineer	:	
Temperature	: 24.5 [°C]			
Humidity	: 62.2 [%]			
Test place	: 3m Semi-anechoic chamber			
			:	<u>Hikaru Shibata</u>
Date	: July 1, 2015	Test engineer	:	
Temperature	: 24.4 [°C]			
Humidity	: 61.9 [%]			
Test place	: 3m Semi-anechoic chamber			
			:	<u>Taiki Watanabe</u>
Date	: July 2, 2015	Test engineer	:	
Temperature	: 24.1 [°C]			
Humidity	: 59.5 [%]			
Test place	: 3m Semi-anechoic chamber			
			:	<u>Hikaru Shibata</u>
Date	: July 3, 2015	Test engineer	:	
Temperature	: 24.8 [°C]			
Humidity	: 63.6 [%]			
Test place	: 3m Semi-anechoic chamber			
			:	<u>Hikaru Shibata</u>

[WCDMA Band II] Channel: 9262

H/V	Frequency [MHz]	S.A Reading [dBm]	S.G Reading [dBm]	Cable loss [dB]	Ant.Gain [dBi]	Result [dBm]	Limit [dBm]	Margin [dB]
H	3707.0	-53.0	-48.5	1.6	9.4	-40.7	-13.0	27.7
V	3707.0	-54.4	-48.5	1.6	9.4	-40.7	-13.0	27.7
H	5561.0	-48.8	-42.3	2.0	11.0	-33.3	-13.0	20.3
V	5561.0	-56.2	-49.3	2.0	8.8	-42.5	-13.0	29.5

Channel: 9400

H/V	Frequency [MHz]	S.A Reading [dBm]	S.G Reading [dBm]	Cable loss [dB]	Ant.Gain [dBi]	Result [dBm]	Limit [dBm]	Margin [dB]
H	3757.5	-60.2	-54.3	1.6	9.2	-46.7	-13.0	33.7
V	3757.5	-62.3	-55.9	1.6	9.2	-48.3	-13.0	35.3

Channel: 9538

H/V	Frequency [MHz]	S.A Reading [dBm]	S.G Reading [dBm]	Cable loss [dB]	Ant.Gain [dBi]	Result [dBm]	Limit [dBm]	Margin [dB]
H	3813.5	-62.1	-56.2	1.6	9.3	-48.5	-13.0	35.5
V	3813.5	-61.5	-55.1	1.6	9.3	-47.4	-13.0	34.4
V	5720.0	-62.5	-54.8	2.0	11.5	-45.3	-13.0	32.3

**[LTE Band II]
QPSK, BW 1.4MHz
Channel: 18607**

H/V	Frequency [MHz]	S.A Reading [dBm]	S.G Reading [dBm]	Cable loss [dB]	Ant.Gain [dBi]	Result [dBm]	Limit [dBm]	Margin [dB]
H	3702.3	-37.1	-32.6	1.6	9.4	-24.8	-13.0	11.8
V	3702.3	-41.1	-35.2	1.6	9.4	-27.4	-13.0	14.4
H	5554.0	-32.1	-24.7	2.0	11.0	-15.7	-13.0	2.7
V	5554.0	-33.2	-25.7	2.0	11.0	-16.7	-13.0	3.7
H	7405.0	-59.2	-43.4	2.3	10.8	-34.8	-13.0	21.8
V	7405.0	-60.5	-47.6	2.3	10.8	-39.0	-13.0	26.0
H	9256.0	-59.9	-40.6	2.6	11.9	-31.3	-13.0	18.3
V	9256.0	-59.5	-41.6	2.6	11.9	-32.3	-13.0	19.3

Channel: 18900

H/V	Frequency [MHz]	S.A Reading [dBm]	S.G Reading [dBm]	Cable loss [dB]	Ant.Gain [dBi]	Result [dBm]	Limit [dBm]	Margin [dB]
H	3761.0	-34.0	-28.1	1.6	9.2	-20.5	-13.0	7.5
V	3761.0	-40.8	-34.4	1.6	9.2	-26.8	-13.0	13.8
H	5641.0	-33.8	-25.3	2.0	11.3	-16.0	-13.0	3.0
V	5641.0	-43.3	-33.2	2.0	11.3	-23.9	-13.0	10.9
H	7252.0	-57.4	-41.3	2.3	11.2	-32.4	-13.0	19.4
V	7252.0	-60.1	-46.3	2.3	11.2	-37.4	-13.0	24.4
H	9402.0	-53.5	-34.2	2.6	11.7	-25.1	-13.0	12.1
V	9402.0	-57.0	-40.7	2.6	11.7	-31.6	-13.0	18.6

Channel: 19193

H/V	Frequency [MHz]	S.A Reading [dBm]	S.G Reading [dBm]	Cable loss [dB]	Ant.Gain [dBi]	Result [dBm]	Limit [dBm]	Margin [dB]
H	3819.6	-39.1	-33.2	1.6	9.3	-25.5	-13.0	12.5
V	3818.5	-43.9	-37.5	1.6	9.3	-29.8	-13.0	16.8
H	5729.0	-37.0	-28.3	2.0	11.5	-18.8	-13.0	5.8
V	5729.0	-55.5	-47.8	2.0	11.5	-38.3	-13.0	25.3
H	7369.0	-56.2	-40.8	2.3	11.0	-32.1	-13.0	19.1
V	7369.0	-58.0	-44.8	2.3	11.0	-36.1	-13.0	23.1
H	9549.0	-56.9	-37.7	2.6	12.0	-28.3	-13.0	15.3
V	9549.0	-62.4	-45.4	2.6	12.0	-36.1	-13.0	23.1

16QAM, BW 1.4MHz**Channel: 18607**

H/V	Frequency [MHz]	S.A Reading [dBm]	S.G Reading [dBm]	Cable loss [dB]	Ant.Gain [dBi]	Result [dBm]	Limit [dBm]	Margin [dB]
H	3702.3	-32.2	-27.7	1.6	9.4	-19.9	-13.0	6.9
V	3702.3	-43.4	-37.5	1.6	9.4	-29.7	-13.0	16.7
H	5554.0	-29.7	-22.3	2.0	11.0	-13.3	-13.0	0.3
V	5554.0	-36.7	-29.2	2.0	11.0	-20.2	-13.0	7.2
H	7405.0	-58.8	-43.0	2.3	10.8	-34.4	-13.0	21.4
V	7405.0	-62.0	-49.1	2.3	10.8	-40.5	-13.0	27.5
H	9256.0	-61.3	-42.0	2.6	11.9	-32.7	-13.0	19.7
V	9256.0	-61.2	-43.3	2.6	11.9	-34.0	-13.0	21.0

Channel: 18900

H/V	Frequency [MHz]	S.A Reading [dBm]	S.G Reading [dBm]	Cable loss [dB]	Ant.Gain [dBi]	Result [dBm]	Limit [dBm]	Margin [dB]
H	3760.9	-33.8	-27.9	1.6	9.2	-20.3	-13.0	7.3
V	3760.9	-40.3	-33.9	1.6	9.2	-26.3	-13.0	13.3
H	5641.0	-31.5	-23.0	2.0	11.3	-13.7	-13.0	0.7
V	5642.0	-39.6	-29.5	2.0	11.3	-20.2	-13.0	7.2
H	7522.0	-57.9	-41.8	2.3	11.2	-32.9	-13.0	19.9
V	7522.0	-61.5	-47.7	2.3	11.2	-38.8	-13.0	25.8
H	9402.0	-54.2	-34.9	2.6	11.7	-25.8	-13.0	12.8
V	9402.0	-56.0	-39.7	2.6	11.7	-30.6	-13.0	17.6

Channel: 19193

H/V	Frequency [MHz]	S.A Reading [dBm]	S.G Reading [dBm]	Cable loss [dB]	Ant.Gain [dBi]	Result [dBm]	Limit [dBm]	Margin [dB]
H	3819.5	-36.7	-30.8	1.6	9.3	-23.1	-13.0	10.1
V	3819.5	-42.7	-36.3	1.6	9.3	-28.6	-13.0	15.6
H	5729.0	-37.0	-28.3	2.0	11.5	-18.8	-13.0	5.8
V	5729.0	-48.7	-41.0	2.0	11.5	-31.5	-13.0	18.5
H	7639.0	-55.1	-39.7	2.3	11.5	-30.6	-13.0	17.6
V	7639.0	-58.7	-45.5	2.3	11.5	-36.4	-13.0	23.4
H	9549.0	-57.0	-37.8	2.6	12.0	-28.4	-13.0	15.4
V	9549.0	-61.3	-44.3	2.6	12.0	-35.0	-13.0	22.0

QPSK, BW 3MHz
Channel: 18615

H/V	Frequency [MHz]	S.A Reading [dBm]	S.G Reading [dBm]	Cable loss [dB]	Ant.Gain [dBi]	Result [dBm]	Limit [dBm]	Margin [dB]
H	3705.5	-37.4	-32.9	1.6	9.4	-25.1	-13.0	12.1
V	3705.6	-41.4	-35.5	1.6	9.4	-27.7	-13.0	14.7
H	5558.0	-29.4	-22.9	2.0	11.0	-13.9	-13.0	0.9
V	5558.0	-34.8	-27.3	2.0	11.0	-18.3	-13.0	5.3
H	7411.0	-60.1	-44.3	2.3	10.9	-35.7	-13.0	22.7
V	7411.0	-63.3	-50.4	2.3	10.9	-41.8	-13.0	28.8
H	9264.0	-59.6	-40.3	2.6	11.8	-31.0	-13.0	18.0
V	9264.0	-61.8	-43.9	2.6	11.8	-34.7	-13.0	21.7
H	11120.0	-61.3	-47.2	2.8	12.8	-37.3	-13.0	24.3

Channel: 18900

H/V	Frequency [MHz]	S.A Reading [dBm]	S.G Reading [dBm]	Cable loss [dB]	Ant.Gain [dBi]	Result [dBm]	Limit [dBm]	Margin [dB]
H	3762.6	-36.0	-30.1	1.6	9.2	-22.5	-13.0	9.5
V	3762.6	-40.6	-34.2	1.6	9.2	-26.6	-13.0	13.6
H	5644.0	-34.4	-25.9	2.0	11.3	-16.6	-13.0	3.6
V	5644.0	-39.6	-29.5	2.0	11.3	-20.2	-13.0	7.2
H	7525.0	-56.9	-40.8	2.3	11.2	-31.9	-13.0	18.9
V	7525.0	-59.7	-45.9	2.3	11.2	-37.0	-13.0	24.0
H	9406.0	-52.8	-33.5	2.6	11.8	-24.4	-13.0	11.4
V	9406.0	-57.3	-41.0	2.6	11.8	-31.8	-13.0	18.8
H	13170.0	-64.8	-49.3	3.1	12.8	-39.7	-13.0	26.7

Channel: 19185

H/V	Frequency [MHz]	S.A Reading [dBm]	S.G Reading [dBm]	Cable loss [dB]	Ant.Gain [dBi]	Result [dBm]	Limit [dBm]	Margin [dB]
H	3819.6	-35.5	-29.6	1.6	9.3	-21.9	-13.0	8.9
V	3819.6	-42.6	-36.2	1.6	9.3	-28.5	-13.0	15.5
H	5729.0	-38.8	-30.1	2.0	11.5	-20.6	-13.0	7.6
V	5729.0	-43.6	-36.2	2.0	11.5	-26.7	-13.0	13.7
H	7369.0	-54.7	-39.3	2.3	11.0	-30.6	-13.0	17.6
V	7369.0	-60.1	-46.9	2.3	11.0	-38.2	-13.0	25.2
H	9549.0	-56.9	-37.7	2.6	12.0	-28.3	-13.0	15.3
V	9549.0	-63.0	-46.0	2.6	12.0	-36.7	-13.0	23.7

16QAM, BW 3MHz
Channel: 18615

H/V	Frequency [MHz]	S.A Reading [dBm]	S.G Reading [dBm]	Cable loss [dB]	Ant.Gain [dBi]	Result [dBm]	Limit [dBm]	Margin [dB]
H	3705.6	-35.5	-31.0	1.6	9.4	-23.2	-13.0	10.2
V	3705.5	-38.8	-32.9	1.6	9.4	-25.1	-13.0	12.1
H	5558.0	-27.8	-23.4	2.0	11.0	-14.4	-13.0	1.4
V	5558.0	-32.5	-28.0	2.0	11.0	-19.0	-13.0	6.0
H	7411.0	-60.8	-45.0	2.3	10.9	-36.4	-13.0	23.4
V	7411.0	-63.2	-50.3	2.3	10.9	-41.7	-13.0	28.7
H	9264.0	-60.9	-41.6	2.6	11.8	-32.3	-13.0	19.3
V	9264.0	-61.2	-43.3	2.6	11.8	-34.1	-13.0	21.1
H	11120.0	-61.4	-46.2	2.8	12.8	-36.3	-13.0	23.3

Channel: 18900

H/V	Frequency [MHz]	S.A Reading [dBm]	S.G Reading [dBm]	Cable loss [dB]	Ant.Gain [dBi]	Result [dBm]	Limit [dBm]	Margin [dB]
H	3762.5	-36.2	-30.3	1.6	9.2	-22.7	-13.0	9.7
V	3762.5	-40.2	-33.8	1.6	9.2	-26.2	-13.0	13.2
H	5644.0	-31.6	-23.1	2.0	11.3	-13.8	-13.0	0.8
V	5644.0	-41.3	-31.2	2.0	11.3	-21.9	-13.0	8.9
H	7525.0	-58.0	-41.9	2.3	11.2	-33.0	-13.0	20.0
V	7525.0	-61.4	-47.6	2.3	11.2	-38.7	-13.0	25.7
H	9406.0	-53.1	-33.8	2.6	11.8	-24.7	-13.0	11.7
V	9406.0	-57.8	-41.5	2.6	11.8	-32.3	-13.0	19.3
H	13170.0	-64.8	-48.3	3.1	12.8	-38.7	-13.0	25.7

Channel: 19185

H/V	Frequency [MHz]	S.A Reading [dBm]	S.G Reading [dBm]	Cable loss [dB]	Ant.Gain [dBi]	Result [dBm]	Limit [dBm]	Margin [dB]
H	3819.6	-36.3	-30.4	1.6	9.3	-22.7	-13.0	9.7
V	3819.6	-42.4	-36.0	1.6	9.3	-28.3	-13.0	15.3
H	5729.0	-38.5	-29.8	2.0	11.5	-20.3	-13.0	7.3
V	5729.0	-45.6	-37.9	2.0	11.5	-28.4	-13.0	15.4
H	7369.0	-53.8	-38.4	2.3	11.0	-29.7	-13.0	16.7
V	7369.0	-58.9	-45.7	2.3	11.0	-37.0	-13.0	24.0
H	9549.0	-56.6	-37.4	2.6	12.0	-28.0	-13.0	15.0
V	9549.0	-63.0	-46.0	2.6	12.0	-36.7	-13.0	23.7

QPSK, BW 5MHz
Channel: 18625

H/V	Frequency [MHz]	S.A Reading [dBm]	S.G Reading [dBm]	Cable loss [dB]	Ant.Gain [dBi]	Result [dBm]	Limit [dBm]	Margin [dB]
H	3709.3	-37.9	-33.4	1.6	9.4	-25.6	-13.0	12.6
V	3709.3	-43.7	-37.8	1.6	9.4	-30.0	-13.0	17.0
H	5564.0	-30.6	-24.1	2.0	11.0	-15.1	-13.0	2.1
V	5564.0	-39.5	-32.6	2.0	11.0	-23.6	-13.0	10.6
H	7419.0	-61.4	-45.4	2.3	10.9	-36.7	-13.0	23.7
V	7419.0	-64.1	-50.1	2.3	10.9	-41.4	-13.0	28.4
H	9273.0	-63.2	-44.1	2.6	11.8	-34.9	-13.0	21.9
V	9273.0	-65.0	-47.4	2.6	11.8	-38.1	-13.0	25.1

Channel: 18900

H/V	Frequency [MHz]	S.A Reading [dBm]	S.G Reading [dBm]	Cable loss [dB]	Ant.Gain [dBi]	Result [dBm]	Limit [dBm]	Margin [dB]
H	3764.4	-32.6	-26.7	1.6	9.2	-19.1	-13.0	6.1
V	3764.3	-43.7	-37.3	1.6	9.2	-29.7	-13.0	16.7
H	5647.0	-34.1	-25.6	2.0	11.3	-16.3	-13.0	3.3
V	5647.0	-44.4	-34.3	2.0	11.3	-25.0	-13.0	12.0
H	7529.0	-56.8	-41.3	2.3	11.3	-32.4	-13.0	19.4
V	7529.0	-61.5	-47.9	2.3	11.3	-38.9	-13.0	25.9
H	9411.0	-54.8	-36.5	2.6	11.8	-27.4	-13.0	14.4
V	9411.0	-60.2	-43.1	2.6	11.8	-33.9	-13.0	20.9

Channel: 19175

H/V	Frequency [MHz]	S.A Reading [dBm]	S.G Reading [dBm]	Cable loss [dB]	Ant.Gain [dBi]	Result [dBm]	Limit [dBm]	Margin [dB]
H	3819.3	-39.1	-33.2	1.6	9.3	-25.5	-13.0	12.5
V	3819.3	-46.9	-40.5	1.6	9.3	-32.8	-13.0	19.8
H	5729.0	-44.7	-36.0	2.0	11.5	-26.5	-13.0	13.5
V	5729.0	-52.5	-44.8	2.0	11.5	-35.3	-13.0	22.3
H	7369.0	-59.1	-43.6	2.3	11.0	-34.9	-13.0	21.9
V	7369.0	-61.0	-46.8	2.3	11.0	-38.1	-13.0	25.1
H	9548.0	-60.7	-41.7	2.6	12.0	-32.4	-13.0	19.4

16QAM, BW 5MHz
Channel: 18625

H/V	Frequency [MHz]	S.A Reading [dBm]	S.G Reading [dBm]	Cable loss [dB]	Ant.Gain [dBi]	Result [dBm]	Limit [dBm]	Margin [dB]
H	3705.0	-32.4	-27.9	1.6	9.4	-20.1	-13.0	7.1
V	3705.0	-43.1	-37.2	1.6	9.4	-29.4	-13.0	16.4
H	5558.0	-28.8	-22.3	2.0	11.0	-13.3	-13.0	0.3
V	5558.0	-39.5	-32.0	2.0	11.0	-23.0	-13.0	10.0
H	7410.0	-60.4	-44.6	2.3	10.9	-36.0	-13.0	23.0
V	7410.0	-64.9	-52.0	2.3	10.9	-43.4	-13.0	30.4
H	9262.0	-61.8	-38.7	2.6	11.8	-29.4	-13.0	16.4
V	9262.0	-63.5	-45.6	2.6	11.8	-36.4	-13.0	23.4

Channel: 18900

H/V	Frequency [MHz]	S.A Reading [dBm]	S.G Reading [dBm]	Cable loss [dB]	Ant.Gain [dBi]	Result [dBm]	Limit [dBm]	Margin [dB]
H	3760.1	-33.3	-27.4	1.6	9.2	-19.9	-13.0	6.9
V	3760.1	-43.5	-37.1	1.6	9.2	-29.5	-13.0	16.5
H	5640.0	-33.2	-24.7	2.0	11.3	-15.4	-13.0	2.4
V	5640.0	-46.0	-35.9	2.0	11.3	-26.6	-13.0	13.6
H	7520.0	-58.8	-42.7	2.3	11.2	-33.8	-13.0	20.8
V	7520.0	-63.1	-49.3	2.3	11.2	-40.4	-13.0	27.4
H	9400.0	-55.2	-35.9	2.6	11.7	-26.8	-13.0	13.8
V	9400.0	-60.0	-43.7	2.6	11.7	-34.6	-13.0	21.6

Channel: 19175

H/V	Frequency [MHz]	S.A Reading [dBm]	S.G Reading [dBm]	Cable loss [dB]	Ant.Gain [dBi]	Result [dBm]	Limit [dBm]	Margin [dB]
H	3815.0	-37.8	-31.9	1.6	9.3	-24.2	-13.0	11.2
V	3815.0	-48.0	-41.6	1.6	9.3	-33.9	-13.0	20.9
H	5723.0	-41.1	-32.4	2.0	11.5	-22.9	-13.0	9.9
V	5723.0	-53.2	-45.5	2.0	11.5	-36.0	-13.0	23.0
H	7630.0	-59.8	-44.4	2.3	11.4	-35.3	-13.0	22.3
V	7630.0	-63.1	-49.9	2.3	11.4	-40.8	-13.0	27.8
H	9538.0	-63.7	-44.5	2.6	12.0	-35.1	-13.0	22.1

QPSK, BW 10MHz
Channel: 18650

H/V	Frequency [MHz]	S.A Reading [dBm]	S.G Reading [dBm]	Cable loss [dB]	Ant.Gain [dBi]	Result [dBm]	Limit [dBm]	Margin [dB]
H	3710.2	-32.4	-27.9	1.6	9.4	-20.1	-13.0	7.1
V	3710.2	-43.9	-38.0	1.6	9.4	-30.2	-13.0	17.2
H	5565.0	-26.9	-23.4	2.0	11.0	-14.4	-13.0	1.4
V	5565.0	-35.7	-28.8	2.0	11.0	-19.8	-13.0	6.8
H	7420.0	-62.3	-46.3	2.3	10.9	-37.6	-13.0	24.6
V	7420.0	-64.2	-50.2	2.3	10.9	-41.5	-13.0	28.5
H	9276.0	-63.8	-44.7	2.6	11.8	-35.5	-13.0	22.5
V	9276.0	-63.3	-45.7	2.6	11.8	-36.4	-13.0	23.4
H	11130.0	-62.3	-50.0	2.8	12.8	-40.1	-13.0	27.1

Channel: 18900

H/V	Frequency [MHz]	S.A Reading [dBm]	S.G Reading [dBm]	Cable loss [dB]	Ant.Gain [dBi]	Result [dBm]	Limit [dBm]	Margin [dB]
H	3760.2	-34.0	-28.1	1.6	9.2	-20.6	-13.0	7.6
V	3760.2	-44.1	-37.7	1.6	9.2	-30.1	-13.0	17.1
H	5640.0	-33.7	-25.2	2.0	11.3	-15.9	-13.0	2.9
V	5640.0	-44.6	-34.5	2.0	11.3	-25.2	-13.0	12.2
H	7520.0	-58.8	-43.3	2.3	11.2	-34.4	-13.0	21.4
V	7520.0	-61.4	-47.8	2.3	11.2	-38.9	-13.0	25.9
H	9401.0	-54.7	-36.4	2.6	11.7	-27.3	-13.0	14.3
V	9401.0	-59.3	-42.2	2.6	11.7	-33.0	-13.0	20.0
H	13160.0	-65.3	-49.1	3.1	12.8	-39.4	-13.0	26.4

Channel: 19150

H/V	Frequency [MHz]	S.A Reading [dBm]	S.G Reading [dBm]	Cable loss [dB]	Ant.Gain [dBi]	Result [dBm]	Limit [dBm]	Margin [dB]
H	3810.2	-35.8	-29.9	1.6	9.4	-22.2	-13.0	9.2
V	3810.1	-45.0	-38.6	1.6	9.4	-30.9	-13.0	17.9
H	5715.0	-39.0	-30.3	2.0	11.5	-20.8	-13.0	7.8
V	5715.0	-48.1	-40.4	2.0	11.5	-30.9	-13.0	17.9
H	7620.0	-56.1	-40.6	2.3	11.4	-31.5	-13.0	18.5
V	7620.0	-62.9	-48.7	2.3	11.4	-39.6	-13.0	26.6
H	9525.0	-61.9	-42.9	2.6	12.0	-33.6	-13.0	20.6
V	9525.0	-65.3	-46.7	2.6	12.0	-37.4	-13.0	24.4

16QAM, BW 10MHz
Channel: 18650

H/V	Frequency [MHz]	S.A Reading [dBm]	S.G Reading [dBm]	Cable loss [dB]	Ant.Gain [dBi]	Result [dBm]	Limit [dBm]	Margin [dB]
H	3710.2	-32.6	-28.1	1.6	9.4	-20.3	-13.0	7.3
V	3710.2	-43.8	-37.9	1.6	9.4	-30.1	-13.0	17.1
H	5565.0	-28.2	-24.7	2.0	11.0	-15.7	-13.0	2.7
V	5565.0	-38.2	-31.3	2.0	11.0	-22.3	-13.0	9.3
H	7420.0	-61.5	-45.5	2.3	10.9	-36.8	-13.0	23.8
V	7420.0	-65.3	-51.3	2.3	10.9	-42.6	-13.0	29.6
H	9275.0	-62.5	-43.4	2.6	11.8	-34.2	-13.0	21.2
V	9275.0	-62.4	-44.8	2.6	11.8	-35.5	-13.0	22.5
H	11130.0	-63.1	-50.8	2.8	12.8	-40.9	-13.0	27.9

Channel: 18900

H/V	Frequency [MHz]	S.A Reading [dBm]	S.G Reading [dBm]	Cable loss [dB]	Ant.Gain [dBi]	Result [dBm]	Limit [dBm]	Margin [dB]
H	3760.2	-33.3	-27.4	1.6	9.2	-19.9	-13.0	6.9
V	3760.2	-53.0	-46.6	1.6	9.2	-39.0	-13.0	26.0
H	5640.0	-33.9	-25.4	2.0	11.3	-16.1	-13.0	3.1
V	5640.0	-42.7	-32.6	2.0	11.3	-23.3	-13.0	10.3
H	7521.0	-61.2	-45.7	2.3	11.2	-36.8	-13.0	23.8
V	7521.0	-61.7	-48.1	2.3	11.2	-39.2	-13.0	26.2
H	9401.0	-54.6	-36.3	2.6	11.7	-27.2	-13.0	14.2
V	9401.0	-62.5	-45.4	2.6	11.7	-36.2	-13.0	23.2
H	13160.0	-64.7	-48.5	3.1	12.8	-38.8	-13.0	25.8

Channel: 19150

H/V	Frequency [MHz]	S.A Reading [dBm]	S.G Reading [dBm]	Cable loss [dB]	Ant.Gain [dBi]	Result [dBm]	Limit [dBm]	Margin [dB]
H	3810.2	-36.4	-30.5	1.6	9.4	-22.8	-13.0	9.8
V	3810.2	-46.6	-40.2	1.6	9.4	-32.5	-13.0	19.5
H	5715.0	-42.1	-33.4	2.0	11.5	-23.9	-13.0	10.9
V	5715.0	-52.3	-44.6	2.0	11.5	-35.1	-13.0	22.1
H	7620.0	-57.8	-42.3	2.3	11.4	-33.2	-13.0	20.2
V	7620.0	-60.5	-46.3	2.3	11.4	-37.2	-13.0	24.2
H	9526.0	-59.8	-40.8	2.6	12.0	-31.5	-13.0	18.5
V	9525.0	-66.1	-47.5	2.6	12.0	-38.2	-13.0	25.2

QPSK, BW 15MHz
Channel: 18675

H/V	Frequency [MHz]	S.A Reading [dBm]	S.G Reading [dBm]	Cable loss [dB]	Ant.Gain [dBi]	Result [dBm]	Limit [dBm]	Margin [dB]
H	3715.0	-32.9	-28.4	1.6	9.4	-20.6	-13.0	7.6
V	3715.0	-42.0	-36.1	1.6	9.4	-28.3	-13.0	15.3
H	5573.0	-36.7	-33.2	2.0	11.0	-24.1	-13.0	11.1
V	5573.0	-37.5	-30.6	2.0	11.0	-21.5	-13.0	8.5
H	7430.0	-63.2	-47.2	2.3	11.0	-38.5	-13.0	25.5
V	7430.0	-64.7	-50.7	2.3	11.0	-41.9	-13.0	28.9
H	9288.0	-60.1	-41.0	2.6	11.8	-31.8	-13.0	18.8
V	9288.0	-62.4	-44.8	2.6	11.8	-35.6	-13.0	22.6
H	11150.0	-63.8	-51.5	2.8	12.7	-41.6	-13.0	28.6

Channel: 18900

H/V	Frequency [MHz]	S.A Reading [dBm]	S.G Reading [dBm]	Cable loss [dB]	Ant.Gain [dBi]	Result [dBm]	Limit [dBm]	Margin [dB]
H	3760.0	-40.5	-34.6	1.6	9.2	-27.1	-13.0	14.1
V	3760.1	-42.3	-35.9	1.6	9.2	-28.3	-13.0	15.3
H	5640.0	-33.7	-25.2	2.0	11.3	-15.9	-13.0	2.9
V	5640.0	-43.5	-33.4	2.0	11.3	-24.1	-13.0	11.1
H	7520.0	-58.8	-43.3	2.3	11.2	-34.4	-13.0	21.4
V	7520.0	-61.3	-47.7	2.3	11.2	-38.8	-13.0	25.8
H	9400.0	-55.8	-37.5	2.6	11.7	-28.4	-13.0	15.4
V	9400.0	-59.0	-41.9	2.6	11.7	-32.7	-13.0	19.7

Channel: 19125

H/V	Frequency [MHz]	S.A Reading [dBm]	S.G Reading [dBm]	Cable loss [dB]	Ant.Gain [dBi]	Result [dBm]	Limit [dBm]	Margin [dB]
H	3805.1	-36.8	-30.9	1.6	9.4	-23.2	-13.0	10.2
V	3805.1	-45.7	-39.3	1.6	9.4	-31.6	-13.0	18.6
H	5708.0	-39.6	-30.9	2.0	11.5	-21.4	-13.0	8.4
V	5708.0	-48.7	-41.0	2.0	11.5	-31.5	-13.0	18.5
H	7610.0	-57.3	-41.8	2.3	9.2	-34.9	-13.0	21.9
V	7610.0	-64.4	-50.2	2.3	9.2	-43.3	-13.0	30.3
H	9513.0	-61.0	-42.0	2.6	9.8	-34.9	-13.0	21.9
V	9513.0	-65.5	-46.9	2.6	9.8	-39.8	-13.0	26.8

16QAM, BW 15MHz
Channel: 18675

H/V	Frequency [MHz]	S.A Reading [dBm]	S.G Reading [dBm]	Cable loss [dB]	Ant.Gain [dBi]	Result [dBm]	Limit [dBm]	Margin [dB]
H	3701.7	-34.0	-29.5	1.6	9.4	-21.7	-13.0	8.7
V	3701.6	-40.1	-34.2	1.6	9.4	-26.4	-13.0	13.4
H	5553.0	-27.4	-22.9	2.0	11.0	-13.9	-13.0	0.9
V	5553.0	-40.0	-32.5	2.0	11.0	-23.5	-13.0	10.5
H	7403.0	-60.9	-45.1	2.3	10.8	-36.5	-13.0	23.5
V	7403.0	-62.0	-49.1	2.3	10.8	-40.5	-13.0	27.5
H	9254.0	-61.5	-42.2	2.6	11.9	-32.9	-13.0	19.9
V	9254.0	-63.9	-46.0	2.6	11.9	-36.7	-13.0	23.7

Channel: 18900

H/V	Frequency [MHz]	S.A Reading [dBm]	S.G Reading [dBm]	Cable loss [dB]	Ant.Gain [dBi]	Result [dBm]	Limit [dBm]	Margin [dB]
H	3746.7	-32.6	-26.7	1.6	9.2	-19.2	-13.0	6.2
V	3746.7	-43.0	-36.6	1.6	9.2	-29.0	-13.0	16.0
H	5620.0	-31.9	-23.4	2.0	11.2	-14.2	-13.0	1.2
V	5620.0	-40.9	-30.8	2.0	11.2	-21.6	-13.0	8.6
H	7493.0	-59.7	-43.6	2.3	11.1	-34.8	-13.0	21.8
V	7493.0	-63.2	-49.4	2.3	11.1	-40.6	-13.0	27.6
H	9367.0	-53.9	-34.6	2.6	11.8	-25.5	-13.0	12.5
V	9367.0	-59.0	-42.7	2.6	11.8	-33.5	-13.0	20.5

Channel: 19125

H/V	Frequency [MHz]	S.A Reading [dBm]	S.G Reading [dBm]	Cable loss [dB]	Ant.Gain [dBi]	Result [dBm]	Limit [dBm]	Margin [dB]
H	3791.7	-36.0	-30.1	1.6	9.3	-22.4	-13.0	9.4
V	3791.7	-48.4	-42.0	1.6	9.3	-34.3	-13.0	21.3
H	5688.0	-38.2	-29.5	2.0	11.4	-20.1	-13.0	7.1
V	5688.0	-47.7	-40.0	2.0	11.4	-30.6	-13.0	17.6
H	7583.0	-57.1	-41.7	2.3	11.4	-32.7	-13.0	19.7
V	7583.0	-63.7	-50.5	2.3	11.4	-41.5	-13.0	28.5
H	9479.0	-61.9	-42.7	2.6	11.9	-33.4	-13.0	20.4
V	9479.0	-64.9	-47.9	2.6	11.9	-38.6	-13.0	25.6

QPSK, BW 20MHz
Channel: 18700

H/V	Frequency [MHz]	S.A Reading [dBm]	S.G Reading [dBm]	Cable loss [dB]	Ant.Gain [dBi]	Result [dBm]	Limit [dBm]	Margin [dB]
H	3702.2	-32.6	-28.1	1.6	9.4	-20.3	-13.0	7.3
V	3702.2	-42.1	-36.2	1.6	9.4	-28.4	-13.0	15.4
H	5553.0	-27.4	-23.0	2.0	11.0	-14.0	-13.0	1.0
V	5553.0	-37.3	-28.1	2.0	11.0	-19.1	-13.0	6.1
H	7404.0	-58.9	-43.2	2.3	10.8	-34.6	-13.0	21.6
V	7404.0	-62.4	-48.4	2.3	10.8	-39.8	-13.0	26.8
H	9255.0	-63.1	-44.2	2.6	11.9	-34.9	-13.0	21.9
V	9255.0	-61.0	-44.0	2.6	11.9	-34.7	-13.0	21.7
H	11110.0	-64.2	-42.8	2.8	12.8	-32.8	-13.0	19.8

Channel: 18900

H/V	Frequency [MHz]	S.A Reading [dBm]	S.G Reading [dBm]	Cable loss [dB]	Ant.Gain [dBi]	Result [dBm]	Limit [dBm]	Margin [dB]
H	3742.2	-32.2	-31.0	1.6	9.2	-23.4	-13.0	10.4
V	3742.2	-42.9	-40.3	1.6	9.2	-32.7	-13.0	19.7
H	5613.0	-31.3	-24.1	2.0	11.2	-14.9	-13.0	1.9
V	5613.0	-42.3	-36.3	2.0	9.0	-29.3	-13.0	16.3
H	7484.0	-62.6	-46.9	2.3	8.9	-40.3	-13.0	27.3
V	7484.0	-62.0	-48.0	2.3	8.9	-41.3	-13.0	28.3
H	9356.0	-53.8	-35.5	2.6	9.6	-28.5	-13.0	15.5
V	9356.0	-60.4	-43.3	2.6	9.6	-36.3	-13.0	23.3

Channel: 19100

H/V	Frequency [MHz]	S.A Reading [dBm]	S.G Reading [dBm]	Cable loss [dB]	Ant.Gain [dBi]	Result [dBm]	Limit [dBm]	Margin [dB]
H	3782.2	-37.1	-35.4	1.6	9.3	-27.7	-13.0	14.7
V	3782.3	-46.9	-44.7	1.6	9.3	-37.0	-13.0	24.0
H	5673.0	-37.6	-30.0	2.0	11.4	-20.6	-13.0	7.6
V	5673.0	-46.2	-40.0	2.0	11.4	-30.6	-13.0	17.6
H	7564.0	-56.3	-41.0	2.3	9.1	-34.1	-13.0	21.1
V	7564.0	-61.6	-47.8	2.3	9.1	-41.0	-13.0	28.0
H	9456.0	-60.8	-42.7	2.6	9.7	-35.6	-13.0	22.6
V	9455.0	-62.9	-45.6	2.6	9.7	-38.6	-13.0	25.6

16QAM, BW 20MHz
Channel: 18700

H/V	Frequency [MHz]	S.A Reading [dBm]	S.G Reading [dBm]	Cable loss [dB]	Ant.Gain [dBi]	Result [dBm]	Limit [dBm]	Margin [dB]
H	3697.2	-33.7	-29.2	1.6	9.5	-21.3	-13.0	8.3
V	3697.2	-42.3	-36.4	1.6	9.5	-28.5	-13.0	15.5
H	5546.0	-28.4	-24.0	2.0	10.9	-15.0	-13.0	2.0
V	5546.0	-40.9	-31.7	2.0	10.9	-22.7	-13.0	9.7
H	7394.0	-59.1	-43.4	2.3	10.8	-34.8	-13.0	21.8
V	7394.0	-63.2	-49.2	2.3	10.8	-40.6	-13.0	27.6
H	9243.0	-61.6	-42.7	2.6	11.9	-33.4	-13.0	20.4
V	9243.0	-62.8	-45.8	2.6	11.9	-36.5	-13.0	23.5

Channel: 18900

H/V	Frequency [MHz]	S.A Reading [dBm]	S.G Reading [dBm]	Cable loss [dB]	Ant.Gain [dBi]	Result [dBm]	Limit [dBm]	Margin [dB]
H	3742.2	-32.9	-31.7	1.6	9.2	-24.1	-13.0	11.1
V	3742.2	-42.6	-40.0	1.6	9.2	-32.4	-13.0	19.4
H	5613.0	-30.7	-23.5	2.0	11.2	-14.3	-13.0	1.3
V	5613.0	-44.8	-38.8	2.0	11.2	-29.6	-13.0	16.6
H	7485.0	-59.8	-44.1	2.3	11.1	-35.3	-13.0	22.3
V	7485.0	-65.7	-51.7	2.3	11.1	-42.8	-13.0	29.8
H	9355.0	-55.3	-37.0	2.6	11.8	-27.8	-13.0	14.8
V	9356.0	-57.9	-40.8	2.6	11.8	-31.6	-13.0	18.6

Channel: 19100

H/V	Frequency [MHz]	S.A Reading [dBm]	S.G Reading [dBm]	Cable loss [dB]	Ant.Gain [dBi]	Result [dBm]	Limit [dBm]	Margin [dB]
H	3782.2	-35.0	-33.3	1.6	9.3	-25.6	-13.0	12.6
V	3782.3	-46.9	-44.7	1.6	9.3	-37.0	-13.0	24.0
H	5673.0	-37.1	-29.5	2.0	11.4	-20.1	-13.0	7.1
V	5673.0	-45.8	-39.6	2.0	11.4	-30.2	-13.0	17.2
H	7564.0	-59.0	-43.7	2.3	11.3	-34.6	-13.0	21.6
V	7564.0	-62.3	-48.5	2.3	11.3	-39.5	-13.0	26.5
H	9456.0	-60.2	-42.1	2.6	11.9	-32.8	-13.0	19.8
V	9455.0	-64.5	-47.2	2.6	11.9	-38.0	-13.0	25.0

10. Frequency Stability

10.1 Measurement procedure

[FCC 24.235, 2.1055, IC RSS-133 6.3]

The EUT was placed inside of a constant temperature chamber as the temperature in the chamber was varied between -30°C and $+50^{\circ}\text{C}$. The temperature was incremented by 10°C intervals and the unit was allowed to stabilize at each measurement. The frequency drift was measured with the normal Temperature and voltage tolerance and it is presented as the ppm unit.

- Test configuration

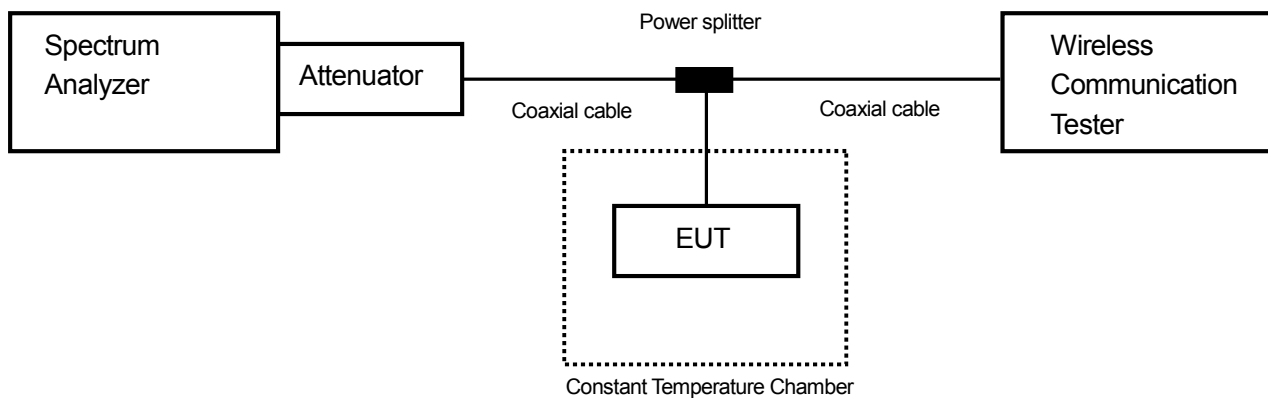

10.2 Limit

$\pm 2.5\text{ppm}$



Zacta

10.3 Measurement result

Date : June 24, 2015
 Temperature : 26.1 [°C]
 Humidity : 59.9 [%]
 Test place : Shielded room No.4
 Test engineer : Hikaru Shibata

Date : June 25, 2015
 Temperature : 27.4 [°C]
 Humidity : 52.3 [%]
 Test place : Shielded room No.4
 Test engineer : Hikaru Shibata

[WCDMA Band II] (Channel: 9400)

Limit: $\pm 0.00025\% = \pm 2.5\text{ppm}$					
Power Supply [V]	Temperature [°C]	Measurements Frequency [Hz]	Frequency Tolerance [ppm]	Limit [ppm]	Result
3.90	25(Ref.)	1,879,997,620	0.00000	± 2.5	Pass
	50	1,879,998,126	0.26915	± 2.5	Pass
	40	1,879,996,624	-0.52979	± 2.5	Pass
	30	1,879,997,846	0.12021	± 2.5	Pass
	20	1,879,998,501	0.46862	± 2.5	Pass
	10	1,879,996,401	-0.64841	± 2.5	Pass
	0	1,879,995,458	-1.15000	± 2.5	Pass
	-10	1,879,994,083	-1.88139	± 2.5	Pass
	-20	1,879,994,596	-1.60851	± 2.5	Pass
	-30	1,879,996,818	-0.42660	± 2.5	Pass
3.315	25	1,879,999,749	1.13262	± 2.5	Pass
4.485	25	1,879,996,581	-0.55266	± 2.5	Pass

Calculation;

Frequency Tolerance (ppm) = Measurements Frequency (Hz) – Reference Frequency (Hz) / Reference Frequency (Hz) x 1000000



Zacta

**[LTE Band II]
(Channel: 18900)**

Limit: $\pm 0.00025\% = \pm 2.5\text{ppm}$					
Power Supply [V]	Temperature [°C]	Measurements Frequency [Hz]	Frequency Tolerance [ppm]	Limit [ppm]	Result
3.90	25(Ref.)	1,880,000,669	0.00000	± 2.5	Pass
	50	1,879,999,734	-0.49715	± 2.5	Pass
	40	1,880,000,276	-0.20882	± 2.5	Pass
	30	1,879,999,105	-0.83159	± 2.5	Pass
	20	1,879,999,458	-0.64391	± 2.5	Pass
	10	1,879,998,419	-1.19655	± 2.5	Pass
	0	1,879,996,856	-2.02793	± 2.5	Pass
	-10	1,879,998,419	-1.19655	± 2.5	Pass
	-20	1,880,000,694	0.01356	± 2.5	Pass
	-30	1,879,997,267	-1.80931	± 2.5	Pass
3.315	25	1,880,000,105	-0.29958	± 2.5	Pass
4.485	25	1,880,000,719	0.02710	± 2.5	Pass

Calculation;

Frequency Tolerance (ppm) = Measurements Frequency (Hz) – Reference Frequency (Hz) / Reference Frequency (Hz) x 1000000



Zacta

11. Uncertainty of measurement

Expanded uncertainties stated are calculated with a coverage Factor $k=2$.

Please note that these results are not taken into account when determining compliance or non-compliance with test result.

Test item	Measurement uncertainty
Conducted emission at mains port	$\pm 3.0\text{dB}$
Radiated emission (9kHz – 30MHz)	$\pm 4.4\text{dB}$
Radiated emission (30MHz – 1000MHz)	$\pm 4.5\text{dB}$
Radiated emission (1000MHz – 26GHz)	$\pm 3.9\text{dB}$



Zacta

12. Laboratory description

1. Location:

TÜV SÜD Zacta Ltd. Yonezawa Testing Center
 4149-7 Hachimanpara 5-chome Yonezawa-shi Yamagata 992-1128 Japan
 Phone: +81-238-28-2880 Fax: +81-238-28-2888

2. Facility filing information:

1) NVLAP accreditation: NVLAP Lab. code: 200306-0

2) VLAC accreditation: Lab. code: VLAC-013

Site name	Radiated emission	Conducted emission for mains port	Conducted emission for telecom port	Radiated emission (CMAD)	Expiry Date
3m Semi-anechoic chamber	VLAC-013	VLAC-013	VLAC-013	-	Jul. 3, 2017
10m Semi-anechoic chamber No.1				VLAC-013	
10m Semi-anechoic chamber No.2					
Shielded room No.1	-	VLAC-013		-	

3) FCC filing:

Site name	Registration Number	Expiry Date
Site 3	91065	Oct. 1, 2017
3m Semi-anechoic chamber	540072	Feb. 20, 2017
10m Semi-anechoic chamber No.1		
10m Semi-anechoic chamber No.2		
Shielded room No.1		

4) Industry Canada Oats site filing:

Site name	Sites on file: Oats 3m/10m	Expiry Date
Site 3	4224A-3	Dec. 3, 2017
3m Semi-anechoic chamber	4224A-4	
10m Semi-anechoic chamber No.1	4224A-5	
10m Semi-anechoic chamber No.2	4224A-6	Jan. 15, 2017

5) VCCI site filing:

Site name	Radiated emission	Conducted emission for mains port	Conducted emission for telecom port	Expiry Date
Site 3	R-138	C-134	T-1222	Nov. 16, 2017
3m Semi-anechoic chamber	A-0166	A-0166	A-0166	Jul. 3, 2017
10m Semi-anechoic chamber No.1				
10m Semi-anechoic chamber No.2				
Shielded room No.1	-	A-0166		

6) TÜV SÜD PS authorization:

Authorized as an EMC test laboratory

7) TÜV Rheinland authorization:

Authorized as an EMC test laboratory



Zacta

Appendix A. Test equipment

Antenna port conducted test

Equipment	Company	Model No.	Serial No.	Cal. due	Cal. date
Spectrum analyzer	Agilent Technologies	E4440A	US44302655	Jun. 30, 2016	Jun. 11, 2015
Microwave cable	RS	YH20_S1	N/A (S389)	Aug. 31, 2015	Aug. 30, 2014
Attenuator	Weinschel	56-10	J4180	Nov. 30, 2015	Nov. 12, 2014
Microwave cable	SUHNER	SUCOFLEX104/1.5m	199121/4	Oct. 31, 2015	Oct. 7, 2014
Microwave cable	SUHNER	SUCOFLEX104/1.5m	322086/4	Jul. 31, 2015	Jul. 30, 2014
Power splitter	ANRITSU	K240B	020205	Jul. 31, 2015	Jul. 12, 2014
Wideband radio frequency tester	ROHDE&SCHWARZ	CMW500	116338	Apr. 30, 2016	Apr. 2, 2015
Operation type temperature controlled bath	Espec	PL1KP	14007261	Jan. 31, 2016	Jan. 9, 2015

Radiated emission

Equipment	Company	Model No.	Serial No.	Cal. Due	Cal. Date
EMI Receiver	ROHDE&SCHWARZ	ESCI	100451	Dec. 31, 2015	Dec. 25, 2014
Preamplifier	ANRITSU	MH648A	M96057	Jun. 30, 2016	Jun. 12, 2015
Biconical antenna	Schwarzbeck	VHA9103/BBA9106	2125	Jun. 30, 2016	Jun. 4, 2015
Log periodic antenna	Schwarzbeck	UHALP9108A	0560	Jun. 30, 2016	Jun. 4, 2015
Attenuator	TME	CFA-01NPJ-6	N/A (S275)	Jun. 30, 2016	Jun. 23, 2015
Attenuator	TME	CFA-01NPJ-3	N/A (S272)	Jun. 30, 2016	Jun. 23, 2015
Spectrum analyzer	Agilent Technologies	E4440A	US44302655	Jun. 30, 2016	Jun. 11, 2015
Preamplifier	TSJ	MLA-100M18-B02-40	1929118	May 31, 2016	May 1, 2015
Attenuator	AEROFLEX	26A-10	081217-08	Mar. 31, 2016	Mar. 12, 2015
Dipole antenna	Schwarzbeck	VHAP	1020	Sep. 30, 2015	Sep. 5, 2014
Dipole antenna	Schwarzbeck	UHAP	994	Sep. 30, 2015	Sep. 5, 2014
Double ridged guide antenna	EMCO	3115	5205	Feb. 29, 2016	Feb. 16, 2015
Attenuator	Agilent Technologies	8491B	MY39268633	Feb. 29, 2016	Feb. 1, 2015
Double ridged guide antenna	EMCO	3115	000058532	Oct. 31, 2015	Oct. 14, 2014
Signal generator	ROHDE&SCHWARZ	SMB100A	177525	Jun. 30, 2016	Jun. 19, 2015
Power amplifier	R&K	CGA020M602-2633R	B40240	Mar.31, 2016	Mar. 23, 2015
Microwave cable	SUHNER	SUCOFELX102/2m	31648/2	Mar. 28, 2016	Mar. 10, 2015
High pass filter	Micro-Tronics	HPM50115	004	Jul. 31, 2015	Jul. 12, 2014
High pass filter	Wainwright	WHKX2.8/18G-6SS	1	Jul. 31, 2015	Jul. 17, 2014
Wideband radio frequency tester	ROHDE&SCHWARZ	CMW500	126079	Aug. 31, 2015	Aug. 28, 2014
Microwave cable	SUHNER	SUCOFLEX104/9m	346316/4	Oct. 31, 2015	Oct. 31, 2014
		SUCOFLEX104/1m	322084/4	Oct. 31, 2015	Oct. 31, 2014
		SUCOFLEX104/1.5m	317226/4	Oct. 31, 2015	Oct. 31, 2014
		SUCOFLEX104/7m	41625/6	Oct. 31, 2015	Oct. 31, 2014
PC	DELL	DIMENSION E521	75465BX	N/A	N/A
Software	TOYO Corporation	EP5/RE-AJ	0611193/V5.3.61	N/A	N/A
3m Semi-anechoic chamber	TOKIN	N/A	N/A (9002-NSA)	Apr. 30, 2016	Apr. 27, 2015
3m Semi-anechoic chamber	TOKIN	N/A	N/A (9002-SVSWR)	Apr. 30, 2016	Apr. 27, 2015

*: The calibrations of the above equipment are traceable to NIST or equivalent standards of the reference organizations.