



FCC CFR47 CERTIFICATION

PART 24E

TEST REPORT

FOR

KYOCERA CORPORATION

MODEL: BS1905A-US-A

FCC ID: JOYIBS19AA

REPORT NUMBER:04I2701-1

ISSUE DATE: MAY 27, 2004

Prepared for

**KYOCERA CORPORATION
2-1-1 KAGAHARA TSUZUKI-KU
YOKOHAMA-SHI,
JAPAN**

Prepared by

**COMPLIANCE CERTIFICATION SERVICES
561F MONTEREY ROAD, ROUTE 2
MORGAN HILL, CA 95037, USA
TEL: (408) 463-0885
FAX: (408) 463-0888**

TABLE OF CONTENT

1. TEST RESULT CERTIFICATION.....	3
2. EUT DESCRIPTION	4
3. TEST METHODOLOGY	4
4. TEST FACILITY.....	4
5. ACCREDITATION AND LISTING.....	4
6. MEASURING INSTRUMENT CALIBRATION	4
7. TEST SETUP, PROCEDURE AND RESULT.....	5
7.1. SECTION 2.1046: RF POWER OUTPUT	5
7.2. SECTION 2.1047: MODULATION CHARACTERISTICS	13
7.3. SECTION 2.1049: OCCUPIED BANDWIDTH	13
7.4. SECTION 2.1051: SPURIOUS EMISSION AT ANTENNA TERMINAL	21
7.5. SECTION 2.1053: FIELD STRENGTH OF SPURIOUS RADIATION	70
7.6. SECTION 2.1055: FREQUENCY STABILITY	80
7.7. RADIATED EMISSION	84
7.8. POWERLINE CONDUCTED EMISSION	91
8. APENDIX	99
8.1. EXTERNAL & INTERNAL PHOTOS	99
8.2. SCHEMATICS	99
8.3. BLOCK DIAGRAM.....	99
8.4. USER MANUAL.....	99

1. TEST RESULT CERTIFICATION

COMPANY NAME: KYOCERA CORPORATION
2-1-1 KAGAHARA TSUZUKI-KU YOKOHAMA-SHI
KANAGAWA 224-8502, JAPAN

EUT DESCRIPTION: BASE STATION OF WIRELESS BROADBAND INTERNET SYSTEM

MODEL NUMBER: BS1905A-US-A

DATE TESTED: MAY 24 TO MAY 27, 2004

TYPE OF EQUIPMENT	INTENTIONAL RADIATOR, LICENSED TX MODULE IN BASE STATION APPLICATION
MEASUREMENT PROCEDURE	ANSI C63.4 / 2001, TIA/EIA 603
PROCEDURE	CERTIFICATION
FCC RULE	CFR 47 PART 24 Subpart E

Compliance Certification Services, Inc. tested the above equipment for compliance with the requirement set forth in CFR 47, PART 24 Subpart E-Broadband PCS. The equipment in the configuration described in this report, shows the measured emission levels emanating from the equipment do not exceed the specified limit.

Note: This document reports conditions under which testing was conducted and results of tests performed. This document may not be altered or revised in any way unless done so by Compliance Certification Services and all revisions are duly noted in the revisions section. Any alteration of this document not carried out by Compliance Certification Services will constitute fraud and shall nullify the document.

Tested By:



VIEN TRAN
EMC TECHNIAN
COMPLIANCE CERTIFICATION SERVICES

Released For CCS By:



THU CHAN
EMC SUPERVISOR
COMPLIANCE CERTIFICATION SERVICES

2. EUT DESCRIPTION

The EUT is a 1900MHz iBurst Commercial Base Station with 5MHz band (8 carrier) at TDMA / SDMA access method, has an output power of 40.62dBm / 11.535W (Peak Conducted Power with 8 carrier), and 58.5dBm / 707.95W (EIRP Output Power with 8 carrier @ 12 antennas = $10\log(12)$), which is designed for the bands transmitting of frequency range 1905MHz to 1910MHz.

3. TEST METHODOLOGY

Both conducted and radiated testing were performed according to the procedures documented on chapter 13 of ANSI C63.4 and FCC CFR 47 2.1046, 2.1047, 2.1049, 2.1051, 2.1053, 2.1055 and 2.1057.

4. TEST FACILITY

The open area test sites and conducted measurement facilities used to collect the radiated data are located at 561F Monterey Road, Morgan Hill, California, USA. The sites are constructed in conformance with the requirements of ANSI C63.7, ANSI C63.4 and CISPR Publication 22.

5. ACCREDITATION AND LISTING

The test facilities used to perform radiated and conducted emissions tests are accredited by National Voluntary Laboratory Accreditation Program for the specific scope of accreditation under Lab Code: 200065-0 to perform Electromagnetic Interference tests according to FCC PART 15 AND CISPR 22 requirements. No part of this report may be used to claim or imply product endorsement by NVLAP or any agency of the US Government. In addition, the test facilities are listed with Federal Communications Commission (reference no: 31040/SIT (1300B3) and 31040/SIT (1300F2))

6. MEASURING INSTRUMENT CALIBRATION

The measuring equipment, which was utilized in performing the tests documented herein, has been calibrated in accordance with the manufacturer's recommendations for utilizing calibration equipment, which is traceable to recognized national standards.

7. TEST SETUP, PROCEDURE AND RESULT

7.1. SECTION 2.1046: RF POWER OUTPUT

INSTRUMENTS LIST

TEST EQUIPMENT LIST				
Name of Equipment	Manufacturer	Model No.	Serial No.	Due Date
Spectrum Analyzer	Agilent	E4446A	MY43360112	1/13/2005
Amplifier 1-26GHz	MITEQ	NSP2600-SP	924342	4/25/2005
Antenna, Horn 1 ~ 18 GHz	EMCO	3115	6717	2/4/2005
Antenna, Horn 1 ~ 18 GHz	EMCO	3115	3328	2/4/2005
Peak Power Meter	Agilent	E4416A	GB41291160	11/7/2004
10dB Attenuator	Weinschel	56-10	M2348	CNR
Signal Generator	R & S	SMP04	DE34210	5/25/2005
20dB Attenuator	Weinschel	WA33-20	A210	CNR
50 ohm Terminator	TDC	N/A	N/A	N/A

TEST SETUP

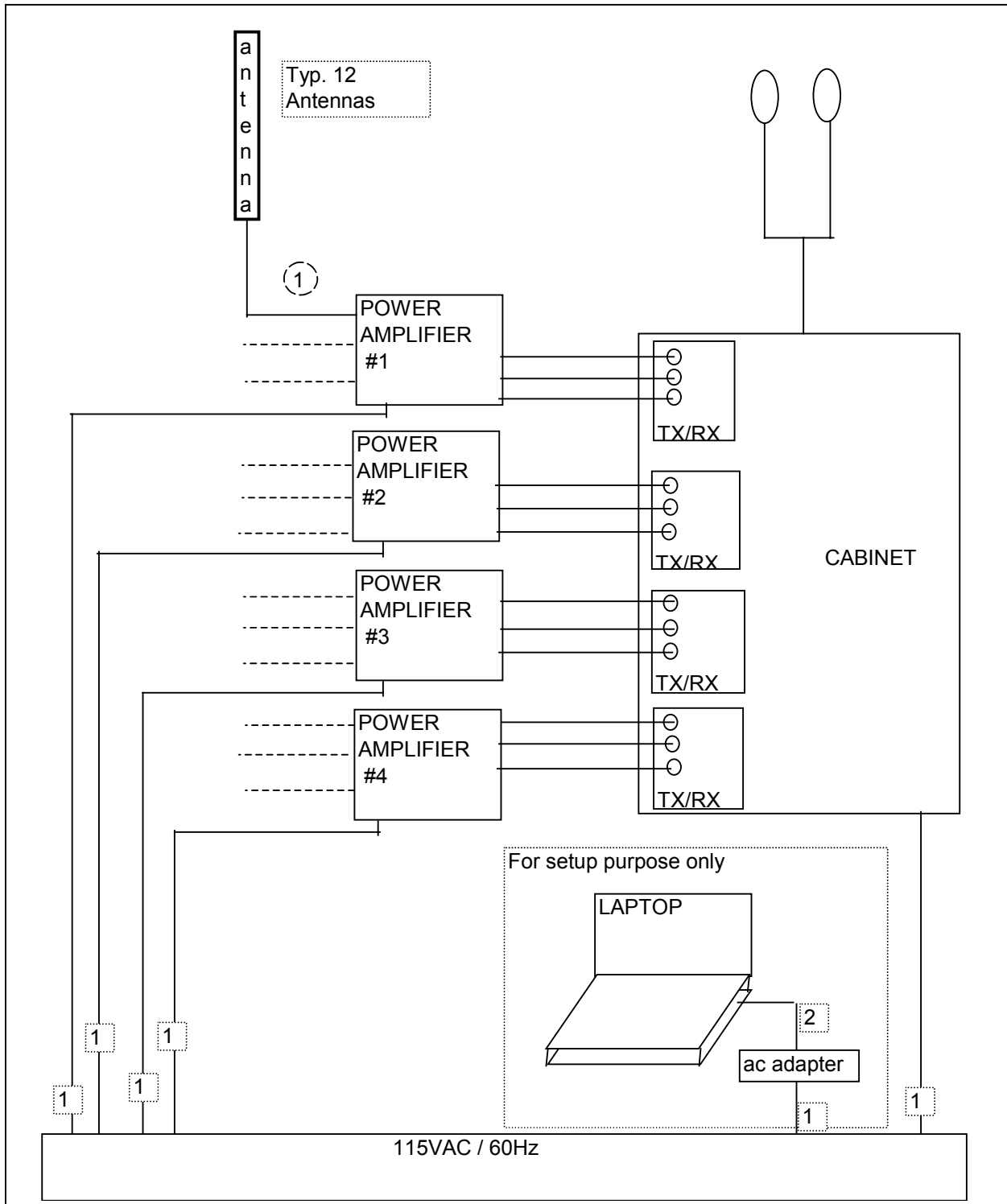

MEASUREMENT PROCEDURE

- 1). On a test site, the EUT shall be placed on a turntable, and in the position closest to the normal use as declared by the user.
- 2). The test antenna shall be oriented initially for vertical polarization located 3m from the EUT to correspond to the frequency of the transmitter.
- 3). The output of the test antenna shall be connected to the measuring receiver and either a peak or quasi-peak detector was used for the measurement as indicated on the report. The detector selection is based on how close the emission level was approaching the limit.
- 4). The transmitter shall be placed 0.80 meter above the ground plane, the X, Y, and Z positions shall be tested and the worst case reported if necessary. The transmitter shall be switched on with typical modulation and the measurement receiver shall be tuned to the frequency of the transmitter under test.
- 5). The test antenna shall be raised and lowered through the specified range of height until a maximum signal level is detected by the measuring receiver.
- 6). The transmitter shall than be rotated through 360° in the horizontal plane, until the maximum signal level is detected by the measuring receiver.
- 7). The test antenna shall be raised and lowered again through the specified range of height until a maximum signal level is detected by the measuring receiver.
- 8). The maximum signal level detected by the measuring receiver shall be noted.
- 9). The transmitter shall be replaced by a tuned dipole (substitution antenna).
- 10). The substitution antenna shall be oriented for vertical polarization and the length of the substitution antenna shall be adjusted to correspond to the frequency of the transmitter.
- 11). The substitution antenna shall be connected to a calibrated signal generator.
- 12). If necessary, the input attenuator setting of the measuring receiver shall be adjusted in order to increase the sensitivity of the measuring receiver.
- 13). The test antenna shall be raised and lowered through the specified range of the height to ensure that the maximum signal is received.

14). The input signal to the substitution antenna shall be adjusted to the level that produces a level detected by the measuring receiver, that is equal to the level noted while the transmitter radiated power was measured, corrected for the change of input attenuation setting of the measuring receiver.

15). The input level to the substitution antenna shall be recorded as power level in dBm, corrected for any change of input attenuator setting of the measuring receiver.

16). The measurement shall be repeated with the test antenna and the substitution antenna oriented for horizontal polarization.

17). The measure of the effective radiated power is the larger of the two levels recorded, at the input to the substitution antenna, corrected for the gain of the substitution antenna if necessary.

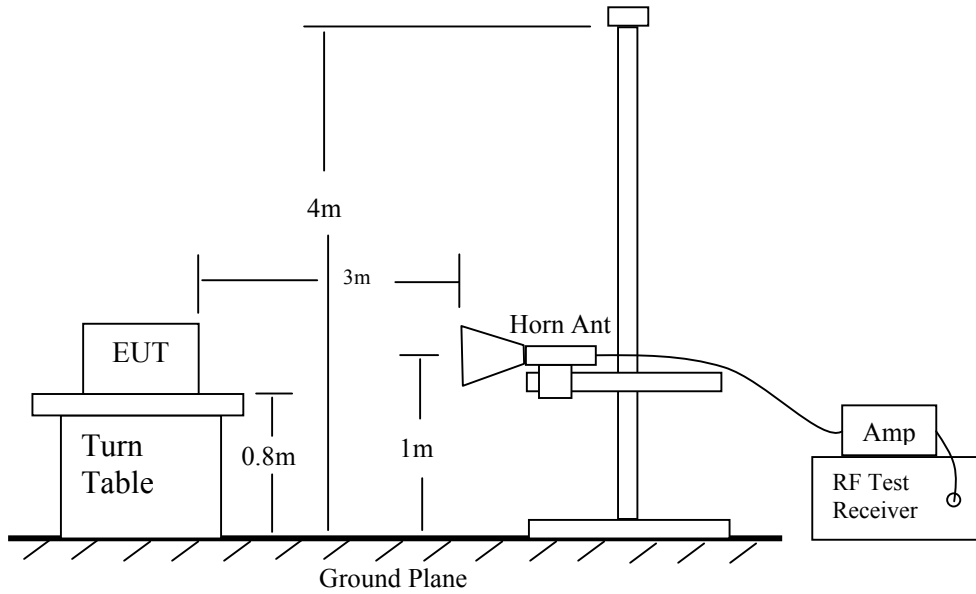

Radiated Emission Above 1000 MHz

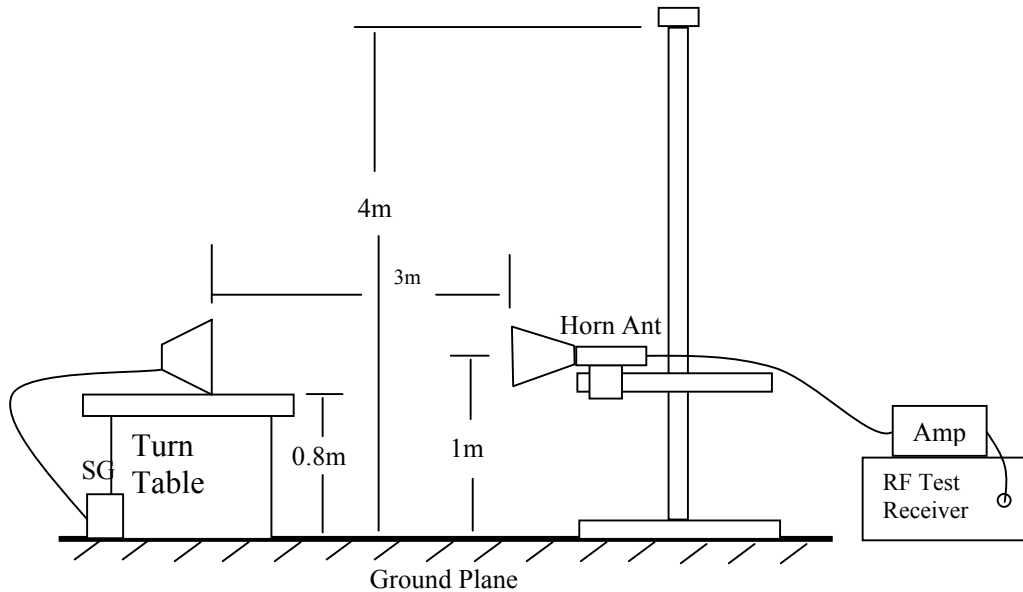

Radiated Emission – Substitution Method setup

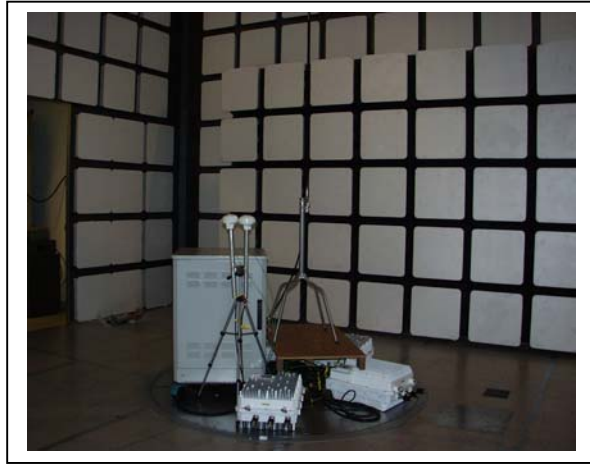

Test result:

RF Conducted Output Power:

BPSK

	Single Carrier			8 Carriers	
	Freq. (MHz)	Peak (dBm)	Ave (dBm)	Peak (dBm)	Ave (dBm)
Low Ch.	1905.3125	35.45	29.20	39.12	31.32
High Ch.	1909.6875	34.85	29.23	39.61	31.32

QPSK

	Single Carrier			8 Carriers	
	Freq. (MHz)	Peak (dBm)	Ave (dBm)	Peak (dBm)	Ave (dBm)
Low Ch.	1905.3125	35.32	29.23	40.30	31.32
High Ch.	1909.6875	35.31	29.2	39.97	31.32

8PSK

	Single Carrier			8 Carriers	
	Freq. (MHz)	Peak (dBm)	Ave (dBm)	Peak (dBm)	Ave (dBm)
Low Ch.	1905.3125	35.25	29.14	40.20	31.30
High Ch.	1909.6875	35.14	29.2	40.1	31.34

12QAM

	Single Carrier			8 Carriers	
	Freq. (MHz)	Peak (dBm)	Ave (dBm)	Peak (dBm)	Ave (dBm)
Low Ch.	1905.3125	36.57	29.30	39.40	31.33
High Ch.	1909.6875	36.64	29.33	39.25	31.32

16QAM

	Single Carrier			8 Carriers	
	Freq. (MHz)	Peak (dBm)	Ave (dBm)	Peak (dBm)	Ave (dBm)
Low Ch.	1905.3125	37.69	29.30	40.62	31.32
High Ch.	1909.6875	37.08	29.22	39.54	31.34

24QAM

	Single Carrier			8 Carriers	
	Freq. (MHz)	Peak (dBm)	Ave (dBm)	Peak (dBm)	Ave (dBm)
Low Ch.	1905.3125	37.36	29.33	39.97	31.36
High Ch.	1909.6875	37.47	29.18	39.81	31.33

Radiated Output Power (EIRP):

RBW=VBW=1MHz >26dB of EBW

f GHz	SA reading (dBuV)	SG reading (dBm)	CL (dB)	Gain (dBi)	Gain (dBd)	EIRP (dBm)	Limit (dBm)	Margin (dB)	Notes
BPSK									
LOW CH 1905.3125MHz									
1.905	112.5	45.2	2.2	7.9	5.8	50.9	62.0	-11.1	PK, Vert @ worst polarization
HI CH 1909.6875MHz									
1.910	113.9	46.6	2.2	7.9	5.8	52.3	62.0	-9.7	PK, Vert @ worst polarization
QPSK									
LOW CH 1905.3125MHz									
1.905	112.5	45.2	2.2	7.9	5.8	50.9	62.0	-11.1	PK, Vert @ worst polarization
HI CH 1909.6875MHz									
1.910	113.9	46.6	2.2	7.9	5.8	52.3	62.0	-9.7	PK, Vert @ worst polarization
8PSK									
LOW CH 1905.3125MHz									
1.905	113.8	46.5	2.2	7.9	5.8	52.2	62.0	-9.8	PK, Vert @ worst polarization
HI CH 1909.6875MHz									
1.910	114.3	47.0	2.2	7.9	5.8	52.7	62.0	-9.3	PK, Vert @ worst polarization
12QAM									
LOW CH 1905.3125MHz									
1.905	115.6	48.3	2.2	7.9	5.8	54.0	62.0	-8.0	PK, Vert @ worst polarization
HI CH 1909.6875MHz									
1.910	115.6	48.3	2.2	7.9	5.8	54.0	62.0	-8.0	PK, Vert @ worst polarization
16QAM									
LOW CH 1905.3125MHz									
1.905	116.6	49.3	2.2	7.9	5.8	55.0	62.0	-7.0	PK, Vert @ worst polarization
HI CH 1909.6875MHz									
1.910	115.7	48.4	2.2	7.9	5.8	54.1	62.0	-7.9	PK, Vert @ worst polarization
24QAM									
LOW CH 1905.3125MHz									
1.905	115.7	48.4	2.2	7.9	5.8	54.1	62.0	-7.9	PK, Vert @ worst polarization
HI CH 1909.6875MHz									
1.910	115.3	48.0	2.2	7.9	5.8	53.7	62.0	-8.3	PK, Vert @ worst polarization
8 Carriers Operating in the same time @ worst modulation type of 16QAM									
1.90800	120.1	52.8	2.2	7.9	5.8	58.5	62.0	-3.5	PK, Vert @ worst polarization

Note: the reading including $10 \times \log(12 \text{ antennas}) = 10.8 \text{ dB}$ due to the measurement of each antenna

7.2. SECTION 2.1047: MODULATION CHARACTERISTICS

Not applicable.

7.3. SECTION 2.1049: OCCUPIED BANDWIDTH

INSTRUMENTS LIST

TEST EQUIPMENT LIST				
Name of Equipment	Manufacturer	Model No.	Serial No.	Due Date
Spectrum Analyzer	Agilent	E4446A	MY43360112	1/13/2005
Peak Power Meter	Agilent	E4416A	GB41291160	11/7/2004
10dB Attenuator	Weinschel	56-10	M2348	CNR
20dB Attenuator	Weinschel	WA33-20	A210	CNR
50 ohm Terminator	TDC	N/A	N/A	N/A

TEST SETUP

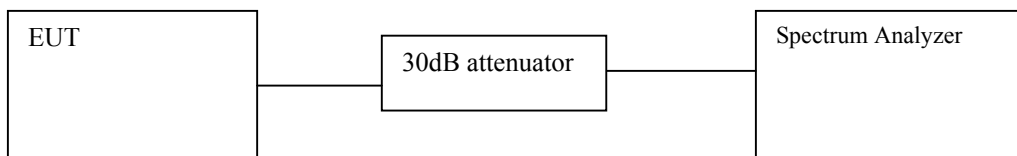

TEST PROCEDURE

The EUT's output RF connector (made solely for the purpose of the test) was connected with a short cable to the spectrum analyzer, RES BW was set to about 1% of emission BW, -26dBc display line was placed on the screen (or 99% bandwidth), the occupied BW is the delta frequency between the two points where the display line intersects the signal trace.

RESULT

No non-compliance noted, reference only.

BPSK

	Freq. (MHz)	99% BW (KHz)	26dBc BW (KHz)
Low Ch.	1905.3125	525.266	606.000
High Ch.	1909.6875	528.555	599.508

QPSK

	Freq. (MHz)	99% BW (KHz)	26dBc BW (KHz)
Low Ch.	1905.3125	524.297	606.093
High Ch.	1909.6875	528.503	597.863

8PSK

	Freq. (MHz)	99% BW (KHz)	26dBc BW (KHz)
Low Ch.	1905.3125	553.020	599.410
High Ch.	1909.6875	552.473	603.493

12QAM

	Freq. (MHz)	99% BW (KHz)	26dBc BW (KHz)
Low Ch.	1905.3125	526.247	604.122
High Ch.	1909.6875	521.128	602.042

16QAM

	Freq. (MHz)	99% BW (KHz)	26dBc BW (KHz)
Low Ch.	1905.3125	527.779	600.855
High Ch.	1909.6875	560.437	606.320

24QAM

	Freq. (MHz)	99% BW (KHz)	26dBc BW (KHz)
Low Ch.	1905.3125	527.368	601.972
High Ch.	1909.6875	558.900	603.859

BPSK Modulation:

Low Channel

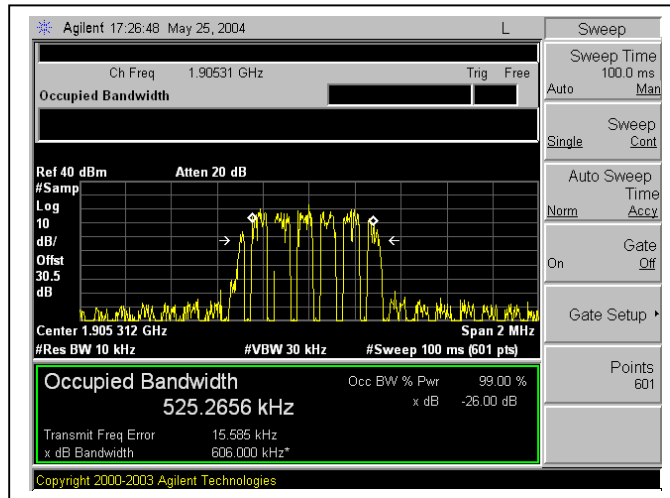

High Channel:

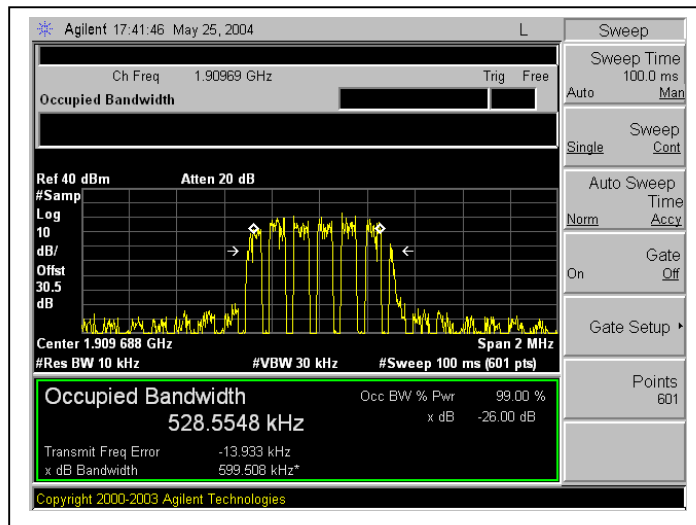

QPSK Modulation:

Low Channel

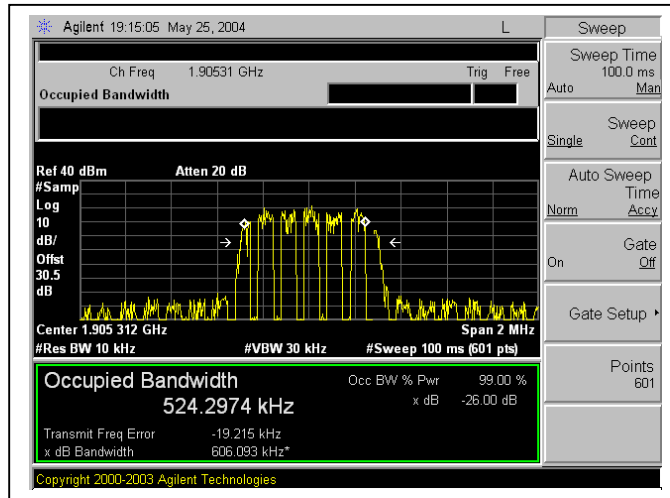

High Channel:

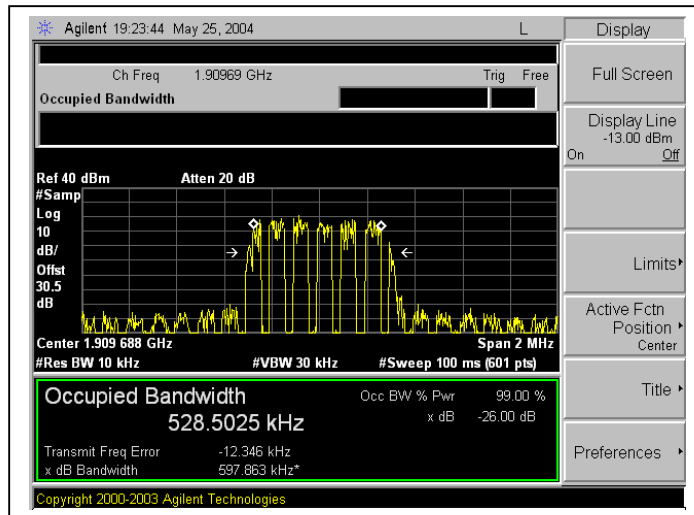

8PSK Modulation:

Low Channel

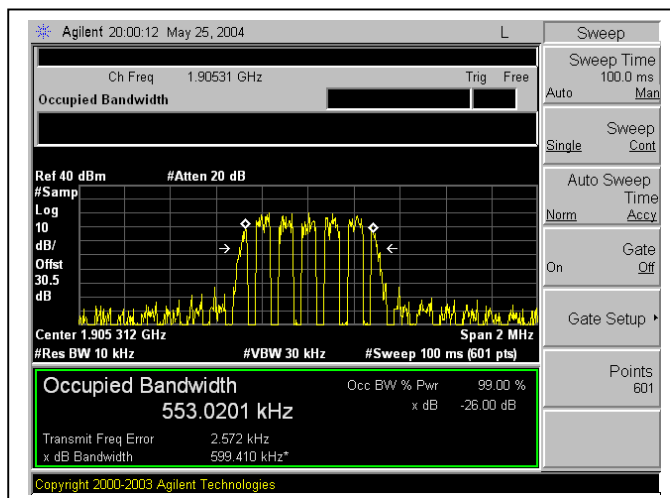

High Channel:

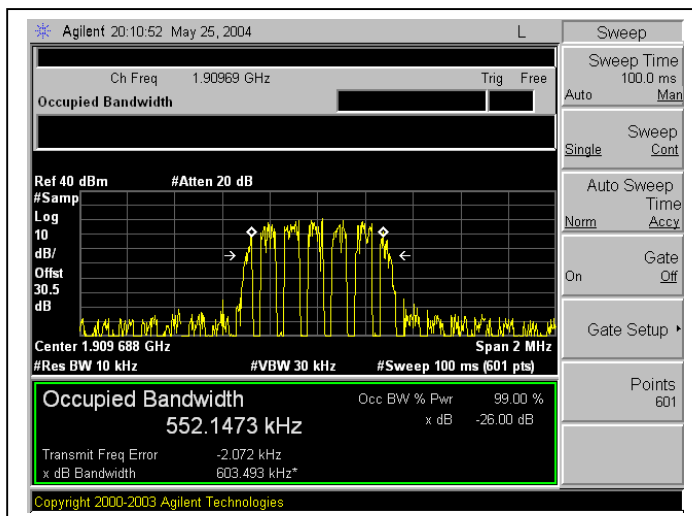

12QAM Modulation:

Low Channel

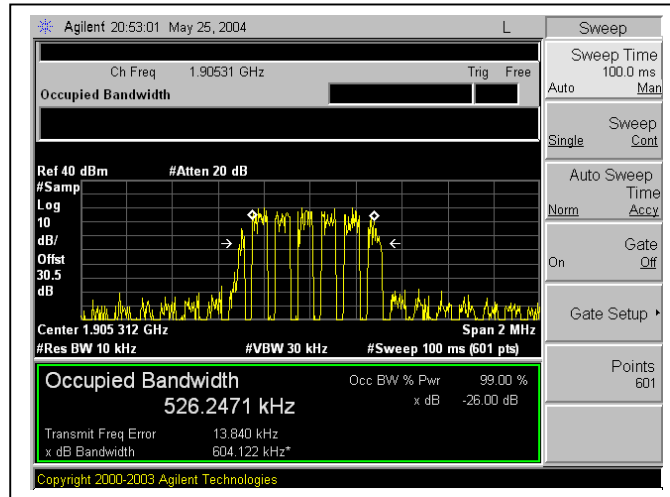

High Channel:

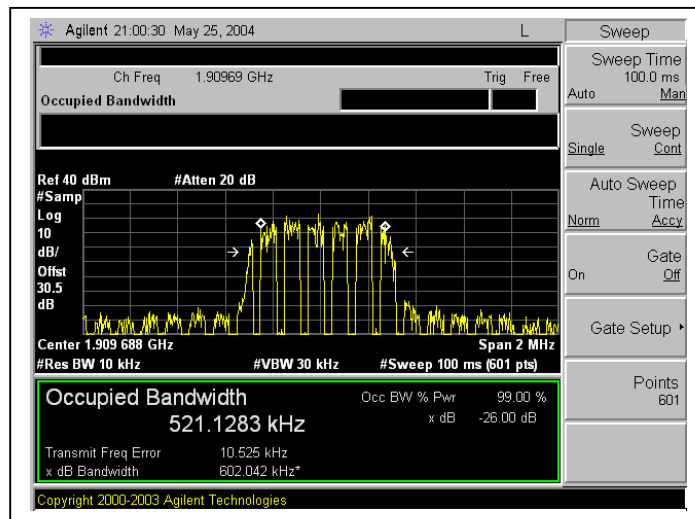

16QAM Modulation:

Low Channel

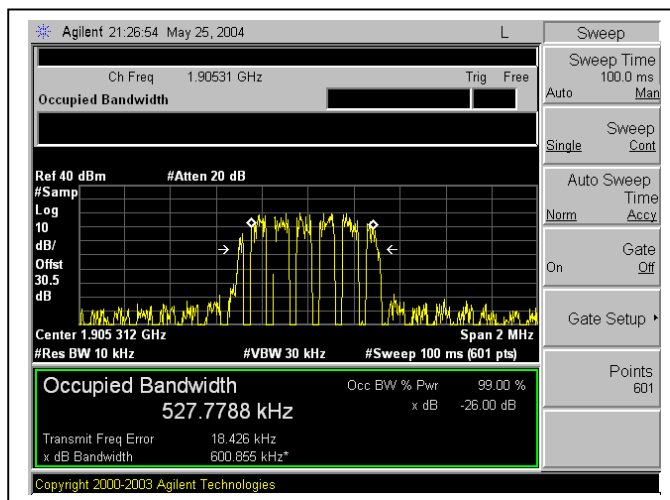

High Channel:

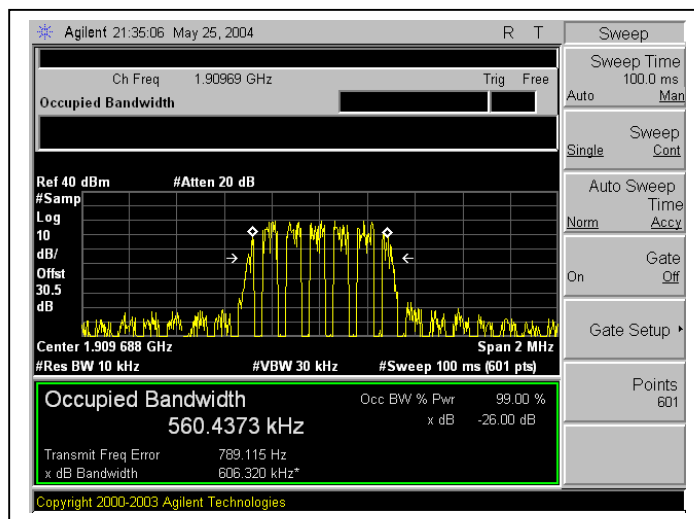

24QAM Modulation:

Low Channel

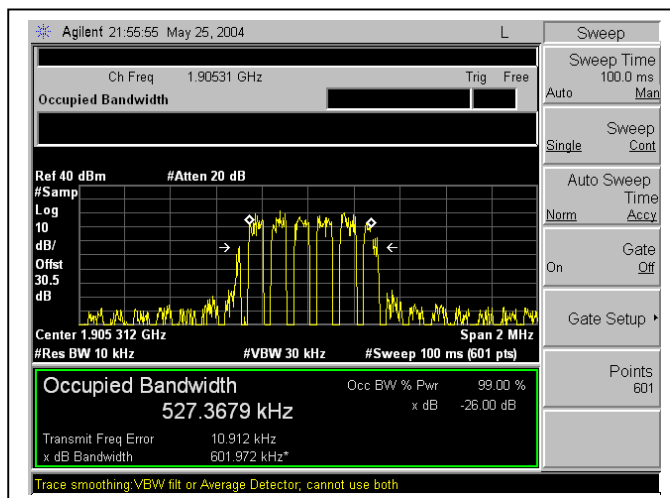

High Channel:

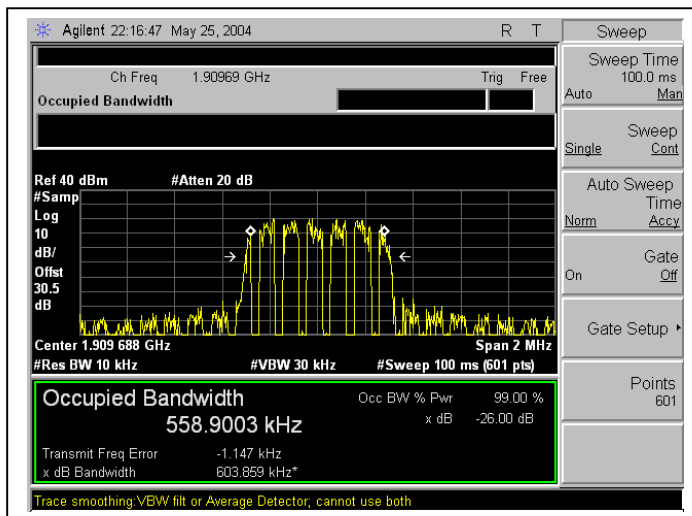

7.4. SECTION 2.1051: SPURIOUS EMISSION AT ANTENNA TERMINAL

INSTRUMENTS LIST

TEST EQUIPMENT LIST				
Name of Equipment	Manufacturer	Model No.	Serial No.	Due Date
Spectrum Analyzer	Agilent	E4446A	MY43360112	1/13/2005
Peak Power Meter	Agilent	E4416A	GB41291160	11/7/2004
10dB Attenuator	Weinschel	56-10	M2348	CNR

TEST SETUP

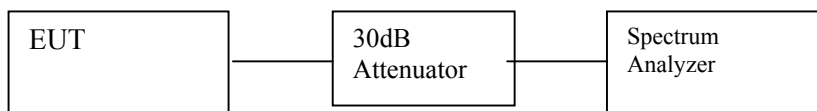

TEST PROCEDURE

- 1) RF signal or three balanced signals (intermodulation measurement) were applied to the RF input. One set as close as possible to the bottom of the block edge and one set as close as possible to the top of the block edge. Set the RES BW to 1% of the emission bandwidth to show compliance with the -13dBm limit, in the 1 MHz bands immediately outside and adjacent to the top and bottom edges of the frequency block.
- 2) For the Out-of-Band measurements a 1 MHz RES BW was used to scan from 15 MHz to $10 \times f_0$ of the fundamental carrier for all frequency block. A display line was placed at -13dBm to show compliance for spurious, harmonics, and intermodulation emissions.

RESULT:

BPSK Modulation: Band Edges, Out-Of-Band Emissions

Low Channel Band Edge

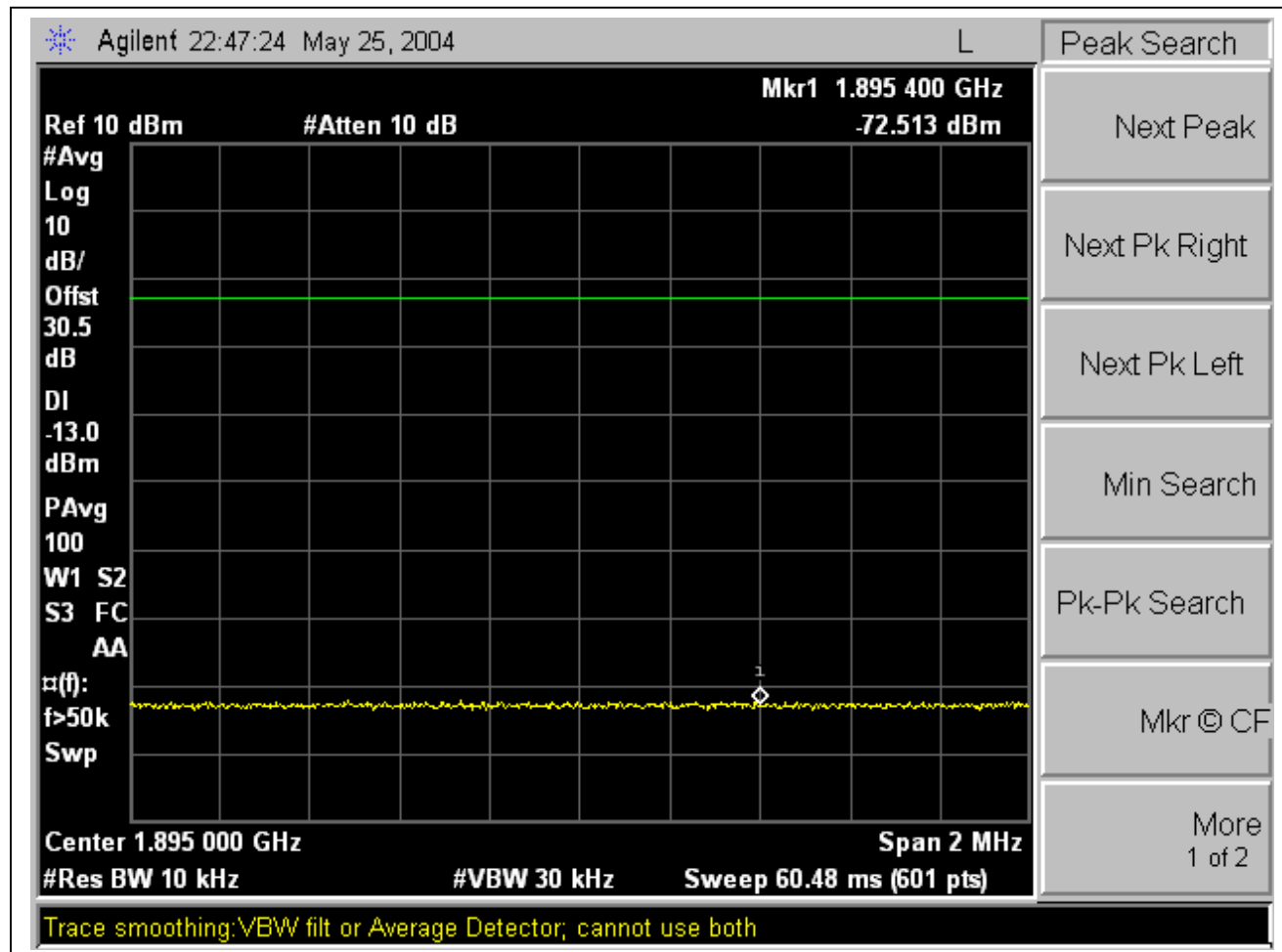

High Channel Band Edge

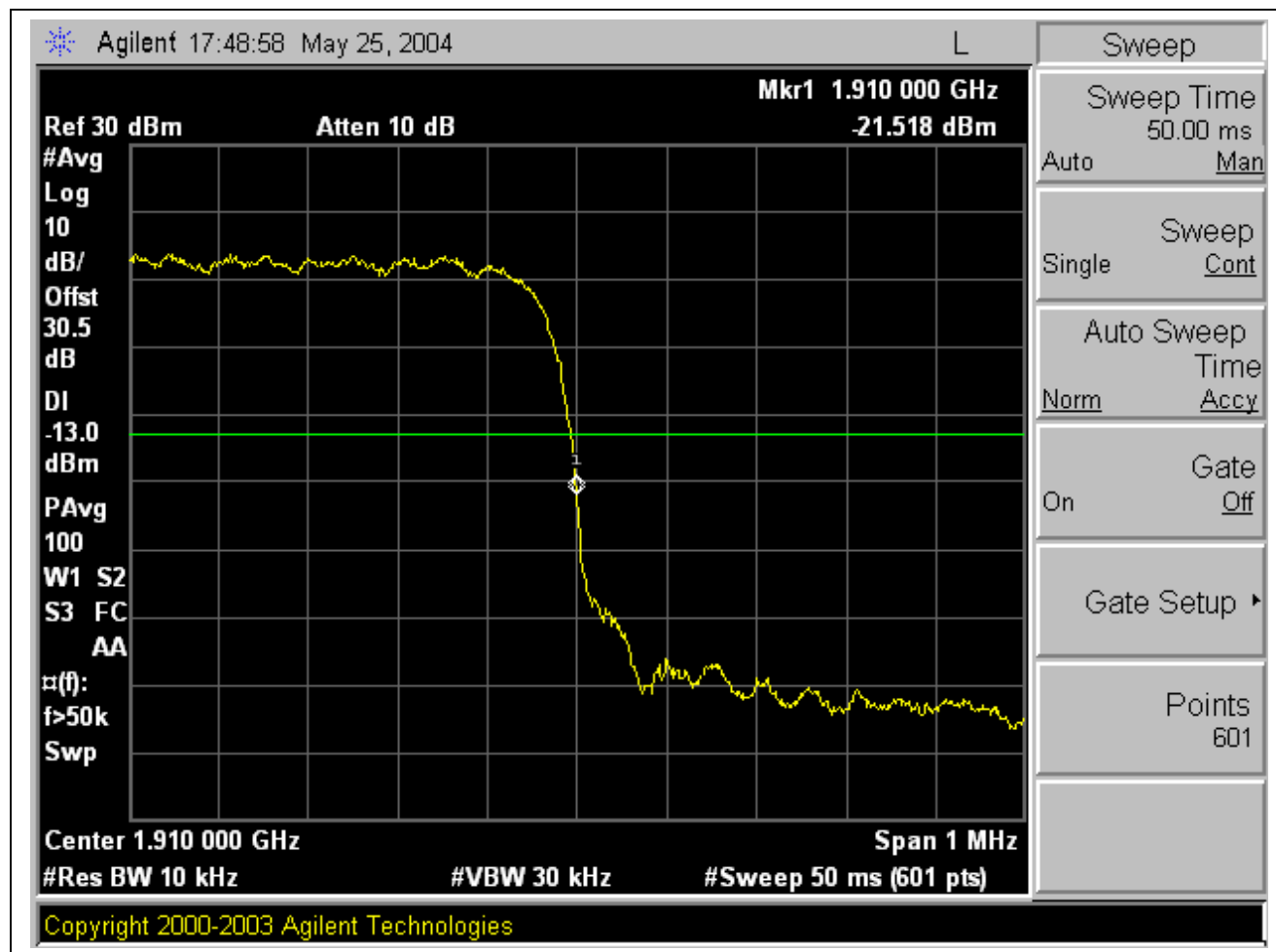

Low Channel, Out-Of-Band Emissions

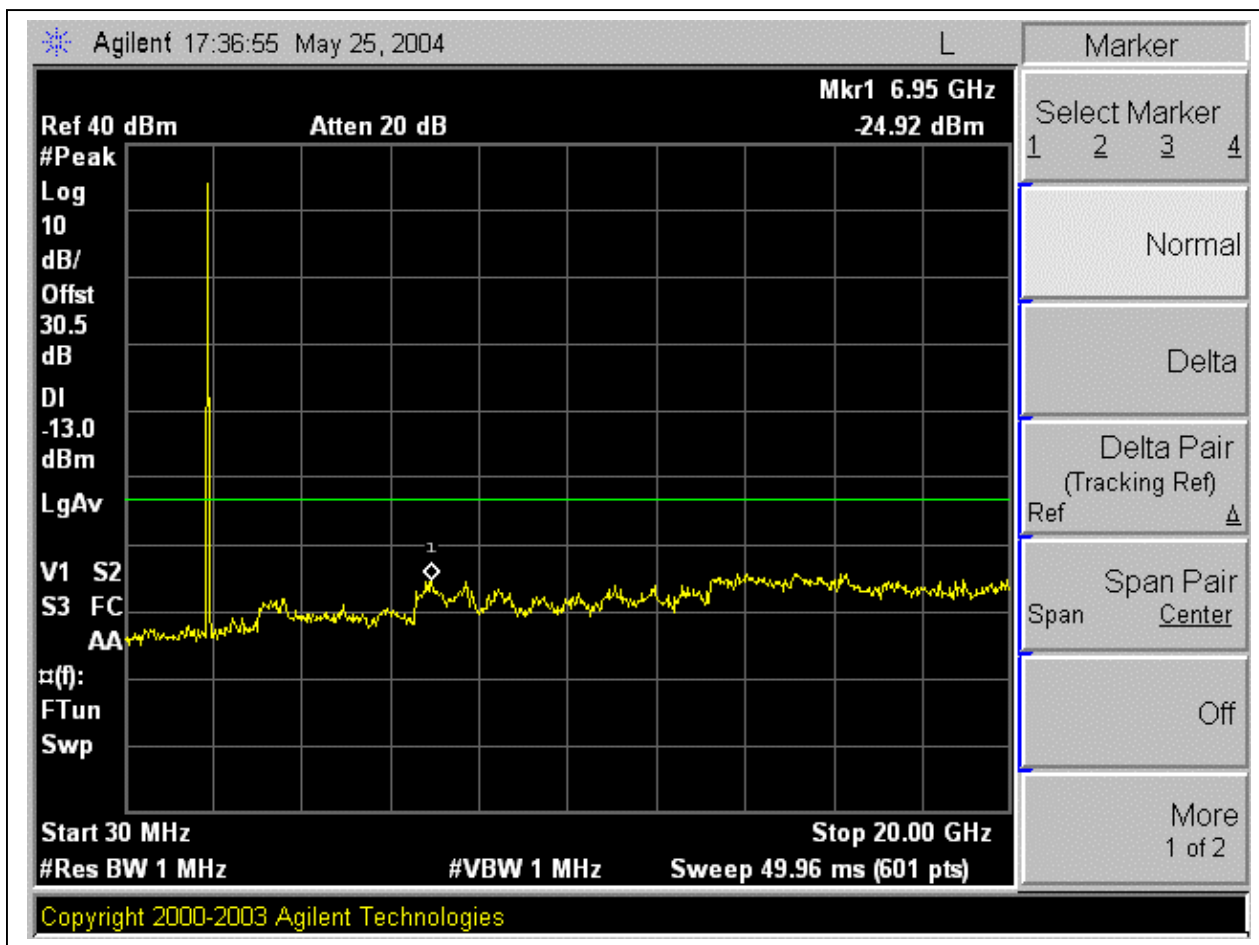

High Channel, Out-Of-Band Emissions

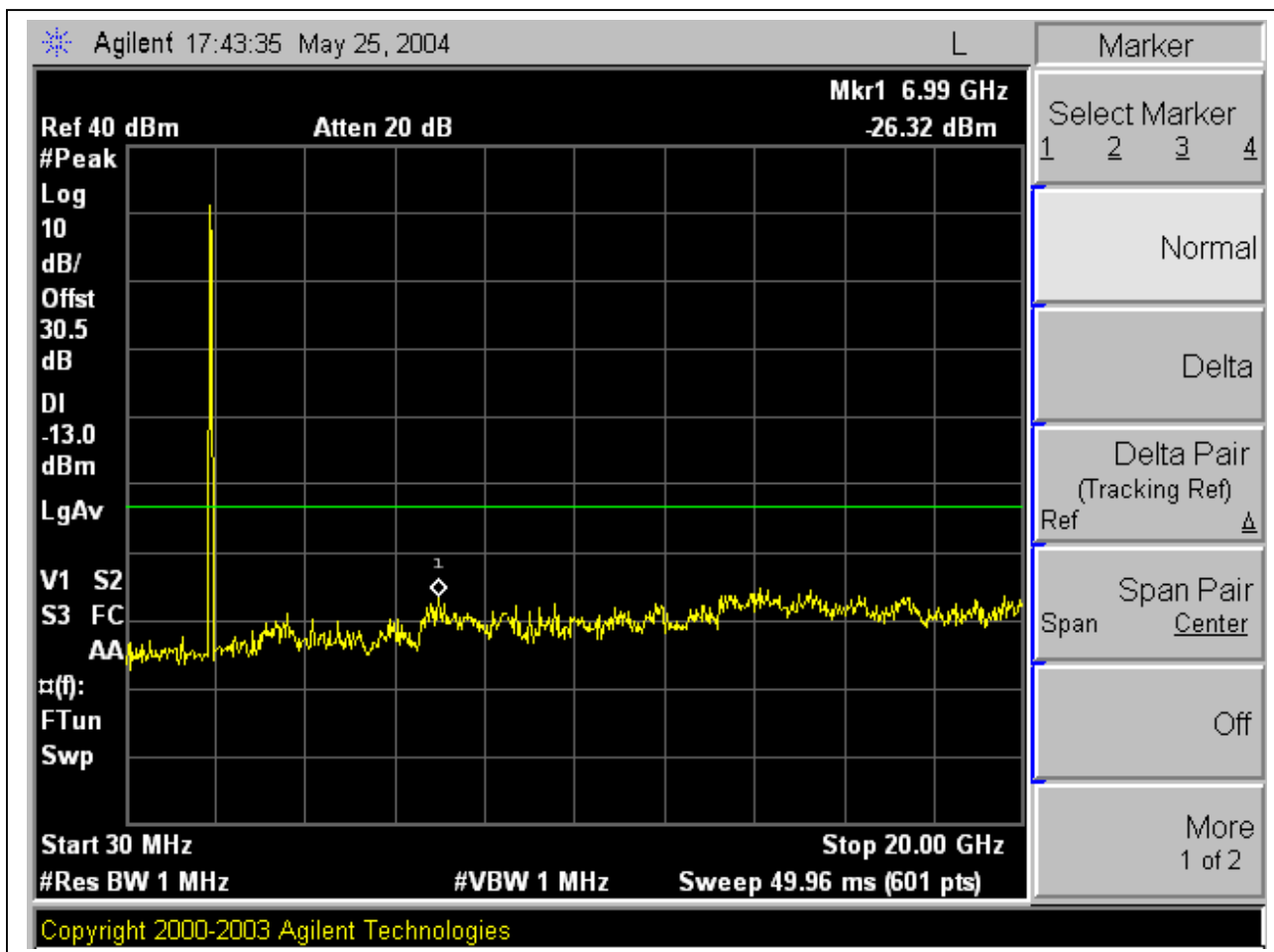

QPSK Modulation: Band Edges, Out-Of-Band Emissions

Low Channel Band Edge

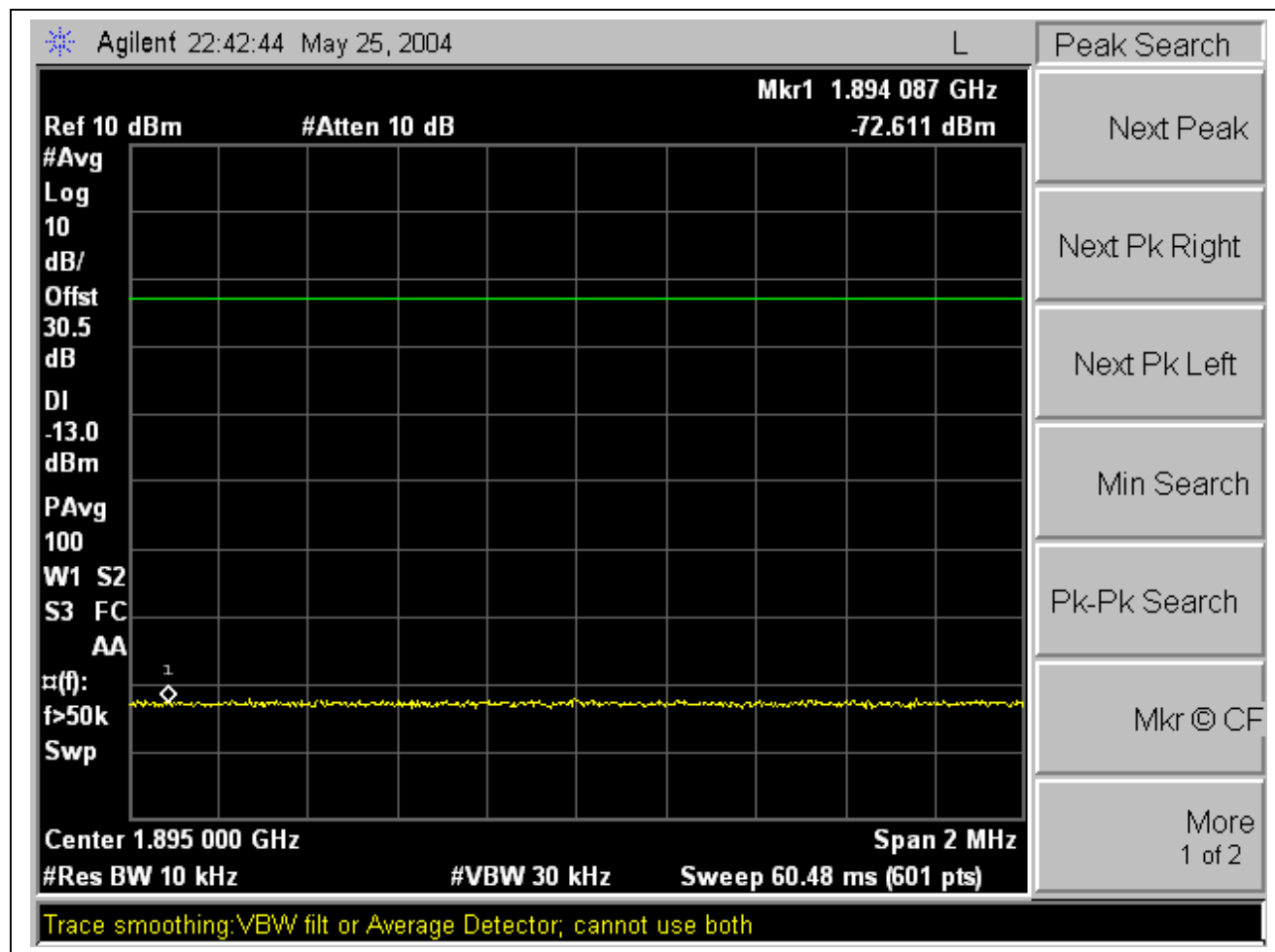

High Channel Band Edge

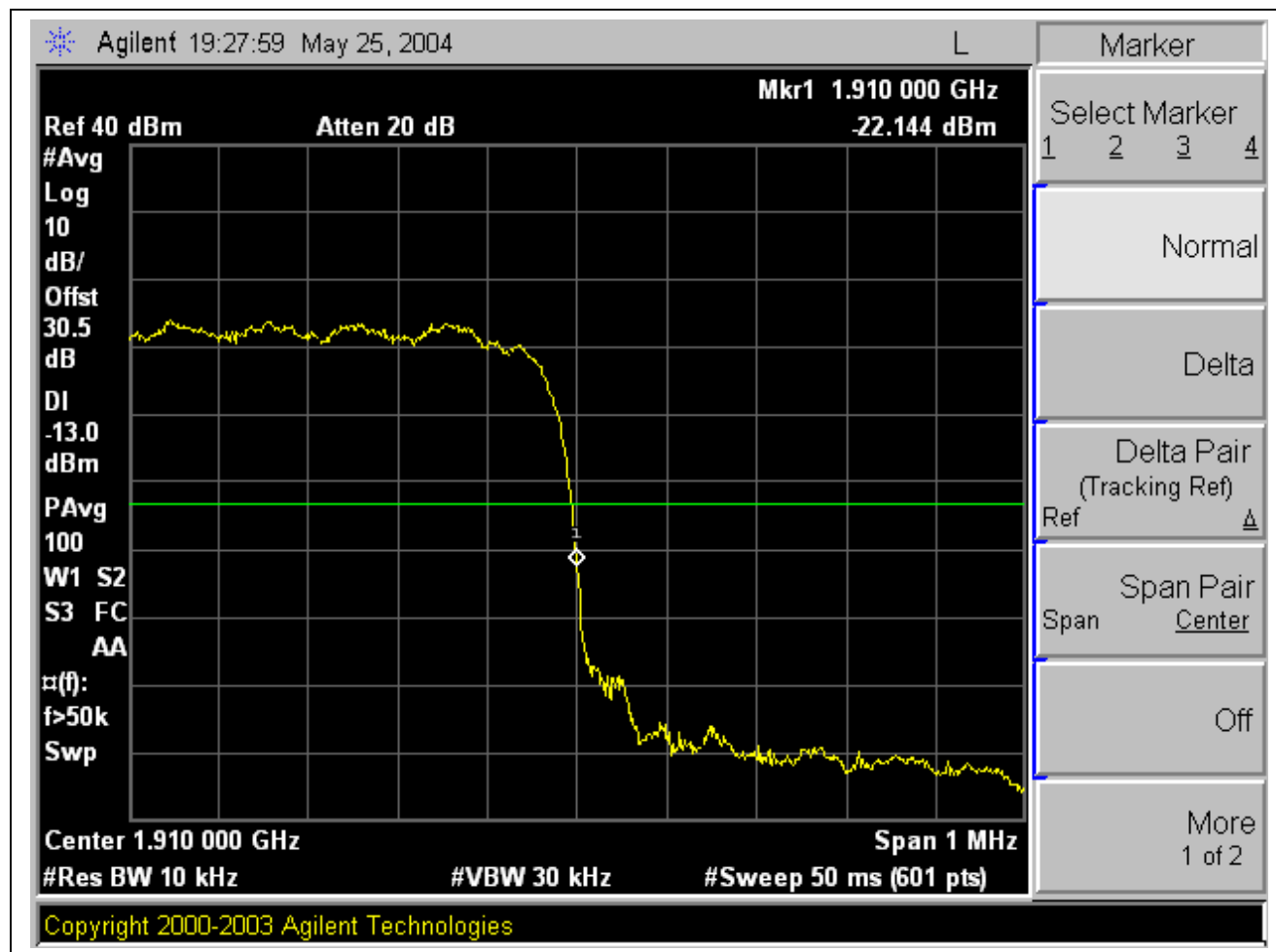

Low Channel, Out-Of-Band Emissions

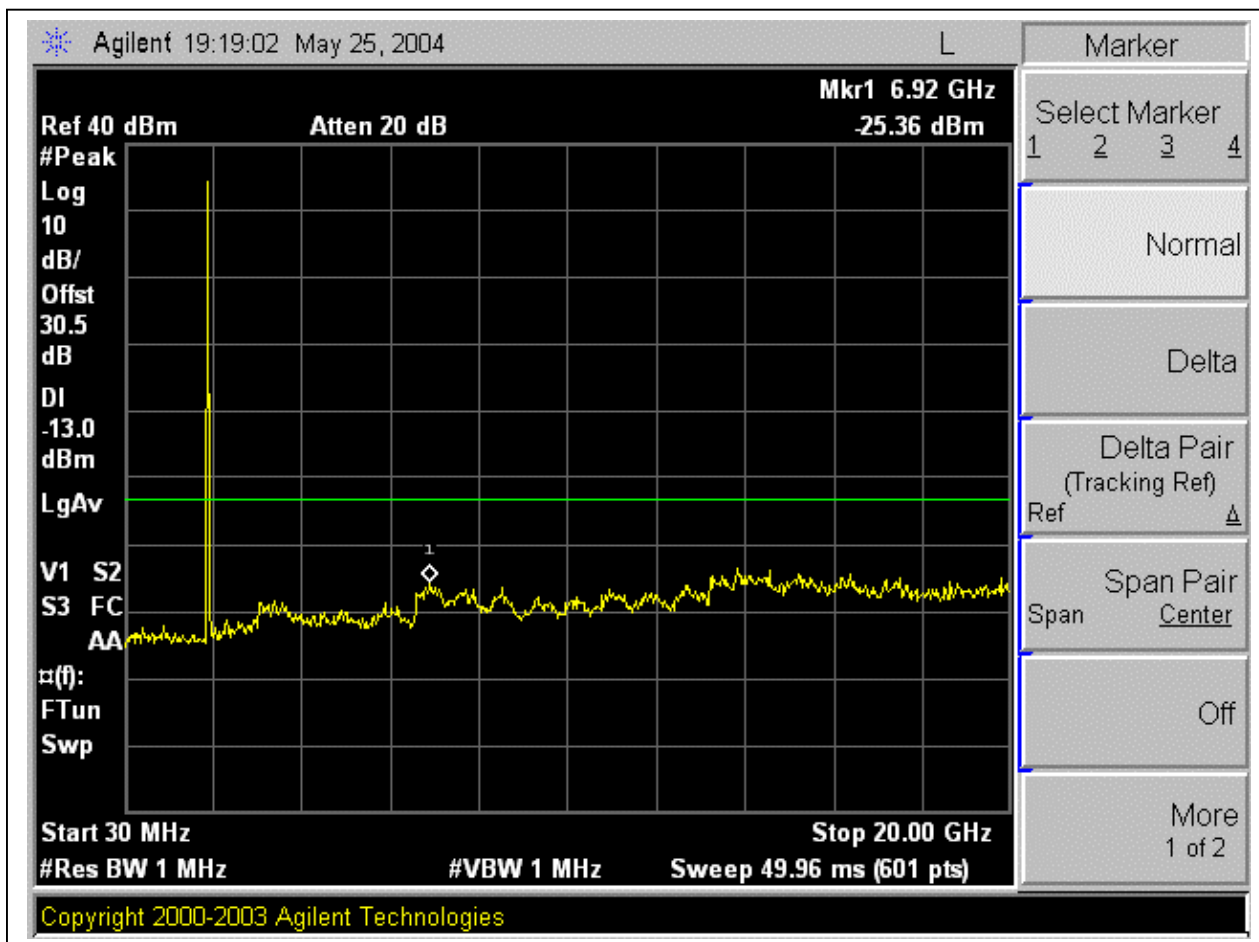

High Channel, Out-Of-Band Emissions

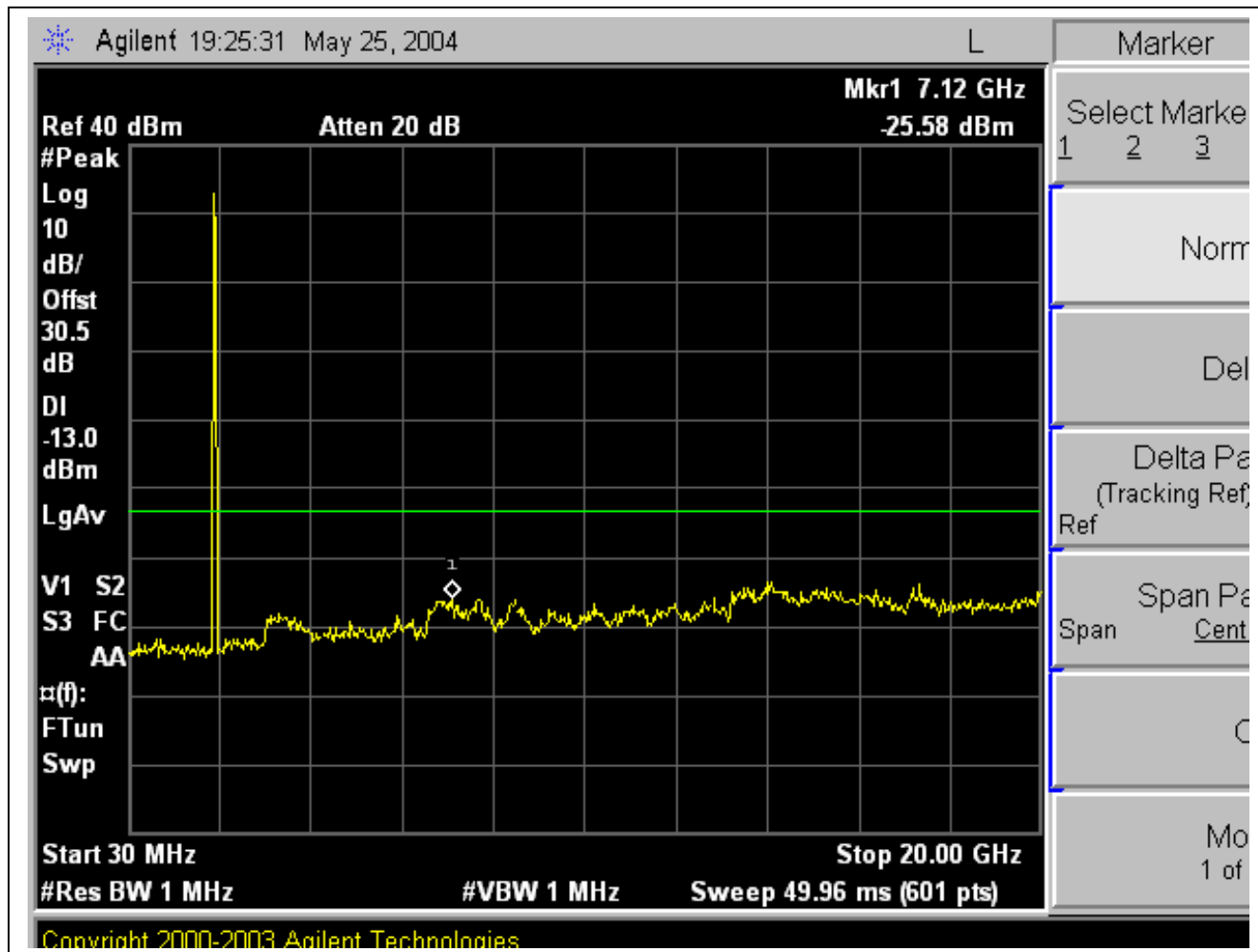

8PSK Modulation: Band Edges, Out-Of-Band Emissions

Low Channel Band Edge

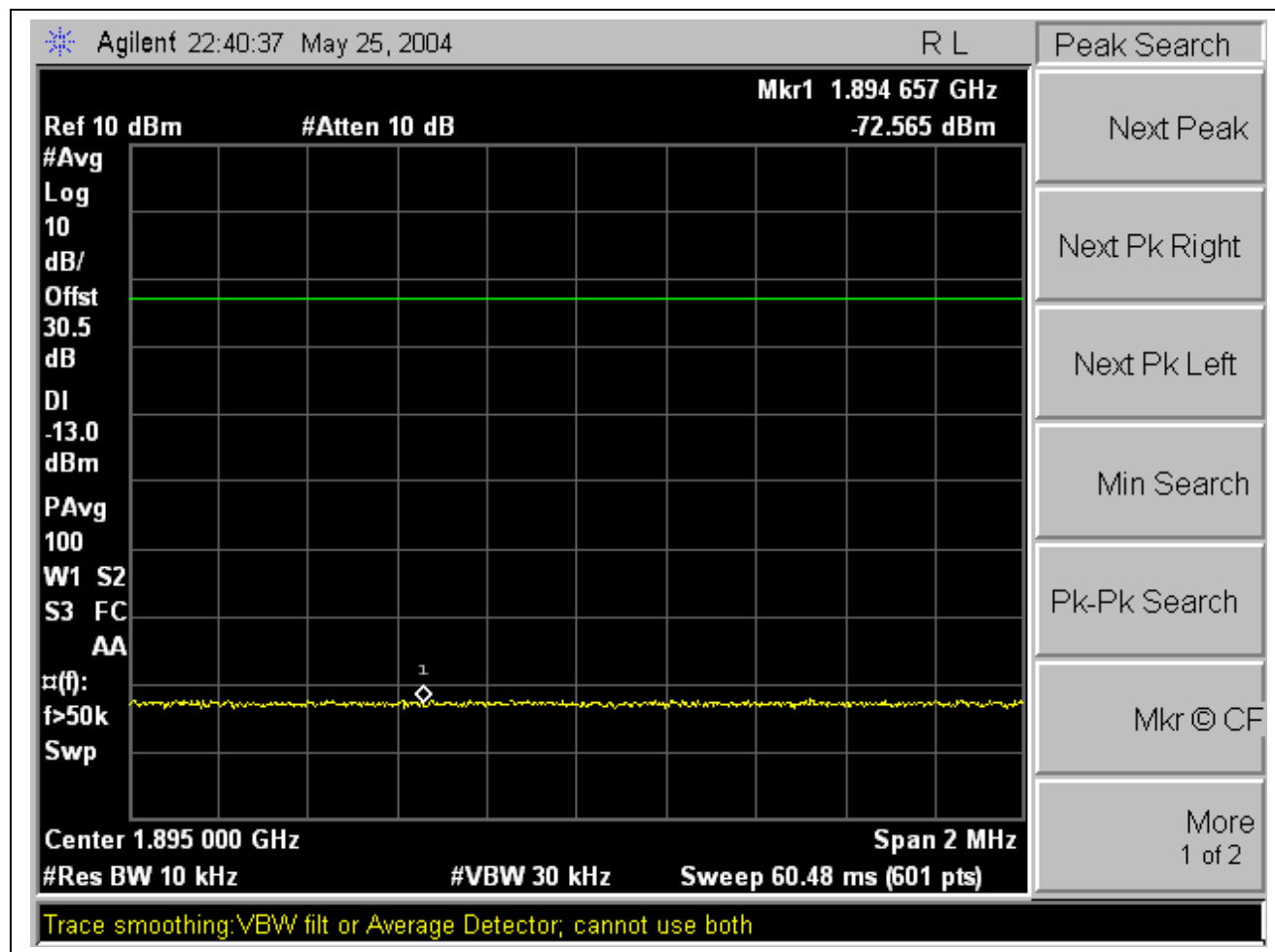

High Channel Band Edge

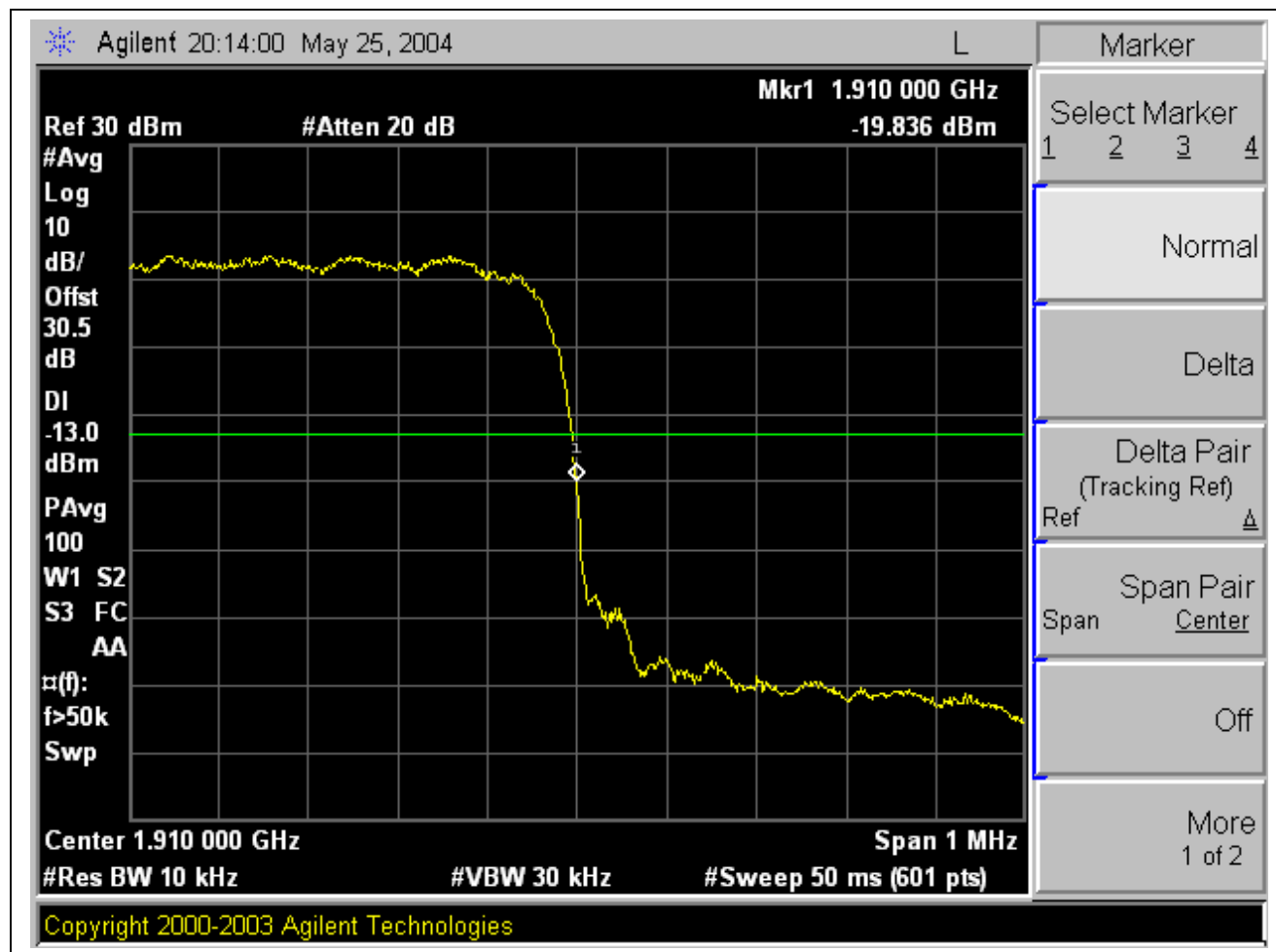

Low Channel, Out-Of-Band Emissions

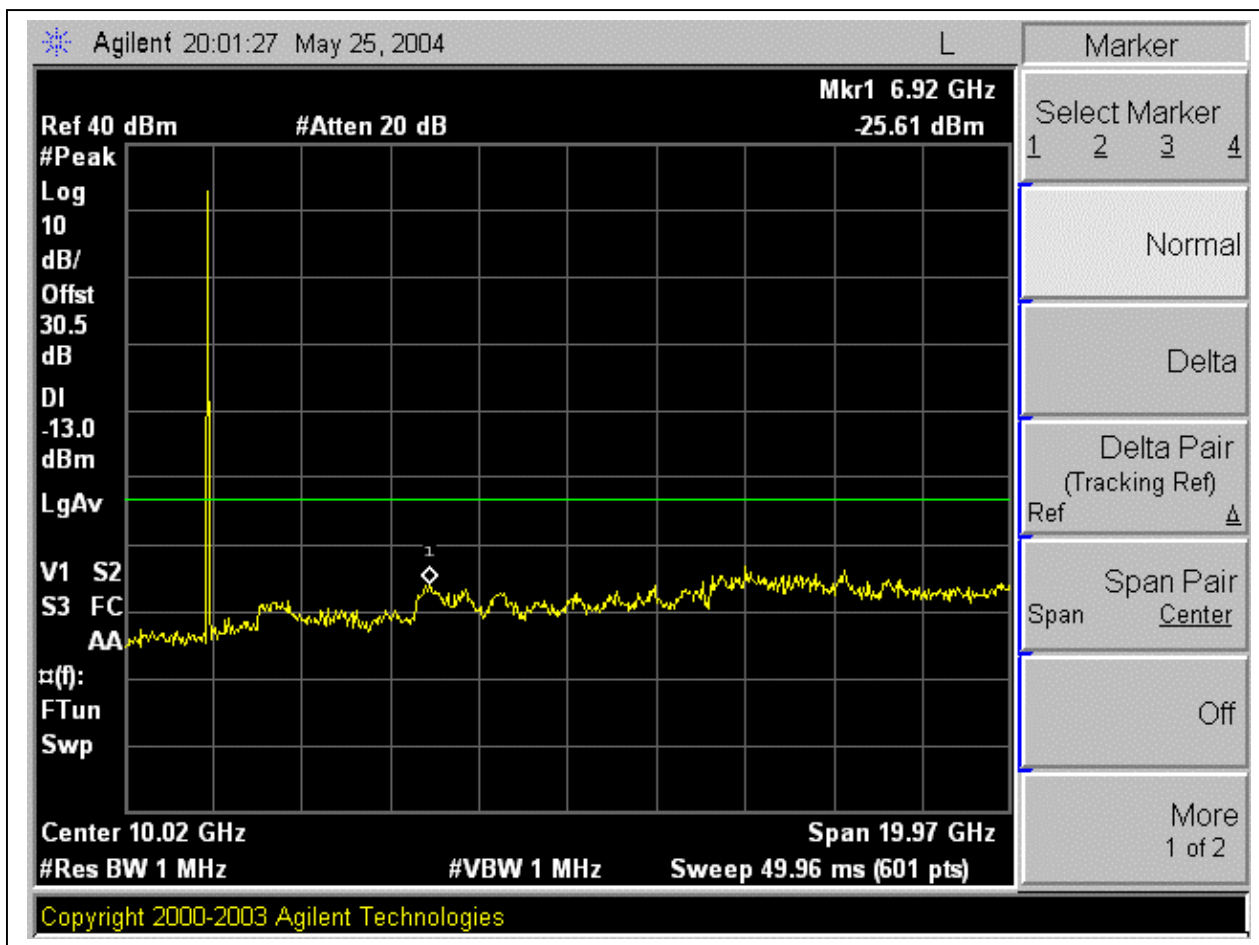

High Channel, Out-Of-Band Emissions

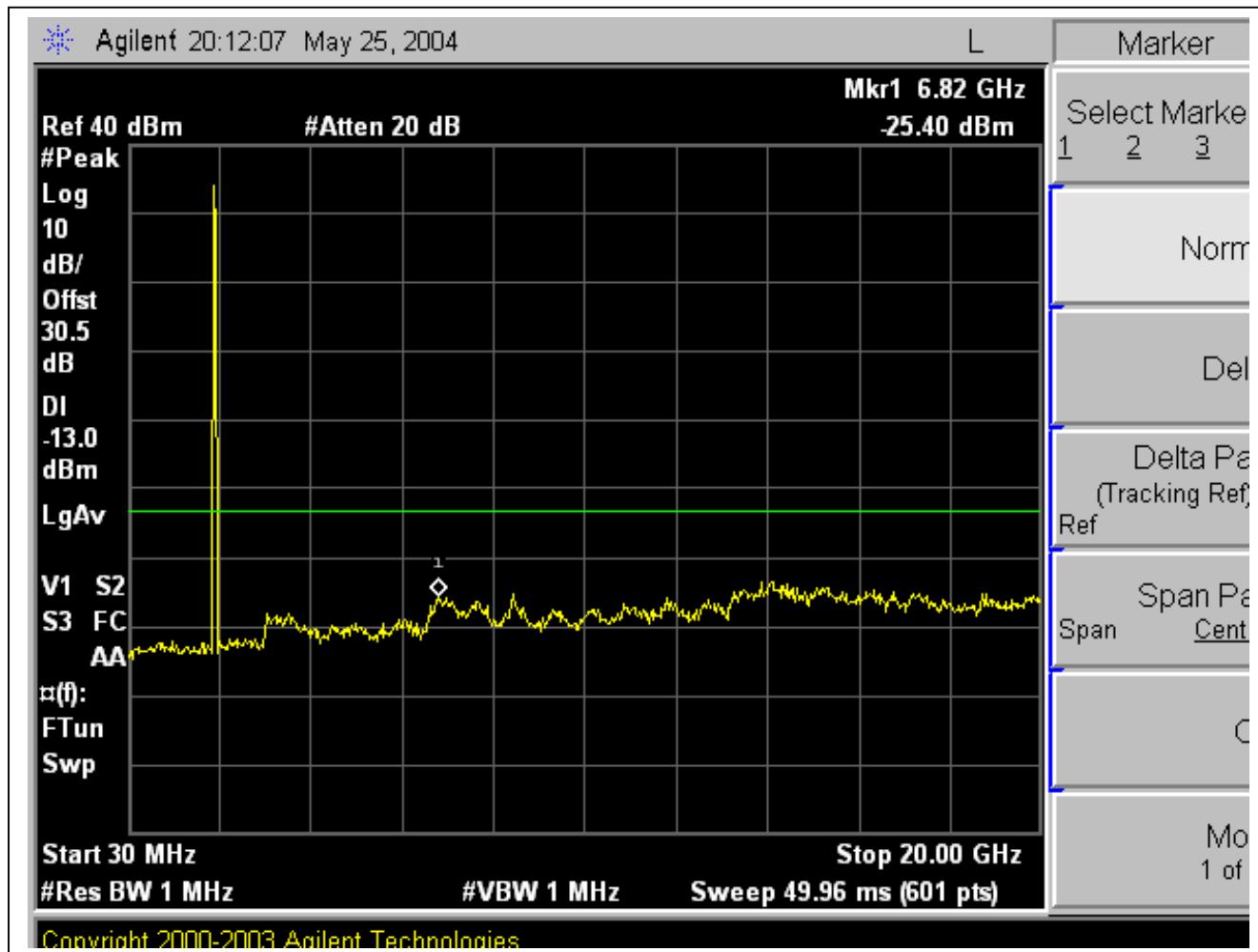

12QAM Modulation: Band Edges, Out-Of-Band Emissions

Low Channel Band Edge

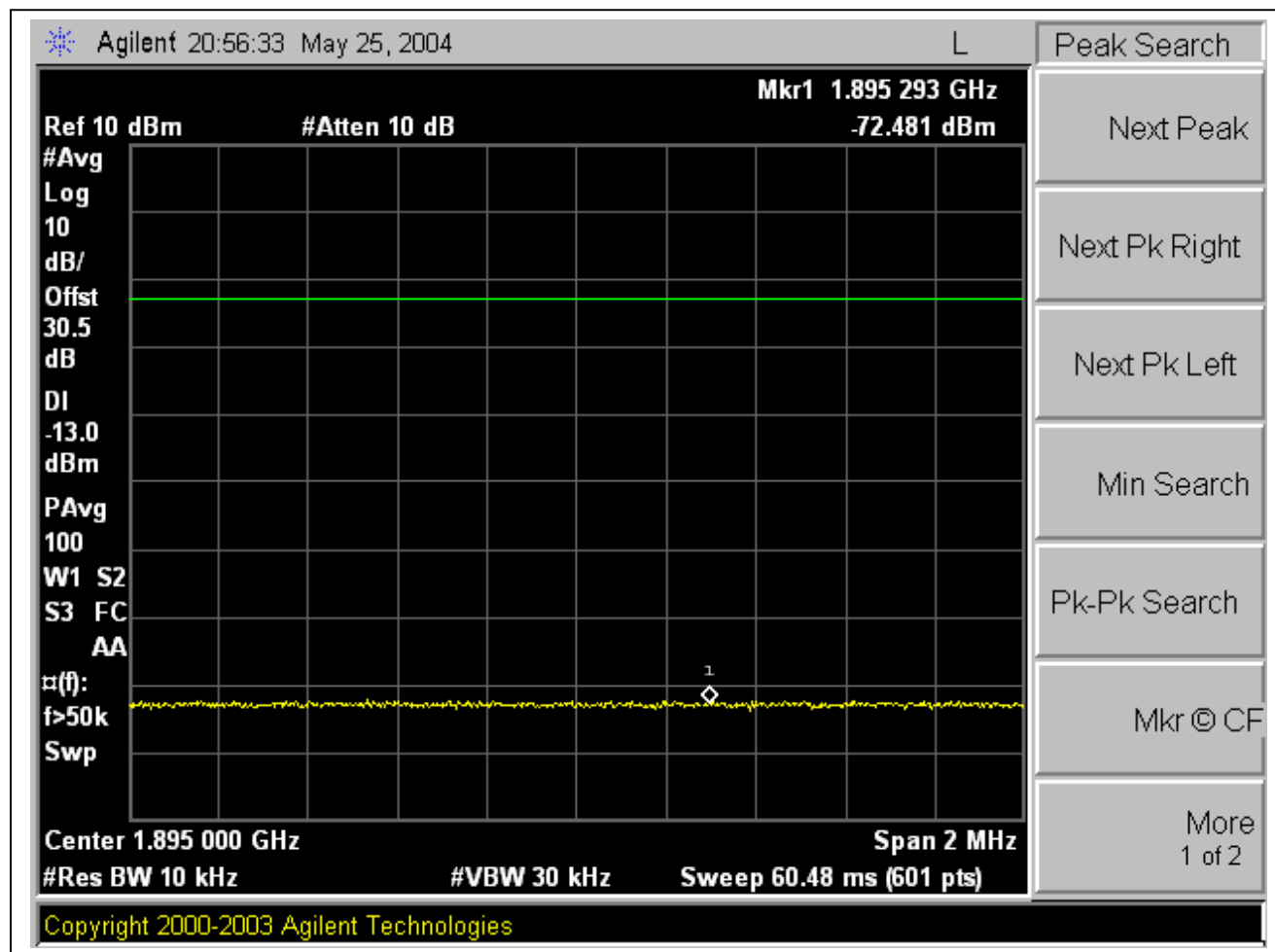

High Channel Band Edge

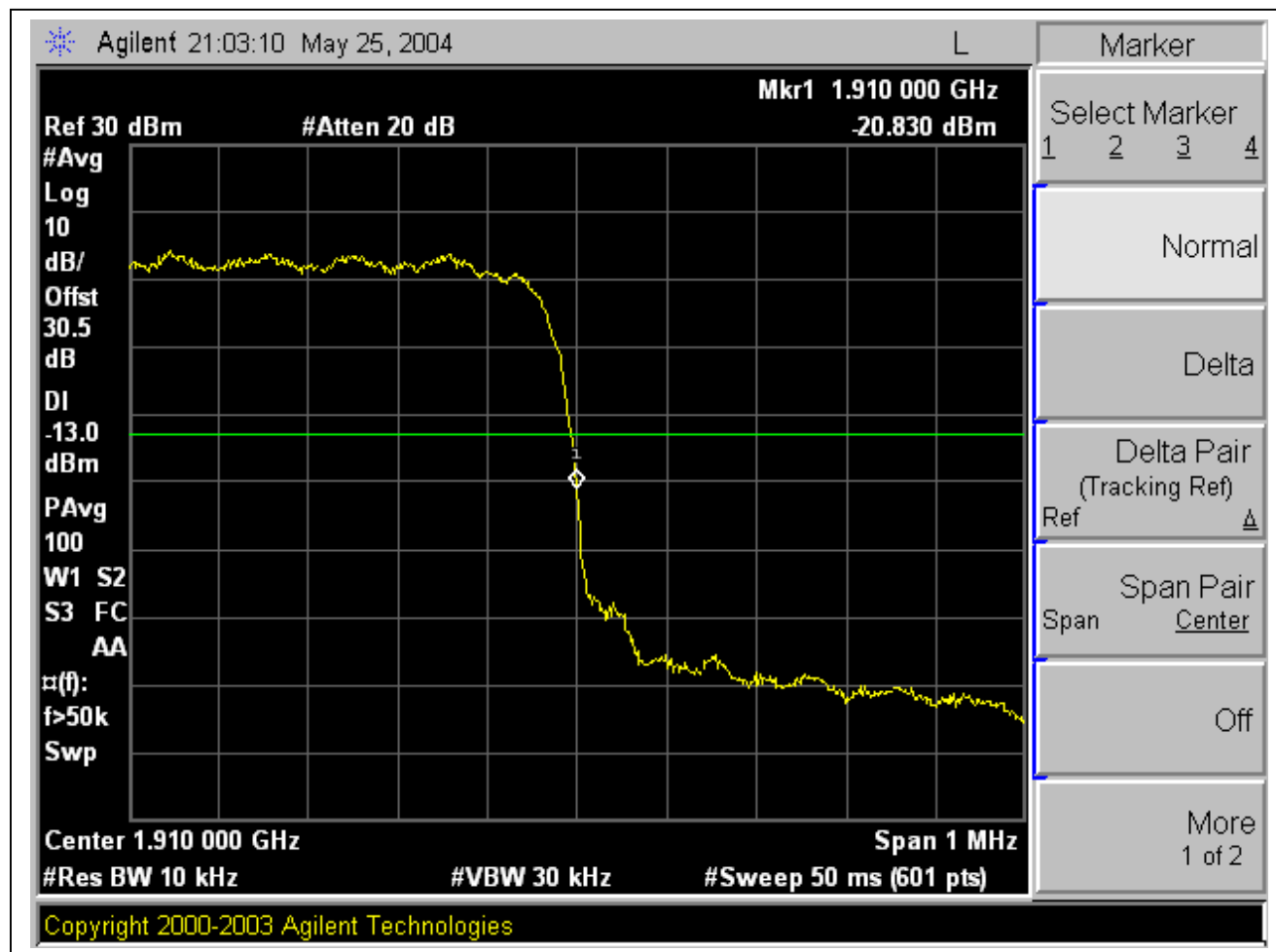

Low Channel, Out-Of-Band Emissions

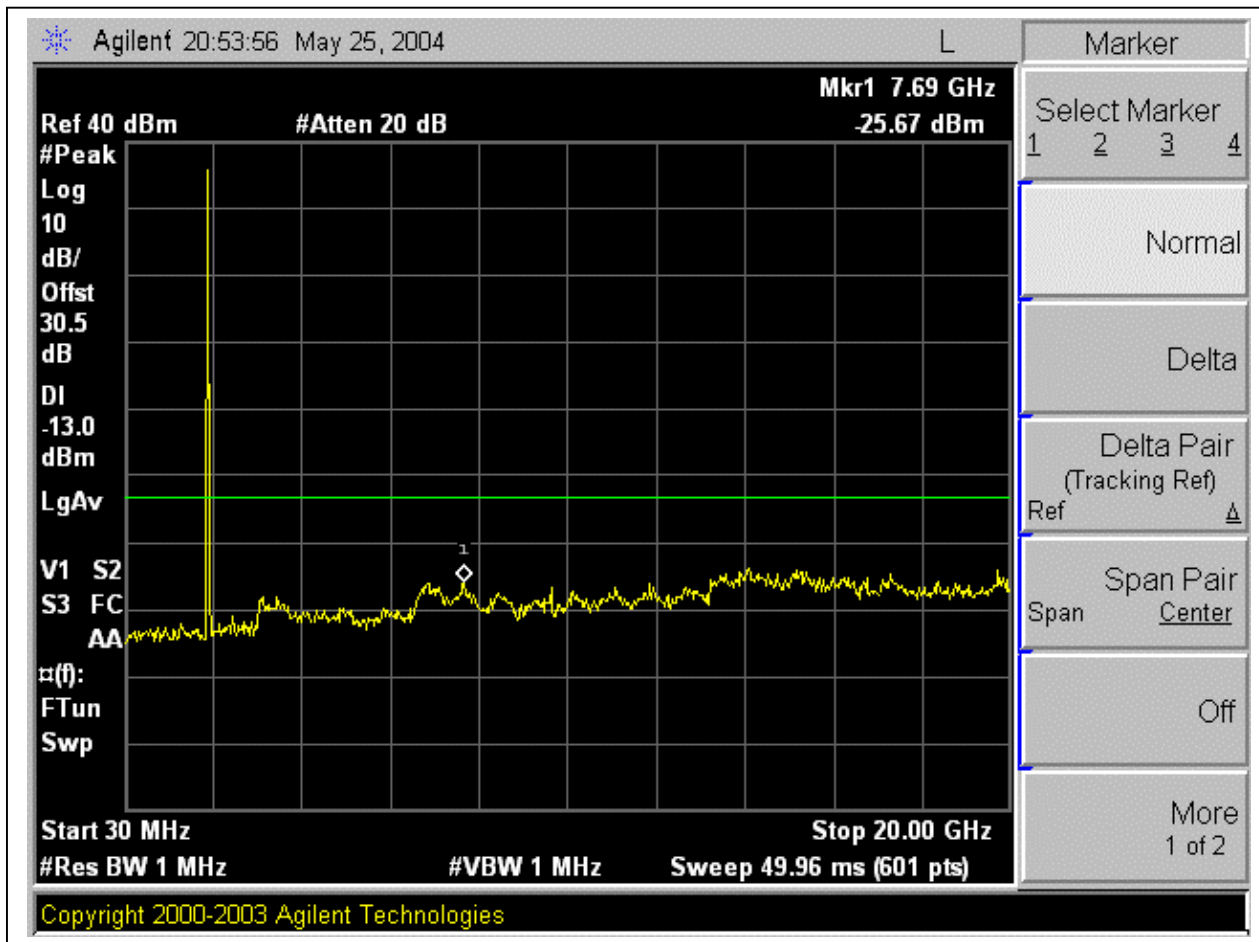

High Channel, Out-Of-Band Emissions

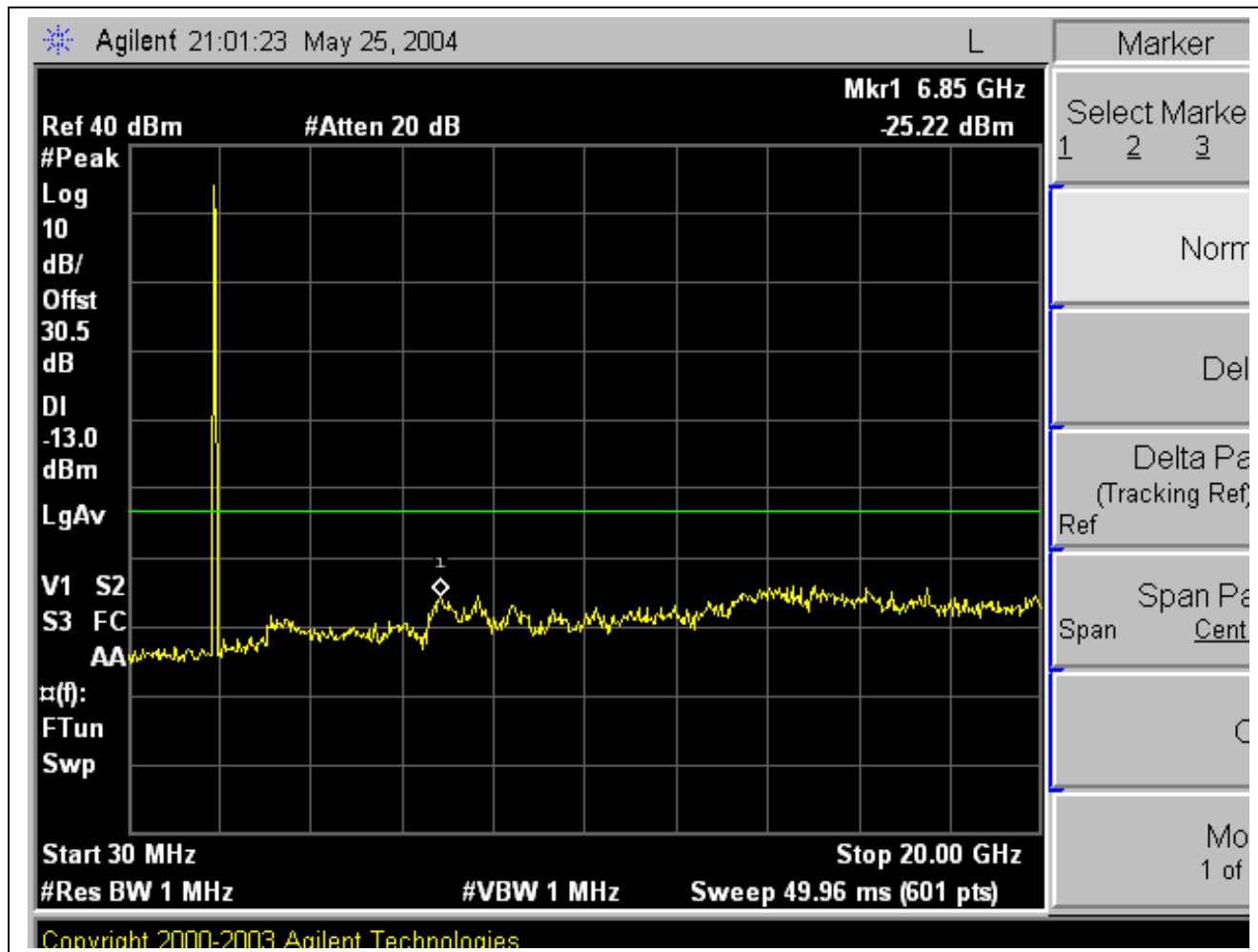

16QAM Modulation: Band Edges, Out-Of-Band Emissions

Low Channel Band Edge

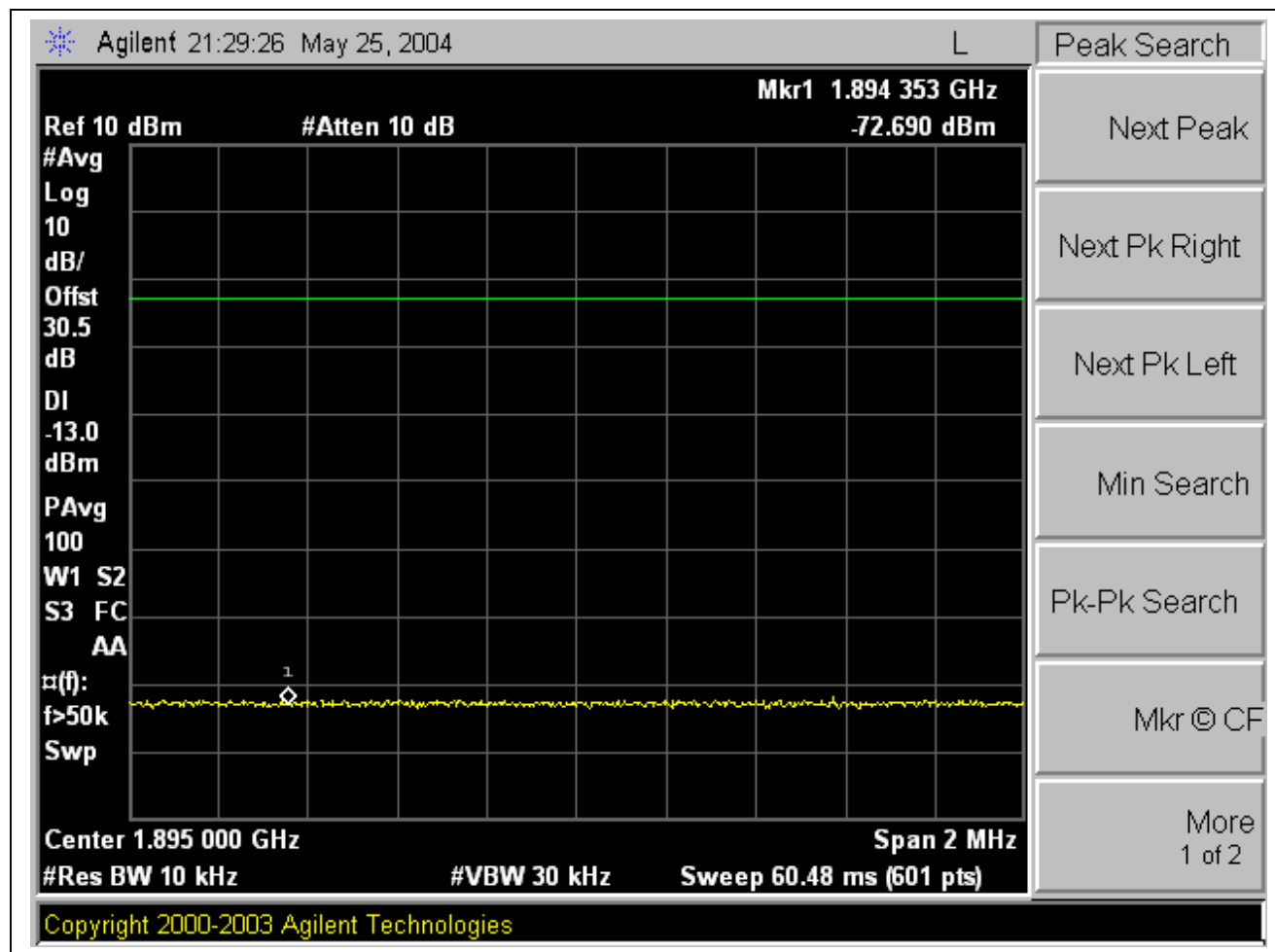

High Channel Band Edge

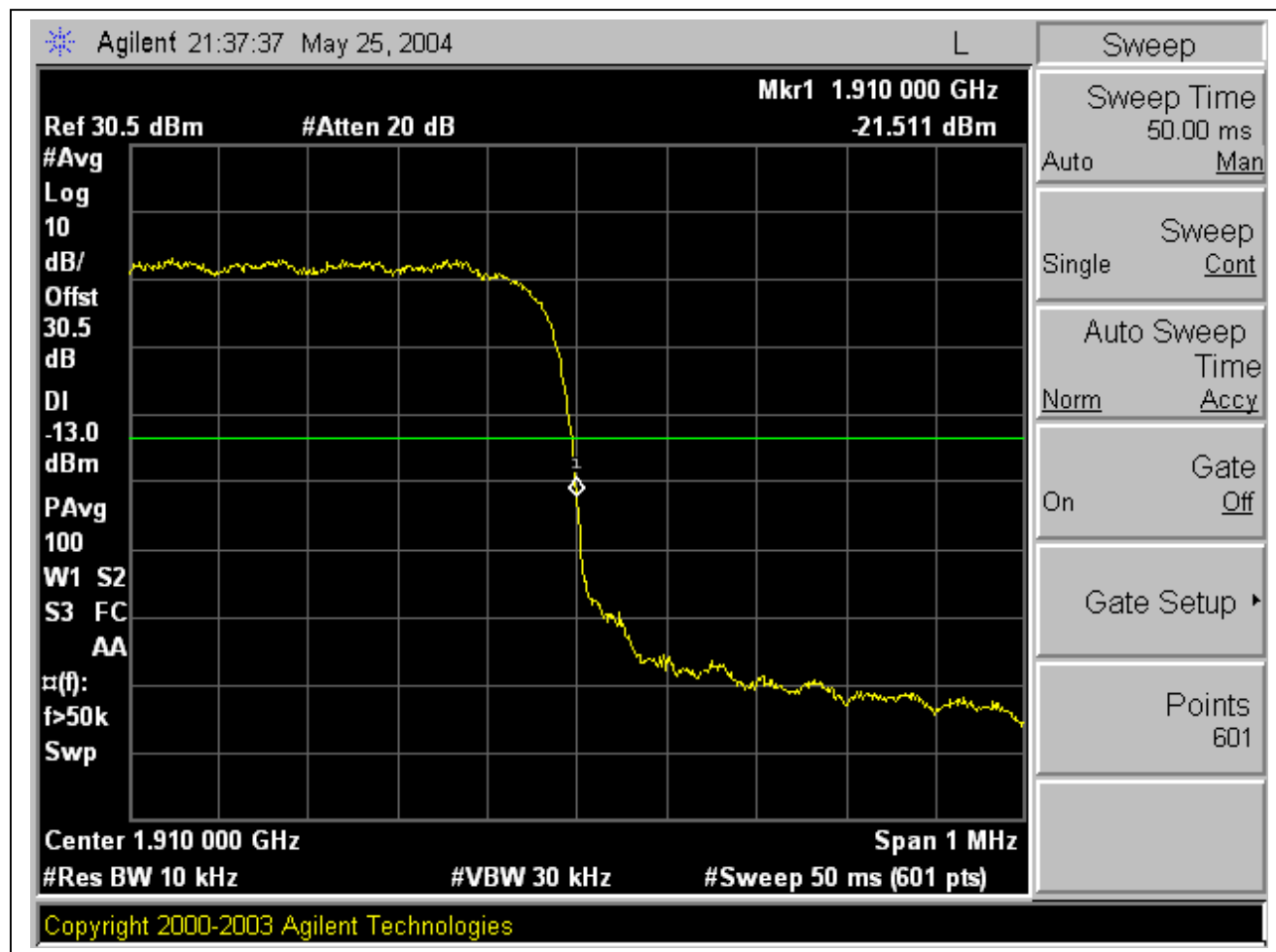

Low Channel, Out-Of-Band Emissions

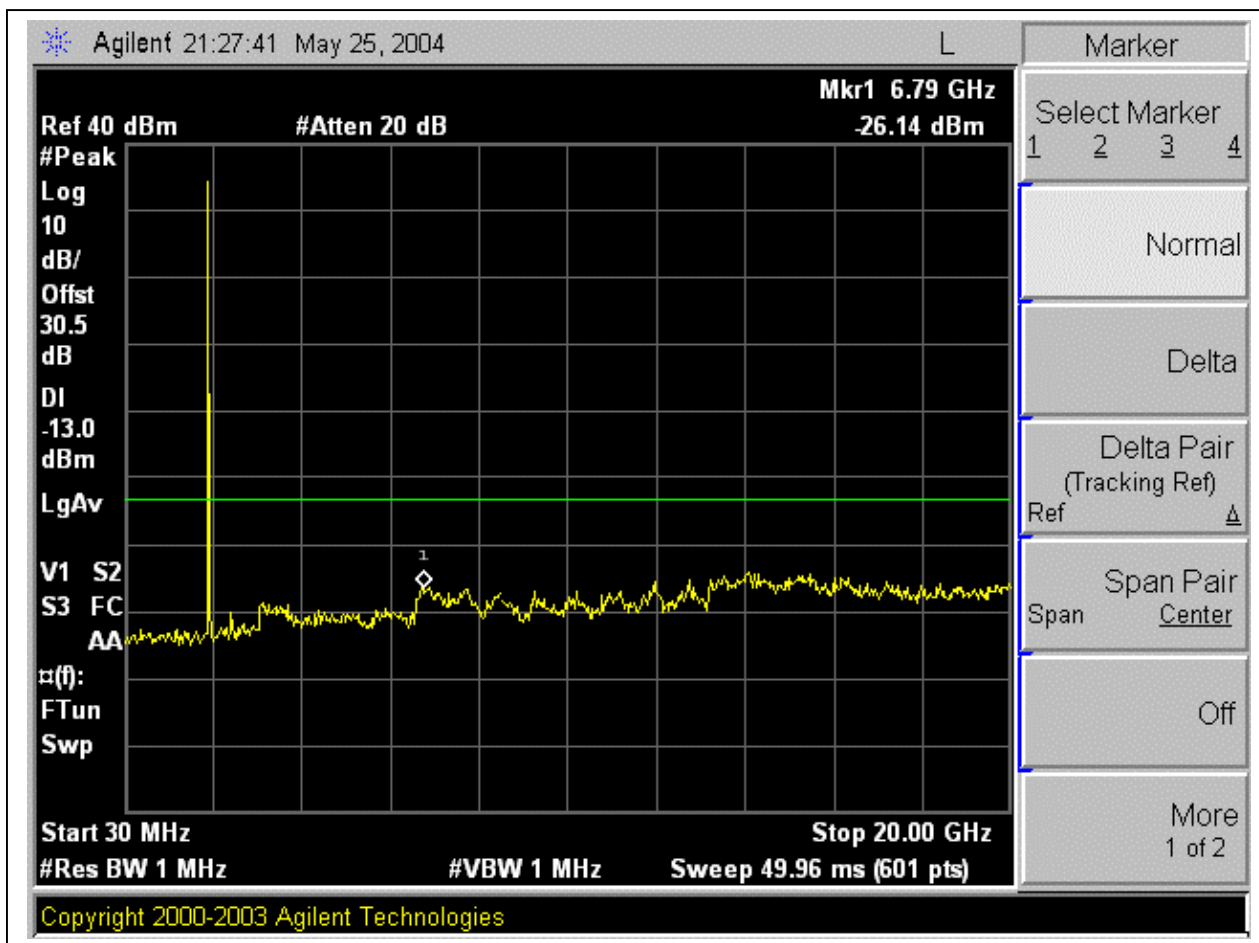

High Channel, Out-Of-Band Emissions

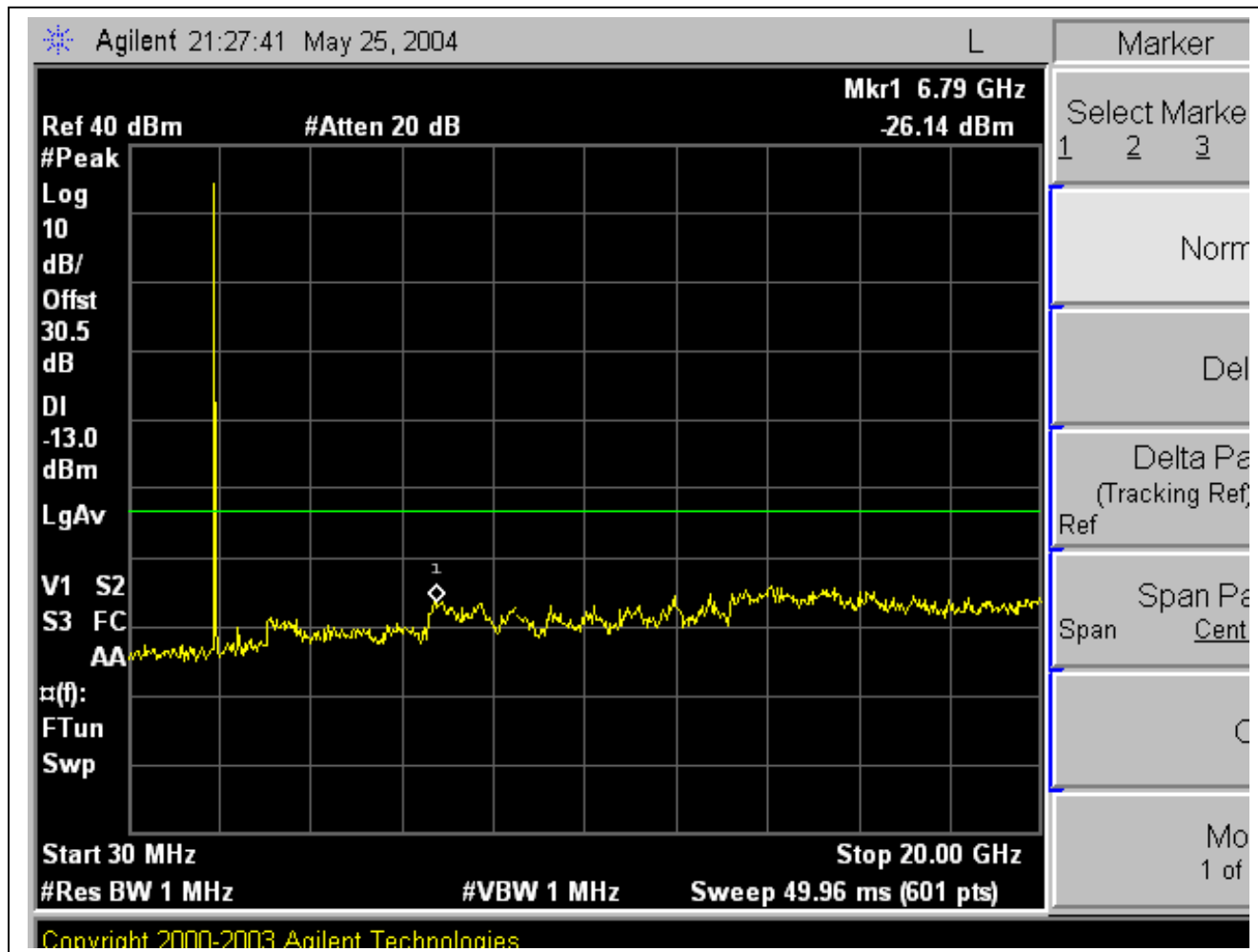

24QAM Modulation: Band Edges, Out-Of-Band Emissions

Low Channel Band Edge

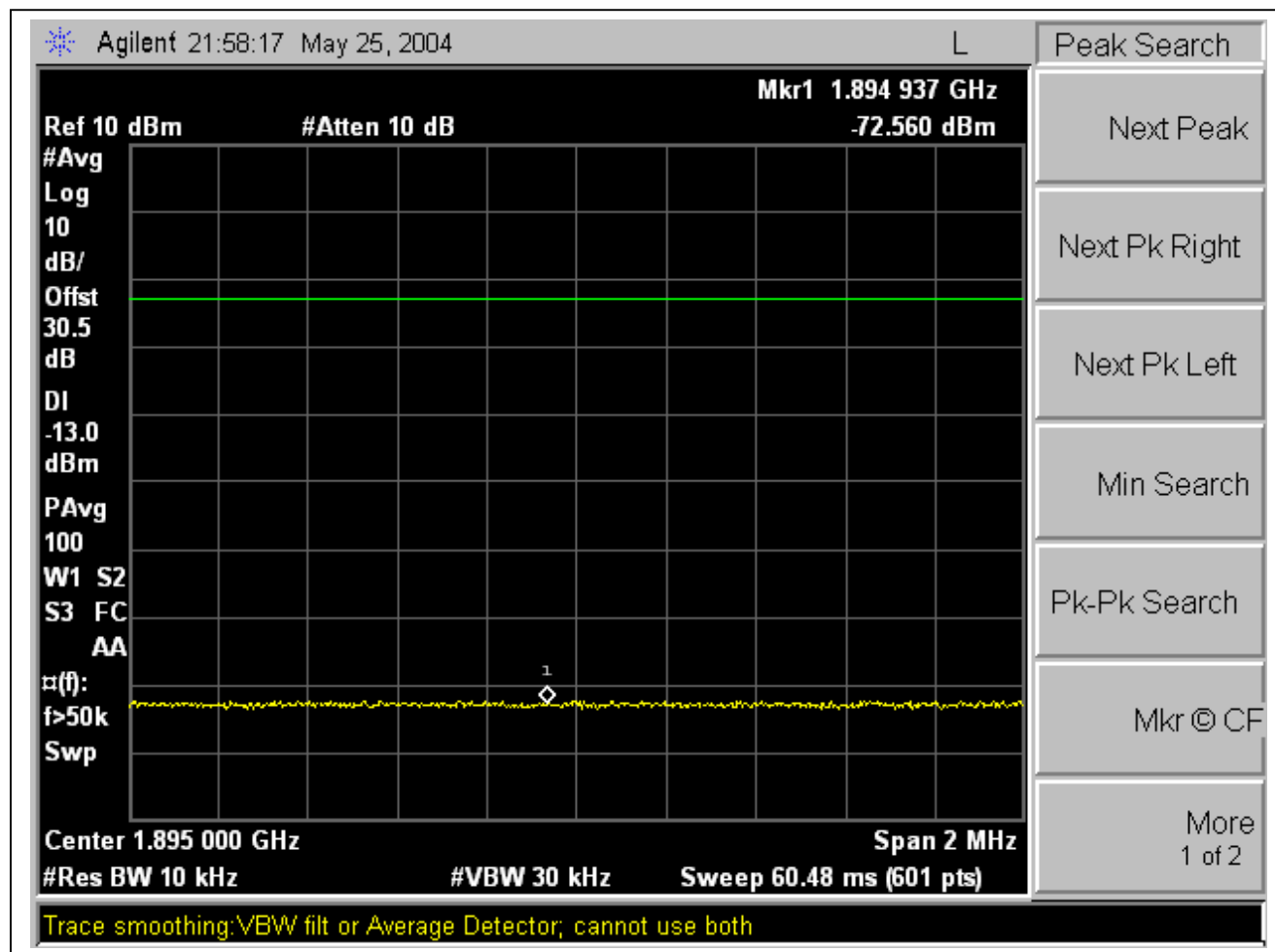

High Channel Band Edge

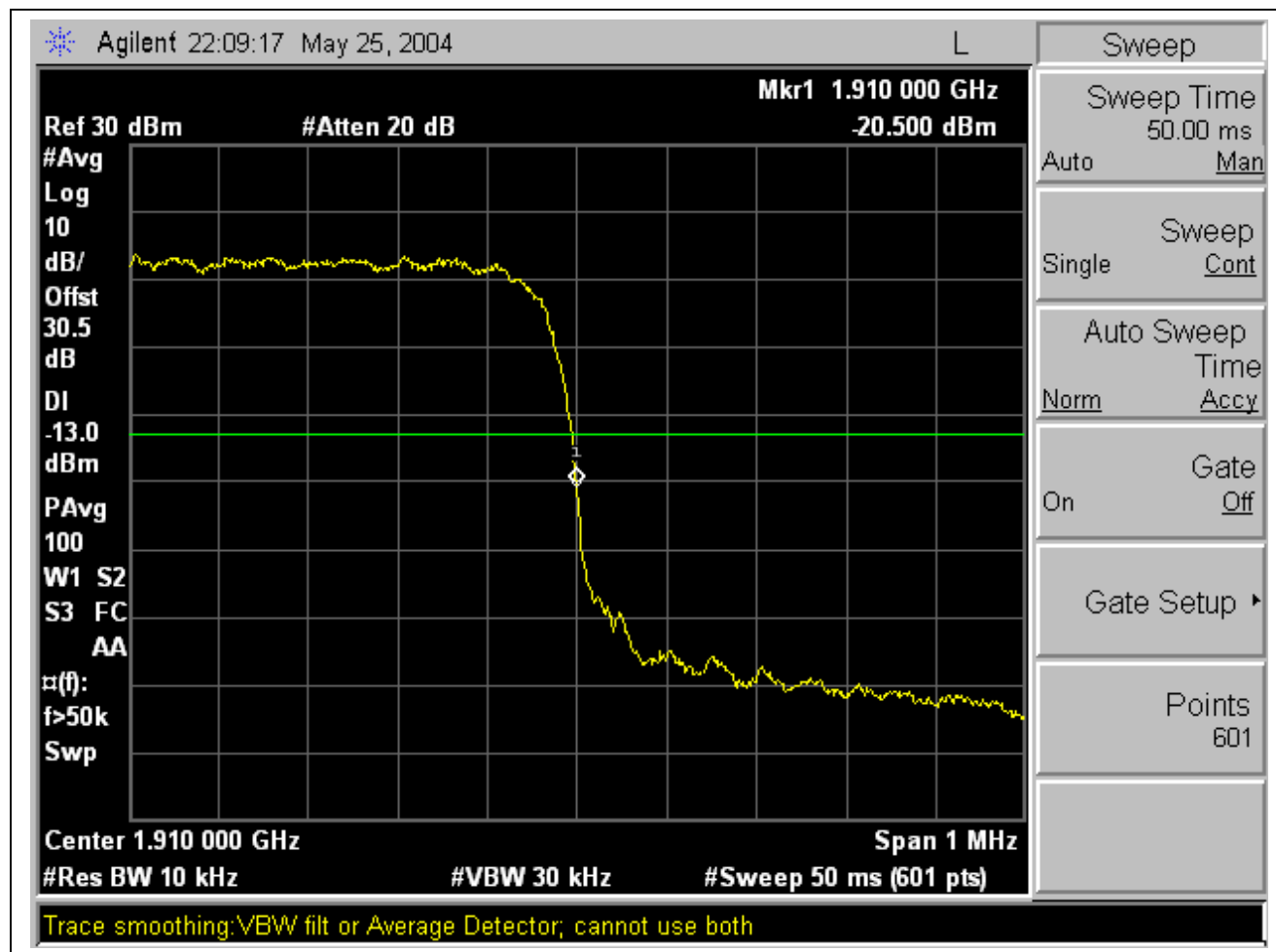

Low Channel, Out-Of-Band Emissions

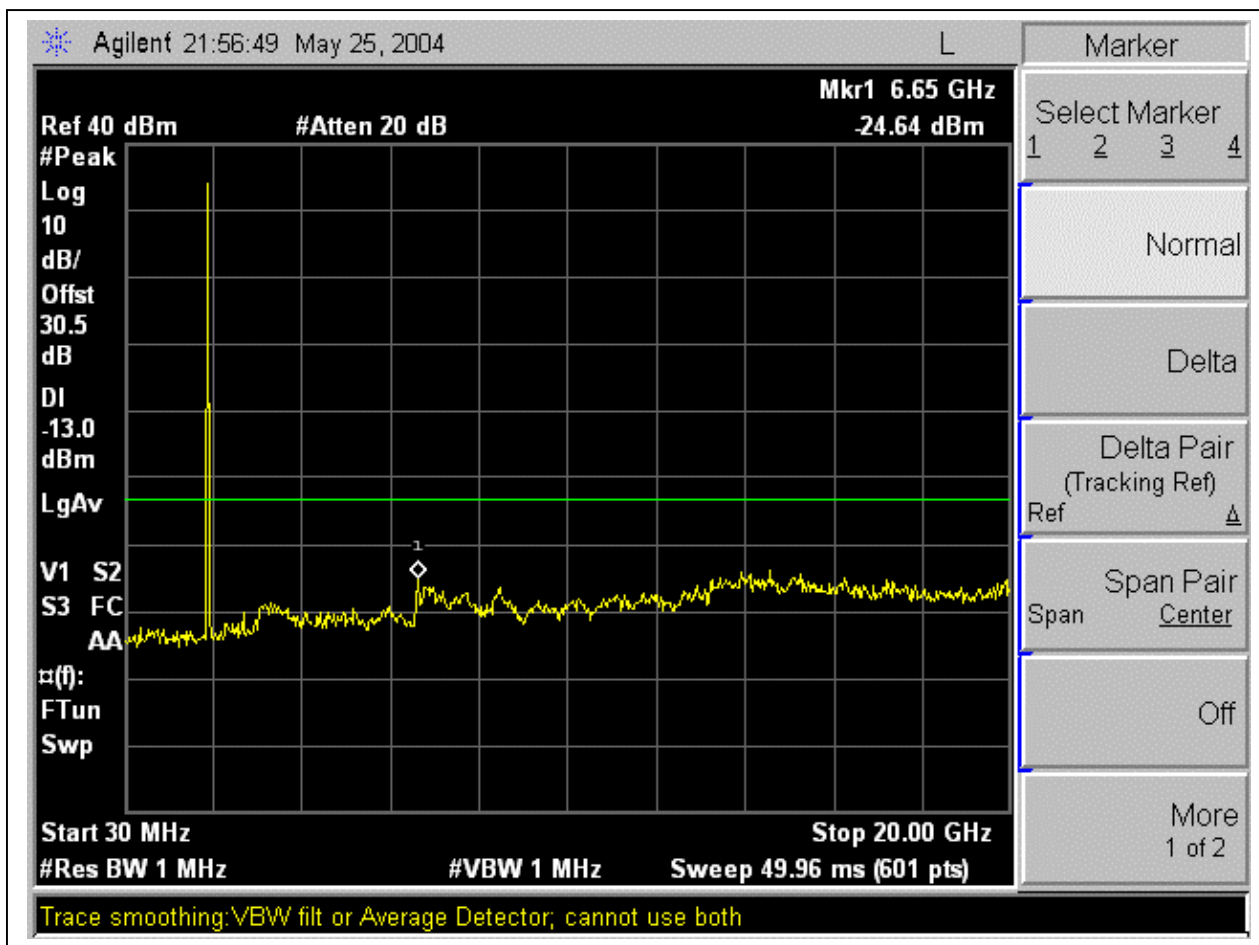

High Channel, Out-Of-Band Emissions

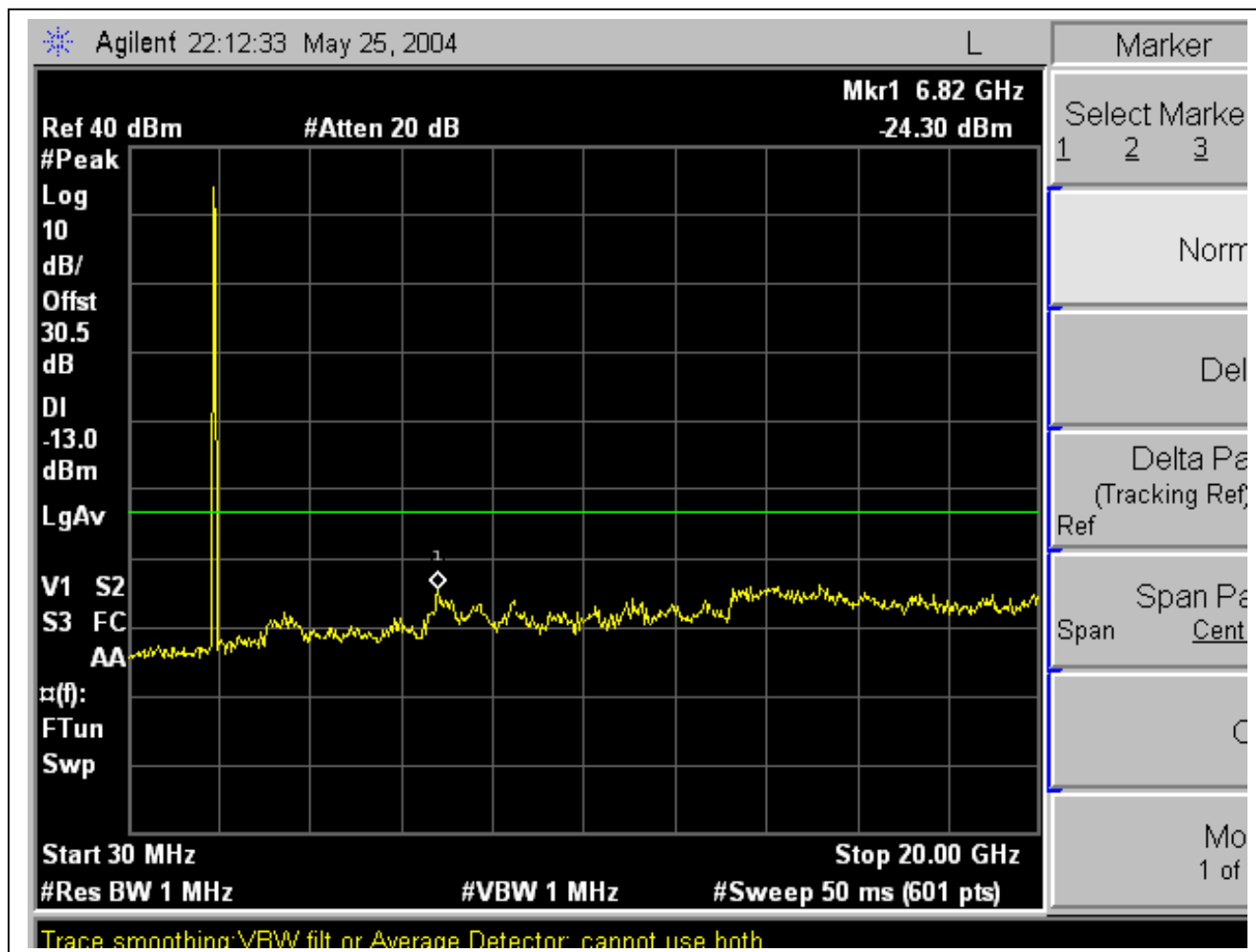

Inter-modulation:

BPSK Modulation: Band Edges, Out-Of-Band Emissions

Low Channel Band Edge

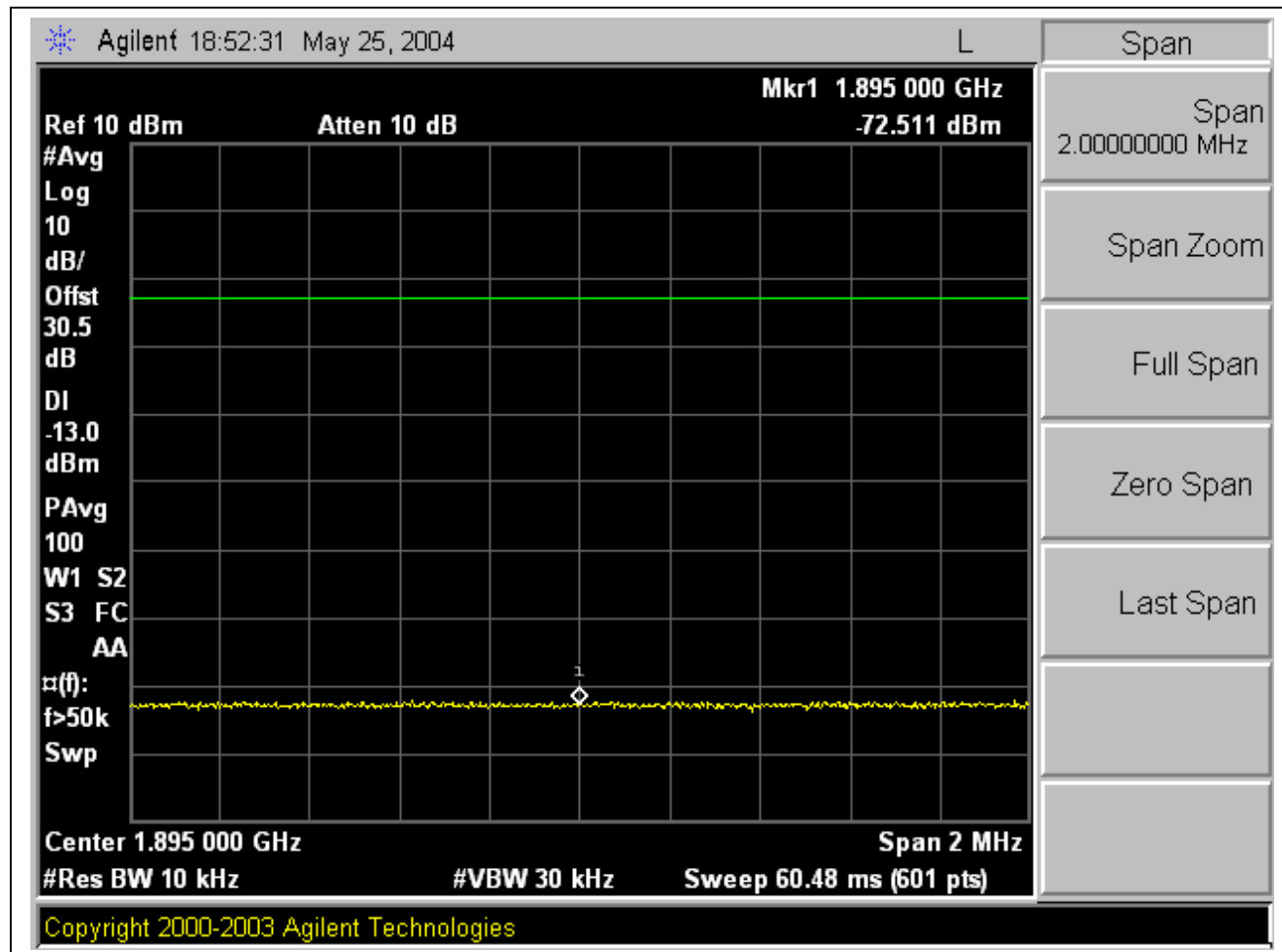

High Channel Band Edge

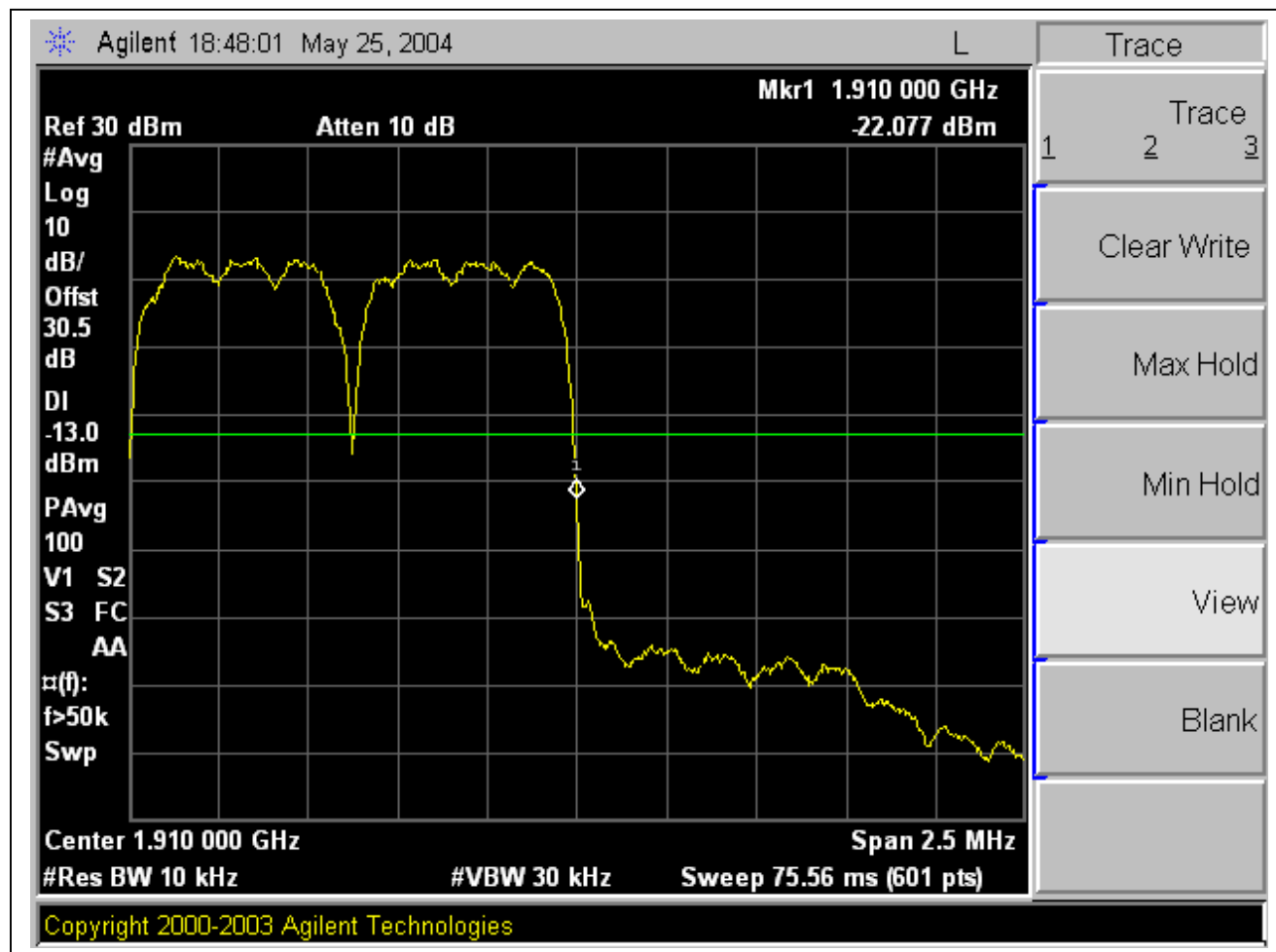

Low Channel, Out-Of-Band Emissions

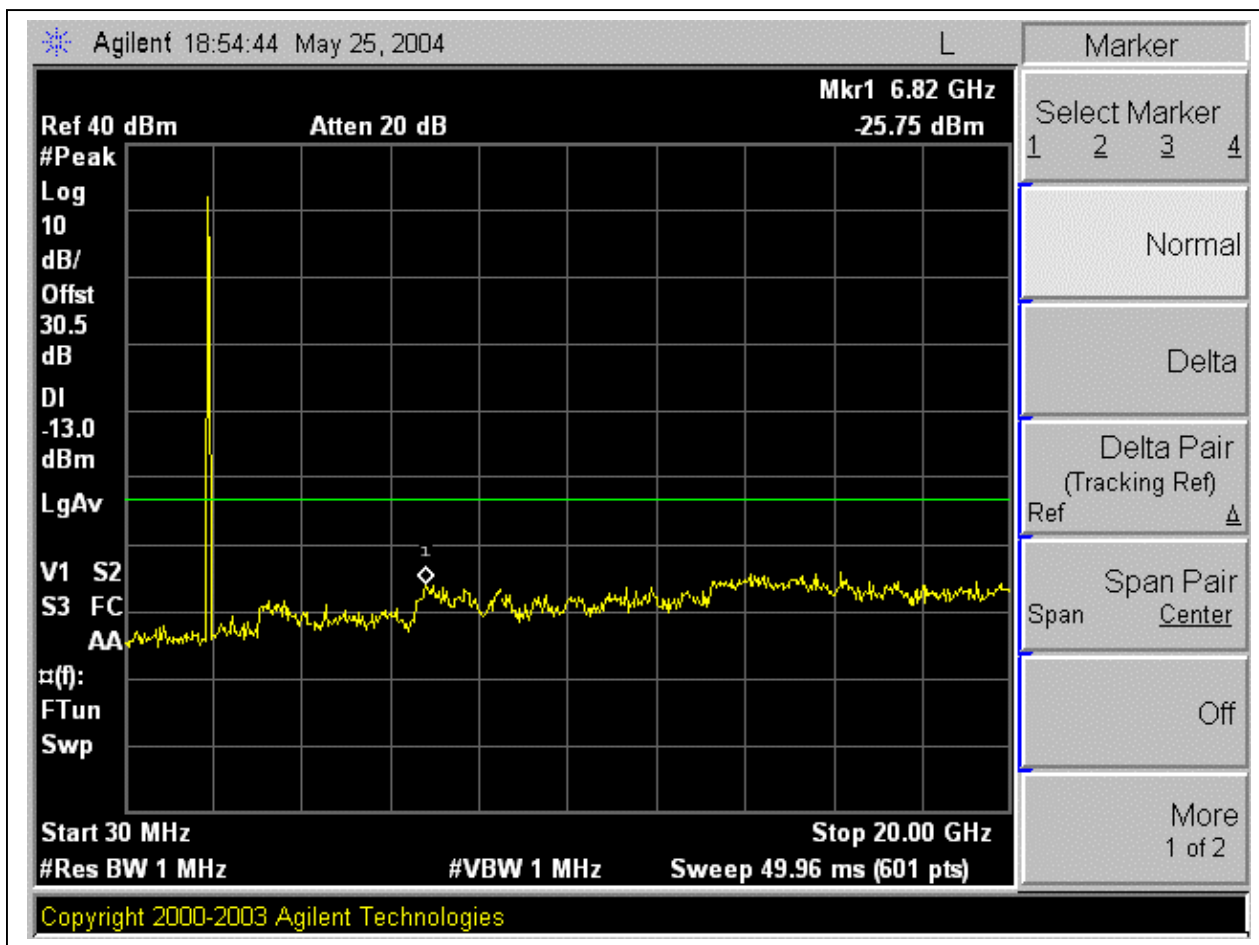

High Channel, Out-Of-Band Emissions

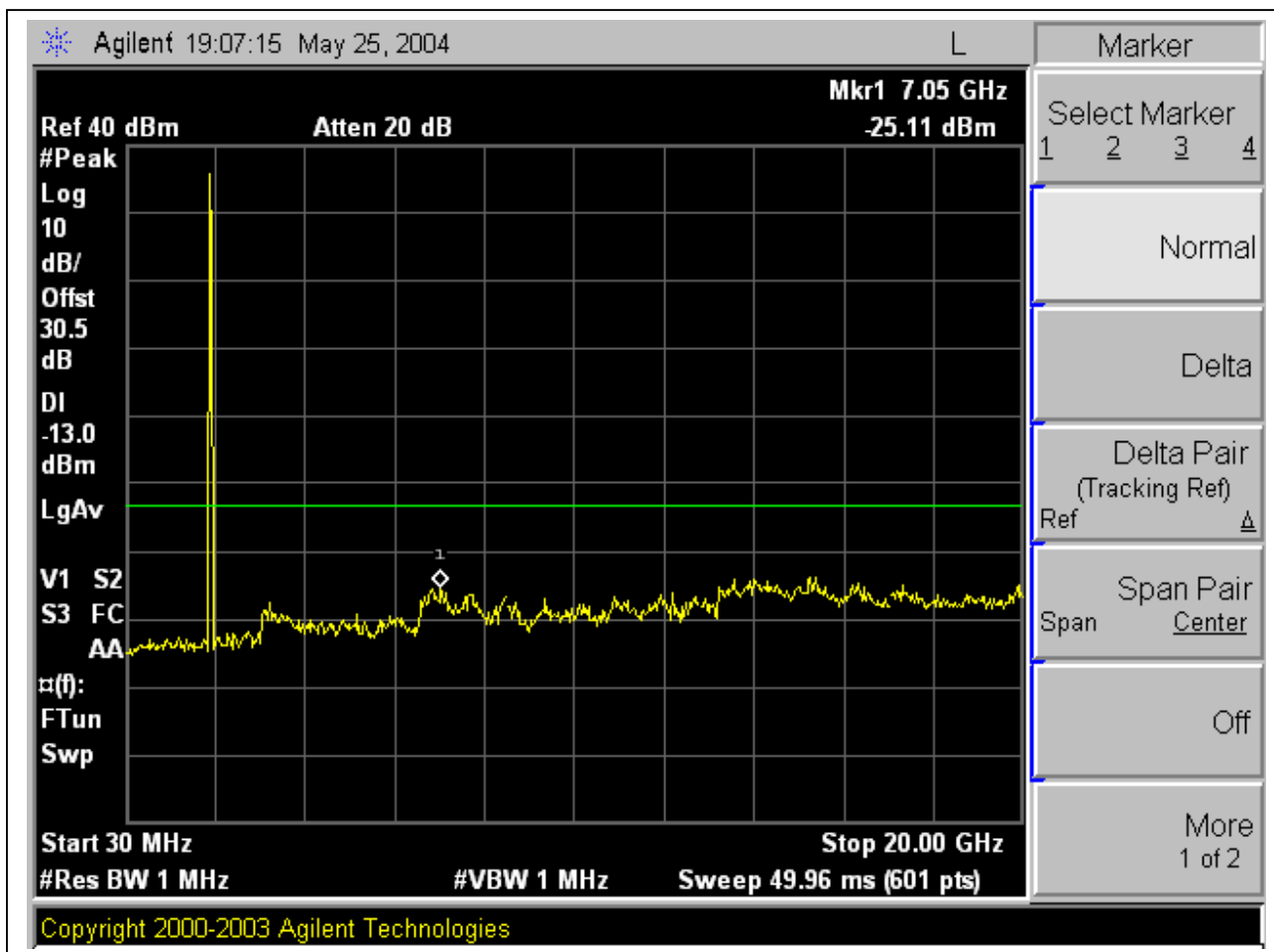

QPSK Modulation: Band Edges, Out-Of-Band Emissions

Low Channel Band Edge

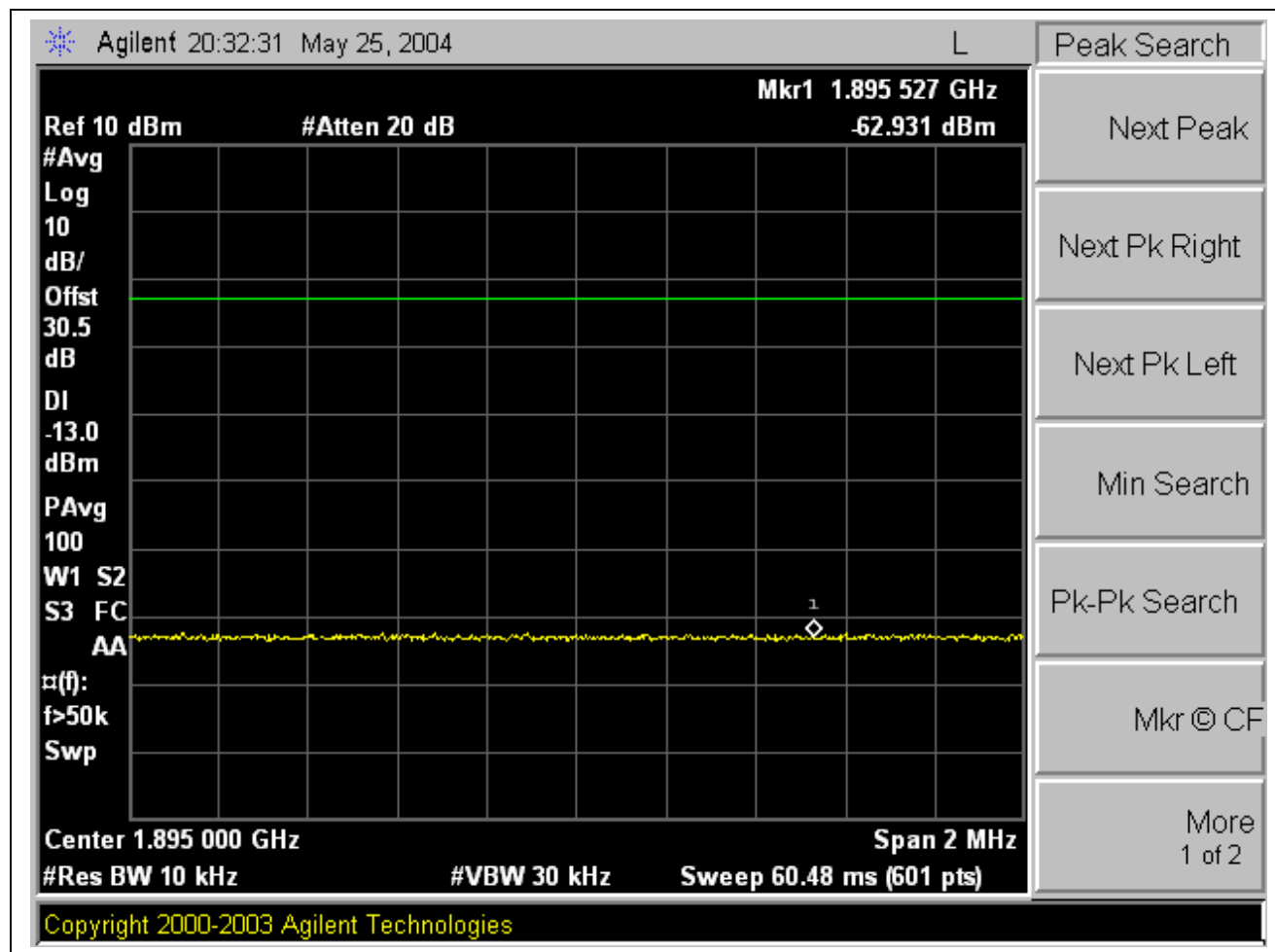

High Channel Band Edge

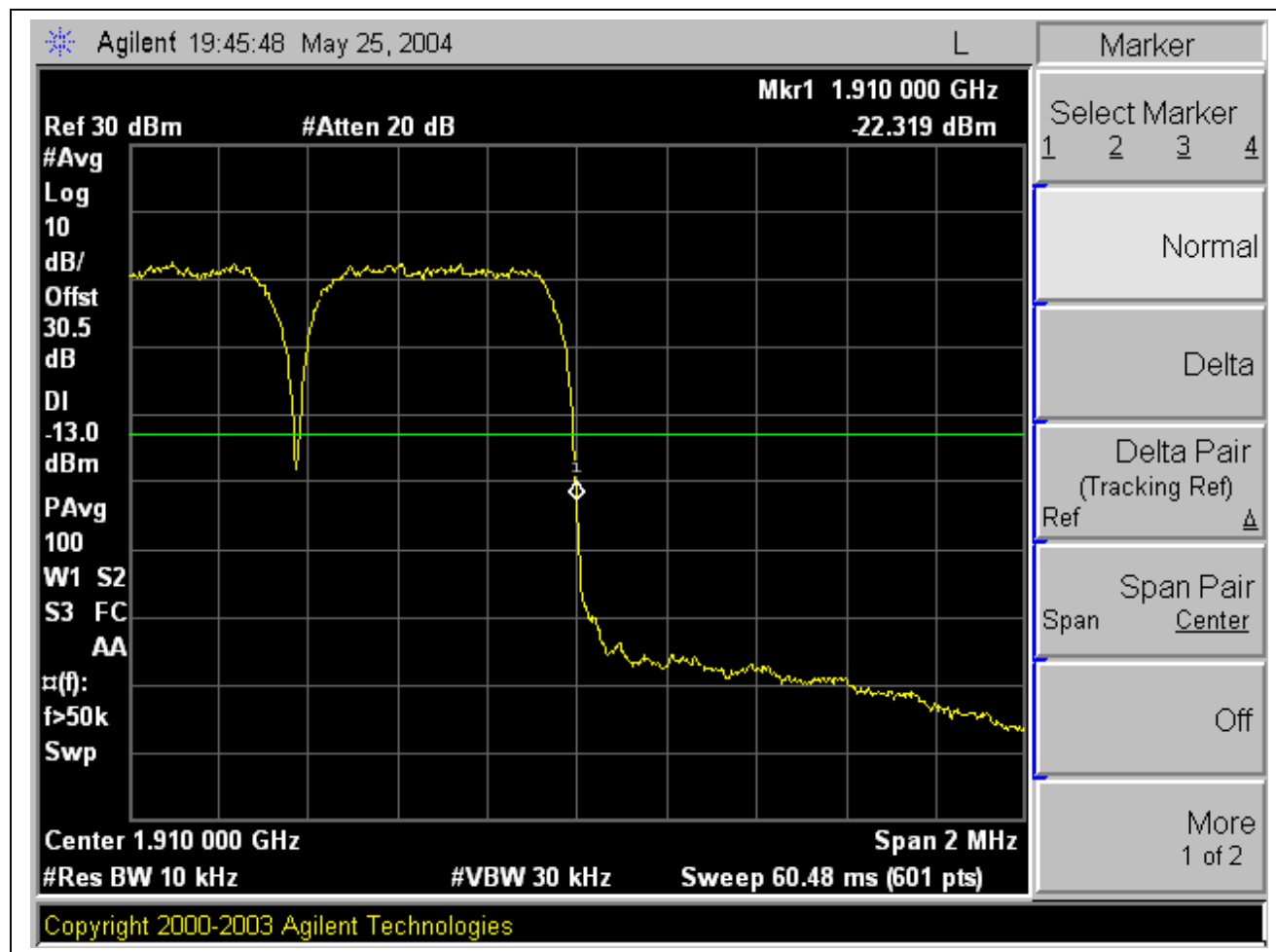

Low Channel, Out-Of-Band Emissions

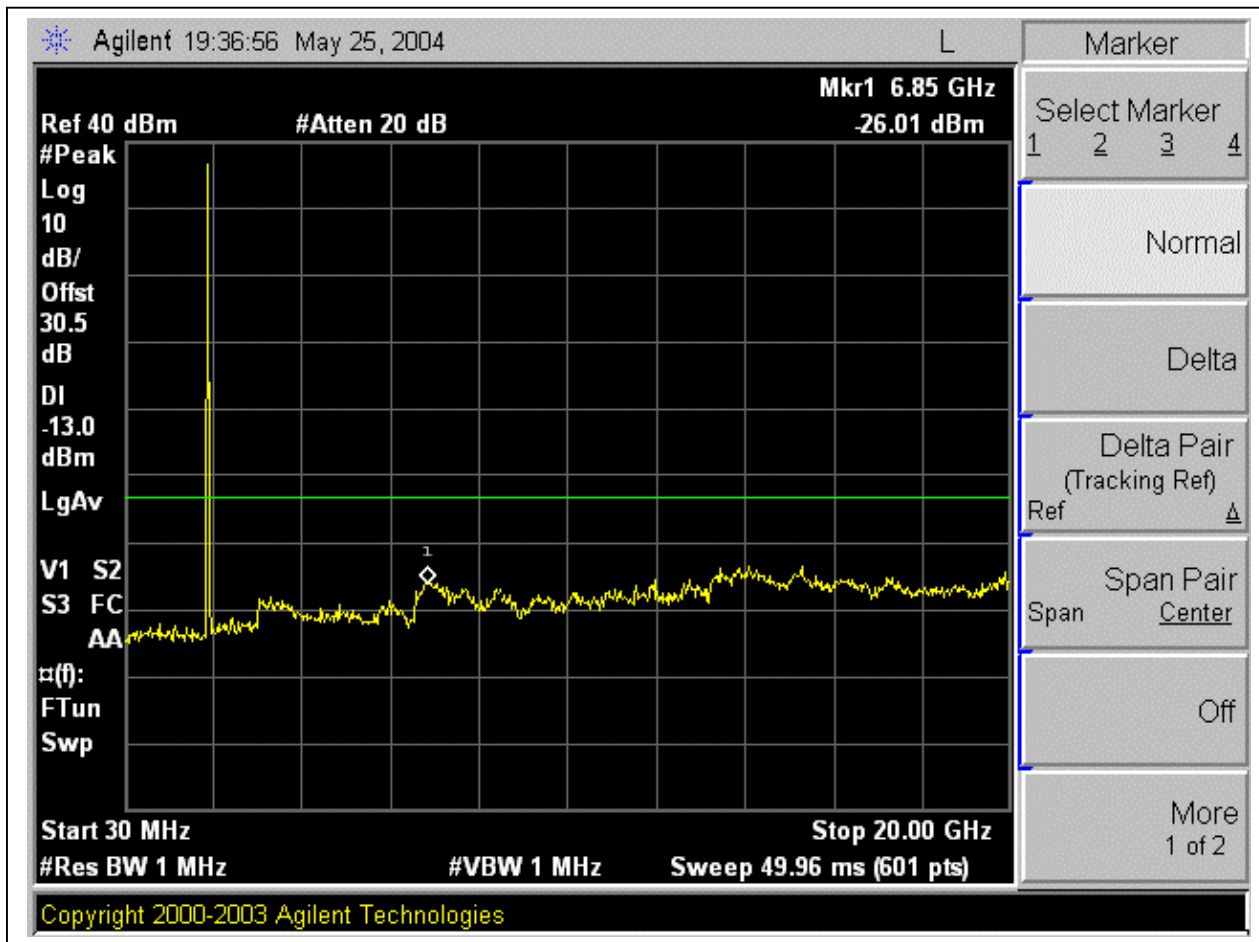

High Channel, Out-Of-Band Emissions

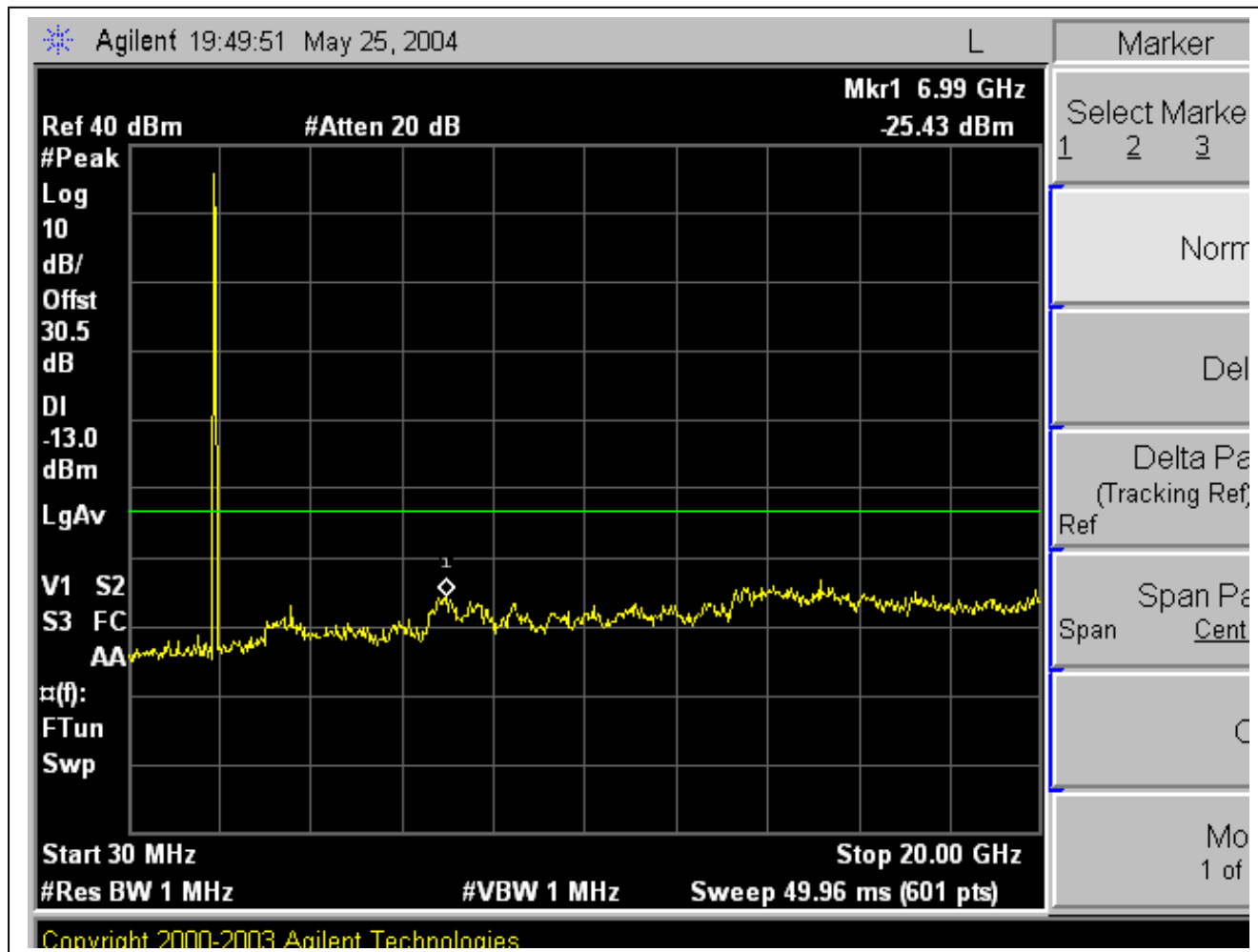

8PSK Modulation: Band Edges, Out-Of-Band Emissions

Low Channel Band Edge

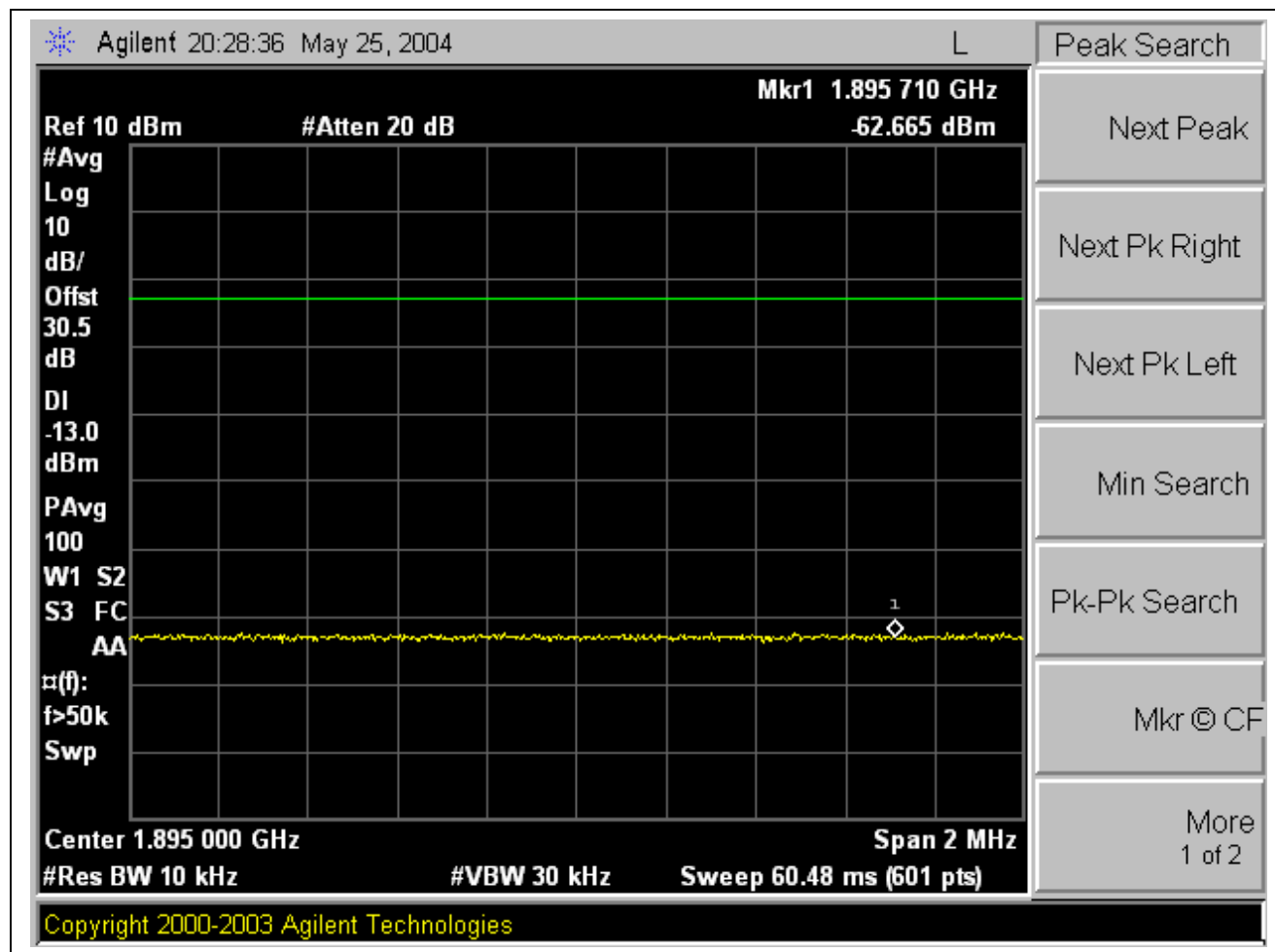

High Channel Band Edge

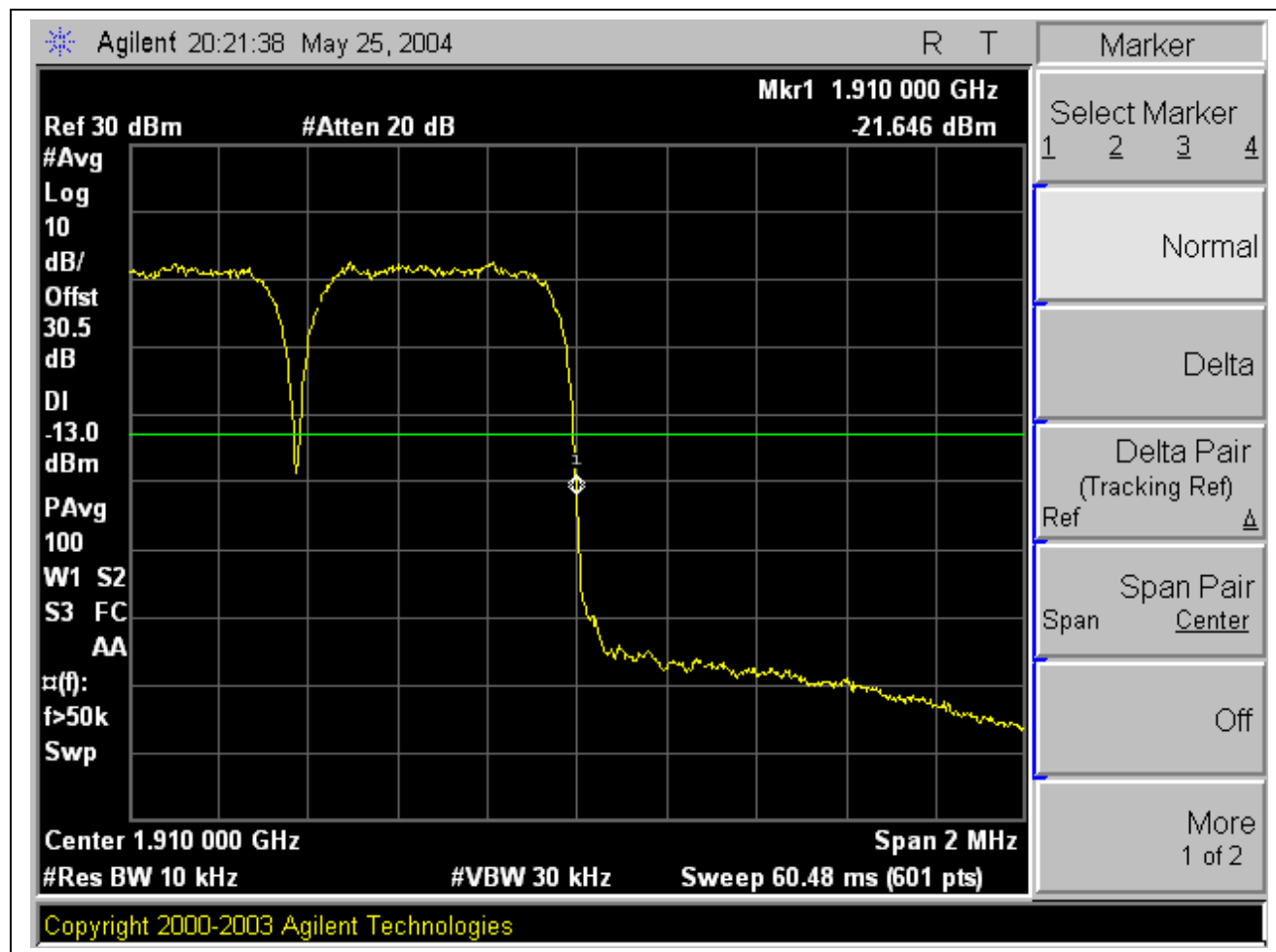

Low Channel, Out-Of-Band Emissions

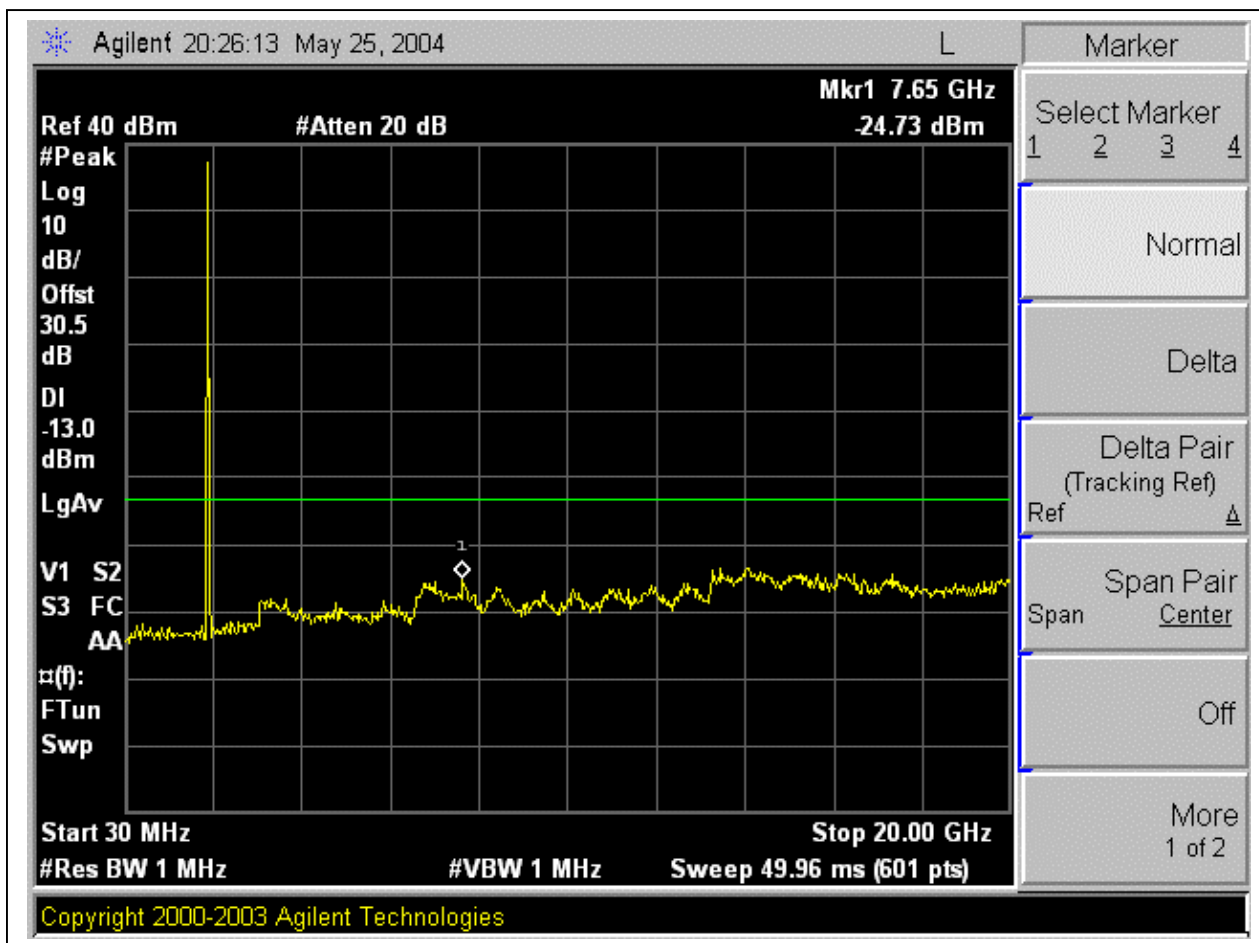

High Channel, Out-Of-Band Emissions

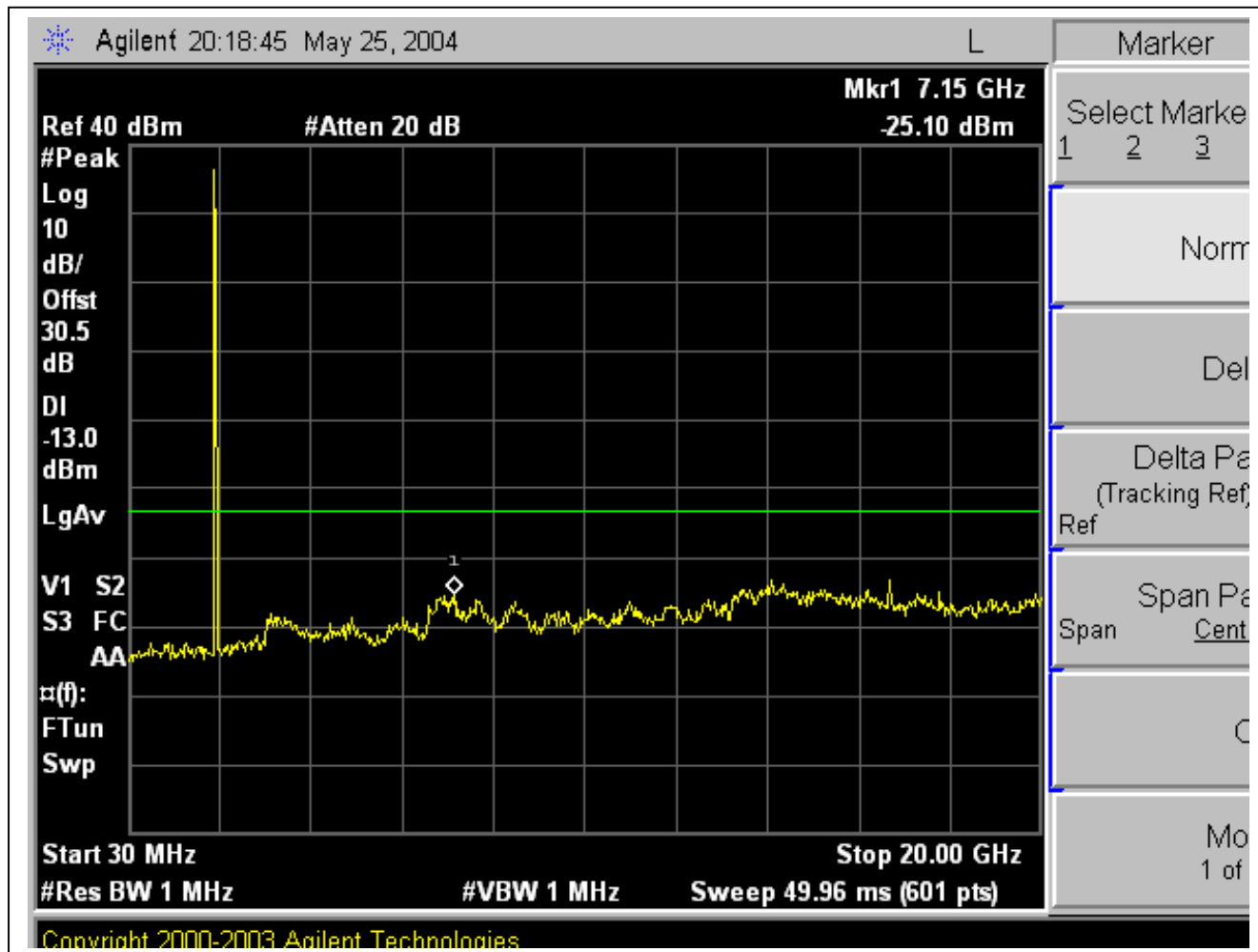

12QAM Modulation: Band Edges, Out-Of-Band Emissions

Low Channel Band Edge

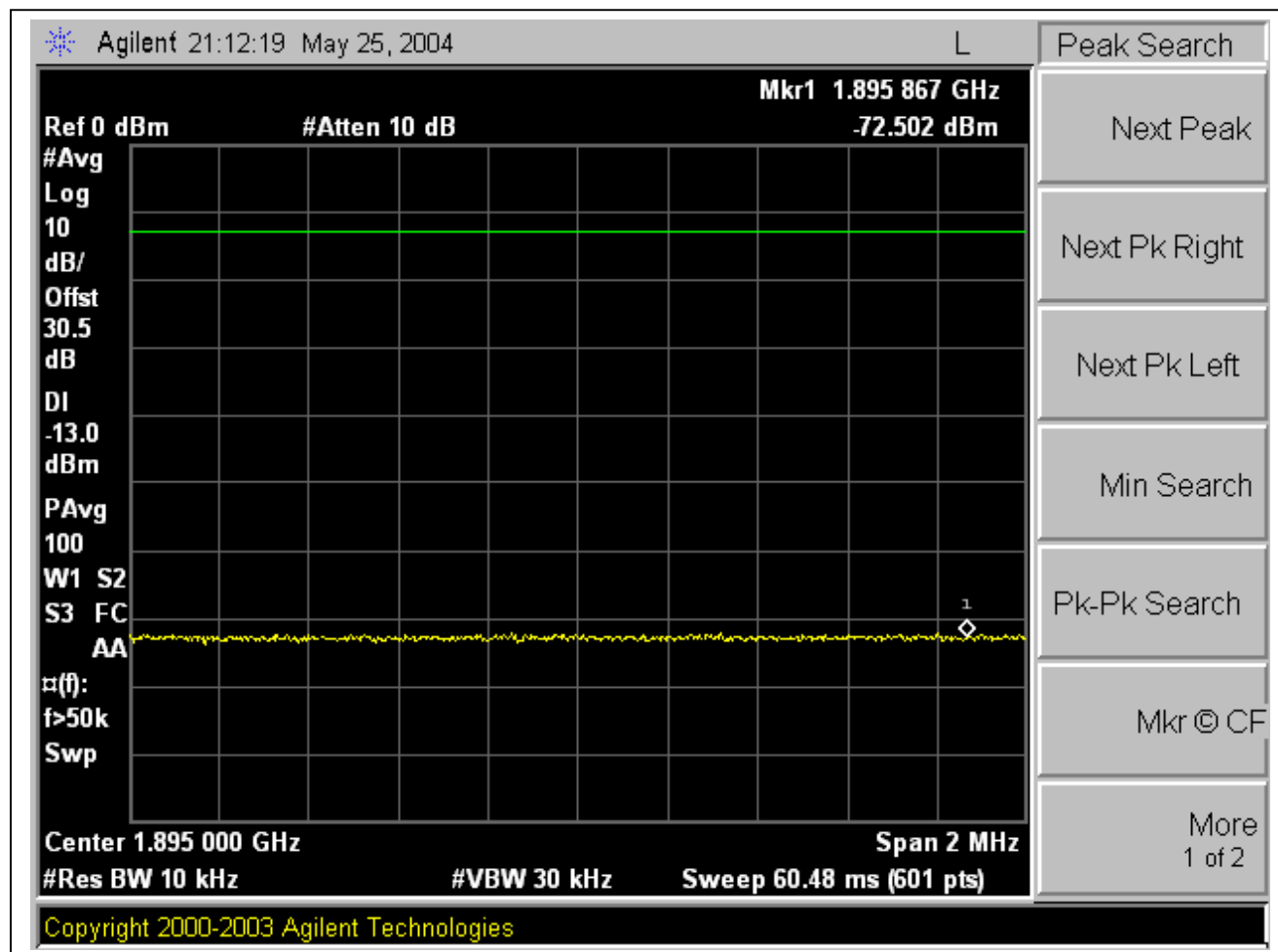

High Channel Band Edge

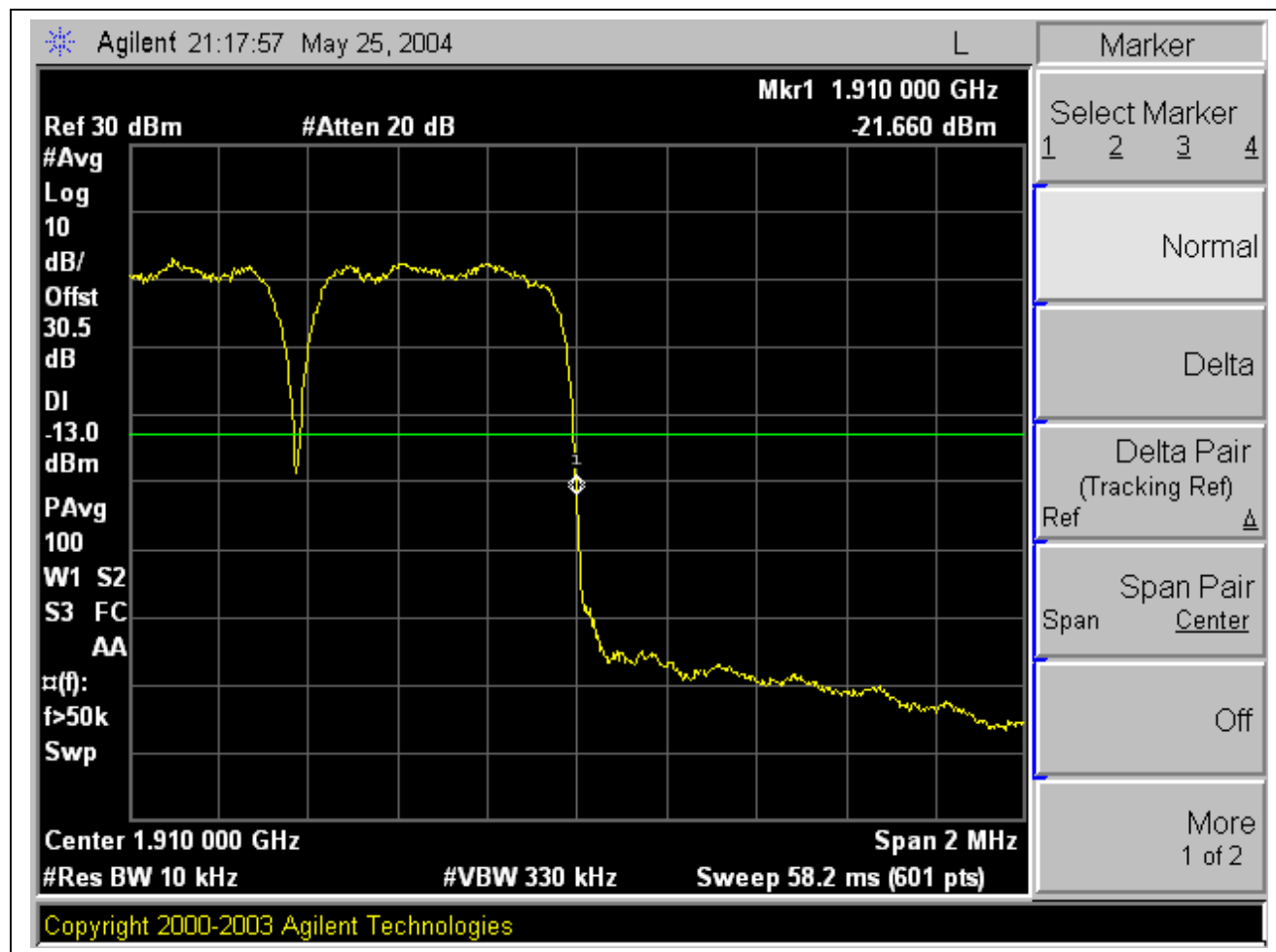

Low Channel, Out-Of-Band Emissions

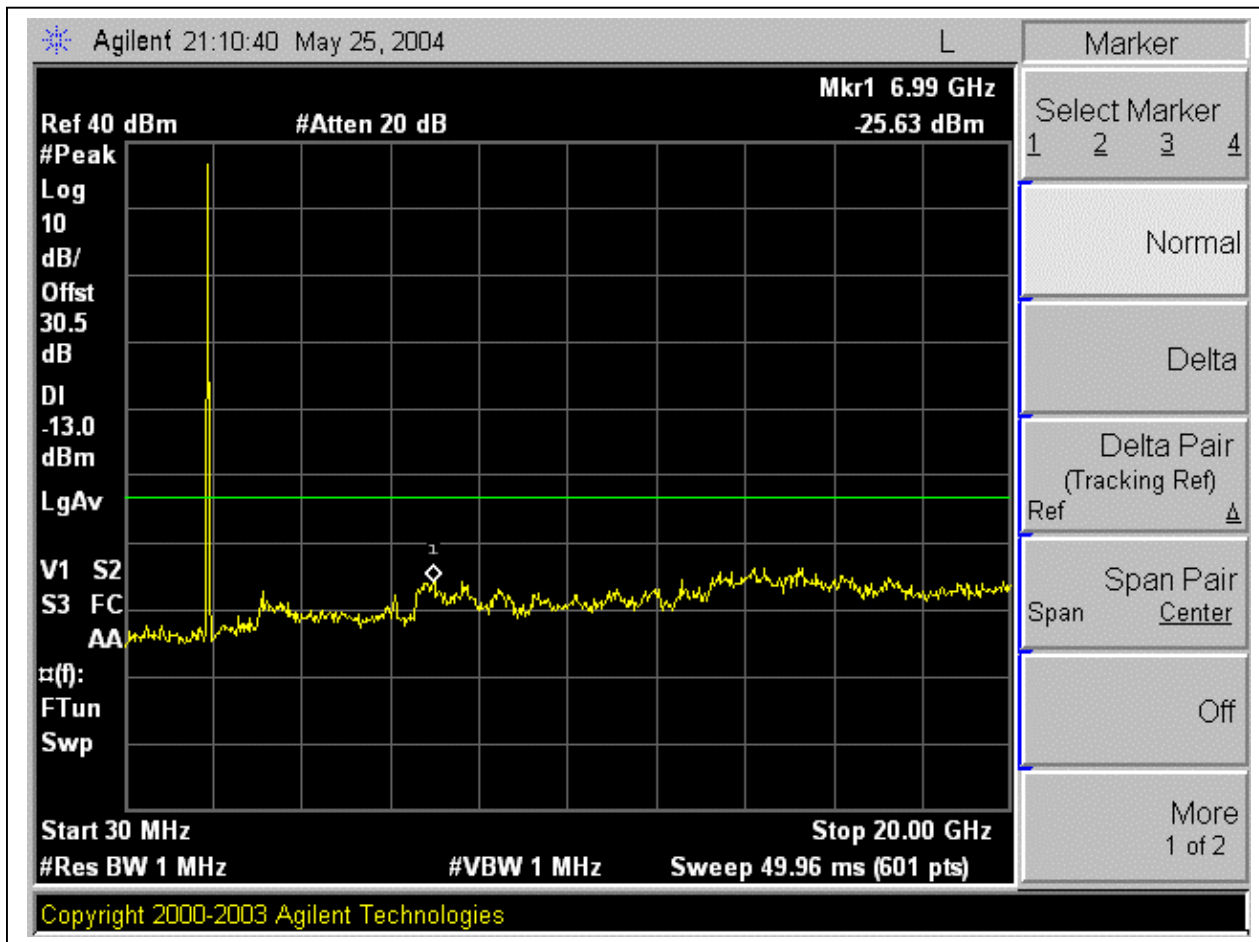

High Channel, Out-Of-Band Emissions

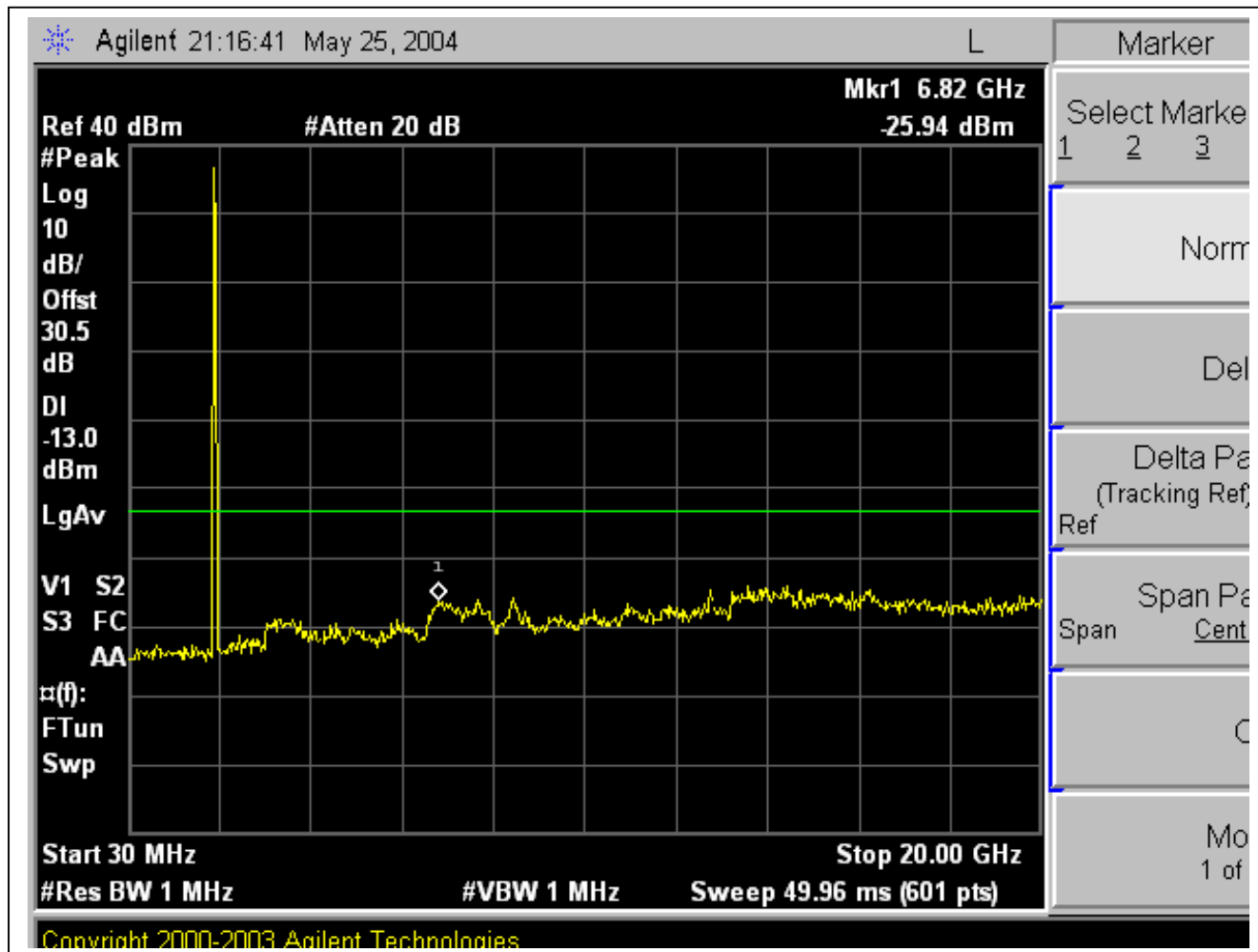

16QAM Modulation: Band Edges, Out-Of-Band Emissions

Low Channel Band Edge

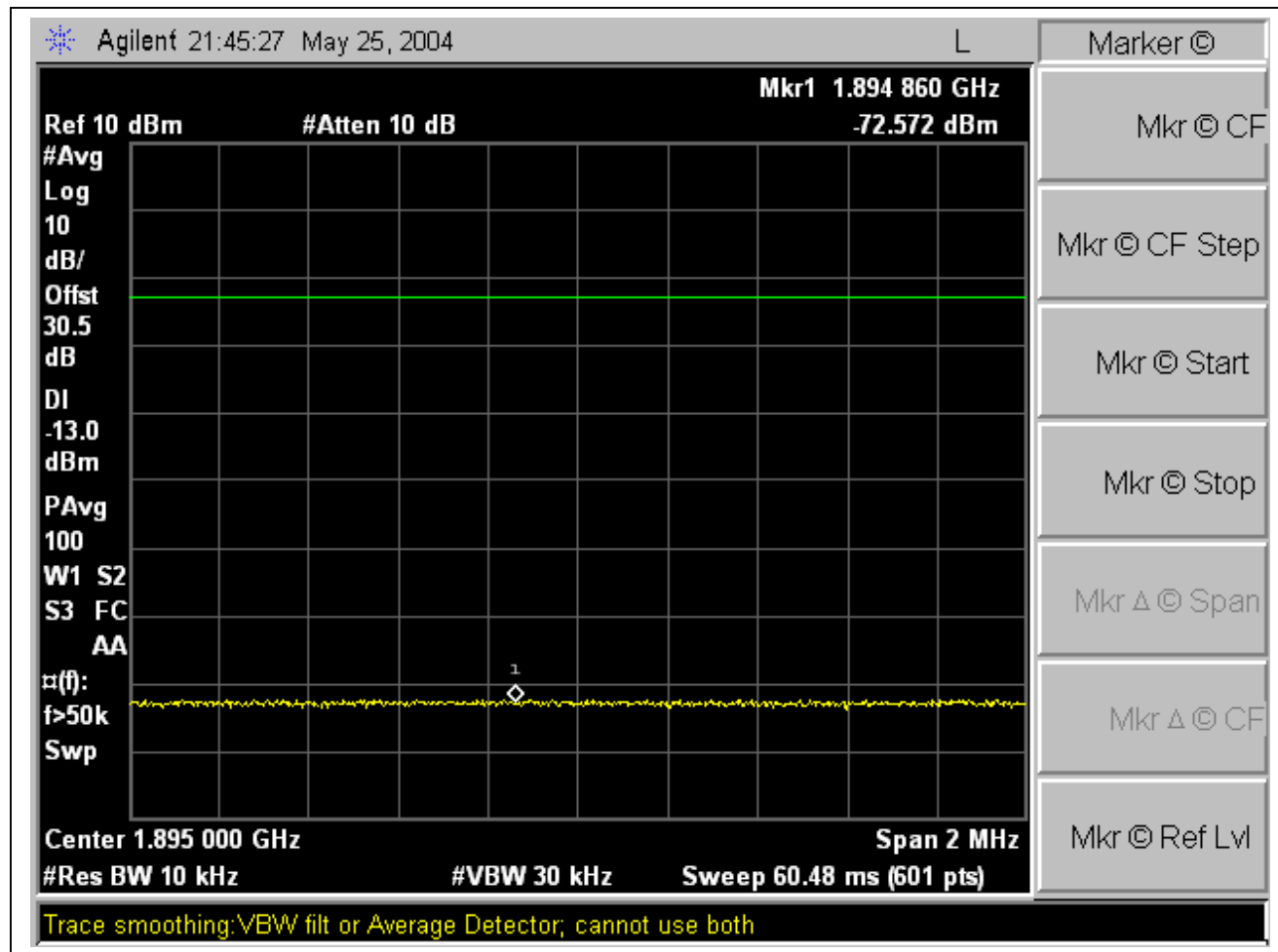

High Channel Band Edge

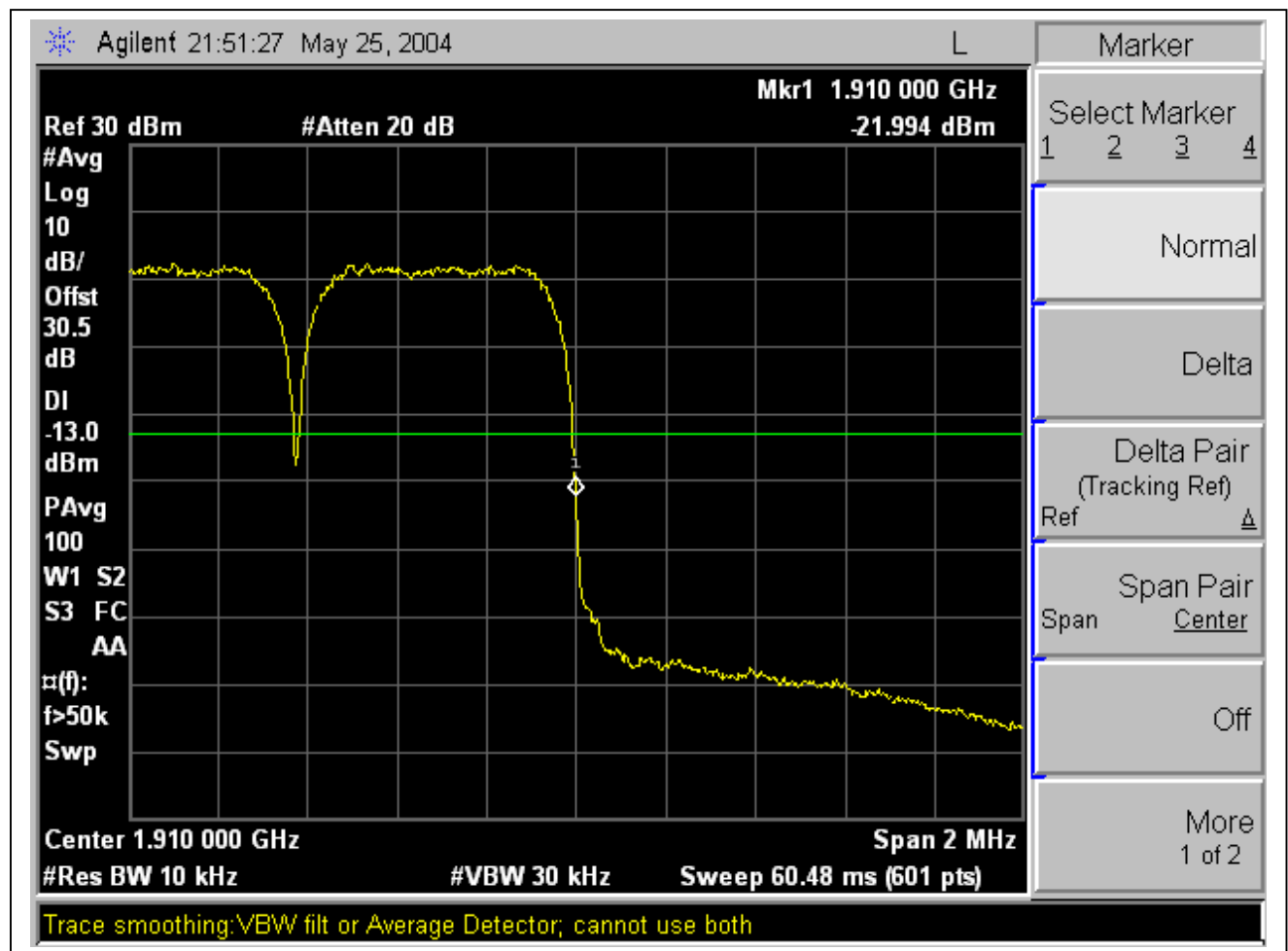

Low Channel, Out-Of-Band Emissions

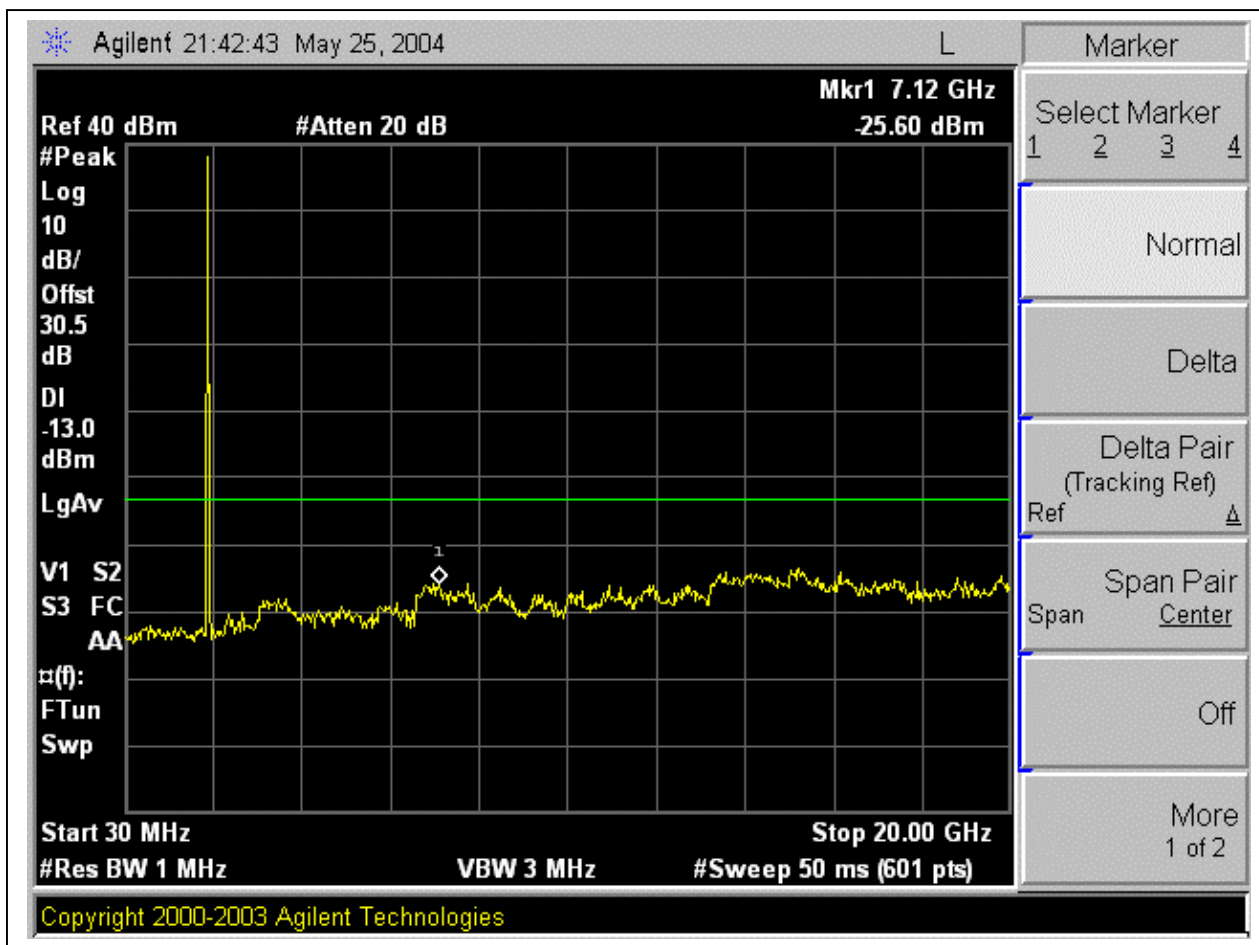

High Channel, Out-Of-Band Emissions

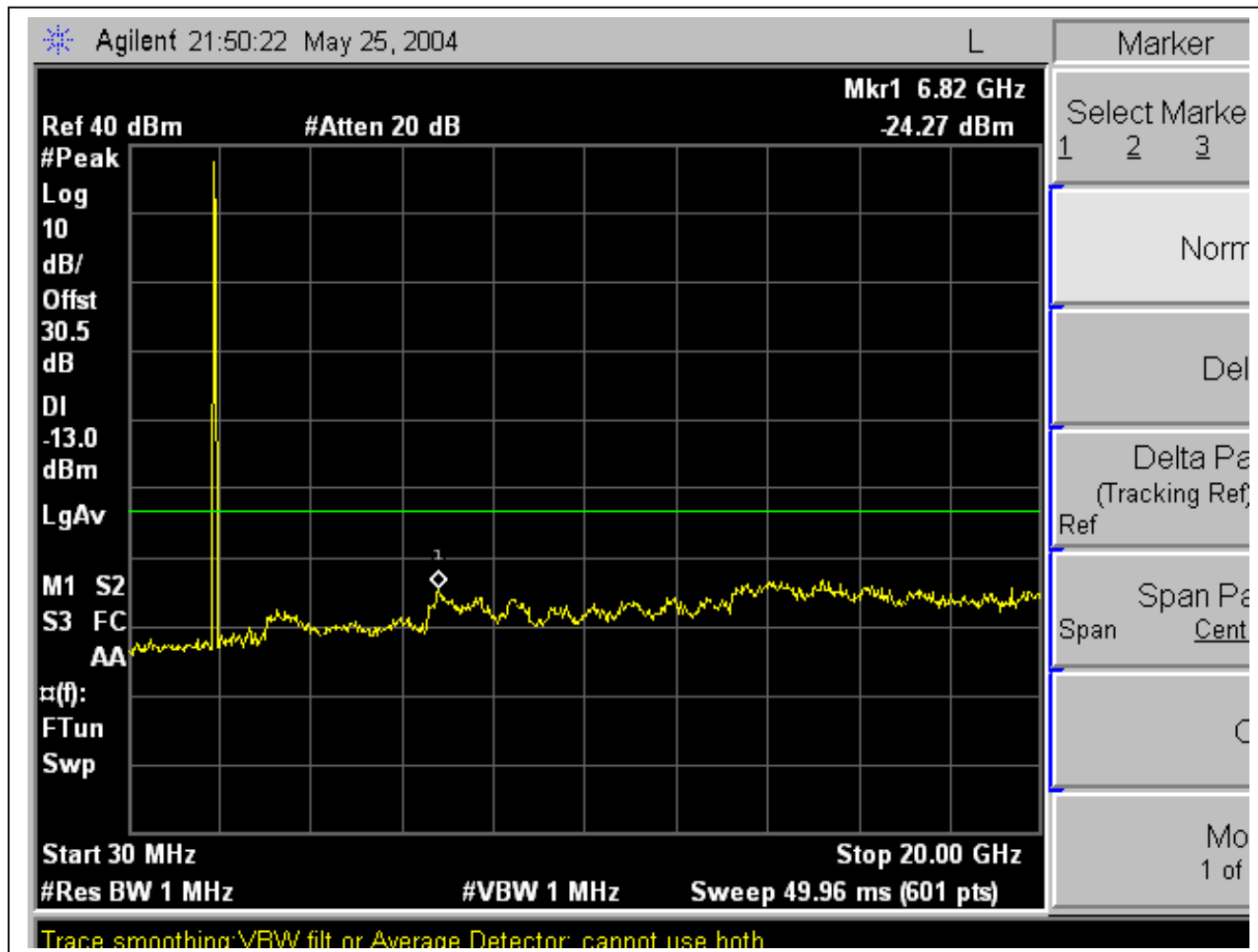

24QAM Modulation: Band Edges, Out-Of-Band Emissions

Low Channel Band Edge

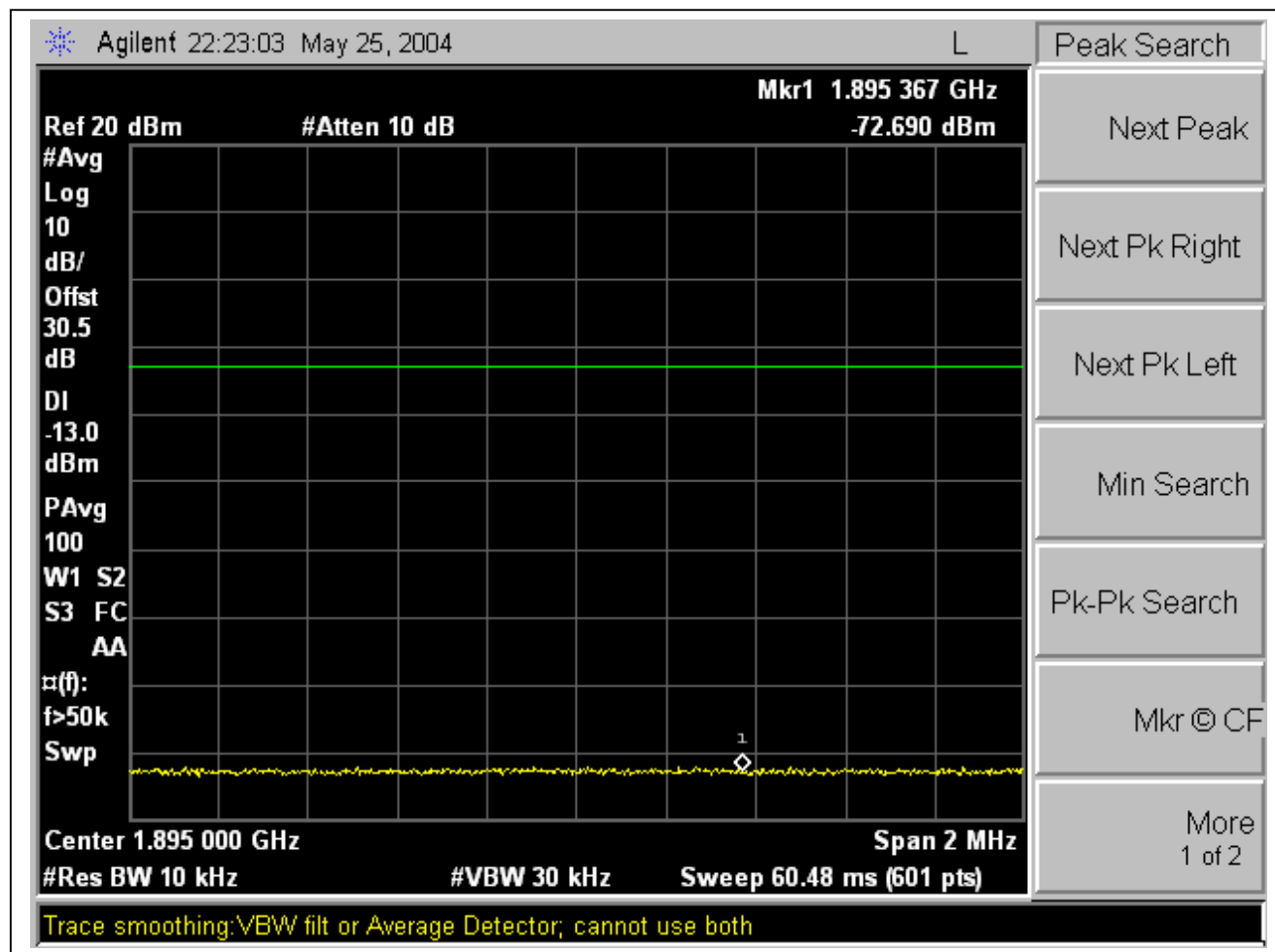

High Channel Band Edge

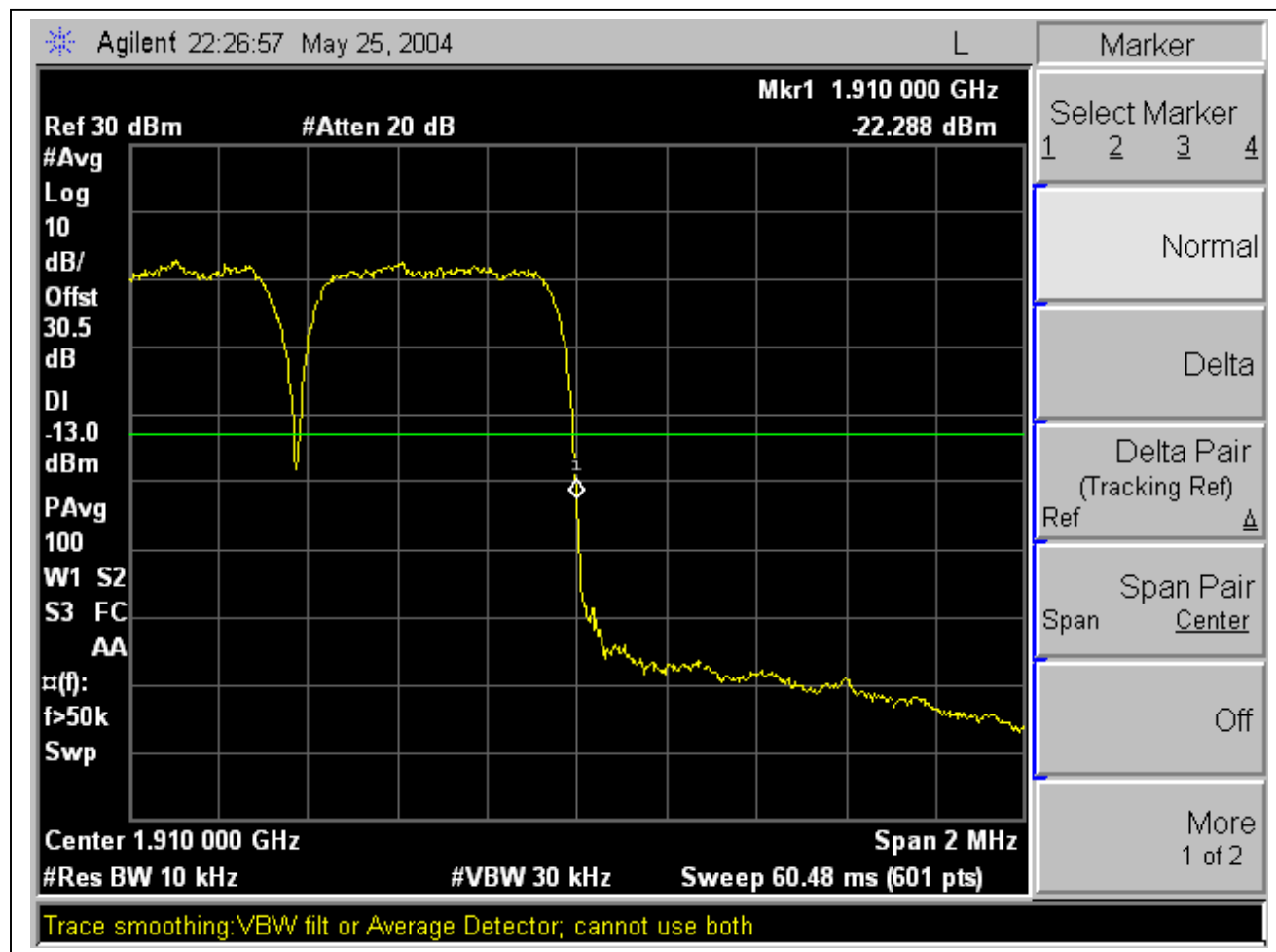

Low Channel, Out-Of-Band Emissions

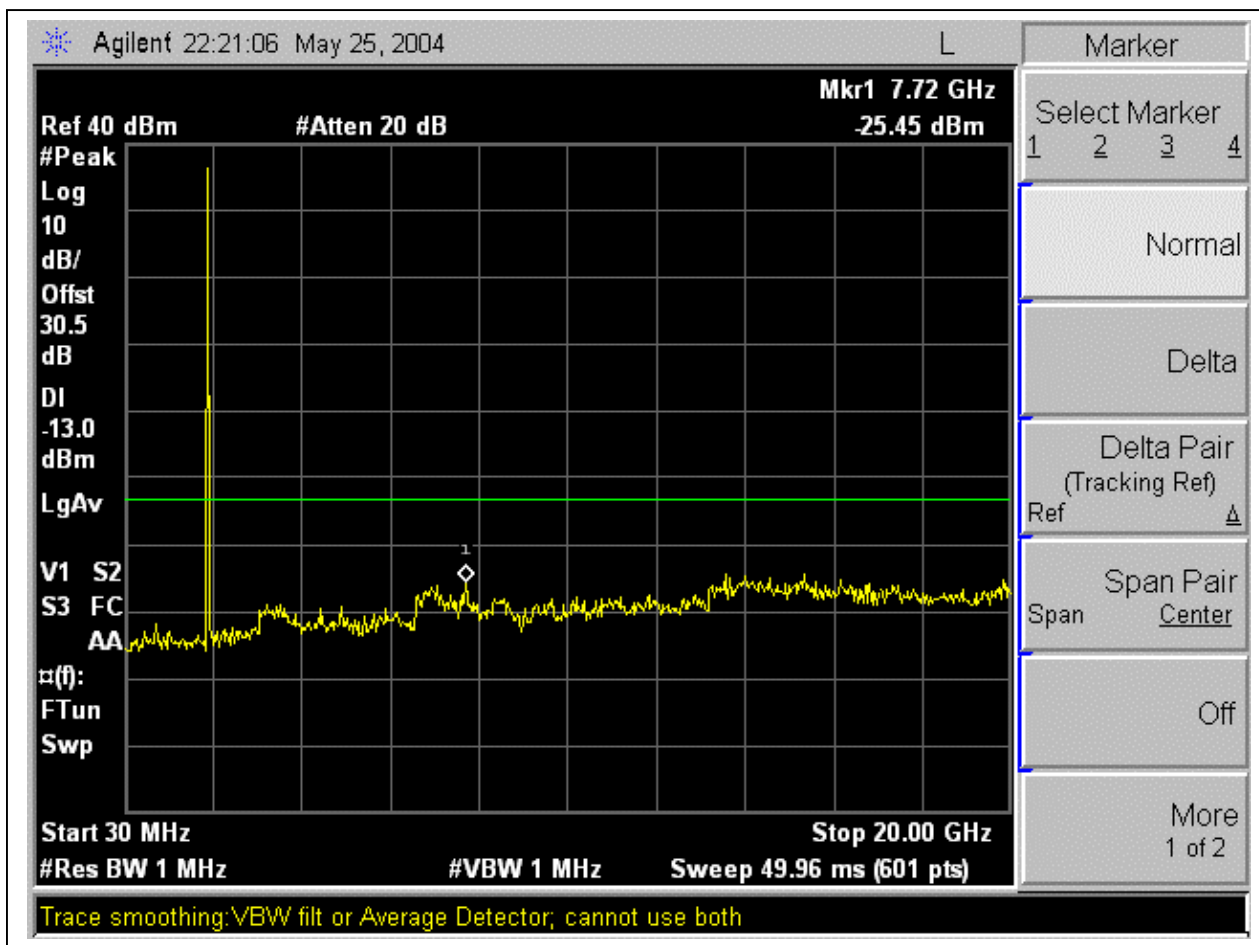

High Channel, Out-Of-Band Emissions

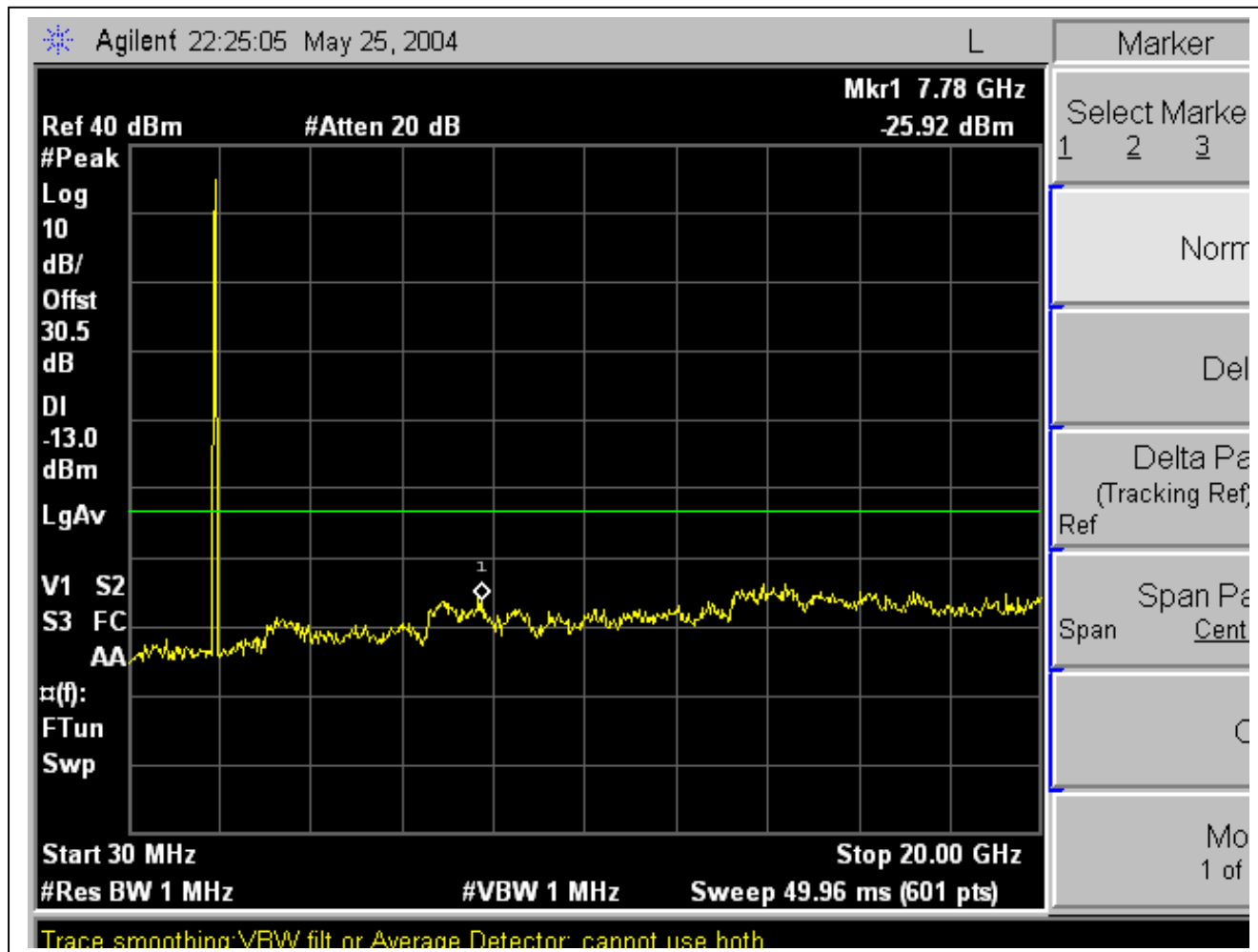

7.5. SECTION 2.1053: FIELD STRENGTH OF SPURIOUS RADIATION

INSTRUMENTS LIST

TEST EQUIPMENT LIST				
Name of Equipment	Manufacturer	Model No.	Serial No.	Due Date
Spectrum Analyzer	Agilent	E4446A	MY43360112	1/13/2005
Amplifier 1-26GHz	MITEQ	NSP2600-SP	924342	4/25/2005
Antenna, Horn 1 ~ 18 GHz	EMCO	3115	6717	2/4/2005
Antenna, Horn 1 ~ 18 GHz	EMCO	3115	3328	2/4/2005
Peak Power Meter	Agilent	E4416A	GB41291160	11/7/2004
Antenna, Tuned Dipole	CDI	Roberts	116	5/15/2005
Bilog 30MHz - 2GHz	Sunol	JB1 Antenna	A121003	12/22/2004
EMI Receiver	HP	8540E	3705A00256	11/21/2004
2.7GHz HPF	MicroTronic	HPM13194	1	CNR
10dB Attenuator	Weinschel	56-10	M2348	CNR
Signal Generator	R & S	SMP04	DE34210	5/25/2005
20dB Attenuator	Weinschel	WA33-20	A210	CNR
50 ohm Terminator	TDC	N/A	N/A	N/A

Detector Function Setting of Test Receiver

Frequency Range (MHz)	Detector Function	Resolution Bandwidth	Video Bandwidth
Above 1000	<input checked="" type="checkbox"/> Peak <input type="checkbox"/> Average	<input checked="" type="checkbox"/> 1 MHz <input type="checkbox"/> 1 MHz	<input checked="" type="checkbox"/> 1 MHz <input type="checkbox"/> 10 Hz

TEST SETUP

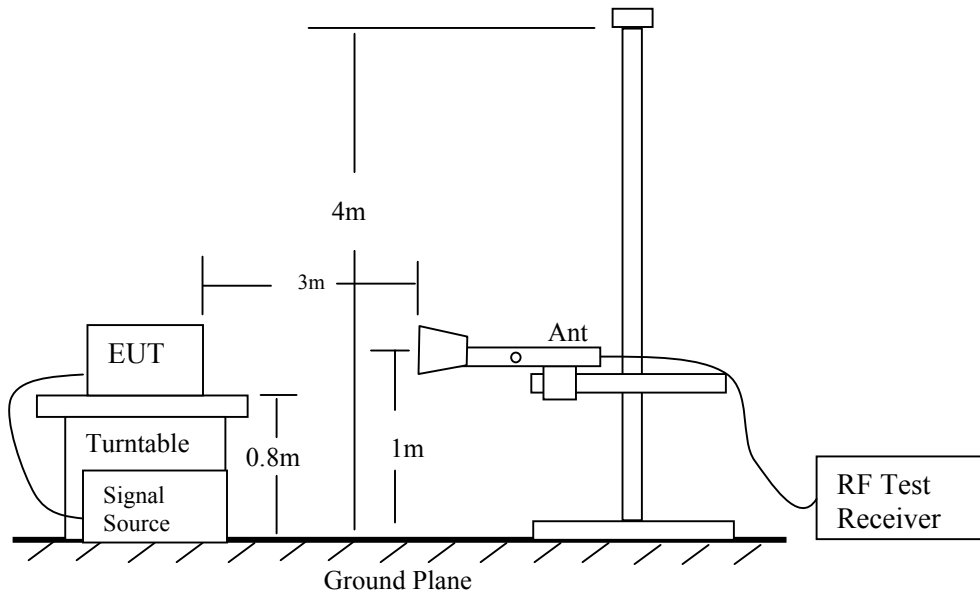

Fig 1: Radiated Emission Measurement

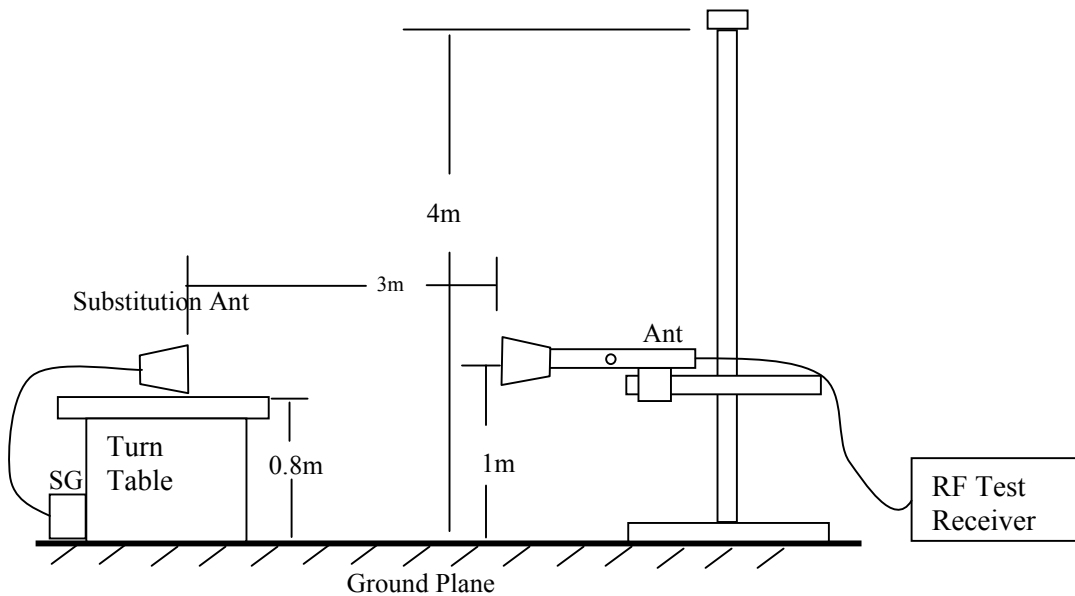

Fig 2: Radiated Emission – Substitution Method set-up

TEST PROCEDURE

- 1). On a test site, the EUT shall be placed on a turntable, and in the position closest to the normal use as declared by the user.
- 2). The test antenna shall be oriented initially for vertical polarization located 1m from the EUT to correspond to the frequency of the transmitter.
- 3). The output of the test antenna shall be connected to the measuring receiver and either a peak or average detector was used for the measurement as indicated on the report. The detector selection is based on how close the emission level was approaching the limit.
- 4). The transmitter shall be switched on, if possible, without the modulation and the measurement receiver shall be tuned to the frequency of the transmitter under test.
- 5). The test antenna shall be raised and lowered through the specified range of height until a maximum signal level is detected by the measuring receiver.
- 6). The transmitter shall then be rotated through 360° in the horizontal plane, until the maximum signal level is detected by the measuring receiver.
- 7). The test antenna shall be raised and lowered again through the specified range of height until a maximum signal level is detected by the measuring receiver.
- 8). The maximum signal level detected by the measuring receiver shall be noted.
- 9). The transmitter shall be replaced by a substitution antenna.
- 10). The substitution antenna shall be oriented for vertical polarization.
- 11). The substitution antenna shall be connected to a calibrated signal generator.
- 12). If necessary, the input attenuator setting of the measuring receiver shall be adjusted in order to increase the sensitivity of the measuring receiver.
- 13). The test antenna shall be raised and lowered through the specified range of the height to ensure that the maximum signal is received.
- 14). The input signal to the substitution antenna shall be adjusted to the level that produces a level detected by the measuring receiver, that is equal to the level noted while the transmitter radiated power was measured, corrected for the change of input attenuation setting of the measuring receiver.
- 15). The input level to the substitution antenna shall be recorded as power level in dBm, corrected for any change of input attenuator setting of the measuring receiver.
- 16). The measurement shall be repeated with the test antenna and the substitution antenna oriented for horizontal polarization.
- 17). The measure of the effective radiated power is the larger of the two levels recorded, at the input to the substitution antenna, corrected for the gain of the substitution antenna if necessary.

RESULT

No non-compliance noted, as shown below

BPSK: Low, & High Channels:

05/26/04 High Frequency Substitution Measurement Compliance Certification Services, Morgan Hill 5m Chamber Site										
Test Engr: Chin Pang Project #: 04I2701-1 Company: KYOCERA EUT Descr.: 1.9GHz IBURST BASE STATION EUT M/N: Q05 (BS) Test Target: FCC PART 24E Mode Oper: TX_BPSK_HARMONIC SPUR & SUBSTITUTION LOW / HI CHANNELS FOR 12 ANTENNAS										
Test Equipment:										
EMCO Horn 1-18GHz T73: S/N: 6717 @3m			Horn > 18GHz			Limit FCC 24				
Hi Frequency Cables <input type="checkbox"/> (2 ft) <input checked="" type="checkbox"/> (2 ~ 3 ft) <input type="checkbox"/> (4 ~ 6 ft) <input checked="" type="checkbox"/> (12 ft)						Pre-amplifier 1-26GHz T87 Miteq 924342		Pre-amplifier 26-40GHz		
f GHz	SA reading (dBuV/m)	Ant. Pol. (H/V)	SG reading (dBm)	CL (dB)	Gain (dBi)	Gain (dBd)	EIRP (dBm)	Limit (dBm)	Margin (dB)	Notes
LOW 1905.3125MHz										
2.800	56.8	V	-49.6	2.7	8.9	6.8	-43.4	-13.0	-30.4	
3.811	51.5	V	-53.0	3.3	9.6	7.5	-46.7	-13.0	-33.7	NOISE FLOOR
2.800	56.2	H	-50.0	2.7	8.9	6.8	-43.8	-13.0	-30.8	
3.811	51.3	H	-53.1	3.3	9.6	7.5	-46.8	-13.0	-33.8	NOISE FLOOR
							0.0	-13.0		
HI 1909.6875MHz										
2.800	57.0	V	-49.4	2.7	8.9	6.8	-43.2	-13.0	-30.2	
3.819	51.7	V	-52.8	3.3	9.6	7.5	-46.5	-13.0	-33.5	NOISE FLOOR
2.800	56.6	H	-49.6	2.7	8.9	6.8	-43.4	-13.0	-30.4	
3.819	51.0	H	-53.4	3.3	9.6	7.5	-47.1	-13.0	-34.1	NOISE FLOOR
NO OTHER SPURIOUS EMISSION WERE DETECTED UP TO 20GHz)										

QPSK: Low, & High Channels:

05/26/04 High Frequency Substitution Measurement Compliance Certification Services, Morgan Hill 5m Chamber Site										
Test Engr: Chin Pang Project #: 04I2701-1 Company: KYOCERA EUT Descrip.: 1.9GHz IBURST BASE STATION EUT M/N: Q05 (BS) Test Target: FCC PART 24E Mode Oper: TX_QPSK _ HARMONIC SPUR & SUBSTITUTION LOW / HI CHANNELS FOR 12 ANTENNAS										
Test Equipment:										
EMCO Horn 1-18GHz T73; S/N: 6717 @3m			Horn > 18GHz			Limit FCC 24				
Hi Frequency Cables <input type="checkbox"/> (2 ft) <input checked="" type="checkbox"/> (2 ~ 3 ft) <input type="checkbox"/> (4 ~ 6 ft) <input checked="" type="checkbox"/> (12 ft)				Pre-amplifier 1-26GHz T87 Miteq 924342			Pre-amplifier 26-40GHz			
f GHz	SA reading (dBuV/m)	Ant. Pol. (H/V)	SG reading (dBm)	CL (dB)	Gain (dBi)	Gain (dBd)	EIRP (dBm)	Limit (dBm)	Margin (dB)	Notes
LOW 1905.3125MHz										
2.800	57.1	V	-49.3	2.7	8.9	6.8	-43.1	-13.0	-30.1	
3.811	51.8	V	-52.7	3.3	9.6	7.5	-46.4	-13.0	-33.4	NOISE FLOOR
2.800	56.7	H	-49.5	2.7	8.9	6.8	-43.3	-13.0	-30.3	
3.811	51.3	H	-53.2	3.3	9.6	7.5	-46.8	-13.0	-33.8	NOISE FLOOR
							0.0	-13.0		
HI 1909.6875MHz										
2.800	56.6	V	-49.8	2.7	8.9	6.8	-43.6	-13.0	-30.6	
3.819	52.8	V	-51.7	3.3	9.6	7.5	-45.4	-13.0	-32.4	NOISE FLOOR
2.800	55.8	H	-50.4	2.7	8.9	6.8	-44.2	-13.0	-31.2	
3.819	50.7	H	-53.7	3.3	9.6	7.5	-47.3	-13.0	-34.3	NOISE FLOOR
NO OTHER SPURIOUS EMISSION WERE DETECTED UP TO 20GHz)										

8PSK: Low, & High Channels:

05/26/04 High Frequency Substitution Measurement
 Compliance Certification Services, Morgan Hill 5m Chamber Site

Test Engr: Chin Pang
 Project #: 04I2701-1
 Company: KYOCERA
 EUT Descr.: 1.9GHz IBURST BASE STATION
 EUT M/N: Q05 (BS)
 Test Target: FCC PART 24E
 Mode Oper: TX_8PSK_HARMONIC SPUR & SUBSTITUTION LOW / HI CHANNELS FOR 12 ANTENNAS

Test Equipment:

EMCO Horn 1-18GHz: T73; S/N: 6717 @3m
 Horn > 18GHz:
 Limit: FCC 24

Hi Frequency Cables: (2 ft) (2 ~ 3 ft) (4 ~ 6 ft) (12 ft)

Pre-amplifer 1-26GHz: T87 Miteq 924342
 Pre-amplifer 26-40GHz:

f GHz	SA reading (dBuV/m)	Ant. Pol. (H/V)	SG reading (dBm)	CL (dB)	Gain (dBi)	Gain (dBd)	EIRP (dBm)	Limit (dBm)	Margin (dB)	Notes
LOW 1905.3125MHz										
2.800	56.2	V	-50.2	2.7	8.9	6.8	-44.0	-13.0	-31.0	
3.811	51.3	V	-53.2	3.3	9.6	7.5	-46.9	-13.0	-33.9	NOISE FLOOR
2.800	55.5	H	-50.7	2.7	8.9	6.8	-44.5	-13.0	-31.5	
3.811	51.0	H	-53.4	3.3	9.6	7.5	-47.1	-13.0	-34.1	NOISE FLOOR
							0.0	-13.0		
HI 1909.6875MHz										
2.800	56.4	V	-50.0	2.7	8.9	6.8	-43.8	-13.0	-30.8	
3.819	50.8	V	-53.7	3.3	9.6	7.5	-47.4	-13.0	-34.4	NOISE FLOOR
2.800	56.0	H	-50.2	2.7	8.9	6.8	-44.0	-13.0	-31.0	
3.819	50.4	H	-54.0	3.3	9.6	7.5	-47.7	-13.0	-34.7	NOISE FLOOR
NO OTHER SPURIOUS EMISSION WERE DETECTED UP TO 20GHz)										

12QAM: Low, & High Channels:

05/26/04 High Frequency Substitution Measurement											
Compliance Certification Services, Morgan Hill 5m Chamber Site											
Test Engr: Chin Pang											
Project #: 04I2701-1											
Company: KYOCERA											
EUT Descrip.: 1.9GHz IBURST BASE STATION											
EUT M/N: Q05 (BS)											
Test Target: FCC PART 24E											
Mode Oper: TX_12QAM _ HARMONIC SPUR & SUBSTITUTION LOW / HI CHANNELS FOR 12 ANTENNAS											
Test Equipment:											
EMCO Horn 1-18GHz			Horn >18GHz			Limit					
T73; S/N: 6717 @3m						FCC 24					
Hi Frequency Cables						Pre-amplifer 1-26GHz			Pre-amplifer 26-40GHz		
<input type="checkbox"/> (2 ft) <input checked="" type="checkbox"/> (2 ~ 3 ft) <input type="checkbox"/> (4 ~ 6 ft) <input checked="" type="checkbox"/> (12 ft)						T87 Miteq 924342					
f GHz	SA reading (dBuV/m)	Ant. Pol. (H/V)	SG reading (dBm)	CL (dB)	Gain (dBi)	Gain (dBd)	EIRP (dBm)	Limit (dBm)	Margin (dB)	Notes	
LOW 1905.3125MHz											
2.800	56.0	V	-50.4	2.7	8.9	6.8	-44.2	-13.0	-31.2		
3.811	51.8	V	-52.7	3.3	9.6	7.5	-46.4	-13.0	-33.4	NOISE FLOOR	
2.800	56.4	H	-49.8	2.7	8.9	6.8	-43.6	-13.0	-30.6		
3.811	51.4	H	-53.0	3.3	9.6	7.5	-46.7	-13.0	-33.7	NOISE FLOOR	
							0.0	-13.0			
HI 1909.6875MHz											
2.800	55.4	V	-51.0	2.7	8.9	6.8	-44.8	-13.0	-31.8		
3.819	51.3	V	-53.2	3.3	9.6	7.5	-46.9	-13.0	-33.9	NOISE FLOOR	
2.800	55.3	H	-50.9	2.7	8.9	6.8	-44.7	-13.0	-31.7		
3.819	51.3	H	-53.1	3.3	9.6	7.5	-46.8	-13.0	-33.8	NOISE FLOOR	
NO OTHER SPURIOUS EMISSION WERE DETECTED UP TO 20GHz)											

16QAM: Low, & High Channels:

05/26/04 High Frequency Substitution Measurement Compliance Certification Services, Morgan Hill 5m Chamber Site										
Test Engr: VIEN TRAN Project #: 04I2701-1 Company: KYOCERA EUT Descrip.: 1.9GHz IBURST BASE STATION EUT M/N: Q05 (BS) Test Target: FCC PART 24E Mode Oper: TX_16QAM _ HARMONIC SPUR & SUBSTITUTION LOW/ MID / HI CHANNELS FOR 12 ANTENNAS										
Test Equipment:										
EMCO Horn 1-18GHz T73; S/N: 6717 @3m			Horn >18GHz			Limit FCC 24				
Hi Frequency Cables <input type="checkbox"/> (2 ft) <input checked="" type="checkbox"/> (2 ~ 3 ft) <input type="checkbox"/> (4 ~ 6 ft) <input checked="" type="checkbox"/> (12 ft)				Pre-amplifer 1-26GHz T87 Miteq 924342			Pre-amplifer 26-40GHz			
f GHz	SA reading (dBuV/m)	Ant. Pol. (H/V)	SG reading (dBm)	CL (dB)	Gain (dBi)	Gain (dBd)	EIRP (dBm)	Limit (dBm)	Margin (dB)	Notes
LOW 1905.3125MHz										
2.800	56.8	V	-49.6	2.7	8.9	6.8	-43.4	-13.0	-30.4	
3.811	54.6	V	-49.9	3.3	9.6	7.5	-43.6	-13.0	-30.6	NOISE FLOOR
2.800	56.4	H	-49.8	2.7	8.9	6.8	-43.6	-13.0	-30.6	
3.811	52.8	H	-51.6	3.3	9.6	7.5	-45.3	-13.0	-32.3	NOISE FLOOR
							0.0	-13.0		
HI 1909.6875MHz										
2.800	57.0	V	-49.4	2.7	8.9	6.8	-43.2	-13.0	-30.2	
3.819	52.8	V	-51.7	3.3	9.6	7.5	-45.4	-13.0	-32.4	NOISE FLOOR
2.800	56.5	H	-49.7	2.7	8.9	6.8	-43.5	-13.0	-30.5	
3.819	51.2	H	-53.2	3.3	9.6	7.5	-46.9	-13.0	-33.9	NOISE FLOOR
NO OTHER SPURIOUS EMISSION WERE DETECTED UP TO 20GHz)										

24QAM: Low, & High Channels:

05/26/04 High Frequency Substitution Measurement Compliance Certification Services, Morgan Hill 5m Chamber Site											
Test Engr: Chin Pang Project #: 04I2701-1 Company: KYOCERA EUT Descrip.: 1.9GHz IBURST BASE STATION EUT M/N: Q05 (BS) Test Target: FCC PART 24E Mode Oper: TX_24QAM _ HARMONIC SPUR & SUBSTITUTION LOW / HI CHANNELS FOR 12 ANTENNAS											
Test Equipment:											
EMCO Horn 1-18GHz T73; S/N: 6717 @3m			Horn >18GHz			Limit FCC 24					
Hi Frequency Cables <input type="checkbox"/> (2 ft) <input checked="" type="checkbox"/> (2 ~ 3 ft) <input type="checkbox"/> (4 ~ 6 ft) <input checked="" type="checkbox"/> (12 ft)						Pre-amplifier 1-26GHz T87 Miteq 924342			Pre-amplifier 26-40GHz		
f GHz	SA reading (dBuV/m)	Ant. Pol. (H/V)	SG reading (dBm)	CL (dB)	Gain (dBi)	Gain (dBd)	EIRP (dBm)	Limit (dBm)	Margin (dB)	Notes	
LOW 1905.3125MHz											
2.800	56.5	V	-49.9	2.7	8.9	6.8	-43.7	-13.0	-30.7		
3.811	51.1	V	-53.4	3.3	9.6	7.5	-47.1	-13.0	-34.1	NOISE FLOOR	
2.800	55.3	H	-50.9	2.7	8.9	6.8	-44.7	-13.0	-31.7		
3.811	50.6	H	-53.8	3.3	9.6	7.5	-47.5	-13.0	-34.5	NOISE FLOOR	
							0.0	-13.0			
HI 1909.6875MHz											
2.800	56.8	V	-49.6	2.7	8.9	6.8	-43.4	-13.0	-30.4		
3.819	51.6	V	-52.9	3.3	9.6	7.5	-46.6	-13.0	-33.6	NOISE FLOOR	
2.800	56.4	H	-49.8	2.7	8.9	6.8	-43.6	-13.0	-30.6		
3.819	50.8	H	-53.7	3.3	9.6	7.5	-47.3	-13.0	-34.3	NOISE FLOOR	
NO OTHER SPURIOUS EMISSION WERE DETECTED UP TO 20GHz											

8 Carriers run in the same time @ worst modulation:

05/26/04 **High Frequency Substitution Measurement**
Compliance Certification Services, Morgan Hill 5m Chamber Site

Test Engr: VIEN TRAN
 Project #: 04I2701-1
 Company: KYOCERA
 EUT Descrip.: 1.9GHz IBURST BASE STATION
 EUT M/N: Q05 (BS)
 Test Target: FCC PART 24E
 Mode Oper: TX_8 CARRIERS & 16QAM (worst case) _ SUBSTITUTION FOR HARMONIC & SPUR_ LOW/ HI CHANNELS

Test Equipment:

EMCO Horn 1-18GHz Horn > 18GHz Limit High Pass Filter
 T73; S/N: 6717 @3m EIRP

Hi Frequency Cables Pre-amplifer 1-26GHz Pre-amplifer 26-40GHz
 (2 ft) (2 ~ 3 ft) (4 ~ 6 ft) (12 ft) T87 Miteq 924342

f GHz	SA reading (dBuV/m)	Ant. Pol. (H/V)	SG reading (dBm)	CL (dB)	Gain (dBi)	Gain (dBd)	EIRP (dBm)	Limit (dBm)	Margin (dB)	Notes
3.818	49.9	V	-54.6	3.3	9.6	7.5	-48.3	-13.0	-35.3	SPUR
5.729	49.4	V	-51.9	4.2	11.2	9.1	-44.9	-13.0	-31.9	SPUR
7.635	51.9	V	-45.3	5.4	11.5	9.3	-39.2	-13.0	-26.2	SPUR
3.818	45.0	H	-59.4	3.3	9.6	7.5	-53.1	-13.0	-40.1	SPUR
5.729	44.1	H	-56.2	4.2	11.2	9.1	-49.2	-13.0	-36.2	SPUR
7.635	46.0	H	-50.3	5.4	11.5	9.3	-44.3	-13.0	-31.3	SPUR

7.6. SECTION 2.1055: FREQUENCY STABILITY

INSTRUMENTS LIST

Detector Function Setting of Test Receiver

Frequency Range (MHz)	Detector Function	Resolution Bandwidth	Video Bandwidth
Show entire High emissions	Peak	300 Hz	300 Hz

TEST SETUP

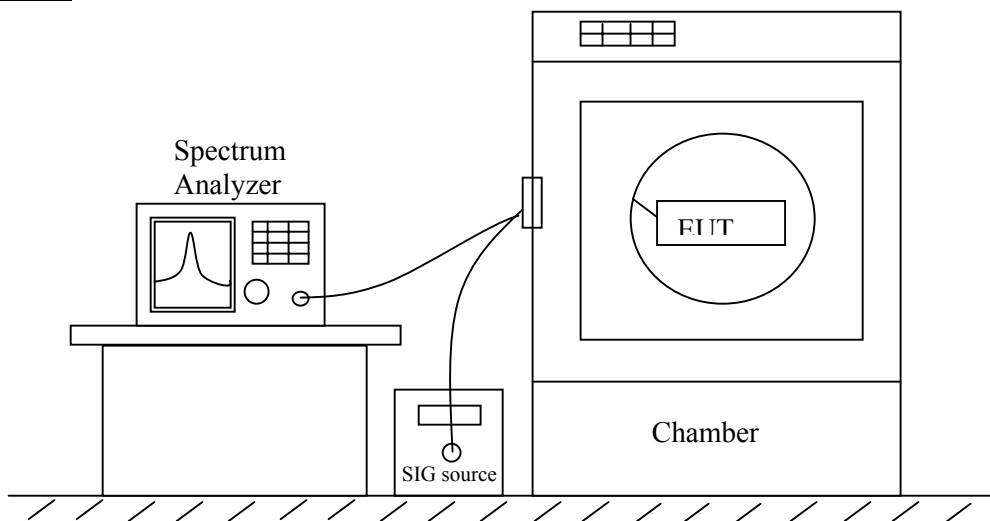

Fig. 3: Frequency Stability Setup

Test Setup Photos



TEST PROCEDURE

- **Frequency stability versus environmental temperature**

- 1). Setup the configuration per figure 6 for frequencies measurement inside the environmental chamber. Set the temperature of the chamber to 25°C. Set SA Resolution Bandwidth low enough to obtain the desired frequency resolution and measure the EUT 25°C operating frequency as reference frequency.
- 2). Turn EUT off and set Chamber temperature to -30°C.
- 3). Allow sufficient time (approximately 20 to 30 mins after chamber reach the assigned temperature) for EUT to stabilize. Turn on EUT and measure the EUT operating frequency. Turn off EUT after the measurement.
- 4). Repeat step 3 with a 10°C increased per stage until the highest temperature of +50°C reached, record all measured frequencies on each temperature step.

- **Frequency stability versus AC input voltage**

- 1). Setup the configuration per figure 6 and set chamber temperature to 25°C. Use a variable AC power supply to power the EUT and set AC output voltage to EUT nominal input AC voltage. Set SA Resolution Bandwidth low enough to obtain the desired frequency resolution and measure the EUT 25°C operating frequency as reference frequency.
- 2). Slowly reduce the EUT input voltage to specified extreme voltage variation ($\pm 15\%$) and record the maximum frequency change.

RESULT

No non-compliance noted, as shown below because the EUT uses the same OSC in both receiver and transmitter LO circuit. As a result, the frequency does not shift in Frequency Stability Test.

Frequency stability versus environmental temperature

Reference Frequency: High Channel @ 25°C Limit: to stay within the authorized block (~4KHz)					
Power Supply (Vac)	Environment Temp (°C)	Frequency Deviation Measured with Time Elapse			
		(MHz)	Delta (ppm)	Limit (ppm)	Delta (Hz)
115.00	50	1909.98625	-0.708	± 2.5	1353
115.00	40	1909.98624	-0.700	± 2.5	1337
115.00	30	1909.98577	-0.457	± 2.5	872
115.00	25	1909.98490	0	± 2.5	0
115.00	20	1909.98579	-0.465	± 2.5	889
115.00	10	1909.98585	-0.499	± 2.5	953
115.00	0	1909.98545	-0.288	± 2.5	551
115.00	-10	1909.98625	-0.707	± 2.5	1351
115.00	-20	1909.98659	-0.884	± 2.5	1688
115.00	-30	1909.98605	-0.604	± 2.5	1154
97.75	25	1909.98389	0.529	± 2.5	-1011
132.25	25	1909.98614	-0.650	± 2.5	1241

7.7. RADIATED EMISSION

Detector Setting of Spectrum Analyzer

Frequency Range (MHz)	Detector Function	Resolution Bandwidth	Video Bandwidth
30 to 1000	<input checked="" type="checkbox"/> Peak	<input checked="" type="checkbox"/> 100 KHz	<input checked="" type="checkbox"/> 100 KHz
	<input checked="" type="checkbox"/> Quasi Peak	<input checked="" type="checkbox"/> 1 MHz	<input checked="" type="checkbox"/> 1 MHz

!

INSTRUMENTS LIST

TEST EQUIPMENT LIST				
Name of Equipment	Manufacturer	Model No.	Serial No.	Due Date
Spectrum Analyzer	Agilent	E4446A	MY43360112	1/13/2005
EMI Receiver, 9 kHz ~ 2.9 GHz	HP	8542E	3942A00286	11/21/2004
RF Filter Section	HP	85420E	3705A00256	11/21/2004
30MHz--- 2Ghz	Sunol Sciences	JB1 Antenna	A121003	12/22/2004
Amplifier 1-26GHz	MITEQ	NSP2600-SP	924342	4/25/2005
Antenna, Horn 1 ~ 18 GHz	EMCO	3115	6717	2/4/2005
EMI Test Receiver	R & S	ESHS 20	827129/006	7/17/2004
2.7GHz HPF	MicroTronic	HPM13194	1	CNR

TEST SETUP FOR DIGITAL RADIATED EMISSIONS

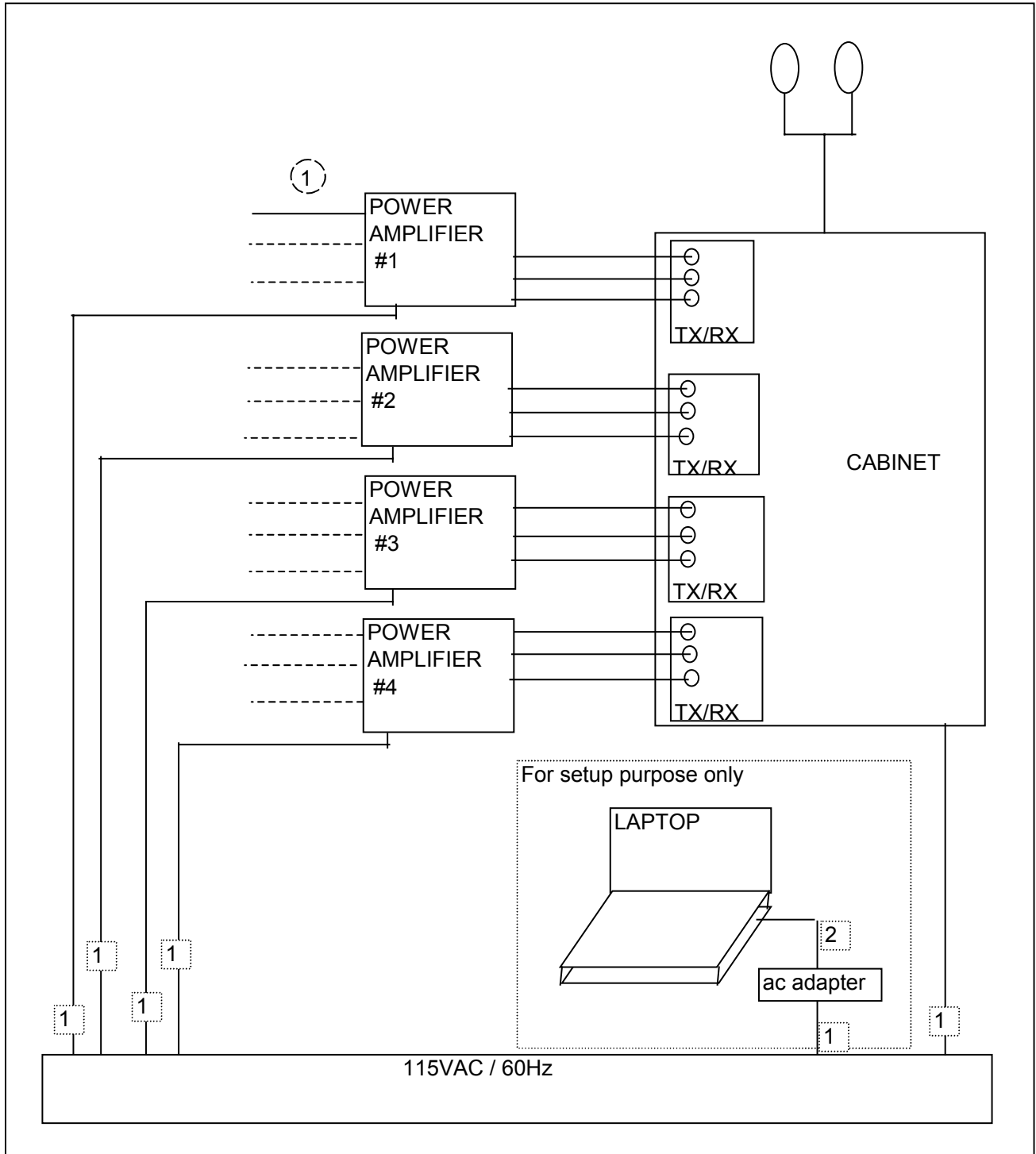

TEST PROCEDURE

1. The EUT was placed on the turn table 0.8 meter above ground inside 3 meter Anechoic Chamber.
2. Set the resolution bandwidth to 120KHz in the test receiver and select Peak function to scan the frequency below 1 GHz.
3. Shift the interference-receiving antenna located in antenna tower upwards and downwards between 1 and 4 meters above ground and find out the local peak emission on frequency domain.
4. Locate the interference-receiving antenna at the position where the local peak reach the maximum emission.
5. Rotate the turn table and stop at the angle where the measurement device has maximum reading
6. Shift the interference-receiving antenna again to detect the maximum emission of the local peak
7. If the reading of the local peak under Peak function is lower than limit by 6dB, then Quasi Peak detection is not needed and this reading should be recorded. And if it is higher than Peak limit, then the test is fail. Others, switch the receiver to Quasi Peak function, set the resolution bandwidth to 100kHz and repeat the procedures (3)~(6). If the reading is lower than limit, this reading should be recorded, otherwise, the test is fail.

MEASUREMENT RESULT

No non-compliance noted, as shown below.

Radiated Emission Vertical

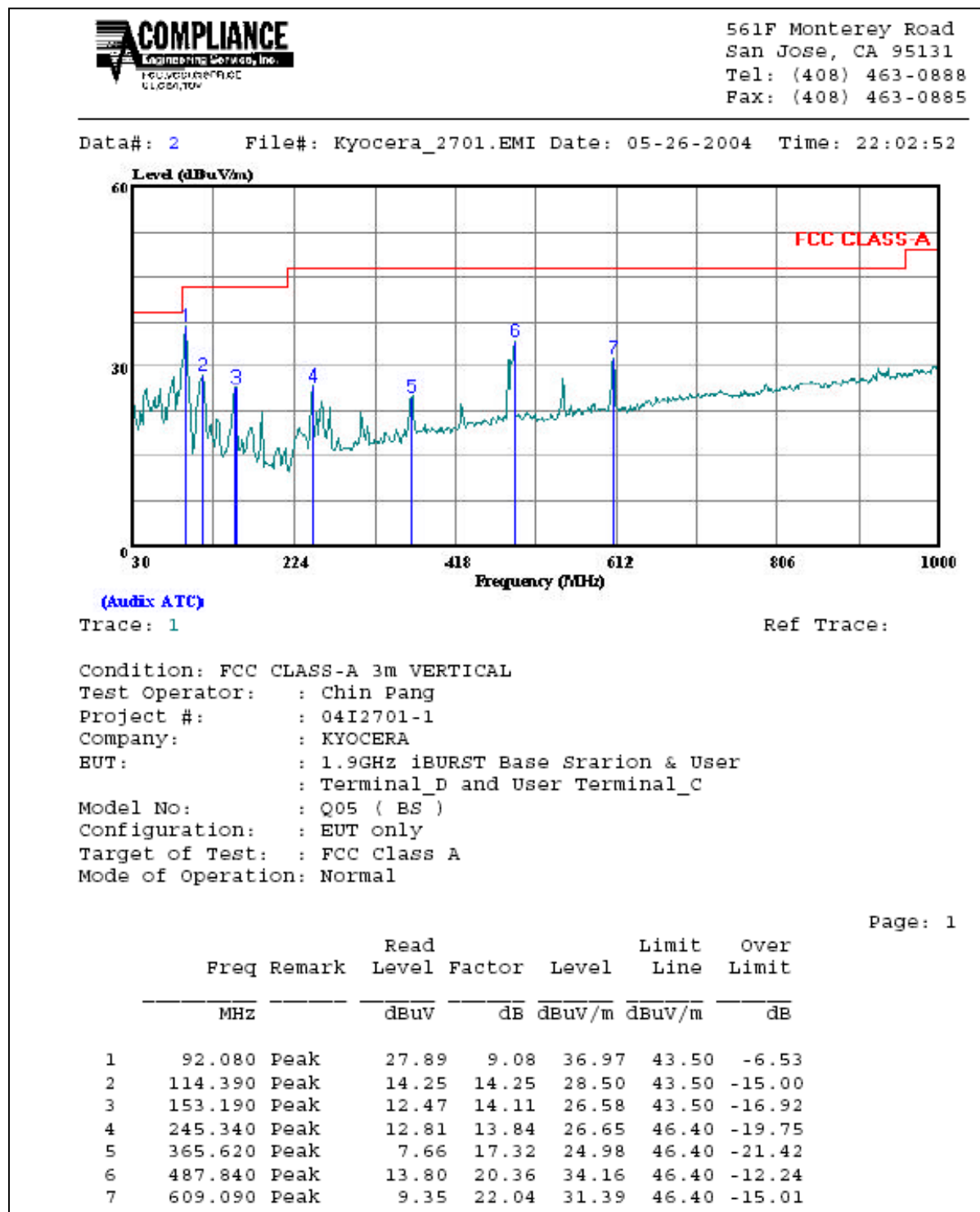

561F Monterey Road
 San Jose, CA 95131
 Tel: (408) 463-0888
 Fax: (408) 463-0885

Data#: 2 File#: Kyocera_2701.EMI Date: 05-26-2004 Time: 22:02:52

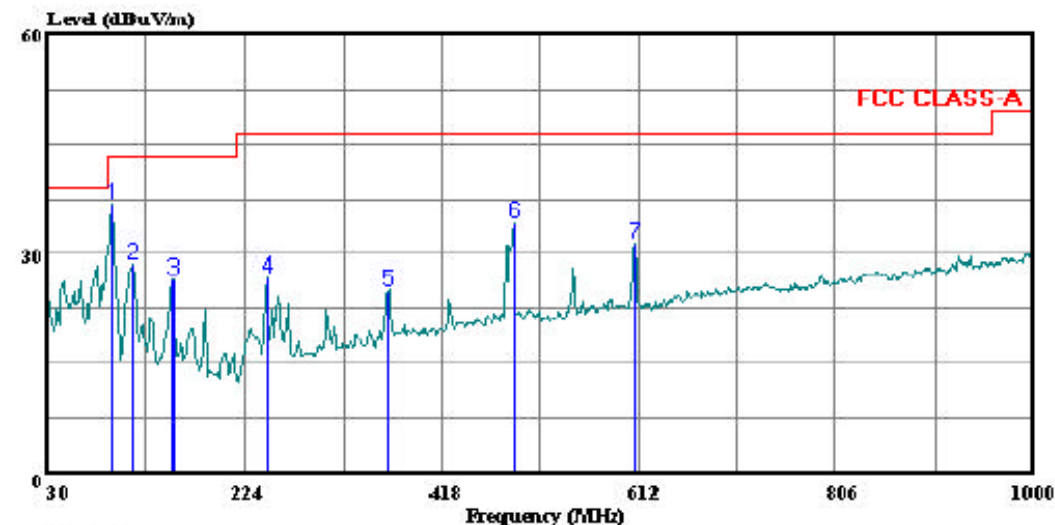

(Aux: ATC)

Trace: 1

Ref Trace:

Condition: FCC CLASS-A 3m VERTICAL
 Test Operator: : Chin Pang
 Project #: : 04I2701-1
 Company: : KYOCERA
 EUT: : 1.9GHz iBURST Base Station & User
 : Terminal_D and User Terminal_C
 Model No: : Q05 (BS)
 Configuration: : EUT only
 Target of Test: : FCC Class A
 Mode of Operation: Normal

Page: 1

	Freq	Remark	Read Level	Read Factor	Level	Limit	Over
	MHz		dBUV	dB	dBUV/m	dBUV/m	dB
1	92.080	Peak	27.89	9.08	36.97	43.50	-6.53
2	114.390	Peak	14.25	14.25	28.50	43.50	-15.00
3	153.190	Peak	12.47	14.11	26.58	43.50	-16.92
4	245.340	Peak	12.81	13.84	26.65	46.40	-19.75
5	365.620	Peak	7.66	17.32	24.98	46.40	-21.42
6	487.840	Peak	13.80	20.36	34.16	46.40	-12.24
7	609.090	Peak	9.35	22.04	31.39	46.40	-15.01

Radiated Emission Horizontal

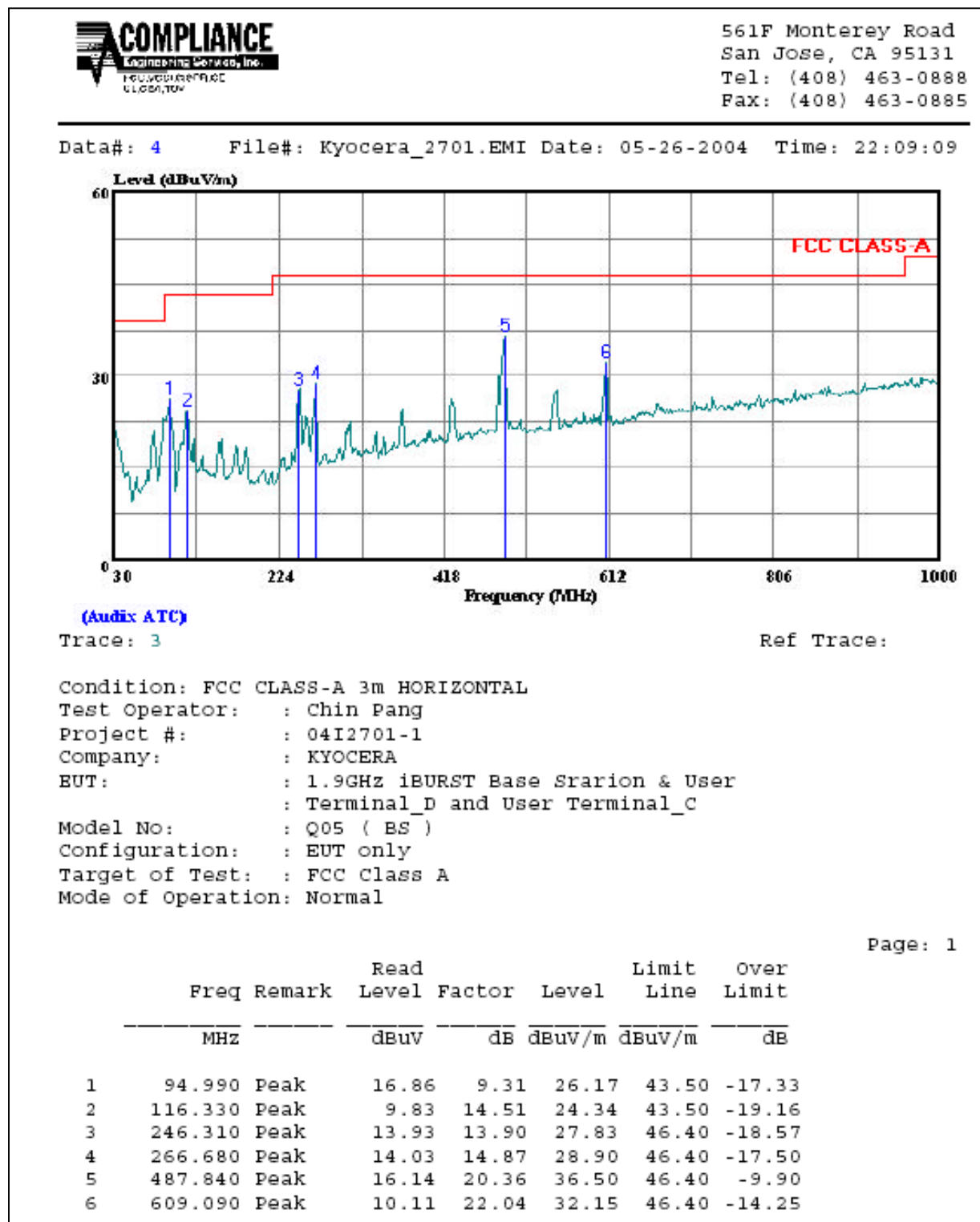

	Freq	Remark	Read Level	Factor	Level	Limit Line	Over Limit
	MHz		dBuV	dB	dBuV/m	dBuV/m	dB
1	94.990	Peak	16.86	9.31	26.17	43.50	-17.33
2	116.330	Peak	9.83	14.51	24.34	43.50	-19.16
3	246.310	Peak	13.93	13.90	27.83	46.40	-18.57
4	266.680	Peak	14.03	14.87	28.90	46.40	-17.50
5	487.840	Peak	16.14	20.36	36.50	46.40	-9.90
6	609.090	Peak	10.11	22.04	32.15	46.40	-14.25

05/26/04 **High Frequency Measurement**
 Compliance Certification Services, Morgan Hill Open Field Site

Test Engr: Chin Pang
 Project #: 04I2701-1
 Company: KYOCERA
 EUT Descrip.: 1.9GHz iBURST Base Station
 EUT M/N: Q05(BS),
 Test Target: FCC Class A
 Mode Oper: Normal

Test Equipment:

EMCO Horn 1-18GHz T73; S/N: 6717 @3m	Spectrum Analyzer Agilent E4446A Analyzer	Pre-amplifier 1-26GHz T87 Miteq 924342	Pre-amplifier 26-40GHz	Horn > 18GHz
---	--	---	------------------------	--------------

Hi Frequency Cables
 (2 ft) (2 ~ 3 ft) (4 ~ 6 ft) (12 ft)

		Peak Measurements:				Average Measurements:				
		1 MHz Resolution Bandwidth				1 MHz Resolution Bandwidth				
		1MHz Video Bandwidth				10Hz Video Bandwidth				

f GHz	Dist feet	Read Pk dBuV	Read Avg. dBuV	AF dB/m	CL dB	Amp dB	D Corr dB	HPF	Peak dBuV/m	Avg dBuV/m	Pk Lim dBuV/m	Avg Lim dBuV/m	Pk Mar dB	Avg Mar dB	Notes
1.330	9.8	38.0	25.7	25.1	1.6	-43.4	0.0	0.0	21.3	9.0	69.5	49.5	-48.2	-40.5	V
2.800	9.8	39.5	35.5	30.2	2.4	-43.2	0.0	0.0	28.9	24.9	69.5	49.5	-40.6	-24.6	V
3.132	9.8	31.5	19.5	30.9	2.5	-43.3	0.0	0.0	21.6	9.6	69.5	49.5	-47.9	-39.9	V
1.330	9.8	35.8	24.5	25.1	1.6	-43.4	0.0	0.0	19.1	7.8	69.5	49.5	-50.4	-41.7	H
2.800	9.8	38.5	34.8	30.2	2.4	-43.2	0.0	0.0	27.9	24.2	69.5	49.5	-41.6	-25.3	H
4.310	9.8	32.5	20.8	32.8	3.0	-44.3	0.0	0.0	24.1	12.4	69.5	49.5	-45.4	-37.1	H

f	Measurement Frequency	Amp	Preamp Gain	Avg Lim	Average Field Strength Limit
Dist	Distance to Antenna	D Corr	Distance Correct to 3 meters	Pk Lim	Peak Field Strength Limit
Read	Analyzer Reading	Avg	Average Field Strength @ 3 m	Avg Mar	Margin vs. Average Limit
AF	Antenna Factor	Peak	Calculated Peak Field Strength	Pk Mar	Margin vs. Peak Limit
CL	Cable Loss	HPF	High Pass Filter		

Radiated Emission photos

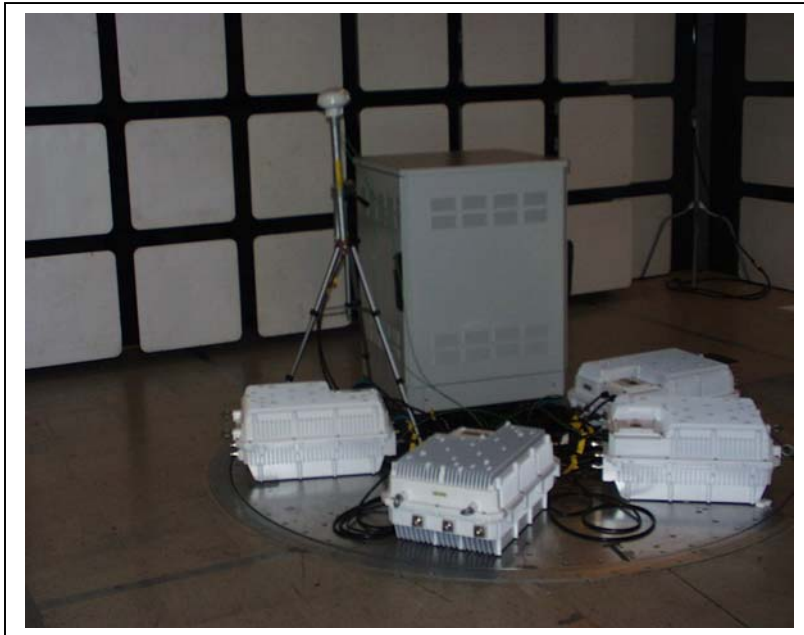
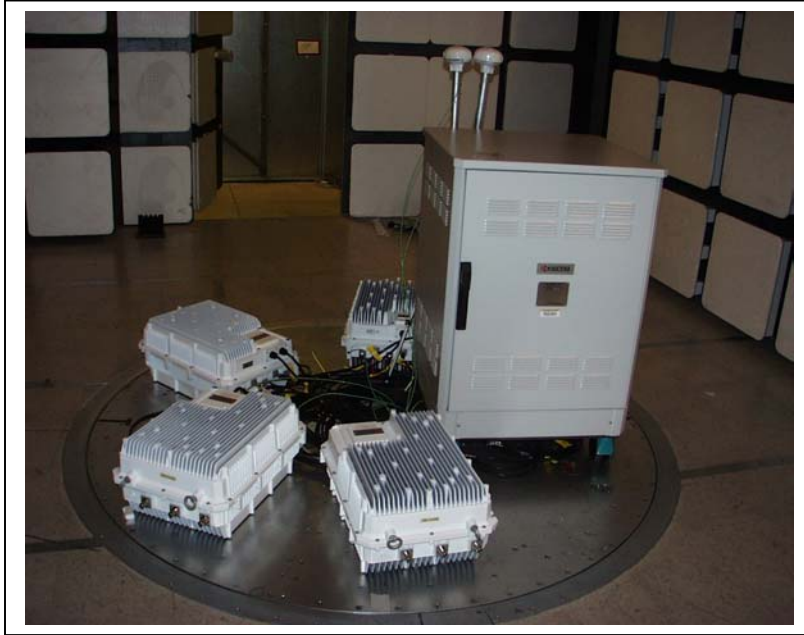

7.8. POWERLINE CONDUCTED EMISSION

Detector Function Setting of Test Receiver

Frequency Range (MHz)	Detector Function	Resolution Bandwidth	Video Bandwidth
150 KHz to 30 MHz	<input checked="" type="checkbox"/> Peak <input type="checkbox"/> CISPR Quasi Peak	<input checked="" type="checkbox"/> 9 KHz	<input checked="" type="checkbox"/> 9 KHz

INSTRUMENTS LIST

TEST EQUIPMENT LIST				
Name of Equipment	Manufacturer	Model No.	Serial No.	Due Date
10dB Attenuator	Weinschel	56-10	M2348	CNR
EMI Test Receiver	R & S	ESHS 20	827129/006	7/17/2004
LISN, 10 kHz ~ 30 MHz	FCC	50/250-25-2	114	10/13/2004
Line Filter	Lindgren	LMF-3489	497	CNR
LISN, 10 kHz ~ 30 MHz	Solar	8012-50-R-24-BNC	837990	10/13/2004
AC Power Source, 10KVA	ACS	AFC-10K-AFC-2	J1568	CNR

TEST SETUP

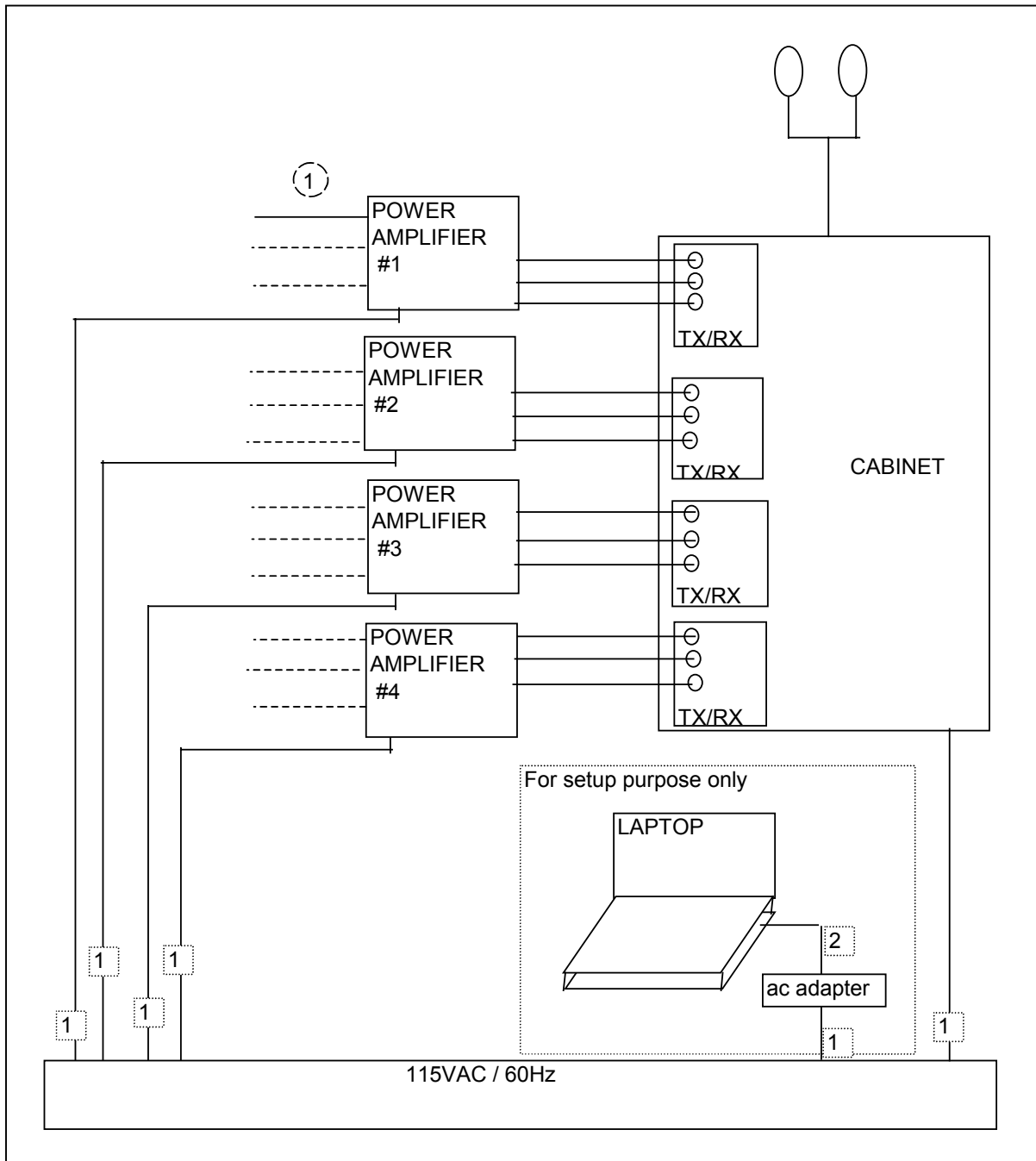

TEST PROCEDURE

1. The EUT was placed on a wooden table 40 cm from a vertical ground plane and approximately 80 cm above the horizontal ground plane on the floor. The EUT was set to transmit in a continuous mode.
2. Line conducted data was recorded for both NEUTRAL and HOT lines.

MEASUREMENT RESULT

4 PA

CONDUCTED EMISSIONS DATA (115VAC 60Hz)									
Freq.	Reading			Closs	Limit	EN A	Margin		Remark
(MHz)	PK (dBuV)	QP (dBuV)	AV (dBuV)	(dB)	QP	AV	QP (dB)	AV (dB)	L1 / L2
0.18	46.90	--	--	0.00	79.00	66.00	-32.10	-19.10	L1
0.21	44.65	--	--	0.00	79.00	66.00	-34.35	-21.35	L1
3.92	51.80	--	--	0.00	73.00	60.00	-21.20	-8.20	L1
0.18	46.46	--	--	0.00	79.00	66.00	-32.54	-19.54	L2
0.21	45.46	--	--	0.00	79.00	66.00	-33.54	-20.54	L2
3.92	48.56	--	--	0.00	73.00	60.00	-24.44	-11.44	L2
6 Worst Data									

CABINET AND 4 PA's

CONDUCTED EMISSIONS DATA (115VAC 60Hz)									
Freq.	Reading			Closs	Limit	EN A	Margin		Remark
(MHz)	PK (dBuV)	QP (dBuV)	AV (dBuV)	(dB)	QP	AV	QP (dB)	AV (dB)	L1 / L2
0.18	45.42	--	--	0.00	79.00	66.00	-33.58	-20.58	L1
0.21	44.66	--	--	0.00	79.00	66.00	-34.34	-21.34	L1
3.92	44.00	--	--	0.00	73.00	60.00	-29.00	-16.00	L1
0.18	46.00	--	--	0.00	79.00	66.00	-33.00	-20.00	L2
0.21	45.40	--	--	0.00	79.00	66.00	-33.60	-20.60	L2
3.92	44.34	--	--	0.00	73.00	60.00	-28.66	-15.66	L2
6 Worst Data									

CABINET

CONDUCTED EMISSIONS DATA (115VAC 60Hz)									
Freq. (MHz)	Reading			Class (dB)	Limit QP	EN A AV	Margin		Remark L1 / L2
	PK (dBuV)	QP (dBuV)	AV (dBuV)				QP (dB)	AV (dB)	
0.18	46.14	--	--	0.00	79.00	66.00	-32.86	-19.86	L1
0.21	51.80	--	--	0.00	79.00	66.00	-27.20	-14.20	L1
3.92	44.66	--	--	0.00	73.00	60.00	-28.34	-15.34	L1
0.18	46.46	--	--	0.00	79.00	66.00	-32.54	-19.54	L2
0.21	47.54	--	--	0.00	79.00	66.00	-31.46	-18.46	L2
3.92	40.92	--	--	0.00	73.00	60.00	-32.08	-19.08	L2
6 Worst Data									

No non-compliance noted, as shown below.

4PAs Line 1 and 2

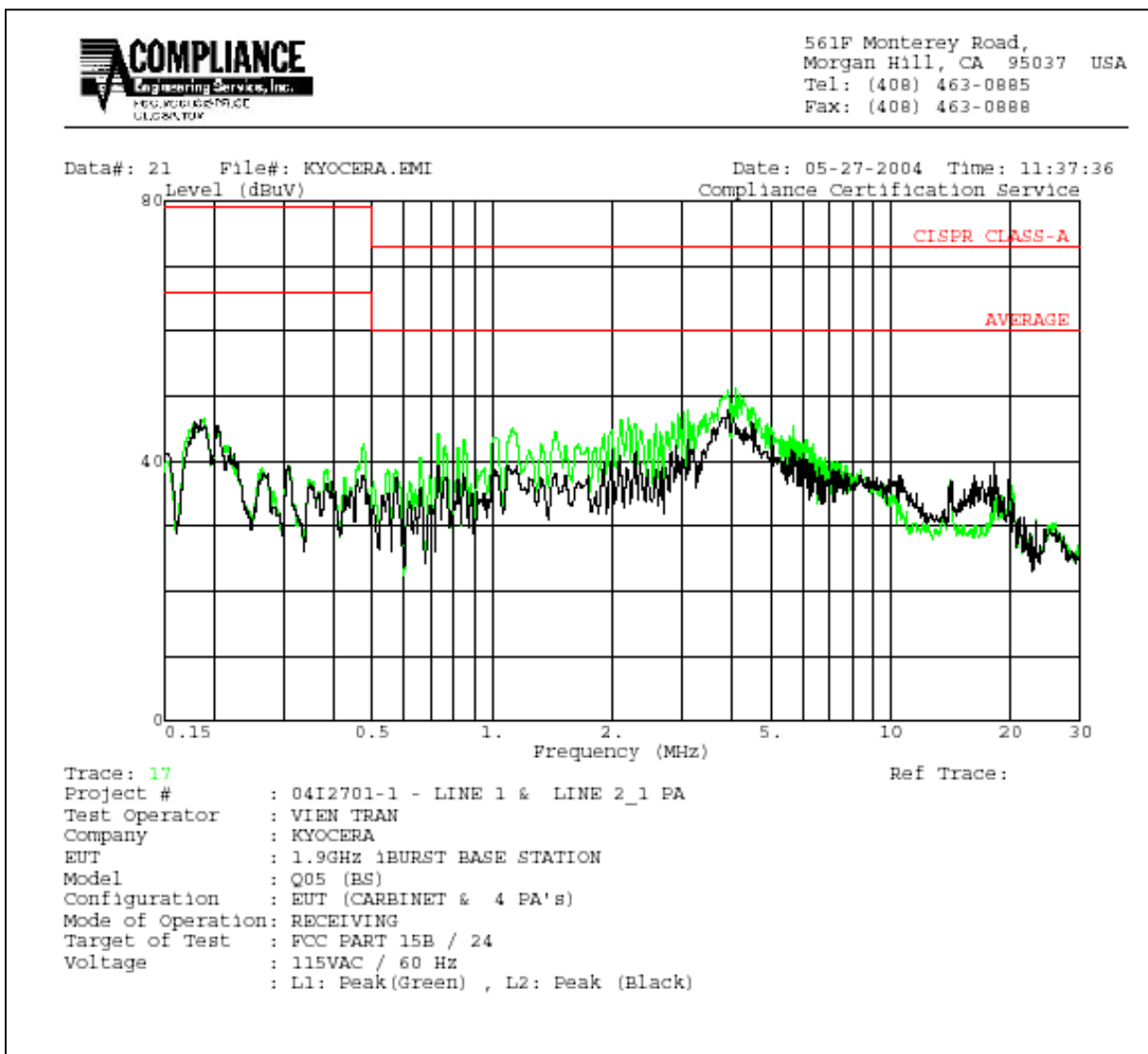

Cabinet and 4 PA Line 1 & 2

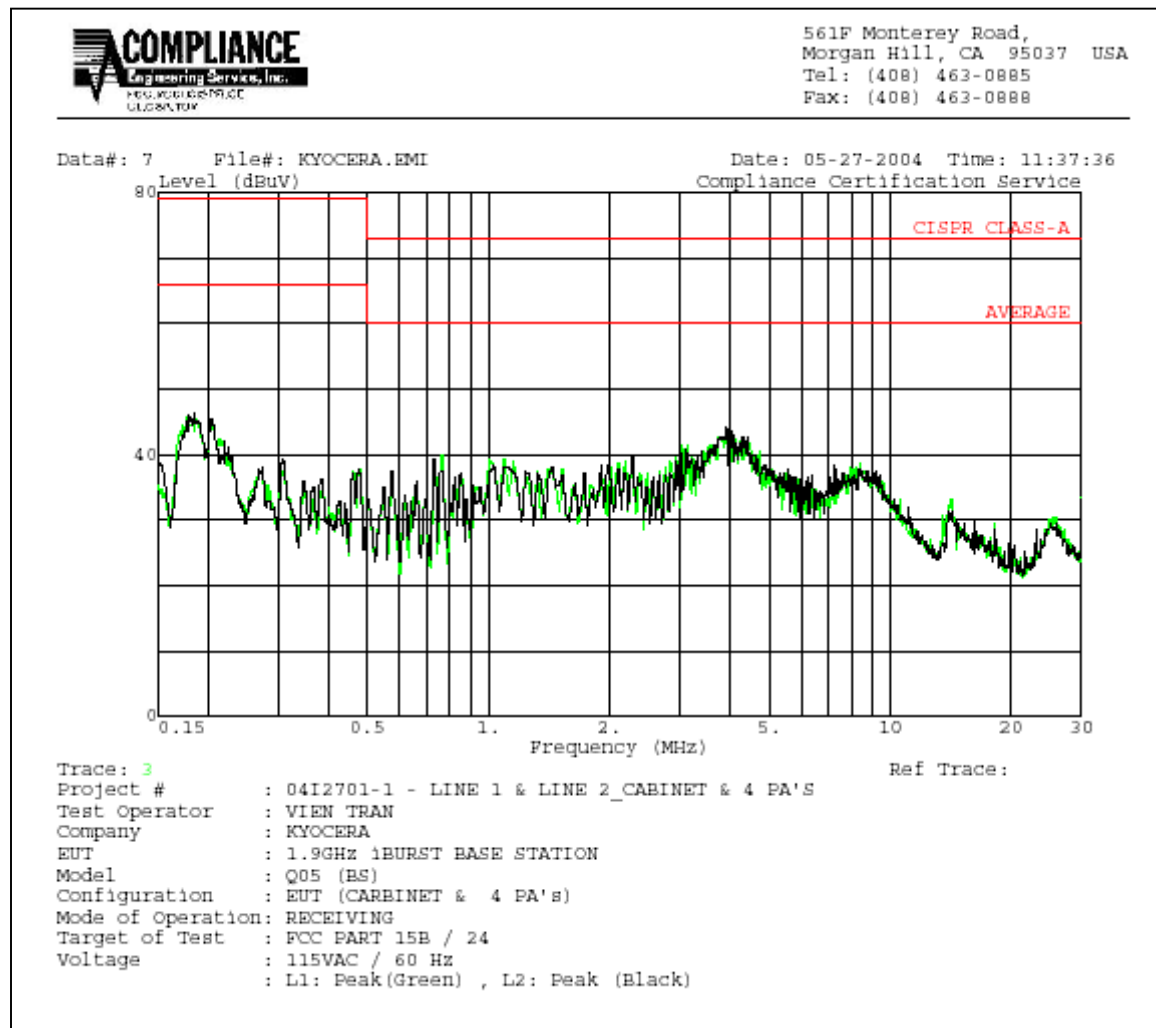

Cabinet Line 1 & 2

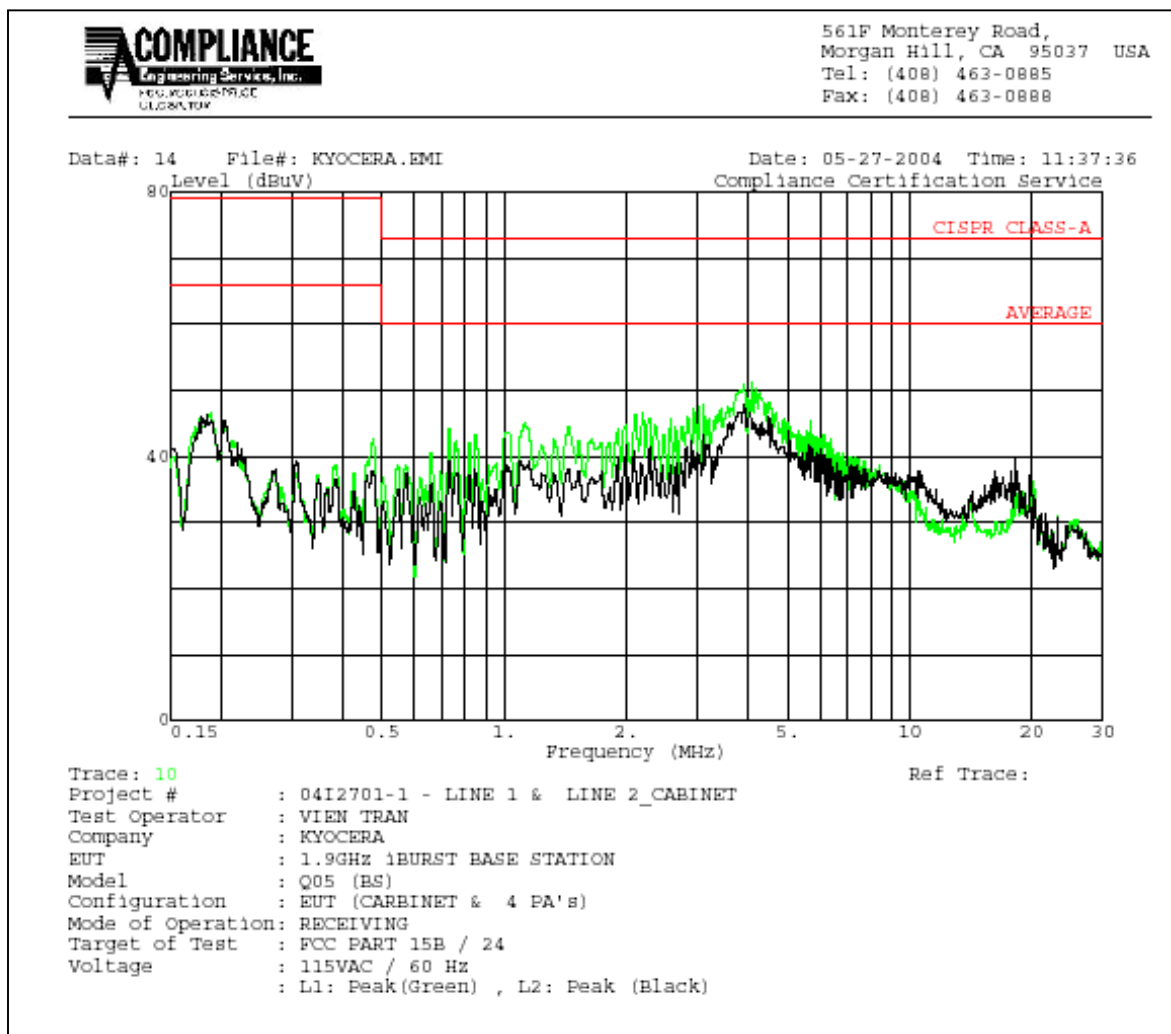

AC Conducted Emission photos



8. APENDIX

8.1. EXTERNAL & INTERNAL PHOTOS

Please refer to attached sheets.

8.2. SCHEMATICS

Please refer to attached sheets.

8.3. BLOCK DIAGRAM

Please refer to attached sheets.

8.4. USER MANUAL

Please refer to attached sheets.

END OF REPORT