



Zacta

TEST REPORT

Report number : Z101C-15133

Issue date : December 17, 2015

The device, as described herewith, was tested pursuant to applicable test procedure and complies with the requirements of;

FCC Part 24 Subpart E

The test results are traceable to the international or national standards.

Applicant	: KYOCERA Corporation
Equipment under test (EUT)	: Mobile Phone
Model number	: HMWH
FCC ID	: JOYHMWH

Date of test : October 28, November 2, 3, 10, December 14, 2015
 Test place : TÜV SÜD Zacta Ltd. Yonezawa Testing Center
 4149-7 Hachimanpara 5-chome
 Yonezawa-shi Yamagata 992-1128 Japan
 Phone: +81-238-28-2880 Fax: +81-238-28-2888
 Test results : Complied

The results in this report are applicable only to the equipment tested.
 This report shall not be re-produced except in full without the written approval of TÜV SÜD Zacta Ltd.
 This test report must not be used by the client to claim product certification, approval, or endorsement by NVLAP, NIST, or any agency of the federal government.

Tested by : Kazunori Saito Tadahiro Seino
 Kazunori Saito Tadahiro Seino

Hikaru Shibata Taiki Watanabe
 Hikaru Shibata Taiki Watanabe

Authorized by : Hiroaki Suzuki
 Hiroaki Suzuki
 Manager of EMC Technical Department



NVLAP LAB CODE 200306-0



Table of contents

	Page
1. Summary of Test	4
1.1 Purpose of test	4
1.2 Standards	4
1.3 List of applied test to the EUT	4
1.4 Modification to the EUT by laboratory	4
2. Equipment Under Test	5
2.1 General Description of equipment	5
2.2 EUT information	5
2.3 Variation of the family model(s)	6
2.4 Description of Test mode	6
3. Configuration of equipment	7
3.1 Equipment(s) used	7
3.2 System configuration	7
4. Conducted Output Power	8
4.1 Measurement procedure	8
4.2 Measurement result	8
5. Equivalent Isotropic Radiated Power	9
5.1 Measurement procedure	9
5.2 Calculation method	10
5.3 Limit	10
5.4 Test data	11
6. Peak to Average Ratio	12
6.1 Measurement procedure	12
6.2 Limit	12
6.3 Measurement result	13
6.4 Trace data	14
7. Occupied Bandwidth	15
7.1 Measurement procedure	15
7.2 Limit	15
7.3 Measurement result	15
7.4 Trace data	16
8. Band Edge Spurious and Harmonic at Antenna Terminals	17
8.1 Measurement procedure	17
8.2 Limit	17
8.3 Measurement result	18
8.4 Trace data	19
9. Radiated Emissions and Harmonic Emissions	23
9.1 Measurement procedure	23
9.2 Calculation method	23
9.3 Limit	23
9.4 Test data	24
10. Frequency Stability	25
10.1 Measurement procedure	25



Zacta

10.2 Limit.....	25
10.3 Measurement result.....	26
11. Uncertainty of measurement	27
12. Laboratory description	28
Appendix A. Test equipment	29

1. Summary of Test

1.1 Purpose of test

It is the original test in order to verify conformance to FCC Part 24 Subpart E.

1.2 Standards

CFR47 FCC Part 24 Subpart E

1.2.1 Test Methods

KDB 971168 D01 Power Meas License Digital Systems v02r02
ANSI/TIA/EIA-603-D-2010

1.2.2 Deviation from standards

None

1.3 List of applied test to the EUT

Test items Section	Test items	Condition	Result
2.1046	Conducted Output Power	Conducted	PASS
24.232(c)	Effective Radiated Power Equivalent Isotropic Radiated Power	Radiated	PASS
24.232(d)	Peak to Average Ratio	Conducted	PASS
24.238(a) 2.1049	Occupied Bandwidth	Conducted	PASS
24.238(a) 2.1051	Band Edge Spurious and Harmonic at Antenna Terminal	Conducted	PASS
24.238(a) 2.1053	Radiated emissions and Harmonic Emissions	Radiated	PASS
24.235 2.1055	Frequency Stability	Conducted	PASS

1.3.1 Test set up

Table-Top

1.4 Modification to the EUT by laboratory

None



Zacta

2. Equipment Under Test

2.1 General Description of equipment

EUT is the Mobile Phone.

2.2 EUT information

Applicant	:	KYOCERA Corporation Yokohama Office 2-1-1 Kagahara, Tsuzuki-ku Yokohama-shi, Kanagawa, Japan Phone: +81-45-943-6253 Fax: +81-45-943-6314
Equipment under test	:	Mobile Phone
Trade name	:	Kyocera
Model number	:	HMWH
Serial number	:	N/A
EUT condition	:	Pre-Production
Power ratings	:	Battery: DC 3.8V
Size	:	(W) 51 × (D) 18.2 × (H) 114 mm
Environment	:	Indoor and Outdoor use
Terminal limitation	:	-20°C to 60°C
RF Specification Frequency of Operation	:	Up Link GSM1900: 1850.2-1909.8MHz Down Link GSM1900: 1930.2-1989.8MHz
Modulation type	:	GSM1900: GMSK
Emission designator	:	GSM1900: 246KGXW
Output power	:	GSM1900: 0.948W (29.77dBm)
Antenna type	:	Internal antenna
Antenna gain	:	GSM1900: 2.1Bi

2.3 Variation of the family model(s)

Not applicable

2.4 Description of Test mode

The EUT had been tested under operating condition.
There are three channels have been tested as following:

Band	Channel	Frequency
GSM1900	512	1850.2MHz
	661	1880.0MHz
	810	1909.8MHz

The field strength of spurious emissions was measured at each position of all three axis X, Y and Z to compare the level, and the maximum noise.

The worst emission was found in X axis and the worst case recorded.



Zacta

3. Configuration of equipment

3.1 Equipment(s) used

No.	Equipment	Company	Model No.	Serial No.	FCC ID / DoC	Comment
1	Mobile Phone	KYOCERA	HMWH	N/A	JOYHMWH	EUT

3.2 System configuration

1. Mobile Phone
(EUT)

Note1: Numbers assigned to equipment or cables on this diagram correspond to the list in "3.1 Equipment(s) used".

4. Conducted Output Power

4.1 Measurement procedure [FCC 2.1046]

The conducted output power was measured with a wireless communication tester connected to the antenna terminal. The wireless communication tester parameters were set to produce the maximum power from the EUT.

- Test configuration

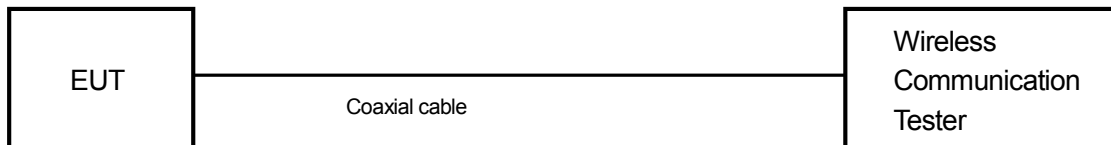

4.2 Measurement result

Date : October 28, 2015

Temperature : 24.9 [°C]

Humidity : 38.9 [%]

Test place : Shielded room No.4

Test engineer :

Tadahiro Seino

Band	Channel	Frequency [MHz]	Maximum Burst-Averaged Output Power [dBm]				
			Voice GSM CS 1slot	GPRS/EDGE(GMSK)Data			
				GPRS 1 TX Slot	GPRS 2 TX Slot	GPRS 3 TX Slot	GPRS 4 TX Slot
PCS 1900	512	1850.2	29.77	29.76	28.16	26.25	25.34
	661	1880.0	29.68	29.67	28.11	26.10	25.15
	810	1909.8	29.59	29.58	28.06	26.03	24.86

5. Equivalent Isotropic Radiated Power

5.1 Measurement procedure [FCC 24.232(c)]

<Step 1>

The EUT and support equipment are placed on a 1 meter x 1.5 meter surface, 0.8 meter height FRP table. Radiated emission measurements are performed at 3 meter distance with the broadband antenna (double ridged guide antenna). The antenna is positioned both the horizontal and vertical planes of polarization and height is varied 1 to 4 meters and stopped at height producing the maximum emission. The bandwidth of the spectrum analyzer is set to 1MHz. The turntable is rotated by 360 degrees and stopped at azimuth of producing the maximum emission.

<Step 2>

The substitution antenna is replaced by the transmitter antenna (EUT). The frequency of the signal generator is adjusted to the measurement frequency. Level of the signal generator is adjusted to the level that is obtained from step 1, and record the emission level of signal generator.

The spectrum analyzer is set to;

- a) Span = 1.5 times the OBW
- b) RBW = 1-5% of the expected OBW, not to exceed 1MHz
- c) VBW $\geq 3 \times$ RBW
- d) Number of sweep points $\geq 2 \times$ span / RBW
- e) Sweep time = auto-couple
- f) Detector = RMS (power averaging)
- g) If the EUT can be configured to transmit continuously (i.e., burst duty cycle $\geq 98\%$), then set the trigger to free run.
- h) If the EUT cannot be configured to transmit continuously (i.e., burst duty cycle $< 98\%$), then use a sweep trigger with the level set to enable triggering only on full power bursts and configure the EUT to transmit at full power for the entire duration of each sweep. Ensure that the sweep time is less than or equal to the transmission burst duration.
- i) Trace average at least 100 traces in power averaging (i.e., RMS) mode.
- j) Compute the power by integrating the spectrum across the OBW of the signal using the instrument's band power measurement function, with the band limits set equal to the OBW band edges. If the instrument does not have a band power function, then sum the spectrum levels (in linear power units) at intervals equal to the RBW extending across the entire OBW of the spectrum.

- Test configuration

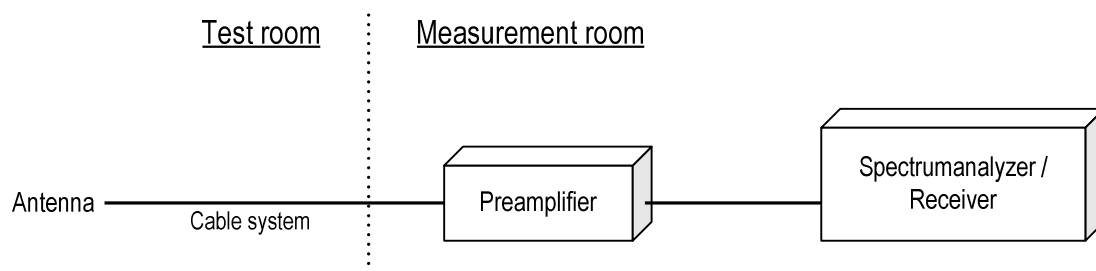



Zacta

5.2 Calculation method

Result (EIRP) = S.G Reading – Cable loss + Antenna Gain
Margin = Limit – Result (EIRP)

5.3 Limit

2 W (33dBm)

5.4 Test data

Date : November 10, 2015
 Temperature : 20.1 [°C]
 Humidity : 46.5 [%]
 Test place : 3m Semi-anechoic chamber

Test engineer : Kazunori Saito

Date : December 14, 2015
 Temperature : 21.9 [°C]
 Humidity : 29.1 [%]
 Test place : 3m Semi-anechoic chamber

Test engineer : Taiki Watanabe

[GSM1900]**

H/V	Frequency [MHz]	S.A Reading [dBm]	S.G Reading [dBm]	Cable loss [dB]	Ant.Gain [dBi]	Result [dBm]	Limit [dBm]	Margin [dB]
H	1850.2	-23.3	21.7	1.1	8.2	28.7	33.0	4.3
H	1880.0	-23.4	21.3	1.1	8.3	28.4	33.0	4.6
H	1909.8	-22.2	23.9	1.1	8.4	31.2	33.0	1.8

6. Peak to Average Ratio

6.1 Measurement procedure [FCC 24.232(d)]

The peak to average ratio was measured with a spectrum analyzer connected to the antenna terminal.

The spectrum analyzer is set to;

Trace A

- Span ≥ 1.5 times the OBW.
- RBW = 1 MHz.
- VBW $\geq 3 \times$ RBW.
- Number of points in sweep $\geq 2 \times$ span / RBW.
- Detector = peak.
- Sweep time = auto-couple.
- Trace mode = max hold.

Trace B

- Span ≥ 1.5 times the OBW.
- RBW = 1 MHz.
- VBW $\geq 3 \times$ RBW.
- Number of points in sweep $\geq 2 \times$ span / RBW.
- Detector = RMS (power averaging).
- Sweep time = auto-couple.
- Employ trace averaging (RMS) mode over a minimum of 100 traces.

- Test configuration

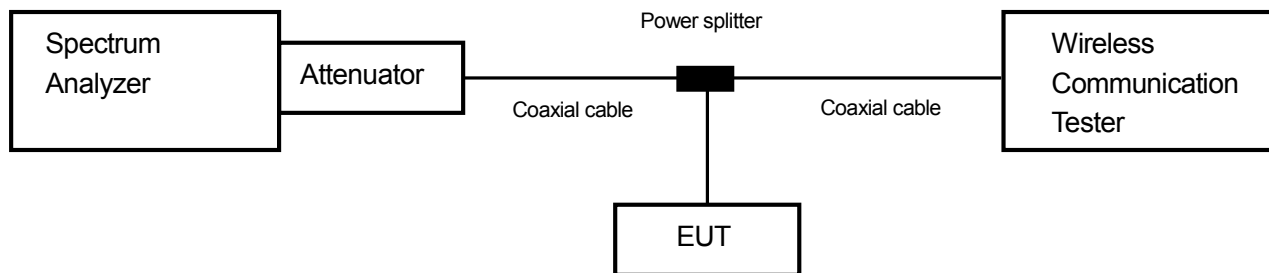

6.2 Limit

13dB or less

6.3 Measurement result

Date : November 2, 2015
 Temperature : 23.2 [°C]
 Humidity : 48.1 [%]
 Test place : Shielded room No.4

Test engineer :

Kazunoro Saito

Mode	Channel	Frequency [MHz]	Peak to Average Power Ratio [dB]	Limit [dB]
GSM1900	512	1850.2	0.04	13.0
	661	1880.0	0.02	
	810	1909.8	0.04	

6.4 Trace data
[GSM1900]

Channel: 512

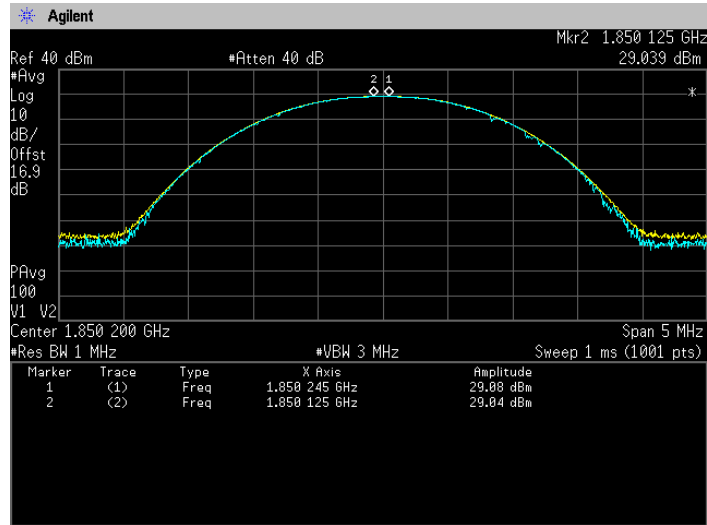

Channel: 661

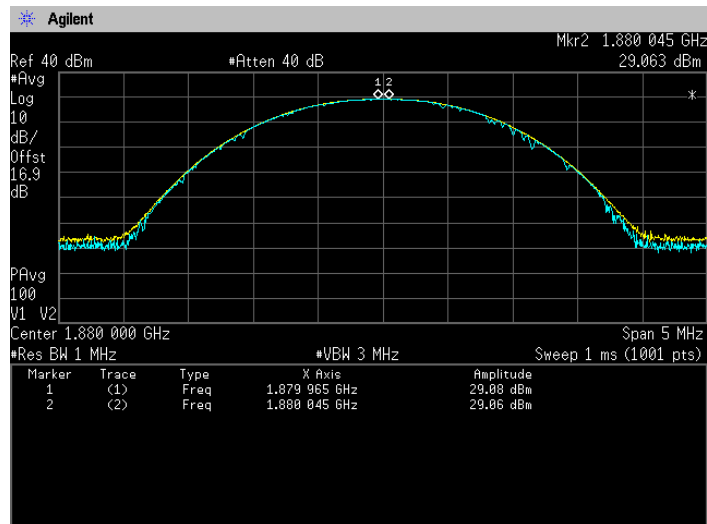

Channel: 810

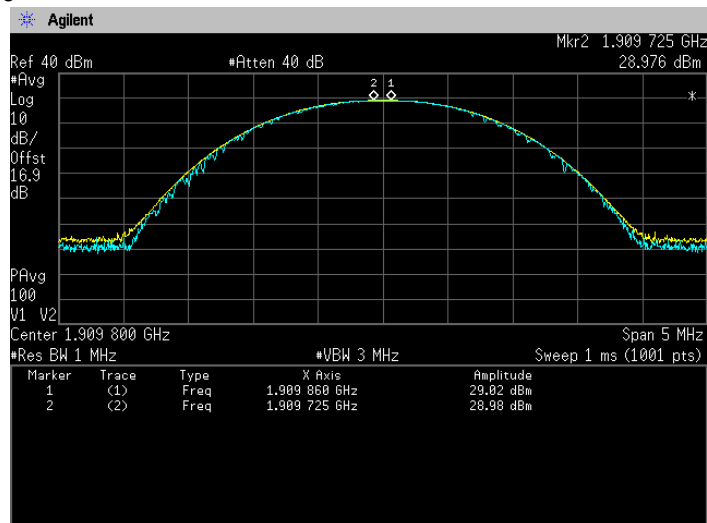

7. Occupied Bandwidth

7.1 Measurement procedure [FCC 24.238(a), 2.1049]

The Occupied bandwidth was measured with a spectrum analyzer connected to the antenna terminal.

The spectrum analyzer is set to;

- a) Span = 2-5 times the OBW.
- b) RBW = 1-5% of the expected OBW.
- c) VBW $\geq 3 \times$ RBW.
- d) Detector = peak.
- e) Sweep time = auto-couple.
- f) Trace mode = max hold.

- Test configuration

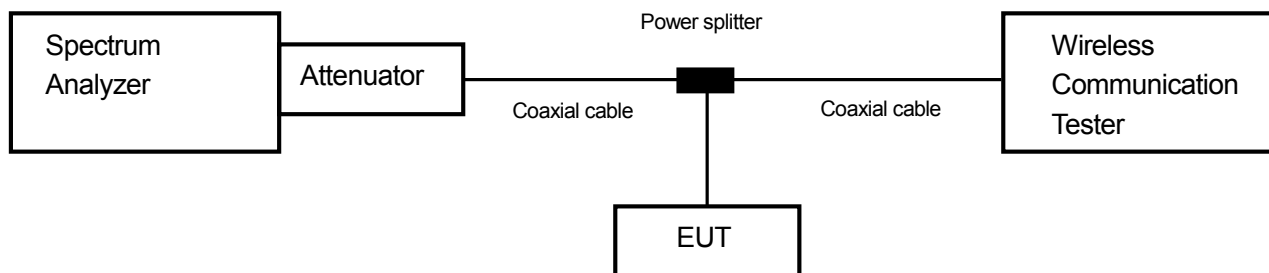

7.2 Limit

None

7.3 Measurement result

Date : November 2, 2015
 Temperature : 23.2 [°C]
 Humidity : 48.1 [%]
 Test place : Shielded room No.4

Test engineer :

Kazunoro Saito

Band	Channel	Frequency (MHz)	Test Result (kHz)
GSM1900	512	1850.2	244.4054
	661	1880.0	244.6162
	810	1909.8	245.8990

7.4 Trace data
[GSM1900]

Channel: 512

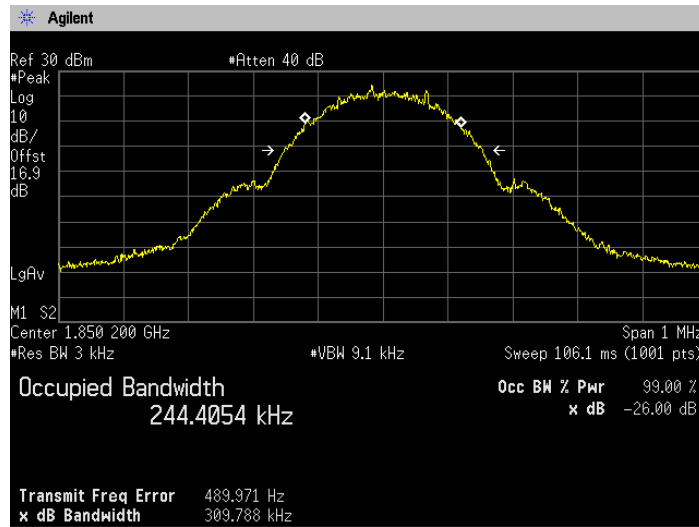

Channel: 661

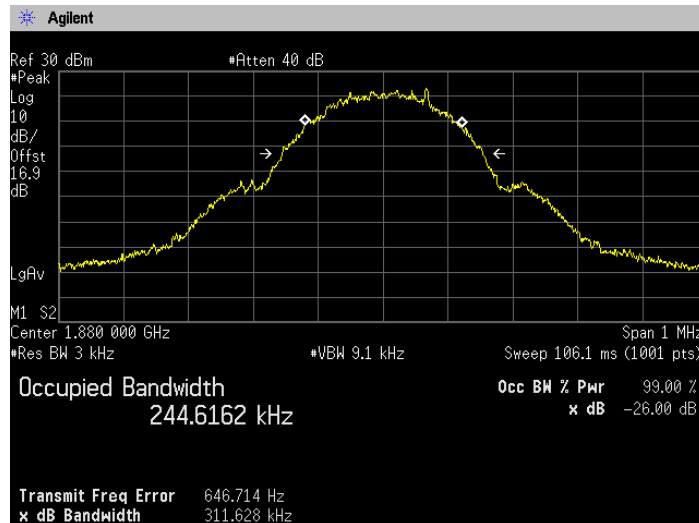

Channel: 810

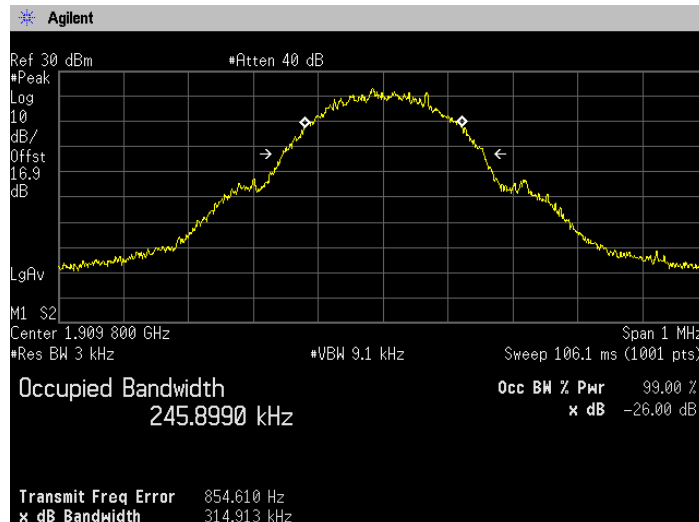

8. Band Edge Spurious and Harmonic at Antenna Terminals

8.1 Measurement procedure [FCC 24.238(a), 2.1051]

The band edge spurious and harmonic was measured with a spectrum analyzer connected to the antenna terminal.

The spectrum analyzer is set to;
<Band Edge>

- a) Span was set large enough so as to capture all out of band emissions near the band edge
- b) RBW \geq 1% of the expected OBW.
- c) VBW \geq 3 x RBW
- d) Number of sweep point \geq span / RBW
- e) Detector = RMS (power averaging).
- f) Sweep time = auto-couple.
- g) Employ trace averaging (RMS) mode over a minimum of 100 traces.
- h) Offset = Cable loss.

<Spurious Emissions>

- a) RBW=1MHz
- b) VBW \geq 3 x RBW.
- c) Number of points in sweep \geq span / RBW.
- d) Detector = peak.
- e) Sweep time = auto-couple.
- f) Trace mode = max hold.

- Test configuration

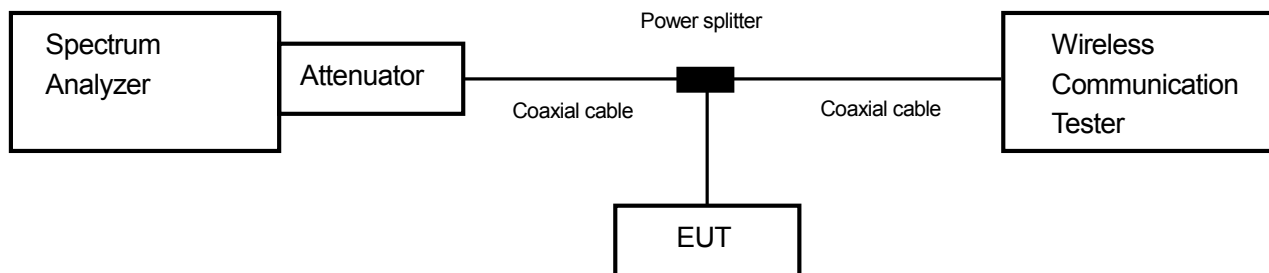

8.2 Limit

-13dBm or less

8.3 Measurement result

Date : November 2, 2015
Temperature : 23.2 [°C]
Humidity : 48.1 [%]
Test place : Shielded room No.4

Test engineer :

Kazunori Saito

Band	Channel	Frequency [MHz]	Limit [dB]	Results	Results
GSM1900	512	1850.2	-13.0	See the trace data	PASS
	810	1909.8	-13.0	See the trace data	PASS



Zacta

**8.4 Trace data
[GSM1900]
(Band Edge)**

Channel: 512

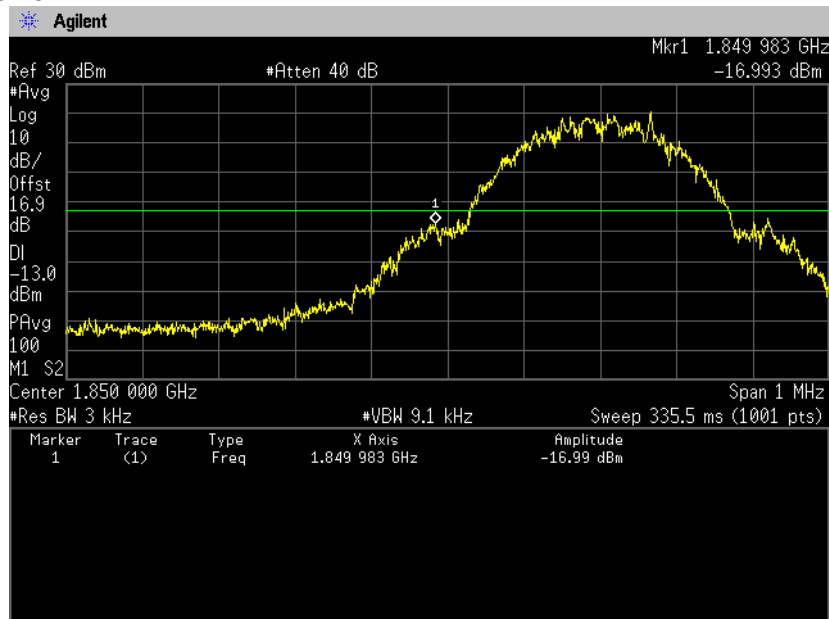

Channel: 810

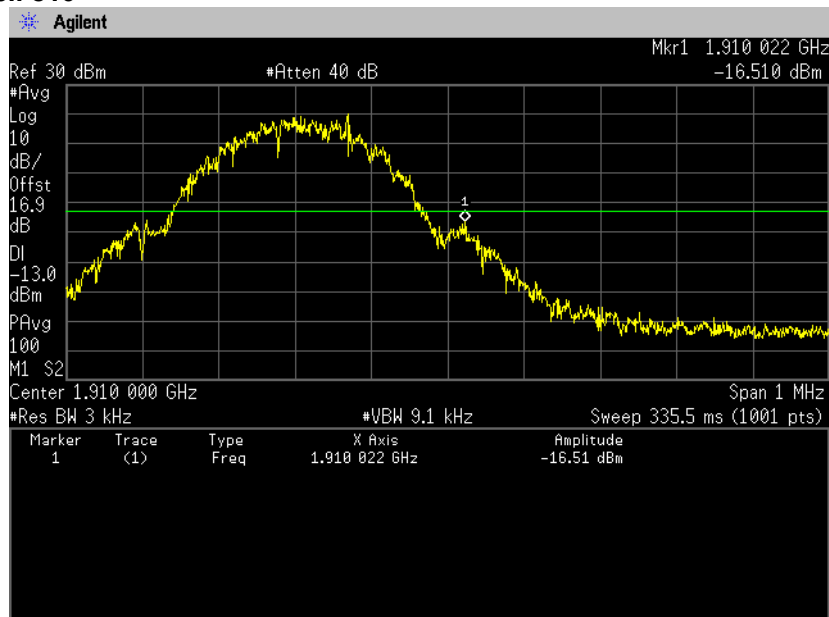



Zacta

(Spurious Emissions)

Note: Conducted spurious test was measured in the worst case of conducted output power.

**Channel: 512
30MHz-5GHz**

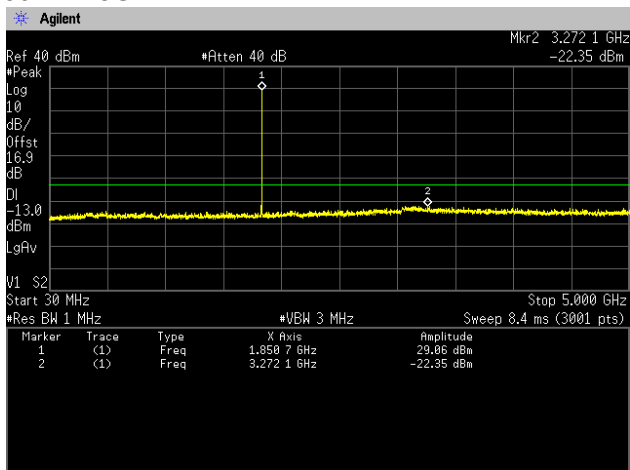

5GHz-10GHz

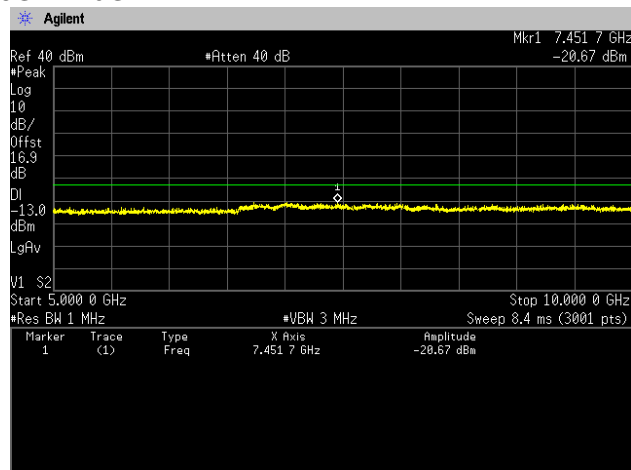

10GHz-15GHz

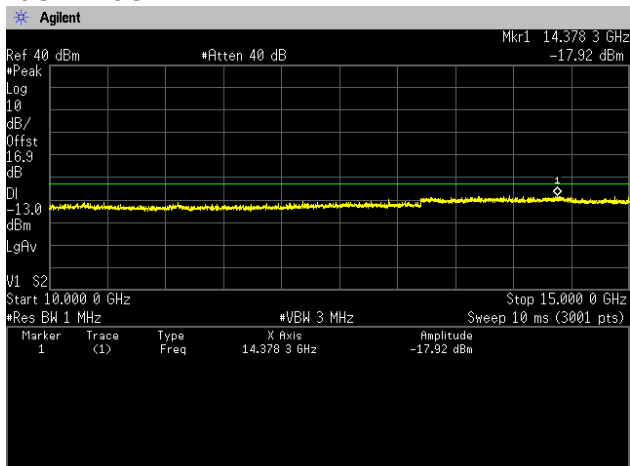

15GHz-20GHz

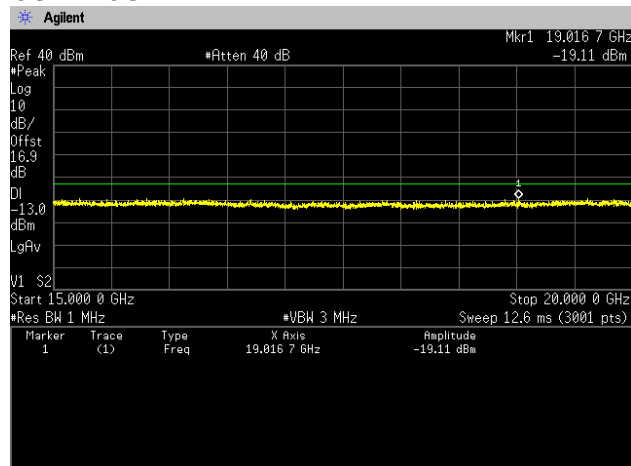



Zacta

**Channel: 661
30MHz-5GHz**

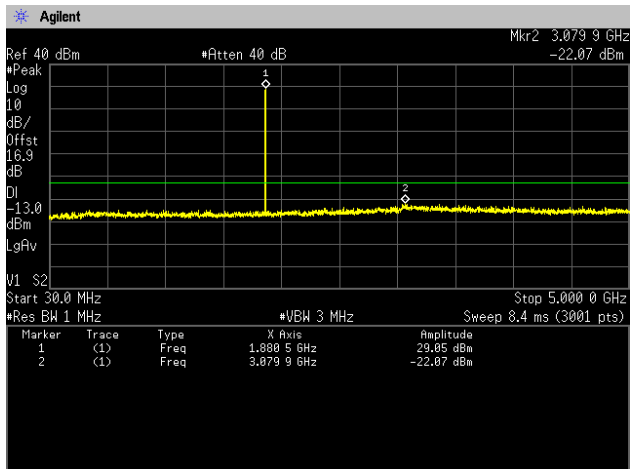

5GHz-10GHz

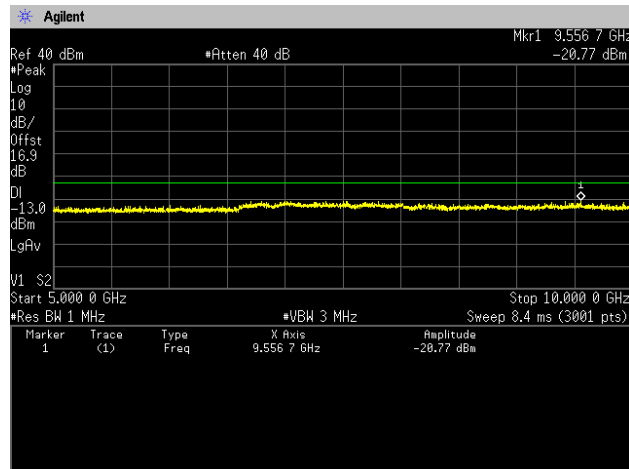

10GHz-15GHz

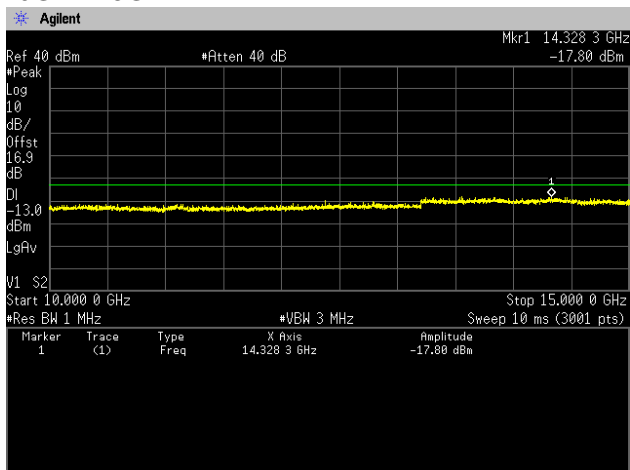

15GHz-20GHz

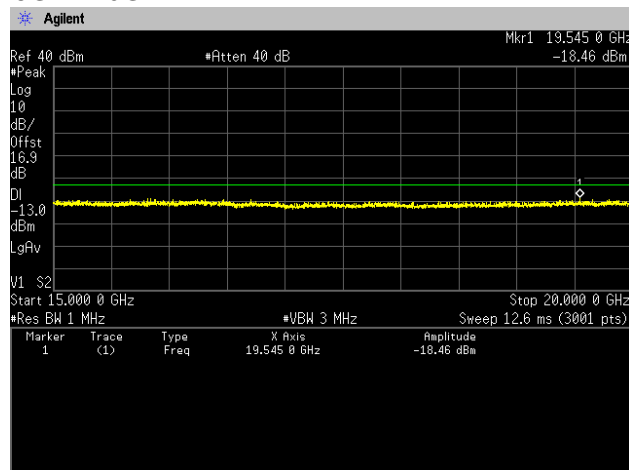



Zacta

Channel: 810
30MHz-5GHz

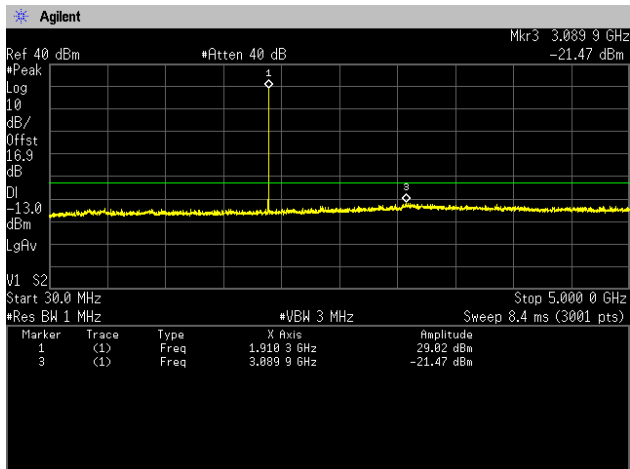

5GHz-10GHz

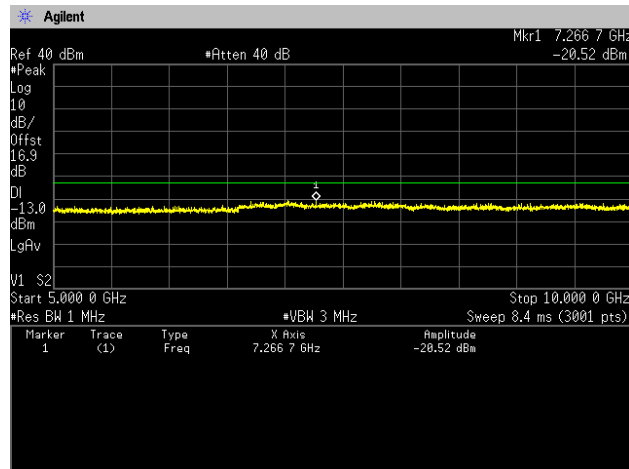

10GHz-15GHz

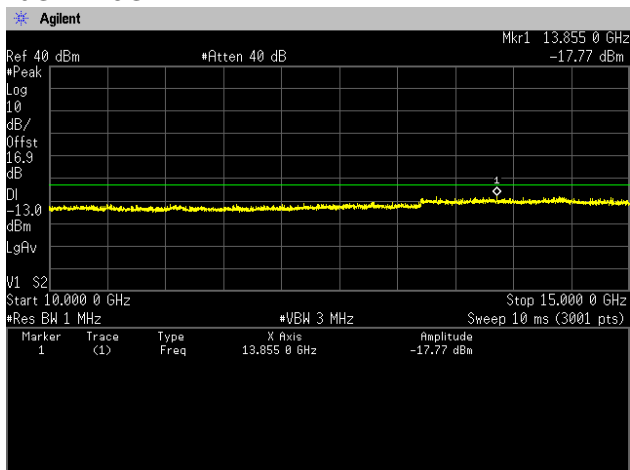

15GHz-20GHz

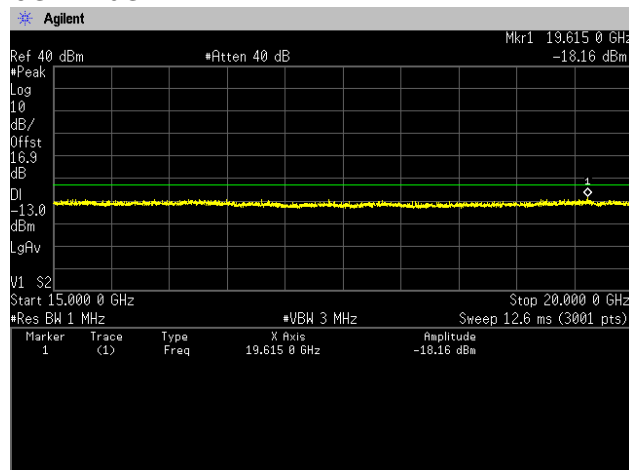

9. Radiated Emissions and Harmonic Emissions

9.1 Measurement procedure [FCC 24.238(a), 2.1053]

<Step 1>

The EUT and support equipment are placed on a 1 meter x 1.5 meter surface, 0.8 meter height FRP table. Radiated emission measurements are performed at 3 meter distance with the broadband antenna (Biconical antenna, Log periodic antenna and double ridged guide antenna). The antenna is positioned both the horizontal and vertical planes of polarization and height is varied 1 to 4 meters and stopped at height producing the maximum emission.

The bandwidth of the spectrum analyzer is set to 1MHz. The turntable is rotated by 360 degrees and stopped at azimuth of producing the maximum emission. The frequency is investigated up to 20GHz.

<Step 2>

The substitution antenna is replaced by the transmitter antenna (EUT).

The frequency of the signal generator is adjusted to the measurement frequency.

Level of the signal generator is adjusted to the level that is obtained from step 1, and record the emission level of signal generator.

The spectrum analyzer is set to;

- RBW = 100kHz for below 1GHz and 1MHz for above 1GHz / VBW $\geq 3 \times$ RBW
- Detector = Peak
- Trace mode = Max hold
- Sweep time = auto-couple

- Test configuration

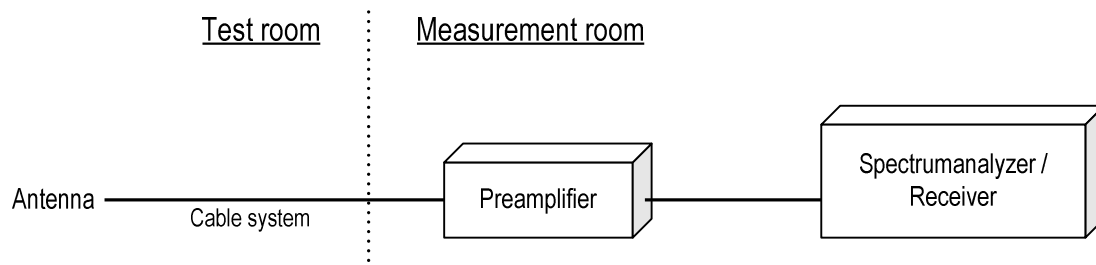

9.2 Calculation method

Result = S.G Reading – Cable loss + Antenna Gain

Margin = Limit – Result (EIRP)

9.3 Limit

-13dBm or less



Zacta

9.4 Test data

Date : November 10, 2015
 Temperature : 20.1 [°C]
 Humidity : 46.3 [%]
 Test place : 3m Semi-anechoic chamber
 Test engineer : Kazunori Saito

Date : December 14, 2015
 Temperature : 21.9 [°C]
 Humidity : 29.1 [%]
 Test place : 3m Semi-anechoic chamber
 Test engineer : Taiki Watanabe

[GSM1900] (Channel: 512)

H/V	Frequency [MHz]	S.A Reading [dBm]	S.G Reading [dBm]	Cable loss [dB]	Ant.Gain [dBi]	Result [dBm]	Limit [dBm]	Margin [dB]
H	3700.4	-54.2	-51.1	1.6	9.5	-43.2	-13.0	30.2
V	3700.4	-53.7	-48.5	1.6	9.5	-40.6	-13.0	27.6
H	5551.0	-53.4	-46.0	2.0	11.0	-37.0	-13.0	24.0
V	5551.0	-54.4	-43.2	2.0	8.8	-36.4	-13.0	23.4

(Channel: 661)

H/V	Frequency [MHz]	S.A Reading [dBm]	S.G Reading [dBm]	Cable loss [dB]	Ant.Gain [dBi]	Result [dBm]	Limit [dBm]	Margin [dB]
H	3760.0	-53.3	-49.3	1.6	9.2	-41.7	-13.0	28.7
V	3760.0	-52.6	-45.9	1.6	9.2	-38.3	-13.0	25.3

(Channel: 810)

H/V	Frequency [MHz]	S.A Reading [dBm]	S.G Reading [dBm]	Cable loss [dB]	Ant.Gain [dBi]	Result [dBm]	Limit [dBm]	Margin [dB]
H	3819.3	-63.9	-61.0	1.6	9.3	-53.3	-13.0	40.3
V	3819.3	-63.0	-55.0	1.6	9.3	-47.3	-13.0	34.3

10. Frequency Stability

10.1 Measurement procedure [FCC 24.235, 2.1055]

The EUT was placed inside of a constant temperature chamber as the temperature in the chamber was varied between -30°C and $+50^{\circ}\text{C}$. The temperature was incremented by 10°C intervals and the unit was allowed to stabilize at each measurement. The frequency drift was measured with the normal Temperature and voltage tolerance and it is presented as the ppm unit.

- Test configuration

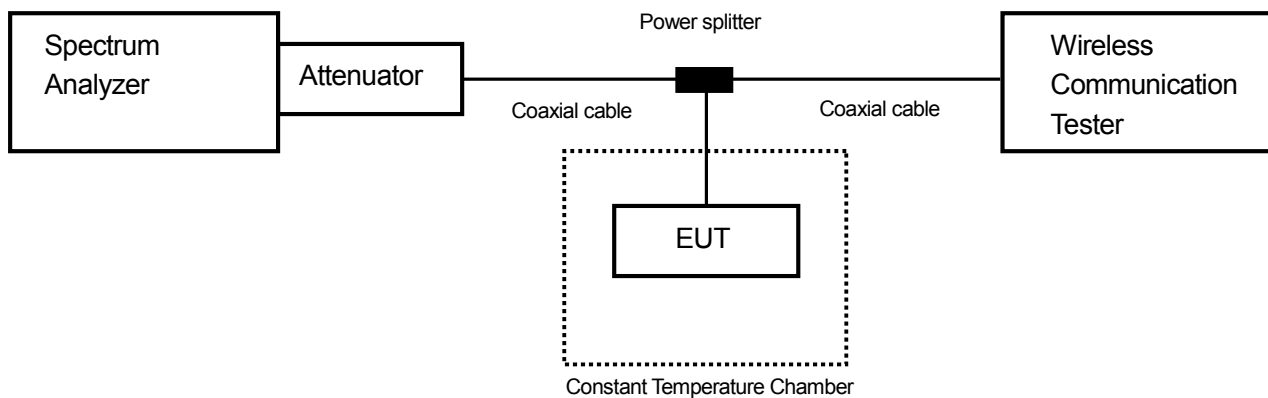

10.2 Limit

$\pm 2.5\text{ppm}$



Zacta

10.3 Measurement result

Date : November 3, 2015
 Temperature : 23.6 [°C]
 Humidity : 48.6 [%]
 Test place : Shielded room No.4

Test engineer :

Kazunori Saito

[GSM1900]

(Channel: 661)

Limit: ±0.00025% = ±2.5ppm					
Power Supply	Temperature	Measurements Frequency	Frequency Tolerance	Limit	Result
[V]	[°C]	[Hz]	[ppm]	[ppm]	
3.80	25(Ref.)	1,880,000,029	0.00000	±2.5	Pass
	50	1,880,000,018	-0.00582	±2.5	Pass
	40	1,880,000,030	0.00028	±2.5	Pass
	30	1,880,000,029	-0.00021	±2.5	Pass
	20	1,880,000,029	0.00005	±2.5	Pass
	10	1,880,000,033	0.00182	±2.5	Pass
	0	1,880,000,035	0.00328	±2.5	Pass
	-10	1,880,000,024	-0.00256	±2.5	Pass
	-20	1,880,000,026	-0.00187	±2.5	Pass
-30	1,880,000,040	0.00560	±2.5	Pass	
3.230	25	1,880,000,036	0.00347	±2.5	Pass
4.370	25	1,880,000,024	-0.00284	±2.5	Pass

Calculation;

Frequency Tolerance (ppm) = Measurements Frequency (Hz) – Reference Frequency (Hz) / Reference Frequency (Hz) x 1000000

11. Uncertainty of measurement

Expanded uncertainties stated are calculated with a coverage Factor $k=2$.

Please note that these results are not taken into account when determining compliance or non-compliance with test result.

Test item	Measurement uncertainty
Conducted emission at mains port	$\pm 3.0\text{dB}$
Radiated emission (9kHz – 30MHz)	$\pm 4.4\text{dB}$
Radiated emission (30MHz – 1000MHz)	$\pm 4.5\text{dB}$
Radiated emission (1000MHz – 26GHz)	$\pm 3.9\text{dB}$



Zacta

12. Laboratory description

1. Location:

TÜV SÜD Zacta Ltd. Yonezawa Testing Center
 4149-7 Hachimanpara 5-chome Yonezawa-shi Yamagata 992-1128 Japan
 Phone: +81-238-28-2880 Fax: +81-238-28-2888

2. Facility filing information:

1) NVLAP accreditation: NVLAP Lab. code: 200306-0

2) VLAC accreditation: Lab. code: VLAC-013

Site name	Radiated emission	Conducted emission for mains port	Conducted emission for telecom port	Radiated emission (CMAD)	Expiry Date
3m Semi-anechoic chamber	VLAC-013	VLAC-013	VLAC-013	-	Jul. 3, 2017
10m Semi-anechoic chamber No.1				VLAC-013	
10m Semi-anechoic chamber No.2				VLAC-013	
Shielded room No.1	-	VLAC-013	-	-	

3) FCC filing:

Site name	Registration Number	Expiry Date
Site 3	91065	Oct. 1, 2017
3m Semi-anechoic chamber	540072	Feb. 20, 2017
10m Semi-anechoic chamber No.1		
10m Semi-anechoic chamber No.2		
Shielded room No.1		

4) Industry Canada Oats site filing:

Site name	Sites on file: Oats 3m/10m	Expiry Date
Site 3	4224A-3	Dec. 3, 2017
3m Semi-anechoic chamber	4224A-4	
10m Semi-anechoic chamber No.1	4224A-5	
10m Semi-anechoic chamber No.2	4224A-6	Jan. 15, 2017

5) VCCI site filing:

Site name	Radiated emission	Conducted emission for mains port	Conducted emission for telecom port	Expiry Date
Site 3	R-138	C-134	T-1222	Nov. 16, 2017
3m Semi-anechoic chamber	A-0166	A-0166	A-0166	Jul. 3, 2017
10m Semi-anechoic chamber No.1				
10m Semi-anechoic chamber No.2				
Shielded room No.1	-	A-0166		

6) TÜV SÜD PS authorization:

Authorized as an EMC test laboratory

7) TÜV Rheinland authorization:

Authorized as an EMC test laboratory

Appendix A. Test equipment

Antenna port conducted test

Equipment	Company	Model No.	Serial No.	Cal. due	Cal. date
Spectrum analyzer	Agilent Technologies	E4440A	US44302655	Jun. 30, 2016	Jun. 11, 2015
Microwave cable	RS	YH_13S5	N/A (S403)	May 31, 2016	May 10, 2015
Attenuator	Weinschel	56-10	J4993	Nov. 30, 2016	Nov. 12, 2015
Microwave cable	SUHNER	SUCOFLEX104/1.5m	199121/4	Oct. 31, 2016	Oct. 30, 2015
Microwave cable	SUHNER	SUCOFLEX104/1.5m	322086/4	May 31, 2016	May 29, 2015
Power splitter	ANRITSU	K240B	020205	Jul. 31, 2016	Jul. 12, 2015
Power meter	ROHDE&SCHWARZ	NRP2	103269	Jun. 20, 2016	Jun. 25, 2015
Power sensor	ROHDE&SCHWARZ	NRP-Z81	102467	Jun. 20, 2016	Jun. 25, 2015
Wideband radio frequency tester	ROHDE&SCHWARZ	CMW500	116338	Apr. 30, 2016	Apr. 2, 2015
Operation type temperature controlled bath	Espec	PL1KP	14007261	Jan. 31, 2016	Jan. 9, 2015

Radiated emission

Equipment	Company	Model No.	Serial No.	Cal. Due	Cal. Date
EMI Receiver	ROHDE&SCHWARZ	ESCI	100764	Aug. 31, 2016	Aug. 21, 2015
Preamplifier	ANRITSU	MH648A	M96057	Jun. 30, 2016	Jun. 30, 2015
Biconical antenna	Schwarzbeck	VHA9103/BBA9106	2125	Jun. 30, 2016	Jun. 4, 2015
Log periodic antenna	Schwarzbeck	UHALP9108A	0560	Jun. 30, 2016	Jun. 4, 2015
Attenuator	TME	CFA-01NPJ-6	N/A (S275)	Jun. 30, 2016	Jun. 23, 2015
Attenuator	TME	CFA-01NPJ-3	N/A (S272)	Jun. 30, 2016	Jun. 23, 2015
Spectrum analyzer	Agilent Technologies	E4440A	US40420937	Jul. 31, 2016	Jul. 23, 2015
Preamplifier	Agilent Technologies	8449B	3008A1008	Dec. 31, 2015	Dec. 5, 2014
Dipole antenna	Schwarzbeck	VHAP	1021	Oct. 31, 2016	Oct. 2, 2015
Dipole antenna	Schwarzbeck	UHAP	993	Oct. 31, 2016	Oct. 2, 2015
Double ridged guide antenna	EMCO	3115	5205	Feb. 29, 2016	Feb. 16, 2015
Attenuator	Agilent Technologies	8491B	MY39268633	Feb. 29, 2016	Feb. 1, 2015
Double ridged guide antenna	EMCO	3115	4328	Mar. 31, 2016	Mar. 4, 2015
Signal generator	ROHDE&SCHWARZ	SMB100A	177525	Jun. 30, 2016	Jun. 19, 2015
Power amplifier	R&K	CGA020M602-2633R	B40240	Mar. 31, 2016	Mar. 23, 2015
Microwave cable	SUHNER	SUCOFELX102/2m	31648/2	Mar. 31, 2016	Mar. 10, 2015
High pass filter	Micro-Tronics	HPM50115	004	Jul. 31, 2016	Jul. 12, 2015
High pass filter	Wainwright	WHKX2.8/18G-6SS	1	Jul. 31, 2016	Jul. 29, 2015
Wideband radio frequency tester	ROHDE&SCHWARZ	CMW500	126079	Sep. 30, 2016	Sep. 15, 2015
Microwave cable	SUHNER	SUCOFLEX104/9m	346316/4	Oct. 31, 2016	Oct. 23, 2015
		SUCOFLEX104/1m	322084/4	Oct. 31, 2016	Oct. 23, 2015
		SUCOFLEX104/1.5m	317226/4	Oct. 31, 2016	Oct. 23, 2015
		SUCOFLEX104/7m	41625/6	Oct. 31, 2016	Oct. 23, 2015
PC	DELL	DIMENSION E521	75465BX	N/A	N/A
Software	TOYO Corporation	EP5/RE-AJ	0611193/V5.3.61	N/A	N/A
3m Semi-anechoic chamber	TOKIN	N/A	N/A (9002-NSA)	Apr. 30, 2016	Apr. 27, 2015
3m Semi-anechoic chamber	TOKIN	N/A	N/A (9002-SVSWR)	Apr. 30, 2016	Apr. 27, 2015

*: The calibrations of the above equipment are traceable to NIST or equivalent standards of the reference organizations.