

## Report on the EMC Testing of:

KYOCERA Corporation  
Mobile Phone, Model: EB1157

## In accordance with FCC Part 15 Subpart B Class B

Prepared for: KYOCERA Corporation  
Yokohama Office 2-1-1 Kagahara, Tsuzuki-ku,  
Yokohama-shi, Kanagawa, 224-8502 Japan  
Phone: +81-45-943-6253 Fax: +81-45-943-6314



Japan

Add value.  
Inspire trust.

## COMMERCIAL-IN-CONFIDENCE

Document Number: JPD-TR-23067-0

### SIGNATURE

*Hiroaki Suzuki*

NAME	JOB TITLE	RESPONSIBLE FOR	ISSUE DATE
Hiroaki Suzuki	Deputy Manager of RF Group	Approved Signatory	2023.08.17

Signatures in this approval box have checked this document in line with the requirements of TÜV SÜD Japan Ltd. document control rules.

### EXECUTIVE SUMMARY – Result: Complied

A sample of this product was tested and the result above was confirmed in accordance with FCC Part 15 Subpart B (Applied only the test items mentioned in section 1.5 and excluded the deviations mentioned in section 1.4 of this document.)



### DISCLAIMER AND COPYRIGHT

The results in this report are applicable only to the equipment tested.  
This report shall not be re-produced except in full without the written approval of TÜV SÜD Japan Ltd.  
Client provided data, for which TÜV SÜD Japan Ltd. takes no responsibility, which can affect validity of results within this report is clearly identified.

### ACCREDITATION

This test report must not be used by the client to claim product certification, approval, or endorsement by A2LA or any agency of the federal government.

TÜV SÜD Japan Ltd.  
Yonezawa Testing Center  
5-4149-7 Hachimanpara,  
Yonezawa-shi, Yamagata,  
992-1128 Japan

Phone: +81 (0) 238 28 2881  
www.tuvsud.com/ja-jp

**Additional signatures required by FCC 47 CFR Part 2, § 2.938 (b) (10)****Signatures of the individuals responsible for testing the product****ENGINEERING STATEMENT**

The measurements shown in this report were made in accordance with the procedures described on test pages. All reported testing was carried out on a sample equipment to demonstrate limited compliance with FCC Part 15 Subpart B. The sample tested was found Complied compliant with the requirements defined in the applied rules.

NAME	RESPONSIBLE FOR	SIGNATURE
Akihiro Goto	Testing	<i>Akihiro Goto</i>
Yoshiyuki Takahashi	Testing	<i>Yoshiyuki Takahashi</i>
Nobuhiko Iwasawa	Testing	<i>Nobuhiko Iwasawa</i>



## Contents

<b>1</b>	<b>Summary of Test .....</b>	<b>4</b>
1.1	Modification history of the test report .....	4
1.2	Standards .....	4
1.3	Measurement standards .....	4
1.4	Deviation from standards .....	4
1.5	List of applied test(s) of the EUT .....	4
1.6	Test information.....	4
1.7	Test set up.....	5
1.8	Test period .....	5
<b>2</b>	<b>Equipment Under Test.....</b>	<b>6</b>
2.1	EUT information .....	6
2.2	Modification to the EUT .....	6
2.3	Variation of family model(s).....	7
2.4	Operation mode.....	7
<b>3</b>	<b>Configuration of Equipment.....</b>	<b>8</b>
3.1	Equipment used .....	8
3.2	Cable(s) used .....	8
3.3	System configuration.....	9
<b>4</b>	<b>Test Result .....</b>	<b>10</b>
4.1	Conducted emission at mains port.....	10
4.2	Radiated emission (below 1 GHz).....	12
4.3	Radiated emission (above 1 GHz) .....	21
<b>5</b>	<b>Measurement Uncertainty .....</b>	<b>31</b>
<b>6</b>	<b>Laboratory Information.....</b>	<b>32</b>
	<b>Appendix A. Test Equipment.....</b>	<b>33</b>

## 1 Summary of Test

### 1.1 Modification history of the test report

Document Number	Modification History	Issue Date
JPD-TR-23067-0	First Issue	Refer to the cover page

### 1.2 Standards

FCC Part 15 Subpart B

### 1.3 Measurement standards

ANSI C63.4 2014

### 1.4 Deviation from standards

None

### 1.5 List of applied test(s) of the EUT

Regarding judgment of conformance to Emission test, a value of measurement uncertainty was not taken in account.

Test Name	Classification of EUT	Test	Worst Point (Margin)	Result	Remarks
Conducted emission at mains port	Class B	Applied	MP4 + USB Read with PC L2 0.150 MHz QP 12.7 dB	Pass	-
Radiated emission (below 1 GHz)	Class B	Applied	MP4 + USB Read with PC V 65.636 MHz QP 4.2 dB	Pass	-
Radiated emission (above 1 GHz)	Class B	Applied	MP4 + USB Read with PC V 2595.627 MHz PK 17.7 dB	Pass	-

### 1.6 Test information

The following EMC test conditions were applied based on the conditions specified by the applicant.

- Tested supply voltage and supply frequency
- Operation mode
- 

This product supports two types of main memory Samsung (model number: KM2L9001CM-B518) and SK Hynix (model number: H9QT0GECN6X145).

All operation modes were performed on the EUT with Samsung (model number: KM2L9001CM-B518) and in its worst case on the EUT with SK Hynix (model number: H9QT0GECN6X145) in accordance with the judgment of the applicant.



Japan

**1.7 Test set up**

Table-top

**1.8 Test period**

28-June-2023 - 22-July-2023

## 2 Equipment Under Test

All information in this chapter was provided by the applicant.

### 2.1 EUT information

Applicant	KYOCERA Corporation Yokohama Office 2-1-1 Kagahara, Tsuzuki-ku, Yokohama-shi, Kanagawa, 224-8502 Japan Phone: +81-45-943-6253 Fax: +81-45-943-6314
Equipment Under Test (EUT)	Mobile Phone
Model number	EB1157
Serial number	358018240001107, 358018240001115, 358018240018267
Trade name	Kyocera
Authorization	JOYEB1157
Number of sample(s)	3
EUT condition	Pre-production
Maximum frequency	2400 MHz
Power rating	Battery: DC 3.87 V
Size	(W) 75 × (D) 14.6 × (H) 154 mm

### 2.2 Modification to the EUT

The table below details modifications made to the EUT during the test project.

Modification State	Description of Modification	Modification fitted by	Date of Modification
EB1157, S/N: 358018240001107			
0	As supplied by the applicant	Not Applicable	Not Applicable
EB1157, S/N: 358018240001115			
0	As supplied by the applicant	Not Applicable	Not Applicable
EB1157, S/N: 358018240018267			
0	As supplied by the applicant	Not Applicable	Not Applicable



## **2.3 Variation of family model(s)**

### **2.3.1 List of family model(s)**

Not applicable

### **2.3.2 Reason for selection of EUT**

Not applicable

## **2.4 Operation mode**

1. In Camera with ADP mode

- i) Power ON
- ii) Record

2. Out Camera with ADP mode

- i) Power ON
- ii) Record

3. Wide Camera with ADP mode

- i) Power ON
- ii) Record

4. Macro Camera with ADP mode

- i) Power ON

5. MP4 with Earphone mode

- i) Power ON
- ii) Execution of Color Bar moving picture data

6. MP4 + USB Read with PC mode

- i) Power ON
- ii) EUT connects to PC via USB cable
- iii) Read/write of MP4 moving picture data
- iv) Execution of Color Bar moving picture data



### 3 Configuration of Equipment

Numbers assigned to equipment or cables in "3.1 Equipment(s) used" and "3.2 Cable(s) used" correspond to numbers in "3.3 System configuration".

Cabling and setup(s) were taken into consideration and test data was taken under worse case condition.

#### 3.1 Equipment used

No.	Equipment	Company	Model No.	Serial No.	Authorization	Remarks
EUT1	Mobile Phone	KYOCERA	EB1157	358018240001107	JOYEB1157	EUT*1
				358018240001115	JOYEB1157	EUT*2
				358018240018267	JOYEB1157	EUT*3
AE1	AC adapter	KDDI	0602PQA	N/A	N/A	*4
AE2	Earphone	N/A	N/A	N/A	N/A	-
AE3	Personal Computer	Lenovo	4334	CB07410173	DoC	*5
AE4	AC adapter	Lenovo	CPA-A065	11S36001943ZZ20011116S	N/A	*5

\*1: Memory: Samsung (M/N: KM2L9001CM-B518), used except for Macro Camera with ADP mode

\*2: Memory: Samsung (M/N: KM2L9001CM-B518), used in Macro Camera with ADP mode

\*3: Memory: SK Hynix (M/N: H9QT0GECN6X145)

\*4: AC adapter is connected to keep operating.

\*5: The property of TÜV SÜD Japan was used.

#### 3.2 Cable(s) used

No.	Cable	Length (m)	Shield	EUT accessory Ferrite core	Remarks
a	DC cable	1.5	Yes	-	-
b	USB to AUDIO conversion cable	0.1	Yes	-	-
c	Earphone cable	0.75	No	-	-
d	USB cable	1.0	Yes	-	-
e	DC cable for PC AC adapter	1.8	No	-	*1
f	AC power cord for PC AC adapter	1.0	No	-	*1

\*1: The property of TÜV SÜD Japan was used.



### 3.3 System configuration

1. In Camera + with ADP mode
2. Out Camera + with ADP mode
3. Wide Camera + with ADP mode
4. Macro Camera + with ADP mode

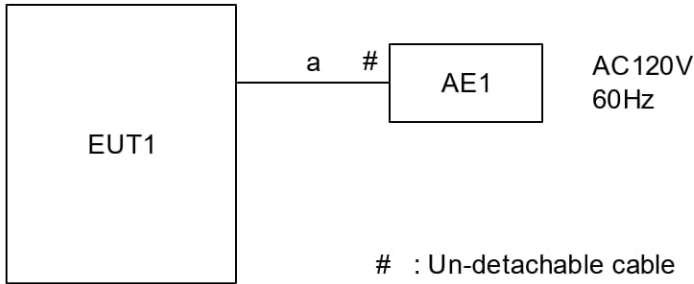

5. MP4 with Earphone mode

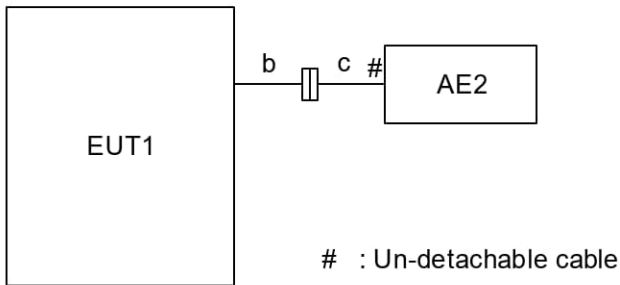

6. MP4 + USB Read with PC mode

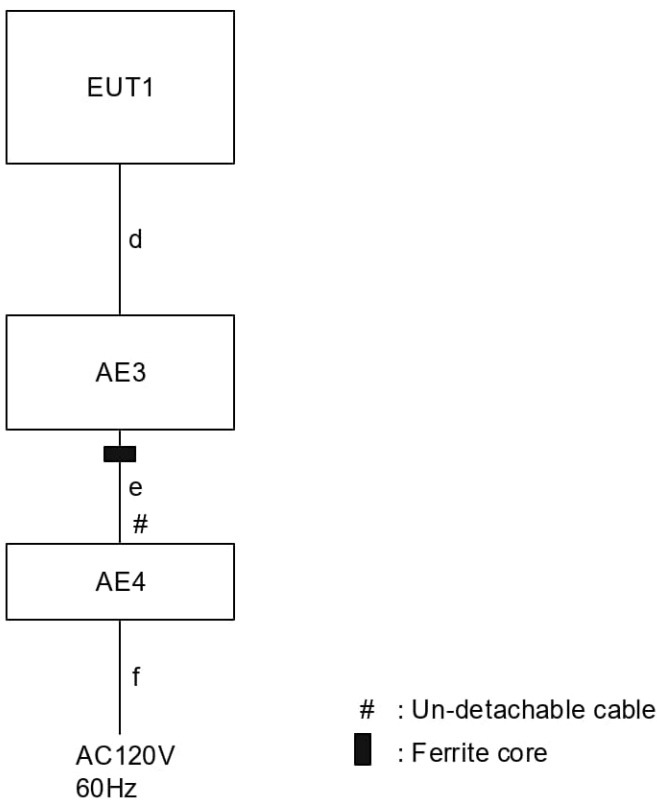

## 4 Test Result

### 4.1 Conducted emission at mains port

#### 4.1.1 Measurement condition

EUT is placed on a non-conducting table for table-top equipment or on insulation material for a floor-standing equipment. In addition, a table-top equipment is located 0.4 m to a metal reference plane.

Line Impedance Stabilization Network (LISN) is placed 0.8 m away from the EUT. The power code of the EUT is connected to LISN and its excess part is bundled in the center. The length of bundling is 0.3-0.4 m.

A power code of a peripheral is connected to LISN and terminated into 50  $\Omega$ .

Excess cables between equipment are bundled in the center. The length of bundling is 0.3-0.4 m.

Where LISN cannot be applied, the test is performed using a voltage probe.

After overall frequency range is investigated with spectrum analyzer using peak detector, measurements are performed with test receiver in setting to the defined values.

Items	Description
Frequency range	0.15 MHz-30 MHz
Test place	10 m Semi-Anechoic Chamber No. 2
EUT was placed on	Styrene foam table (W) 2.0 × (D) 1.0 × (H) 0.8 m
Metal reference plane	Vertical
Test receiver setting	Detector: Quasi-peak, Average Bandwidth: 9 kHz
Line Impedance Stabilization Network (LISN)	Specification: 50 $\Omega$ /50 $\mu$ H Distance from EUT: 0.8 m

#### 4.1.2 Calculation method

Emission Level = Reading + Factor\*

Margin = Limit – Emission Level

\*Note: Factor = LISN factor + Cable system loss + ATT. loss

Example)

Limit @ 6.770 MHz:    60.0 dB $\mu$ V (Quasi-peak)  
                                  50.0 dB $\mu$ V (Average)

Quasi-peak    Reading = 41.2 dB $\mu$ V    Factor = 10.3 dB  
                                  Emission level = 41.2 + 10.3 = 51.5 dB $\mu$ V  
                                  Margin = 60.0 - 51.5 = 8.5 dB

Average        Reading = 35.0 dB $\mu$ V    Factor = 10.3 dB  
                                  Emission level = 35.0 + 10.3 = 45.3 dB $\mu$ V  
                                  Margin = 50.0 - 45.3 = 4.7 dB



### 4.1.3 Test data and Configuration photographs

Operation mode	MP4 + USB Read with PC mode
EUT	EB1157, S/N: 358018240001107 - Modification State 0

S/N: 358018240001107 (Memory: Samsung (M/N KM2L9001CM-B518))  
 Standard : FCC Part 15 Class B  
 Date of test : 29 June,2023 09:16  
 Operator : Akihiro Goto  
 Temp, Hum, Atm : 22.3 [°C], 64.5 [%], 980 [hPa]  
 Supply power : AC 120 V, 60 Hz, 1 phase

\*\*\*\*\* CONDUCTED EMISSION \*\*\*\*\*  
 [ 10m Semi-anechoic chamber #2 ]

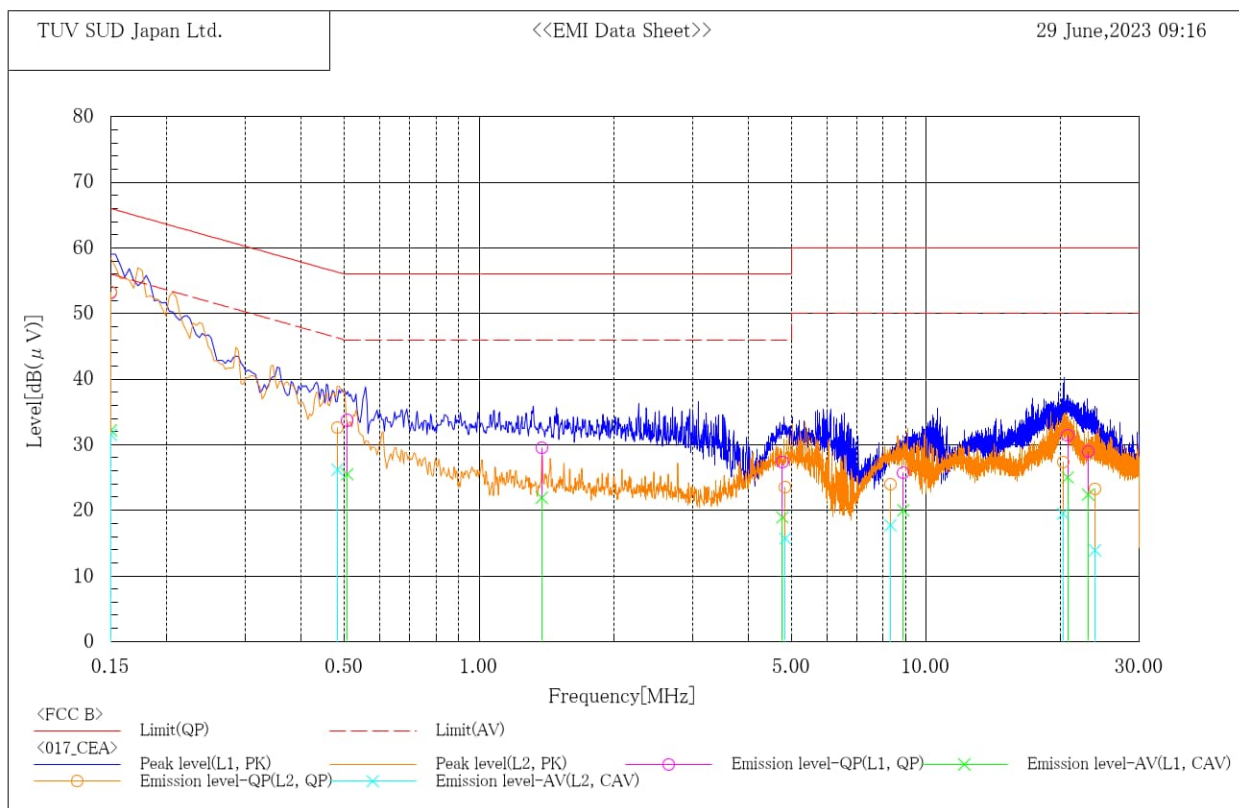

### Final Result

Line	Frequency MHz	Reading dB(uV)		Factor dB	Level dB(uV)		Limit dB(uV)		Margin dB	
		QP	CAV		QP	CAV	QP	AV	QP	AV
		L1	0.150		42.7	21.7	10.5	53.2	32.2	66.0
L1	0.507	23.4	15.2	10.3	33.7	25.5	56.0	46.0	22.3	20.5
L1	1.380	19.1	11.5	10.4	29.5	21.9	56.0	46.0	26.5	24.1
L1	4.770	16.8	8.3	10.6	27.4	18.9	56.0	46.0	28.6	27.1
L1	8.891	14.9	9.2	10.8	25.7	20.0	60.0	50.0	34.3	30.0
L1	20.733	20.3	13.9	11.1	31.4	25.0	60.0	50.0	28.6	25.0
L1	23.021	17.7	11.2	11.2	28.9	22.4	60.0	50.0	31.1	27.6
L2	0.150	42.8	21.0	10.5	53.3	31.5	66.0	56.0	12.7	24.5
L2	0.482	22.3	15.9	10.3	32.6	26.2	56.3	46.3	23.7	20.1
L2	4.834	12.9	5.1	10.6	23.5	15.7	56.0	46.0	32.5	30.3
L2	8.319	13.2	6.9	10.8	24.0	17.7	60.0	50.0	36.0	32.3
L2	20.224	16.2	8.3	11.2	27.4	19.5	60.0	50.0	32.6	30.5
L2	23.857	12.1	2.7	11.2	23.3	13.9	60.0	50.0	36.7	36.1

## 4.2 Radiated emission (below 1 GHz)

### 4.2.1 Measurement condition

Frequency range	30 MHz-1000 MHz
Test place	10 m Semi-Anechoic Chamber No. 2
EUT was placed on	Styrene foam table (W) 2.0 × (D) 1.0 × (H) 0.8 m
Axis	0°-360°
Antenna	Distance from EUT: 3 m Height: 1-4 m Polarity: Horizontal/Vertical
Test receiver setting	Detector: Quasi-peak Bandwidth: 120 kHz

EUT is placed on a non-conducting table for table-top equipment or on insulation material for a floor-standing equipment. The non-conducting table or the insulation material is placed on a rotating turn table.

Excess cables between equipment are bundled in the center. The length of bundling is 0.3-0.4 m.

An antenna is adjusted between 1-4 m in height and varied its polarization (horizontal and vertical), and the EUT azimuth is varied by the rotating turntable 0 to 360 degrees.

After overall frequency range is investigated with spectrum analyzer using peak detector, measurements are performed with test receiver in setting to the defined values.

### 4.2.2 Calculation method

Emission level = Reading + c.f. (correction factor)\*

Margin = Limit - Emission level

\*Note: c.f. = Antenna factor + Cable system loss + Attenuator loss - Amplifier Gain

Example)

Limit @ 350.0 MHz: 37.0 dB $\mu$ V/m

Reading = 41.1 dB $\mu$ V c.f. = -11.8 dB/m

Emission level = 41.1 - 11.8 = 29.3 dB $\mu$ V/m

Margin = 37.0 - 29.3 = 7.7 dB



### 4.2.3 Test data and Configuration photographs

Operation mode	In Camera with ADP mode
EUT	EB1157, S/N: 358018240001107 - Modification State 0 EB1157, S/N: 358018240018267 - Modification State 0

S/N: 358018240001107 (Memory: Samsung (M/N KM2L9001CM-B518))

Standard : FCC Part 15 Class B  
 Date of test : 28 June,2023 23:48  
 Operator : Yoshiyuki Takahashi  
 Temp, Hum, Atm : 22.6 [°C], 58.8 [%], 982 [hPa]  
 Supply power : DC 5 V

\*\*\*\*\* RADIATED EMISSION \*\*\*\*\*  
 [ 10m Semi-anechoic chamber #2 ]

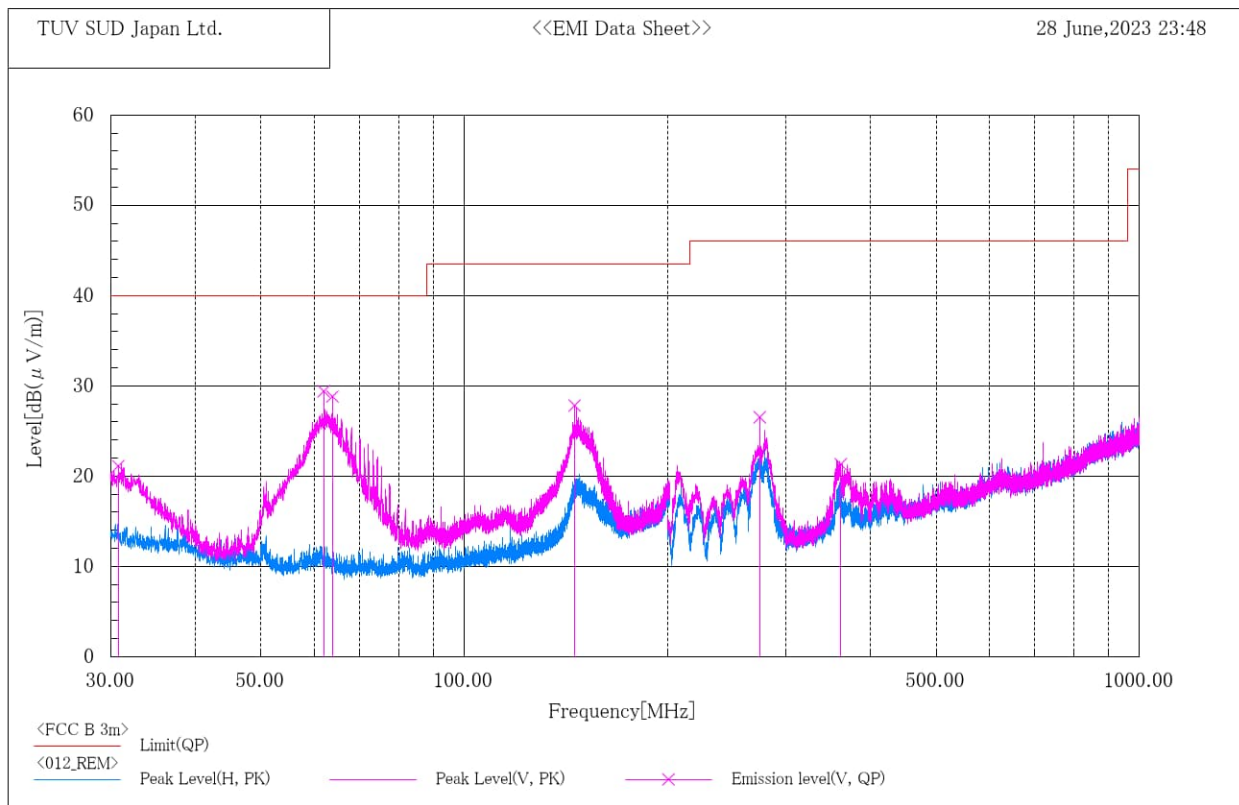

### Final Result

Frequency MHz	Pol.	Reading	Factor	Level	Limit	Margin	Height cm	Angle deg
		dB(μV) QP	dB(1/m)	dB(μV/m) QP	dB(μV/m) QP	dB QP		
30.778	V	34.5	-13.4	21.1	40.0	18.9	100.0	158.0
62.007	V	46.5	-17.1	29.4	40.0	10.6	100.0	166.0
63.881	V	46.0	-17.2	28.8	40.0	11.2	100.0	167.0
145.772	V	41.5	-13.7	27.8	43.5	15.7	100.0	235.0
274.072	V	41.3	-14.8	26.5	46.0	19.5	169.0	22.0
361.063	V	33.7	-12.4	21.3	46.0	24.7	168.0	171.0





S/N: 358018240018267 (Memory: SK Hynix (M/N: H9QT0GECN6X145))

Standard : FCC Part 15 Class B  
 Date of test : 22 July,2023 09:32  
 Operator : Nobuhiko Iwasawa  
 Temp, Hum, Atm : 24.0 [°C], 60.0 [%], 992 [hPa]  
 Supply power : DC 5 V

\*\*\*\*\* RADIATED EMISSION \*\*\*\*\*  
 [ 10m Semi-anechoic chamber #2 ]

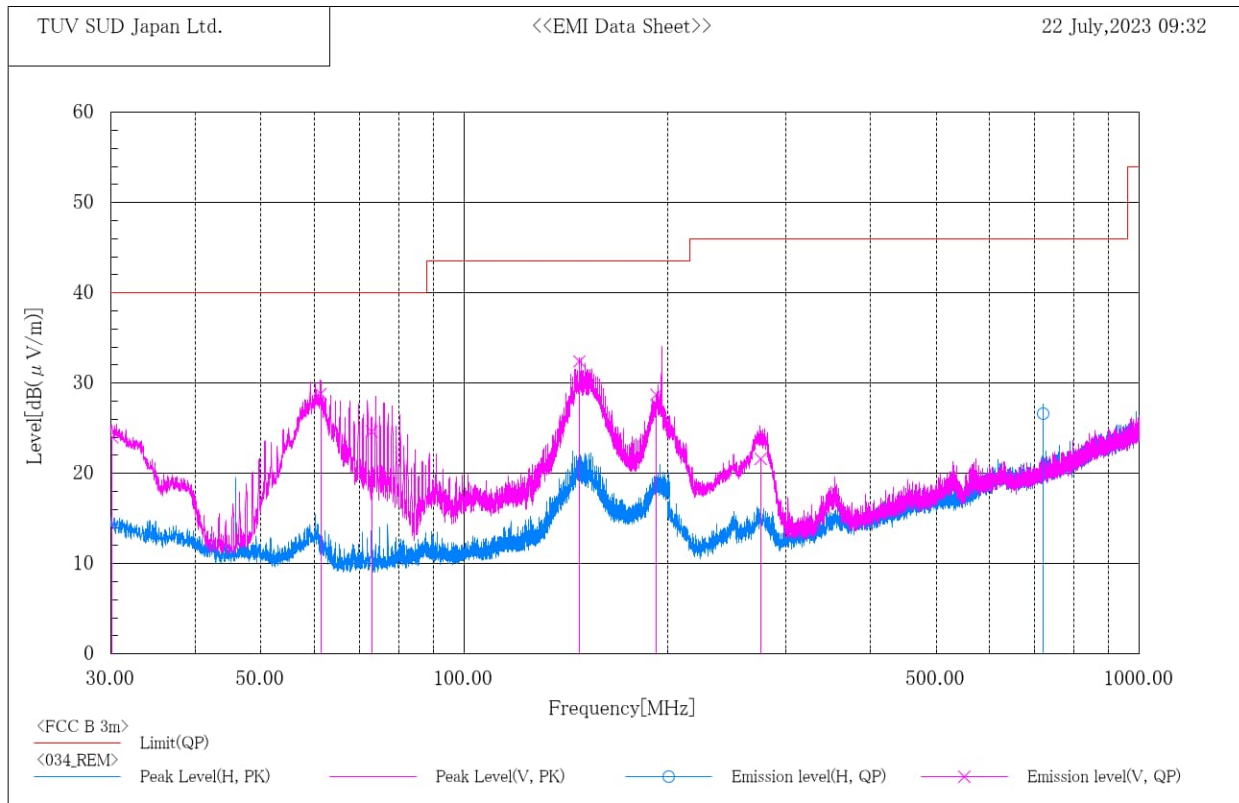

**Final Result**

Frequency	Pol.	Reading	Factor	Level	Limit	Margin	Height	Angle
MHz		dB(μV) QP	dB(1/m)	dB(μV/m) QP	dB(μV/m) QP	dB QP	cm	deg
30.150	V	36.9	-12.9	24.0	40.0	16.0	100.0	154.0
61.362	V	46.0	-17.2	28.8	40.0	11.2	100.0	192.0
73.067	V	41.6	-17.0	24.6	40.0	15.4	100.0	199.0
148.199	V	45.7	-13.3	32.4	43.5	11.1	100.0	287.0
192.553	V	40.1	-11.4	28.7	43.5	14.8	100.0	144.0
274.920	V	36.3	-14.7	21.6	46.0	24.4	100.0	313.0
719.990	H	32.8	-6.2	26.6	46.0	19.4	100.0	162.0



Operation mode	Out Camera with ADP mode
EUT	EB1157, S/N: 358018240001107 - Modification State 0

S/N: 358018240001107 (Memory: Samsung (M/N KM2L9001CM-B518))

Standard : FCC Part 15 Class B  
 Date of test : 29 June,2023 00:50  
 Operator : Yoshiyuki Takahashi  
 Temp, Hum, Atm : 22.6 [°C], 58.8 [%], 982 [hPa]  
 Supply power : DC 5 V

\*\*\*\*\* RADIATED EMISSION \*\*\*\*\*  
 [ 10m Semi-anechoic chamber #2 ]

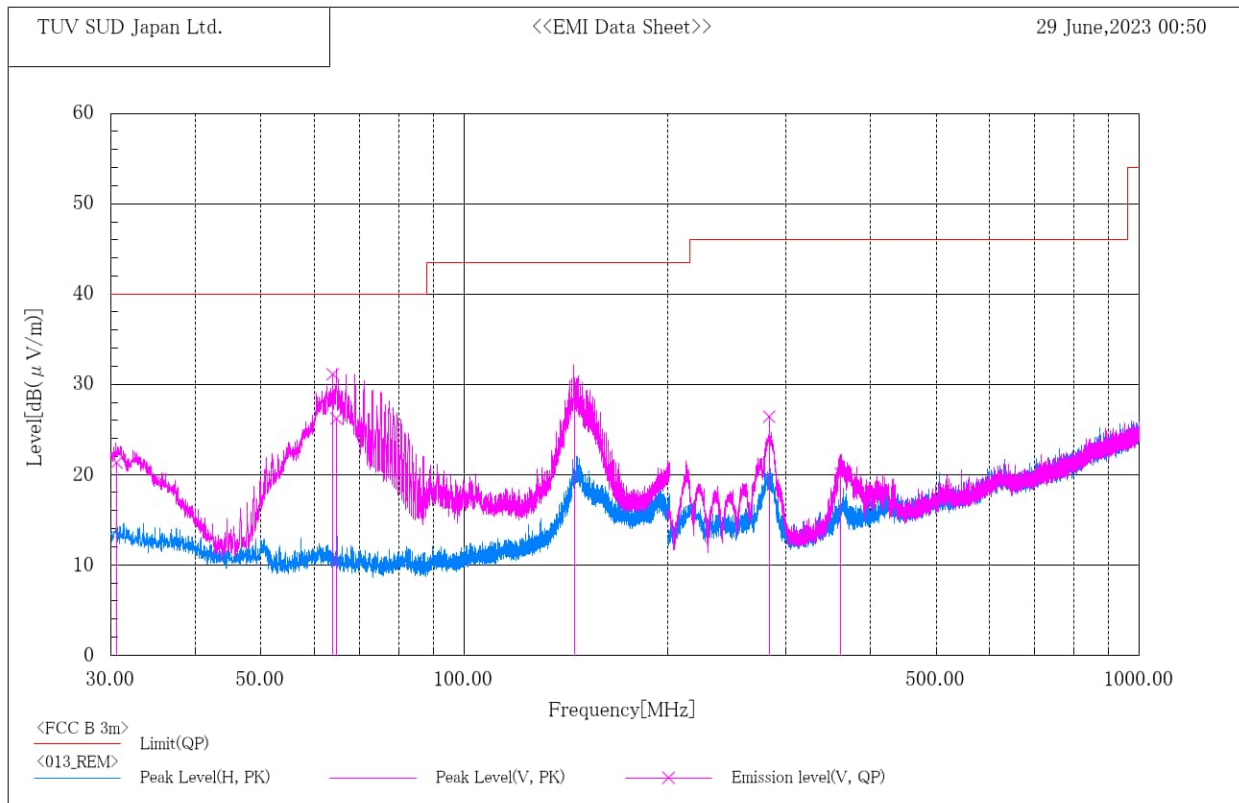

**Final Result**

Frequency	Pol.	Reading	Factor	Level	Limit	Margin	Height	Angle
MHz		dB(μV) QP		dB(1/m)				
30.604	V	34.7	-13.4	21.3	40.0	18.7	100.0	219.0
63.940	V	48.3	-17.2	31.1	40.0	8.9	100.0	143.0
64.748	V	43.4	-17.2	26.2	40.0	13.8	100.0	146.0
145.986	V	41.7	-13.7	28.0	43.5	15.5	100.0	232.0
283.081	V	40.9	-14.5	26.4	46.0	19.6	165.0	24.0
361.196	V	32.5	-12.4	20.1	46.0	25.9	181.0	159.0





Operation mode	Wide Camera with ADP mode
EUT	EB1157, S/N: 358018240001107 - Modification State 0

S/N: 358018240001107 (Memory: Samsung (M/N KM2L9001CM-B518))

Standard : FCC Part 15 Class B  
 Date of test : 29 June,2023 01:43  
 Operator : Yoshiyuki Takahashi  
 Temp, Hum, Atm : 22.6 [°C], 58.8 [%], 982 [hPa]  
 Supply power : DC 5 V

\*\*\*\*\* RADIATED EMISSION \*\*\*\*\*  
 [ 10m Semi-anechoic chamber #2 ]

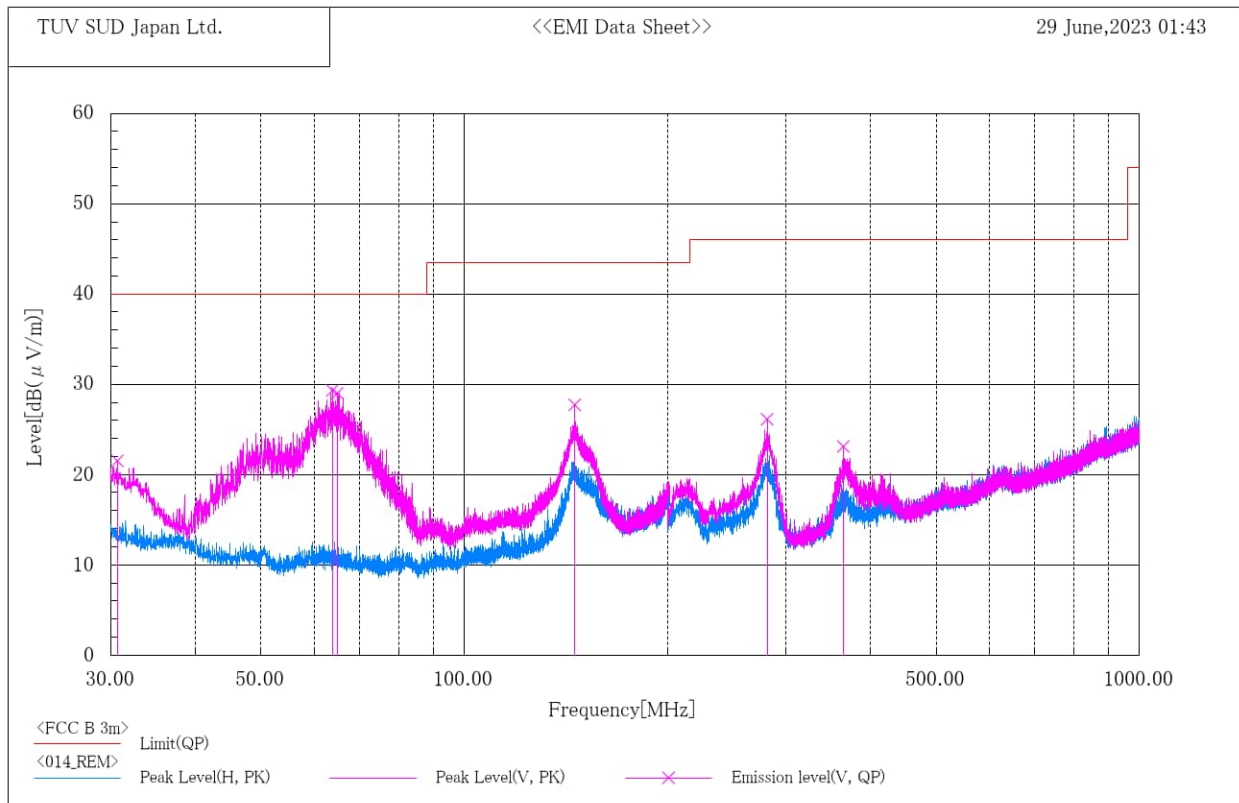

**Final Result**

Frequency	Pol.	Reading	Factor	Level	Limit	Margin	Height	Angle
MHz		dB( $\mu\text{V}$ ) QP	dB(1/m)	dB( $\mu\text{V}/\text{m}$ ) QP	dB( $\mu\text{V}/\text{m}$ ) QP	dB QP	cm	deg
30.666	V	34.9	-13.4	21.5	40.0	18.5	100.0	189.0
63.881	V	46.5	-17.2	29.3	40.0	10.7	100.0	158.0
64.900	V	46.2	-17.2	29.0	40.0	11.0	100.0	160.0
145.869	V	41.4	-13.7	27.7	43.5	15.8	100.0	235.0
281.024	V	40.7	-14.6	26.1	46.0	19.9	190.0	5.0
364.160	V	35.5	-12.4	23.1	46.0	22.9	131.0	175.0



Operation mode	Macro Camera with ADP mode
EUT	EB1157, S/N: 358018240001115 - Modification State 0

S/N: 358018240001115 (Memory: Samsung (M/N KM2L9001CM-B518))

Standard : FCC Part 15 Class B  
 Date of test : 28 June,2023 22:46  
 Operator : Yoshiyuki Takahashi  
 Temp, Hum, Atm : 22.6 [°C], 58.8 [%], 982 [hPa]  
 Supply power : DC 5 V

\*\*\*\*\* RADIATED EMISSION \*\*\*\*\*  
 [ 10m Semi-anechoic chamber #2 ]

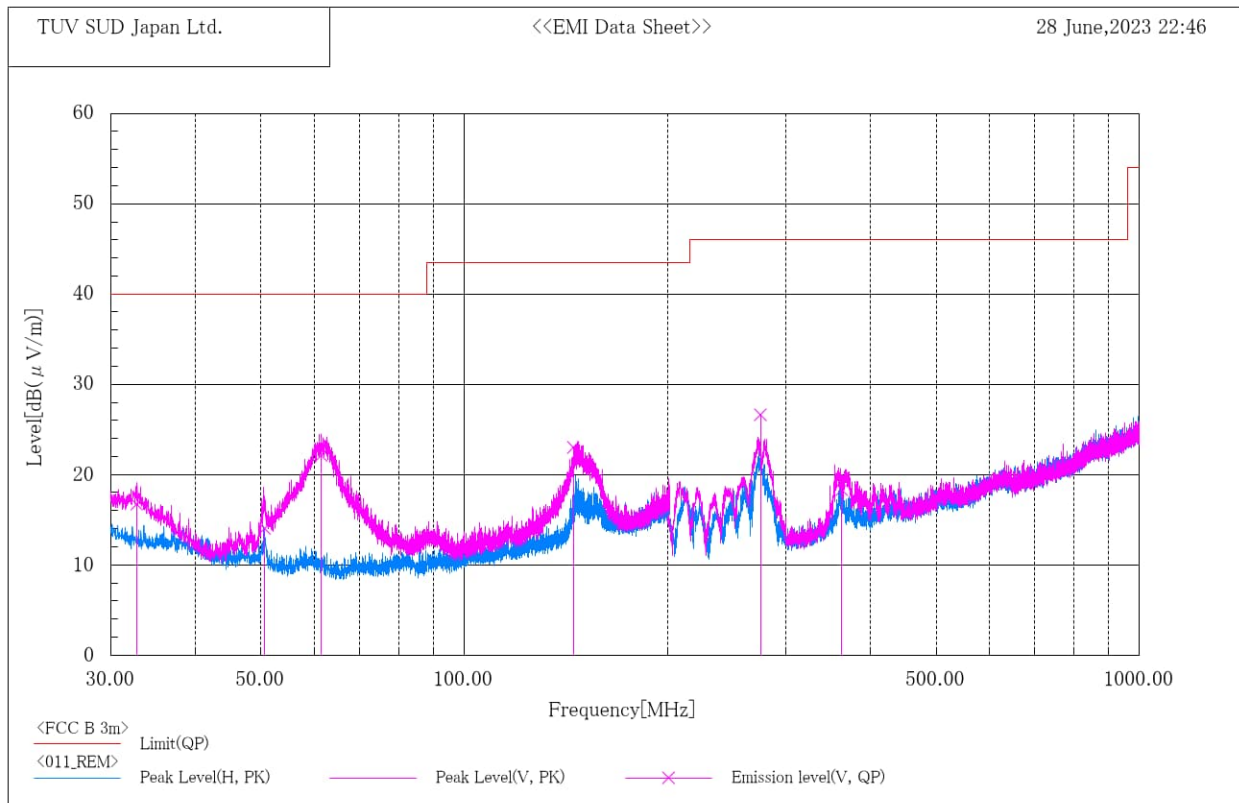

**Final Result**

Frequency	Pol.	Reading	Factor	Level	Limit	Margin	Height	Angle
MHz		$\text{dB}(\mu\text{V})$ QP	$\text{dB}(1/\text{m})$	$\text{dB}(\mu\text{V}/\text{m})$ QP	$\text{dB}(\mu\text{V}/\text{m})$ QP	$\text{dB}$ QP	cm	deg
32.763	V	30.5	-13.8	16.7	40.0	23.3	100.0	273.0
50.680	V	30.4	-16.4	14.0	40.0	26.0	100.0	140.0
61.486	V	39.1	-17.0	22.1	40.0	17.9	100.0	211.0
145.173	V	36.7	-13.7	23.0	43.5	20.5	100.0	257.0
274.692	V	41.3	-14.7	26.6	46.0	19.4	194.0	28.0
362.413	V	30.7	-12.4	18.3	46.0	27.7	100.0	161.0



Operation mode	MP4 with Earphone mode
EUT	EB1157, S/N: 358018240001107 - Modification State 0

S/N: 358018240001107 (Memory: Samsung (M/N KM2L9001CM-B518))

Standard : FCC Part 15 Class B  
 Date of test : 29 June,2023 03:41  
 Operator : Yoshiyuki Takahashi  
 Temp, Hum, Atm : 22.6 [°C], 58.8 [%], 982 [hPa]  
 Supply power : DC 3.87 V (Battery)

\*\*\*\*\* RADIATED EMISSION \*\*\*\*\*  
 [ 10m Semi-anechoic chamber #2 ]

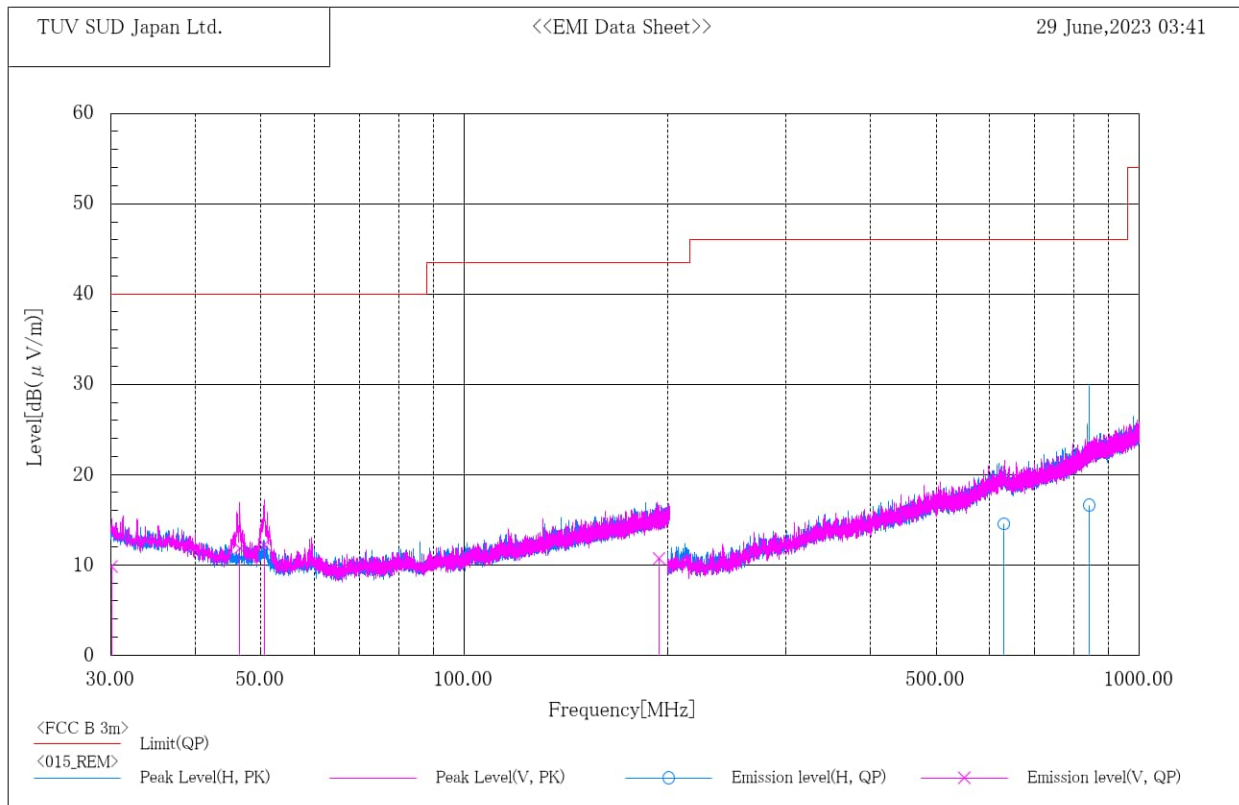

**Final Result**

Frequency	Pol.	Reading	Factor	Level	Limit	Margin	Height	Angle
MHz		dB(μV) QP		dB(1/m)				
30.093	V	23.0	-13.2	9.8	40.0	30.2	100.0	337.0
46.591	V	27.8	-16.0	11.8	40.0	28.2	250.0	328.0
50.627	V	28.6	-16.4	12.2	40.0	27.8	313.0	16.0
194.381	V	22.3	-11.6	10.7	43.5	32.8	100.0	15.0
630.563	H	21.5	-7.0	14.5	46.0	31.5	198.0	310.0
842.562	H	20.5	-3.9	16.6	46.0	29.4	309.0	101.0



Operation mode	MP4 + USB Read with PC mode
EUT	EB1157, S/N: 358018240001107 - Modification State 0 EB1157, S/N: 358018240018267 - Modification State 0

S/N: 358018240001107 (Memory: Samsung (M/N KM2L9001CM-B518))

Standard : FCC Part 15 Class B  
 Date of test : 29 June,2023 05:29  
 Operator : Yoshiyuki Takahashi  
 Temp, Hum, Atm : 22.6 [°C], 58.8 [%], 982 [hPa]  
 Supply power : AC 120 V, 60 Hz, 1 phase

\*\*\*\*\* RADIATED EMISSION \*\*\*\*\*  
 [ 10m Semi-anechoic chamber #2 ]

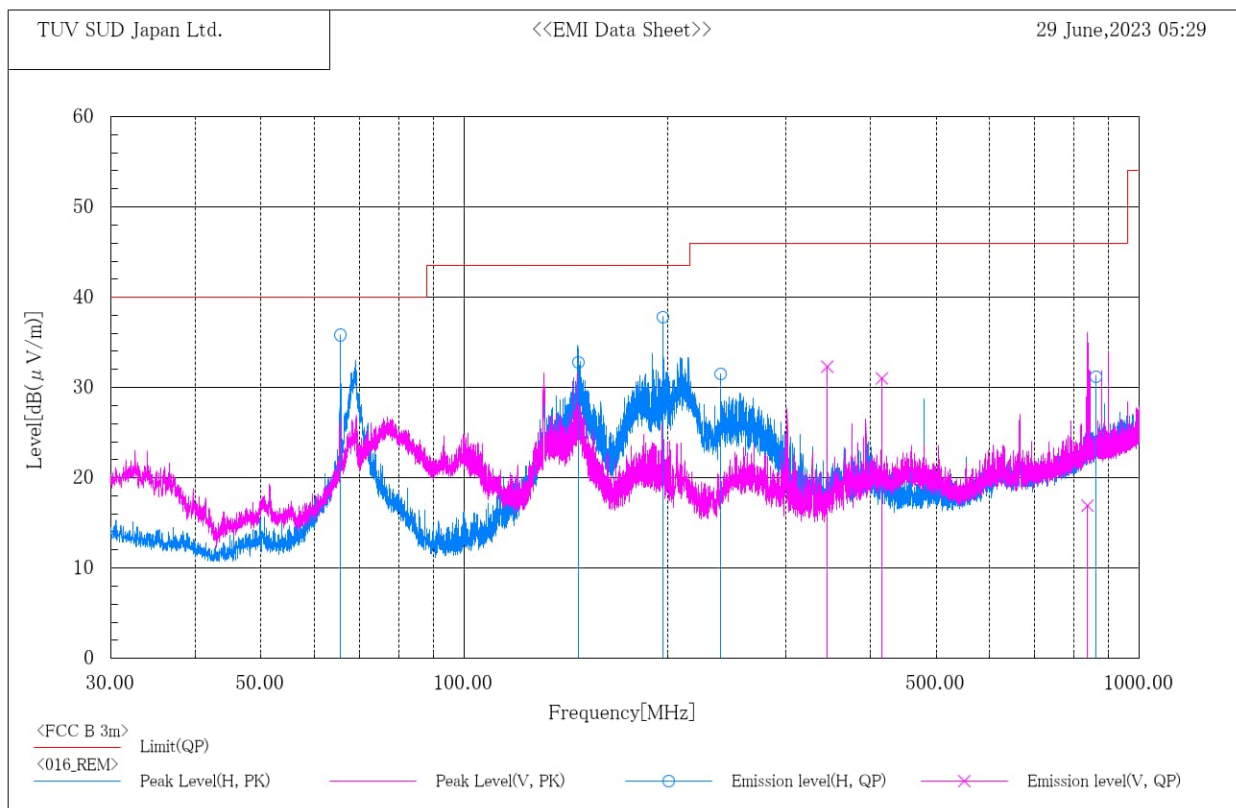

**Final Result**

Frequency	Pol.	Reading	Factor	Level	Limit	Margin	Height	Angle
MHz		dB( $\mu\text{V}$ ) QP	dB(1/m)	dB( $\mu\text{V}/\text{m}$ ) QP	dB( $\mu\text{V}/\text{m}$ ) QP	dB QP	cm	deg
65.636	H	53.0	-17.2	35.8	40.0	4.2	350.0	342.0
147.568	H	46.4	-13.6	32.8	43.5	10.7	213.0	133.0
196.998	H	49.3	-11.5	37.8	43.5	5.7	163.0	203.0
239.993	H	47.9	-16.4	31.5	46.0	14.5	148.0	300.0
344.989	V	44.9	-12.6	32.3	46.0	13.7	100.0	109.0
415.541	V	42.3	-11.3	31.0	46.0	15.0	100.0	113.0
837.714	V	20.9	-4.0	16.9	46.0	29.1	318.0	315.0
862.459	H	34.7	-3.5	31.2	46.0	14.8	172.0	2.0



S/N: 358018240018267 (Memory: SK Hynix (M/N: H9QT0GECN6X145))

Standard : FCC Part 15 Class B  
 Date of test : 22 July,2023 10:34  
 Operator : Nobuhiko Iwasawa  
 Temp, Hum, Atm : 24.0 [°C], 60.0 [%], 992 [hPa]  
 Supply power : AC 120 V, 60 Hz, 1 phase

\*\*\*\*\* RADIATED EMISSION \*\*\*\*\*  
 [ 10m Semi-anechoic chamber #2 ]

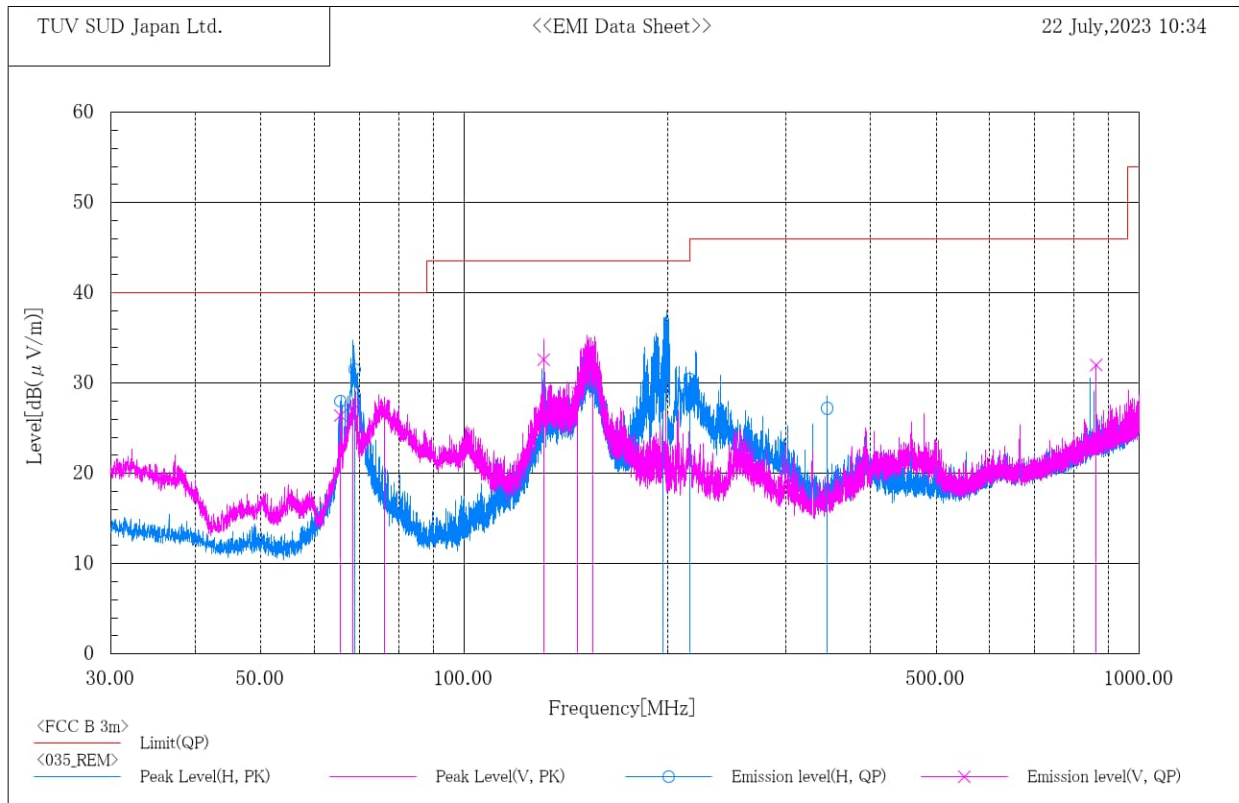

**Final Result**

Frequency	Pol.	Reading	Factor	Level	Limit	Margin	Height	Angle
MHz		dB(μV) QP	dB(1/m)	dB(μV/m) QP	dB(μV/m) QP	dB QP	cm	deg
65.638	H	45.3	-17.3	28.0	40.0	12.0	306.0	172.0
65.657	V	43.7	-17.3	26.4	40.0	13.6	100.0	98.0
68.383	V	44.1	-17.2	26.9	40.0	13.1	100.0	85.0
68.909	H	48.7	-17.2	31.5	40.0	8.5	308.0	175.0
76.210	V	44.1	-16.8	27.3	40.0	12.7	100.0	160.0
131.195	V	46.8	-14.2	32.6	43.5	10.9	100.0	219.0
147.457	V	42.3	-13.4	28.9	43.5	14.6	100.0	218.0
155.244	V	43.2	-13.1	30.1	43.5	13.4	100.0	233.0
196.828	H	42.7	-11.1	31.6	43.5	11.9	187.0	188.0
215.613	H	47.2	-16.8	30.4	43.5	13.1	158.0	176.0
344.989	H	39.8	-12.6	27.2	46.0	18.8	100.0	206.0
862.465	V	35.5	-3.5	32.0	46.0	14.0	100.0	0.0



### 4.3 Radiated emission (above 1 GHz)

#### 4.3.1 Measurement condition

EUT is placed on a styrene form table for table-top equipment or on insulation material for a floor-standing equipment. The styrene form table or the insulation material is placed on a rotating turn table.

Excess cables between equipment are bundled in the center. The length of bundling is 0.3-0.4 m.

Absorbers are placed between the EUT and an antenna.

The antenna is adjusted between 1-4 m in height and varied its polarization (horizontal and vertical), and the EUT azimuth is varied by the rotating turntable 0 to 360 degrees. Where height of the antenna is changed, its angle is also adjusted to the position of the EUT.

After overall frequency range is investigated with spectrum analyzer using peak detector, measurements are performed with test receiver in setting to the defined values.

The antenna is positioned from the test volume that was predetermined by the site VSWR measurement.

Since this predetermined test volume is different from maximum circumference where the EUT and the peripheral devices are actually placed, the measurement distance conversion factor is added to the measurement data.

Items	Description
Frequency range	1000 MHz-12000 MHz
Test place	10 m Semi-Anechoic Chamber No. 2
EUT was placed on	Styrene foam table (W) 2.0 × (D) 1.0 × (H) 0.8 m
Axis	0°-360°
Antenna	Distance from EUT: 408 cm, 392 cm Height: 1-4 m Polarity: Horizontal/Vertical
Test receiver setting	Detector: Peak, Average Bandwidth: 1 MHz

Antenna 3 dB beamwidth

Antenna: 3117

Frequency (GHz)	θ3 dB (°)	3 dB beamwidth w (m)
1.0	83	5.31
2.0	51	2.86
3.0	64	3.75
4.0	51	2.86
5.0	52	2.93
6.0	51	2.86

Measurement distance:  $d = 3.0$  m

$W = 2 \times d \times \tan(0.5 \times \theta_{3\text{ dB}})$



#### 4.3.2 Calculation method

Emission level = Reading + CF\*

Margin = Limit - Emission level

\*Note: CF (correction factor) = TF (Transducer Factor; Antenna factor) + PF (Path Factor; Cable system loss + ATT. loss - Amplifier Gain) + DF (Distance correction Factor)

Example)

Limit @ 1100.0 MHz: 70.0 dB $\mu$ V/m (Peak)  
50.0 dB $\mu$ V/m (Average)

Measurement distance: 3.25 m

Distance conversion Factor:  $20 \log (3.25\text{m}/3.0\text{m}) = 0.7 \text{ dB}$

Peak            Reading = 50.2 dB $\mu$ V    CF = 2.4 dB  
                  Emission level =  $50.2 + 2.4 = 52.6 \text{ dB}\mu\text{V/m}$   
                  Margin =  $70.0 - 52.6 = 17.4 \text{ dB}$

Average        Reading = 32.0 dB $\mu$ V    CF = 2.4 dB  
                  Emission level =  $32.0 + 2.4 = 34.4 \text{ dB}\mu\text{V/m}$   
                  Margin =  $50.0 - 34.4 = 15.6 \text{ dB}$





### 4.3.3 Test data and Configuration photographs

Operation mode	In Camera with ADP mode
EUT	EB1157, S/N: 358018240001107 - Modification State 0 EB1157, S/N: 358018240018267 - Modification State 0

S/N: 358018240001107 (Memory: Samsung (M/N KM2L9001CM-B518))

Standard : FCC Part 15 Class B  
 Date of test : 30 June,2023 13:38  
 Operator : Akihiro Goto  
 Temp, Hum, Atm : 22.6 [°C], 58.4 [%], 978 [hPa]  
 Supply power : DC 5 V  
 Antenna distance (cm) : 408  
 Antenna height (cm) : 100 - 400

\*\*\*\*\* RADIATED EMISSION \*\*\*\*\*  
 [ 10m Semi-anechoic chamber #1 ]

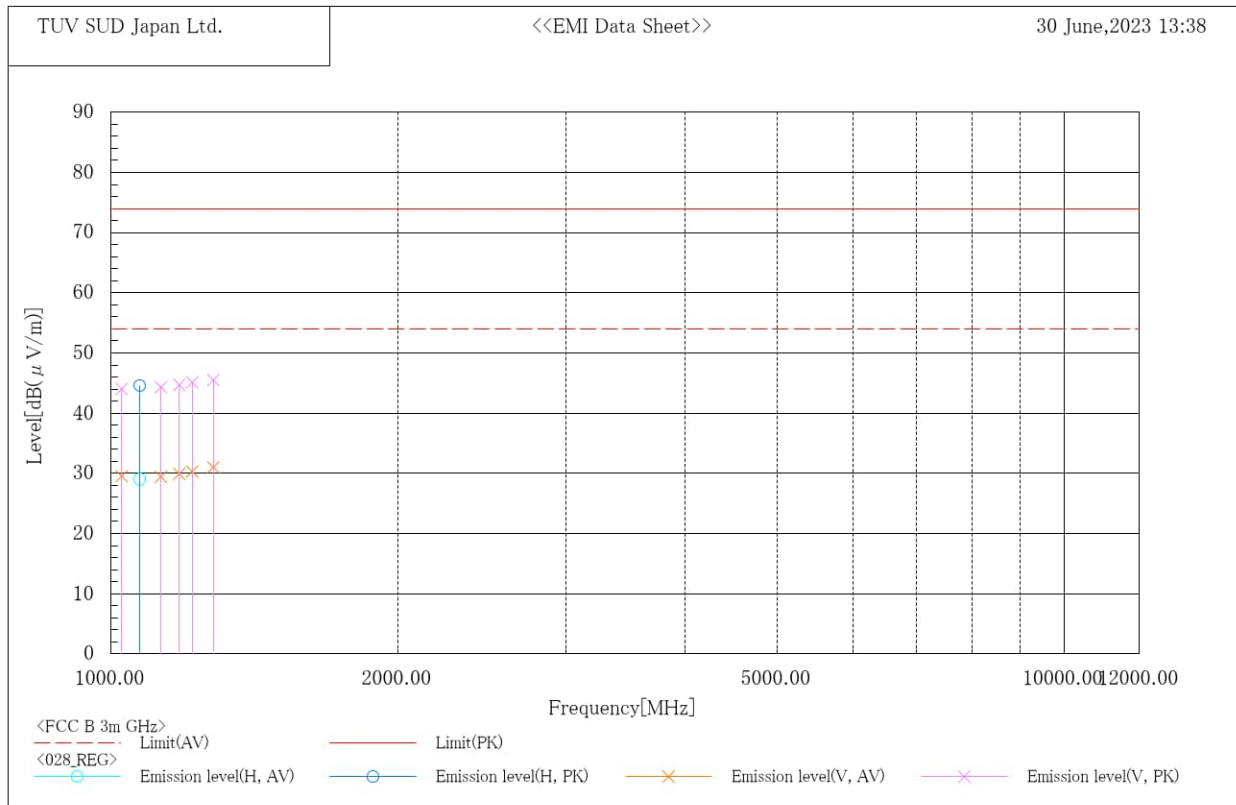

### Final Result

Frequency MHz	Pol.	Reading dB(μV)		Factor dB(1/m)				Level dB(μV/m)		Limit dB(μV/m)		Margin dB		Height cm	Angle deg	Tilt deg
		AV	PK	CF	TF	PF	DF	AV	PK	AV	PK	AV	PK			
1026.584	V	37.7	52.2	-8.2	28.0	-38.9	2.7	29.5	44.0	54.0	74.0	24.5	30.0	100.0	186.0	0
1072.864	H	37.4	53.0	-8.4	27.7	-38.8	2.7	29.0	44.6	54.0	74.0	25.0	29.4	100.0	138.0	0
1128.881	V	37.5	52.4	-8.1	27.8	-38.6	2.7	29.4	44.3	54.0	74.0	24.6	29.7	100.0	242.0	0
1180.059	V	37.4	52.2	-7.5	28.3	-38.5	2.7	29.9	44.7	54.0	74.0	24.1	29.3	100.0	260.0	0
1217.491	V	37.4	52.2	-7.1	28.7	-38.5	2.7	30.3	45.1	54.0	74.0	23.7	28.9	100.0	39.0	0
1280.855	V	37.3	51.8	-6.3	29.3	-38.3	2.7	31.0	45.5	54.0	74.0	23.0	28.5	100.0	97.0	0



S/N: 358018240018267 (Memory: SK Hynix (M/N: H9QT0GECN6X145))

Standard : FCC Part 15 Class B  
 Date of test : 22 July,2023 14:50  
 Operator : Nobuhiko Iwasawa  
 Temp, Hum, Atm : 23.8 [°C], 52.3 [%], 991 [hPa]  
 Supply power : DC 5 V  
 Antenna distance (cm) : 408  
 Antenna height (cm) : 100 - 400

\*\*\*\*\* RADIATED EMISSION \*\*\*\*\*  
 [ 10m Semi-anechoic chamber #1 ]

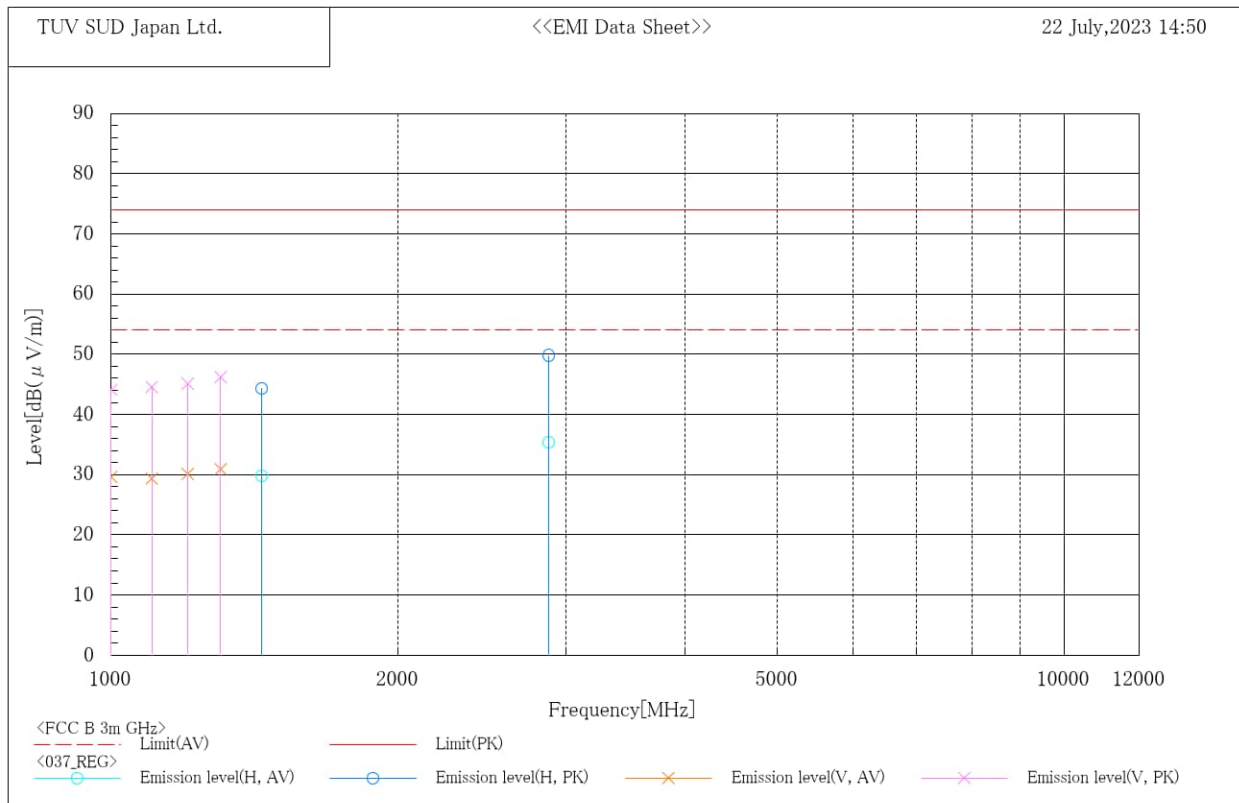

**Final Result**

Frequency MHz	Pol.	Reading dB(μV)		Factor dB(1/m)				Level dB(μV/m)		Limit dB(μV/m)		Margin dB		Height cm	Angle deg	Tilt deg
		AV	PK	CF	TF	PF	DF	AV	PK	AV	PK	AV	PK			
1001.303	V	37.7	52.2	-8.1	28.1	-38.9	2.7	29.6	44.1	54.0	74.0	24.4	29.9	248.0	127.0	25.9
1103.799	V	37.7	52.9	-8.4	27.6	-38.7	2.7	29.3	44.5	54.0	74.0	24.7	29.5	213.0	118.0	20.1
1204.771	V	37.3	52.3	-7.2	28.5	-38.4	2.7	30.1	45.1	54.0	74.0	23.9	28.9	281.0	220.0	30.1
1303.980	V	37.0	52.3	-6.1	29.4	-38.2	2.7	30.9	46.2	54.0	74.0	23.1	27.8	245.0	288.0	24.9
1439.998	H	37.0	51.5	-7.2	28.0	-37.9	2.7	29.8	44.3	54.0	74.0	24.2	29.7	223.0	191.0	21.7
2879.991	H	35.4	49.9	-0.1	32.3	-35.1	2.7	35.3	49.8	54.0	74.0	18.7	24.2	326.0	209.0	35.3



Operation mode	Out Camera with ADP mode
EUT	EB1157, S/N: 358018240001107 - Modification State 0

S/N: 358018240001107 (Memory: Samsung (M/N KM2L9001CM-B518))

Standard : FCC Part 15 Class B  
 Date of test : 30 June,2023 15:10  
 Operator : Akihiro Goto  
 Temp, Hum, Atm : 22.6 [°C], 58.4 [%], 978 [hPa]  
 Supply power : DC 5 V  
 Antenna distance (cm) : 408  
 Antenna height (cm) : 100 - 400

\*\*\*\*\* RADIATED EMISSION \*\*\*\*\*  
 [ 10m Semi-anechoic chamber #1 ]

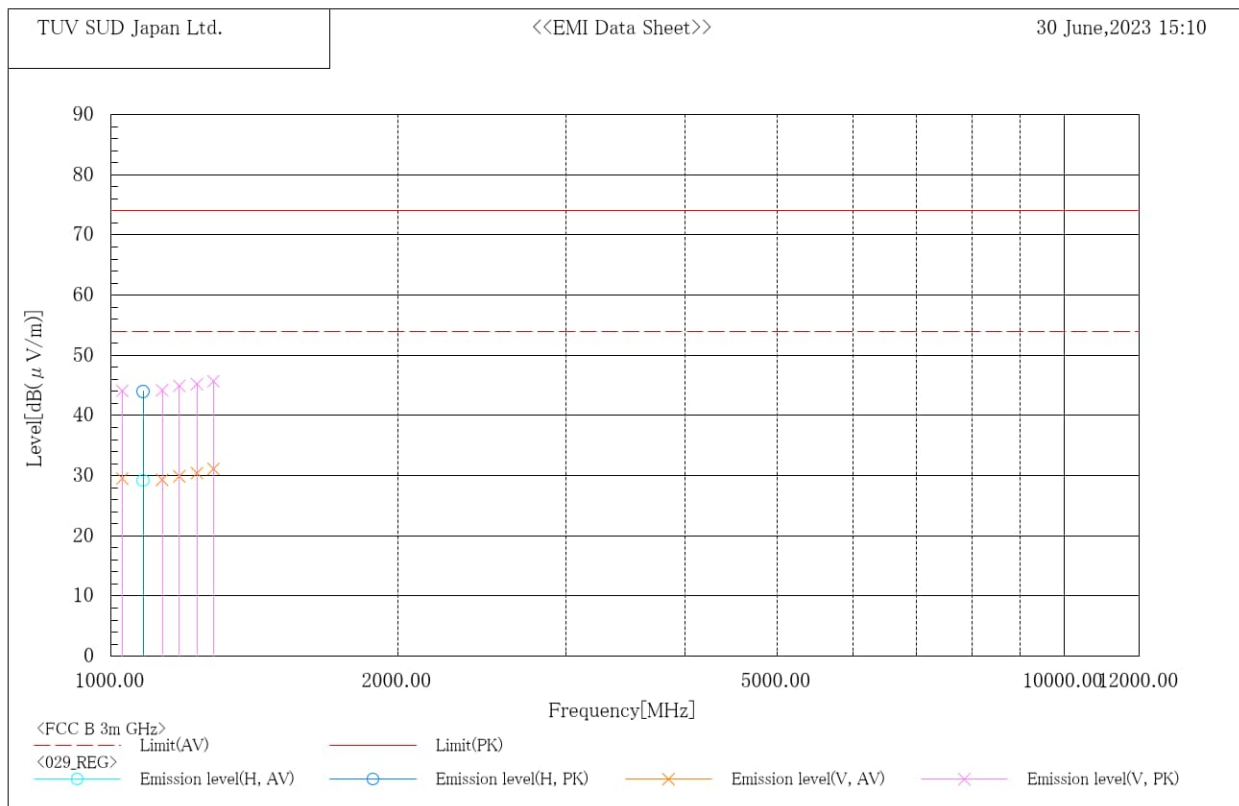

**Final Result**

Frequency MHz	Pol.	Reading dB(μV)		Factor dB(1/m)				Level dB(μV/m)		Limit dB(μV/m)		Margin dB		Height cm	Angle deg	Tilt deg
		AV	PK	CF	TF	PF	DF	AV	PK	AV	PK	AV	PK			
1028.060	V	37.7	52.3	-8.2	27.9	-38.8	2.7	29.5	44.1	54.0	74.0	24.5	29.9	100.0	275.0	0
1080.870	H	37.6	52.4	-8.4	27.7	-38.8	2.7	29.2	44.0	54.0	74.0	24.8	30.0	100.0	138.0	0
1132.320	V	37.4	52.3	-8.1	27.9	-38.7	2.7	29.3	44.2	54.0	74.0	24.7	29.8	100.0	76.0	0
1179.820	V	37.4	52.4	-7.5	28.3	-38.5	2.7	29.9	44.9	54.0	74.0	24.1	29.1	100.0	221.0	0
1231.438	V	37.3	52.1	-6.9	28.8	-38.4	2.7	30.4	45.2	54.0	74.0	23.6	28.8	100.0	323.0	0
1281.817	V	37.4	52.0	-6.3	29.3	-38.3	2.7	31.1	45.7	54.0	74.0	22.9	28.3	100.0	187.0	0



Operation mode	Wide Camera with ADP mode
EUT	EB1157, S/N: 358018240001107 - Modification State 0

S/N: 358018240001107 (Memory: Samsung (M/N KM2L9001CM-B518))

Standard : FCC Part 15 Class B  
 Date of test : 30 June,2023 22:30  
 Operator : Yoshiyuki Takahashi  
 Temp, Hum, Atm : 22.8 [°C], 62.0 [%], 977 [hPa]  
 Supply power : DC 5 V  
 Antenna distance (cm) : 408  
 Antenna height (cm) : 100 - 400

\*\*\*\*\* RADIATED EMISSION \*\*\*\*\*  
 [ 10m Semi-anechoic chamber #1 ]

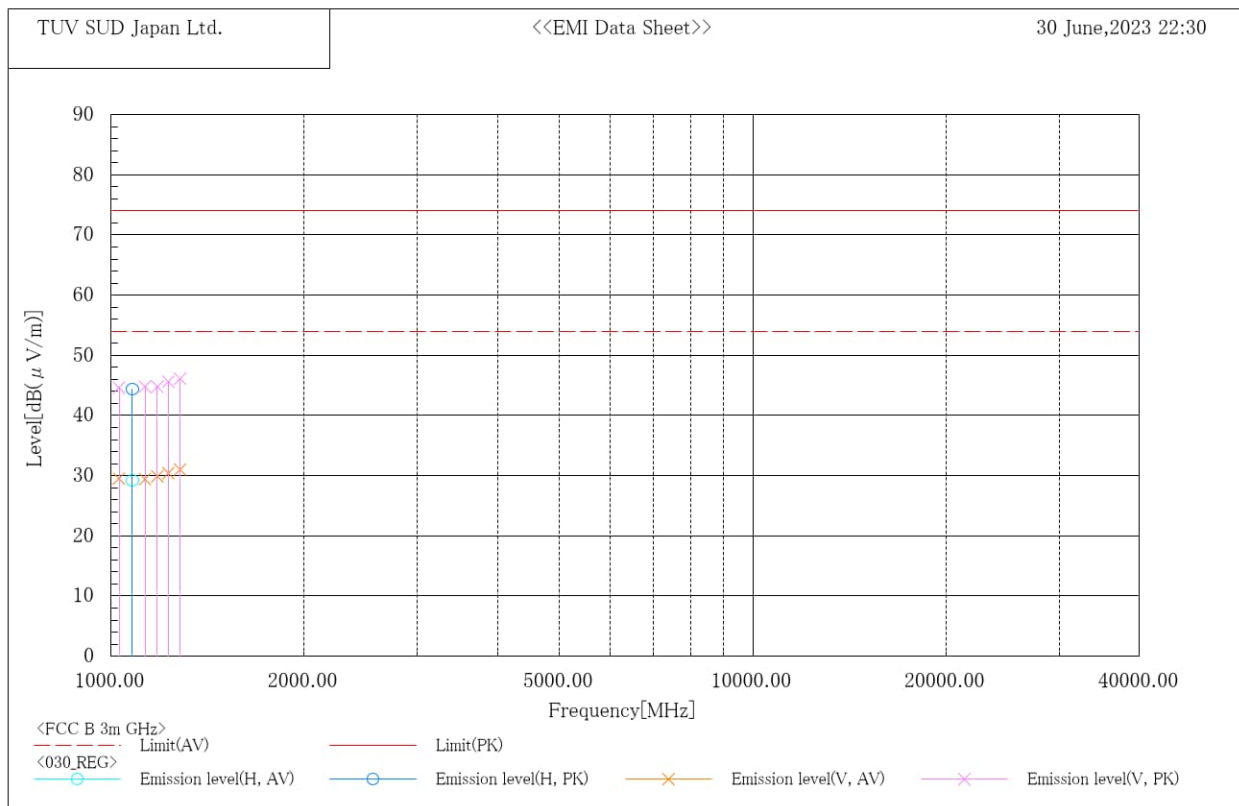

**Final Result**

Frequency MHz	Pol.	Reading		Factor				Level		Limit		Margin		Height cm	Angle deg	Tilt deg
		AV	PK	CF	TF	PF	DF	AV	PK	AV	PK	AV	PK			
1029.439	V	37.7	52.8	-8.2	27.9	-38.8	2.7	29.5	44.6	54.0	74.0	24.5	29.4	100.0	182.0	0
1080.000	H	37.6	52.8	-8.4	27.7	-38.8	2.7	29.2	44.4	54.0	74.0	24.8	29.6	100.0	250.0	0
1130.247	V	37.5	52.9	-8.1	27.8	-38.6	2.7	29.4	44.8	54.0	74.0	24.6	29.2	100.0	48.0	0
1181.647	V	37.4	52.3	-7.5	28.3	-38.5	2.7	29.9	44.8	54.0	74.0	24.1	29.2	100.0	347.0	0
1229.380	V	37.3	52.5	-6.9	28.8	-38.4	2.7	30.4	45.6	54.0	74.0	23.6	28.4	100.0	254.0	0
1282.123	V	37.3	52.4	-6.3	29.3	-38.3	2.7	31.0	46.1	54.0	74.0	23.0	27.9	100.0	165.0	0



Operation mode	Macro Camera with ADP mode
EUT	EB1157, S/N: 358018240001115 - Modification State 0

S/N: 358018240001115 (Memory: Samsung (M/N KM2L9001CM-B518))

Standard : FCC Part 15 Class B  
 Date of test : 01 July,2023 00:01  
 Operator : Yoshiyuki Takahashi  
 Temp, Hum, Atm : 22.8 [°C], 62.0 [%], 977 [hPa]  
 Supply power : DC 5 V  
 Antenna distance (cm) : 408  
 Antenna height (cm) : 100 - 400

\*\*\*\*\* RADIATED EMISSION \*\*\*\*\*  
 [ 10m Semi-anechoic chamber #1 ]

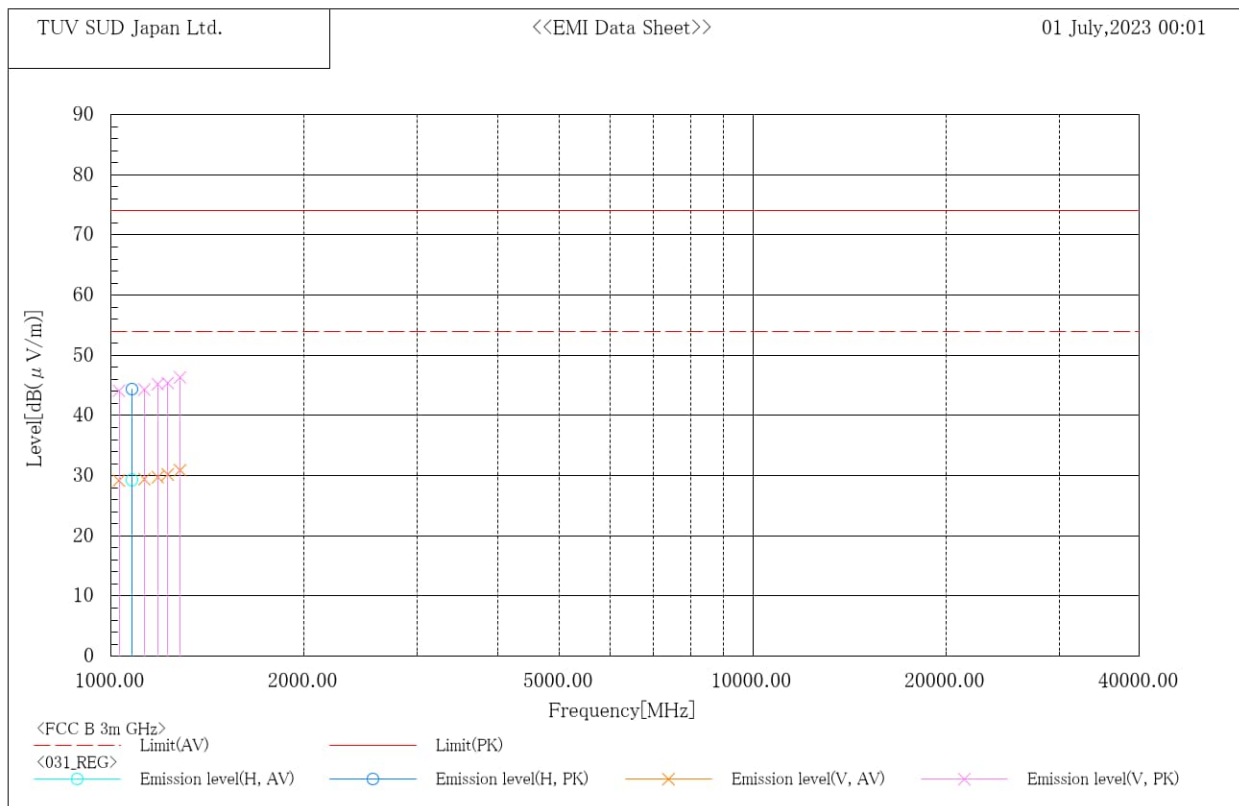

**Final Result**

Frequency MHz	Pol.	Reading dB(μV)		Factor dB(1/m)				Level dB(μV/m)		Limit dB(μV/m)		Margin dB		Height cm	Angle deg	Tilt deg
		AV	PK	CF	TF	PF	DF	AV	PK	AV	PK	AV	PK			
1029.439	V	37.4	52.3	-8.2	27.9	-38.8	2.7	29.2	44.1	54.0	74.0	24.8	29.9	100.0	274.0	0
1079.179	H	37.7	52.8	-8.4	27.7	-38.8	2.7	29.3	44.4	54.0	74.0	24.7	29.6	100.0	226.0	0
1128.204	V	37.5	52.4	-8.1	27.8	-38.6	2.7	29.4	44.3	54.0	74.0	24.6	29.7	100.0	65.0	0
1183.732	V	37.2	52.7	-7.5	28.3	-38.5	2.7	29.7	45.2	54.0	74.0	24.3	28.8	100.0	30.0	0
1226.684	V	37.2	52.4	-7.0	28.7	-38.4	2.7	30.2	45.4	54.0	74.0	23.8	28.6	100.0	350.0	0
1281.949	V	37.2	52.6	-6.3	29.3	-38.3	2.7	30.9	46.3	54.0	74.0	23.1	27.7	100.0	288.0	0





Operation mode	MP4 with Earphone mode
EUT	EB1157, S/N: 358018240001107 - Modification State 0

S/N: 358018240001107 (Memory: Samsung (M/N KM2L9001CM-B518))

Standard : FCC Part 15 Class B  
 Date of test : 01 July,2023 01:35  
 Operator : Yoshiyuki Takahashi  
 Temp, Hum, Atm : 22.8 [°C], 62.0 [%], 977 [hPa]  
 Supply power : DC 3.87 V (Battery)  
 Antenna distance (cm) : 408  
 Antenna height (cm) : 100 - 400

\*\*\*\*\* RADIATED EMISSION \*\*\*\*\*  
 [ 10m Semi-anechoic chamber #1 ]

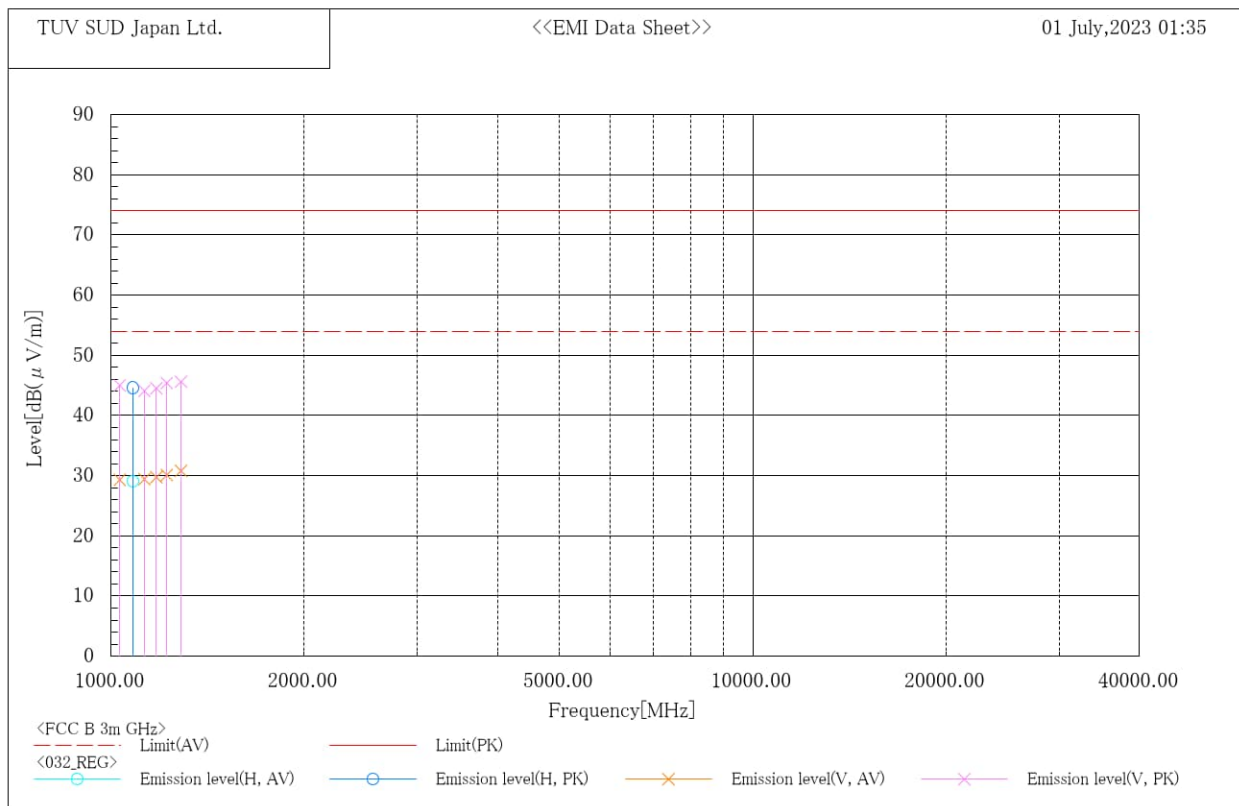

**Final Result**

Frequency MHz	Pol.	Reading dB(μV)		Factor dB(1/m)				Level dB(μV/m)		Limit dB(μV/m)		Margin dB		Height cm	Angle deg	Tilt deg
		AV	PK	CF	TF	PF	DF	AV	PK	AV	PK	AV	PK			
1032.235	V	37.5	53.2	-8.2	27.9	-38.8	2.7	29.3	45.0	54.0	74.0	24.7	29.0	100.0	294.0	0
1081.768	H	37.5	53.0	-8.4	27.7	-38.8	2.7	29.1	44.6	54.0	74.0	24.9	29.4	100.0	185.0	0
1128.496	V	37.5	52.2	-8.1	27.8	-38.6	2.7	29.4	44.1	54.0	74.0	24.6	29.9	100.0	82.0	0
1177.178	V	37.3	52.1	-7.6	28.3	-38.6	2.7	29.7	44.5	54.0	74.0	24.3	29.5	100.0	252.0	0
1222.692	V	37.1	52.4	-7.0	28.7	-38.4	2.7	30.1	45.4	54.0	74.0	23.9	28.6	100.0	124.0	0
1286.695	V	37.0	51.8	-6.2	29.3	-38.2	2.7	30.8	45.6	54.0	74.0	23.2	28.4	100.0	134.0	0



Operation mode	MP4 + USB Read with PC mode
EUT	EB1157, S/N: 358018240001107 - Modification State 0 EB1157, S/N: 358018240018267 - Modification State 0

S/N: 358018240001107 (Memory: Samsung (M/N KM2L9001CM-B518))

Standard : FCC Part 15 Class B  
 Date of test : 01 July,2023 01:35  
 Operator : Yoshiyuki Takahashi  
 Temp, Hum, Atm : 22.8 [°C], 62.0 [%], 977 [hPa]  
 Supply power : AC 120 V, 60 Hz, 1 phase  
 Antenna distance (cm) : 392  
 Antenna height (cm) : 100 - 400

\*\*\*\*\* RADIATED EMISSION \*\*\*\*\*  
 [ 10m Semi-anechoic chamber #1 ]

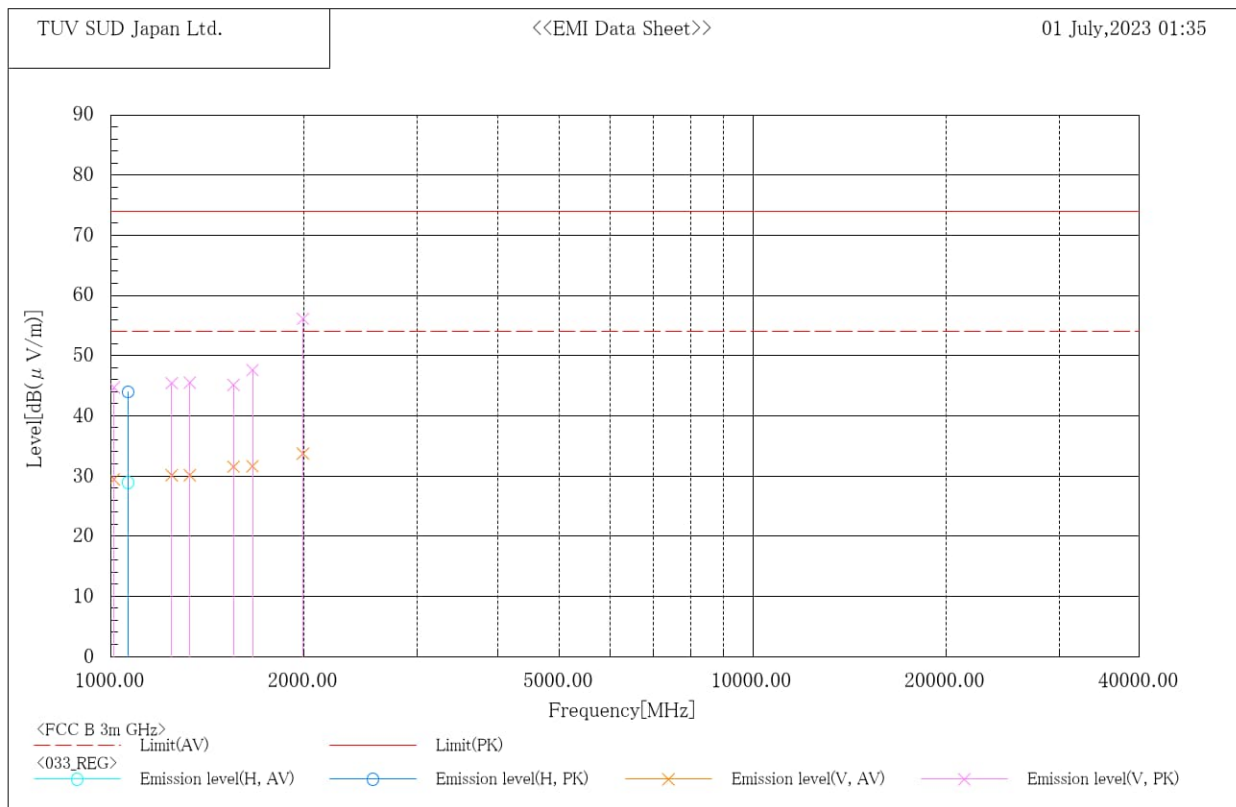

**Final Result**

Frequency MHz	Pol.	Reading		Factor				Level		Limit		Margin		Height cm	Angle deg	Tilt deg
		AV	PK	CF	TF	PF	DF	AV	PK	AV	PK	AV	PK			
1011.497	V	38.0	53.3	-8.6	28.0	-38.9	2.3	29.4	44.7	54.0	74.0	24.6	29.3	100.0	298.0	0
1063.646	H	37.7	52.7	-8.8	27.8	-38.9	2.3	28.9	43.9	54.0	74.0	25.1	30.1	100.0	172.0	0
1244.589	V	37.2	52.5	-7.1	28.9	-38.3	2.3	30.1	45.4	54.0	74.0	23.9	28.6	100.0	61.0	0
1327.517	V	36.9	52.3	-6.8	29.1	-38.2	2.3	30.1	45.5	54.0	74.0	23.9	28.5	100.0	207.0	0
1552.440	V	39.1	52.7	-7.6	27.7	-37.6	2.3	31.5	45.1	54.0	74.0	22.5	28.9	100.0	328.0	0
1662.359	V	37.7	53.7	-6.1	29.0	-37.4	2.3	31.6	47.6	54.0	74.0	22.4	26.4	100.0	152.0	0
1991.403	V	37.2	59.6	-3.5	30.9	-36.7	2.3	33.7	56.1	54.0	74.0	20.3	17.9	100.0	269.0	0





S/N: 358018240018267 (Memory: SK Hynix (M/N: H9QT0GECN6X145))

Standard : FCC Part 15 Class B  
 Date of test : 22 July,2023 13:06  
 Operator : Nobuhiko Iwasawa  
 Temp, Hum, Atm : 23.8 [°C], 52.3 [%], 991 [hPa]  
 Supply power : AC 120 V, 60 Hz, 1 phase  
 Antenna distance (cm) : 392  
 Antenna height (cm) : 100 - 400

\*\*\*\*\* RADIATED EMISSION \*\*\*\*\*  
 [ 10m Semi-anechoic chamber #1 ]

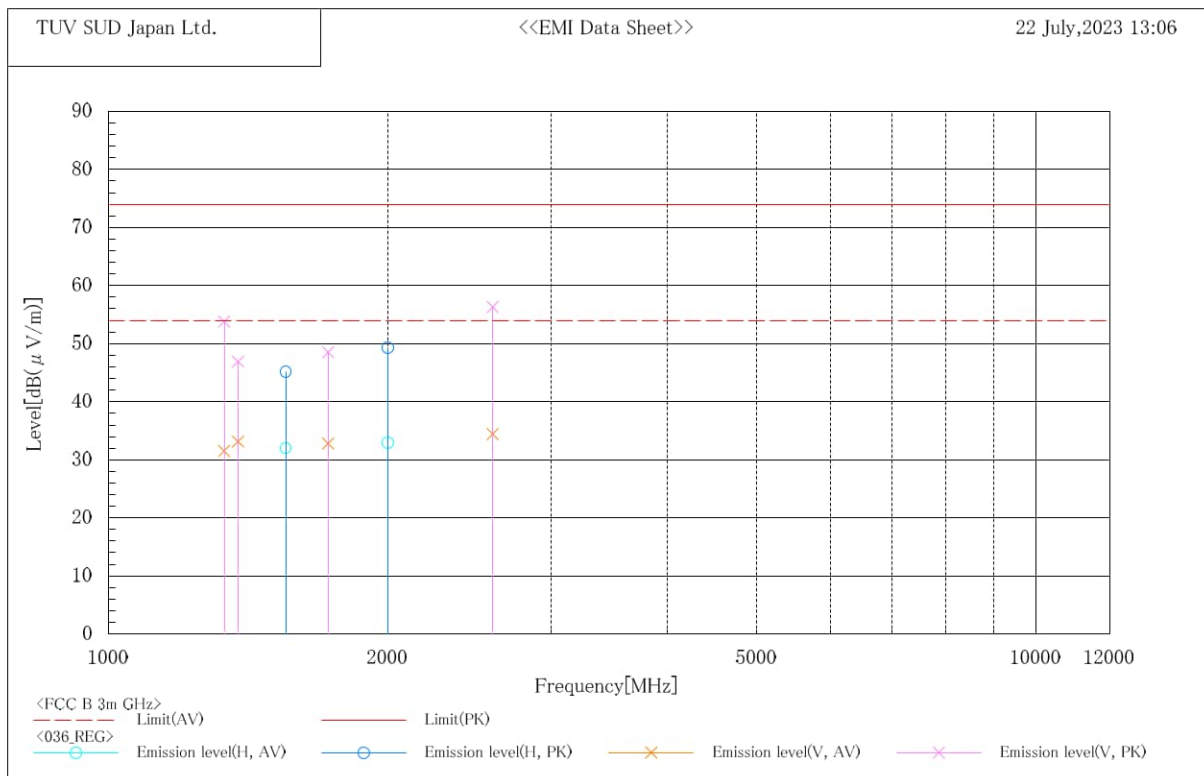





**Final Result**

Frequency MHz	Pol.	Reading dB(μV)		Factor dB(1/m)				Level dB(μV/m)		Limit dB(μV/m)		Margin dB		Height cm	Angle deg	Tilt deg
		AV	PK	CF	TF	PF	DF	AV	PK	AV	PK	AV	PK			
1332.742	V	38.3	60.6	-6.8	29.0	-38.1	2.3	31.5	53.8	54.0	74.0	22.5	20.2	314.0	353.0	34.0
1379.940	V	40.4	54.2	-7.3	28.4	-38.0	2.3	33.1	46.9	54.0	74.0	20.9	27.1	316.0	311.0	34.2
1552.439	H	39.6	52.8	-7.6	27.7	-37.6	2.3	32.0	45.2	54.0	74.0	22.0	28.8	323.0	264.0	34.9
1724.924	V	37.8	53.5	-5.0	30.0	-37.3	2.3	32.8	48.5	54.0	74.0	21.2	25.5	312.0	0.0	33.7
1999.350	H	36.6	52.9	-3.6	30.8	-36.7	2.3	33.0	49.3	54.0	74.0	21.0	24.7	305.0	350.0	32.9
2595.627	V	35.1	57.0	-0.7	32.5	-35.5	2.3	34.4	56.3	54.0	74.0	19.6	17.7	269.0	283.0	28.9

## 5 Measurement Uncertainty

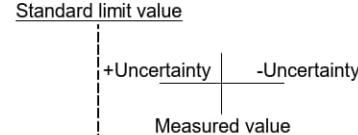
The reported measurement uncertainty is based on a value obtained by multiplying standard uncertainty by coverage factor of  $k=2$ , and a level of confidence becomes 95 %.

Item	Parameter	$U_{lab}$	$U_{cispr}$
Conducted Emission, V-AMN	9kHz to 150kHz	$\pm 3.7$ dB	$\pm 3.8$ dB
Conducted Emission, V-AMN	150kHz to 30MHz	$\pm 3.3$ dB	$\pm 3.4$ dB
Conducted Emission, $\Delta$ -AN	150kHz to 30MHz	$\pm 4.9$ dB	-
Conducted Emission, AN	150kHz to 30MHz	$\pm 4.3$ dB	-
Conducted Emission, AAN	150kHz to 30MHz	$\pm 4.8$ dB	$\pm 5.0$ dB
Conducted Emission, Voltage Probe	9kHz to 30MHz	$\pm 2.8$ dB	$\pm 2.9$ dB
Conducted Emission, Current Probe	150kHz to 30MHz	$\pm 2.9$ dB	$\pm 2.9$ dB
Disturbance Power	30MHz to 300MHz	$\pm 3.8$ dB	$\pm 4.5$ dB
Radiated Emission	30MHz to 1000MHz	$\pm 5.5$ dB	$\pm 6.3$ dB
Radiated Emission	1GHz to 6GHz	$\pm 4.9$ dB	$\pm 5.2$ dB
Radiated Emission	6GHz to 18GHz	$\pm 4.7$ dB	$\pm 5.5$ dB
Radiated Emission	9kHz to 30MHz	$\pm 3.2$ dB	-

Judge	Measured value and standard limit value	
PASS	<p><b>Case1</b></p>  <p>+Uncertainty   -Uncertainty Measured value</p>	Even if it takes uncertainty into consideration, a standard limit value is fulfilled.
	<p><b>Case2</b></p> 	Although measured value is in a standard limit value, a limit value won't be fulfilled if uncertainty is taken into consideration.
FAIL	<p><b>Case3</b></p> 	Although measured value exceeds a standard limit value, a limit value will be fulfilled if uncertainty is taken into consideration.
	<p><b>Case4</b></p> 	Even if it takes uncertainty into consideration, a standard limit value isn't fulfilled.



Japan

## 6 Laboratory Information

Testing was performed and the report was issued at:

**TÜV SÜD Japan Ltd. Yonezawa Testing Center**

Address: 5-4149-7 Hachimanpara, Yonezawa-shi, Yamagata, 992-1128 Japan

Phone: +81-238-28-2881

### Accreditation and Registration

A2LA

Certificate #3686.03

VLAC

Accreditation No.: VLAC-013

BSMI

Laboratory Code: SL2-IN-E-6018, SL2-A1-E-6018

Innovation, Science and Economic Development Canada

ISED#: 4224A

VCCI Council

Registration number: A-0166

## Appendix A. Test Equipment

### Conducted emission at mains port

Equipment	Company	Model No.	Serial No.	Cal. due	Cal. Date
EMI receiver	ROHDE&SCHWARZ	ESR7	102352	31-Dec-2023	26-Dec-2022
Line impedance stabilization network	Kyoritsu Technology Corporation	TNW-407F2	12-17-110-1	30-Jun-2023	15-Jun-2022
Attenuator	TYC	BA-PJ-10	N/A(S347)	31-Dec-2023	21-Dec-2022
Coaxial cable	FUJIKURA	5D-2W/5m	N/A(S336)	29-Feb-2024	21-Feb-2023
Microwave cable	HUBER+SUHNER	SUCOFLEX106/28m	501941/6	29-Feb-2024	21-Feb-2023
Microwave cable	HUBER+SUHNER	SUCOFLEX104/2m	MY15570/4	29-Feb-2024	20-Feb-2023
Software	TOYO Technica	ES10/CE-AJ	Ver.2023.01.001	N/A	N/A

### Radiated emission (below 1 GHz)

[Date of test: 28-Jun-2023 - 29-Jun-2023]

Equipment	Company	Model No.	Serial No.	Cal. due	Cal. date
EMI receiver	ROHDE&SCHWARZ	ESR7	102352	31-Dec-2023	26-Dec-2022
Biconical antenna	Schwarzbeck	VHBB9124/BBA9106	1145	30-Jun-2023	28-Jun-2022
Log-periodic antenna	Schwarzbeck	VUSLP9111B	343	30-Sep-2023	07-Sep-2022
Attenuator	TDC	TAT-43B-03	N/A(S396)	31-Oct-2023	26-Oct-2022
Attenuator	TOYO Connector	NA-PJ-6	N/A(S549)	30-Sep-2023	28-Sep-2022
Microwave cable	HUBER+SUHNER	SUCOFLEX104/1m	SN MY20467/6	29-Feb-2024	20-Feb-2023
Microwave cable	HUBER+SUHNER	SUCOFLEX104/9m	811447/4	29-Feb-2024	20-Feb-2023
Microwave cable	HUBER+SUHNER	SUCOFLEX106/10m	501942/6	29-Feb-2024	20-Feb-2023
Microwave cable	HUBER+SUHNER	SUCOFLEX104/2m	MY34424/4	29-Feb-2024	20-Feb-2023
Preamplifier	SONOMA	310	400316	31-Mar-2024	16-Mar-2023
10m Semi-anechoic Chamber	TOKIN	N/A	N/A(9005-NSA3m/TTφ3m)	31-Oct-2023	02-Oct-2022
Software	TOYO Corporation	ES10/RE-AJ	Ver.2023.01.001	N/A	N/A

### Radiated emission (below 1 GHz)

[Date of test: 22-Jul-2023]

Equipment	Company	Model No.	Serial No.	Cal. due	Cal. date
EMI receiver	ROHDE&SCHWARZ	ESR7	102352	31-Dec-2023	26-Dec-2022
Biconical antenna	Schwarzbeck	VHBB9124/BBA9106	1344	30-Jun-2024	19-Jun-2023
Log-periodic antenna	Schwarzbeck	VUSLP9111B	343	30-Sep-2023	07-Sep-2022
Attenuator	TDC	TAT-43B-03	N/A(S396)	31-Oct-2023	26-Oct-2022
Attenuator	TOYO Connector	NA-PJ-6	N/A(S549)	30-Sep-2023	28-Sep-2022
Microwave cable	HUBER+SUHNER	SUCOFLEX104/1m	SN MY20467/6	29-Feb-2024	20-Feb-2023
Microwave cable	HUBER+SUHNER	SUCOFLEX104/9m	811447/4	29-Feb-2024	20-Feb-2023
Microwave cable	HUBER+SUHNER	SUCOFLEX106/10m	501942/6	29-Feb-2024	20-Feb-2023
Microwave cable	HUBER+SUHNER	SUCOFLEX104/2m	MY34424/4	29-Feb-2024	20-Feb-2023
Preamplifier	SONOMA	310	400316	31-Mar-2024	16-Mar-2023
10m Semi-anechoic Chamber	TOKIN	N/A	N/A(9005-NSA3m/TTφ3m)	31-Oct-2023	02-Oct-2022
Software	TOYO Corporation	ES10/RE-AJ	Ver.2023.01.001	N/A	N/A



**Radiated emission (above 1 GHz)**  
**[Date of test: 30-Jun-2023 - 01-Jul-2023]**

Equipment	Company	Model No.	Serial No.	Cal. due	Cal. date
Signal Spectrum Analyzer	ROHDE&SCHWARZ	FSW85	101572	31-Oct-2023	21-Oct-2022
Low Noise Pre Amplifier	TSJ	MLA-0118-J02-40	19326	31-Dec-2023	22-Dec-2022
Preamplifier	TSJ	MLA-1840-B03-35	1240332	31-Aug-2023	19-Aug-2022
Double ridged guide antenna	ETS LINDGREN	3117	00143141	31-Jul-2023	19-Jul-2022
DRGH antenna	A.H.Systems Inc.	SAS-574	469	31-Aug-2023	19-Aug-2022
Attenuator	HUBER+SUHNER	6803.17.B	N/A(2341)	31-Dec-2023	22-Dec-2022
Microwave cable	HUBER+SUHNER	SUCOFLEX104/1m	MY38347/4	29-Feb-2024	20-Feb-2023
Microwave cable	HUBER+SUHNER	SUCOFLEX104/9m	811446/4	29-Feb-2024	20-Feb-2023
Microwave cable	HUBER+SUHNER	SUCOFLEX106/10m	501942/6	29-Feb-2024	20-Feb-2023
Microwave cable	HUBER+SUHNER	SUCOFLEX104/2m	MY34424/4	29-Feb-2024	20-Feb-2023
Microwave cable	HUBER SUNER	Sucoflex 102/5m	31647	31-Jul-2023	15-Jul-2022
Absorber	NEC TOKIN	TFA	N/A	N/A	N/A
10m Semi-anechoic Chamber	TOKIN	N/A	N/A(9005-SVSWR/TTφ3m)	31-Oct-2023	02-Oct-2022
Software	TOYO Technica	ES10/RE-AJ	Ver.2023.01.001	N/A	N/A

**Radiated emission (above 1 GHz)**  
**[Date of test: 22-Jul-2023]**

Equipment	Company	Model No.	Serial No.	Cal. due	Cal. date
Spectrum analyzer	ROHDE&SCHWARZ	FSV40	101732	30-Apr-2024	07-Apr-2023
Low Noise Pre Amplifier	TSJ	MLA-0118-J02-40	19326	31-Dec-2023	22-Dec-2022
Preamplifier	TSJ	MLA-1840-B03-35	1240332	31-Aug-2023	19-Aug-2022
Double ridged guide antenna	ETS LINDGREN	3117	00143141	31-Jul-2023	19-Jul-2022
DRGH antenna	A.H.Systems Inc.	SAS-574	469	31-Aug-2023	19-Aug-2022
Attenuator	HUBER+SUHNER	6803.17.B	N/A(2341)	31-Dec-2023	22-Dec-2022
Microwave cable	HUBER+SUHNER	SUCOFLEX104/1m	MY38347/4	29-Feb-2024	20-Feb-2023
Microwave cable	HUBER+SUHNER	SUCOFLEX104/9m	811446/4	29-Feb-2024	20-Feb-2023
Microwave cable	HUBER+SUHNER	SUCOFLEX106/10m	501942/6	29-Feb-2024	20-Feb-2023
Microwave cable	HUBER+SUHNER	SUCOFLEX104/2m	MY34424/4	29-Feb-2024	20-Feb-2023
Microwave cable	HUBER SUNER	Sucoflex 102/5m	31647	31-Jul-2023	15-Jul-2022
Absorber	NEC TOKIN	TFA	N/A	N/A	N/A
10m Semi-anechoic Chamber	TOKIN	N/A	N/A(9005-SVSWR/TTφ3m)	31-Oct-2023	02-Oct-2022
Software	TOYO Technica	ES10/RE-AJ	Ver.2023.01.001	N/A	N/A