

Report on the RF Testing of:

KYOCERA Corporation
Mobile Phone, Model: EB1157
FCC ID: JOYEB1157

In accordance with FCC Part 22 Subpart H

Prepared for: KYOCERA Corporation
Yokohama Office 2-1-1 Kagahara, Tsuzuki-ku
Yokohama-shi, Kanagawa, Japan
Phone: +81-45-943-6253 Fax: +81-45-943-6314



Japan

Add value.
Inspire trust.

COMMERCIAL-IN-CONFIDENCE

Document Number: JPD-TR-23083-0

SIGNATURE

NAME	JOB TITLE	RESPONSIBLE FOR	ISSUE DATE
Hiroaki Suzuki	Deputy Manager of RF Group	Approved Signatory	2023.08.18

Signatures in this approval box have checked this document in line with the requirements of TÜV SÜD Japan Ltd. document control rules.

EXECUTIVE SUMMARY - Result: Complied

A sample(s) of this product was tested and the result above was confirmed in accordance with FCC Part 22 Subpart H.



DISCLAIMER AND COPYRIGHT

The results in this report are applicable only to the equipment tested.
This report shall not be re-produced except in full without the written approval of TÜV SÜD Japan Ltd.
Client provided data, for which TÜV SÜD Japan Ltd. take no responsibility, which can affect validity of results within this report is clearly identified.

ACCREDITATION

This test report must not be used by the client to claim product certification, approval, or endorsement by A2LA or any agency of the U.S. Government.

TÜV SÜD Japan Ltd.
Yonezawa Testing Center
5-4149-7 Hachimanpara,
Yonezawa-shi, Yamagata,
992-1128 Japan

Phone: +81 (0) 238 28 2881
www.tuvsud.com/ja-jp

Contents

1	Summary of Test	3
1.1	Modification history of the test report.....	3
1.2	Standards.....	3
1.3	Test methods.....	3
1.4	Deviation from standards.....	3
1.5	List of applied test(s) of the EUT.....	3
1.6	Test information.....	3
1.7	Test set up.....	3
1.8	Test period.....	3
2	Equipment Under Test	4
2.1	EUT information.....	4
2.2	Modification to the EUT.....	5
2.3	Variation of family model(s).....	5
2.4	Description of test mode.....	5
3	Configuration of Equipment	6
3.1	Equipment used.....	6
3.2	System configuration.....	6
4	Test Result	7
4.1	Effective Radiated Power.....	7
4.2	Occupied Bandwidth.....	10
4.3	Band Edge Spurious and Harmonic at Antenna Terminals.....	14
4.4	Radiated Emissions and Harmonic Emissions.....	25
4.5	Frequency Stability.....	28
5	Measurement Uncertainty	30
6	Laboratory Information	31
	Appendix A. Test Equipment	32

1 Summary of Test

1.1 Modification history of the test report

Document Number	Modification History	Issue Date
JPD-TR-23083-0	First Issue	Refer to the cover page

1.2 Standards

CFR47 FCC Part 22 Subpart H

1.3 Test methods

KDB 971168 D01 Power Meas License Digital Systems v03r01
ANSI/TIA/EIA 603-E-2016
ANSI C63.26-2015

1.4 Deviation from standards

None

1.5 List of applied test(s) of the EUT

Test item section	Test item	Condition	Result	Remark
2.1046	Conducted Output Power	Conducted	PASS	*1
22.913(a)	Effective Radiated Power	Radiated	PASS	-
22.917(a) 2.1049	Occupied Bandwidth	Conducted	PASS	-
22.917(a) 2.1051	Band Edge Spurious and Harmonic at Antenna Terminal	Conducted	PASS	-
22.917(a) 2.1053	Radiated emissions and Harmonic Emissions	Radiated	PASS	-
22.355 2.1055	Frequency Stability	Conducted	PASS	-

*1: Refer to RF Exposure Report (Test Report_SAR)

1.6 Test information

None

1.7 Test set up

Table-top

1.8 Test period

21-June-2023 - 27-July-2023

2 Equipment Under Test

All information in this chapter was provided by the applicant.

2.1 EUT information

Applicant	KYOCERA Corporation Yokohama Office 2-1-1 Kagahara, Tsuzuki-ku Yokohama-shi, Kanagawa, Japan Phone: +81-45-943-6253 Fax: +81-45-943-6314
Equipment Under Test (EUT)	Mobile Phone
Model number	EB1157
Serial number	358018240001222, 358018240001032, 358018240001040
Trade name	Kyocera
Number of sample(s)	3
EUT condition	Pre-Production
Power rating	Battery: DC 3.87 V
Size	(W) 75 mm x (D) 14.6 mm x (H) 154 mm
Environment	Indoor and Outdoor use
Terminal limitation	-20°C to 60°C
Hardware version	Pre-Production
Software version	0.130RI
Firmware version	Not applicable
RF Specification	
Frequency of Operation	Up Link GSM850: 824.2-848.8 MHz WCDMA Band V: 826.4-846.6 MHz Down Link GSM850: 869.2-893.8 MHz WCDMA Band V: 871.4-891.6 MHz
Modulation type	GSM850: GMSK WCDMA Band V: QPSK, 16QAM
Emission designator	GSM850: 243KGXW WCDMA Band V: 4M14F9W
Effective Radiated Power (E.R.P.)	GSM850: 2.512 W (34.0 dBm) WCDMA Band V: 0.288 W (24.6 dBm)
Antenna type	Internal antenna
Antenna gain	GSM850: -2.0 dBi WCDMA Band V: -2.0 dBi

2.2 Modification to the EUT

The table below details modifications made to the EUT during the test project.

Modification State	Description of Modification	Modification fitted by	Date of Modification
Model: EB1157, Serial Number: 358018240001222, 358018240001032, 358018240001040			
0	As supplied by the applicant	Not Applicable	Not Applicable

2.3 Variation of family model(s)

2.3.1 List of family model(s)

EB1135 has model with camera and without camera.

2.3.2 Reason for selection of EUT

Not applicable

2.4 Description of test mode

The EUT had been tested under operating condition.
There are three channels have been tested as following:

Band	Channel	Frequency [MHz]
GSM850	128	824.2
	190	836.6
	251	848.8
WCDMA Band V	4132	826.4
	4183	836.6
	4233	846.6

The field strength of spurious emissions was measured at each position of all three axis X, Y and Z to compare the level, and the maximum noise.

The worst emission was found in Z-axis (All Bands), and the worst case recorded.

Pre-scan has been conducted to determine the worst-case mode from all possible combinations between available modulations, data rates and antenna ports.

3 Configuration of Equipment

Numbers assigned to equipment on the diagram in “3.2 System configuration” correspond to the list in “3.1 Equipment used”.

This test configuration is based on the manufacture’s instruction.

Cabling and setup(s) were taken into consideration and test data was taken under worse case condition.

3.1 Equipment used

No.	Equipment	Company	Model No.	Serial No.	FCC ID/DoC	Comment
1	Mobile Phone	KYOCERA	EB1157	358018240001222, 358018240001032, 358018240001040	JOYEB1157	EUT

3.2 System configuration

1. Mobile Phone
(EUT)

4 Test Result

4.1 Effective Radiated Power

4.1.1 Measurement procedure

[FCC 22.913(a)]

<Step 1>

The EUT and support equipment are placed on a 1 meter x 1 meter surface, 0.8 meter height styrene foam table. Radiated emission measurements are performed at 3 meter distance with the broadband antenna (Log periodic antenna). The antenna is positioned both the horizontal and vertical planes of polarization and height is varied 1 to 4 meters and stopped at height producing the maximum emission.

The turntable is rotated by 360 degrees and stopped at azimuth of producing the maximum emission.

<Step 2>

The substitution antenna is replaced by the transmitter antenna (EUT).

The frequency of the signal generator is adjusted to the measurement frequency.

Level of the signal generator is adjusted to the level that is obtained from step 1, and record the emission level of signal generator.

The spectrum analyzer is set to;

- Span = 1.5 times the OBW
- RBW = 1-5% of the expected OBW, not to exceed 1 MHz
- VBW $\geq 3 \times$ RBW
- Number of sweep points $\geq 2 \times$ span / RBW
- Sweep time = auto-couple
- Detector = RMS (power averaging)
- If the EUT can be configured to transmit continuously (i.e., burst duty cycle $\geq 98\%$), then set the trigger to free run.
- If the EUT cannot be configured to transmit continuously (i.e., burst duty cycle $< 98\%$), then use a sweep trigger with the level set to enable triggering only on full power bursts and configure the EUT to transmit at full power for the entire duration of each sweep. Ensure that the sweep time is less than or equal to the transmission burst duration.
- Trace average at least 100 traces in power averaging (i.e., RMS) mode.
- Compute the power by integrating the spectrum across the OBW of the signal using the instrument's band power measurement function, with the band limits set equal to the OBW band edges. If the instrument does not have a band power function, then sum the spectrum levels (in linear power units) at intervals equal to the RBW extending across the entire OBW of the spectrum.

- Test configuration

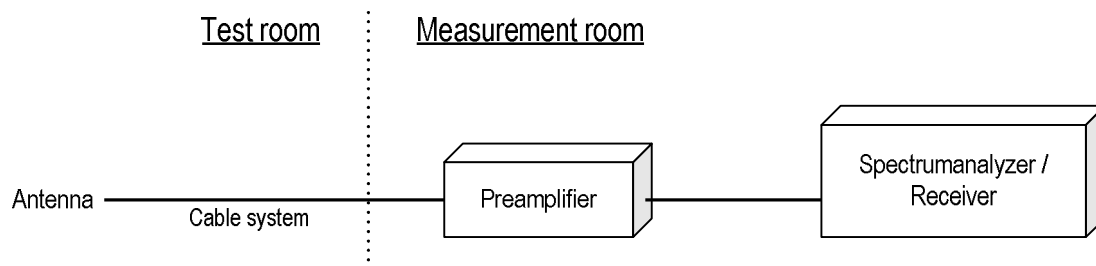



4.1.2 Calculation method

Result (ERP) = Ant. Input - Cable loss + Antenna Gain

Margin = Limit – Result (ERP)

Example:

Limit @ 836.6 MHz : 38.45 dBm

Ant. Input = 40.0 dBm Cable loss = 0.8 dB Ant. Gain = -6.7 dBd

Result = 40.0 - 0.8 + (-6.7) = 32.5 dBm

Margin = 38.45 – 32.5 = 5.95 dB

4.1.3 Limit

7 W (38.45 dBm)

4.1.4 Test data

Date : 21~22-June-2023
 Temperature : 24.0 [°C]
 Humidity : 49.4 [%]
 Test place : 3m Semi-anechoic chamber

Test engineer : Chiaki Kanno

Date : 22-June-2023
 Temperature : 22.1 [°C]
 Humidity : 56.2 [%]
 Test place : 3m Semi-anechoic chamber

Test engineer : Chiaki Kanno

[GSM850]

H/V	Frequency [MHz]	S.A Reading [dBm]	Ant. Input [dBm]	Cable loss [dB]	Ant.Gain [dBd]	Result [dBm]	Result [W]	Limit [dBm]	Margin [dB]
H	824.2	-31.7	40.9	1.1	-6.3	33.6	2.291	38.45	4.9
H	836.6	-31.3	41.4	1.1	-6.3	34.0	2.512	38.45	4.5
H	848.8	-32.2	41.1	1.1	-6.3	33.7	2.344	38.45	4.8

[WCDMA Band V]

H/V	Frequency [MHz]	S.A Reading [dBm]	Ant. Input [dBm]	Cable loss [dB]	Ant.Gain [dBd]	Result [dBm]	Result [W]	Limit [dBm]	Margin [dB]
H	826.4	-32.1	31.5	1.1	-6.3	24.2	0.263	38.45	14.3
H	836.6	-31.6	32.0	1.1	-6.3	24.6	0.288	38.45	13.9
H	846.6	-31.9	32.0	1.1	-6.3	24.6	0.288	38.45	13.9

4.2 Occupied Bandwidth

4.2.1 Measurement procedure

[FCC 22.917(a), 2.1049]

The Occupied bandwidth was measured with a spectrum analyzer connected to the antenna terminal. The spectrum analyzer's automatic bandwidth measurement capability was used to perform the 99% occupied bandwidth and the 26dB bandwidth.

The spectrum analyzer is set to;

- a) RBW = 1-5% of the expected OBW & VBW $\geq 3 \times$ RBW
- b) Detector = Peak
- c) Trace mode = Max hold
- d) Sweep time = auto-couple

- Test configuration

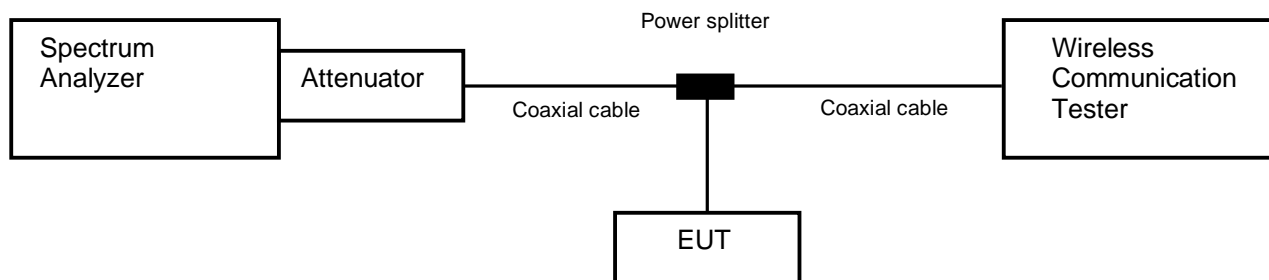

4.2.2 Limit

None



Japan

4.2.3 Measurement result

Date : 26-July-2023
 Temperature : 23.6 [°C]
 Humidity : 55.9 [%]
 Test place : Shielded room No.4

Test engineer : Kazunori Saito

Band	Channel	Frequency (MHz)	Test Result (kHz)
GSM850	128	824.2	242.4469
	190	836.6	241.7768
	251	848.8	242.8998
WCDMA Band V	4132	826.4	4126.0
	4183	836.6	4128.0
	4233	846.6	4135.8



4.2.4 Trace data

[GSM850]

Channel: 128

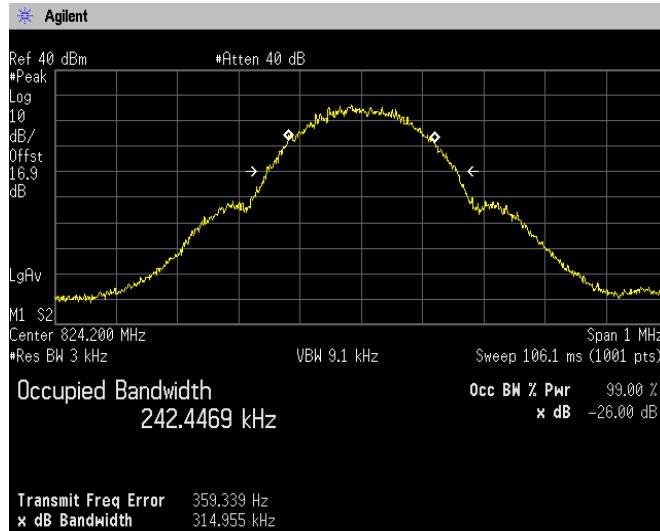

Channel: 190

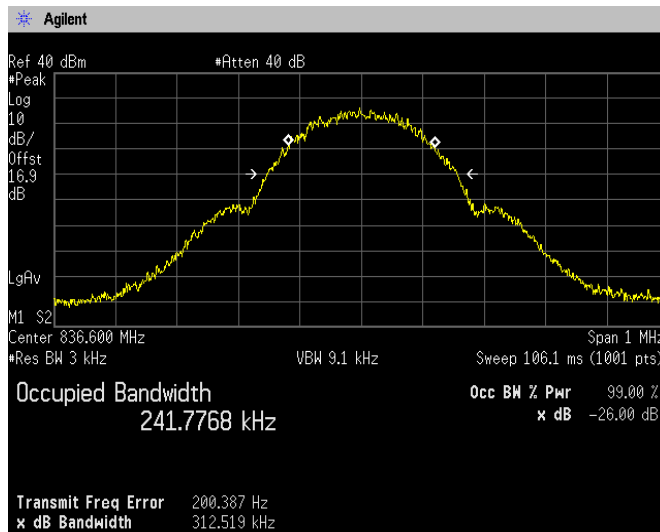

Channel: 251

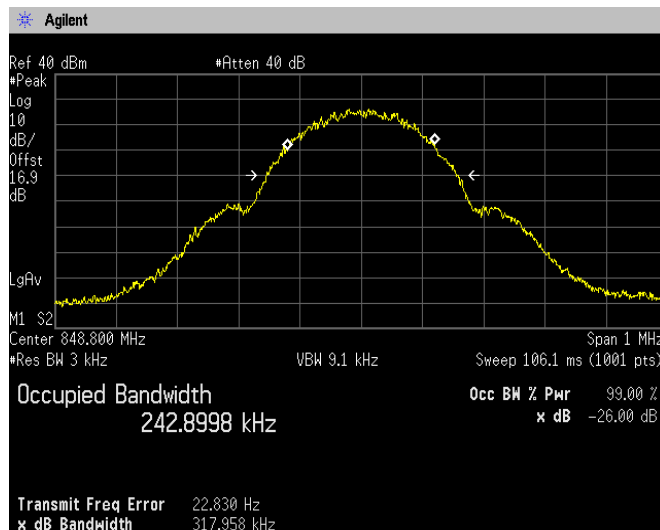

**[WCDMA Band V]
Channel: 4132**

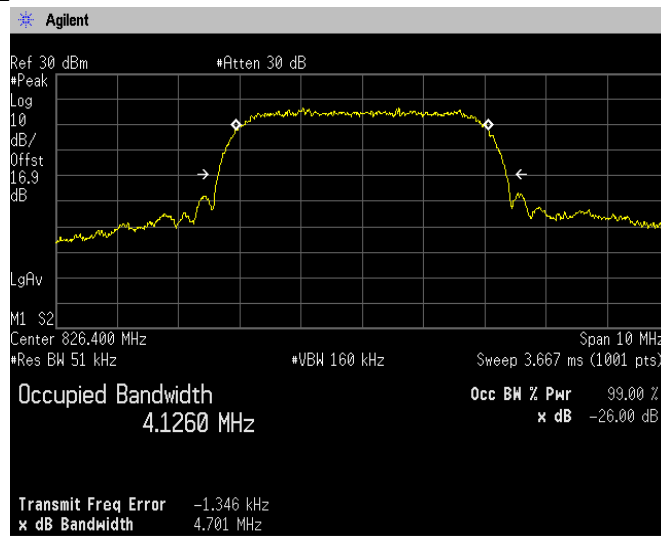

Channel: 4183

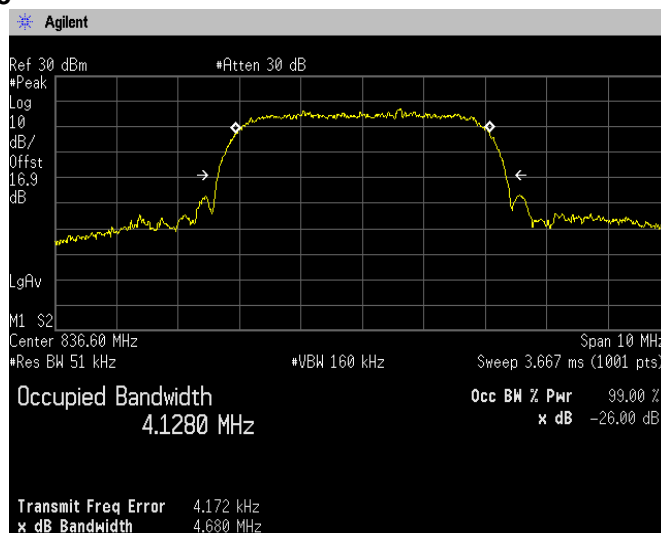

Channel: 4233

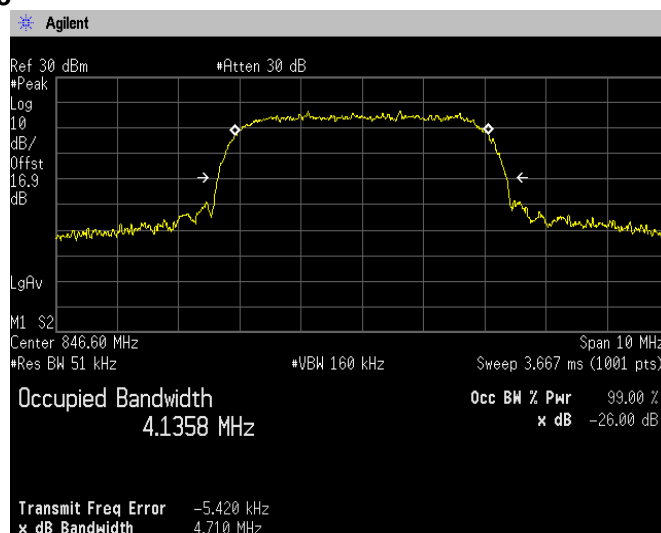

4.3 Band Edge Spurious and Harmonic at Antenna Terminals

4.3.1 Measurement procedure

[FCC 22.917(a), 2.1051]

The band edge spurious and harmonic was measured with a spectrum analyzer connected to the antenna terminal.

The spectrum analyzer is set to;

<Band Edge>

- Span was set large enough so as to capture all out of band emissions near the band edge
- RBW $\geq 1\%$ of the emission bandwidth or 2% of the emission bandwidth
- VBW $\geq 3 \times$ RBW
- Detector = RMS
- Trace mode = Max hold
- Sweep time = auto-couple
- Number of sweep point $\geq 2 \times$ span / RBW

<Spurious Emissions>

- RBW = 1MHz & VBW $\geq 3 \times$ RBW
- Detector = Peak
- Trace mode = Max hold
- Sweep time = auto-couple
- Number of sweep point $\geq 2 \times$ span / RBW

- Test configuration

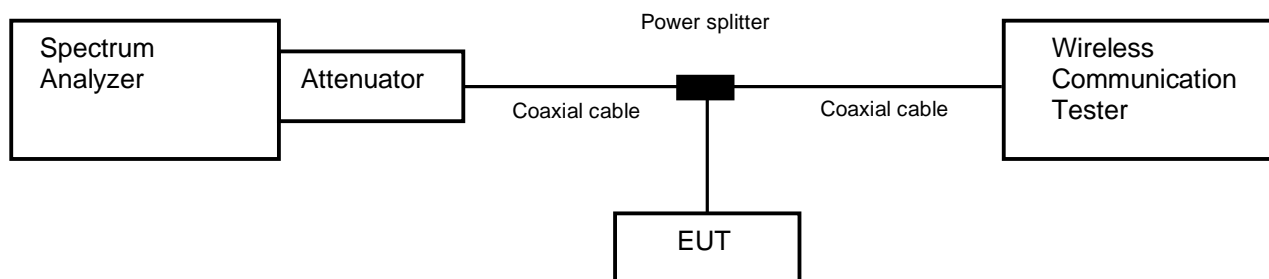

4.3.2 Limit

-13 dBm or less

4.3.3 Measurement result

Date : 26-July-2023
Temperature : 23.6 [°C]
Humidity : 55.9 [%]
Test place : Shielded room No.4

Test engineer : Kazunori Saito

Band	Channel	Frequency [MHz]	Limit [dBm]	Results	
GSM850	128	824.2	-13.0	See the trace data	PASS
	190	836.6	-13.0	See the trace data	PASS
	251	848.8	-13.0	See the trace data	PASS
WCDMA Band V	4132	826.4	-13.0	See the trace data	PASS
	4183	836.6	-13.0	See the trace data	PASS
	4233	846.6	-13.0	See the trace data	PASS

4.3.4 Trace data

[GSM850]
(Band Edge)

Channel: 128

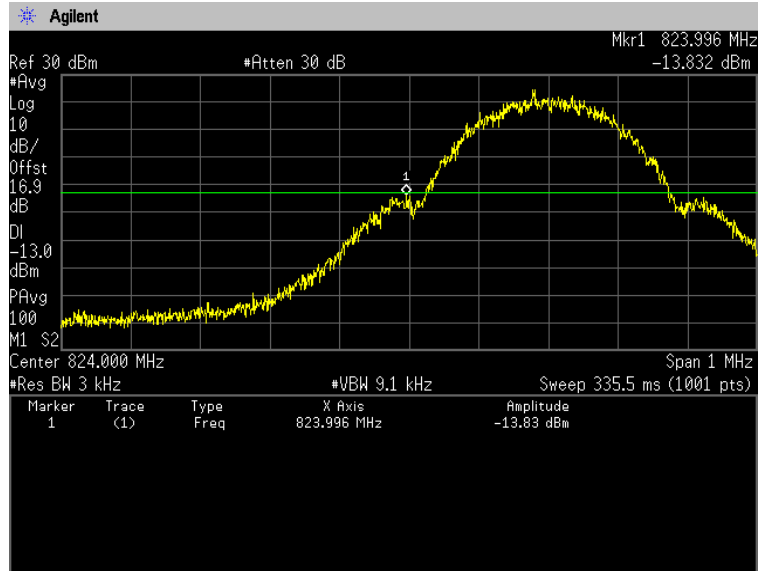

Channel: 251

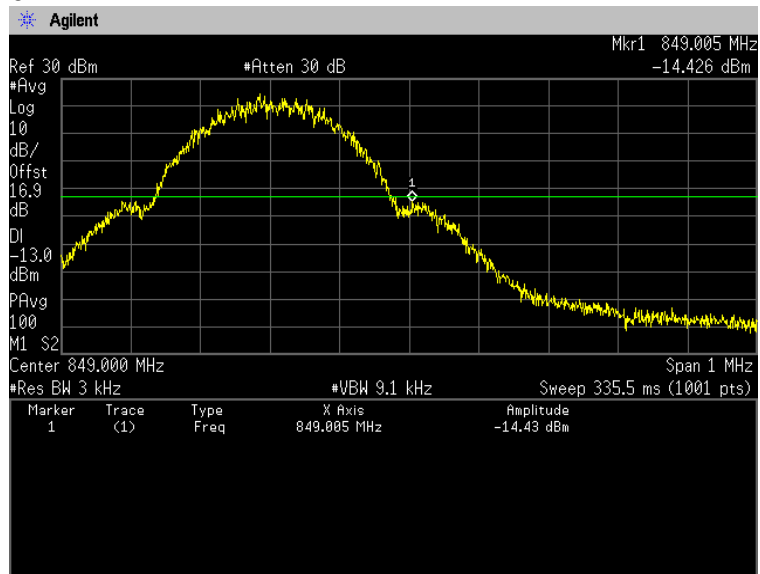



Japan

(Spurious Emissions)

Note: Conducted spurious test was measured in the worst case of conducted output power.

**Channel: 128
30MHz-5GHz**

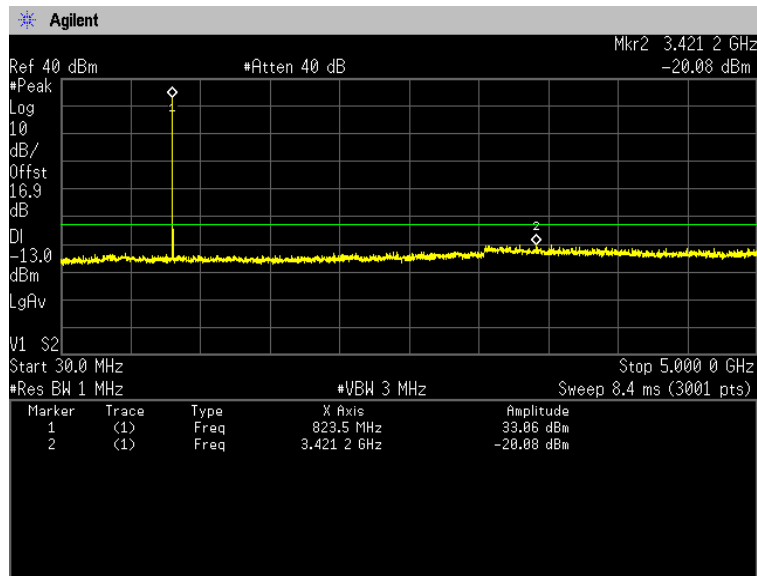

5GHz-10GHz

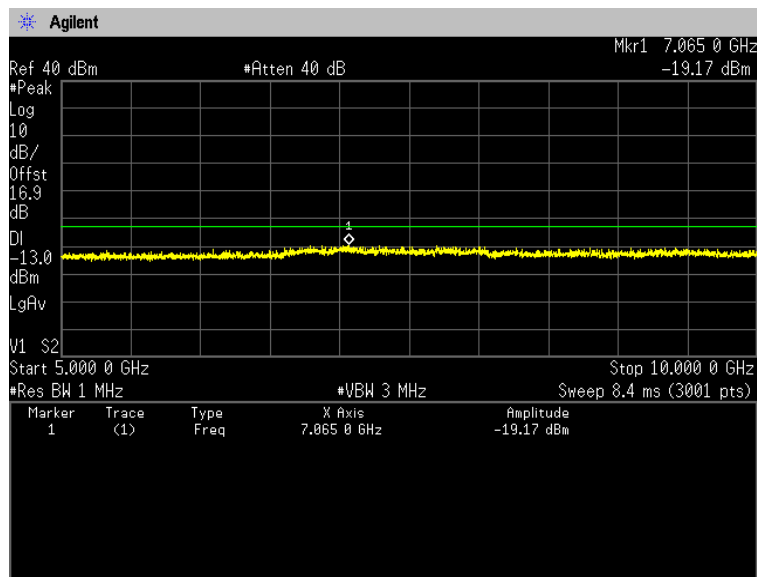



Japan

**Channel: 190
30MHz-5GHz**

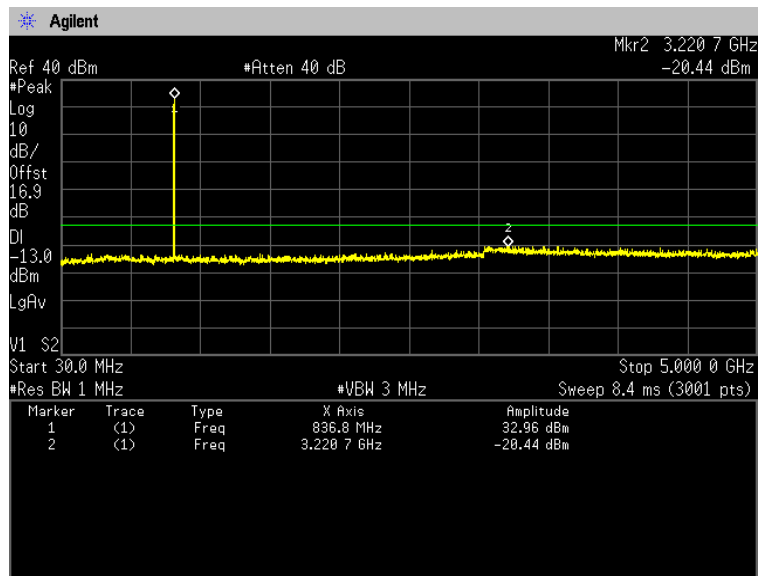

5GHz-10GHz

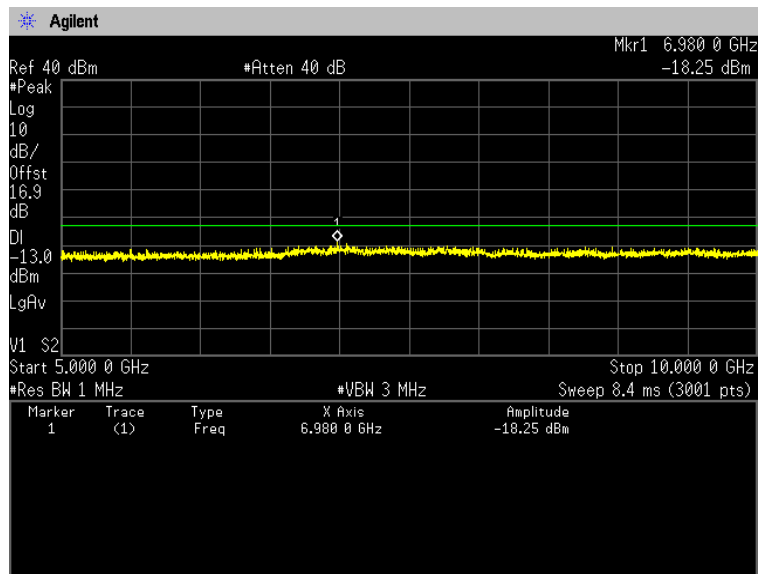



Japan

**Channel: 251
30MHz-5GHz**

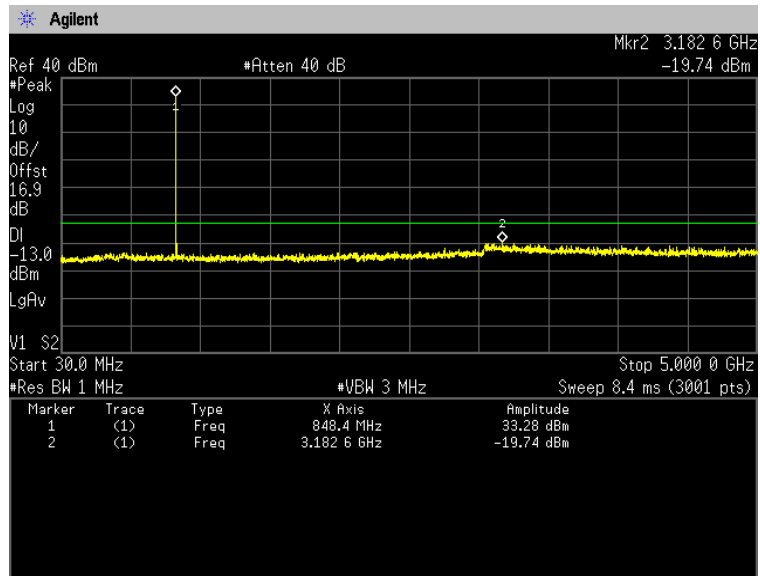

5GHz-10GHz

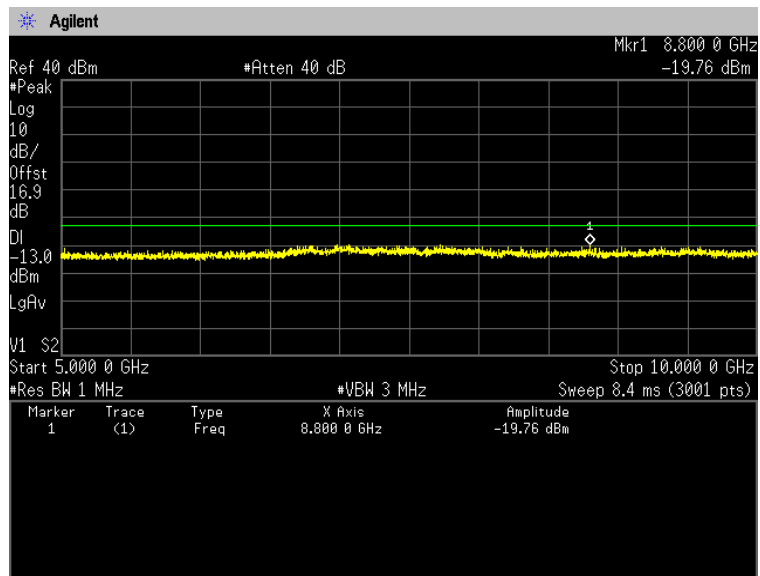



**[WCDMA Band V]
(Band Edge)**

Channel: 4132

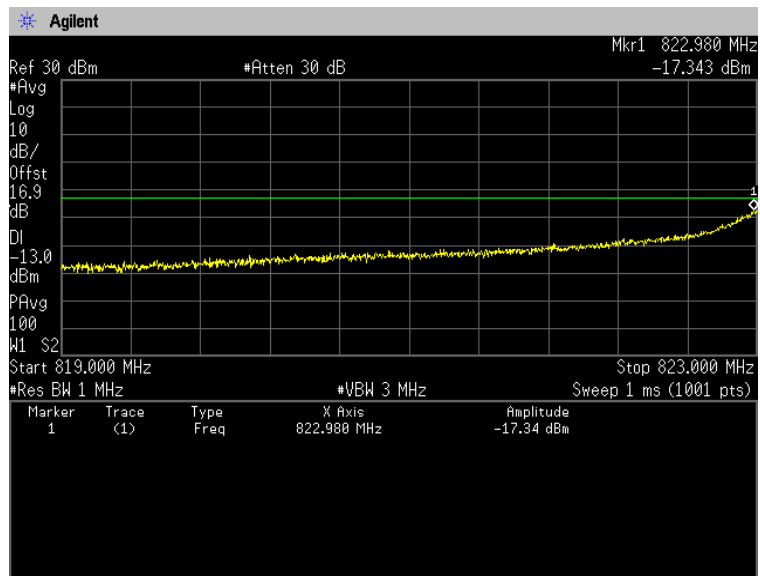
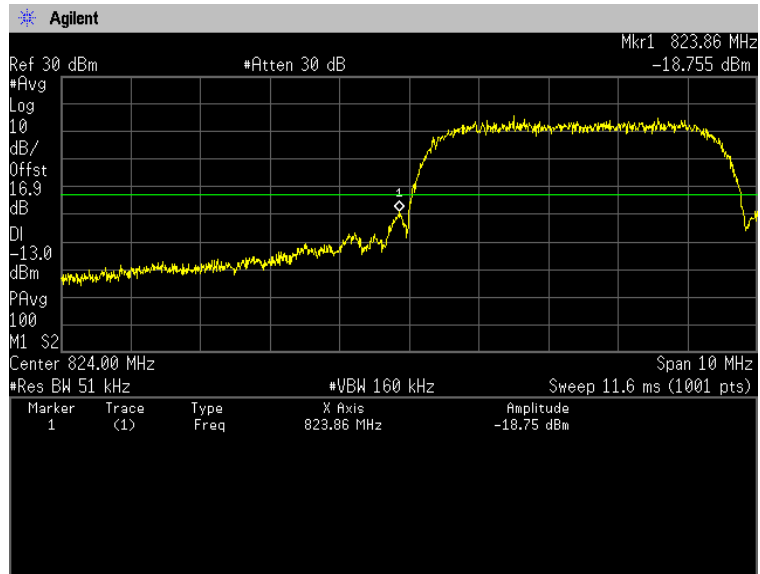



Japan

Channel: 4233

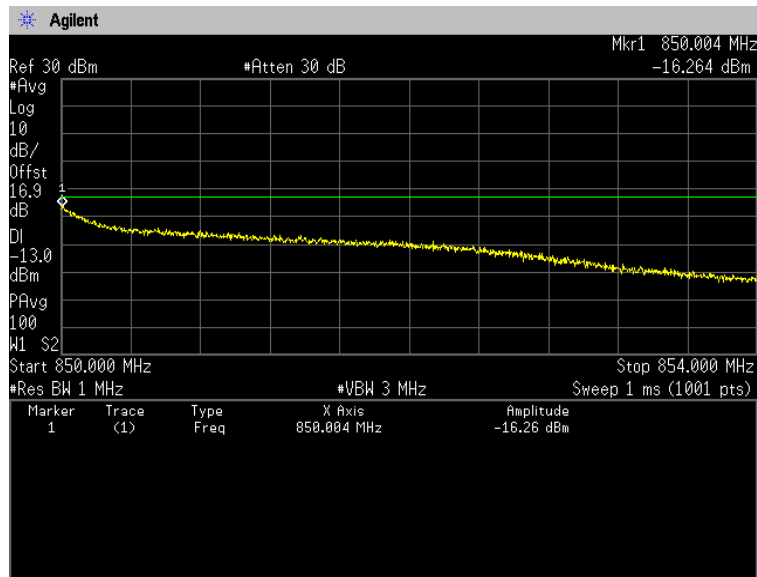
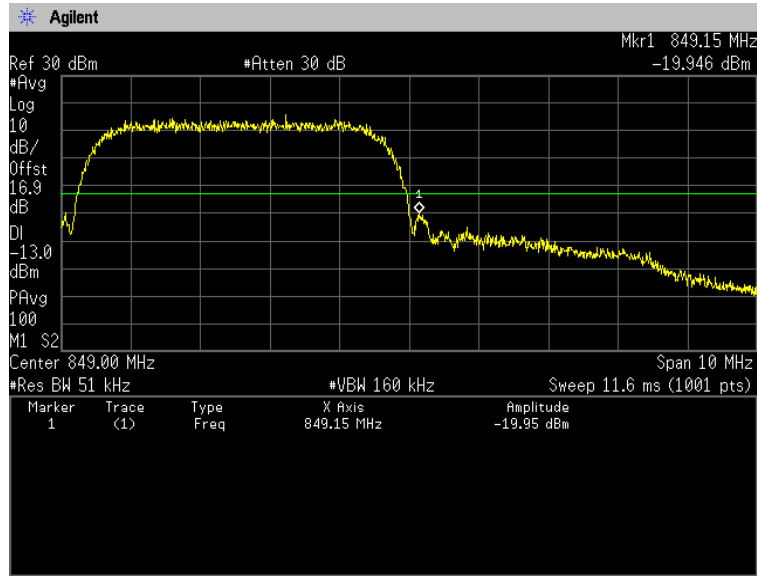

(Spurious Emissions)

Note: Conducted spurious test was measured in the worst case of conducted output power.

**Channel: 4132
30MHz-5GHz**

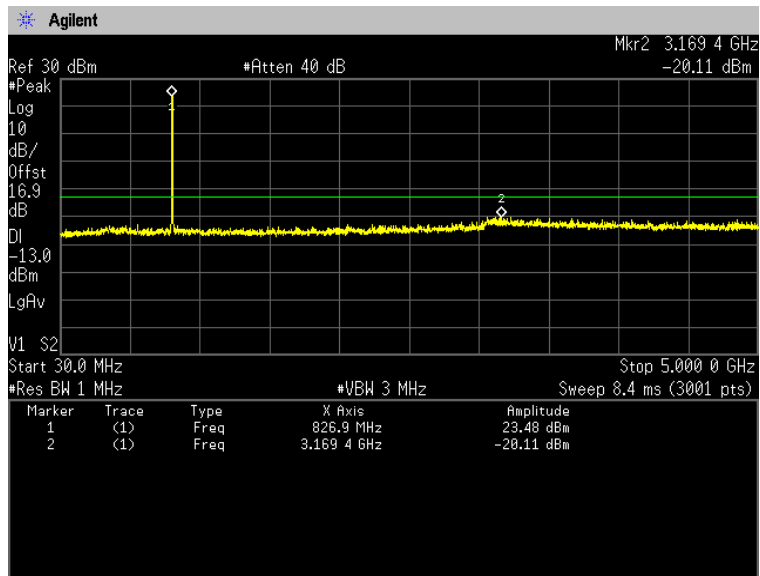

5GHz-10GHz

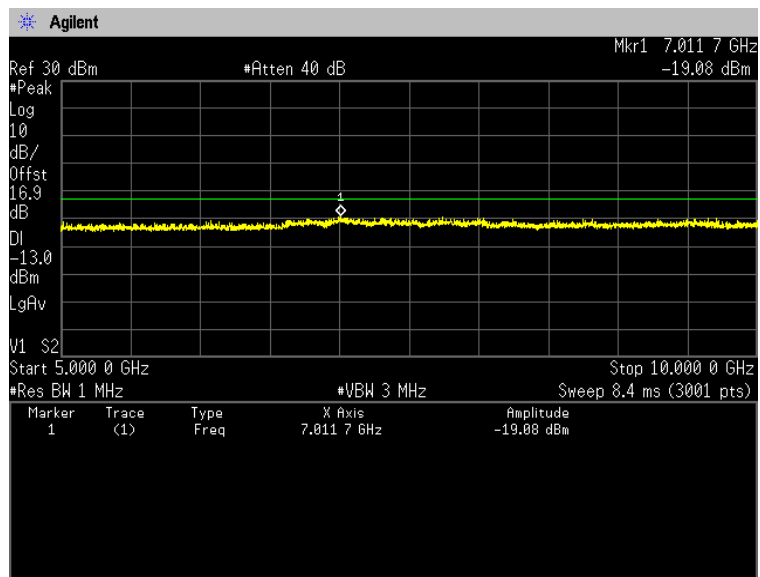



**Channel: 4183
30MHz-5GHz**

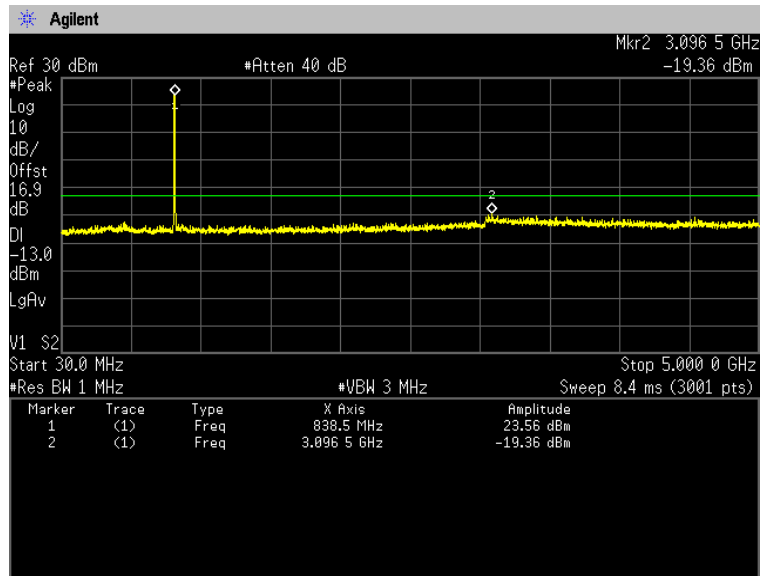

5GHz-10GHz

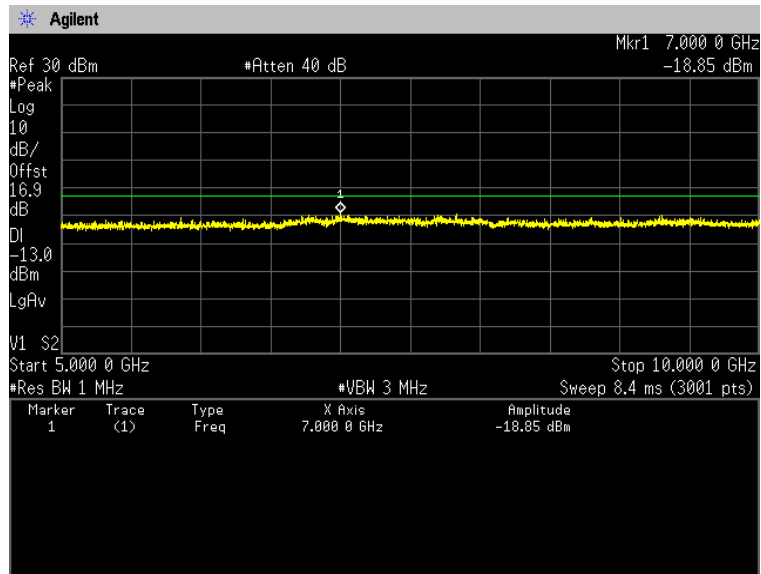



**Channel: 4233
30MHz-5GHz**

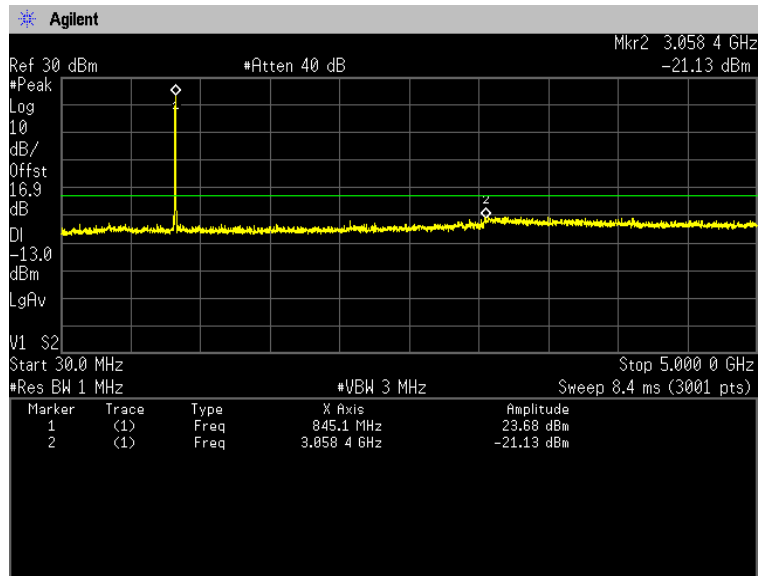

5GHz-10GHz

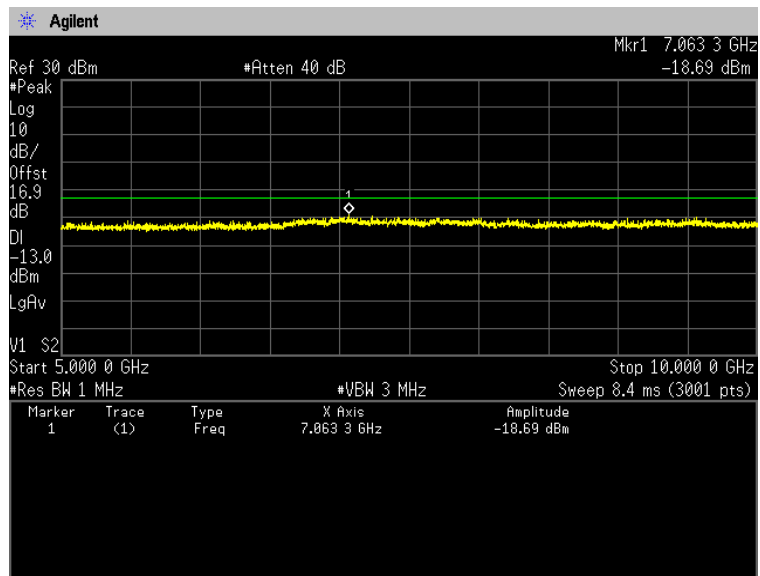

4.4 Radiated Emissions and Harmonic Emissions

4.4.1 Measurement procedure

[FCC 22.917(a), 2.1053]

<Step 1>

The EUT and support equipment are placed on a 1 meter x 1 meter surface, 0.8 meter height (Below 1GHz) or 0.6 meter x 0.6 meter surface, 1.5 meter height (Above 1GHz) styrene foam table. Radiated emission measurements are performed at 3 meter distance with the broadband antenna (Biconical antenna, Log periodic antenna and double ridged guide antenna). The antenna is positioned both the horizontal and vertical planes of polarization and height is varied 1 to 4 meters and stopped at height producing the maximum emission.

The bandwidth of the spectrum analyzer is set to 1MHz. The turntable is rotated by 360 degrees and stopped at azimuth of producing the maximum emission. The frequency is investigated up to 20GHz.

<Step 2>

The substitution antenna is replaced by the transmitter antenna (EUT).

The frequency of the signal generator is adjusted to the measurement frequency.

Level of the signal generator is adjusted to the level that is obtained from step 1, and record the emission level of signal generator.

The spectrum analyzer is set to;

- RBW = 100kHz for below 1GHz and 1MHz for above 1GHz / VBW \geq 3 x RBW
- Detector = Peak
- Trace mode = Max hold
- Sweep time = auto-couple

- Test configuration

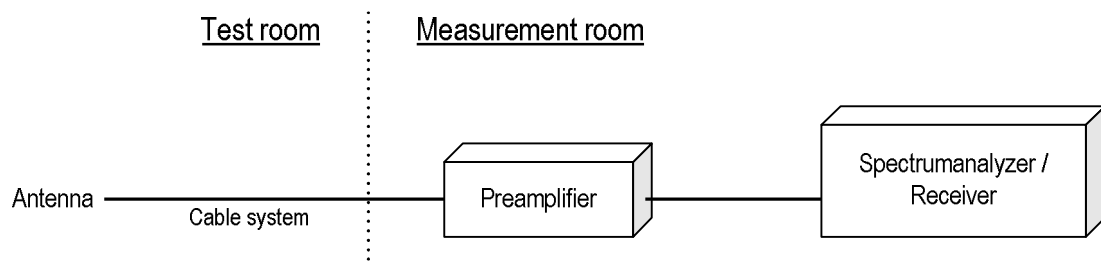



Japan

4.4.2 Calculation method

Result (EIRP) = Ant. Input - Cable loss + Antenna Gain
Margin = Limit – Result (EIRP)

Example:

Limit @ 1673.2 MHz : -13.0 dBm
Ant. Input = -56.4 dBm Cable loss = 1.0 dB Ant. Gain = 6.9 dBi
Result = -56.4 - 1.0 + 6.9 = -50.5 dBm
Margin = -13.0 - (-50.5) = 37.5 dB

4.4.3 Limit

-13 dBm or less

4.4.4 Test data

Date : 22-June-2023
 Temperature : 22.6 [°C]
 Humidity : 56.4 [%]
 Test place : 3m Semi-anechoic chamber
 Test engineer : Tadahiro Seino

Date : 22-June-2023
 Temperature : 22.1 [°C]
 Humidity : 56.2 [%]
 Test place : 3m Semi-anechoic chamber
 Test engineer : Chiaki Kanno

Date : 23-June-2023
 Temperature : 22.1 [°C]
 Humidity : 60.8 [%]
 Test place : 3m Semi-anechoic chamber
 Test engineer : Tadahiro Seino

[GSM850 - Z-axis]
(Channel: 128)

H/V	Frequency [MHz]	S.A Reading [dBm]	Ant. Input [dBm]	Cable loss [dB]	Ant.Gain [dBi]	Result [dBm]	Limit [dBm]	Margin [dB]
V	1648.4	-54.9	-55.4	1.1	6.2	-50.3	-13.0	37.3

(Channel: 190)

H/V	Frequency [MHz]	S.A Reading [dBm]	Ant. Input [dBm]	Cable loss [dB]	Ant.Gain [dBi]	Result [dBm]	Limit [dBm]	Margin [dB]
H	1673.2	-56.3	-56.1	1.1	5.8	-51.4	-13.0	38.4
V	1673.2	-56.1	-55.2	1.1	5.8	-50.5	-13.0	37.5

(Channel: 251)

H/V	Frequency [MHz]	S.A Reading [dBm]	Ant. Input [dBm]	Cable loss [dB]	Ant.Gain [dBi]	Result [dBm]	Limit [dBm]	Margin [dB]
V	1697.6	-56.5	-56.1	1.1	5.3	-51.9	-13.0	38.9

[WCDMA Band V - Z-axis]
(Channel: 4132)

H/V	Frequency [MHz]	S.A Reading [dBm]	Ant. Input [dBm]	Cable loss [dB]	Ant.Gain [dBi]	Result [dBm]	Limit [dBm]	Margin [dB]
H	1652.8	-55.9	-56.0	1.1	6.2	-51.0	-13.0	38.0

(Channel: 4183)

H/V	Frequency [MHz]	S.A Reading [dBm]	Ant. Input [dBm]	Cable loss [dB]	Ant.Gain [dBi]	Result [dBm]	Limit [dBm]	Margin [dB]
H	1673.2	-56.2	-56.2	1.1	5.8	-51.5	-13.0	38.5

(Channel: 4233)

H/V	Frequency [MHz]	S.A Reading [dBm]	Ant. Input [dBm]	Cable loss [dB]	Ant.Gain [dBi]	Result [dBm]	Limit [dBm]	Margin [dB]
H	1693.2	-56.1	-55.9	1.1	5.4	-51.6	-13.0	38.6

4.5 Frequency Stability

4.5.1 Measurement procedure

[FCC 22.355, 2.1055]

The EUT was placed of an inside of an constant temperature chamber as the temperature in the chamber was varied between -30°C and $+50^{\circ}\text{C}$. The temperature was incremented by 10°C intervals and the unit was allowed to stabilize at each measurement. The frequency drift was measured with the normal Temperature and voltage tolerance and it is presented as the ppm unit.

- Test configuration

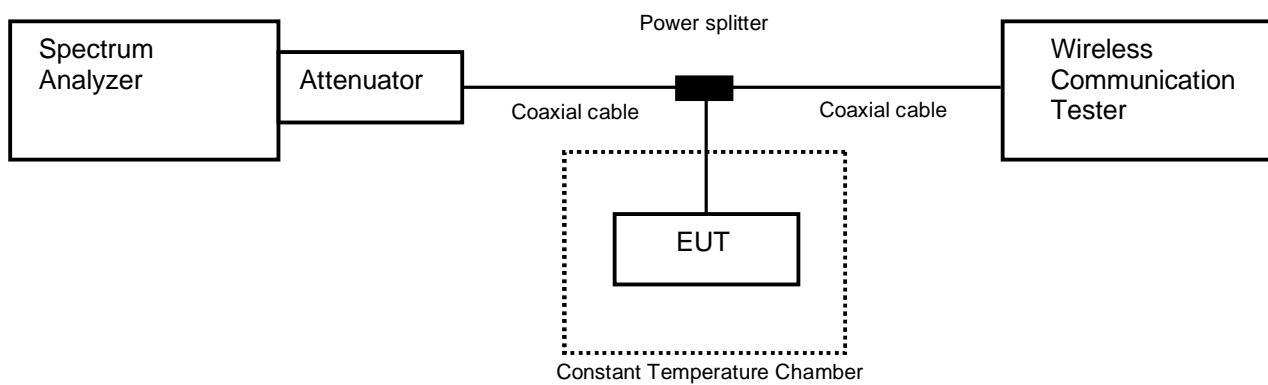

4.5.2 Limit

± 2.5 ppm

4.5.3 Measurement result

Date : 27-July-2023
 Temperature : 23.5 [°C]
 Humidity : 53.0 [%]
 Test place : Shielded room No.4

Test engineer : Kazunori Saito

[GSM850] (Channel: 190)

Limit: ±0.00025% = ±2.5 ppm					
Power Supply [V]	Temperature [°C]	Measurements Frequency [Hz]	Frequency Tolerance [ppm]	Limit [ppm]	Result
3.80	25(Ref.)	836,600,036	0.00000	±2.5	Pass
	50	836,600,026	-0.01188	±2.5	Pass
	40	836,600,020	-0.01990	±2.5	Pass
	30	836,600,037	0.00123	±2.5	Pass
	20	836,600,031	-0.00694	±2.5	Pass
	10	836,600,033	-0.00374	±2.5	Pass
	0	836,600,039	0.00289	±2.5	Pass
	-10	836,600,040	0.00471	±2.5	Pass
	-20	836,600,043	0.00791	±2.5	Pass
	-30	836,600,055	0.02211	±2.5	Pass
3.42	25	836,600,035	-0.00216	±2.5	Pass
4.18	25	836,600,039	0.00329	±2.5	Pass

[WCDMA Band V] (Channel: 4183)

Limit: ±0.00025% = ±2.5 ppm					
Power Supply [V]	Temperature [°C]	Measurements Frequency [Hz]	Frequency Tolerance [ppm]	Limit [ppm]	Result
3.80	25(Ref.)	836,599,999	0.00000	±2.5	Pass
	50	836,599,997	-0.00295	±2.5	Pass
	40	836,599,997	-0.00210	±2.5	Pass
	30	836,599,998	-0.00148	±2.5	Pass
	20	836,599,998	-0.00111	±2.5	Pass
	10	836,599,990	-0.01026	±2.5	Pass
	0	836,599,992	-0.00804	±2.5	Pass
	-10	836,600,007	0.00906	±2.5	Pass
	-20	836,599,993	-0.00760	±2.5	Pass
	-30	836,600,007	0.00930	±2.5	Pass
3.42	25	836,599,998	-0.00136	±2.5	Pass
4.18	25	836,599,997	-0.00186	±2.5	Pass

Calculation:



Frequency Tolerance (ppm) = Measurements Frequency (Hz) – Reference Frequency (Hz) / Reference Frequency (Hz) x 1000000

5 Measurement Uncertainty

The reported measurement uncertainty is based on a value obtained by multiplying standard uncertainty by coverage factor of k=2, and a level of confidence becomes 95 %.

3m Semi Anechoic Chamber	
Test item	Measurement uncertainty
Conducted emission, AMN (9 kHz – 150 kHz)	±3.7 dB
Conducted emission, AMN (150 kHz – 30 MHz)	±3.3 dB
Radiated emission (9kHz – 30 MHz)	±3.8 dB
Radiated emission (30 MHz – 1000 MHz)	±5.4 dB
Radiated emission (1 GHz – 6 GHz)	±4.6 dB
Radiated emission (6 GHz – 18 GHz)	±4.7 dB
Radiated emission (18 GHz – 40 GHz)	±6.4 dB
Radio Frequency	±1.3 * 10 ⁻⁸
RF power, conducted	±0.7 dB
Adjacent channel power	±1.5 dB
Temperature	±0.6 °C
Humidity	±1.2 %
Voltage (DC)	±0.4 %
Voltage (AC, <10kHz)	±0.2 %

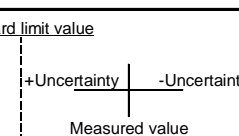
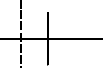
Measurement uncertainty of not listed immunity tests is considered to suffice because requirements of relevant standards are met.

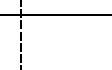
Judge	Measured value and standard limit value
PASS	<p>Case1</p>  <p>Even if it takes uncertainty into consideration, a standard limit value is fulfilled.</p>
	<p>Case2</p>  <p>Although measured value is in a standard limit value, a limit value won't be fulfilled if uncertainty is taken into consideration.</p>
FAIL	<p>Case3</p>  <p>Although measured value exceeds a standard limit value, a limit value will be fulfilled if uncertainty is taken into consideration.</p>
	<p>Case4</p>  <p>Even if it takes uncertainty into consideration, a standard limit value isn't fulfilled.</p>



Japan

6 Laboratory Information

Testing was performed and the report was issued at:

TÜV SÜD Japan Ltd. Yonezawa Testing Center

Address: 5-4149-7 Hachimanpara, Yonezawa-shi, Yamagata, 992-1128 Japan

Phone: +81-238-28-2881

Accreditation and Registration

A2LA

Certificate #3686.03

VLAC

Accreditation No.: VLAC-013

BSMI

Laboratory Code: SL2-IN-E-6018, SL2-A1-E-6018

Innovation, Science and Economic Development Canada

ISED#: 4224A

VCCI Council

Registration number: A-0166

Appendix A. Test Equipment

Antenna port conducted test

Equipment	Company	Model No.	Serial No.	Cal. Due	Cal. Date
Spectrum analyzer	Agilent Technologies	E4440A	US44302655	30-Sep-2023	05-Sep-2022
Attenuator	HUBER+SUHNER	6810.19.A	N/A(S450)	31-Dec-2023	19-Dec-2022
Microwave cable	Junkosha Inc.	MWX221/1m	N/A(S400)	31-Mar-2024	16-Mar-2023
Power divider	Keysight	11636B	MY51359874	30-Sep-2023	28-Sep-2022
Wideband Radio Frequency Tester	ROHDE&SCHWARZ	CMW500	116338	31-Aug-2023	04-Aug-2022
Temperature and humidity chamber	ESPEC	PL1KP	14007261	30-Sep-2023	02-Sep-2022

Radiated emission

Equipment	Company	Model No.	Serial No.	Cal. Due	Cal. Date
EMI Receiver	ROHDE&SCHWARZ	ESW44	103171	30-Sep-2023	20-Sep-2022
Preamplifier	SONOMA	310	372170	30-Sep-2023	15-Sep-2022
Biconical antenna	Schwarzbeck	VHBB9124/BBA9106	1145	30-Jun-2023	28-Jun-2022
Log periodic antenna	Schwarzbeck	VUSLP9111B	346	30-Nov-2023	16-Nov-2022
Attenuator	TOYO Connector	NA-PJ-6/6dB	N/A(S541)	30-Sep-2023	28-Sep-2022
Attenuator	TAMAGAWA.ELEC	CFA-10/3dB	N/A(S503)	31-Jul-2023	14-Jul-2022
Preamplifier	TSJ	MLA-100M18-B02-40	1929118	31-Dec-2023	22-Dec-2022
Attenuator	AEROFLEX	26A-10	081217-08	31-Dec-2023	19-Dec-2022
Double ridged guide antenna	ETS LINDGREN	3117	00052315	30-Jun-2024	22-Jun-2023
Attenuator	HUBER+SUHNER	6803.17.B	N/A(2340)	31-Dec-2023	22-Dec-2022
Double ridged guide antenna	A.H.Systems Inc.	SAS-574	469	31-Aug-2023	19-Aug-2022
Preamplifier	TSJ	MLA-1840-B03-35	1240332	31-Aug-2023	19-Aug-2022
Notch Filter	Micro-Tronics	BRM50706	003	31-Jul-2024	19-Jul-2023
Signal generator	ROHDE&SCHWARZ	SMB100A	177525	31-Dec-2023	16-Dec-2022
RF power amplifier	R&K	CGA020M602-2633R	B40240	30-Jun-2024	21-Jun-2023
Attenuator	HUBER+SUHNER	6820.19.A	N/A(2399)	30-Sep-2023	28-Sep-2022
Microwave cable	HUBER+SUHNER	SUCOFLEX102/2m	31648	31-Mar-2024	16-Mar-2023
Dipole antenna	Schwarzbeck	VHAP	1020	31-Jul-2023	05-Jul-2022
Dipole antenna	Schwarzbeck	UHAP	994	31-Jul-2023	05-Jul-2022
Double ridged guide antenna	ETS LINDGREN	3117	00218815	31-Dec-2023	19-Dec-2022
Wideband Radio Frequency Tester	ROHDE&SCHWARZ	CMW500	126079	31-Aug-2023	15-Aug-2022
Wideband Radio Frequency Tester	ROHDE&SCHWARZ	CMW500	116338	31-Aug-2023	04-Aug-2022
Microwave cable	HUBER+SUHNER	SUCOFLEX104/9m	800690/4	31-Oct-2023	26-Oct-2022
		SUCOFLEX104/1m	my24610/4	31-Dec-2023	19-Dec-2022
		SUCOFLEX104/9m	2001099/4	31-Dec-2023	22-Dec-2022
		SUCOFLEX104/1m	MY32976/4	31-Dec-2023	22-Dec-2022
		SUCOFLEX104/2m	SN MY28404/4	31-Dec-2023	19-Dec-2022
		SUCOFLEX104/7m	41625/6	31-Dec-2023	22-Dec-2022
PC	DELL	OPTIPLEX9010	00186-228-073-851	N/A	N/A
Software	TOYO Technica	ES10/RE-AJ	Ver.2023.01.001	N/A	N/A
Absorber	RIKEN	PFP30	N/A	N/A	N/A
3m Semi an-echoic Chamber	TOKIN	N/A	N/A(9002-NSA)	31-May-2024	28-May-2023
3m Semi an-echoic Chamber	TOKIN	N/A	N/A(9002-SVSWR)	31-May-2024	29-May-2023

*: The calibrations of the above equipment are traceable to NIST or equivalent standards of the reference organizations.