

Antenna Gain

Main Antenna	LTE Band 1 UE:Open	+1.32 dBi
	LTE Band 1 UE:Close	-1.66 dBi
Main Antenna	LTE Band 3 UE:Open	+1.90 dBi
	LTE Band 3 UE:Close	-1.14 dBi
Main Antenna	LTE Band 12 UE:Open	-0.80 dBi
	LTE Band 12 UE:Close	-6.08 dBi
Main Antenna	LTE Band 17 UE:Open	-0.80 dBi
	LTE Band 17 UE:Close	-6.08 dBi
Main Antenna	UMTS Band 1 UE:Open	+1.32 dBi
	UMTS Band 1 UE:Close	-1.66 dBi
Main Antenna	UMTS Band 5 UE:Open	+0.61 dBi
	UMTS Band 5 UE:Close	-1.49 dBi
Main Antenna	GSM850 UE:Open	+0.61 dBi
	GSM850 UE:Close	-1.49 dBi
Main Antenna	GSM900 UE:Open	-0.01 dBi
	GSM900 UE:Close	-1.17 dBi
Main Antenna	GSM1800 UE:Open	+1.90 dBi
	GSM1800 UE:Close	-1.14 dBi
Main Antenna	GSM1900 UE:Open	+0.39 dBi
	GSM1900 UE:Close	-1.55 dBi
Bluetooth/WLAN Antenna	Bluetooth/WLAN2.4G UE:Open	+1.99 dBi
	Bluetooth/WLAN2.4G UE:Close	+1.27 dBi

LTE Band1 Peak +1.32[dBi] (UE : Open)

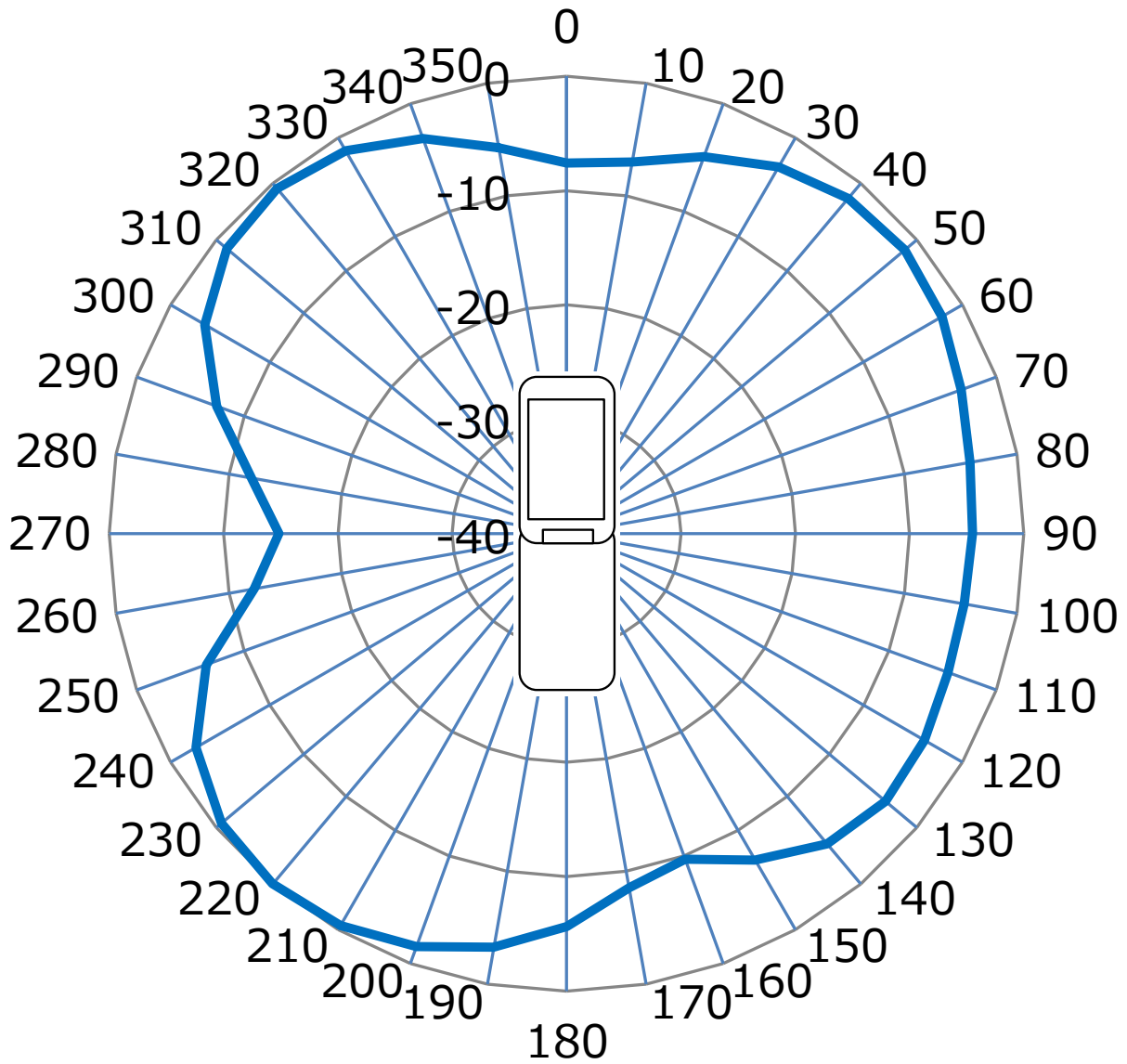

Kyocera Confidential

LTE Band1 Peak -1.66[dBi] (UE : Close)

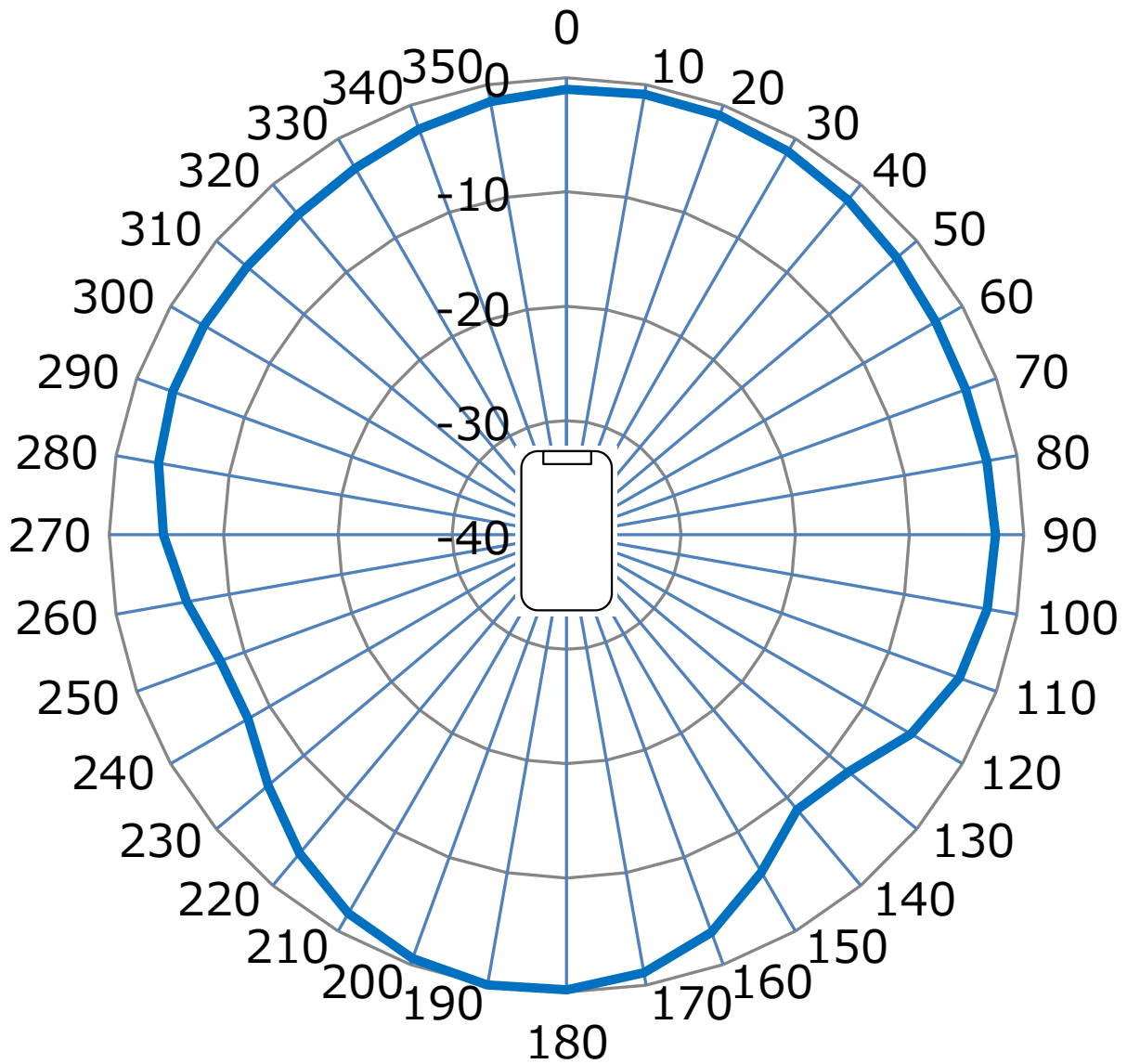

Kyocera Confidential

LTE Band3 Peak +1.90[dBi] (UE : Open)

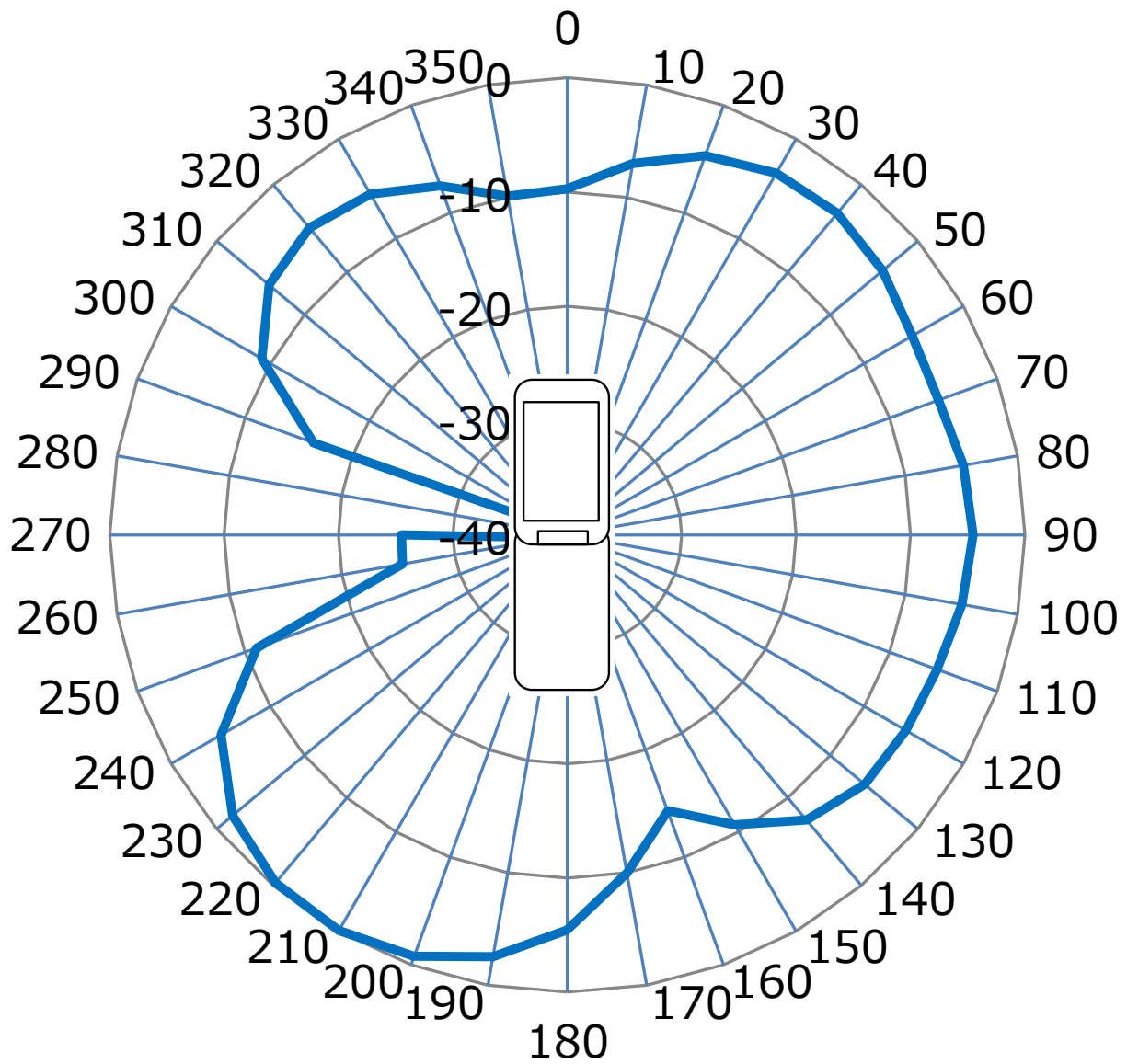

Kyocera Confidential

LTE Band3 Peak -1.14[dBi] (UE : Close)

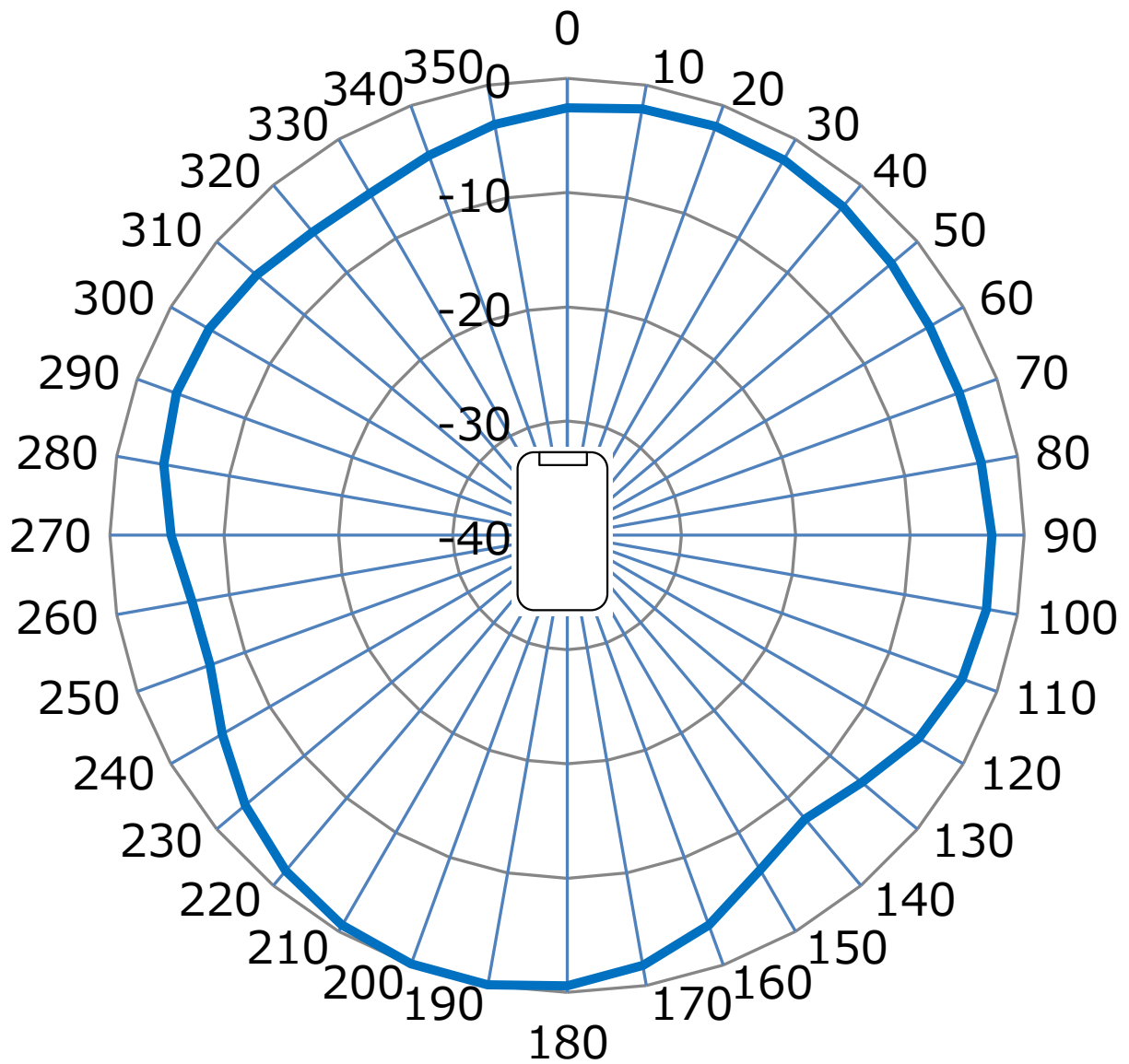

Kyocera Confidential

LTE Band12 Peak -0.80[dBi] (UE : Open)

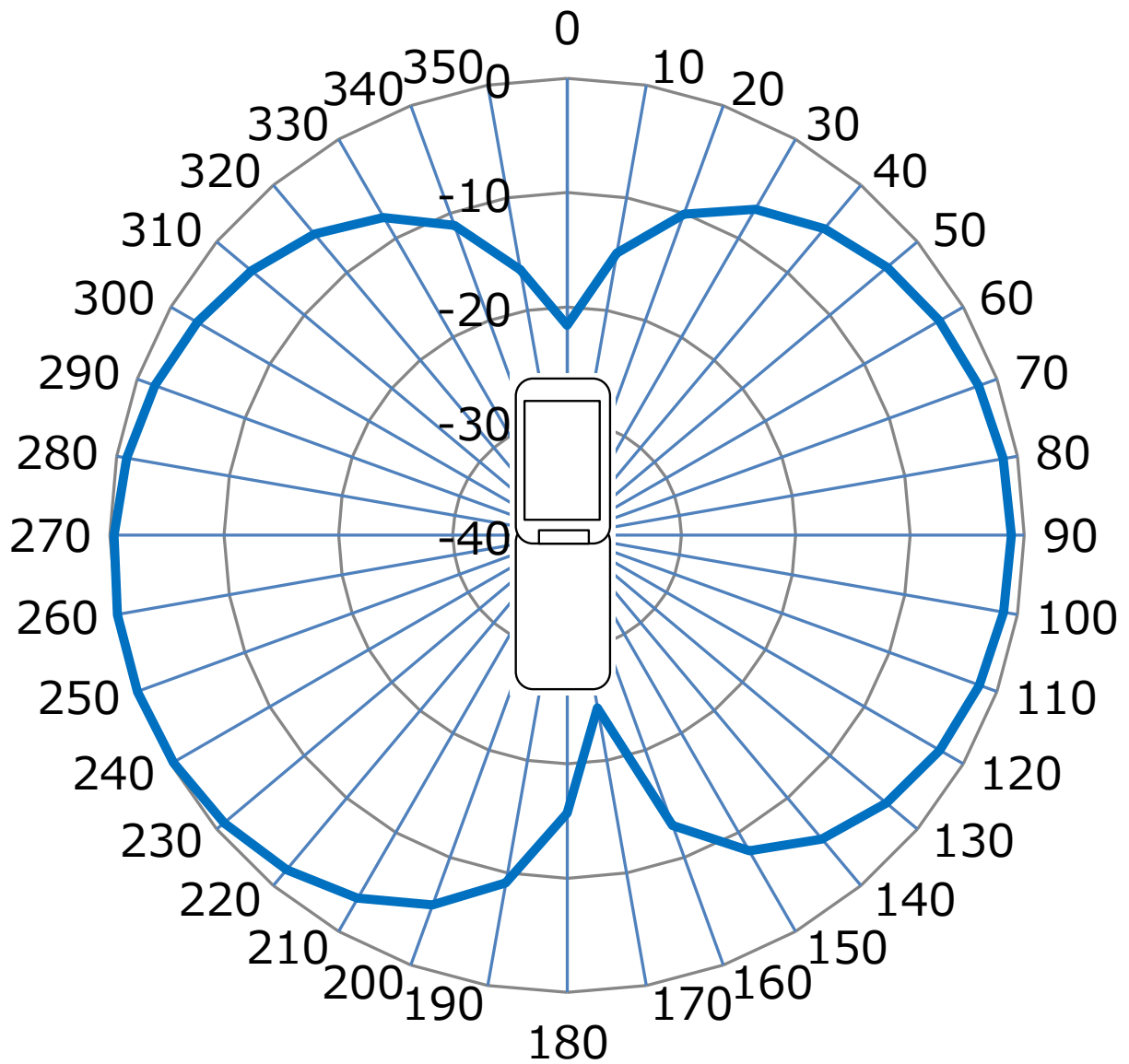

Kyocera Confidential

LTE Band12 Peak -6.08[dBi] (UE : Close)

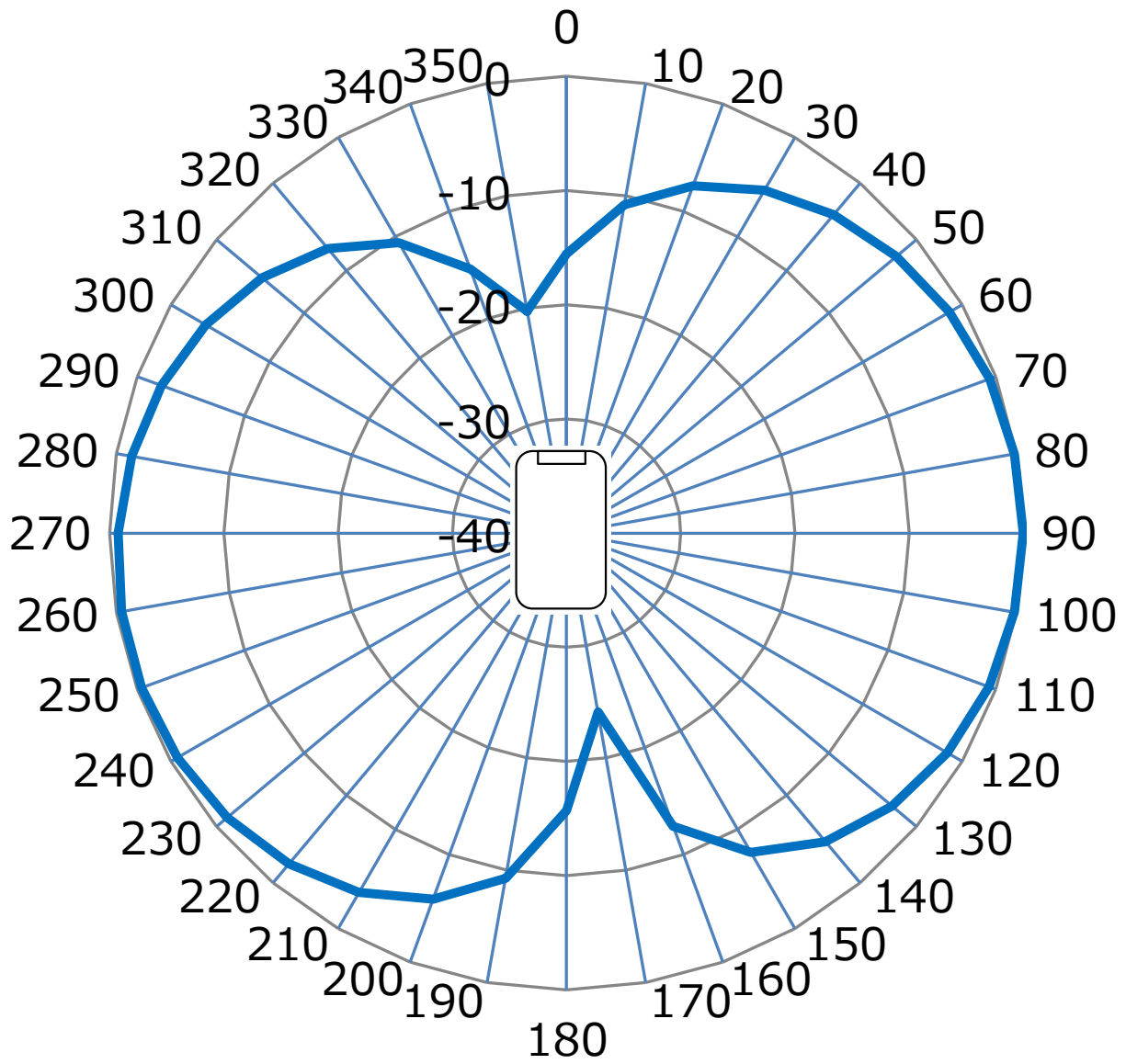

Kyocera Confidential

LTE Band17 Peak -0.80[dBi] (UE : Open)

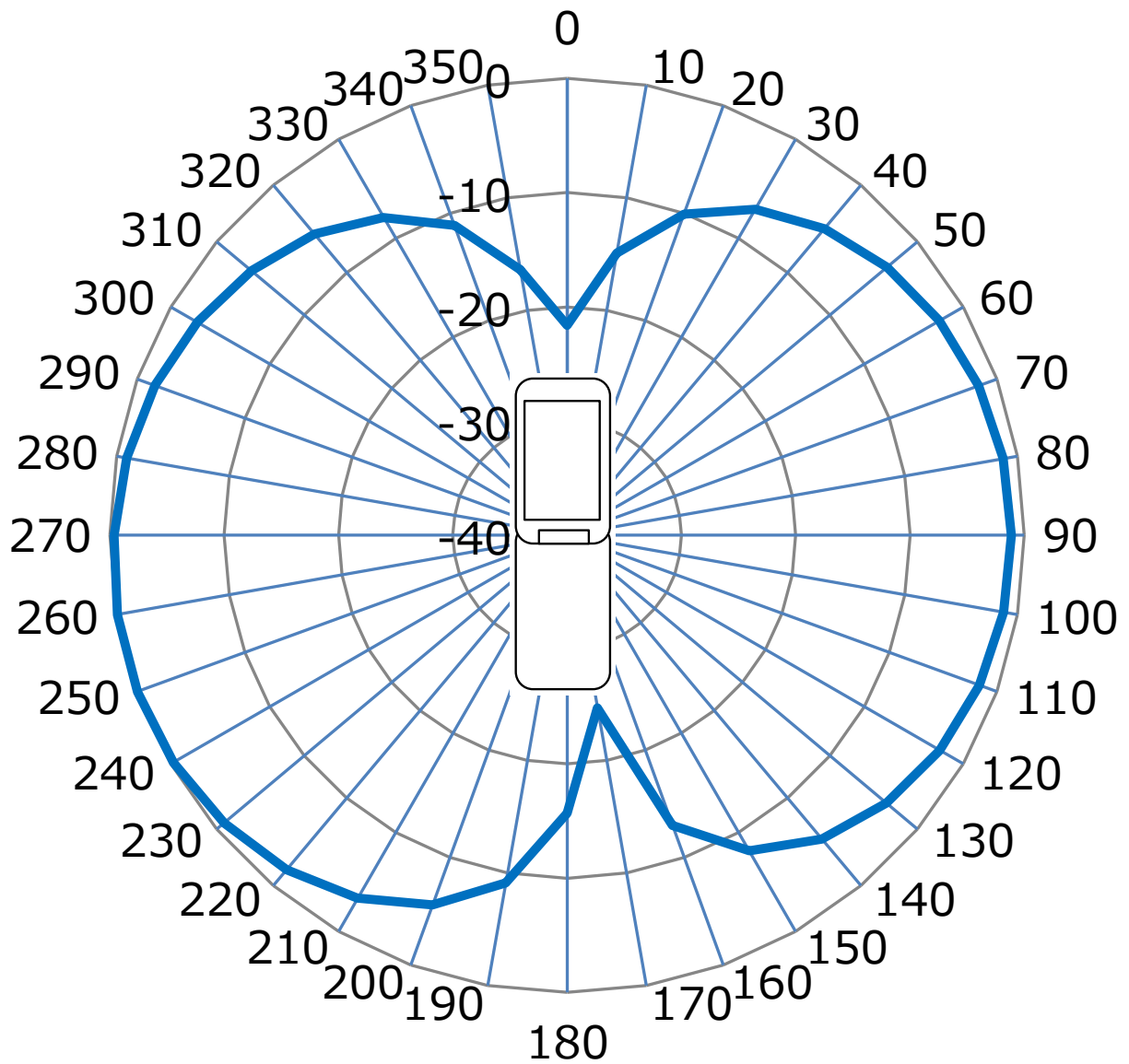

Kyocera Confidential

LTE Band17 Peak -6.08[dBi] (UE : Close)

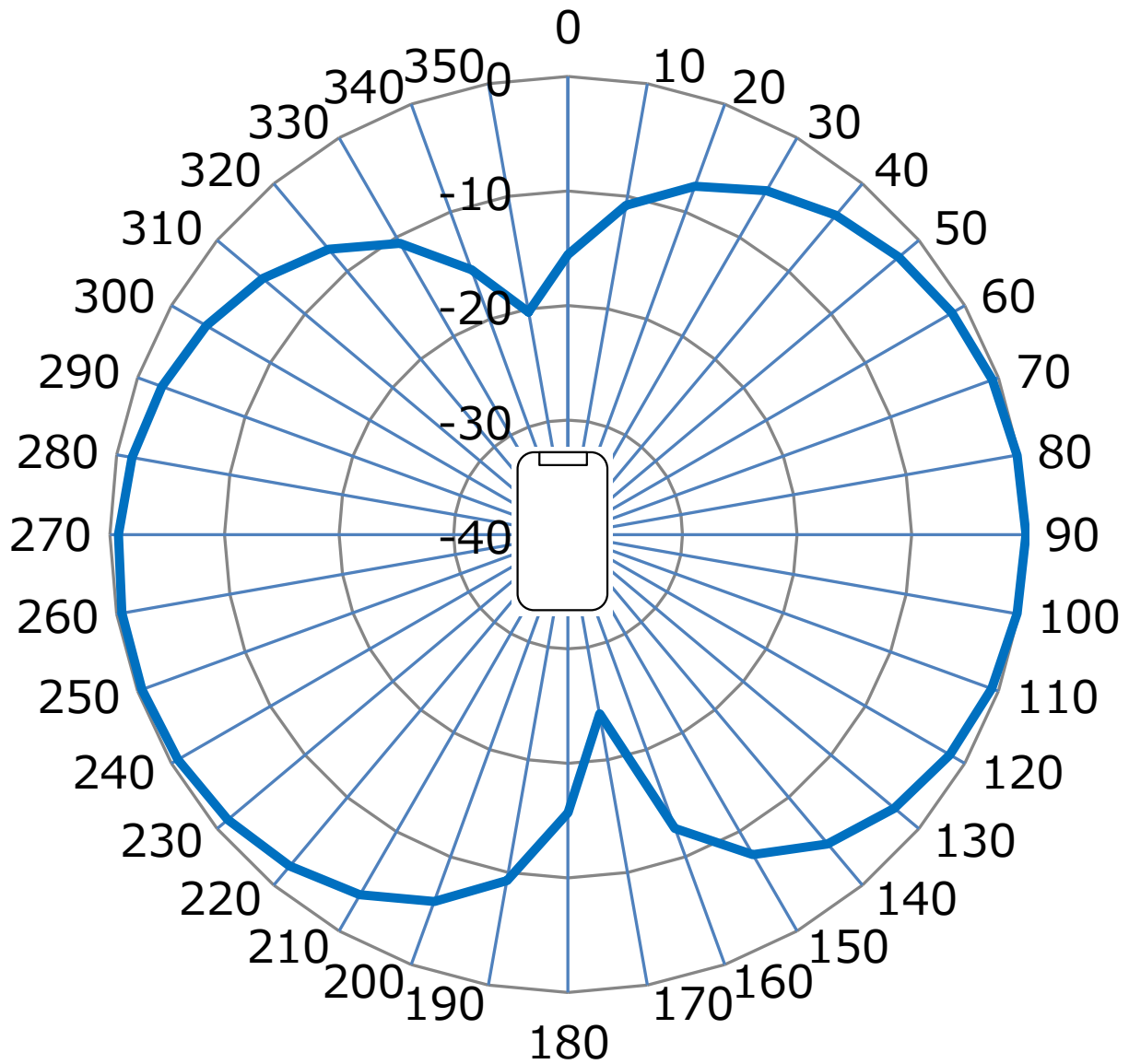

Kyocera Confidential

UMTS Band1 Peak +1.32[dBi] (UE : Open)

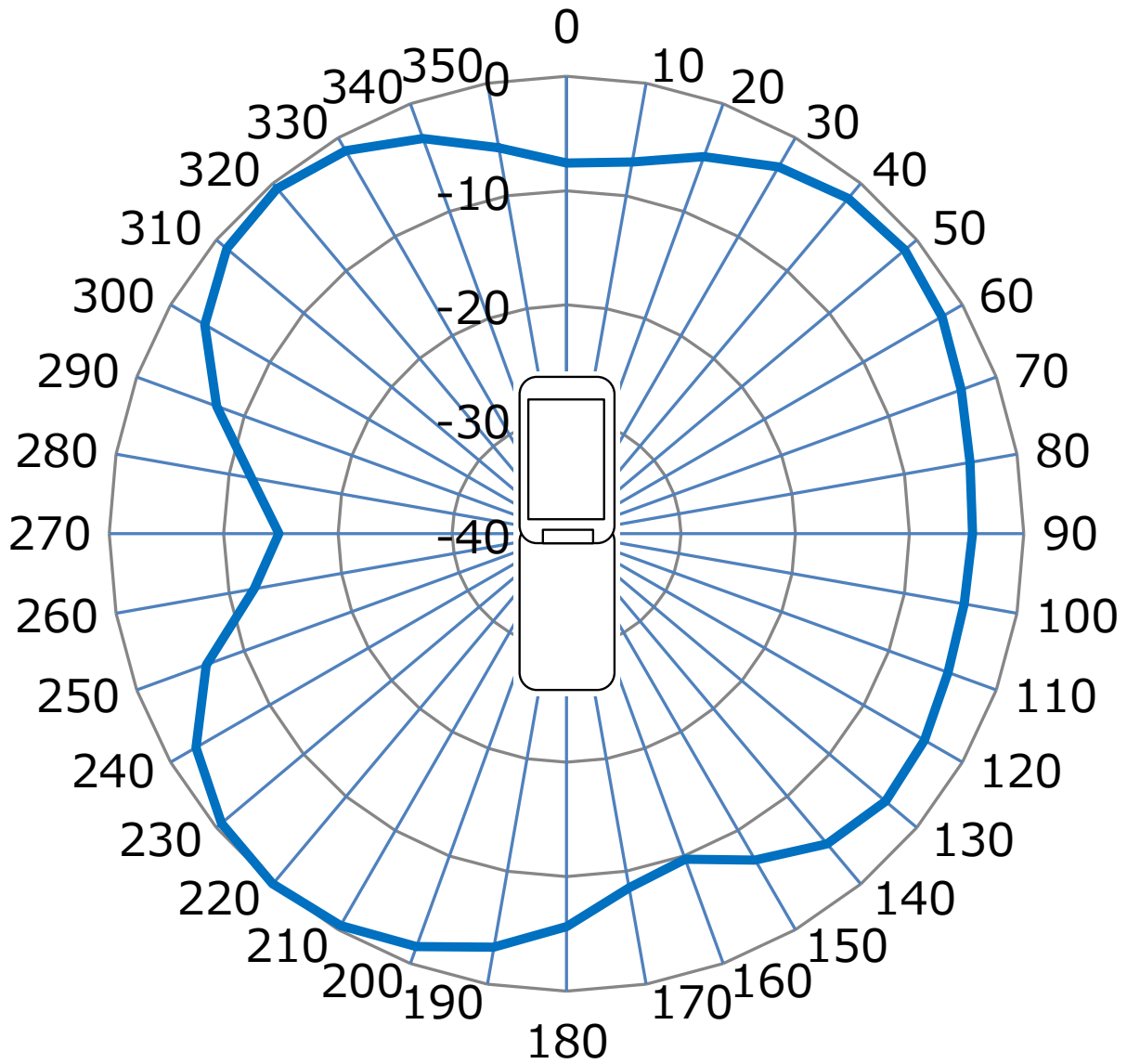

Kyocera Confidential

UMTS Band1 Peak -1.66[dBi] (UE : Close)

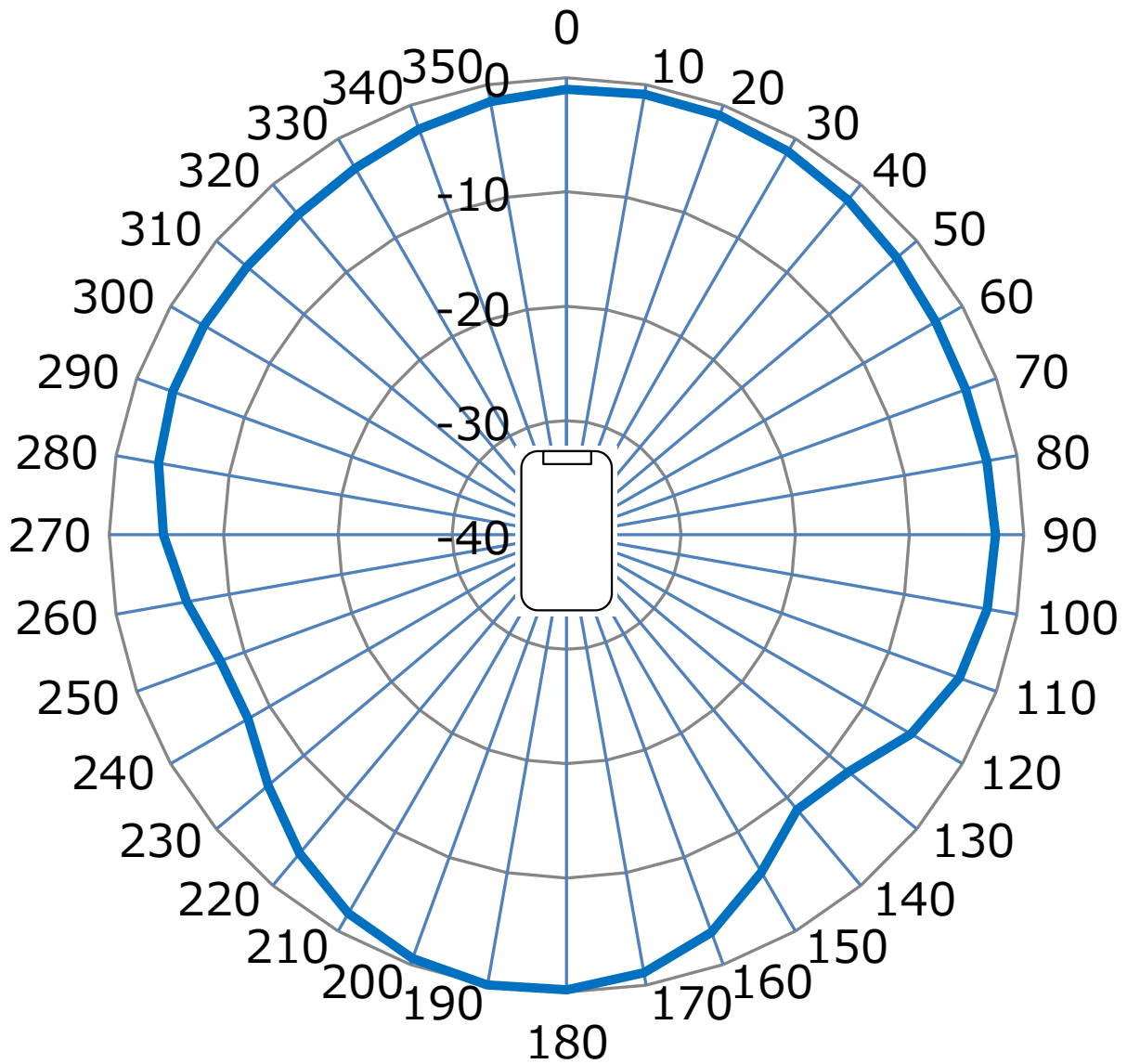

Kyocera Confidential

UMTS Band5 Peak +0.61[dBi] (UE : Open)

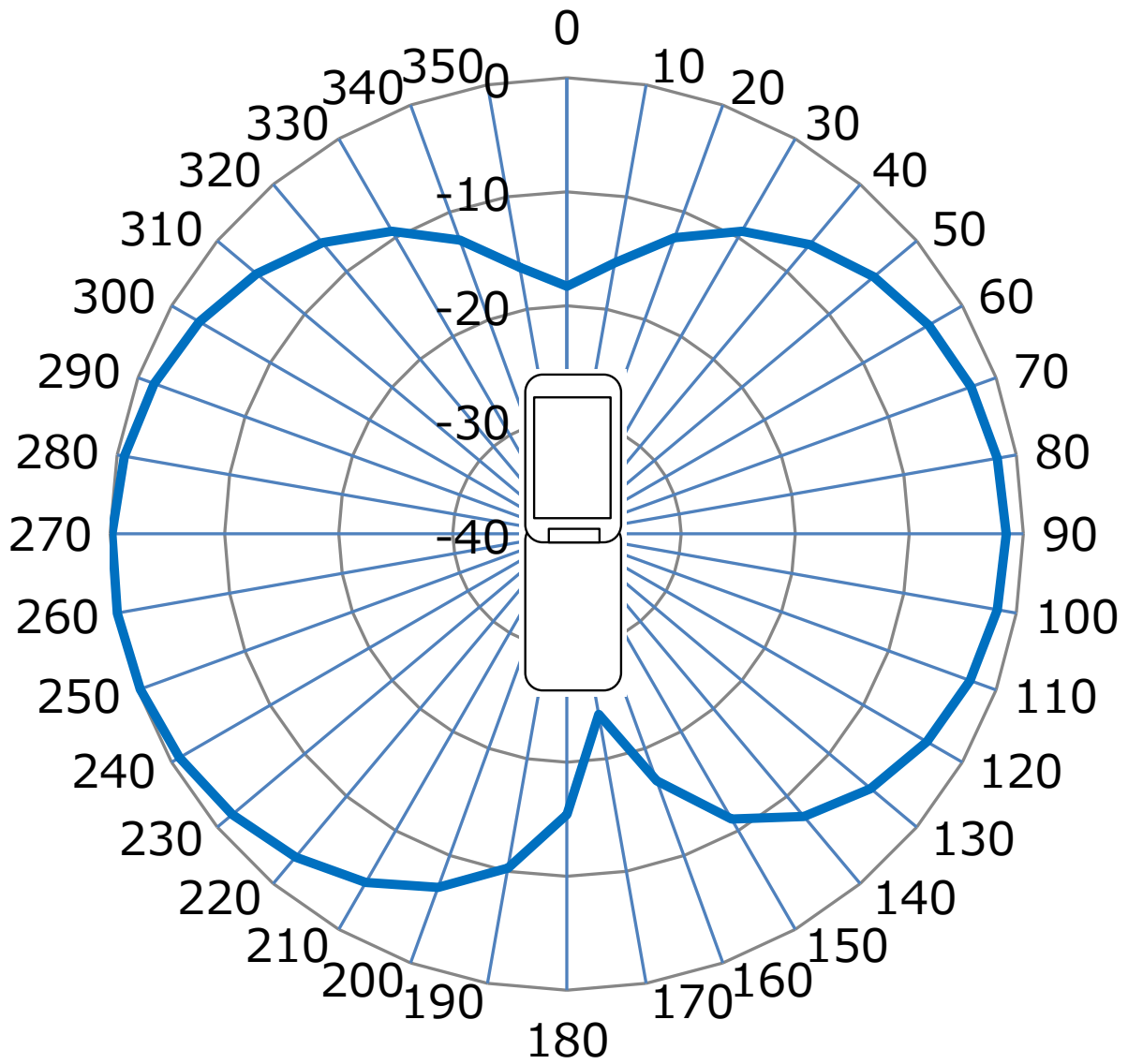

Kyocera Confidential

UMTS Band5 Peak -1.49[dBi] (UE : Close)

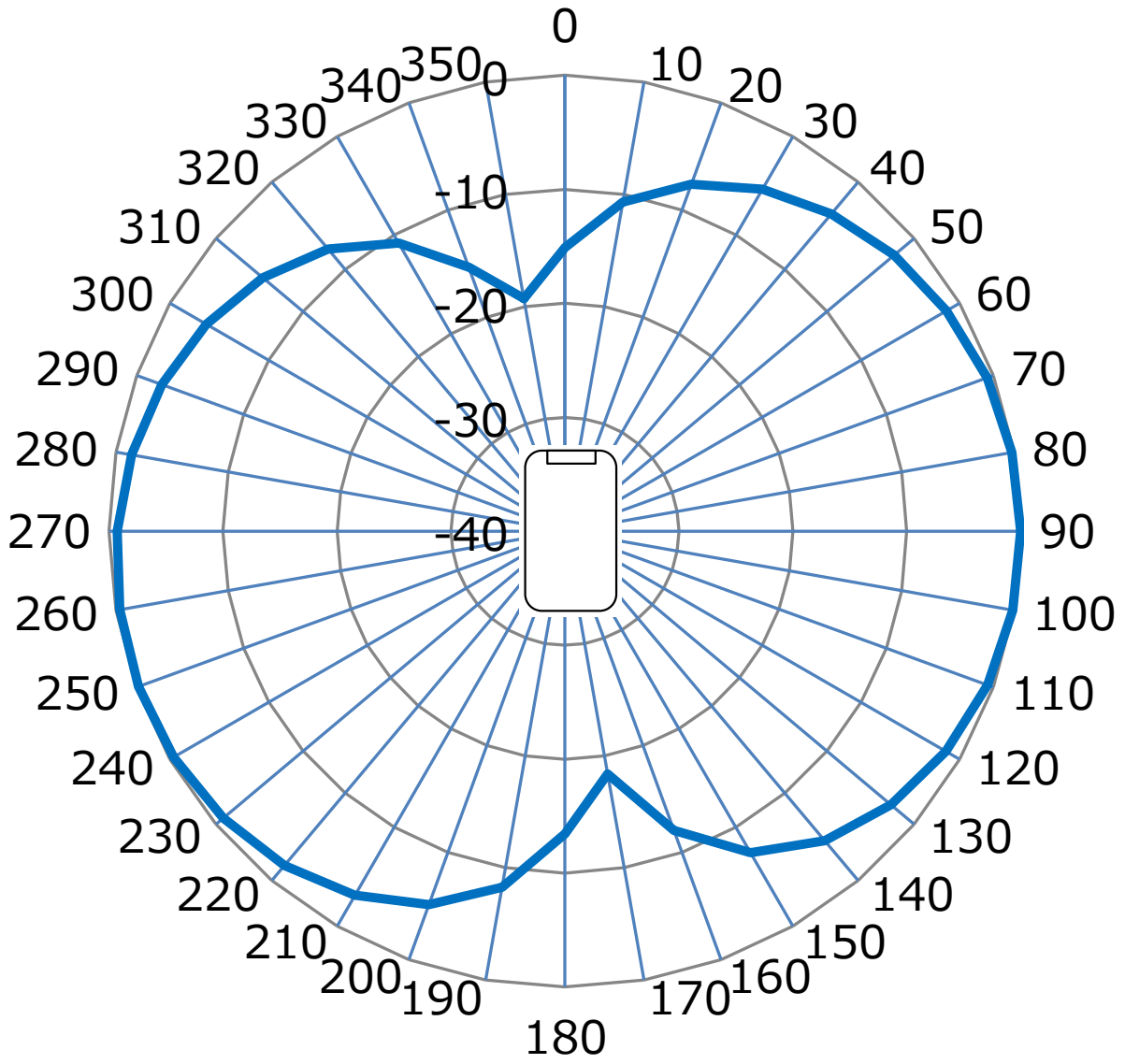

Kyocera Confidential

GSM850 Peak +0.61[dBi] (UE : Open)

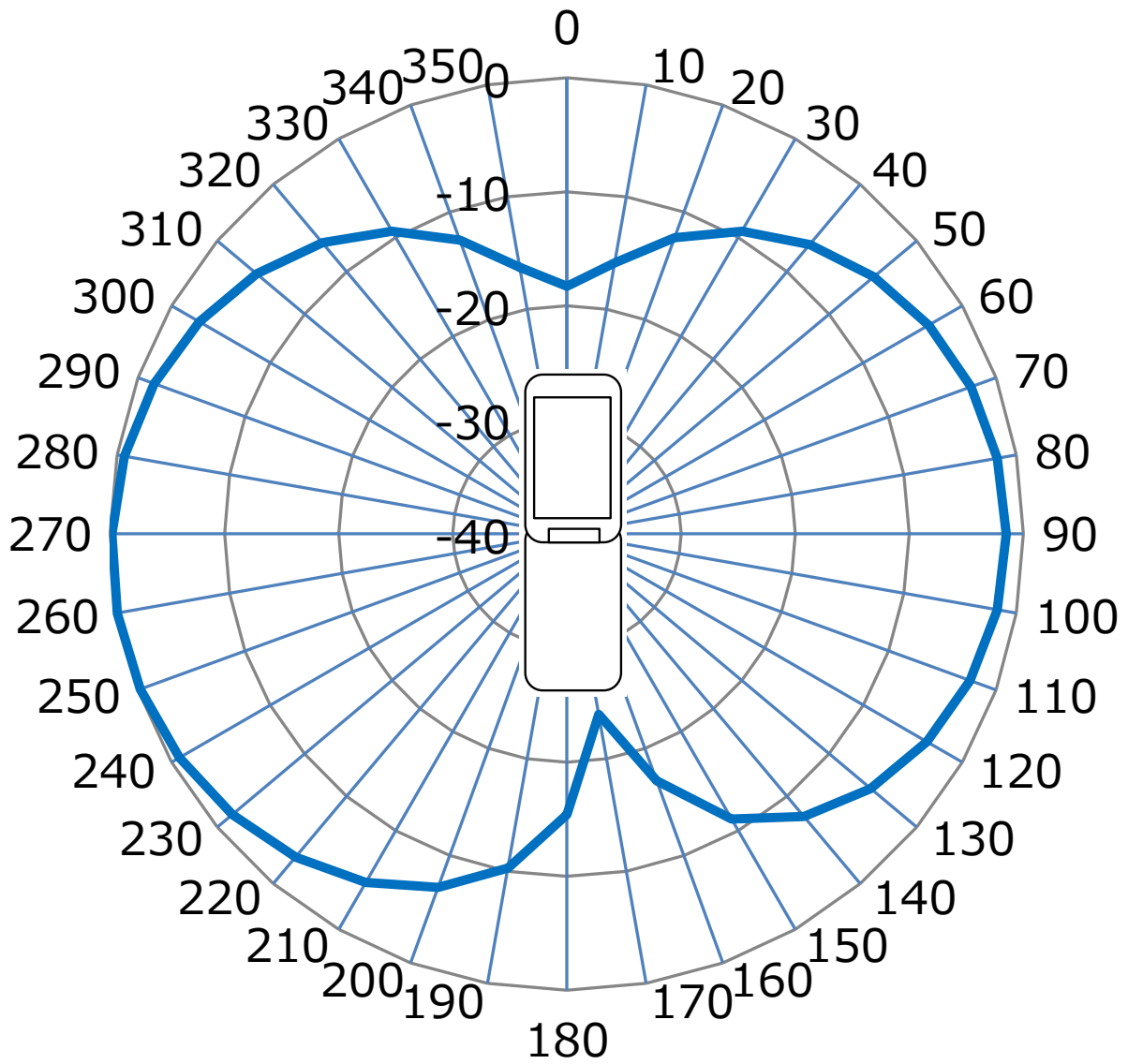

Kyocera Confidential

GSM850 Peak -1.49 [dBi] (UE : Close)

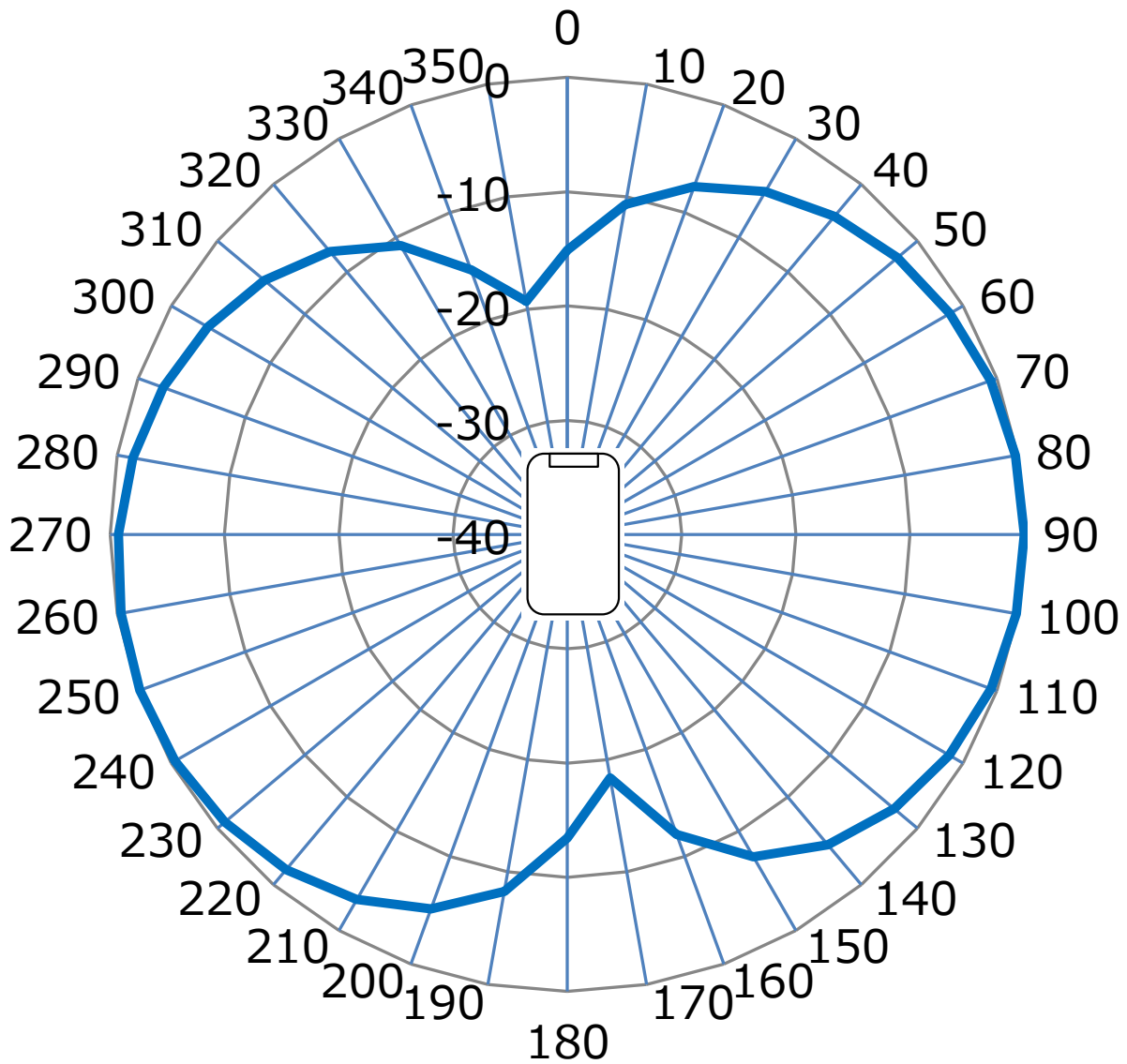

Kyocera Confidential

GSM900 Peak -0.01[dBi] (UE : Open)

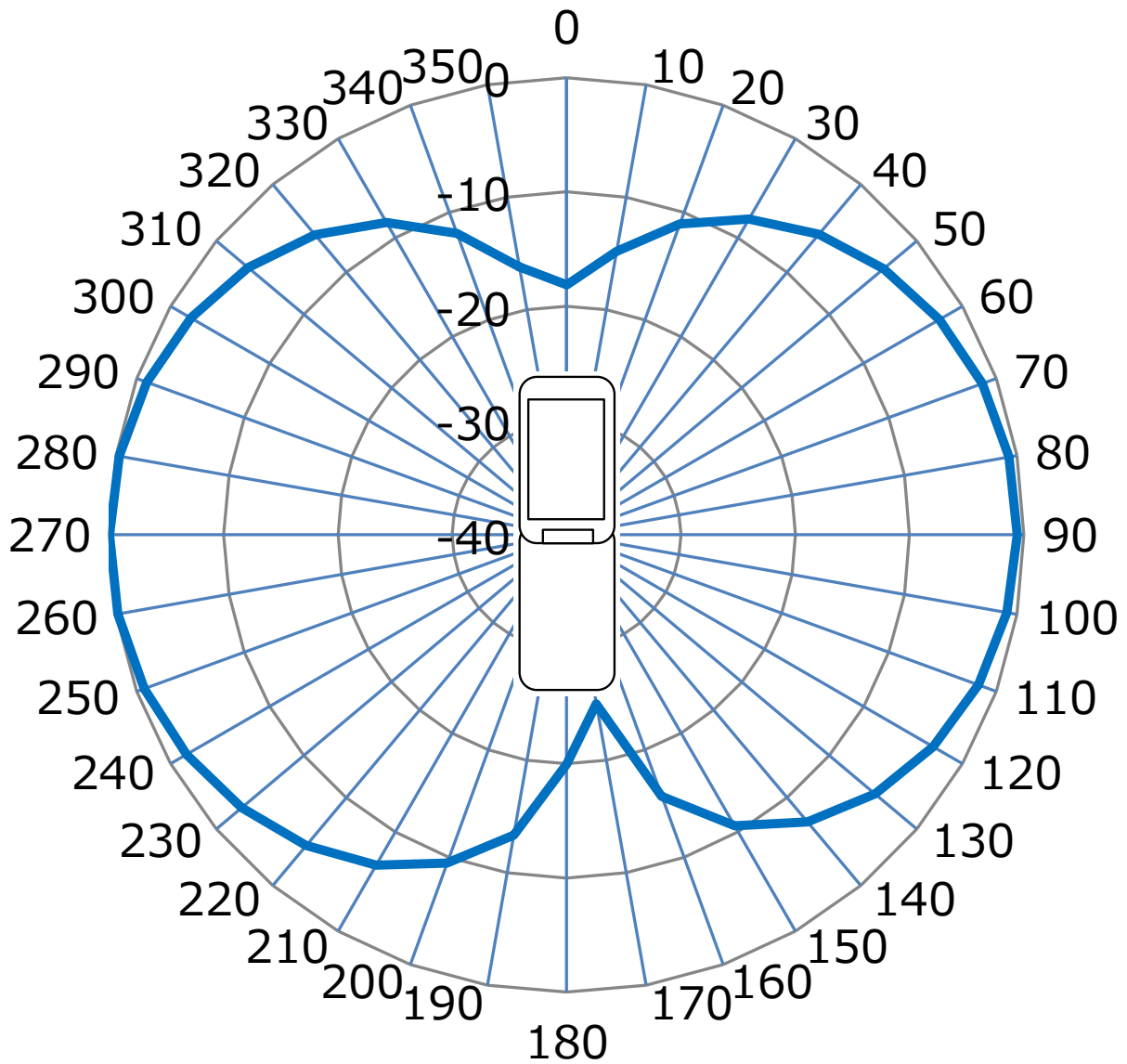

Kyocera Confidential

GSM900 Peak -1.17[dBi] (UE : Close)

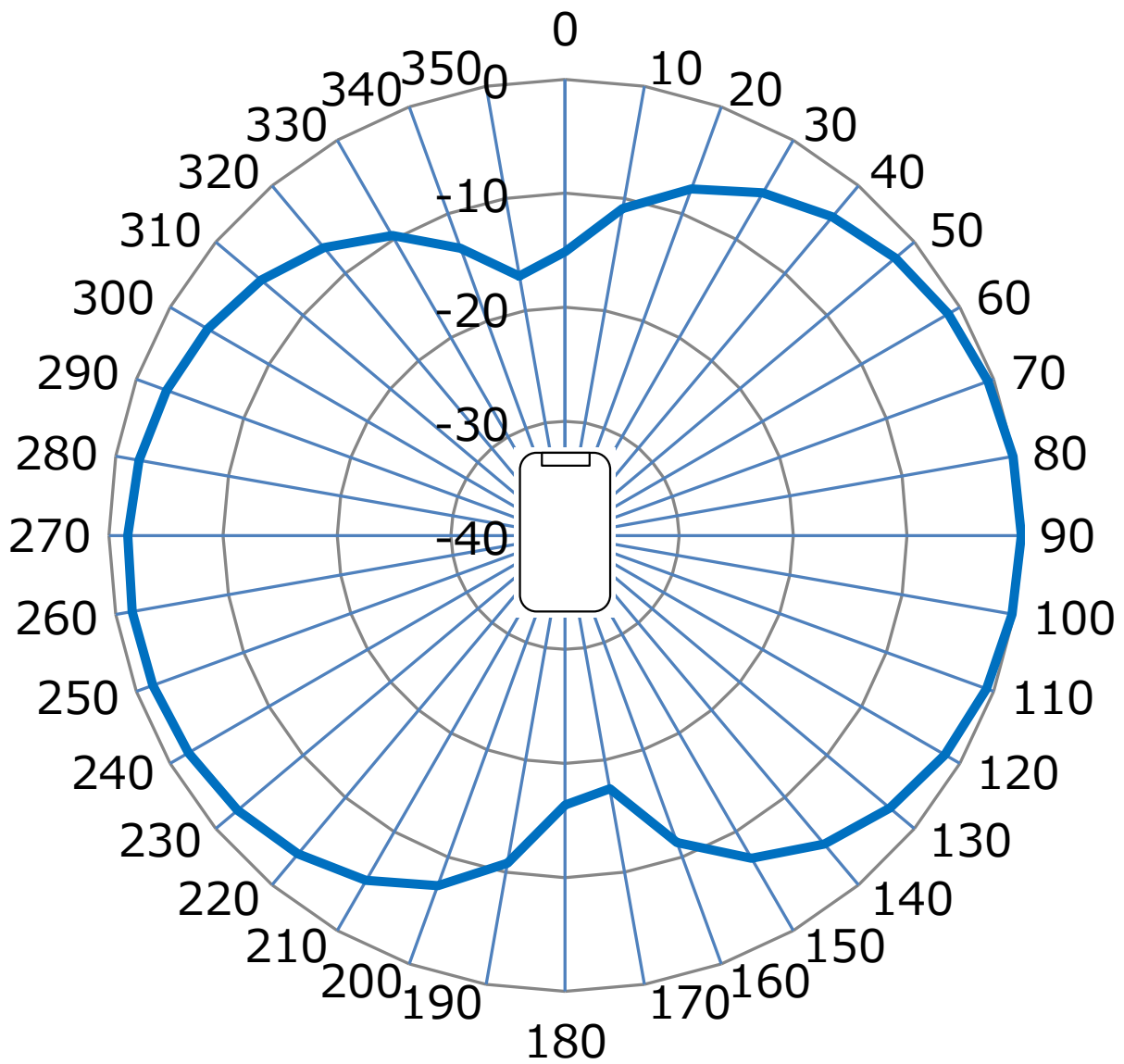

Kyocera Confidential

GSM1800 Peak +1.90[dBi] (UE : Open)

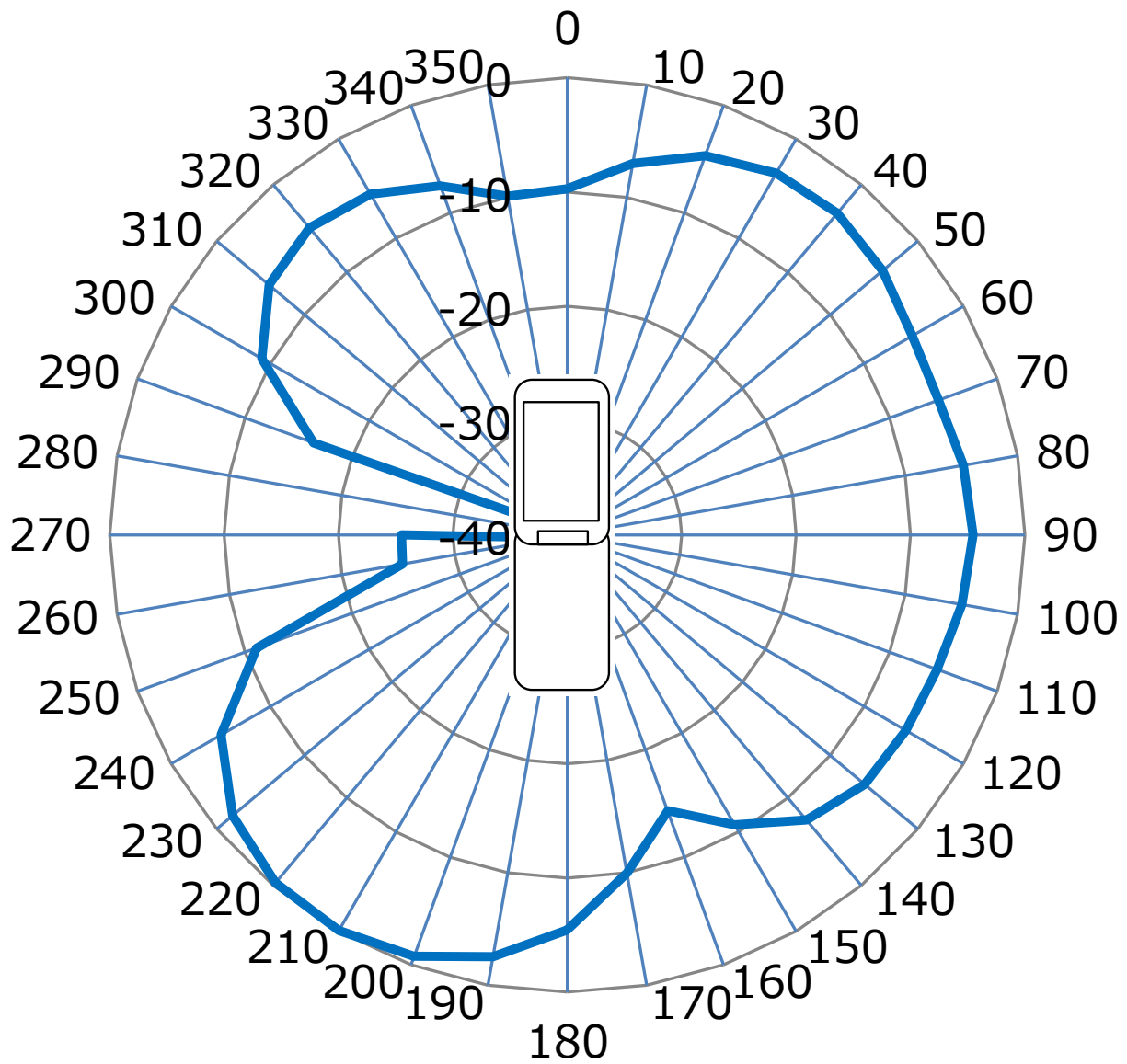

Kyocera Confidential

GSM1800 Peak -1.14[dBi] (UE : Close)

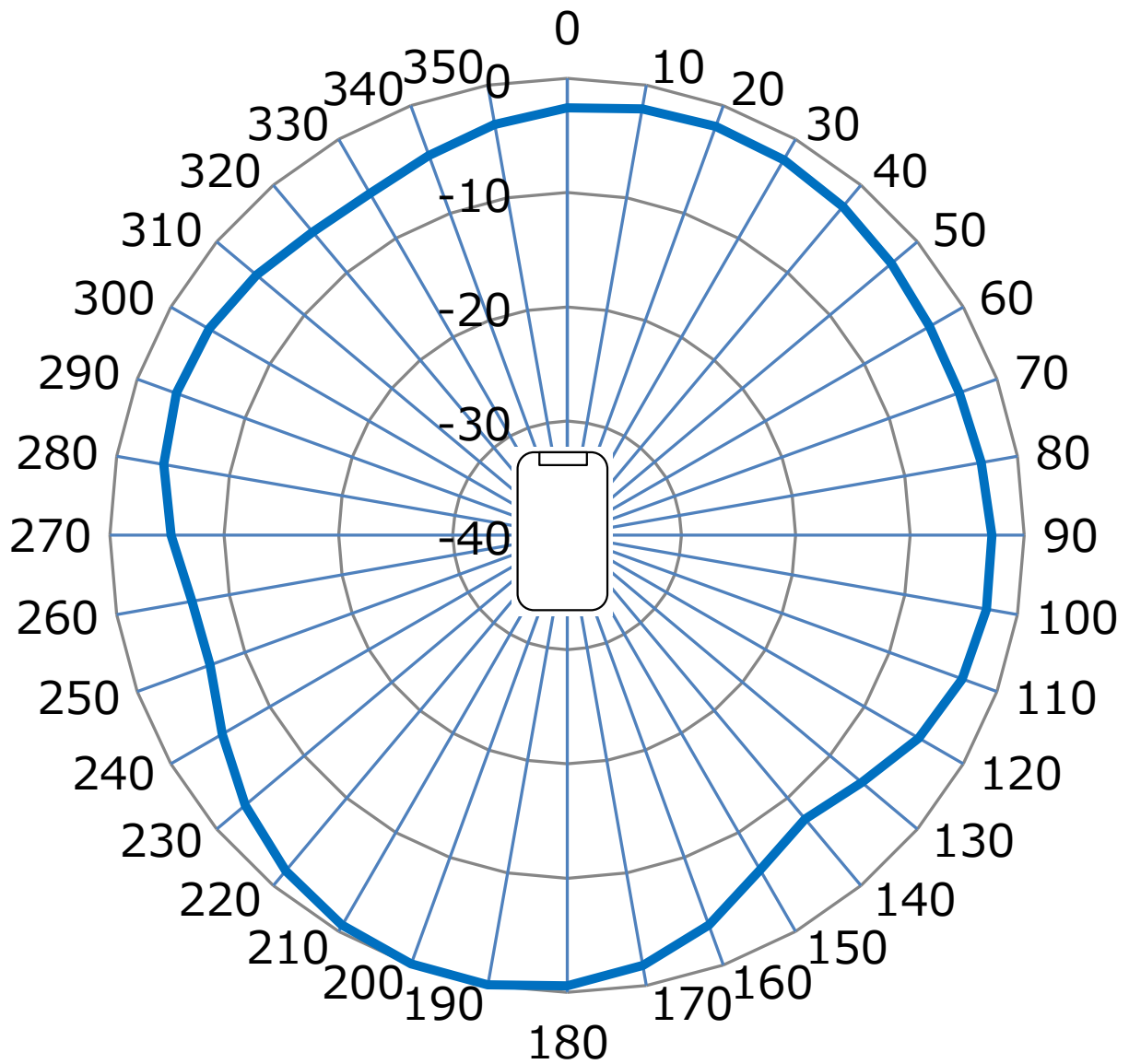

Kyocera Confidential

GSM1900 Peak +0.39[dBi] (UE : Open)

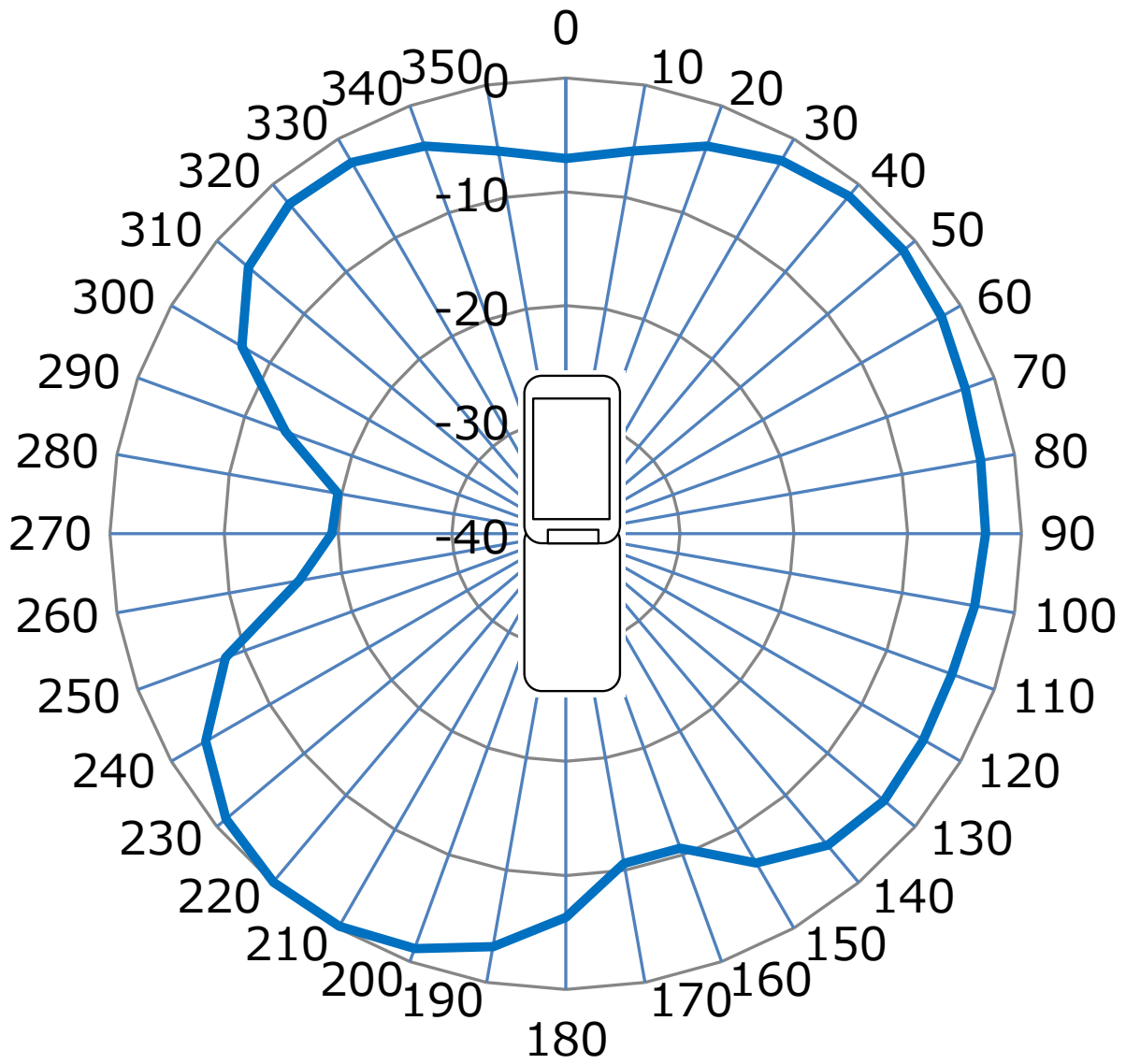

Kyocera Confidential

GSM1900 Peak -1.55[dBi] (UE : Close)

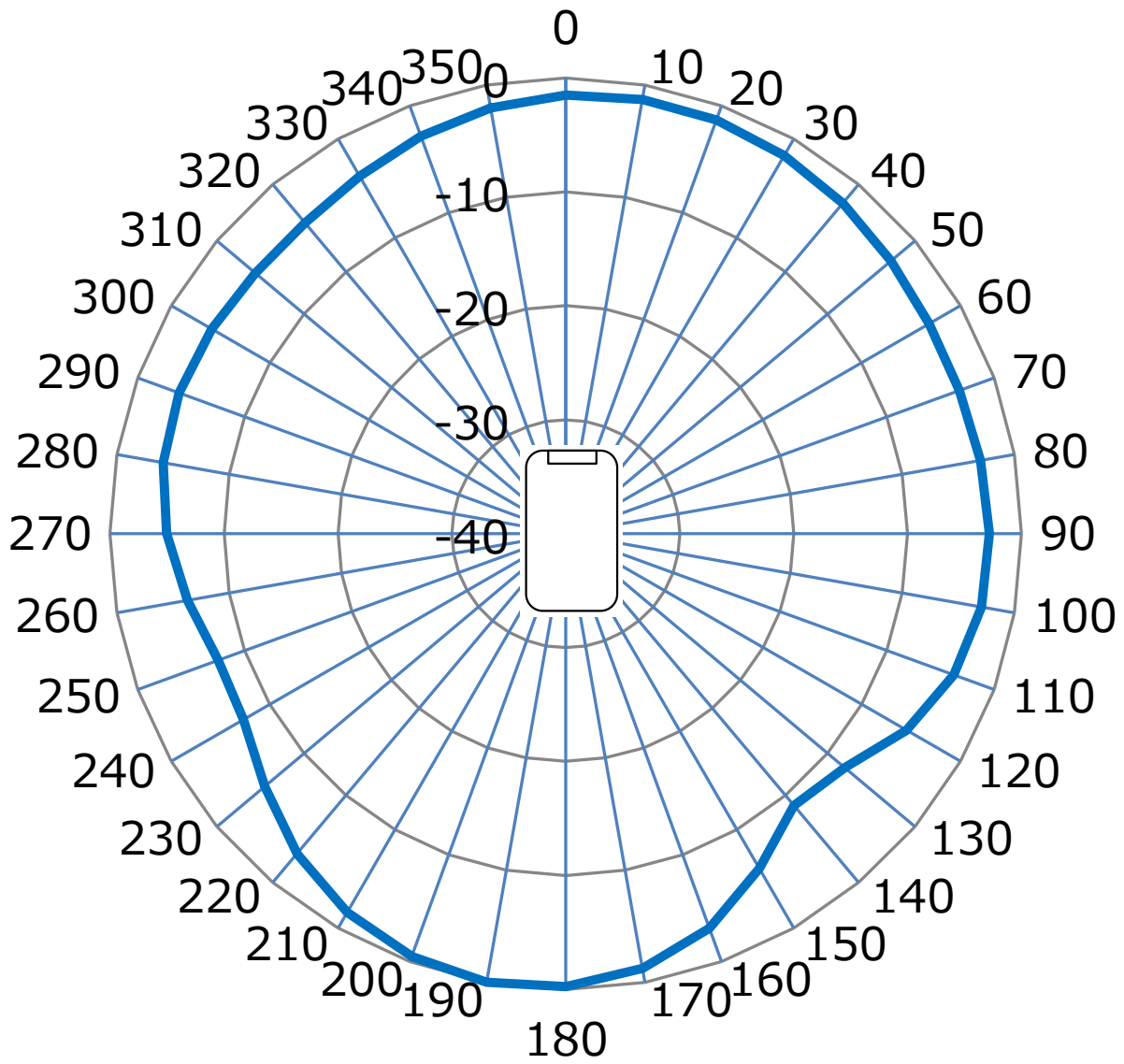

Kyocera Confidential

Bluetooth/WLAN2.4G

Peak +1.99[dBi]

(UE : Open)

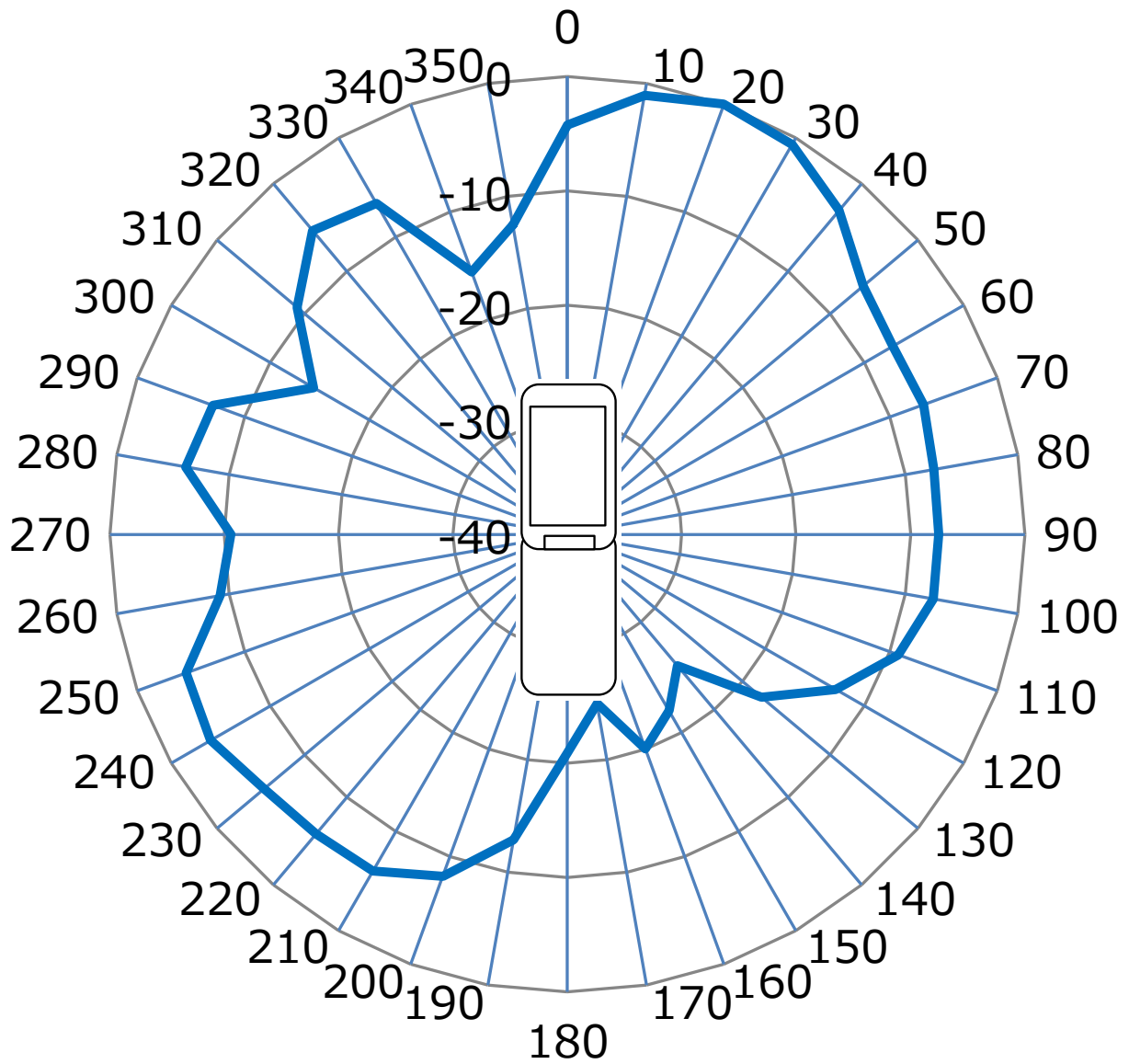

Kyocera Confidential

Bluetooth/WLAN2.4G

Peak +1.27[dBi]

(UE : Close)

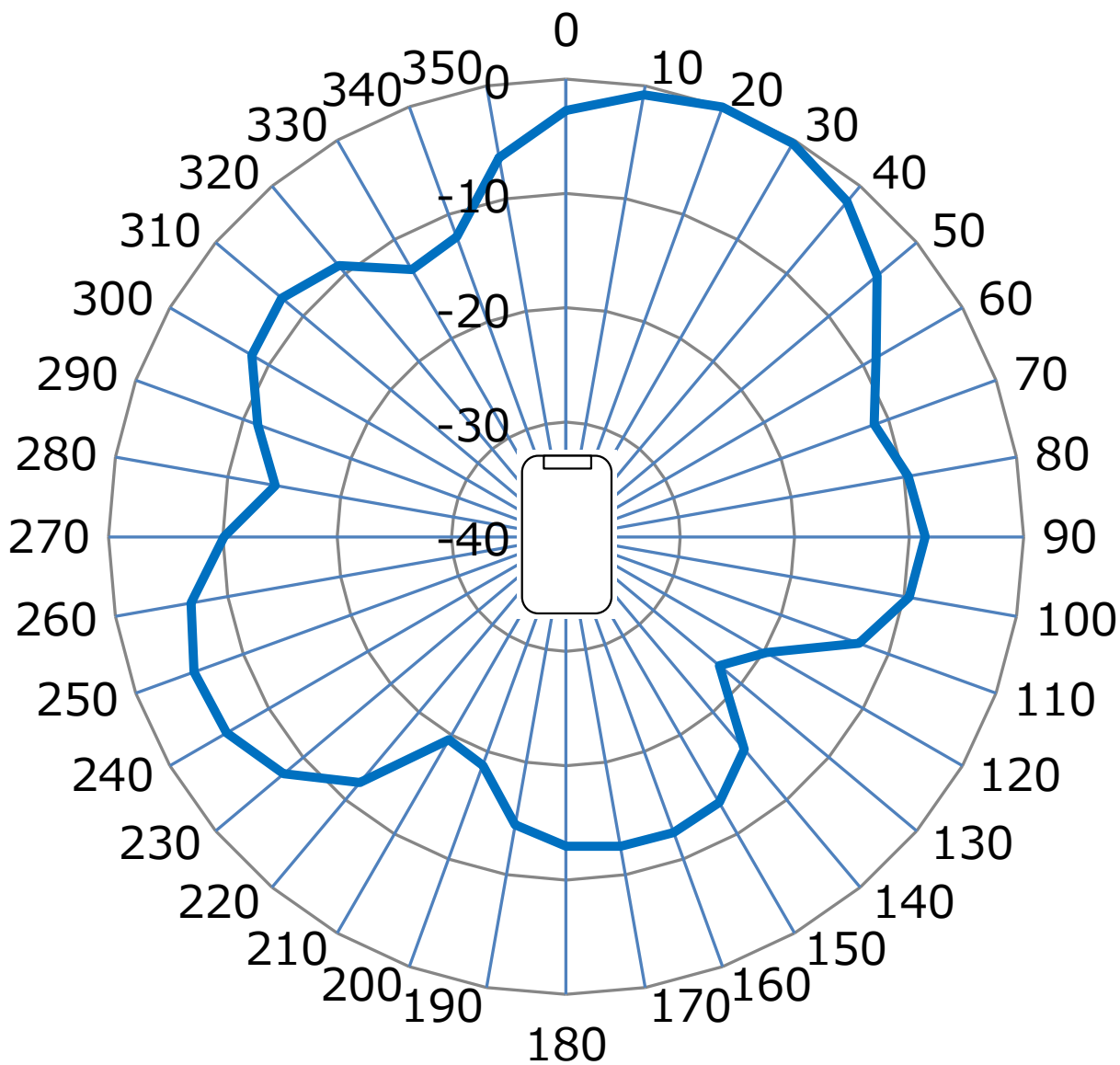

Kyocera Confidential

Antenna Gain

Main Antenna	LTE Band 1 UE:Open	+1.70 dBi
	LTE Band 1 UE:Close	-1.65 dBi
Main Antenna	LTE Band 3 UE:Open	+2.33 dBi
	LTE Band 3 UE:Close	-0.84 dBi
Main Antenna	LTE Band 12 UE:Open	-0.58 dBi
	LTE Band 12 UE:Close	-5.88 dBi
Main Antenna	LTE Band 17 UE:Open	-0.58 dBi
	LTE Band 17 UE:Close	-5.88 dBi
Main Antenna	UMTS Band 1 UE:Open	+1.70 dBi
	UMTS Band 1 UE:Close	-1.65 dBi
Main Antenna	UMTS Band 5 UE:Open	+0.81 dBi
	UMTS Band 5 UE:Close	-1.16 dBi
Main Antenna	GSM850 UE:Open	+0.81 dBi
	GSM850 UE:Close	-1.16 dBi
Main Antenna	GSM900 UE:Open	-0.03 dBi
	GSM900 UE:Close	-0.80 dBi
Main Antenna	GSM1800 UE:Open	+2.33 dBi
	GSM1800 UE:Close	-0.84 dBi
Main Antenna	GSM1900 UE:Open	+0.94 dBi
	GSM1900 UE:Close	-1.50 dBi
Bluetooth/WLAN Antenna	Bluetooth/WLAN2.4G UE:Open	+1.99 dBi
	Bluetooth/WLAN2.4G UE:Close	+1.27 dBi

LTE Band1 Peak +1.70[dBi] (UE : Open)

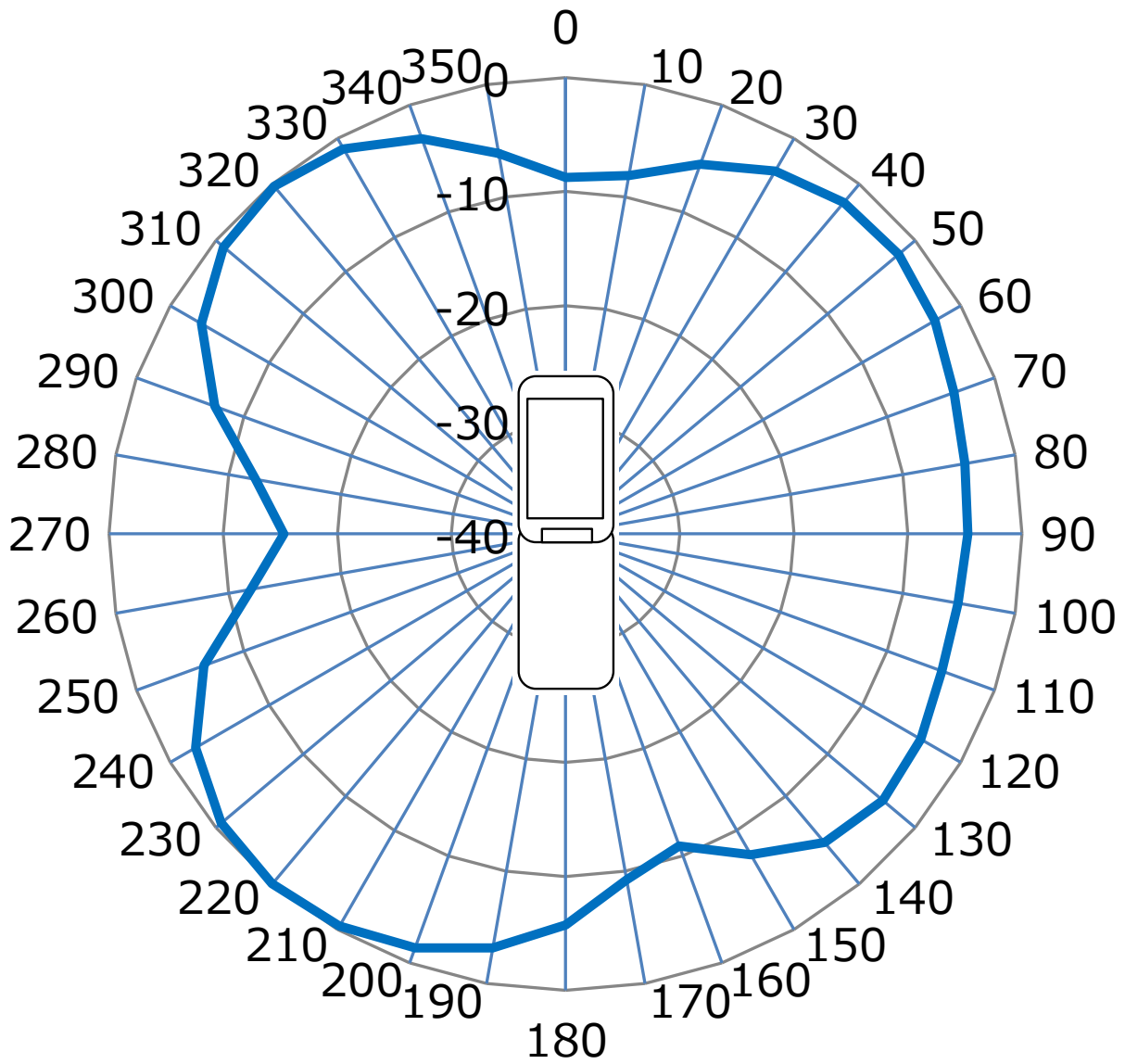

Kyocera Confidential

LTE Band1 Peak -1.65[dBi] (UE : Close)

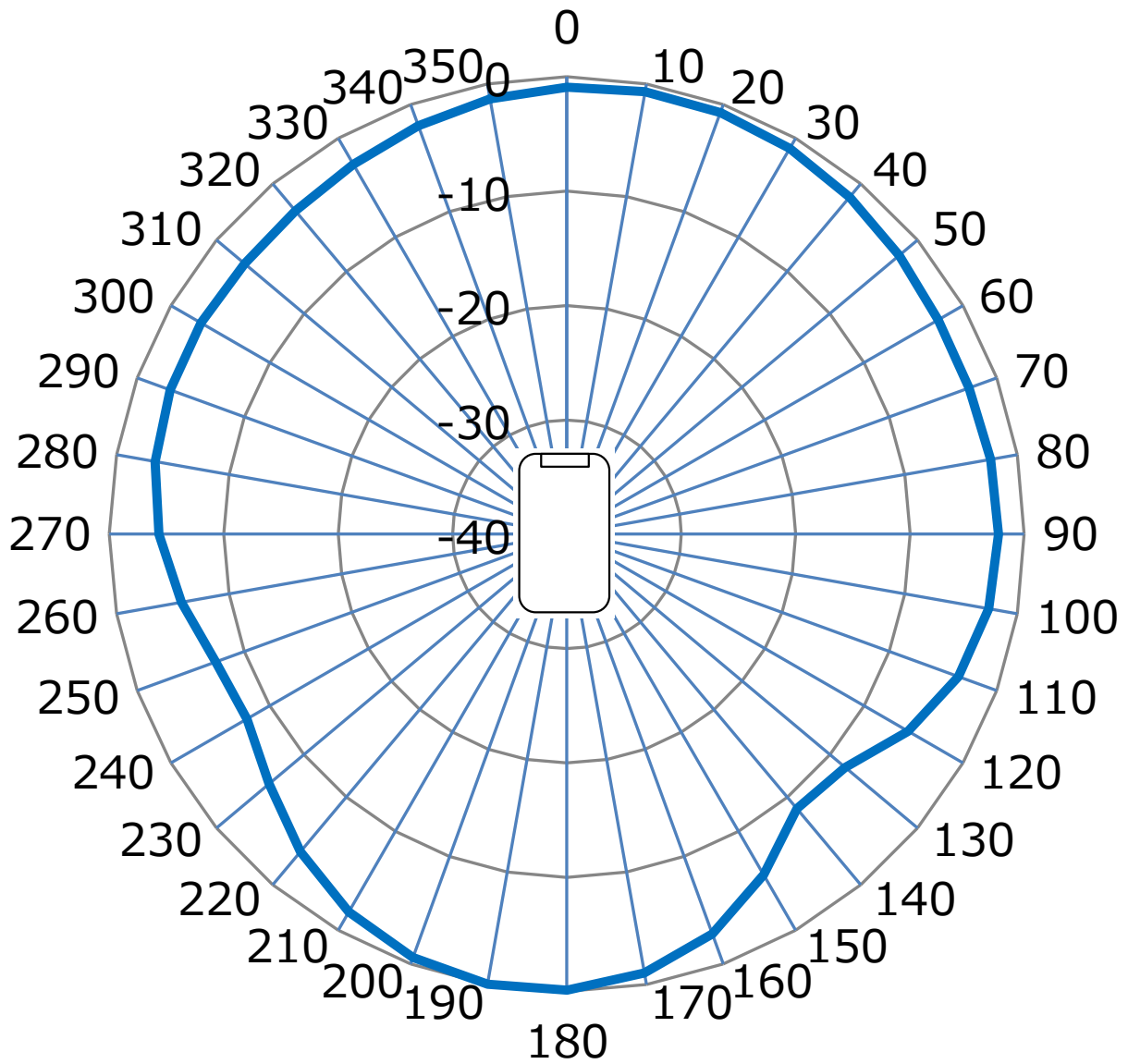

Kyocera Confidential

LTE Band3 Peak +2.33[dBi] (UE : Open)

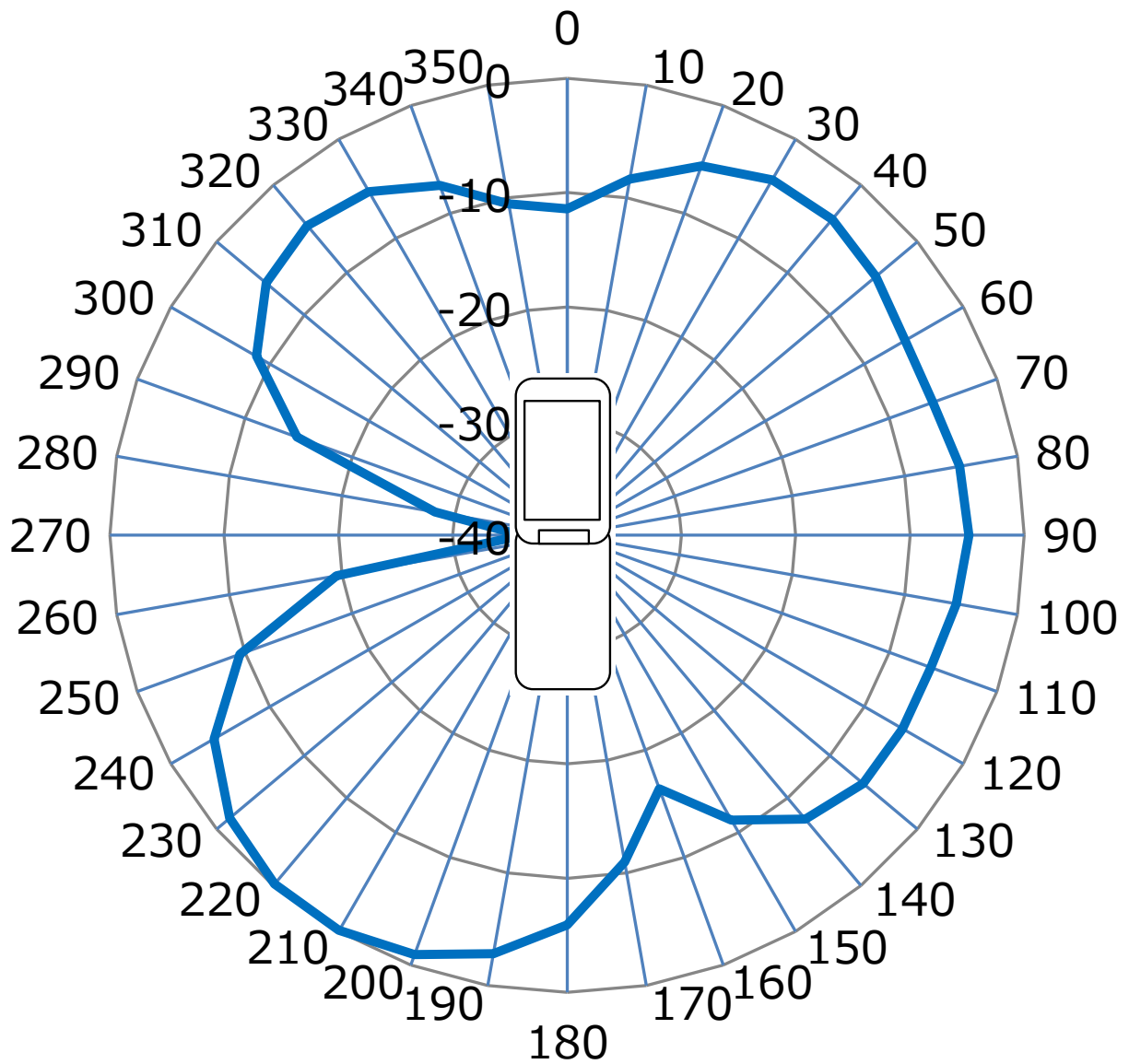

Kyocera Confidential

LTE Band3 Peak -0.84[dBi] (UE : Close)

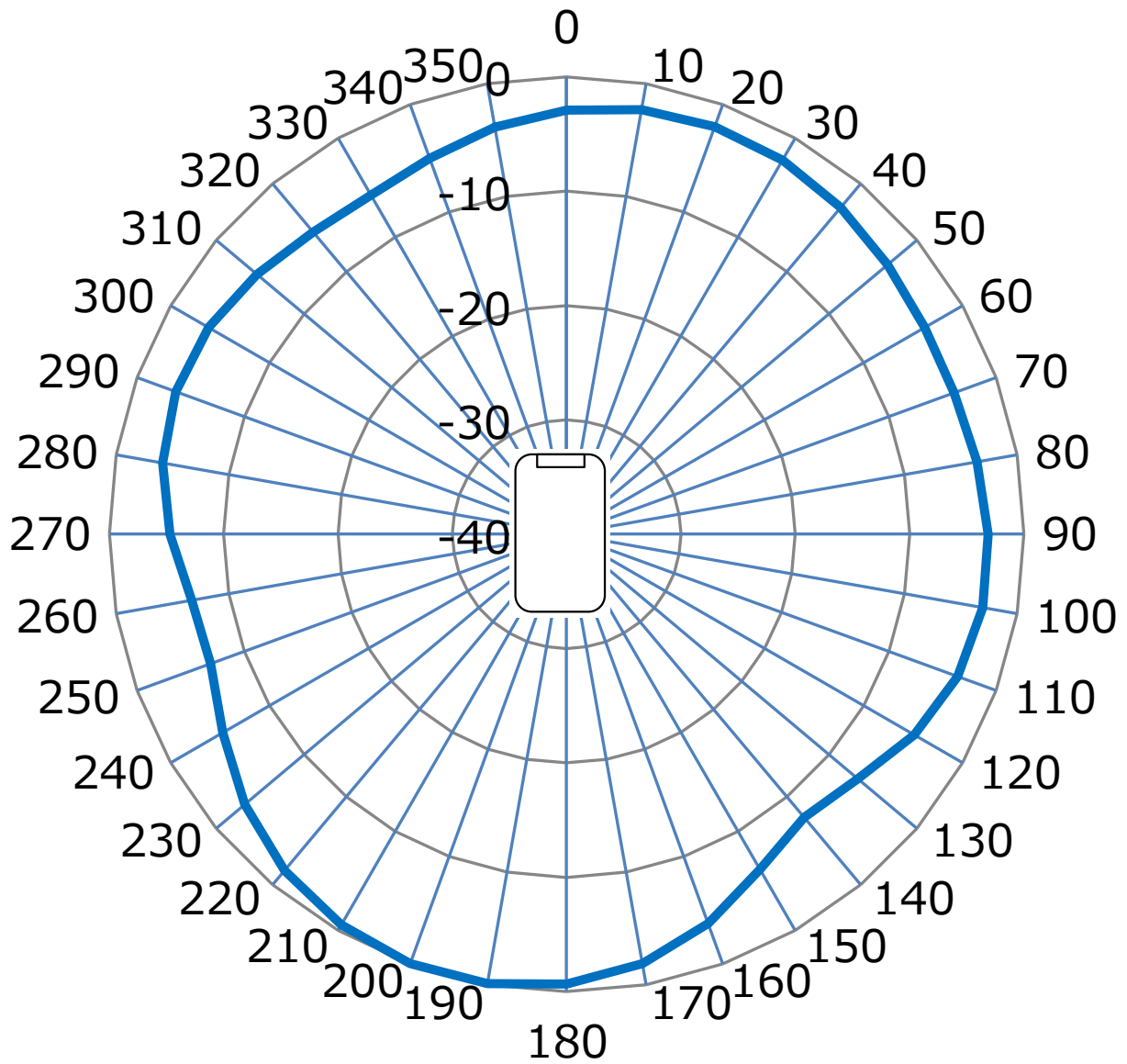

Kyocera Confidential

LTE Band12 Peak -0.58[dBi] (UE : Open)

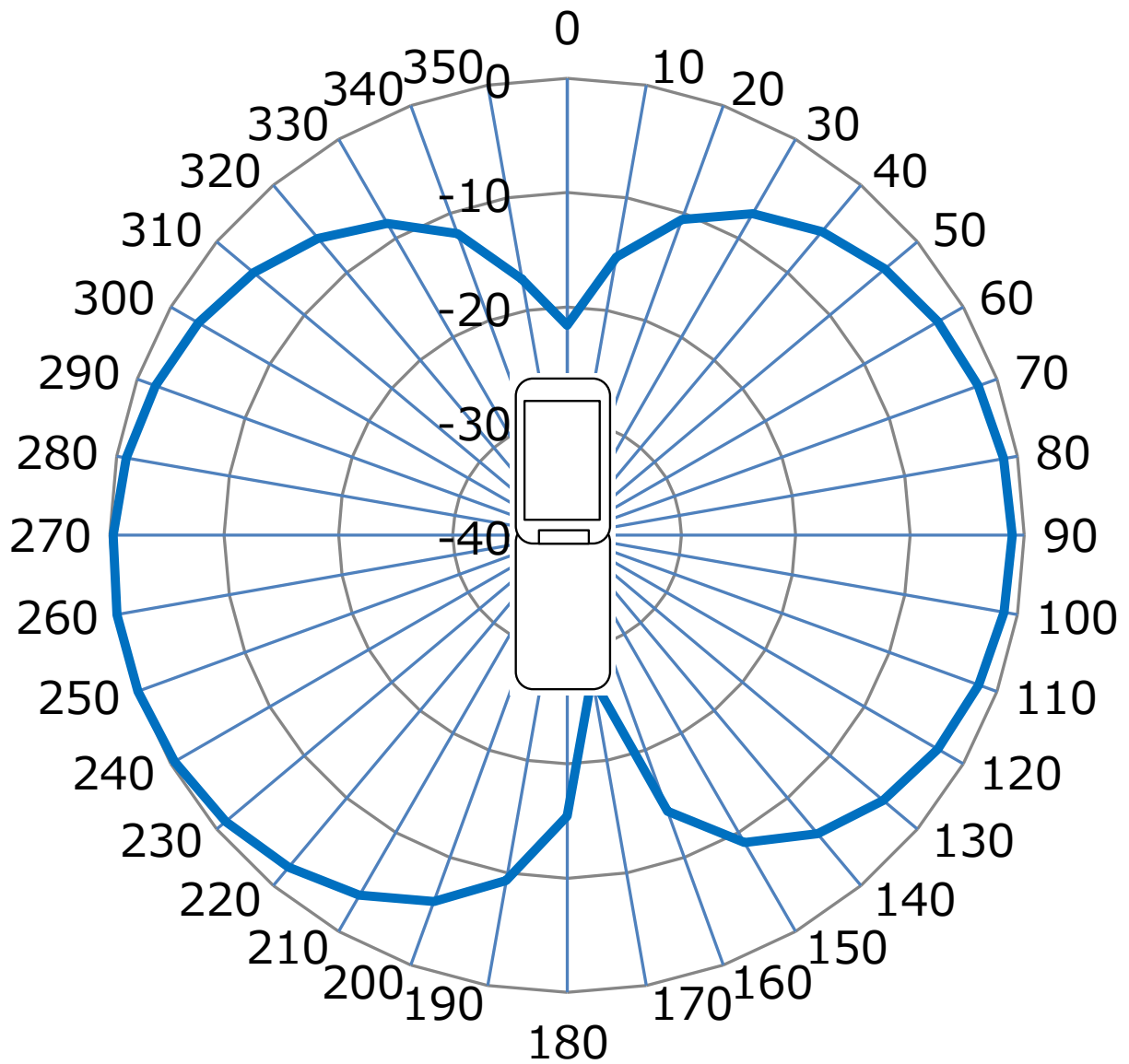

Kyocera Confidential

LTE Band12 Peak -5.88[dBi] (UE : Close)

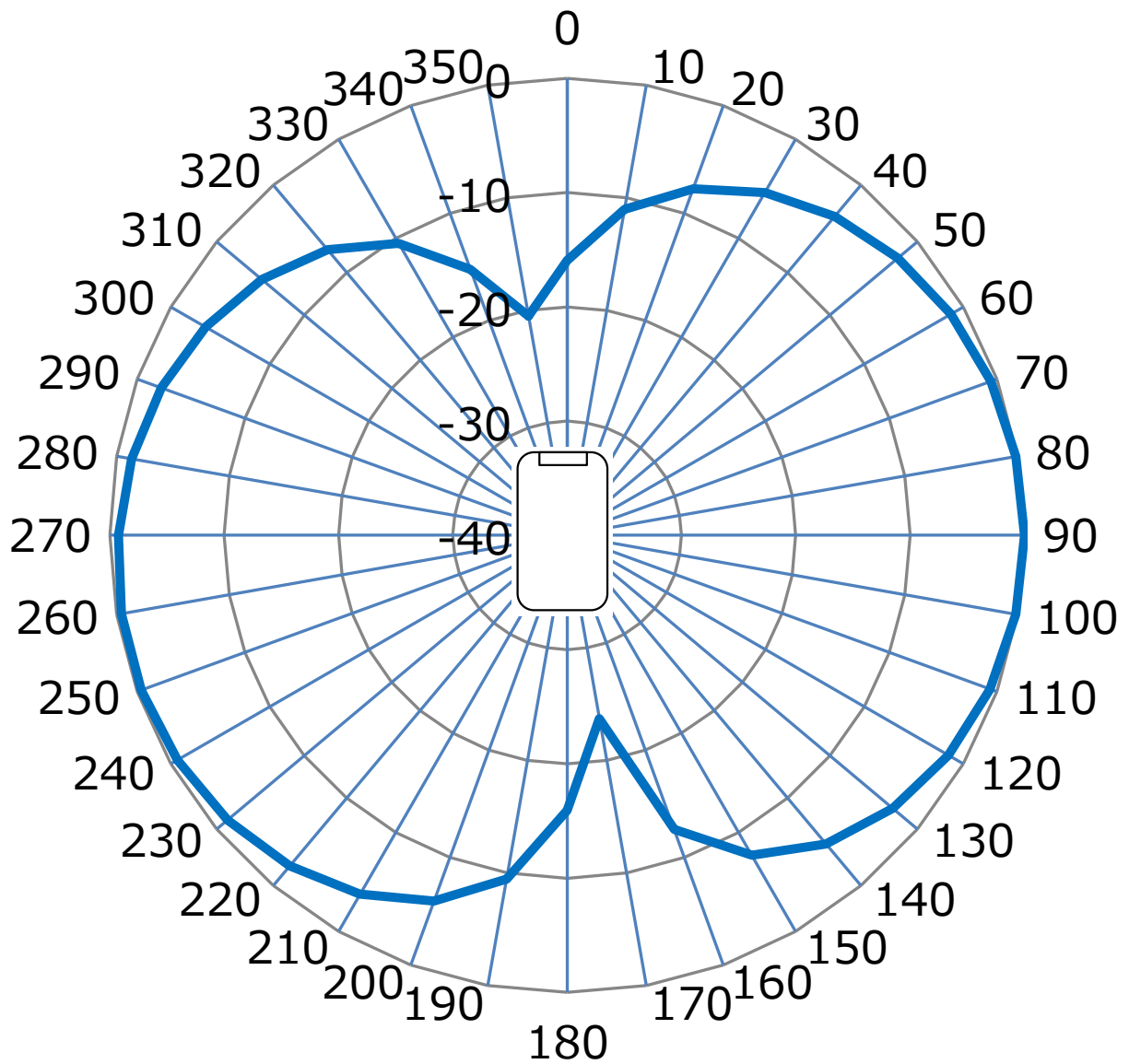

Kyocera Confidential

LTE Band17 Peak -0.58[dBi] (UE : Open)

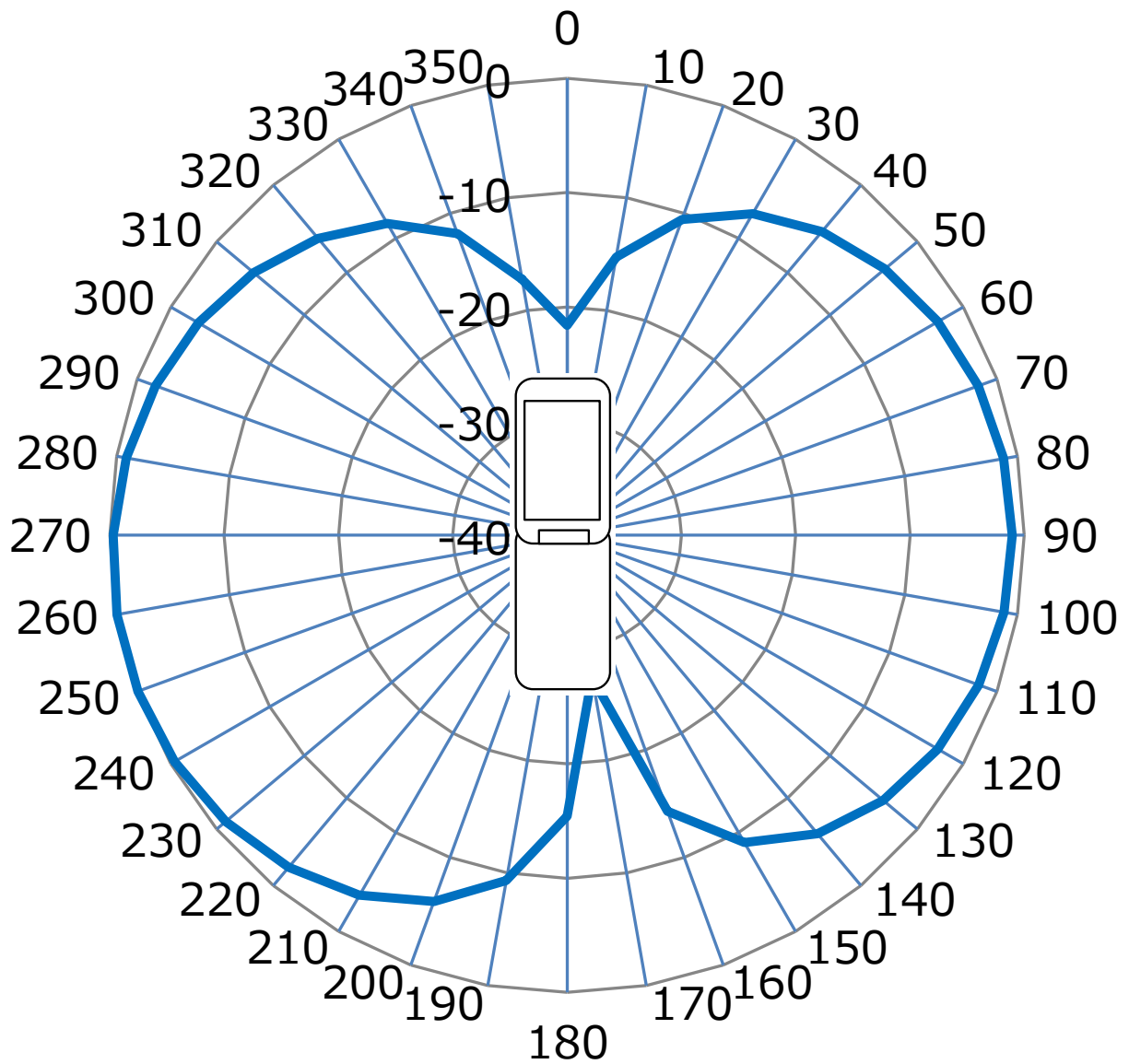

Kyocera Confidential

LTE Band17 Peak -5.88[dBi] (UE : Close)

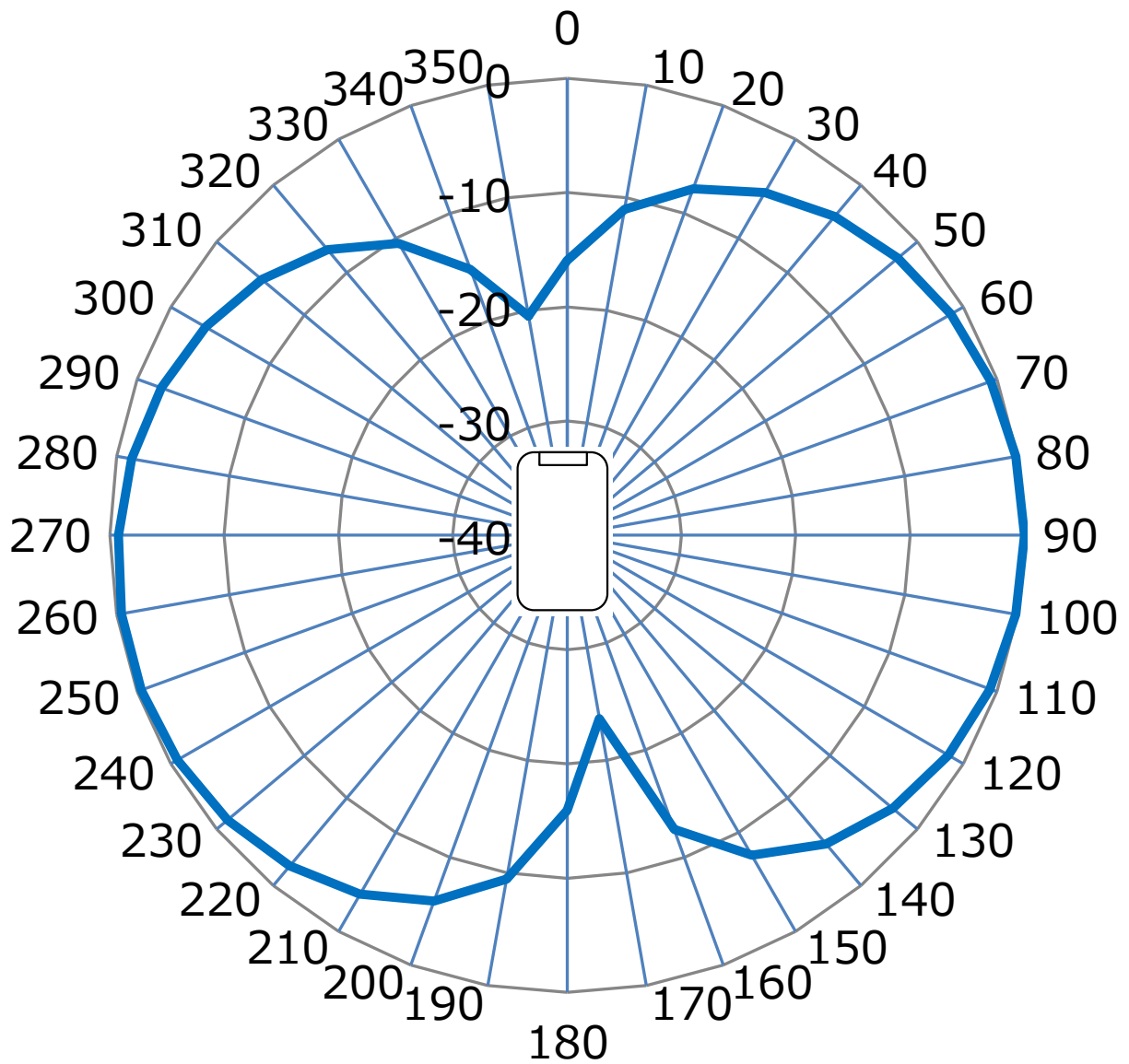

Kyocera Confidential

UMTS Band1 Peak +1.70[dBi] (UE : Open)

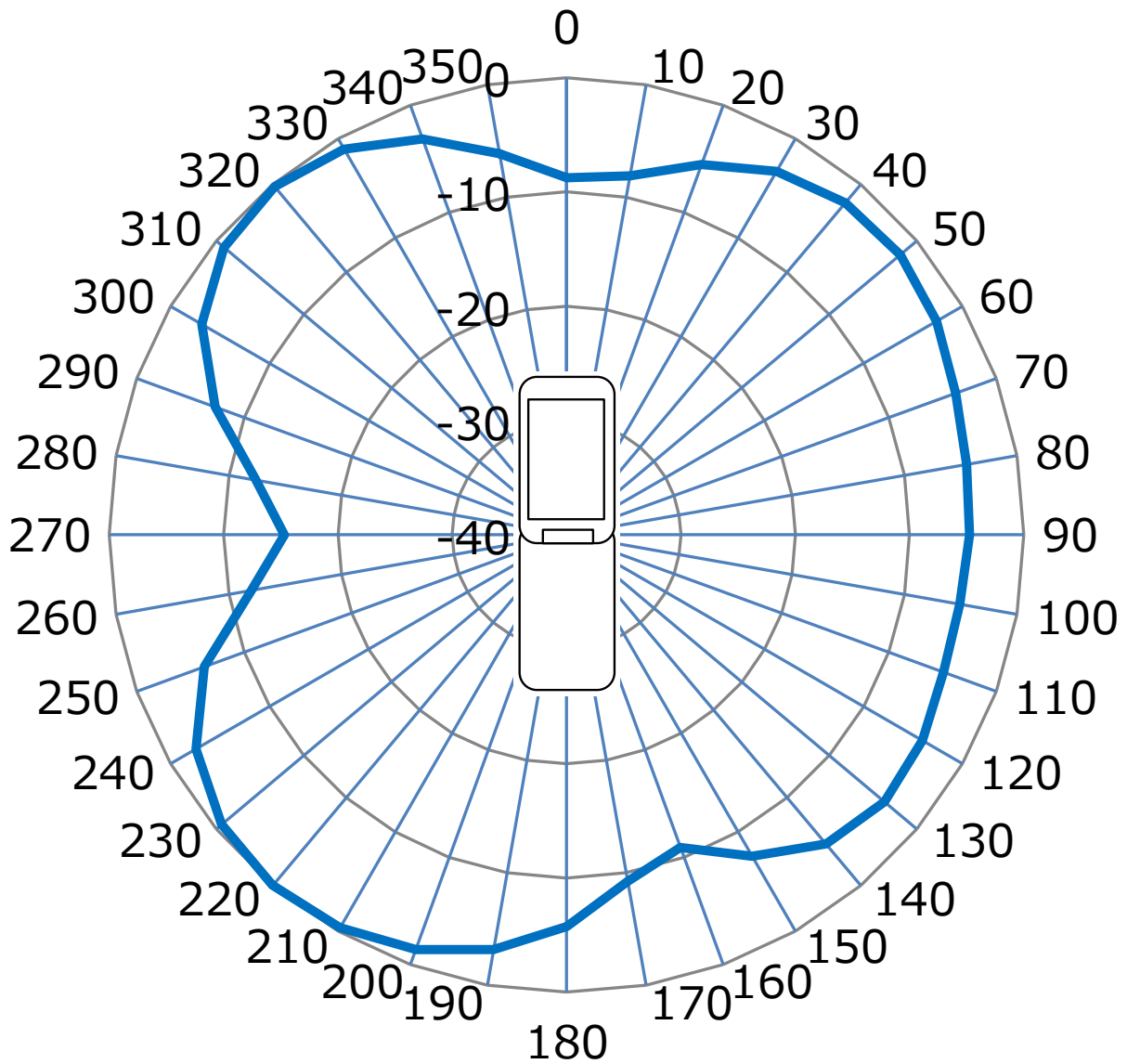

Kyocera Confidential

UMTS Band1 Peak -1.65[dBi] (UE : Close)

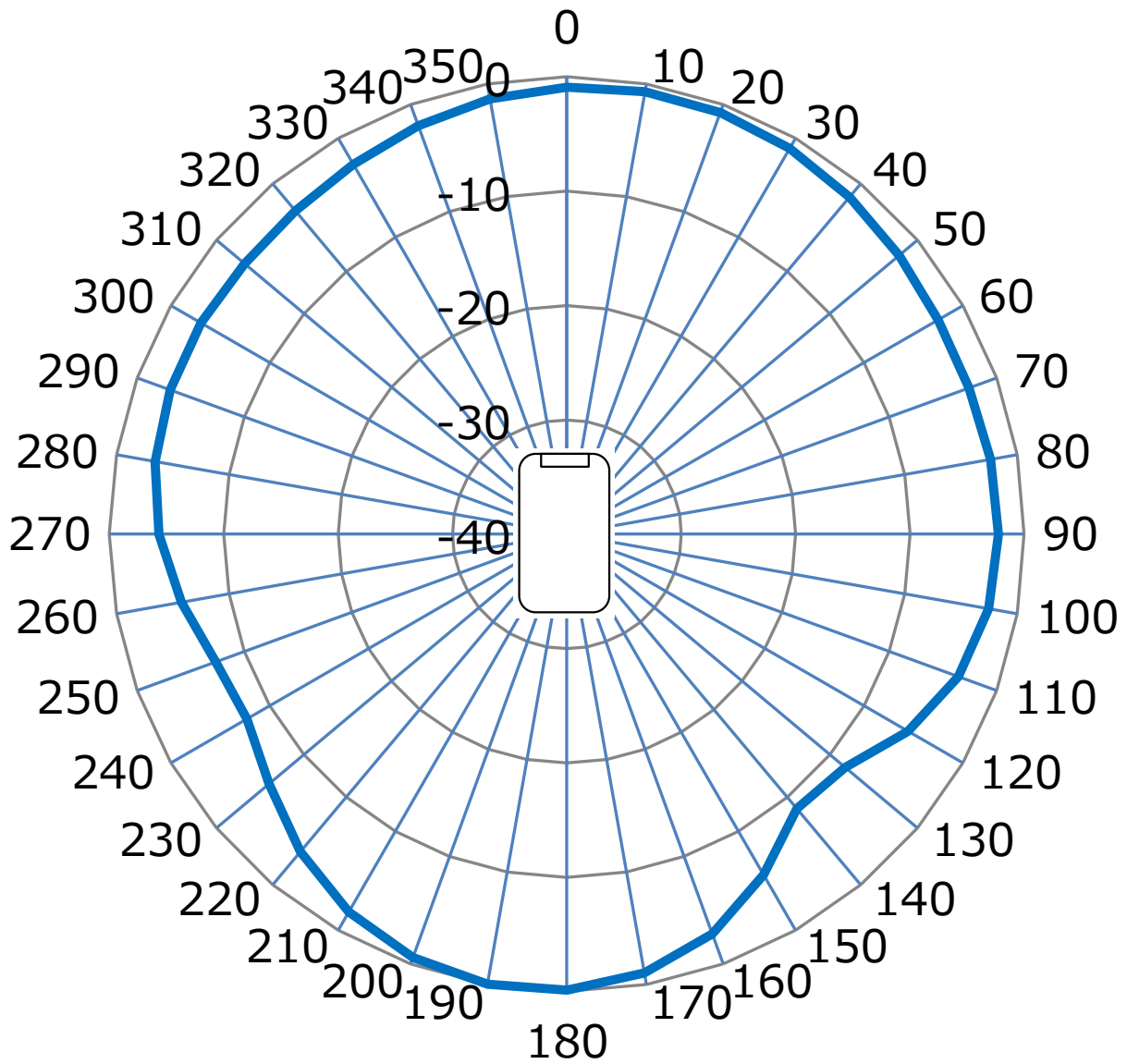

Kyocera Confidential

UMTS Band5 Peak +0.81[dBi] (UE : Open)

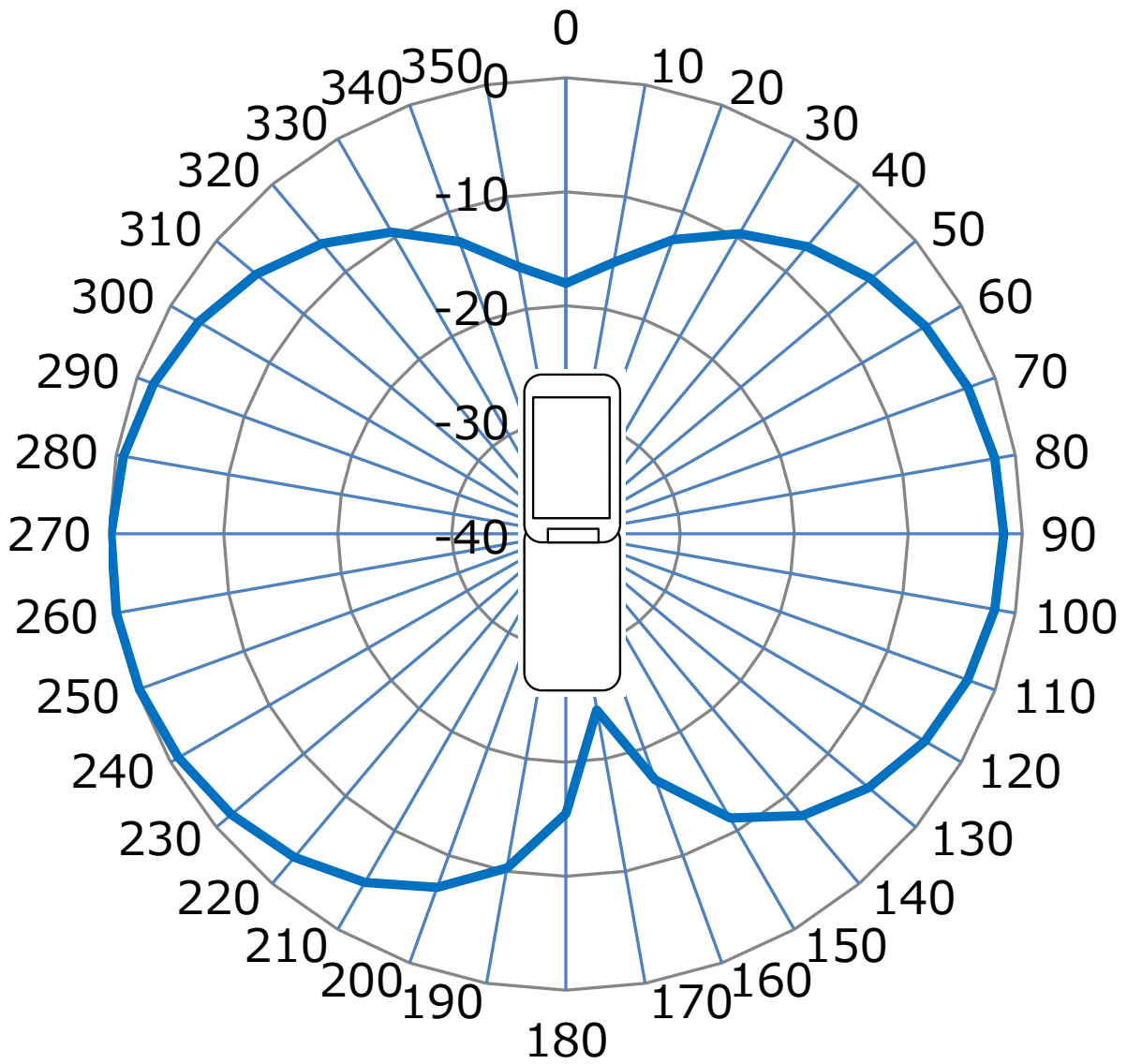

Kyocera Confidential

UMTS Band5 Peak -1.16[dBi] (UE : Close)

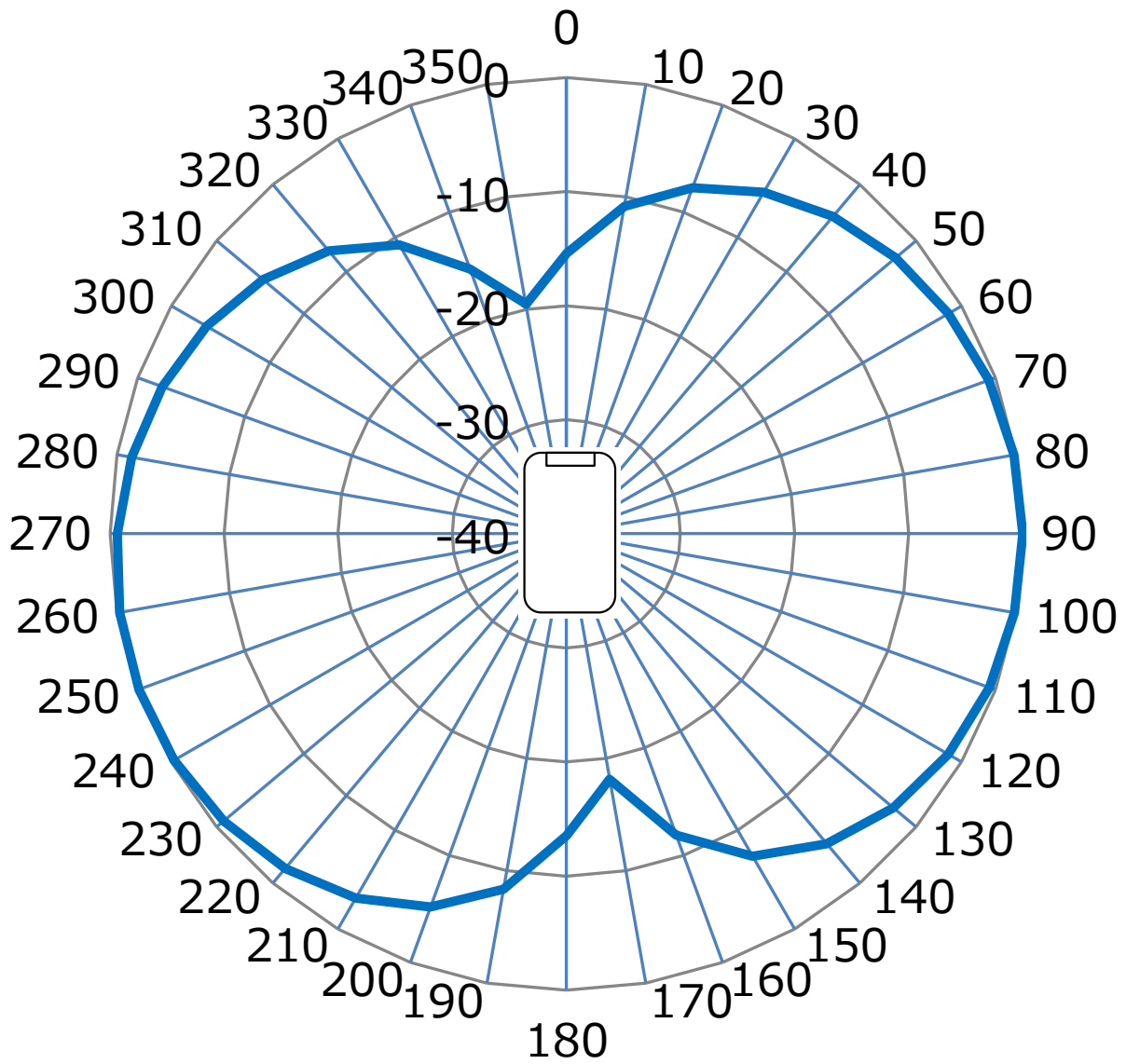

Kyocera Confidential

GSM850 Peak +0.81[dBi] (UE : Open)

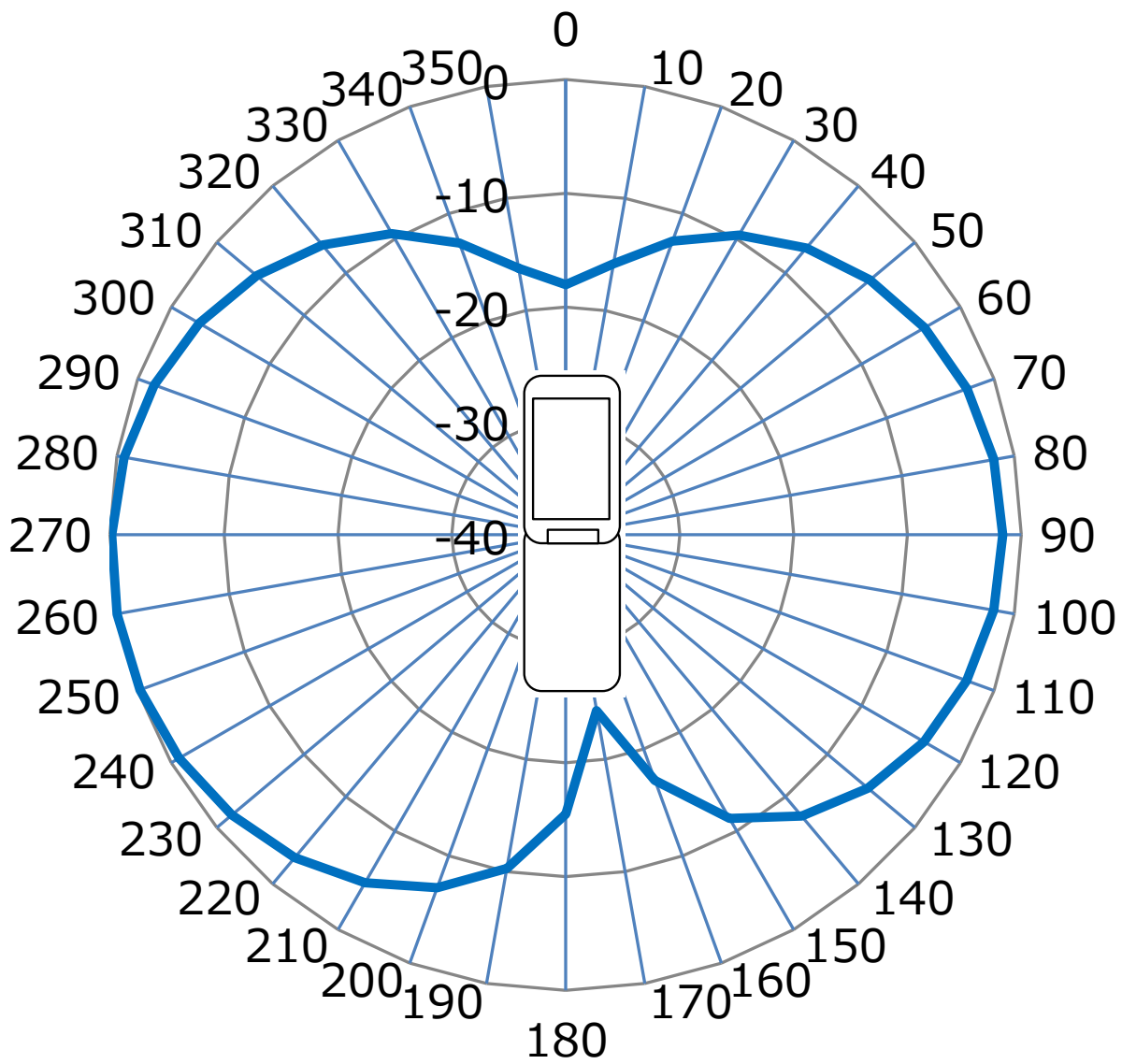

Kyocera Confidential

GSM850 Peak -1.16 [dBi] (UE : Close)

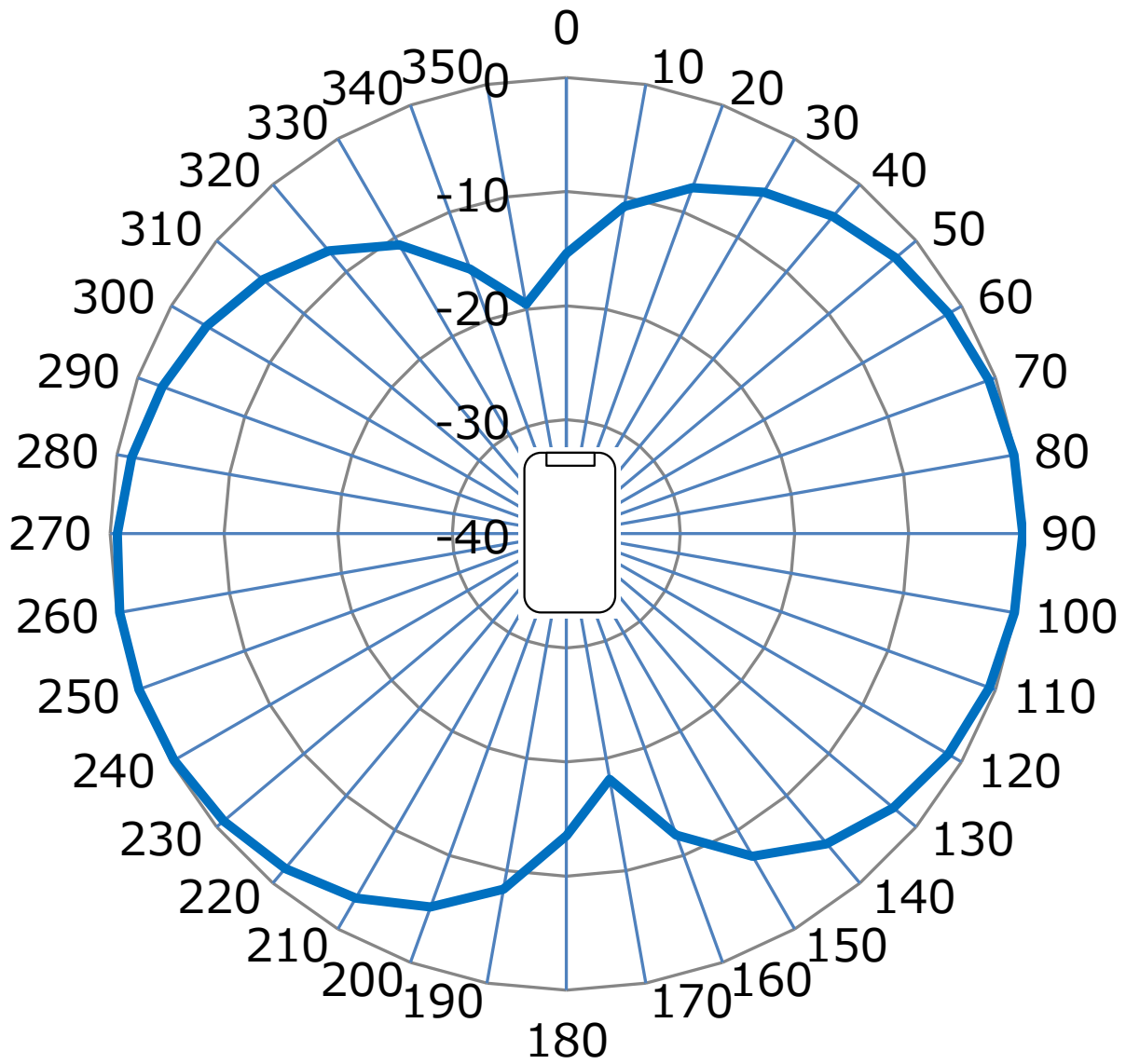

Kyocera Confidential

GSM900 Peak -0.03[dBi] (UE : Open)

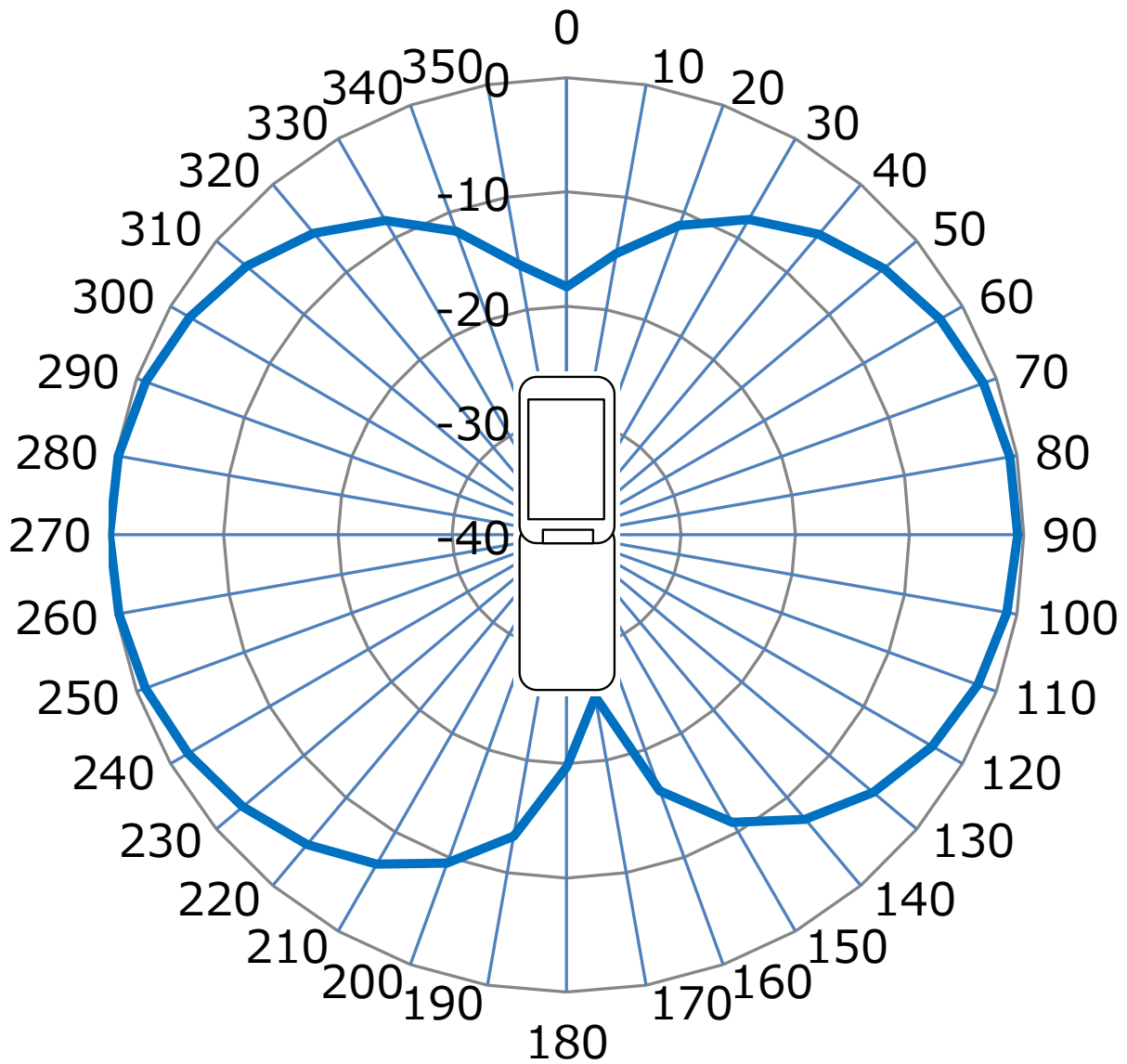

Kyocera Confidential

GSM900 Peak -0.80[dBi] (UE : Close)

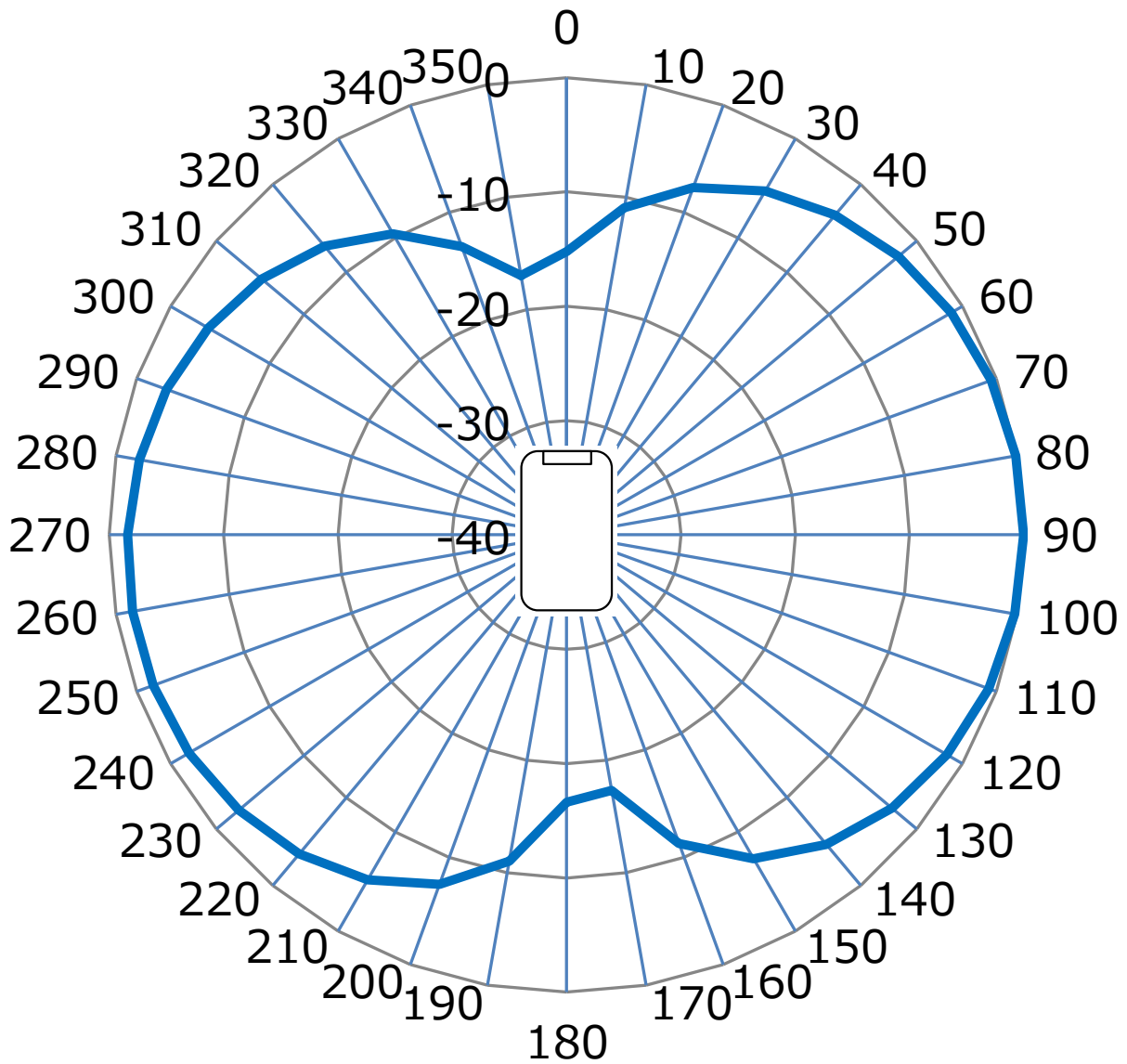

Kyocera Confidential

GSM1800 Peak +2.33[dBi] (UE : Open)

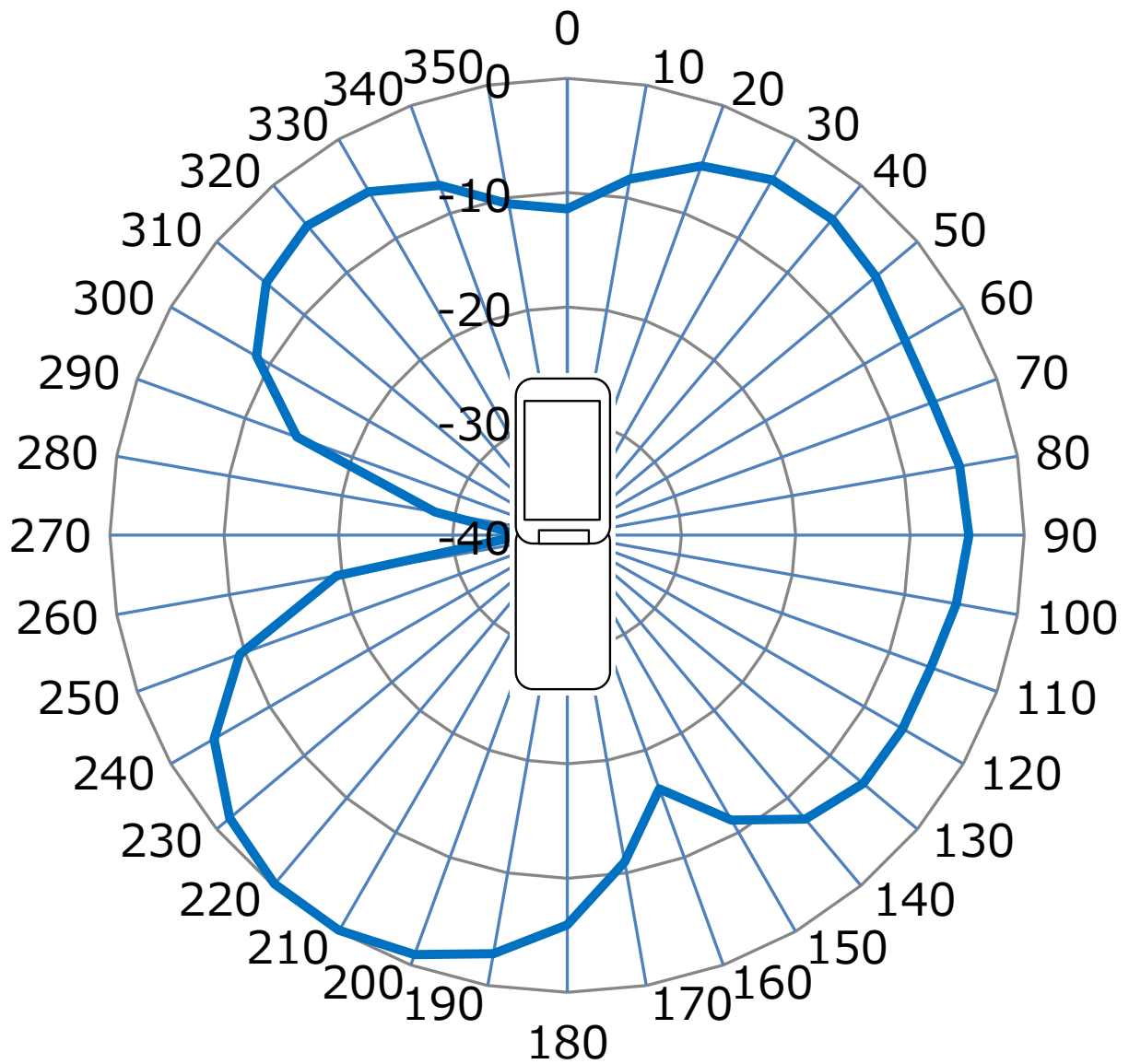

Kyocera Confidential

GSM1800 Peak -0.84[dBi] (UE : Close)

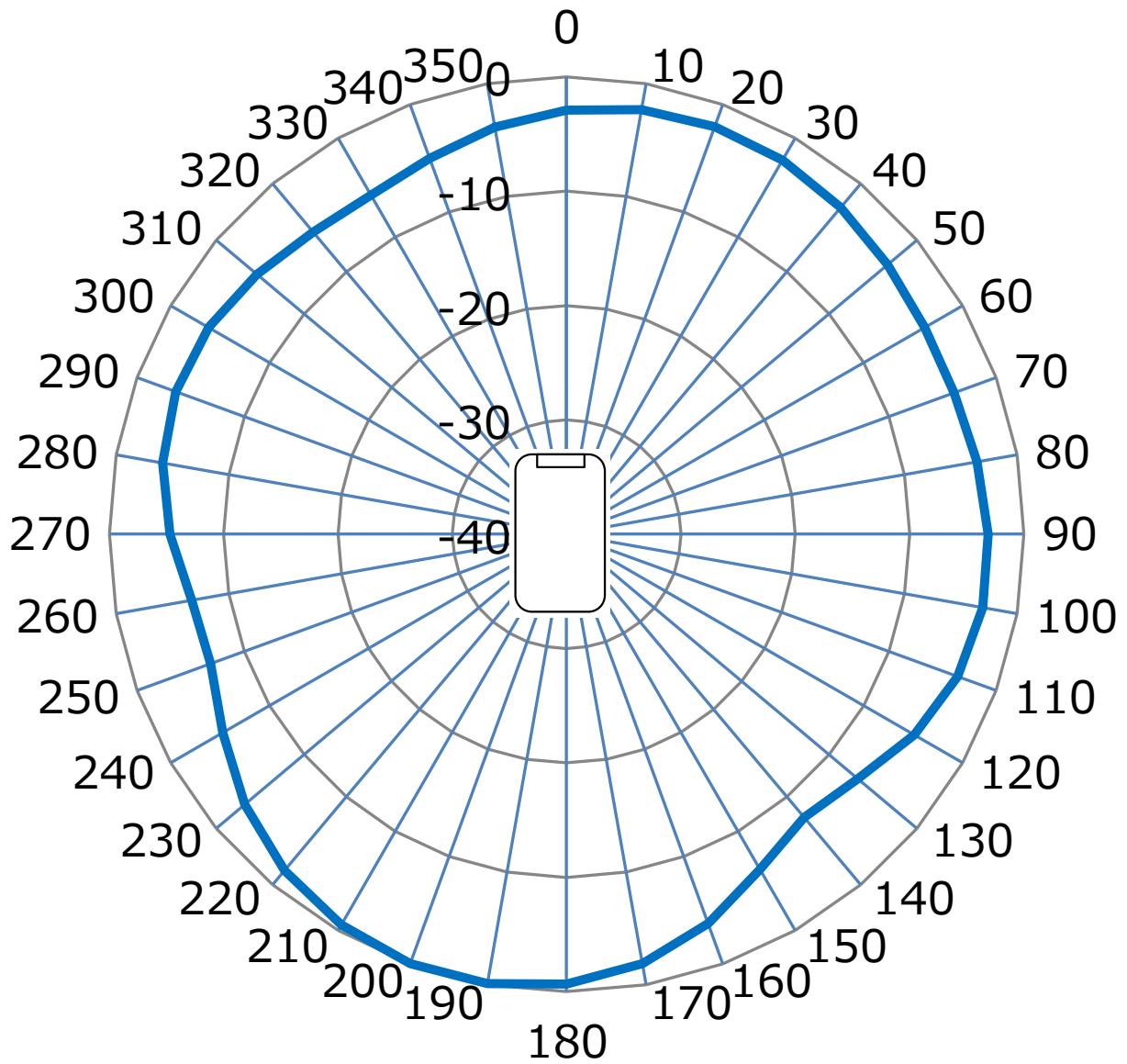

Kyocera Confidential

GSM1900 Peak +0.94[dBi] (UE : Open)

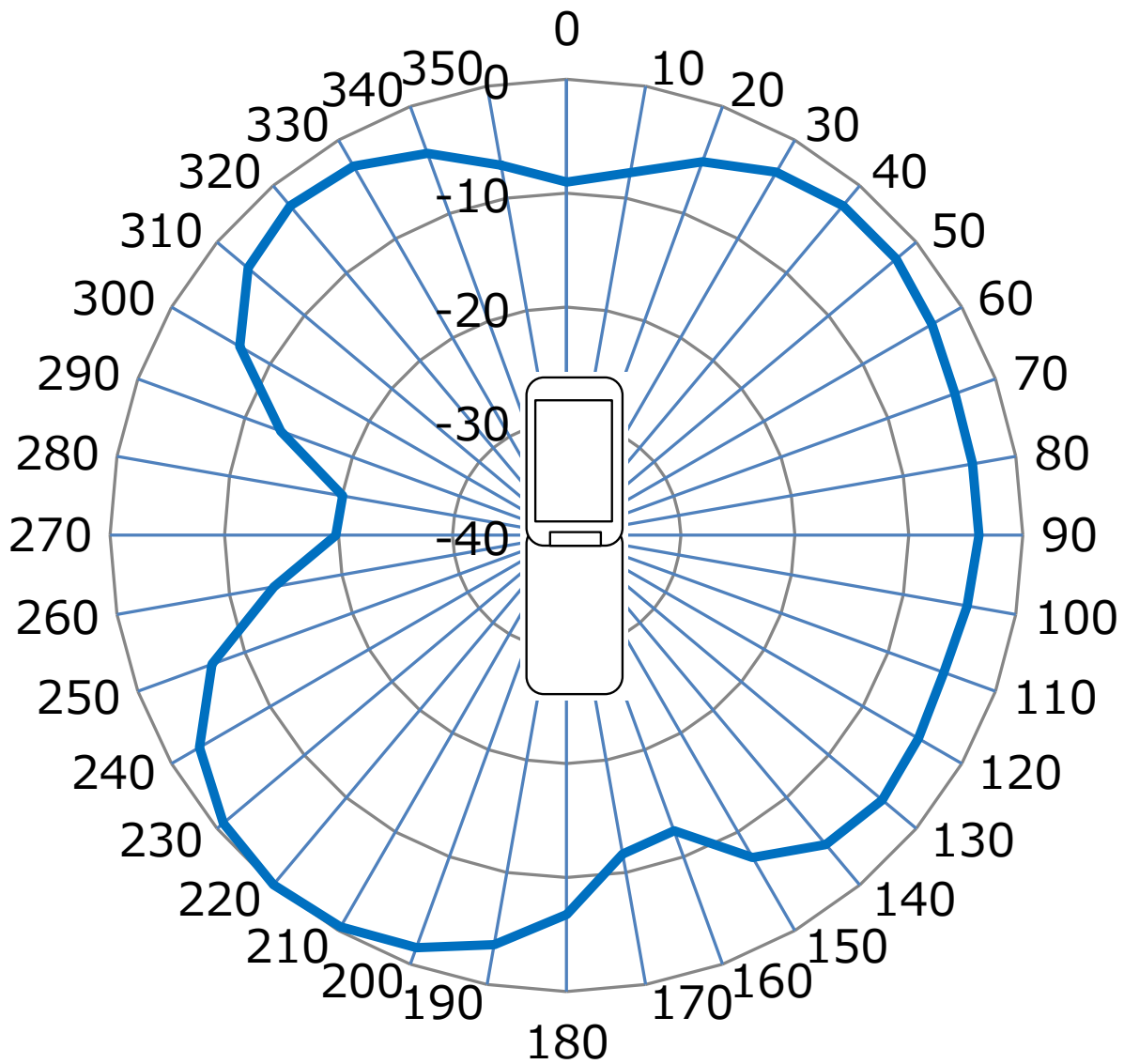

Kyocera Confidential

GSM1900 Peak -1.50[dBi] (UE : Close)

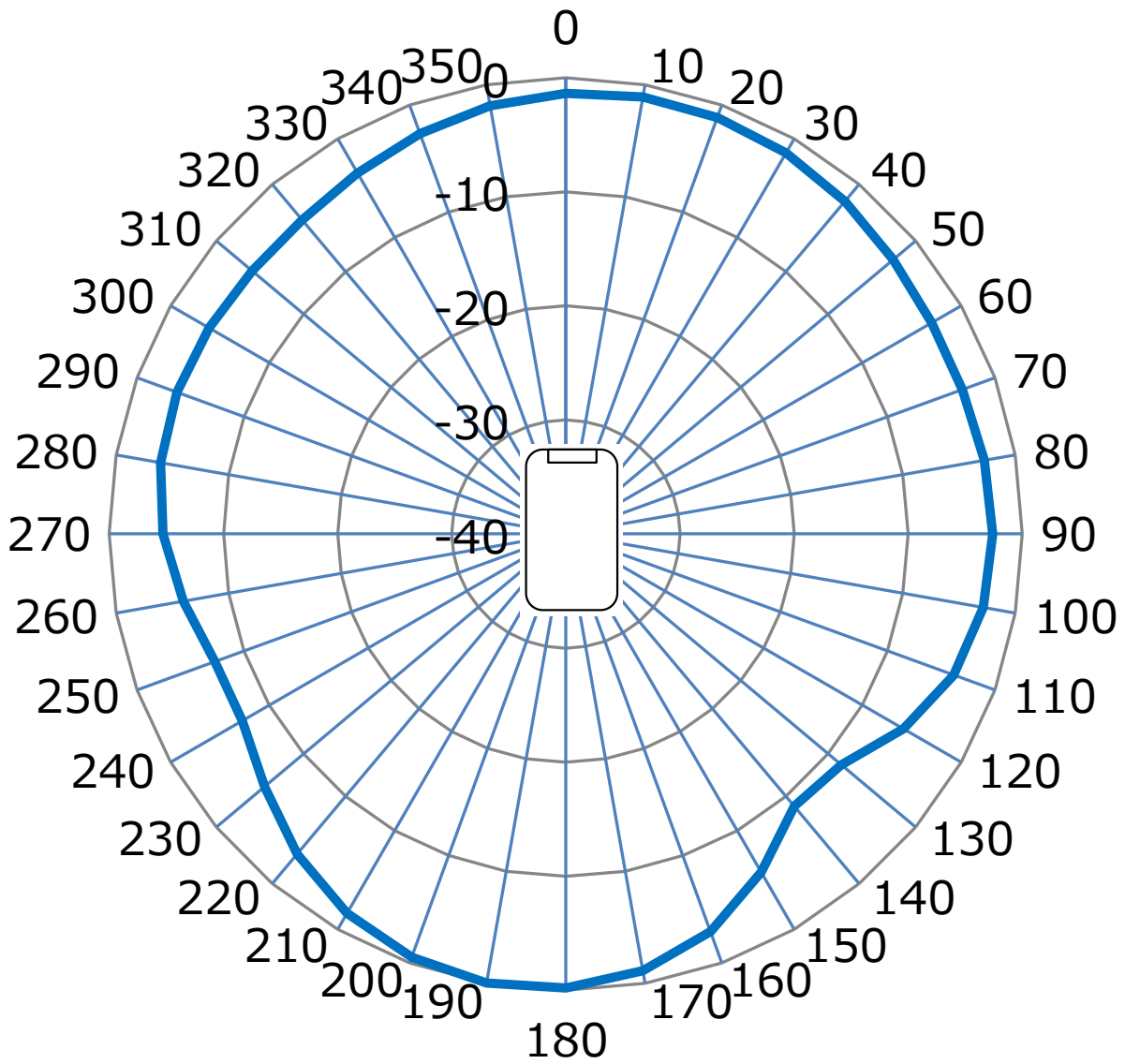

Kyocera Confidential

Bluetooth/WLAN2.4G

Peak +1.99[dBi]

(UE : Open)

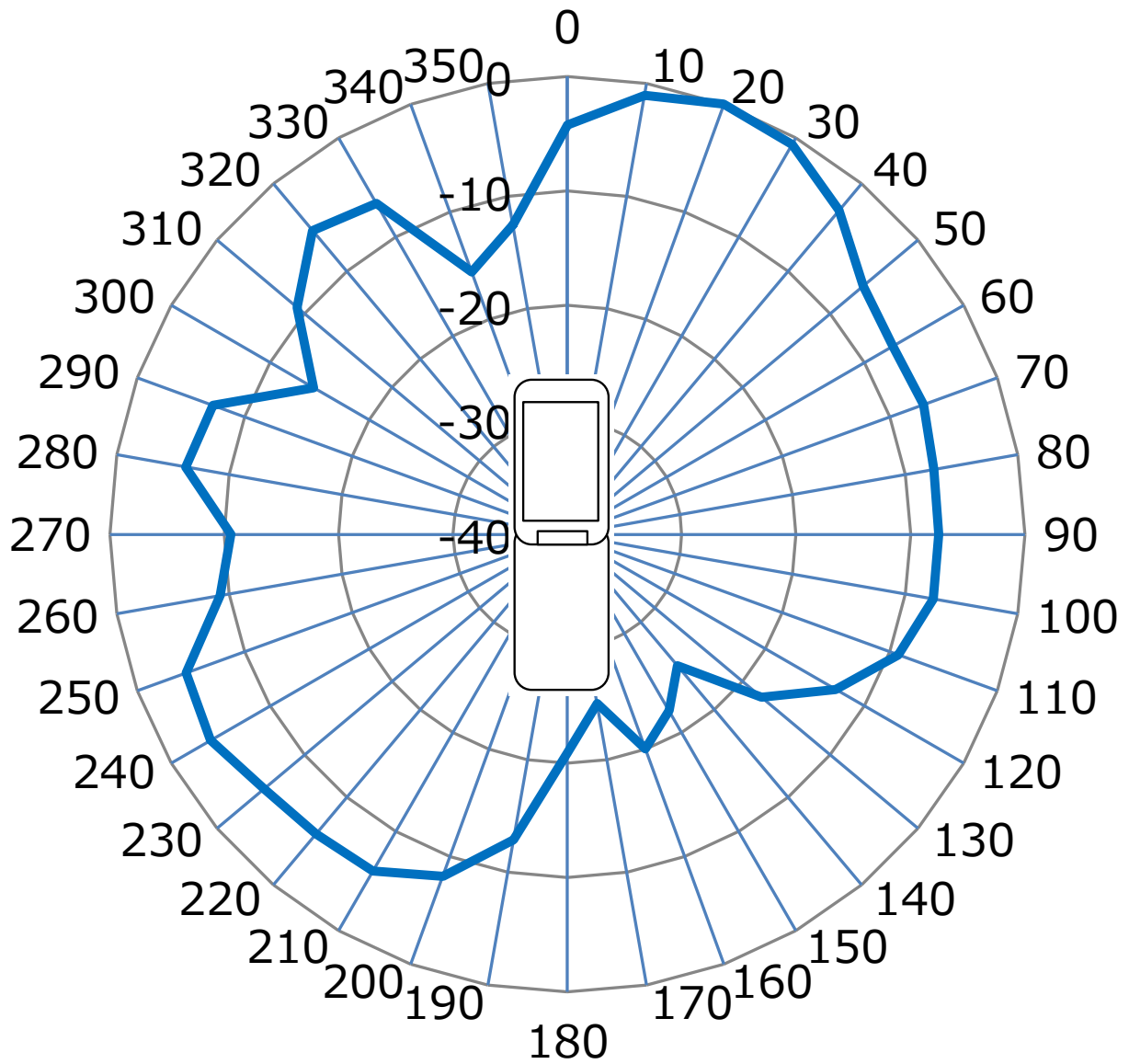

Kyocera Confidential

Bluetooth/WLAN2.4G

Peak +1.27[dBi]

(UE : Close)

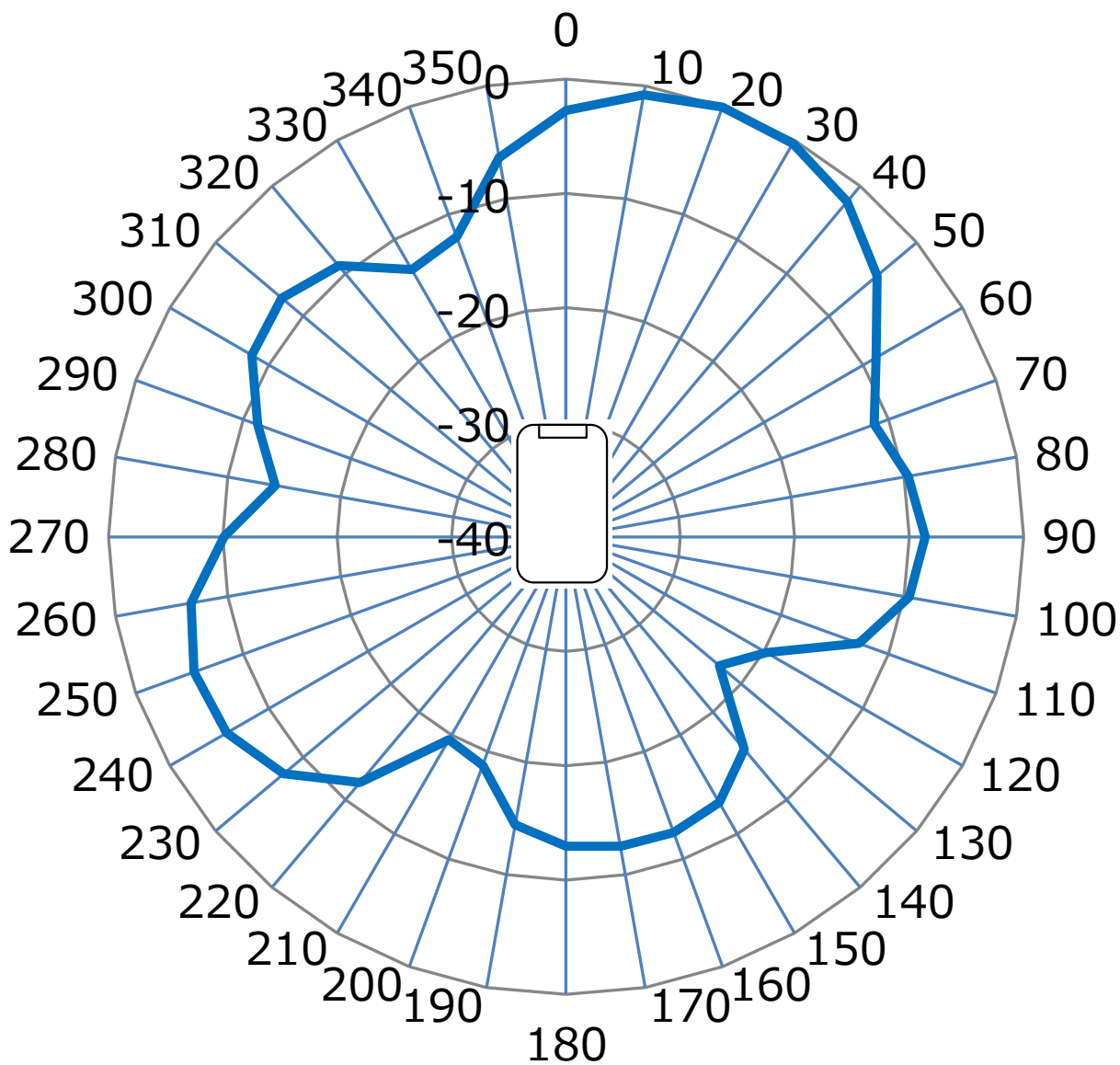

Kyocera Confidential

ANTENNA DISTANCE

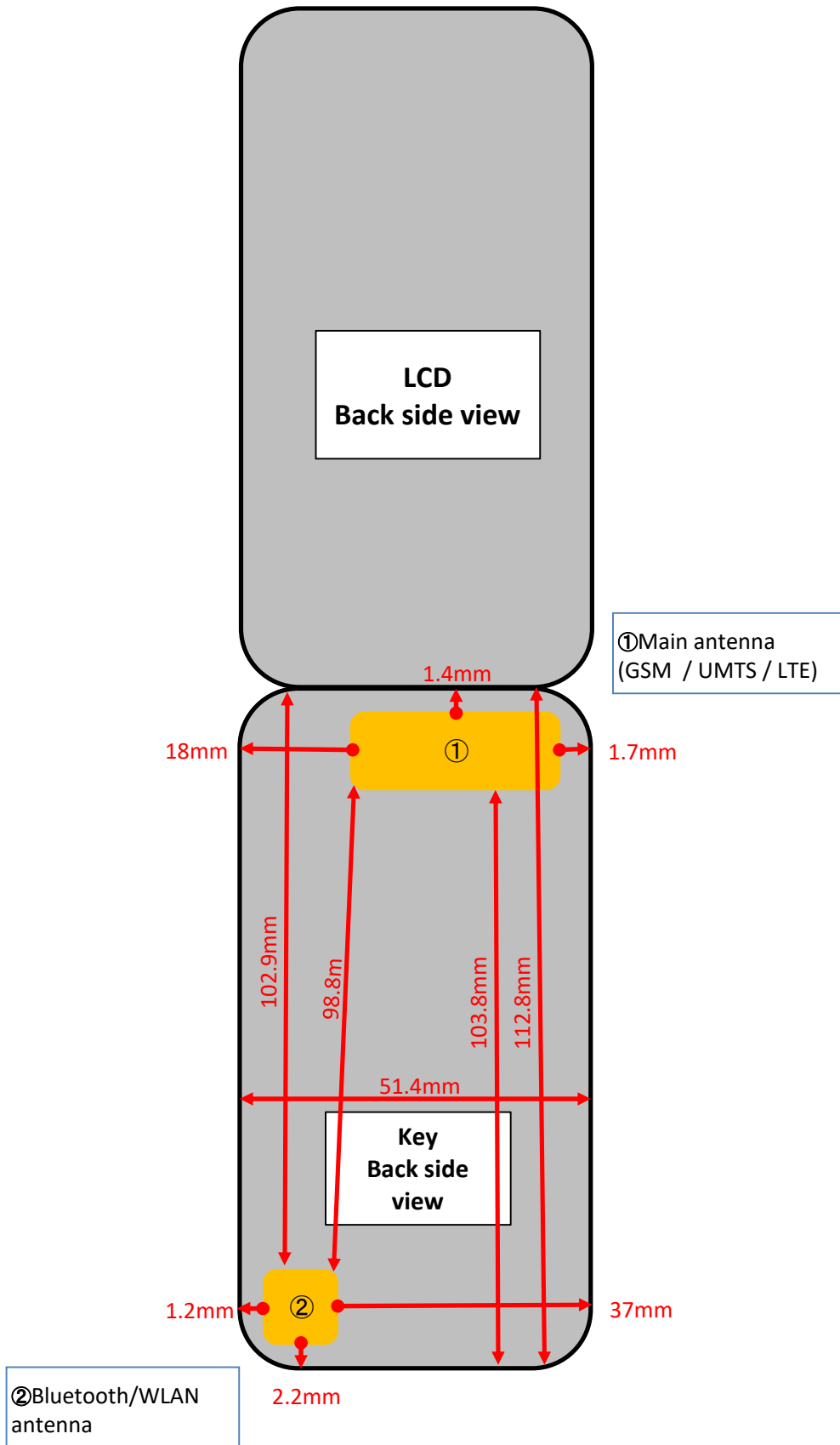

KYOCERA CONFIDENTIAL

Main antenna
(GSM / UMTS / LTE)

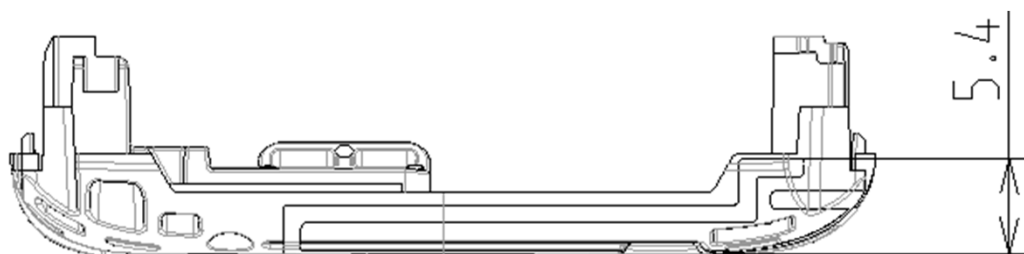
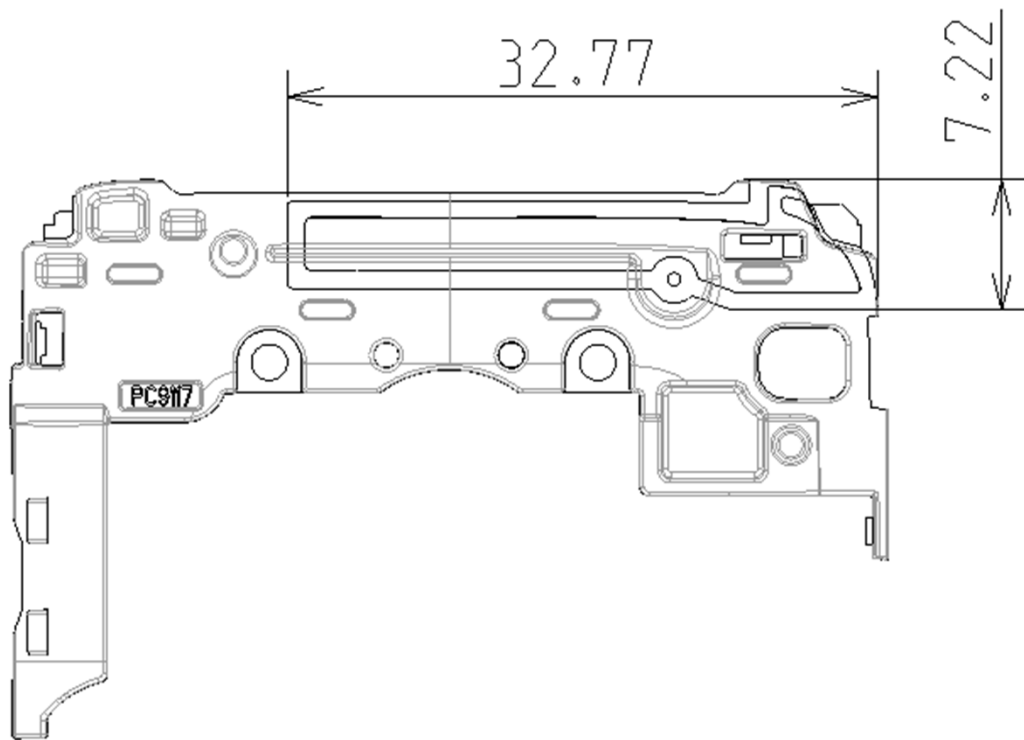
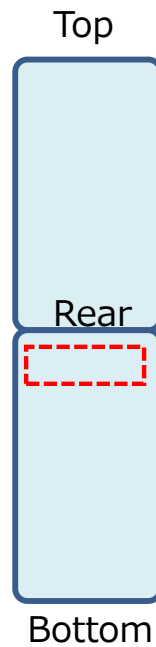

Unit: mm

KYOCERA CONFIDENTIAL

Bluetooth / WLAN antenna

Top

Rear



Bottom

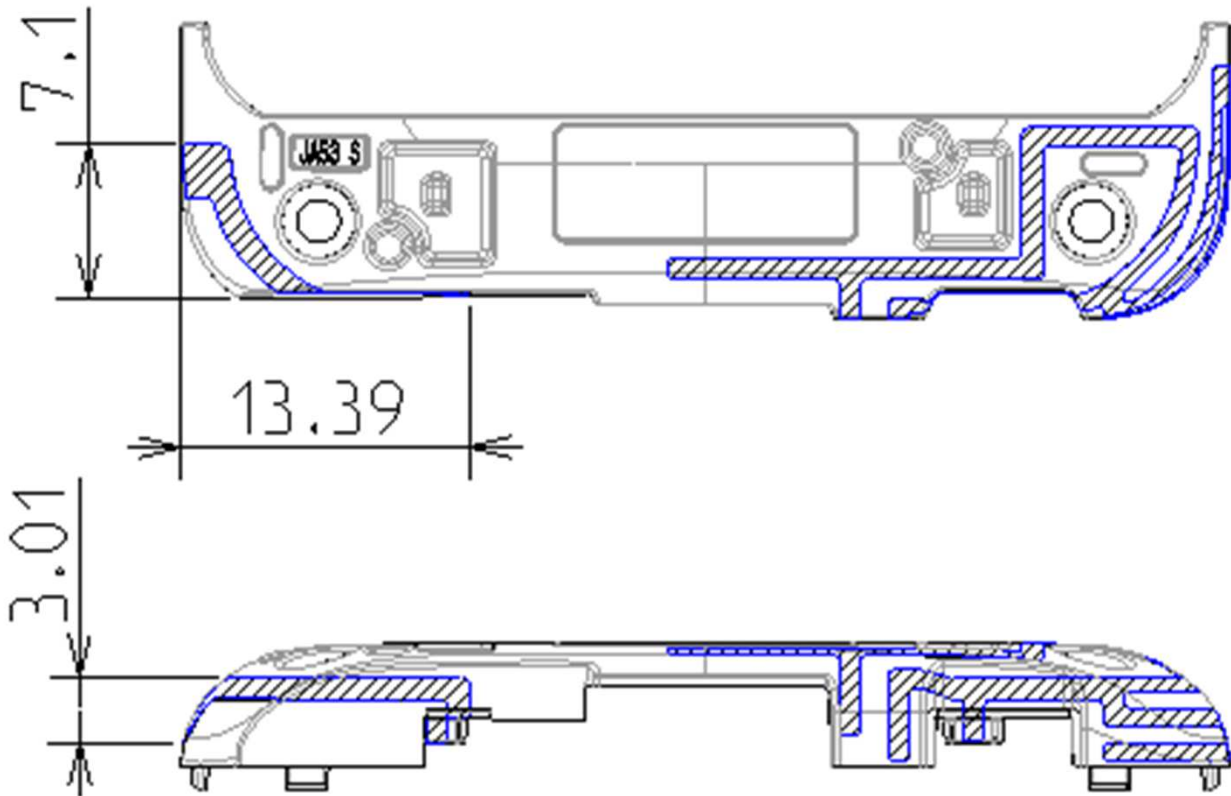

Unit : mm

KYOCERA CONFIDENTIAL