

Report on the RF Testing of:

KYOCERA Corporation
Mobile Phone, Model: EB1134
FCC ID: JOYEB1134

In accordance with FCC Part 27 Subpart C

Prepared for: KYOCERA Corporation
Yokohama Office 2-1-1 Kagahara, Tsuzuki-ku
Yokohama-shi, Kanagawa, Japan
Phone: +81-45-943-6253 Fax: +81-45-943-6314



Japan

**Add value.
Inspire trust.**

COMMERCIAL-IN-CONFIDENCE

Document Number: JPD-TR-22092-0

SIGNATURE

NAME	JOB TITLE	RESPONSIBLE FOR	ISSUE DATE
Hiroaki Suzuki	Deputy Manager of RF Group	Approved Signatory	2022.05.24

Signatures in this approval box have checked this document in line with the requirements of TÜV SÜD Japan Ltd. document control rules.

EXECUTIVE SUMMARY - Result: Complied

A sample(s) of this product was tested and the result above was confirmed in accordance with FCC Part 27 Subpart C.



DISCLAIMER AND COPYRIGHT

The results in this report are applicable only to the equipment tested.
This report shall not be re-produced except in full without the written approval of TÜV SÜD Japan Ltd.
Client provided data, for which TÜV SÜD Japan Ltd. take no responsibility, which can affect validity of results within this report is clearly identified.

ACCREDITATION

This test report must not be used by the client to claim product certification, approval, or endorsement by A2LA or any agency of the U.S. Government.

TÜV SÜD Japan Ltd.
Yonezawa Testing Center
5-4149-7 Hachimanpara,
Yonezawa-shi, Yamagata,
992-1128 Japan

Phone: +81 (0) 238 28 2881
www.tuvsud.com/ja-jp



Contents

1	Summary of Test	3
1.1	Modification history of the test report.....	3
1.2	Standards.....	3
1.3	Test methods.....	3
1.4	Deviation from standards.....	3
1.5	List of applied test(s) of the EUT.....	3
1.6	Test information.....	3
1.7	Test set up.....	3
1.8	Test period.....	3
2	Equipment Under Test	4
2.1	EUT information.....	4
2.2	Modification to the EUT.....	6
2.3	Variation of family model(s).....	6
2.4	Description of test mode.....	6
3	Configuration of Equipment	7
3.1	Equipment used.....	7
3.2	System configuration.....	7
4	Test Result	8
4.1	Equivalent Isotropic Radiated Power.....	8
4.2	Peak to Average Ratio.....	14
4.3	Occupied Bandwidth.....	23
4.4	Band Edge Spurious and Harmonic at Antenna Terminals.....	32
4.5	Radiated Emissions and Harmonic Emissions.....	77
4.6	Frequency Stability.....	86
5	Measurement Uncertainty	88
6	Laboratory Information	89
	Appendix A. Test Equipment	90

1 Summary of Test

1.1 Modification history of the test report

Document Number	Modification History	Issue Date
JPD-TR-22092-0	First Issue	Refer to the cover page

1.2 Standards

CFR47 FCC Part 27 Subpart C

1.3 Test methods

KDB 971168 D01 Power Meas License Digital Systems v03r01
ANSI/TIA/EIA 603-E-2016
ANSI C63.26-2015

1.4 Deviation from standards

None

1.5 List of applied test(s) of the EUT

Test item section	Test item	Condition	Result	Remark
2.1046	Conducted Output Power	Conducted	PASS	*1
27.50	Equivalent Isotropic Radiated Power	Radiated	PASS	-
27.50	Peak to Average Ratio	Conducted	PASS	-
2.1049	Occupied Bandwidth	Conducted	PASS	-
27.53 2.1051	Band Edge Spurious and Harmonic at Antenna Terminal	Conducted	PASS	-
27.53 2.1053	Radiated emissions and Harmonic Emissions	Radiated	PASS	-
27.54 2.1055	Frequency Stability	Conducted	PASS	-

*1: Refer to RF Exposure Report (Test Report_SAR)

1.6 Test information

None

1.7 Test set up

Table-top

1.8 Test period

13-April-2022 - 6-May-2022

2 Equipment Under Test

All information in this chapter was provided by the applicant.

2.1 EUT information

Applicant	KYOCERA Corporation Yokohama Office 2-1-1 Kagahara, Tsuzuki-ku Yokohama-shi, Kanagawa, Japan Phone: +81-45-943-6253 Fax: +81-45-943-6314
Equipment Under Test (EUT)	Mobile Phone
Model number	EB1134
Serial number	358079740016730, 355161850001265, 358079740017217
Trade name	Kyocera
Number of sample(s)	3
EUT condition	Pre-Production
Power rating	Battery: DC 3.8 V
Size	(W) 112.9 mm × (D) 51.3 mm × (H) 18.0 mm
Environment	Indoor and Outdoor use
Terminal limitation	-20°C to 60°C
Hardware version	DMT1
Software version	0.021AL.0013.a
Firmware version	Not applicable
RF Specification	
Frequency of Operation	Up Link WCDMA Band IV: 1712.4-1752.6 MHz LTE Band IV: 1710.0-1755.0 MHz Down Link WCDMA Band IV: 2112.4-2152.6 MHz LTE Band IV: 2110.0-2155.0 MHz
Modulation type	WCDMA Band IV: QPSK, 16QAM LTE Band IV: QPSK, 16QAM, 64QAM
Emission designator	WCDMA Band IV: 4M17F9W LTE Band IV: BW 1.4M QPSK: 1M10G7D, 16QAM: 1M10W7D, 64QAM: 1M09W7D BW 3M QPSK: 2M69G7D, 16QAM: 2M69W7D, 64QAM: 2M71W7D BW 5M QPSK: 4M52G7D, 16QAM: 4M50W7D, 64QAM: 4M50W7D BW 10M QPSK: 8M99G7D, 16QAM: 8M98W7D, 64QAM: 8M97W7D BW 15M QPSK: 13M5G7D, 16QAM: 13M5W7D, 64QAM: 13M5W7D BW 20M QPSK: 18M0G7D, 16QAM: 18M0W7D, 64QAM: 17M9W7D



Japan

Effective Radiated Power (E.I.R.P.)	WCDMA Band IV: 0.4467 W (26.5 dBm) LTE Band IV: 0.3981 W (26.0 dBm)
Antenna type	Internal antenna
Antenna gain	WCDMA Band IV: 1.54 dBi LTE Band IV: 1.54 dBi

2.2 Modification to the EUT

The table below details modifications made to the EUT during the test project.

Modification State	Description of Modification	Modification fitted by	Date of Modification
Model: EB1134, Serial Number: 358079740016730, 355161850001265, 358079740017217			
0	As supplied by the applicant	Not Applicable	Not Applicable

2.3 Variation of family model(s)

2.3.1 List of family model(s)

EB1134 has model with camera and without camera.

2.3.2 Reason for selection of EUT

Not applicable

2.4 Description of test mode

The EUT had been tested under operating condition.
There are three channels have been tested as following:

Band	Modulation	Bandwidth [MHz]	Channel	Frequency [MHz]
WCDMA Band IV	QPSK	-	1312, 1413, 1513	1712.4, 1732.6, 1752.6
	16QAM	-	1312, 1413, 1513	1712.4, 1732.6, 1752.6
LTE Band IV	QPSK, 16QAM, 64QAM	1.4	19957, 20175, 20393	1710.7, 1732.5, 1754.3
		3	19965, 20175, 20385	1711.5, 1732.5, 1753.5
		5	19975, 20175, 20375	1712.5, 1732.5, 1752.5
		10	20000, 20175, 20350	1715.0, 1732.5, 1750.0
		15	20025, 20175, 20325	1717.5, 1732.5, 1747.5
		20	20050, 20175, 20300	1720.0, 1732.5, 1745.0

The field strength of spurious emissions was measured at each position of all three axis X, Y and Z to compare the level, and the maximum noise.

The worst emission was found in X-axis (WCDMA Band IV), Open, Without camera, Z-axis (LTE Band IV), Open, Without camera and the worst case recorded.

Pre-scan has been conducted to determine the worst-case mode from all possible combinations between available modulations, data rates and antenna ports.

3 Configuration of Equipment

Numbers assigned to equipment on the diagram in “3.2 System configuration” correspond to the list in “3.1 Equipment used”.

This test configuration is based on the manufacture’s instruction.

Cabling and setup(s) were taken into consideration and test data was taken under worse case condition.

3.1 Equipment used

No.	Equipment	Company	Model No.	Serial No.	FCC ID/DoC	Comment
1	Mobile Phone	KYOCERA	EB1134	358079740016730, 355161850001265, 358079740017217	JOYEB1134	EUT

3.2 System configuration

1. Mobile Phone
(EUT)

4 Test Result

4.1 Equivalent Isotropic Radiated Power

4.1.1 Measurement procedure

[FCC 27.50]

<Step 1>

The EUT and support equipment are placed on 0.6 meter x 0.6 meter surface, 1.5 meter height (Above 1GHz) styrene foam table. Radiated emission measurements are performed at 3 meter distance with the broadband antenna (Log periodic antenna). The antenna is positioned both the horizontal and vertical planes of polarization and height is varied 1 to 4 meters and stopped at height producing the maximum emission.

The bandwidth of the spectrum analyzer is set to 1 MHz. The turntable is rotated by 360 degrees and stopped at azimuth of producing the maximum emission.

<Step 2>

The substitution antenna is replaced by the transmitter antenna (EUT).

The frequency of the signal generator is adjusted to the measurement frequency.

Level of the signal generator is adjusted to the level that is obtained from step 1, and record the emission level of signal generator.

The spectrum analyzer is set to;

- a) Span = 1.5 times the OBW
- b) RBW = 1-5% of the expected OBW, not to exceed 1 MHz
- c) VBW $\geq 3 \times$ RBW
- d) Number of sweep points $\geq 2 \times$ span / RBW
- e) Sweep time = auto-couple
- f) Detector = RMS (power averaging)
- g) If the EUT can be configured to transmit continuously (i.e., burst duty cycle $\geq 98\%$), then set the trigger to free run.
- h) If the EUT cannot be configured to transmit continuously (i.e., burst duty cycle $< 98\%$), then use a sweep trigger with the level set to enable triggering only on full power bursts and configure the EUT to transmit at full power for the entire duration of each sweep. Ensure that the sweep time is less than or equal to the transmission burst duration.
- i) Trace average at least 100 traces in power averaging (i.e., RMS) mode.
- j) Compute the power by integrating the spectrum across the OBW of the signal using the instrument's band power measurement function, with the band limits set equal to the OBW band edges.

If the instrument does not have a band power function, then sum the spectrum levels (in linear power units) at intervals equal to the RBW extending across the entire OBW of the spectrum.

- Test configuration

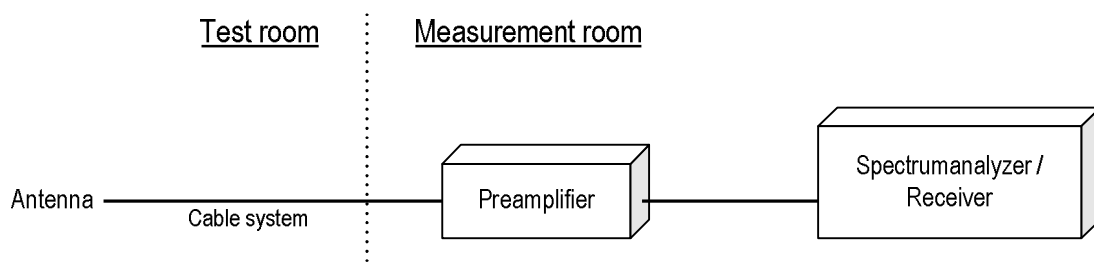



Japan

4.1.2 Calculation method

Result (EIRP) = Ant. Input - Cable loss + Antenna Gain
Margin = Limit – Result (EIRP)

Example:

Limit @ 1732.6MHz : 30.0 dBm

Ant. Input = 25.5 dBm Cable loss = 0.7 dB Ant. Gain = -10.1 dBi

Result = 25.5 - 0.7 + (-10.1) = 14.7 dBm

Margin = 30.0 – 14.7 = 15.3 dB

4.1.3 Limit

1W (30 dBm)

4.1.4 Test data

Date	: 13~14-April-2022	Test engineer	:	<u>Tadahiro Seino</u>
Temperature	: 22.2 [°C]			
Humidity	: 41.4 [%]			
Test place	: 3m Semi-anechoic chamber			
Date	: 14~15-April-2022	Test engineer	:	<u>Tadahiro Seino</u>
Temperature	: 22.2 [°C]			
Humidity	: 31.3 [%]			
Test place	: 3m Semi-anechoic chamber			
Date	: 15~16-April-2022	Test engineer	:	<u>Tadahiro Seino</u>
Temperature	: 22.8 [°C]			
Humidity	: 31.9 [%]			
Test place	: 3m Semi-anechoic chamber			
Date	: 18~19-April-2022	Test engineer	:	<u>Chiaki Kanno</u>
Temperature	: 21.9 [°C]			
Humidity	: 30.3 [%]			
Test place	: 3m Semi-anechoic chamber			
Date	: 26~27-April-2022	Test engineer	:	<u>Chiaki Kanno</u>
Temperature	: 22.3 [°C]			
Humidity	: 56.2 [%]			
Test place	: 3m Semi-anechoic chamber			
Date	: 27~28-April-2022	Test engineer	:	<u>Chiaki Kanno</u>
Temperature	: 22.9 [°C]			
Humidity	: 37.5 [%]			
Test place	: 3m Semi-anechoic chamber			

[WCDMA Band IV - X-axis, Open, Without camera]

H/V	Frequency [MHz]	S.A Reading [dBm]	Ant. Input [dBm]	Cable loss [dB]	Ant.Gain [dBi]	Result [dBm]	Limit [dBm]	Margin [dB]
H	1712.4	-25.8	20.1	1.1	5.3	24.3	30.0	5.7
H	1732.6	-25.4	21.0	1.1	5.2	25.0	30.0	5.0
H	1752.6	-24.9	22.6	1.1	5.0	26.5	30.0	3.5

[LTE Band IV - Z-axis, Open, Without camera]**QPSK, BW 1.4MHz**

H/V	Frequency [MHz]	S.A Reading [dBm]	Ant. Input [dBm]	Cable loss [dB]	Ant.Gain [dBi]	Result [dBm]	Limit [dBm]	Margin [dB]
H	1710.7	-25.5	20.3	1.1	5.3	24.5	30.0	5.5
H	1732.5	-25.3	21.1	1.1	5.2	25.1	30.0	4.9
H	1754.3	-25.4	22.1	1.1	5.0	26.0	30.0	4.0

16QAM, BW 1.4MHz

H/V	Frequency [MHz]	S.A Reading [dBm]	Ant. Input [dBm]	Cable loss [dB]	Ant.Gain [dBi]	Result [dBm]	Limit [dBm]	Margin [dB]
H	1710.7	-26.6	19.2	1.1	5.3	23.4	30.0	6.6
H	1732.5	-25.9	20.5	1.1	5.2	24.5	30.0	5.5
H	1754.3	-26.4	21.1	1.1	5.0	25.0	30.0	5.0

64QAM, BW 1.4MHz

H/V	Frequency [MHz]	S.A Reading [dBm]	Ant. Input [dBm]	Cable loss [dB]	Ant.Gain [dBi]	Result [dBm]	Limit [dBm]	Margin [dB]
H	1710.7	-27.3	18.5	1.1	5.3	22.7	30.0	7.3
H	1732.5	-27.1	19.3	1.1	5.2	23.3	30.0	6.7
H	1754.3	-27.2	20.3	1.1	5.0	24.2	30.0	5.8

QPSK, BW 3MHz

H/V	Frequency [MHz]	S.A Reading [dBm]	Ant. Input [dBm]	Cable loss [dB]	Ant.Gain [dBi]	Result [dBm]	Limit [dBm]	Margin [dB]
H	1711.5	-25.4	20.5	1.1	5.3	24.7	30.0	5.3
H	1732.5	-25.1	21.3	1.1	5.2	25.3	30.0	4.7
H	1753.5	-25.6	21.9	1.1	5.0	25.8	30.0	4.2

16QAM, BW 3MHz

H/V	Frequency [MHz]	S.A Reading [dBm]	Ant. Input [dBm]	Cable loss [dB]	Ant.Gain [dBi]	Result [dBm]	Limit [dBm]	Margin [dB]
H	1711.5	-26.1	19.8	1.1	5.3	24.0	30.0	6.0
H	1732.5	-26.1	20.3	1.1	5.2	24.3	30.0	5.7
H	1753.5	-26.6	20.9	1.1	5.0	24.8	30.0	5.2

64QAM, BW 3MHz

H/V	Frequency [MHz]	S.A Reading [dBm]	Ant. Input [dBm]	Cable loss [dB]	Ant.Gain [dBi]	Result [dBm]	Limit [dBm]	Margin [dB]
H	1711.5	-27.2	18.7	1.1	5.3	22.9	30.0	7.1
H	1732.5	-27.2	19.2	1.1	5.2	23.2	30.0	6.8
H	1753.5	-27.3	20.2	1.1	5.0	24.1	30.0	5.9

[LTE Band IV - Z-axis, Open, Without camera]**QPSK, BW 5MHz**

H/V	Frequency [MHz]	S.A Reading [dBm]	Ant. Input [dBm]	Cable loss [dB]	Ant.Gain [dBi]	Result [dBm]	Limit [dBm]	Margin [dB]
H	1712.5	-25.5	20.4	1.1	5.3	24.6	30.0	5.4
H	1732.5	-25.3	21.1	1.1	5.2	25.1	30.0	4.9
H	1752.5	-26.3	21.2	1.1	5.0	25.1	30.0	4.9

16QAM, BW 5MHz

H/V	Frequency [MHz]	S.A Reading [dBm]	Ant. Input [dBm]	Cable loss [dB]	Ant.Gain [dBi]	Result [dBm]	Limit [dBm]	Margin [dB]
H	1712.5	-26.5	19.4	1.1	5.3	23.6	30.0	6.4
H	1732.5	-26.1	20.3	1.1	5.2	24.3	30.0	5.7
H	1752.5	-27.1	20.4	1.1	5.0	24.3	30.0	5.7

64QAM, BW 5MHz

H/V	Frequency [MHz]	S.A Reading [dBm]	Ant. Input [dBm]	Cable loss [dB]	Ant.Gain [dBi]	Result [dBm]	Limit [dBm]	Margin [dB]
H	1712.5	-27.6	18.3	1.1	5.3	22.5	30.0	7.5
H	1732.5	-27.0	19.4	1.1	5.2	23.4	30.0	6.6
H	1752.5	-28.1	19.4	1.1	5.0	23.3	30.0	6.7

QPSK, BW 10MHz

H/V	Frequency [MHz]	S.A Reading [dBm]	Ant. Input [dBm]	Cable loss [dB]	Ant.Gain [dBi]	Result [dBm]	Limit [dBm]	Margin [dB]
H	1715.0	-24.8	21.2	1.1	5.3	25.4	30.0	4.6
H	1732.5	-24.9	21.5	1.1	5.2	25.5	30.0	4.5
H	1750.0	-26.7	20.8	1.1	5.0	24.7	30.0	5.3

16QAM, BW 10MHz

H/V	Frequency [MHz]	S.A Reading [dBm]	Ant. Input [dBm]	Cable loss [dB]	Ant.Gain [dBi]	Result [dBm]	Limit [dBm]	Margin [dB]
H	1715.0	-26.0	20.0	1.1	5.3	24.2	30.0	5.8
H	1732.5	-25.6	20.8	1.1	5.2	24.8	30.0	5.2
H	1750.0	-27.7	19.8	1.1	5.0	23.7	30.0	6.3

64QAM, BW 10MHz

H/V	Frequency [MHz]	S.A Reading [dBm]	Ant. Input [dBm]	Cable loss [dB]	Ant.Gain [dBi]	Result [dBm]	Limit [dBm]	Margin [dB]
H	1715.0	-27.1	18.9	1.1	5.3	23.1	30.0	6.9
H	1732.5	-26.8	19.6	1.1	5.2	23.6	30.0	6.4
H	1750.0	-28.6	18.9	1.1	5.0	22.8	30.0	7.2

[LTE Band IV - Z-axis, Open, Without camera]**QPSK, BW 15MHz**

H/V	Frequency [MHz]	S.A Reading [dBm]	Ant. Input [dBm]	Cable loss [dB]	Ant.Gain [dBi]	Result [dBm]	Limit [dBm]	Margin [dB]
H	1717.5	-25.6	20.2	1.1	5.3	24.3	30.0	5.7
H	1732.5	-24.7	21.7	1.1	5.2	25.7	30.0	4.3
H	1747.5	-26.7	20.7	1.1	5.0	24.7	30.0	5.3

16QAM, BW 15MHz

H/V	Frequency [MHz]	S.A Reading [dBm]	Ant. Input [dBm]	Cable loss [dB]	Ant.Gain [dBi]	Result [dBm]	Limit [dBm]	Margin [dB]
H	1717.5	-26.3	19.5	1.1	5.3	23.6	30.0	6.4
H	1732.5	-25.9	20.5	1.1	5.2	24.5	30.0	5.5
H	1747.5	-27.5	19.9	1.1	5.0	23.9	30.0	6.1

64QAM, BW 15MHz

H/V	Frequency [MHz]	S.A Reading [dBm]	Ant. Input [dBm]	Cable loss [dB]	Ant.Gain [dBi]	Result [dBm]	Limit [dBm]	Margin [dB]
H	1717.5	-27.3	18.5	1.1	5.3	22.6	30.0	7.4
H	1732.5	-26.6	19.8	1.1	5.2	23.8	30.0	6.2
H	1747.5	-28.6	18.8	1.1	5.0	22.8	30.0	7.2

QPSK, BW 20MHz

H/V	Frequency [MHz]	S.A Reading [dBm]	Ant. Input [dBm]	Cable loss [dB]	Ant.Gain [dBi]	Result [dBm]	Limit [dBm]	Margin [dB]
H	1720.0	-24.5	21.1	1.1	5.3	25.2	30.0	4.8
H	1732.5	-24.7	21.7	1.1	5.2	25.7	30.0	4.3
H	1745.0	-25.5	21.9	1.1	5.1	25.9	30.0	4.1

16QAM, BW 20MHz

H/V	Frequency [MHz]	S.A Reading [dBm]	Ant. Input [dBm]	Cable loss [dB]	Ant.Gain [dBi]	Result [dBm]	Limit [dBm]	Margin [dB]
H	1720.0	-25.4	20.2	1.1	5.3	24.3	30.0	5.7
H	1732.5	-25.8	20.6	1.1	5.2	24.6	30.0	5.4
H	1745.0	-26.3	21.1	1.1	5.1	25.1	30.0	4.9

64QAM, BW 20MHz

H/V	Frequency [MHz]	S.A Reading [dBm]	Ant. Input [dBm]	Cable loss [dB]	Ant.Gain [dBi]	Result [dBm]	Limit [dBm]	Margin [dB]
H	1720.0	-26.3	19.3	1.1	5.3	23.4	30.0	6.6
H	1732.5	-26.9	19.5	1.1	5.2	23.5	30.0	6.5
H	1745.0	-27.8	19.6	1.1	5.1	23.6	30.0	6.4

4.2 Peak to Average Ratio

4.2.1 Measurement procedure

[FCC 27.50]

The peak to average ratio was measured with a spectrum analyzer connected to the antenna terminal.

The spectrum analyzer is set to;

- a) Power Stat CCDF mode
- b) Set resolution / measurement bandwidth \geq signal's occupied bandwidth.
- c) Set the number of counts to a value that stabilizes the measured CCDF curve.
- d) Set the measurement interval as follows:
 - 1) For continuous transmissions, set to 1ms.
 - 2) For burst transmissions, employ an external trigger that is synchronized with the EUT burst timing sequence, or use the internal burst trigger with a trigger level that allows the burst duration.
- e) Record the maximum PAPR level associated with a probability of 0.1%.

- Test configuration

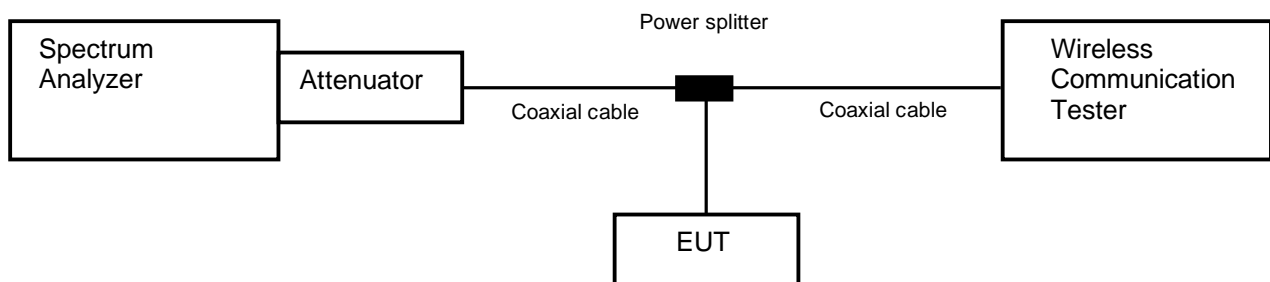

4.2.2 Limit

13 dB or less



4.2.3 Measurement result

Date : 28-April-2022
 Temperature : 22.9 [°C]
 Humidity : 36.1 [%]
 Test place : Shielded room No.4
 Test engineer : Tadahiro Seino

Band	Channel	Frequency [MHz]	Peak to Average Power Ratio [dB]	Limit [dB]
WCDMA Band IV	1312	1712.4	2.98	13.0
	1413	1732.6	3.23	
	1513	1752.6	2.92	

Band	Channel	Frequency [MHz]	Modulation	Bandwidth [MHz]	RB	Peak to Average Power Ratio [dB]	Limit [dB]
LTE Band IV	20175	1732.5	QPSK	1.4	6-0	5.80	13.0
				3	15-0	5.86	
				5	25-0	5.83	
				10	50-0	5.44	
				15	75-0	5.82	
				20	100-0	6.56	
			16QAM	1.4	6-0	6.50	
				3	15-0	6.73	
				5	25-0	6.50	
				10	50-0	6.34	
				15	75-0	6.80	
				20	100-0	7.19	
			64QAM	1.4	6-0	6.58	
				3	15-0	6.77	
				5	25-0	6.78	
				10	50-0	6.58	
				15	75-0	7.11	
				20	100-0	7.33	

4.2.4 Trace data

[WCDMA Band IV]
Channel: 1312

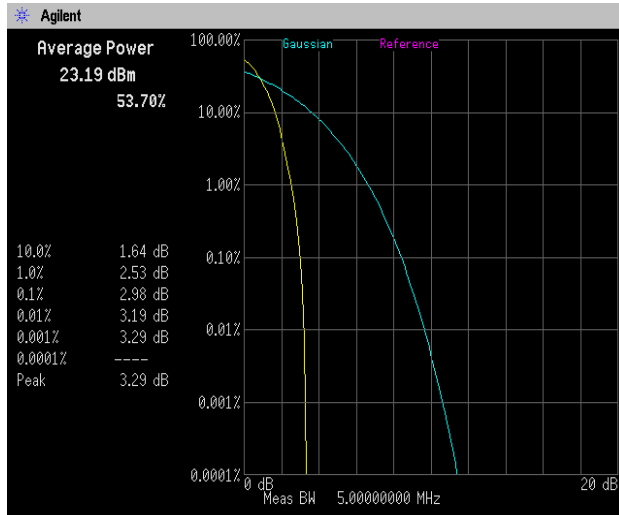

Channel: 1413

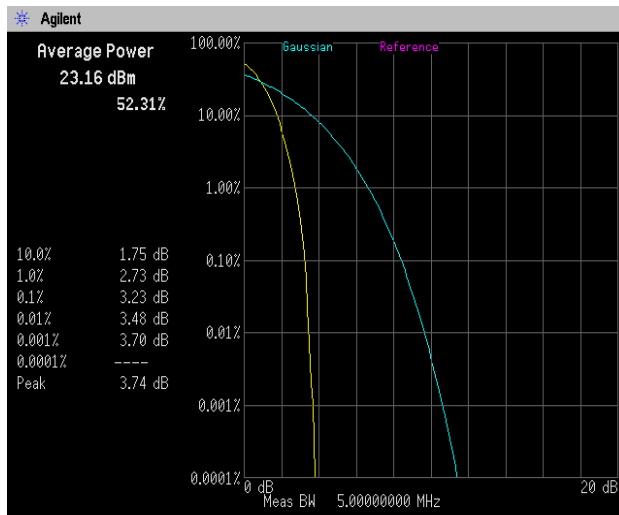

Channel: 1513

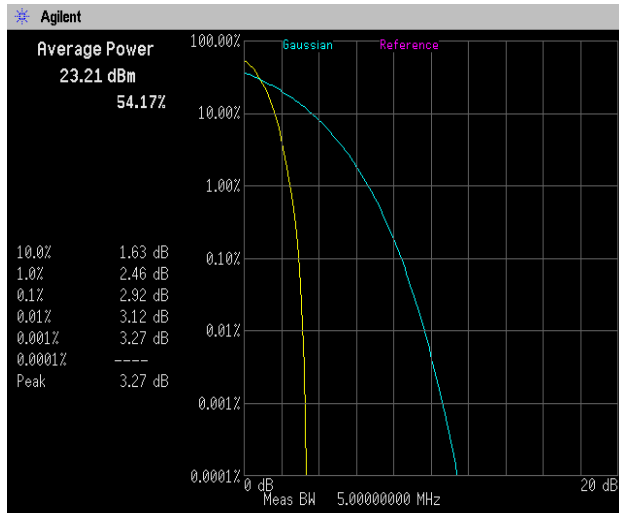

[LTE Band IV]

Channel: 20175

QPSK, BW 1.4MHz, RB6-0

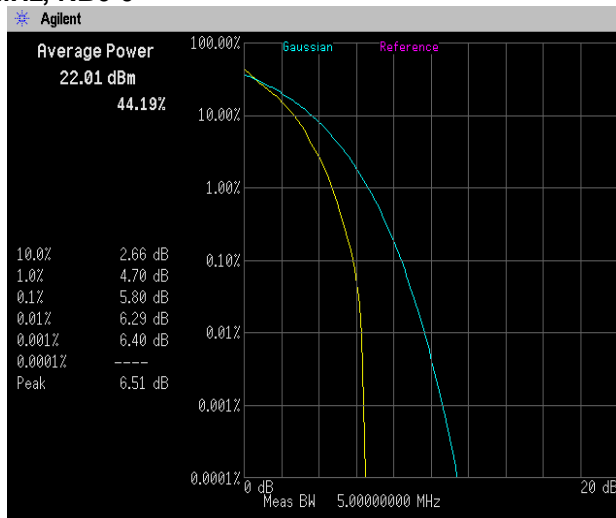

QPSK, BW 3MHz, RB15-0

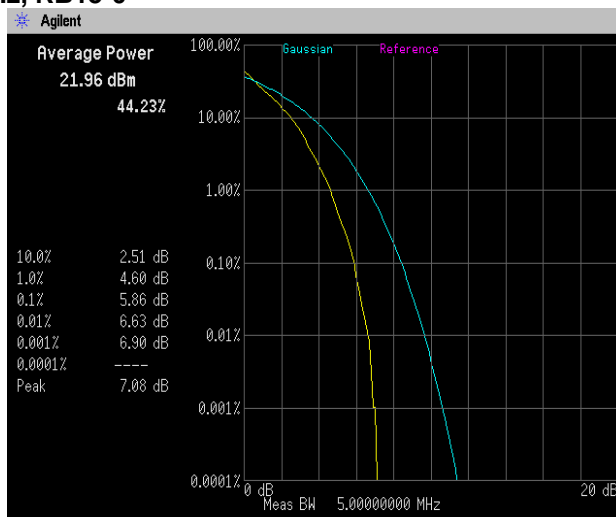

QPSK, BW 5MHz, RB25-0



Channel: 20175
QPSK, BW 10MHz, RB50-0

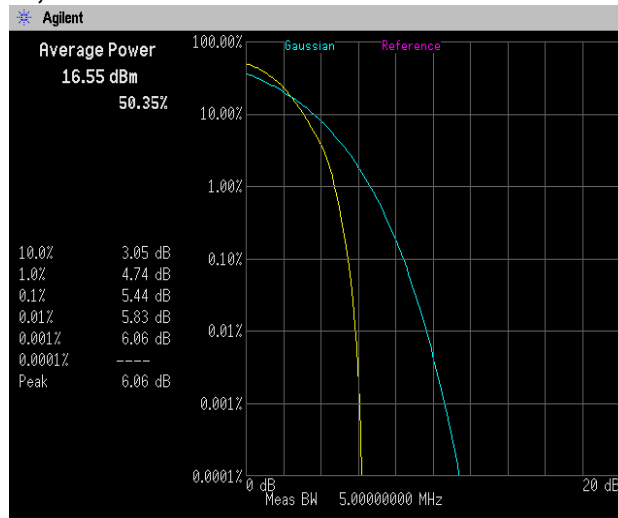

QPSK, BW 15MHz, RB75-0

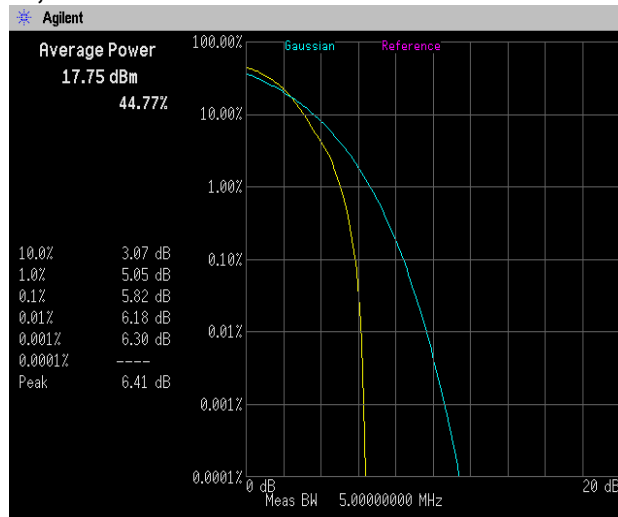

QPSK, BW 20MHz, RB100-0

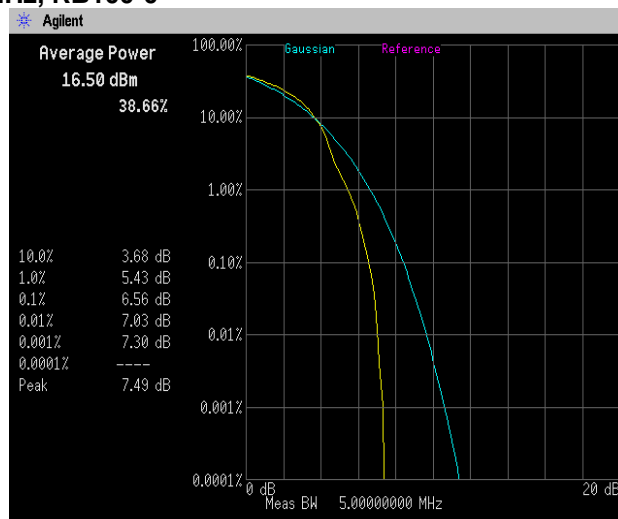

Channel: 20175
16QAM, BW 1.4MHz, RB6-0

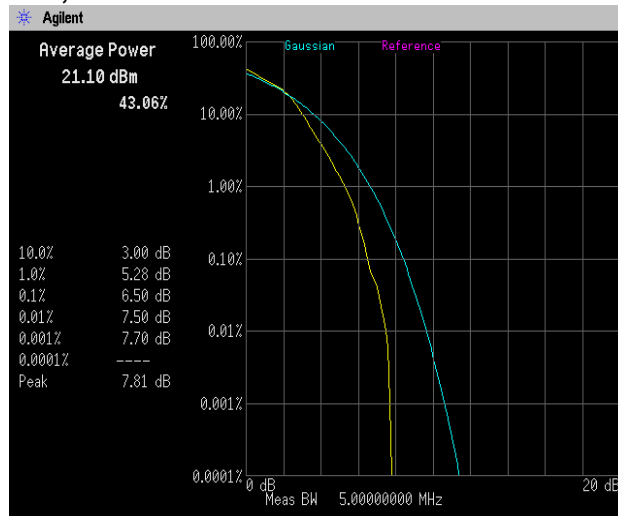

16QAM, BW 3MHz, RB15-0

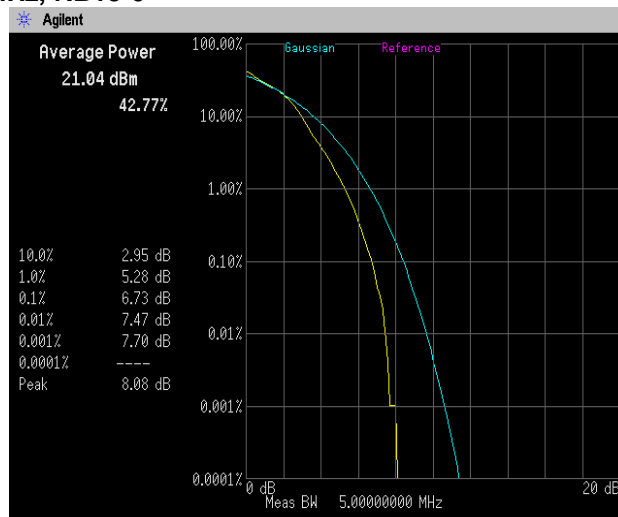

16QAM, BW 5MHz, RB25-0

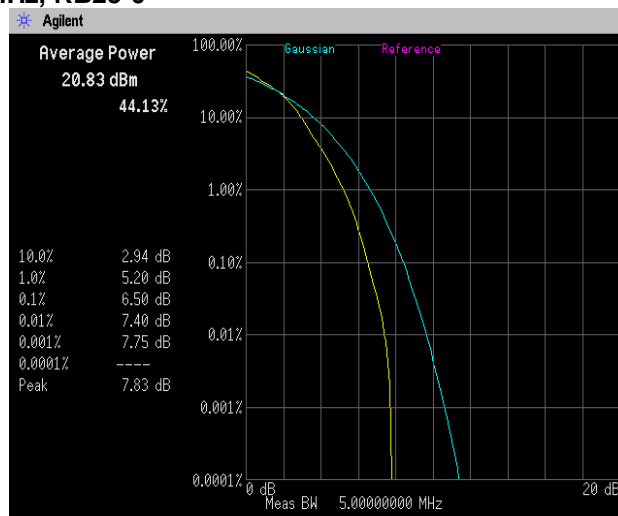

Channel: 20175
16QAM, BW 10MHz, RB50-0

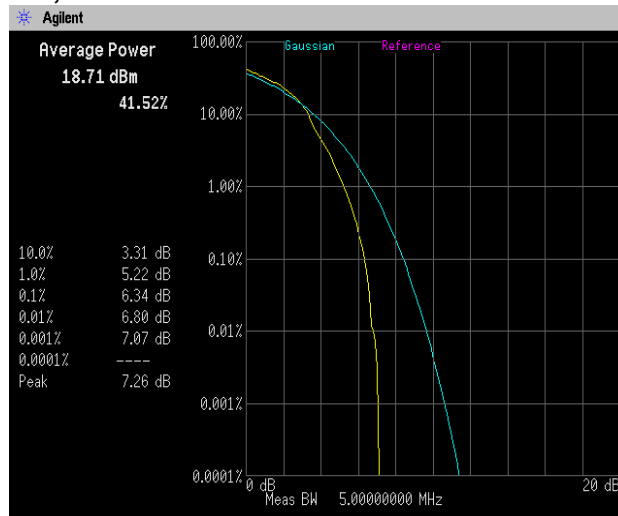

16QAM, BW 15MHz, RB75-0

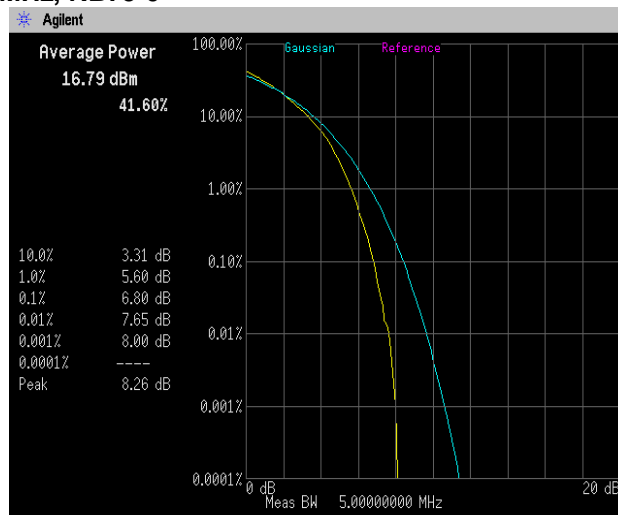

16QAM, BW 20MHz, RB100-0

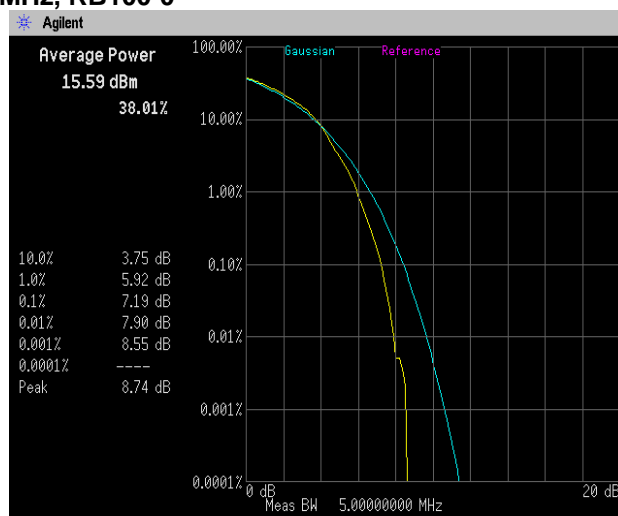

Channel: 20175
64QAM, BW 1.4MHz, RB6-0

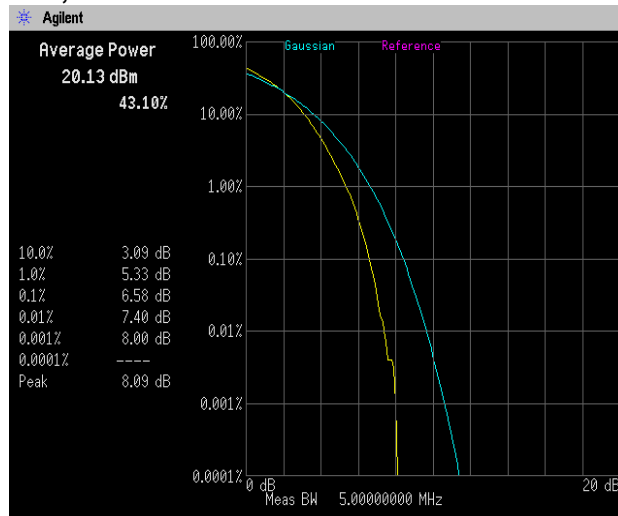

64QAM, BW 3MHz, RB15-0

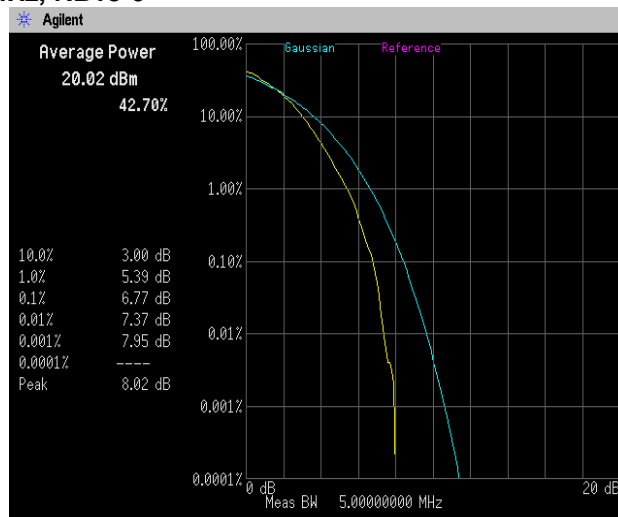

64QAM, BW 5MHz, RB25-0

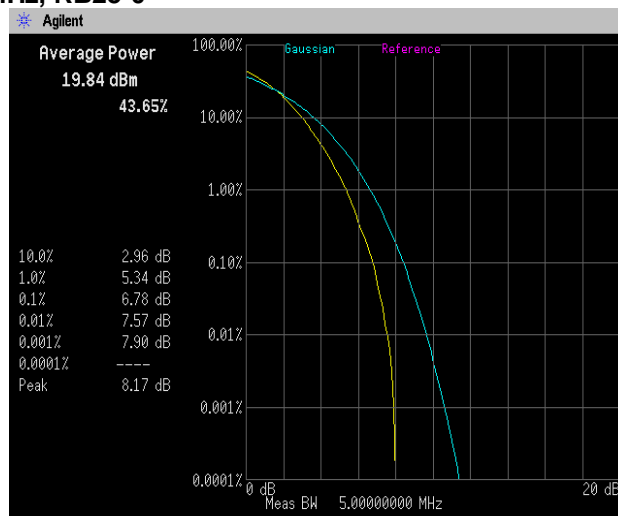

Channel: 20175
64QAM, BW 10MHz, RB50-0

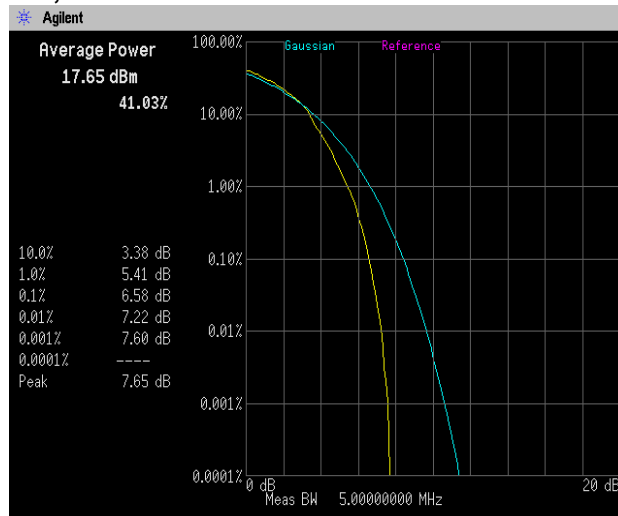

64QAM, BW 15MHz, RB75-0

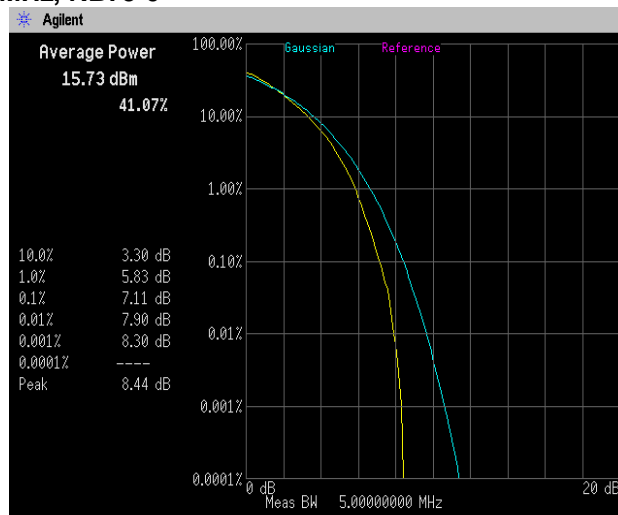

64QAM, BW 20MHz, RB100-0

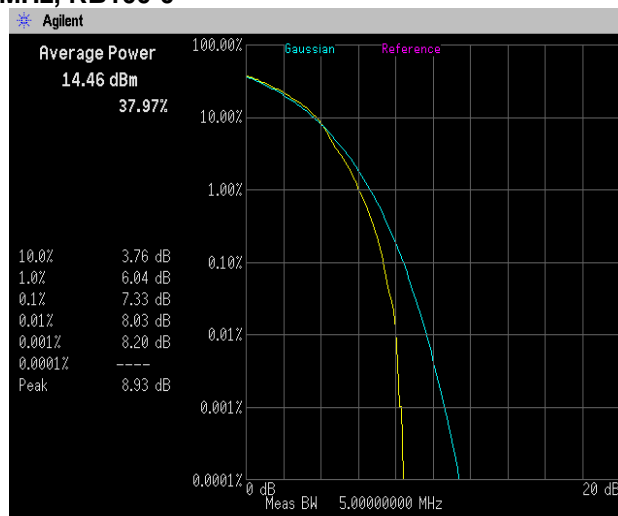

4.3 Occupied Bandwidth

4.3.1 Measurement procedure

[FCC 2.1049]

The Occupied bandwidth was measured with a spectrum analyzer connected to the antenna terminal.

The spectrum analyzer is set to;

- a) RBW = 1-5% of the expected OBW & VBW $\geq 3 \times$ RBW
- b) Detector = Peak
- c) Trace mode = Max hold
- d) Sweep time = auto-couple

- Test configuration

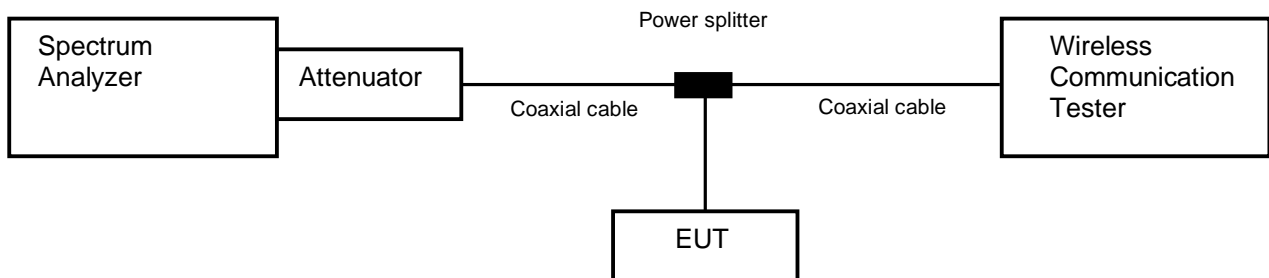

4.3.2 Limit

None

4.3.3 Measurement result

Date : 2-May-2022
 Temperature : 20.8 [°C]
 Humidity : 47.9 [%]
 Test place : Shielded room No.4

Test engineer : Tadahiro Seino



Band	Channel	Frequency [MHz]	Test Result [MHz]
WCDMA Band IV	1312	1712.4	4.1683
	1413	1732.6	4.1625
	1513	1752.6	4.1737

Band	Channel	Frequency [MHz]	Bandwidth [MHz]	Modulation	RB	Test Result [MHz]
LTE Band IV	20175	1732.5	1.4	QPSK	3-1	0.6051
					6-0	1.0951
				16QAM	3-1	0.6078
					6-0	1.0991
				64QAM	3-1	0.5954
					6-0	1.0931
			3	QPSK	8-4	1.5106
					15-0	2.6921
				16QAM	8-4	1.5171
					15-0	2.6921
				64QAM	8-4	1.4965
					15-0	2.7101
			5	QPSK	12-7	2.3092
					25-0	4.5153
				16QAM	12-7	2.2946
					25-0	4.4983
				64QAM	12-7	2.2684
					25-0	4.5043
			10	QPSK	25-12	4.6540
					50-0	8.9871
				16QAM	25-12	4.6609
					50-0	8.9774
				64QAM	25-12	4.6577
					50-0	8.9733
			15	QPSK	36-20	6.6932
					75-0	13.4760
				16QAM	36-20	6.6921
					75-0	13.4791
				64QAM	36-20	6.7295
					75-0	13.4564
			20	QPSK	50-24	9.2205
					100-0	17.9675
				16QAM	50-24	9.1948
					100-0	18.0237
				64QAM	50-24	9.2082
					100-0	17.9494

4.3.4 Trace data

[WCDMA Band IV]
Channel: 1312

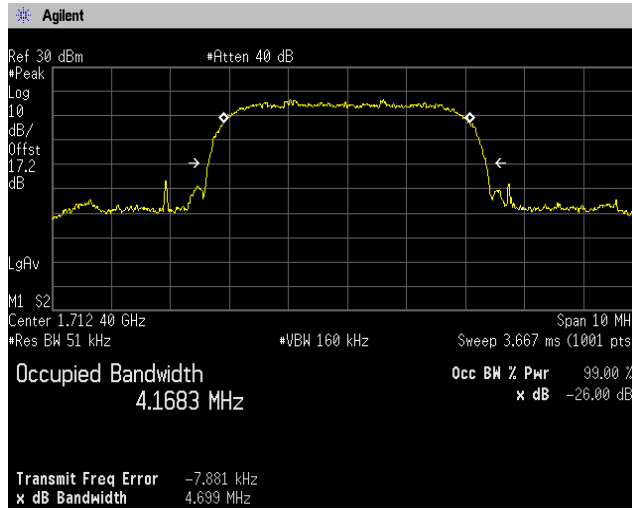

Channel: 1413

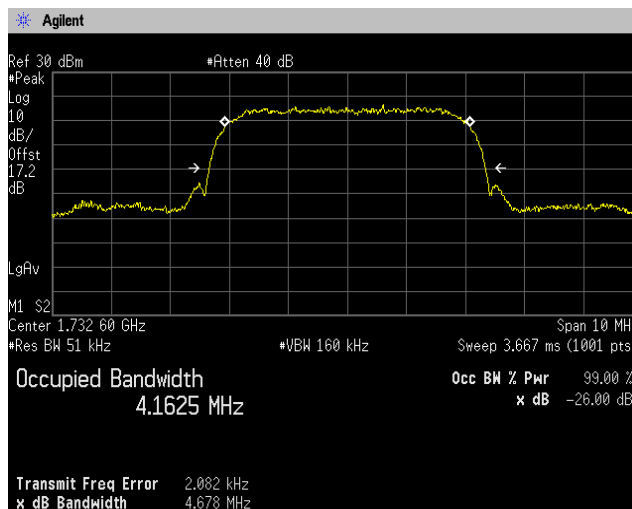

Channel: 1513

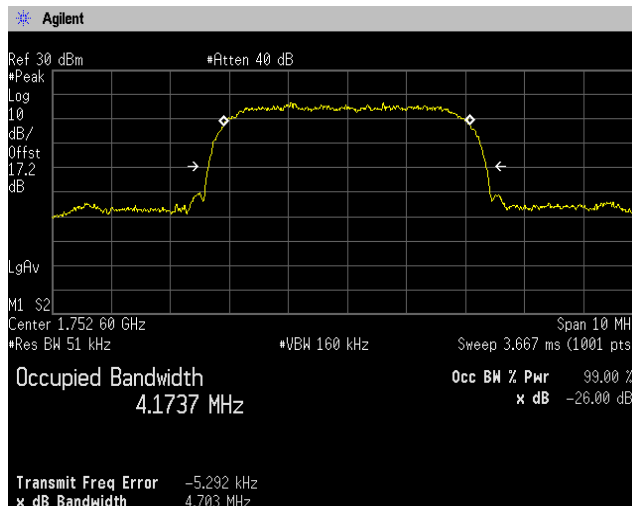



[LTE Band IV]
Channel: 20175

QPSK, BW 1.4MHz

RB3-1

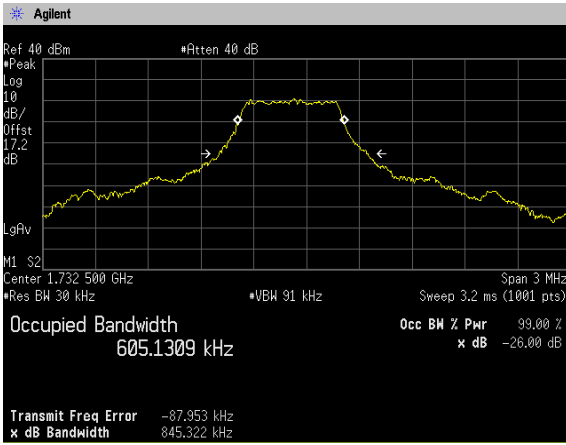

RB6-0

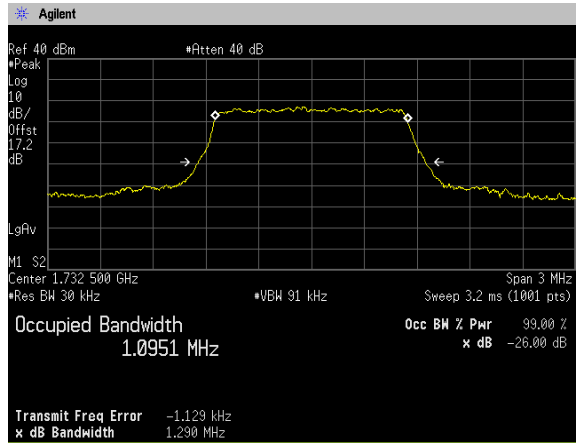

16QAM, BW 1.4MHz

RB3-1

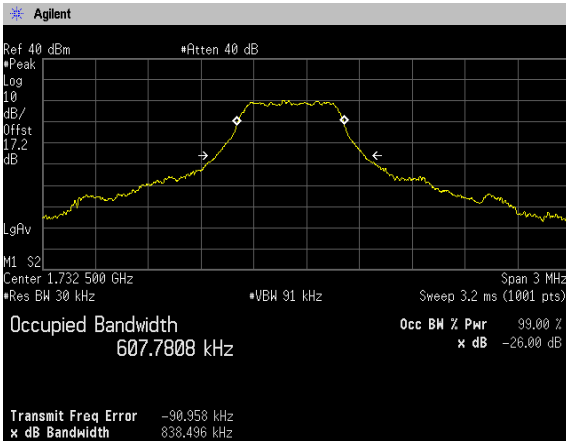

RB6-0

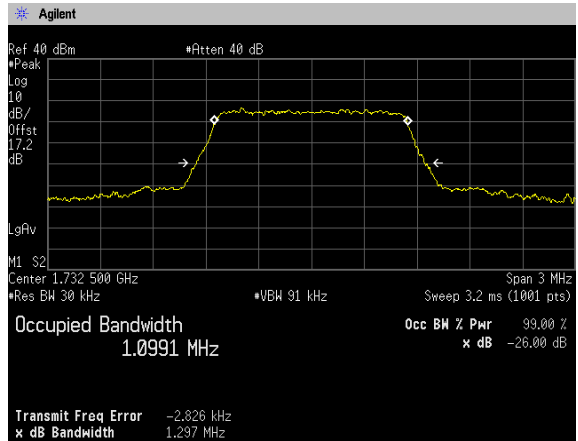

64QAM, BW 1.4MHz

RB3-1

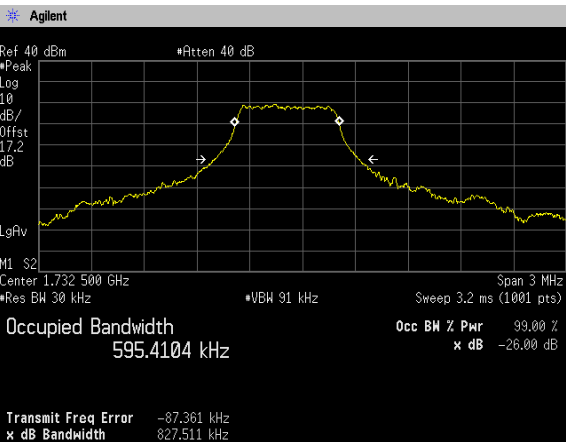

RB6-0

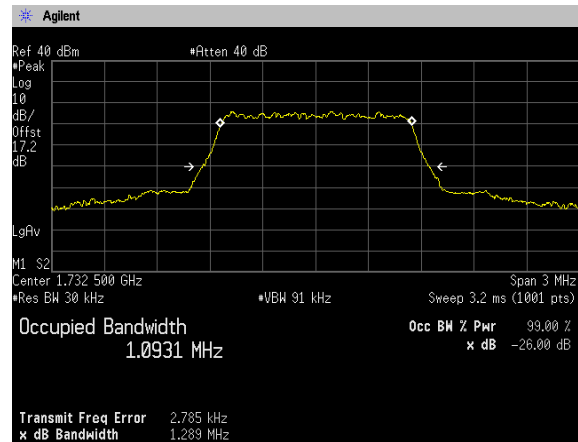

QPSK, BW 3MHz

RB8-4

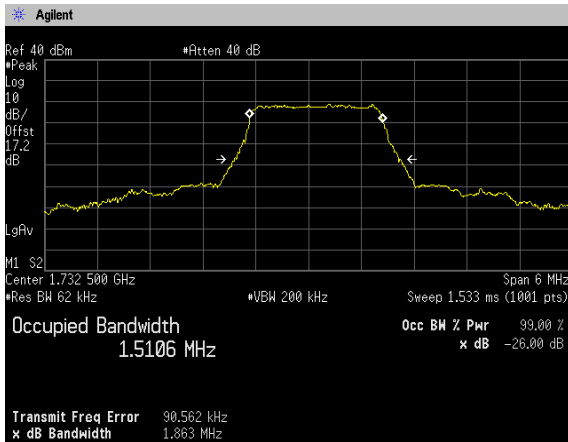

RB15-0

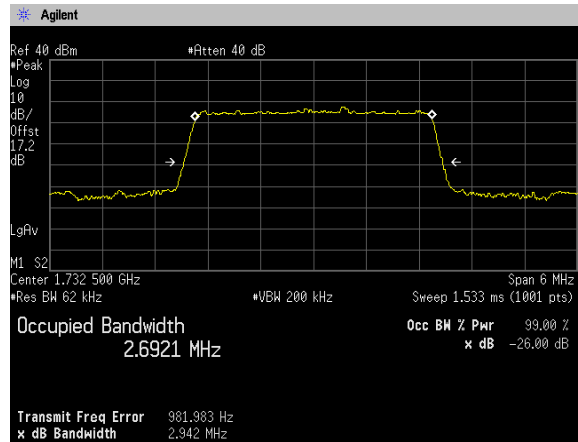

16QAM, BW 3MHz

RB8-4

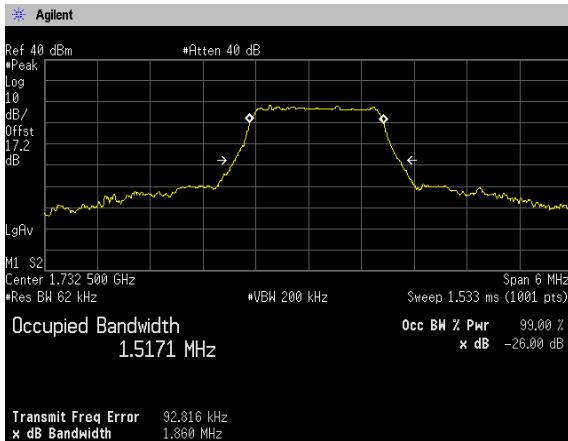

RB15-0

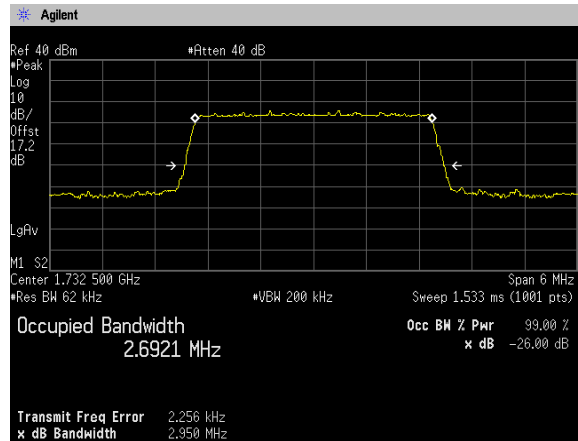

64QAM, BW 3MHz

RB8-4

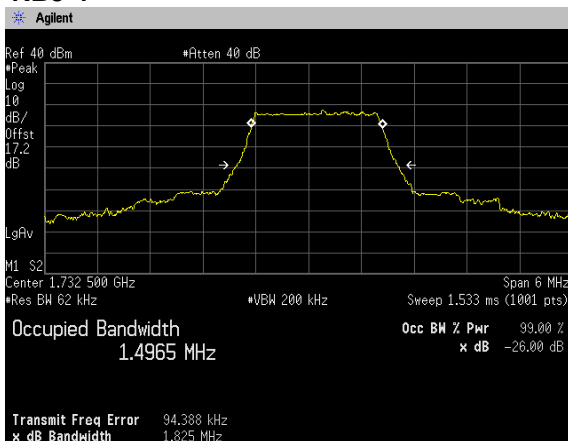

RB15-0

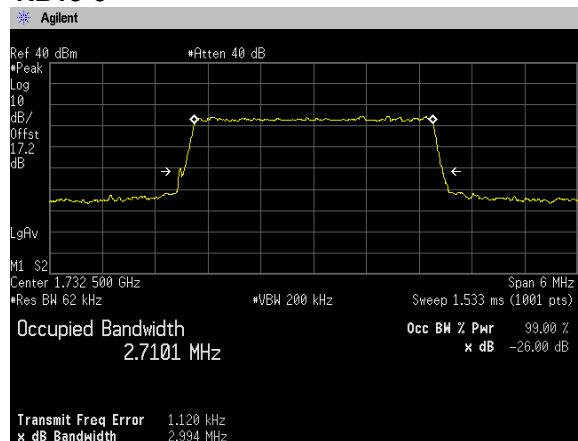



QPSK, BW 5MHz
RB12-7

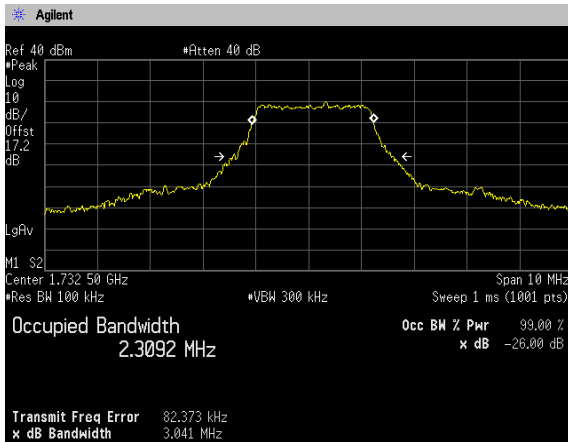

RB25-0

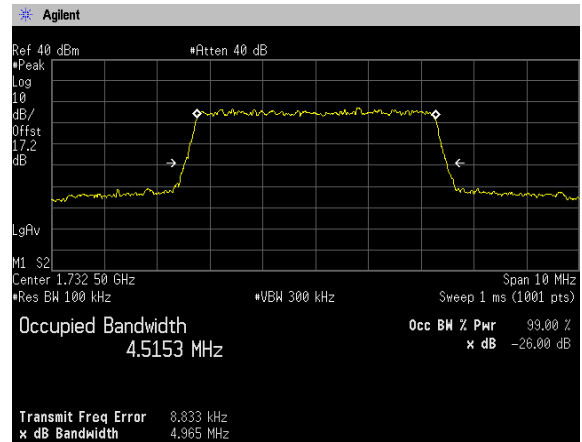

16QAM, BW 5MHz
RB12-7

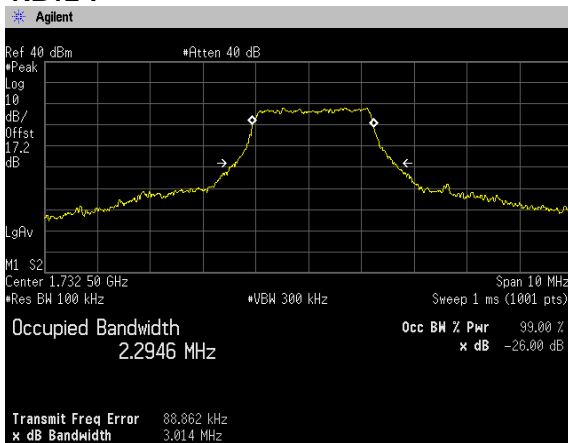

RB25-0

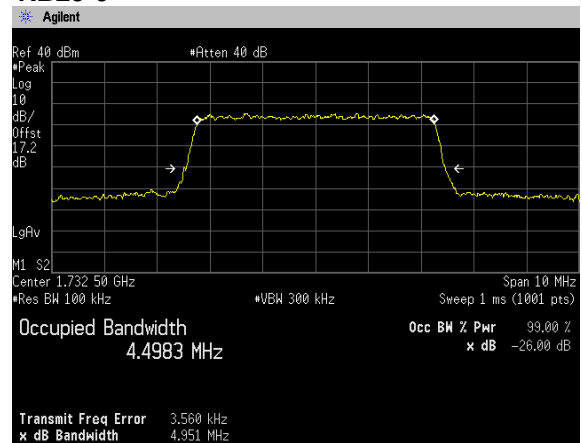

64QAM, BW 5MHz
RB12-7

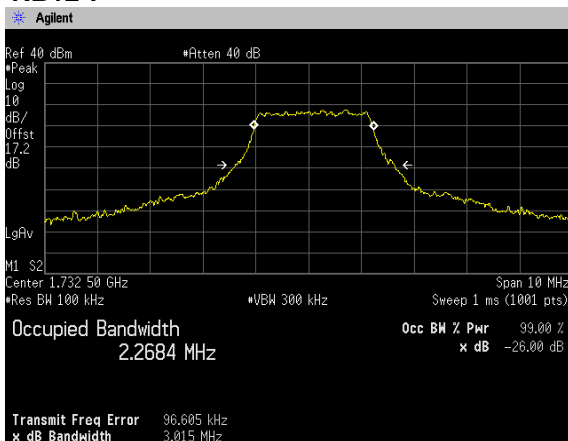

RB25-0

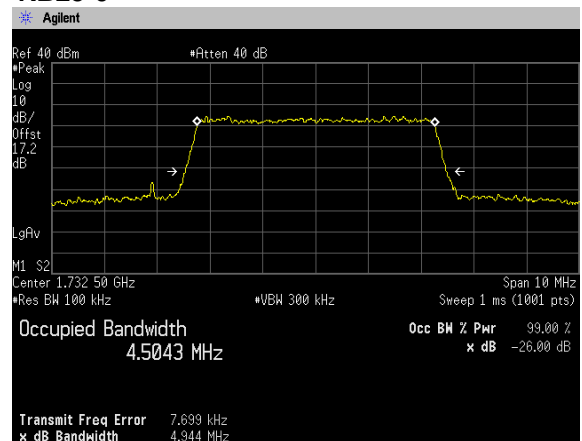



QPSK, BW 10MHz
RB25-12

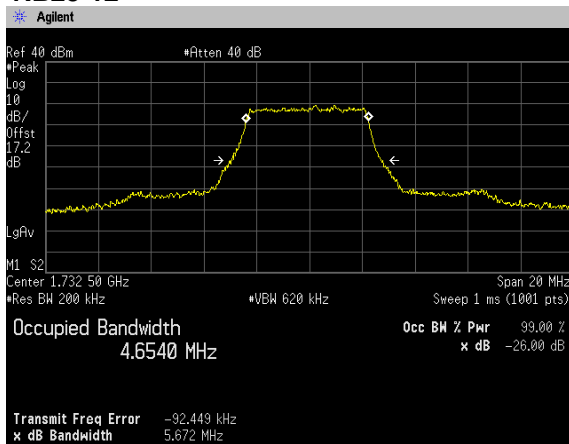

RB50-0

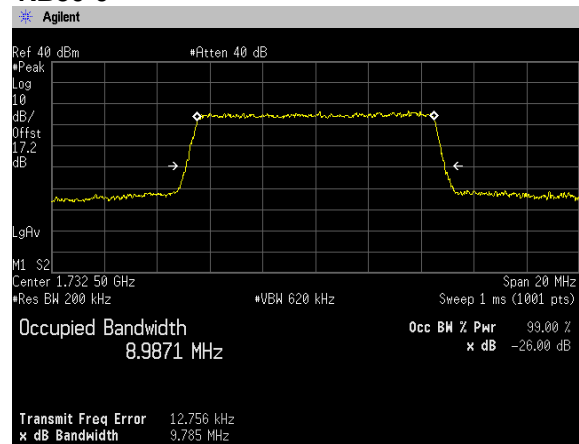

16QAM, BW 10MHz
RB25-12

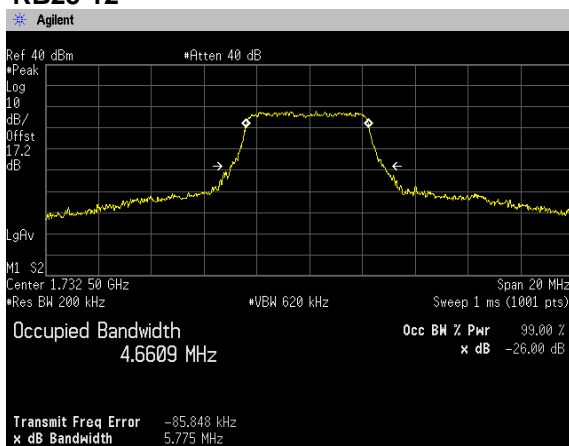

RB50-0

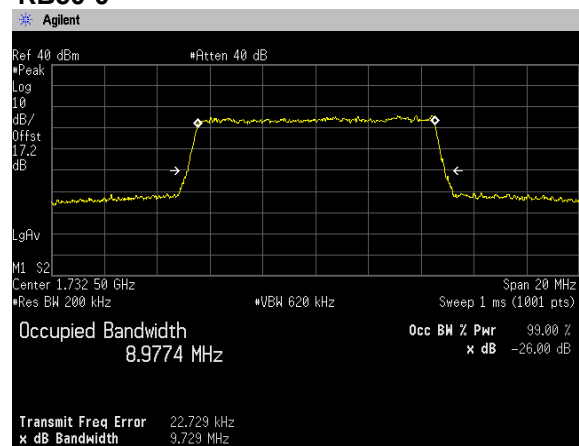

64QAM, BW 10MHz
RB25-12

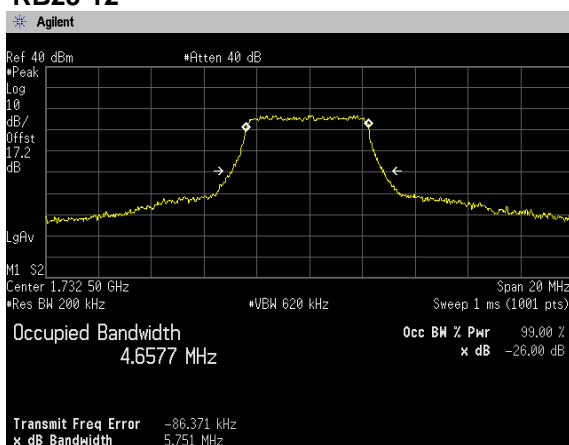

RB50-0

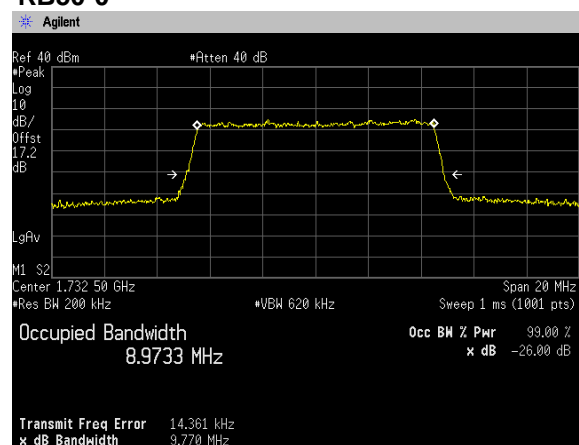



QPSK, BW 15MHz

RB36-20

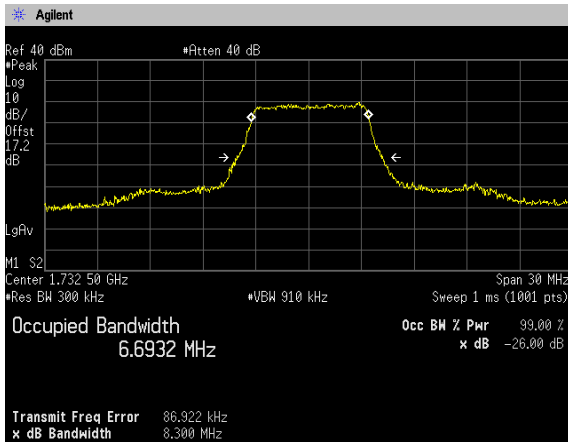

RB75-0

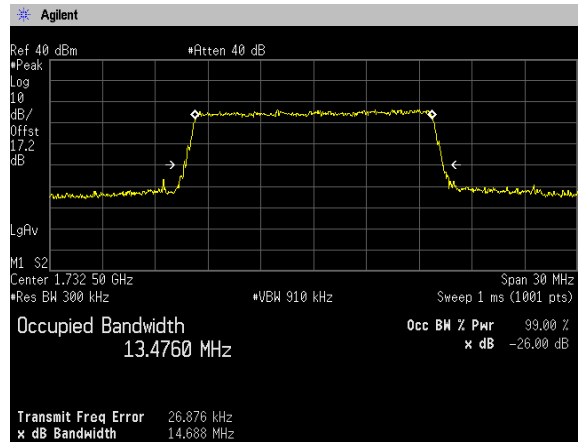

16QAM, BW 15MHz

RB36-20

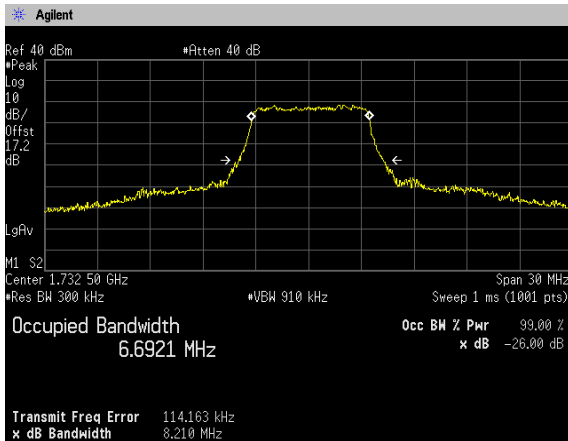

RB75-0

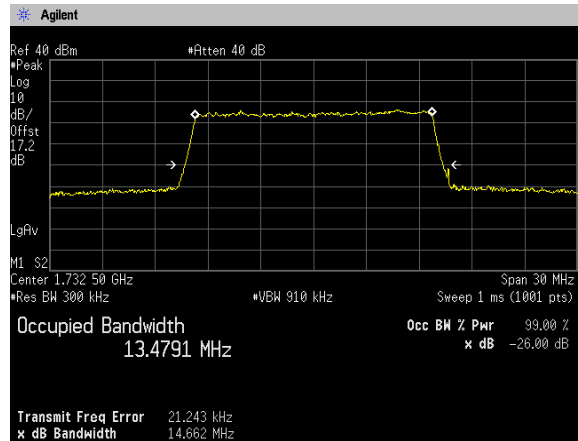

64QAM, BW 15MHz

RB36-20

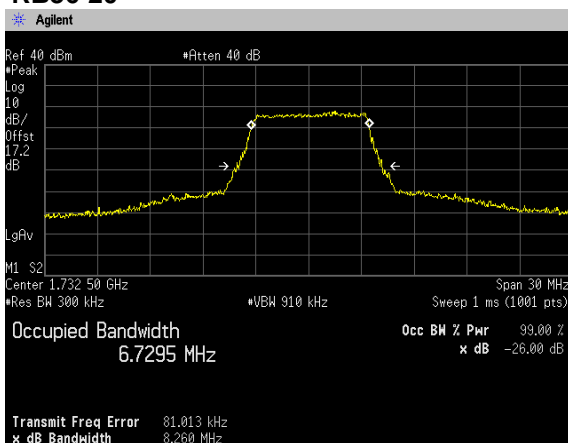

RB75-0

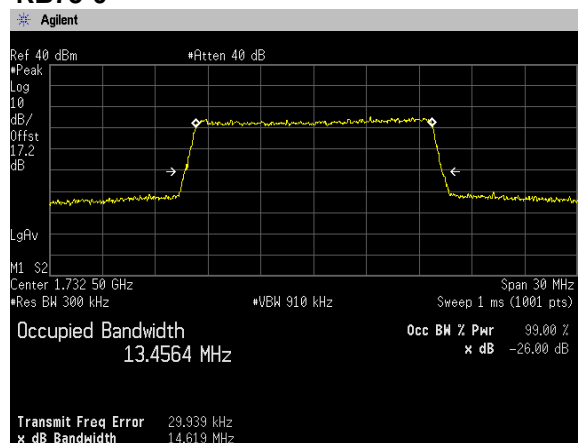



QPSK, BW 20MHz
RB50-24

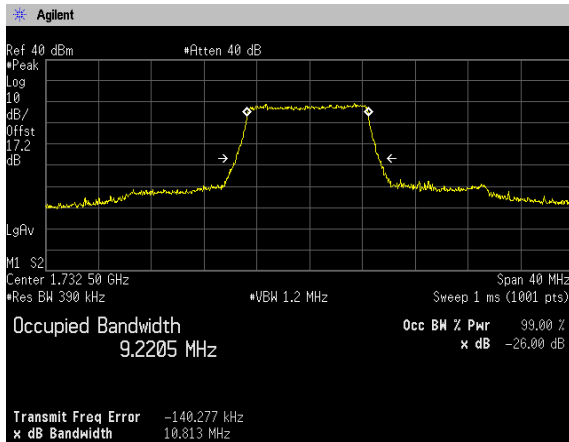

RB100-0

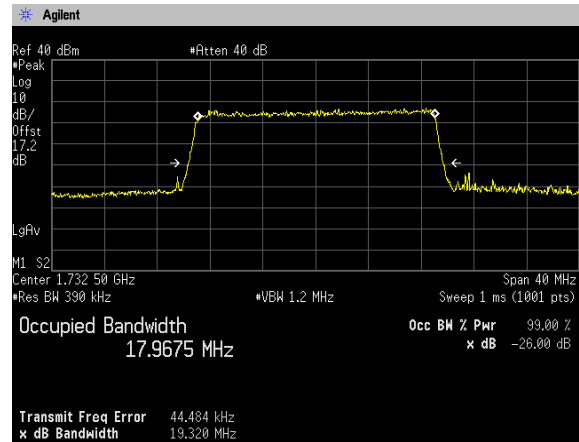

16QAM, BW 20MHz
RB50-24

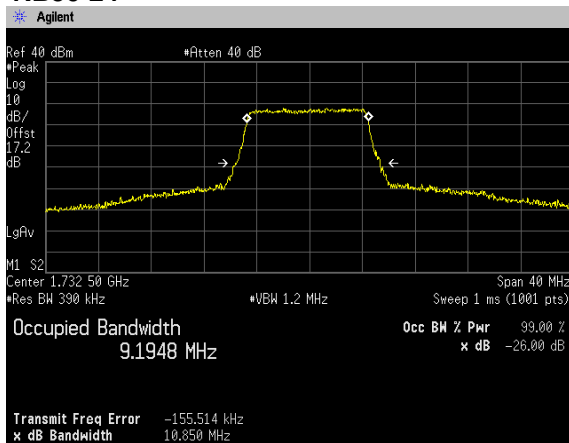

RB100-0

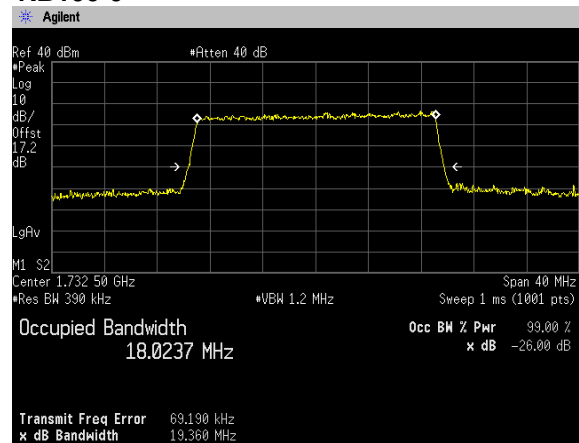

64QAM, BW 20MHz
RB50-24

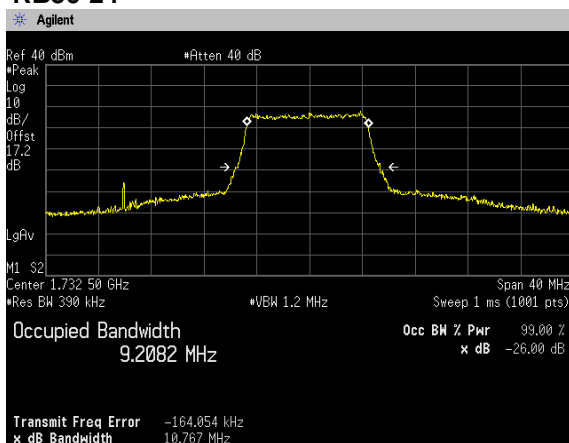

RB100-0

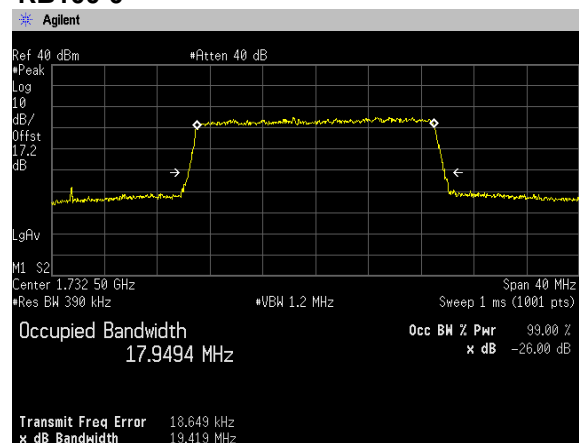

4.4 Band Edge Spurious and Harmonic at Antenna Terminals

4.4.1 Measurement procedure

[FCC 27.53, 2.1051]

The band edge spurious and harmonic was measured with a spectrum analyzer connected to the antenna terminal.

The spectrum analyzer is set to;

<Band Edge>

- Span was set large enough so as to capture all out of band emissions near the band edge
- RBW \geq 1% of the emission bandwidth or 2% of the emission bandwidth
- VBW \geq 3 x RBW
- Detector = RMS
- Trace mode = Max hold
- Sweep time = auto-couple
- Number of sweep point \geq 2 x span / RBW

<Spurious Emissions>

- RBW = 1MHz & VBW \geq 3 x RBW
- Detector = Peak
- Trace mode = Max hold
- Sweep time = auto-couple
- Number of sweep point \geq 2 x span / RBW

- Test configuration

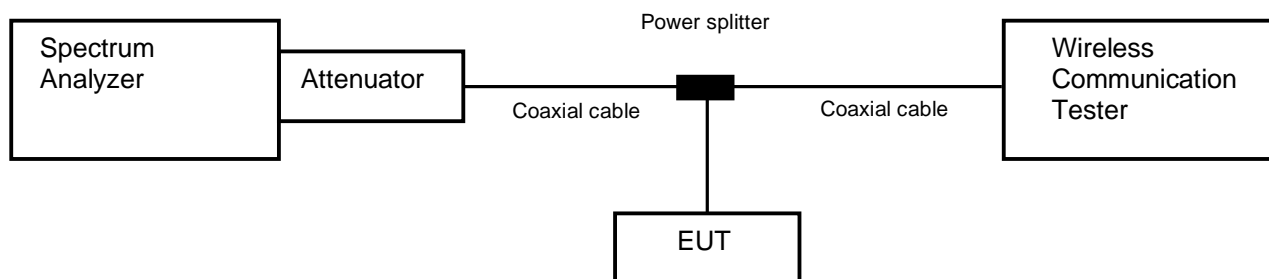

4.4.2 Limit

-13 dBm or less

4.4.3 Measurement result

Date : 2-May-2022
 Temperature : 20.8 [°C]
 Humidity : 47.9 [%]
 Test place : Shielded room No.4

Test engineer : Tadahiro Seino

Band	Channel	Frequency [MHz]	Limit [dBm]	Results	
WCDMA Band IV	1312	1712.4	-13.0	See the trace data	PASS
	1513	1752.6	-13.0	See the trace data	PASS

Band	Modulation	Bandwidth [MHz]	Channel	Frequency [MHz]	Limit [dBm]	Results	
LTE Band IV	QPSK, 16QAM, 64QAM	1.4	19957	1710.7	-13.0	See the trace data	PASS
			20393	1754.3	-13.0	See the trace data	PASS
		3	19965	1711.5	-13.0	See the trace data	PASS
			20385	1753.5	-13.0	See the trace data	PASS
		5	19975	1712.5	-13.0	See the trace data	PASS
			20375	1752.5	-13.0	See the trace data	PASS
		10	20000	1715.0	-13.0	See the trace data	PASS
			20350	1750.0	-13.0	See the trace data	PASS
		15	20025	1717.5	-13.0	See the trace data	PASS
			20325	1747.5	-13.0	See the trace data	PASS
		20	20050	1720.0	-13.0	See the trace data	PASS
			20300	1745.0	-13.0	See the trace data	PASS



4.4.4 Trace data

[WCDMA Band IV]
(Band Edge)

Channel: 1312

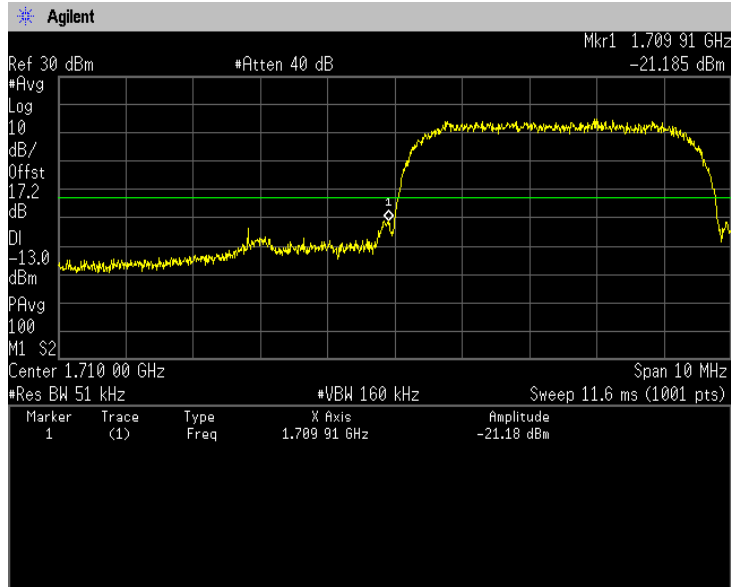

Channel: 1513

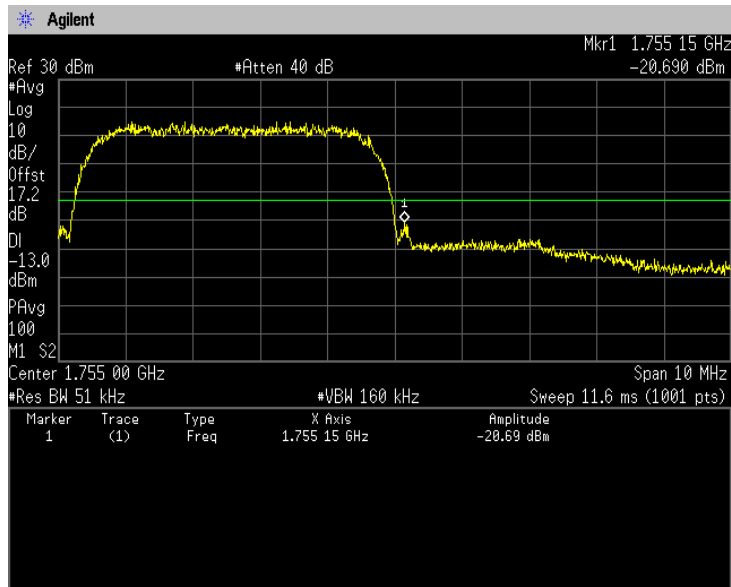

(Spurious Emissions)

Note: Conducted spurious test was measured in the worst case of conducted output power.

**Channel: 1312
30MHz-5GHz**

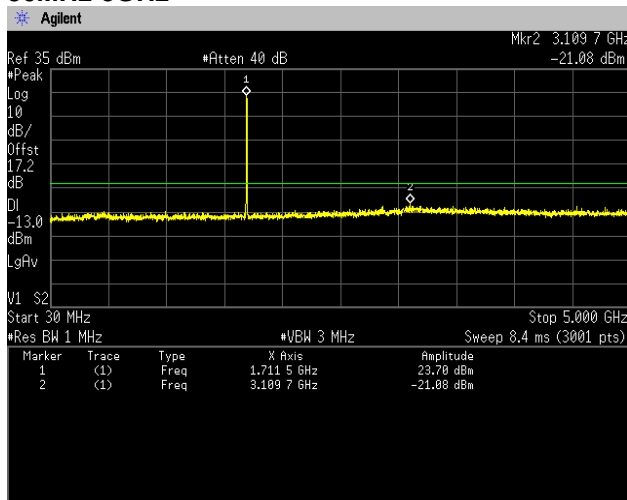

5GHz-10GHz

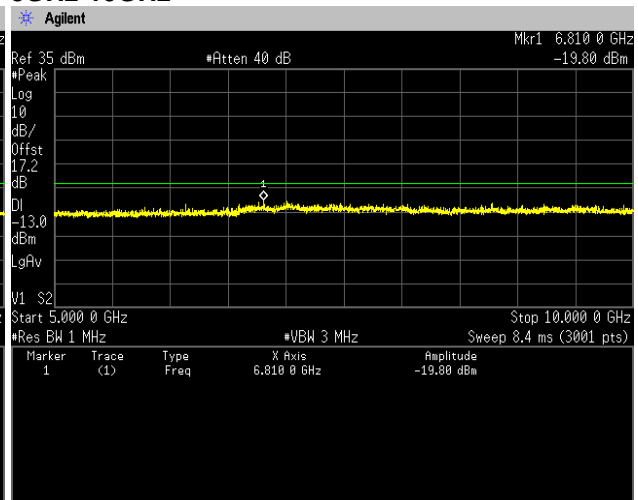

10GHz-15GHz

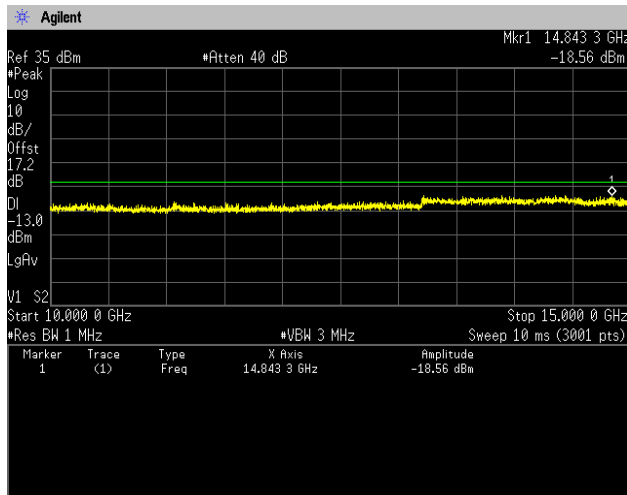

15GHz-20GHz

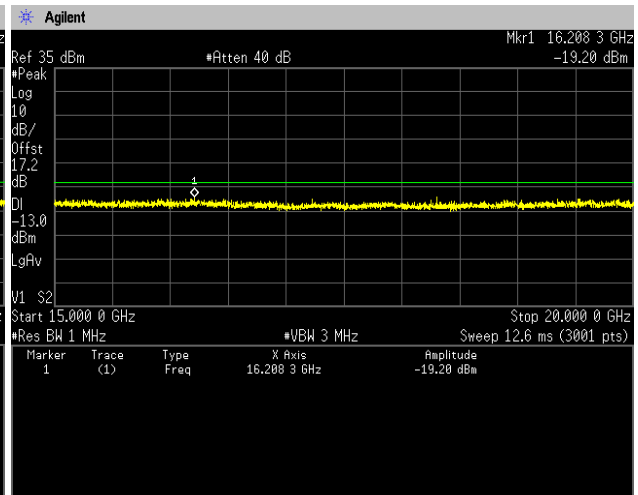



Channel: 1413
30MHz-5GHz

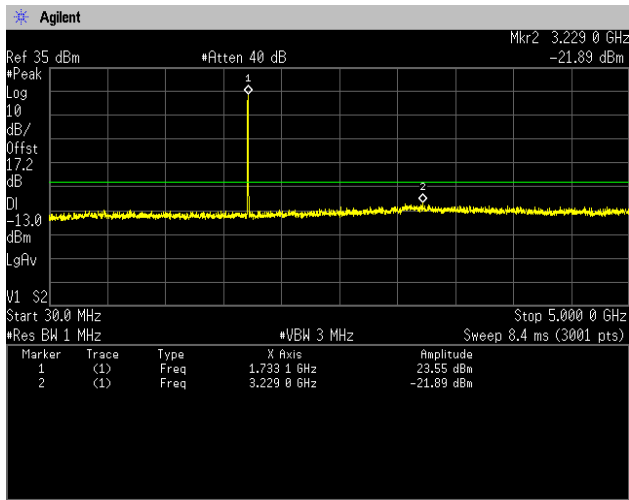

5GHz-10GHz

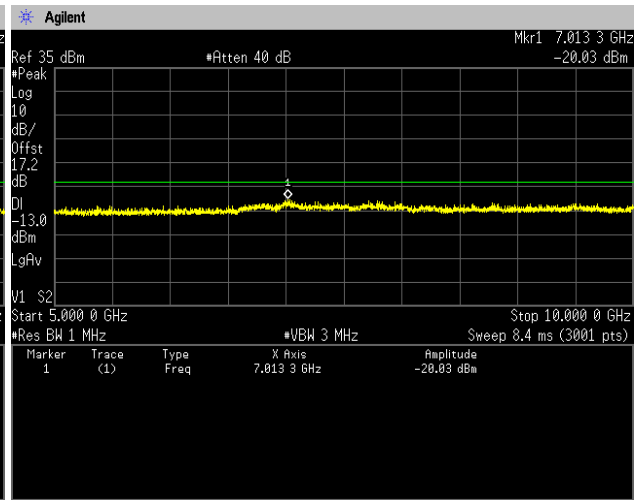

10GHz-15GHz

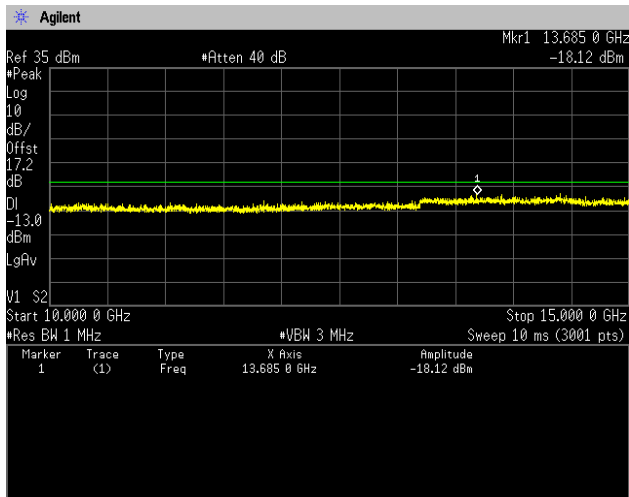

15GHz-20GHz

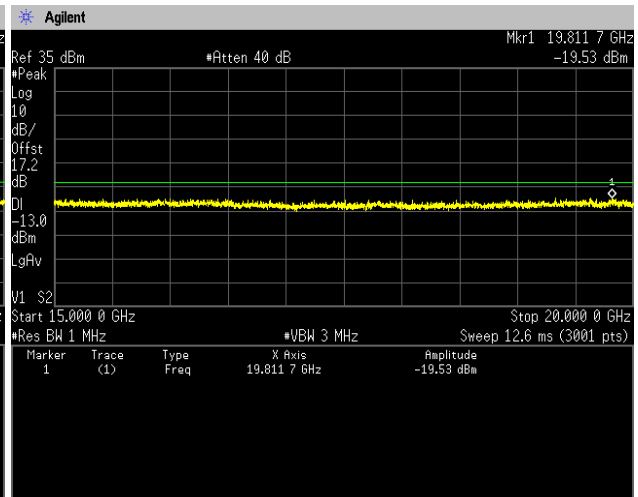



Channel: 1513
30MHz-5GHz

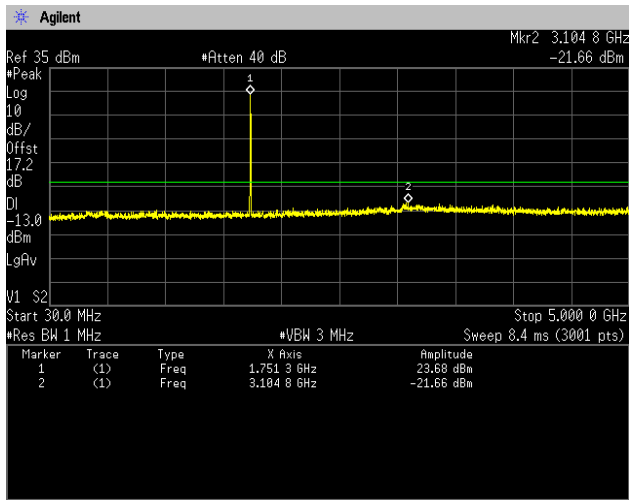

5GHz-10GHz

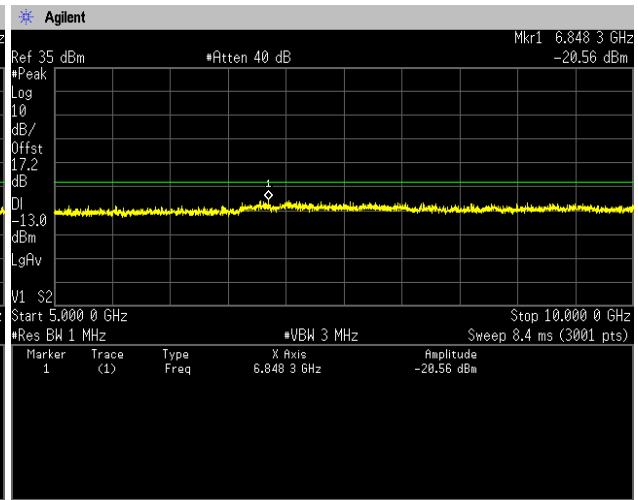

10GHz-15GHz

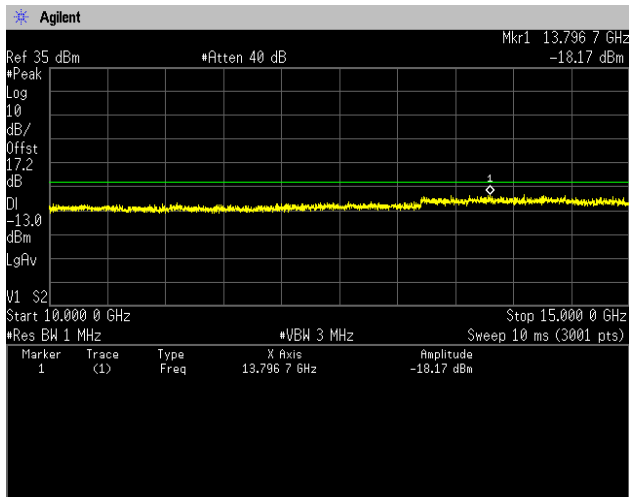

15GHz-20GHz

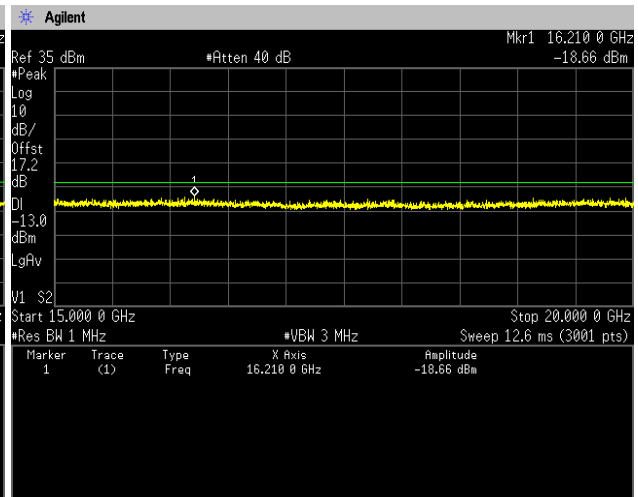

**[LTE Band IV]
(Band Edge)
QPSK, BW 1.4MHz, RB1-0
Channel: Low**

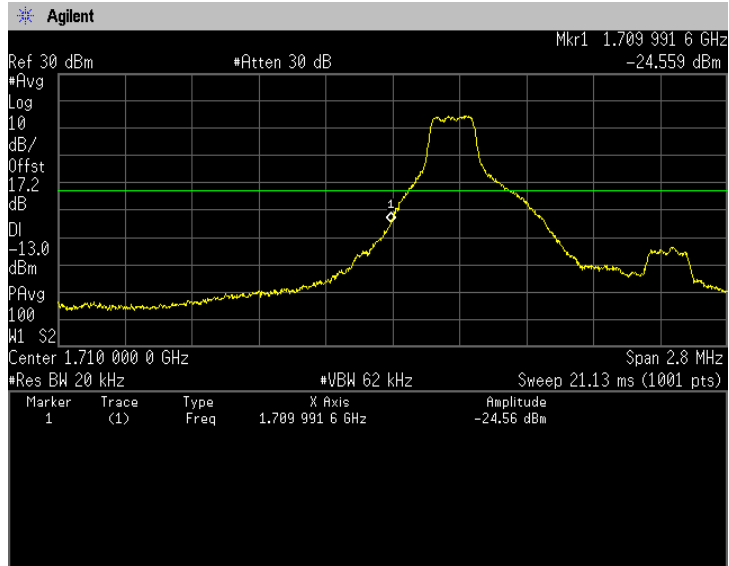

**QPSK, BW 1.4MHz, RB1-5
Channel: High**

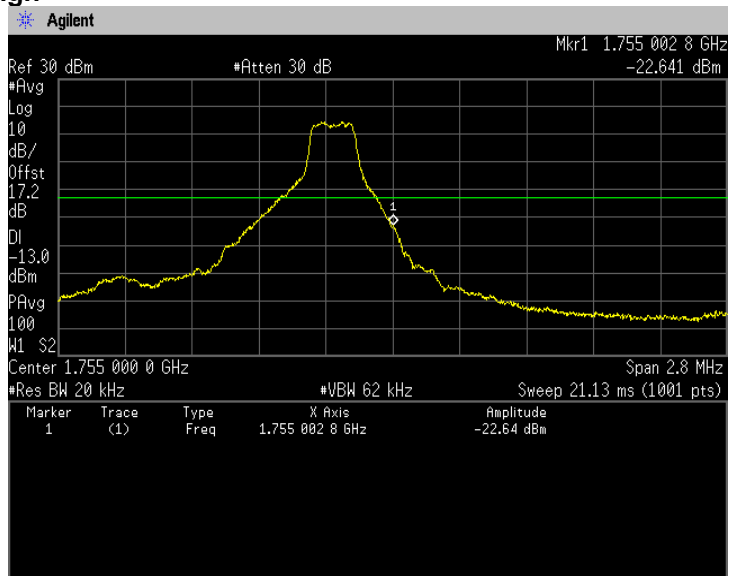



QPSK, BW 1.4MHz, RB6-0
Channel: Low

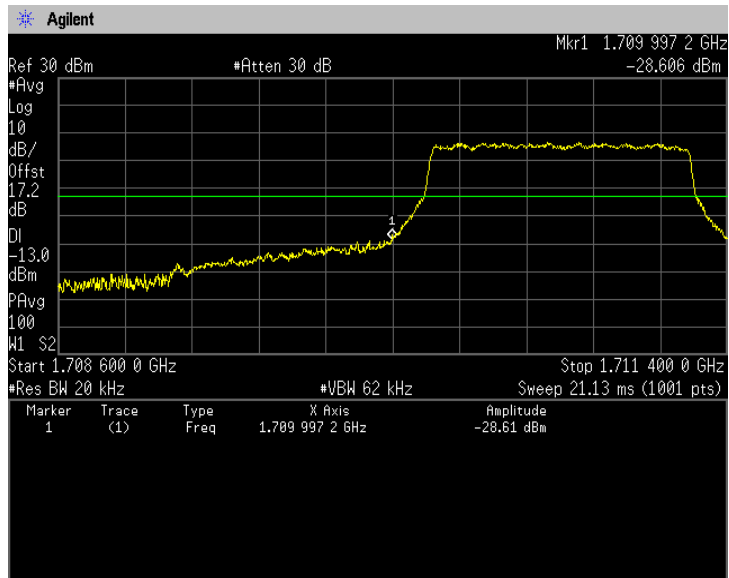

QPSK, BW 1.4MHz, RB6-0
Channel: High

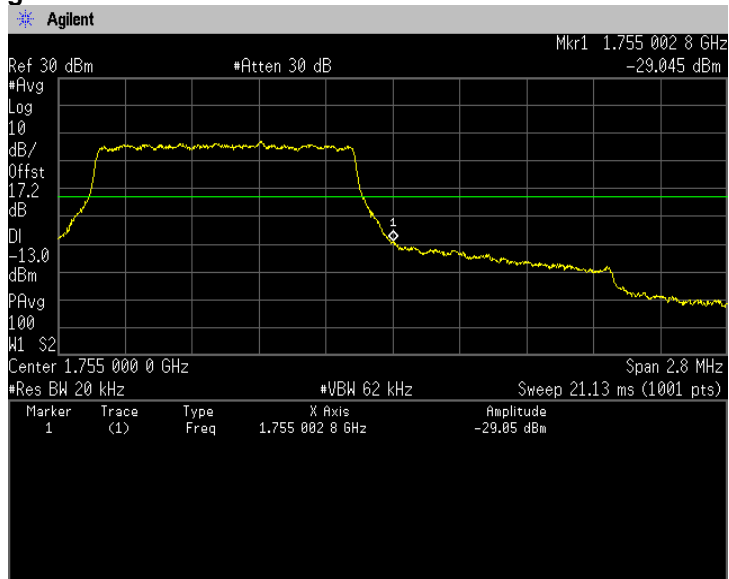



Japan

QPSK, BW 3MHz, RB1-0
Channel: Low

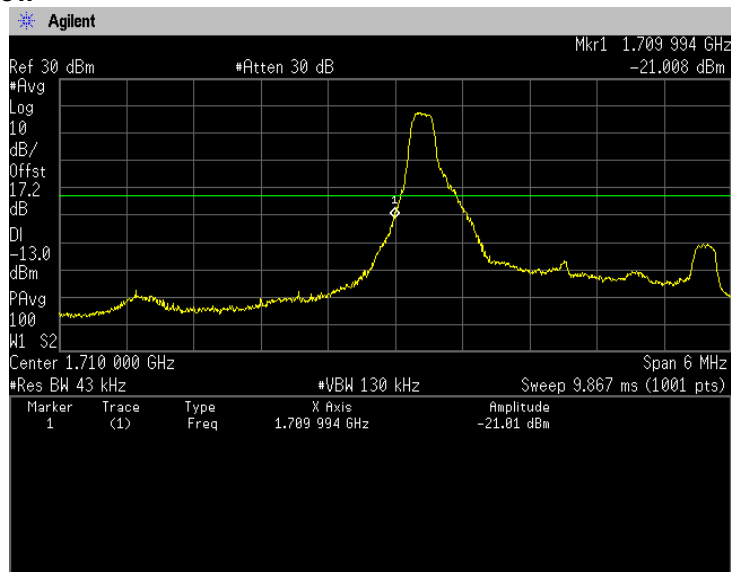

QPSK, BW 3MHz, RB1-14
Channel: High

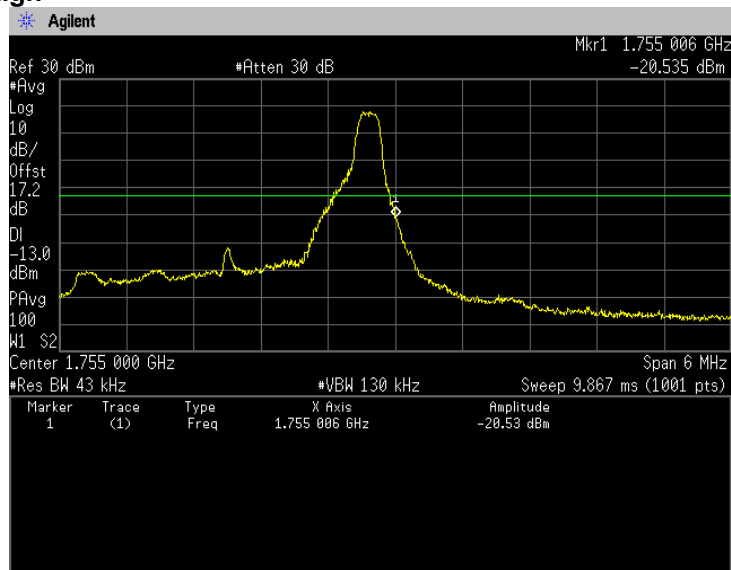



QPSK, BW 3MHz, RB15-0
Channel: Low

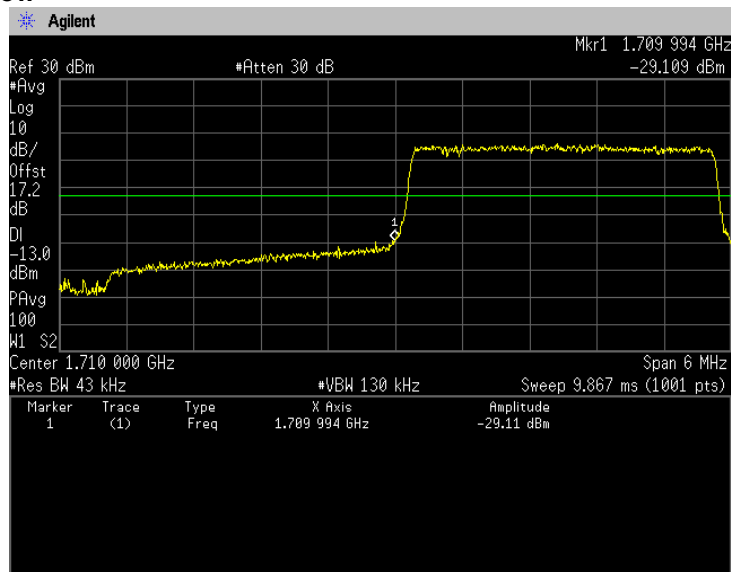

QPSK, BW 3MHz, RB15-0
Channel: High

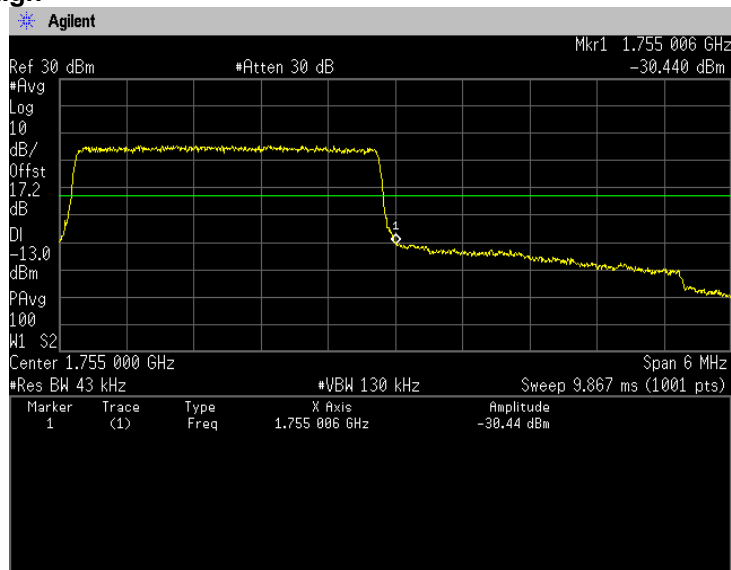



QPSK, BW 5MHz, RB1-0
Channel: Low

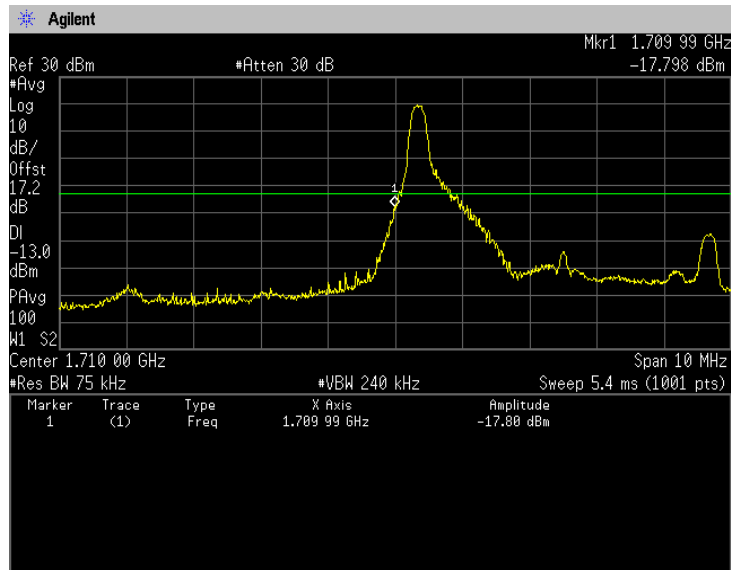

QPSK, BW 5MHz, RB1-24
Channel: High

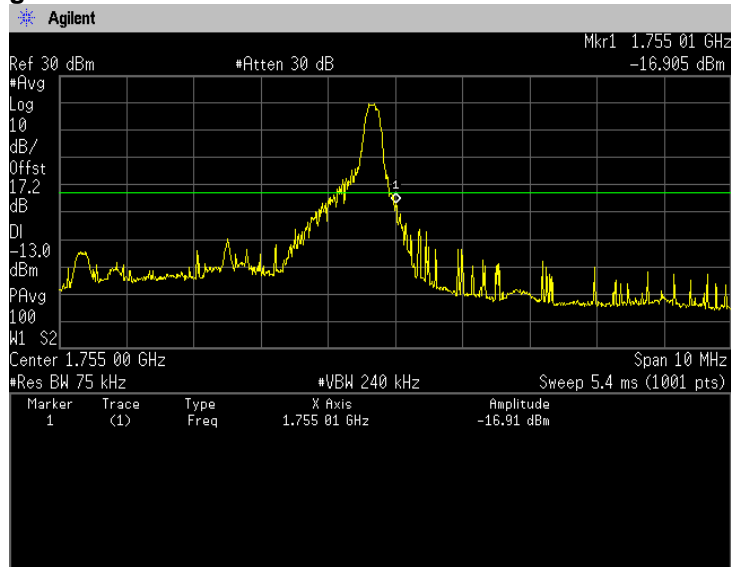



QPSK, BW 5MHz, RB25-0
Channel: Low

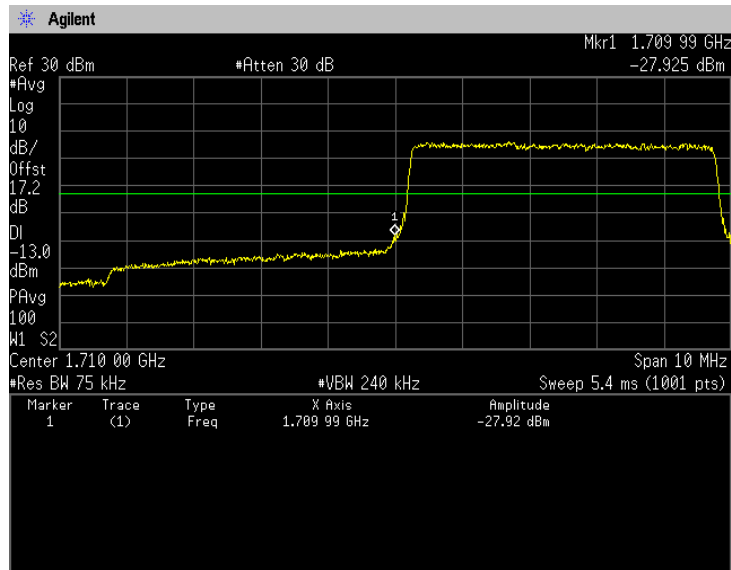

QPSK, BW 5MHz, RB25-0
Channel: High

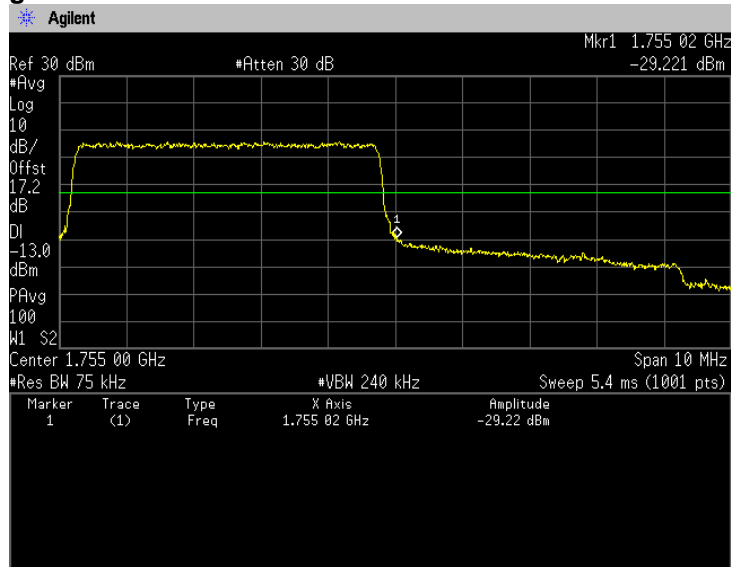



QPSK, BW 10MHz, RB1-0
Channel: Low

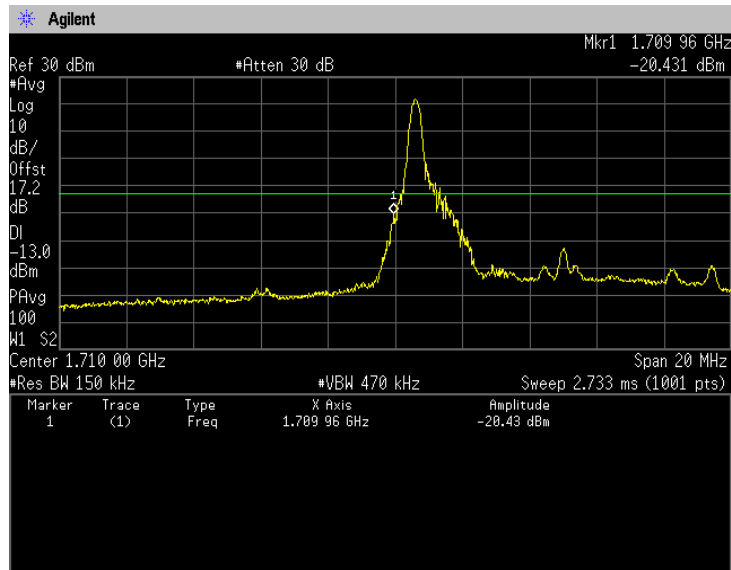

QPSK, BW 10MHz, RB1-49
Channel: High

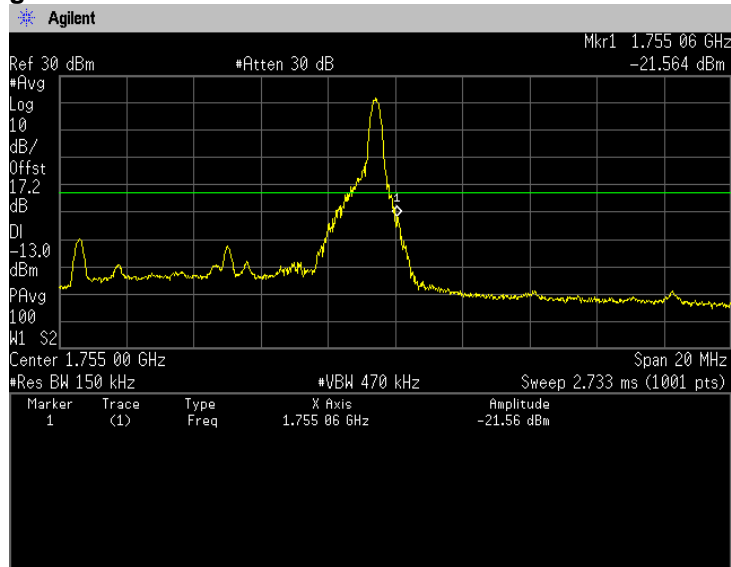



QPSK, BW 10MHz, RB50-0
Channel: Low

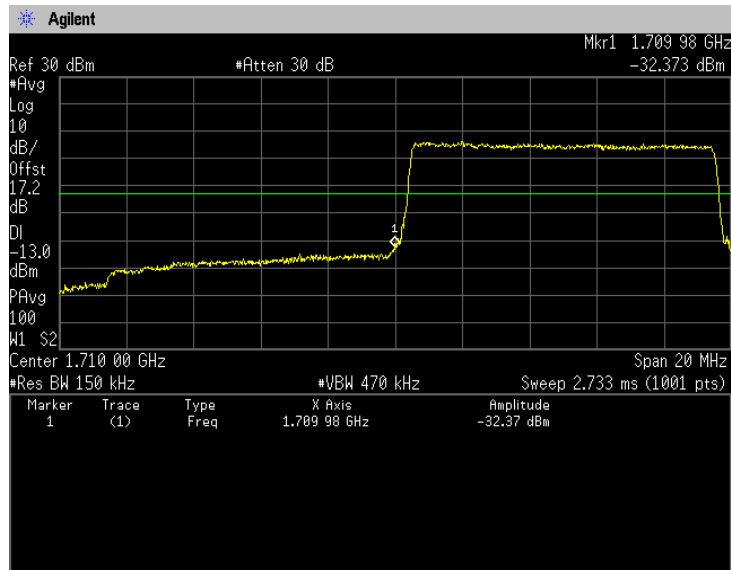

QPSK, BW 10MHz, RB50-0
Channel: High

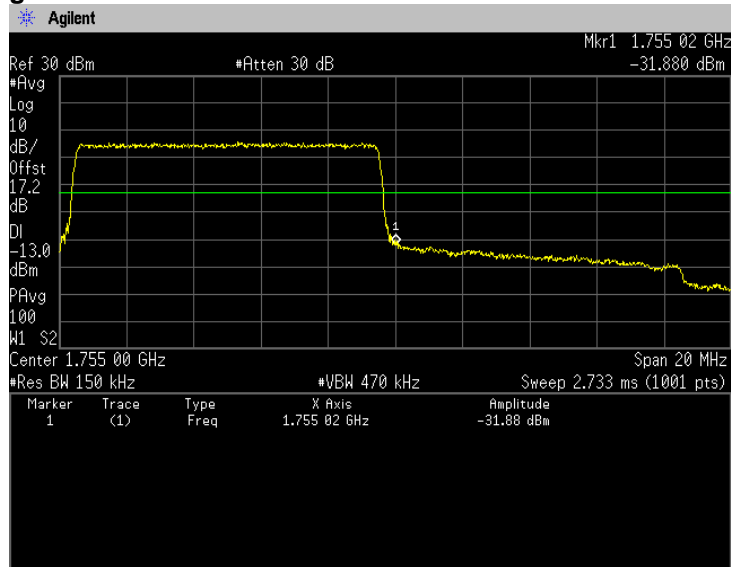



QPSK, BW 15MHz, RB1-0
Channel: Low

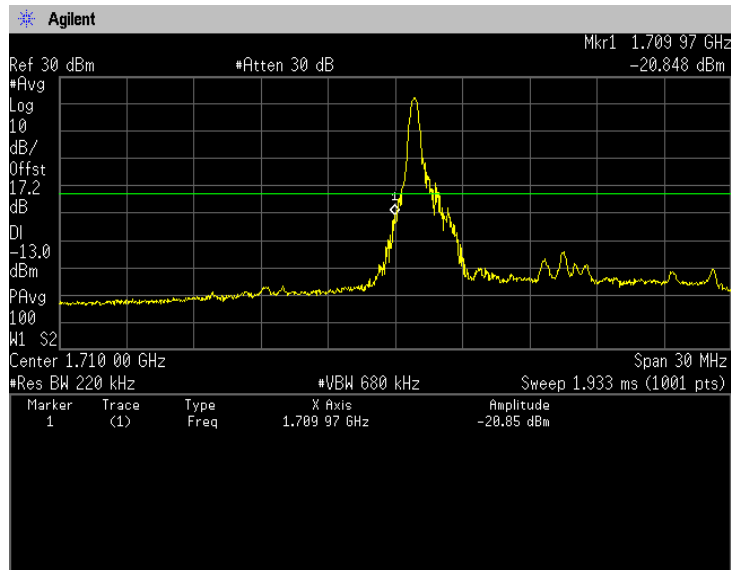

QPSK, BW 15MHz, RB1-74
Channel: High

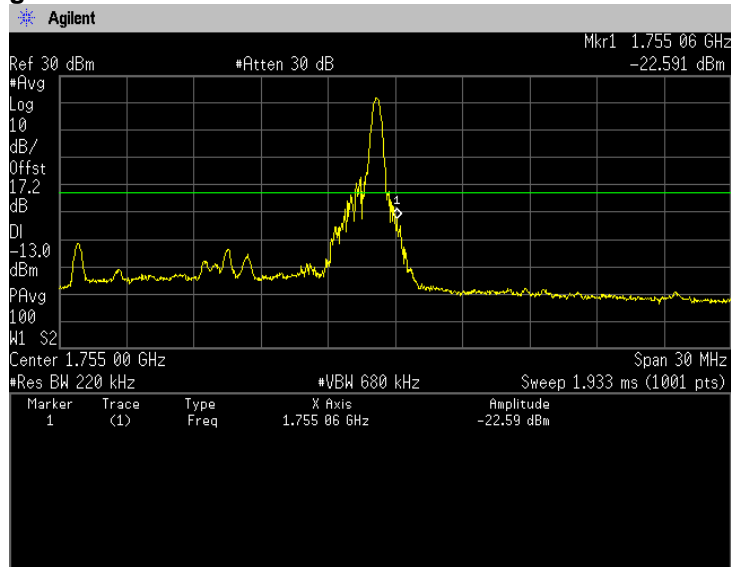



QPSK, BW 15MHz, RB75-0
Channel: Low

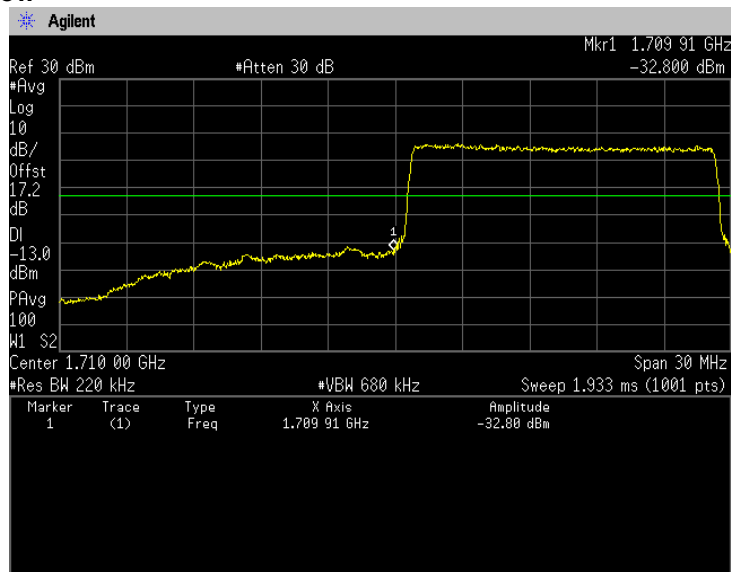

QPSK, BW 15MHz, RB75-0
Channel: High

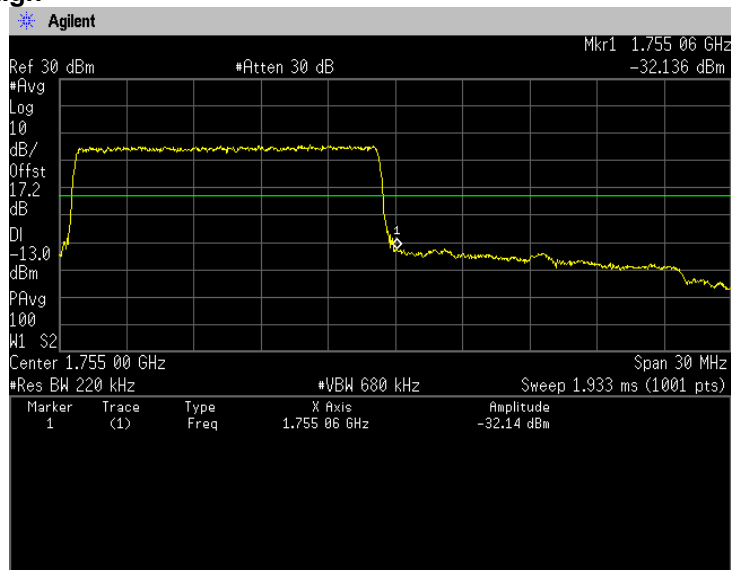



QPSK, BW 20MHz, RB1-0
Channel: Low

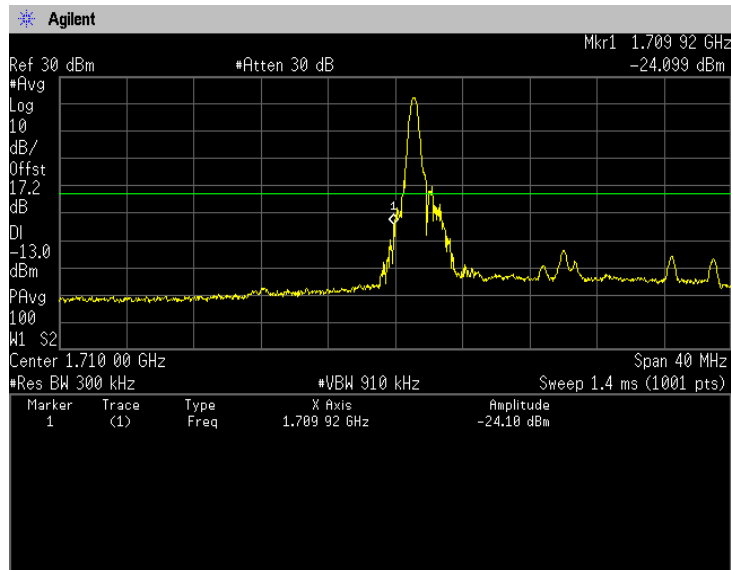

QPSK, BW 20MHz, RB1-99
Channel: High

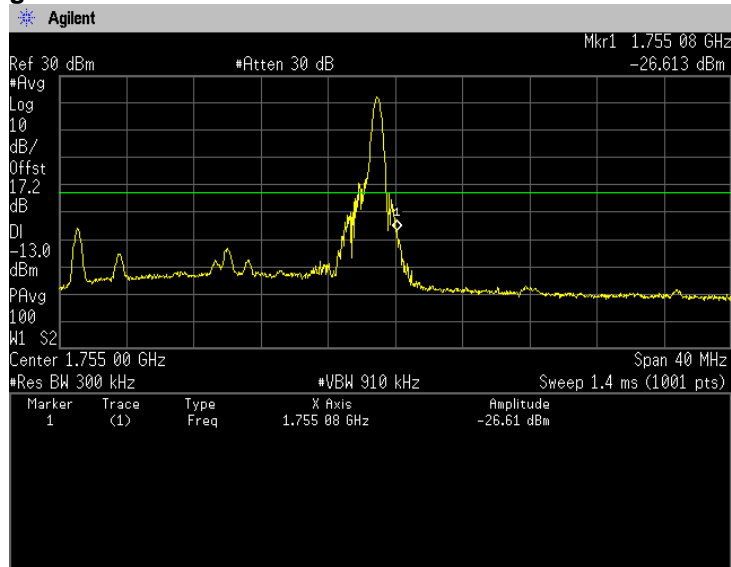



QPSK, BW 20MHz, RB100-0
Channel: Low

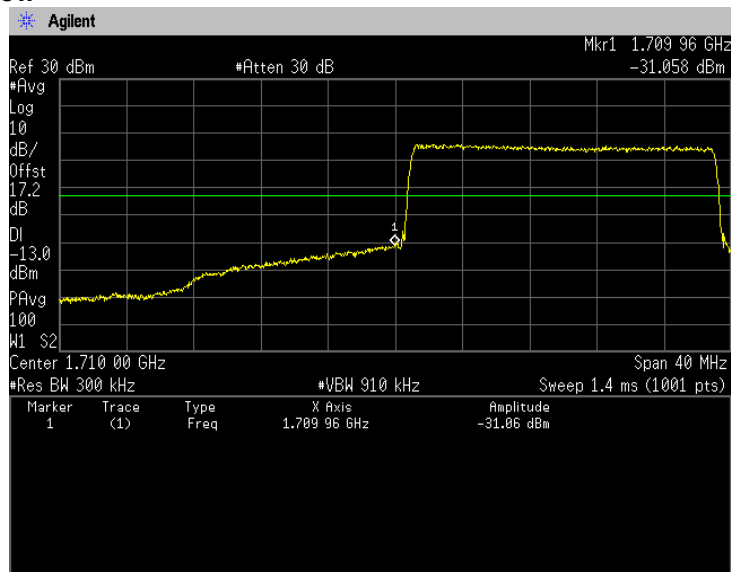

QPSK, BW 20MHz, RB100-0
Channel: High

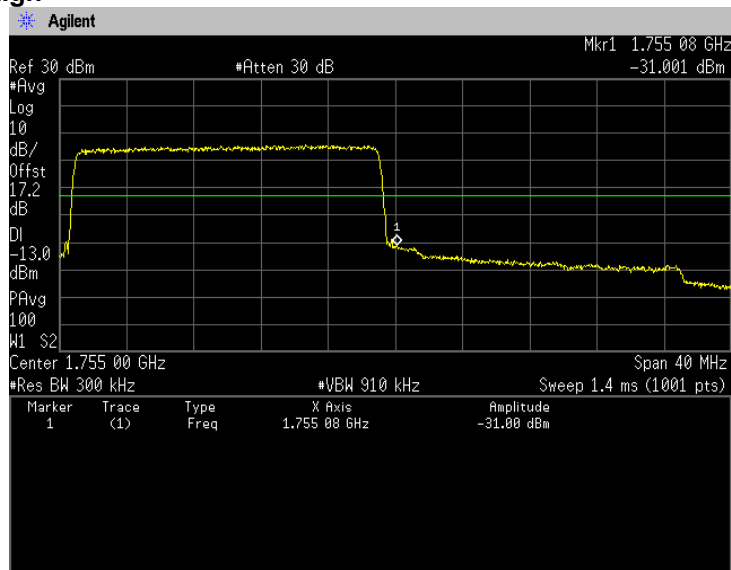



16QAM, BW 1.4MHz, RB1-0
Channel: Low

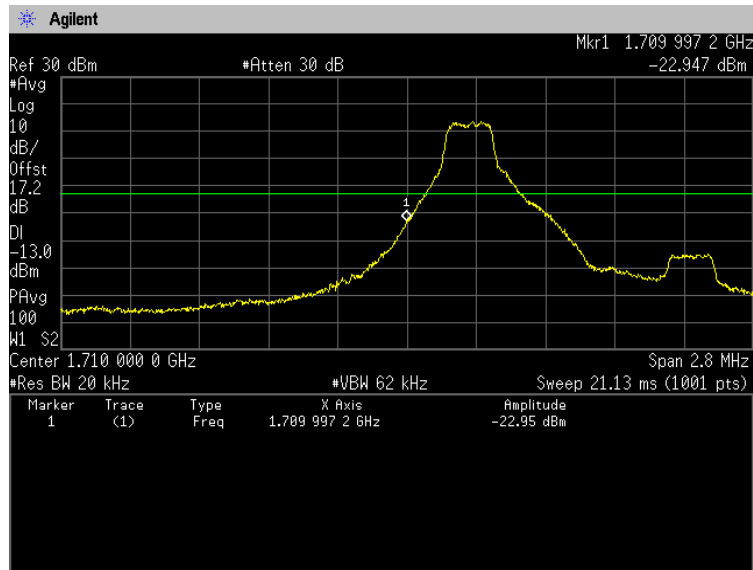

16QAM, BW 1.4MHz, RB1-5
Channel: High

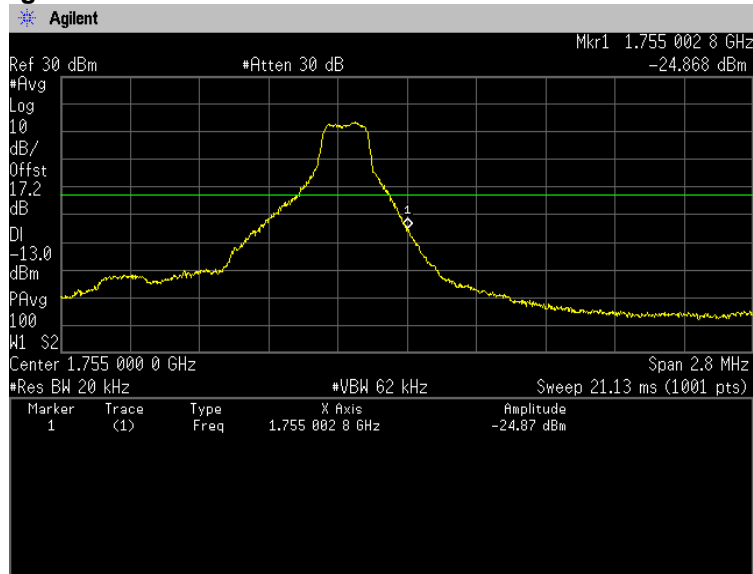



16QAM, BW 1.4MHz, RB6-0
Channel: Low

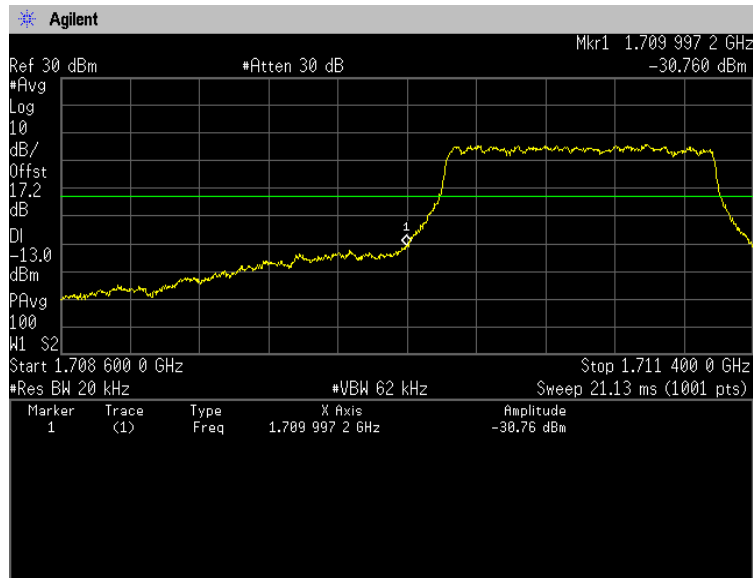

16QAM, BW 1.4MHz, RB6-0
Channel: High

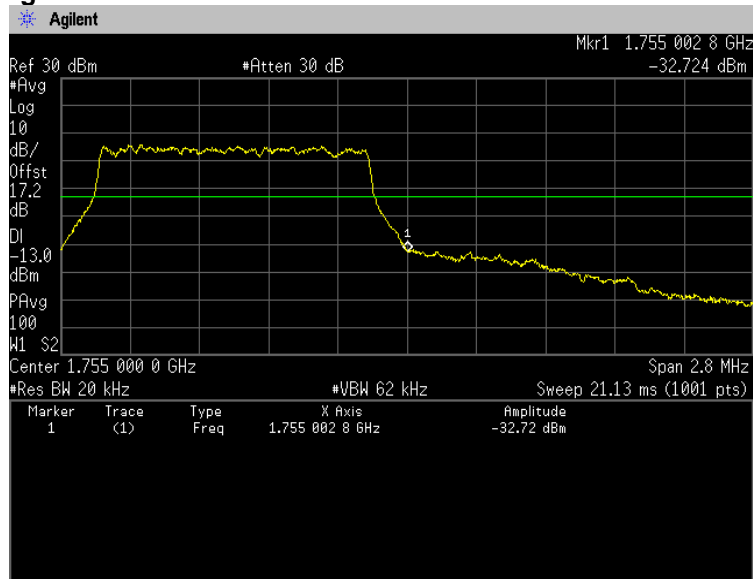



16QAM, BW 3MHz, RB1-0
Channel: Low

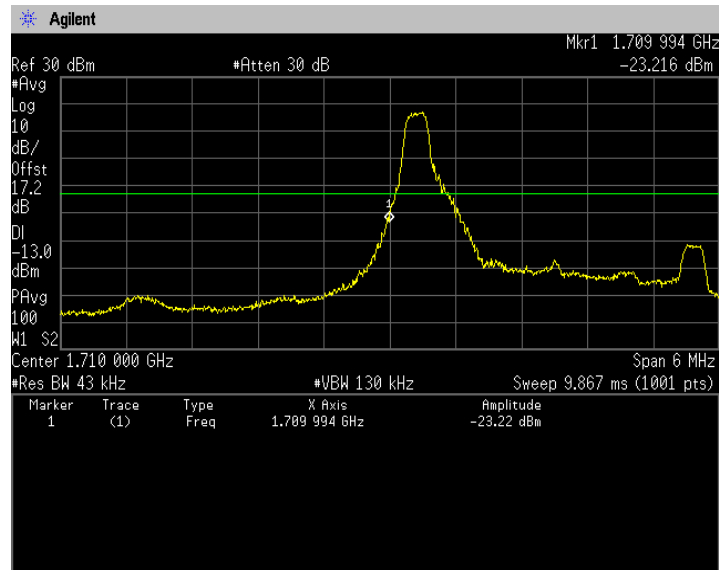

16QAM, BW 3MHz, RB1-14
Channel: High

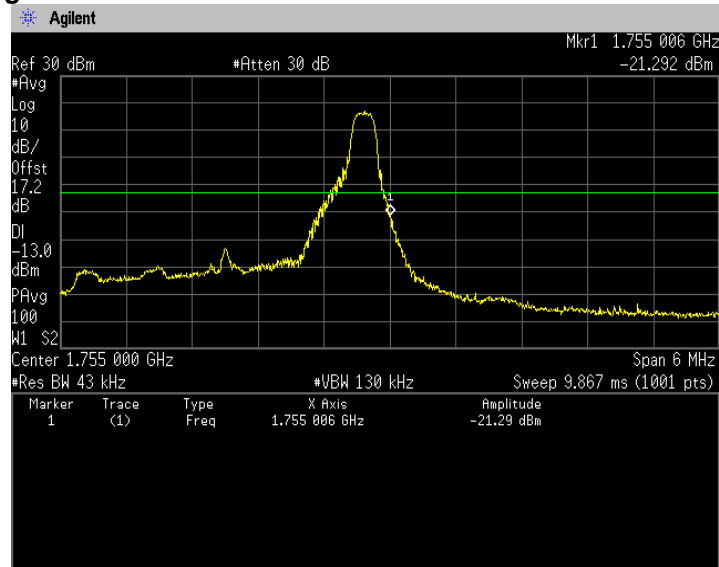



16QAM, BW 3MHz, RB15-0
Channel: Low

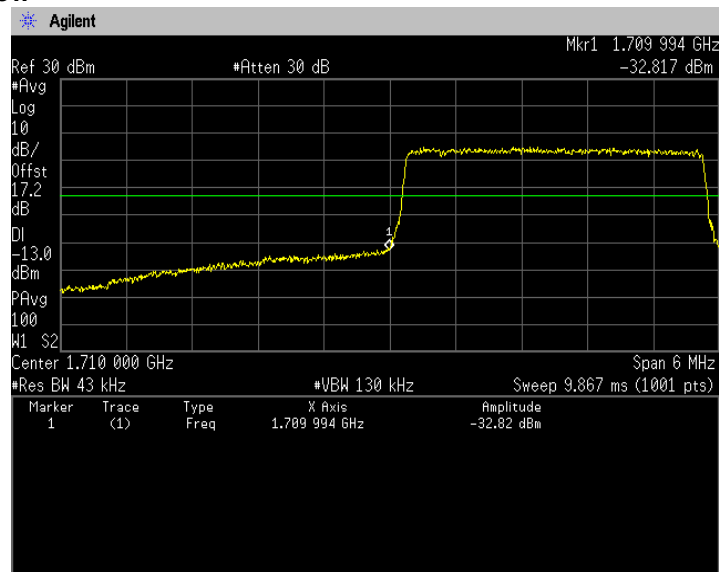

16QAM, BW 3MHz, RB15-0
Channel: High

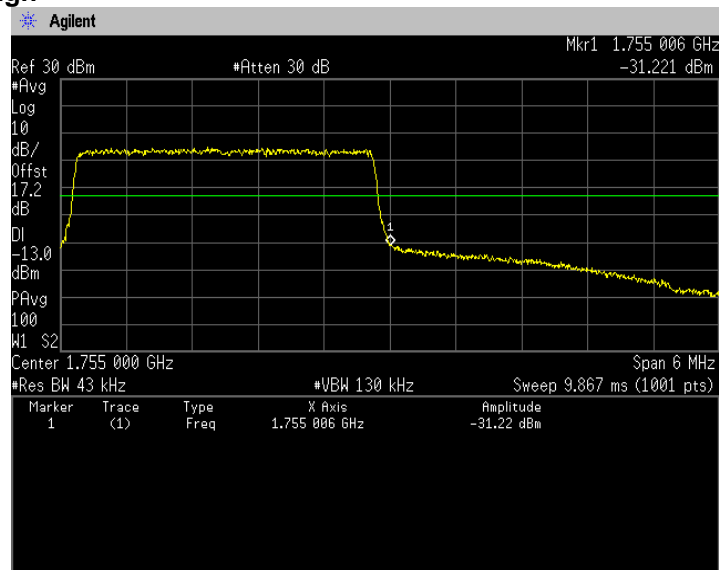



16QAM, BW 5MHz, RB1-0
Channel: Low

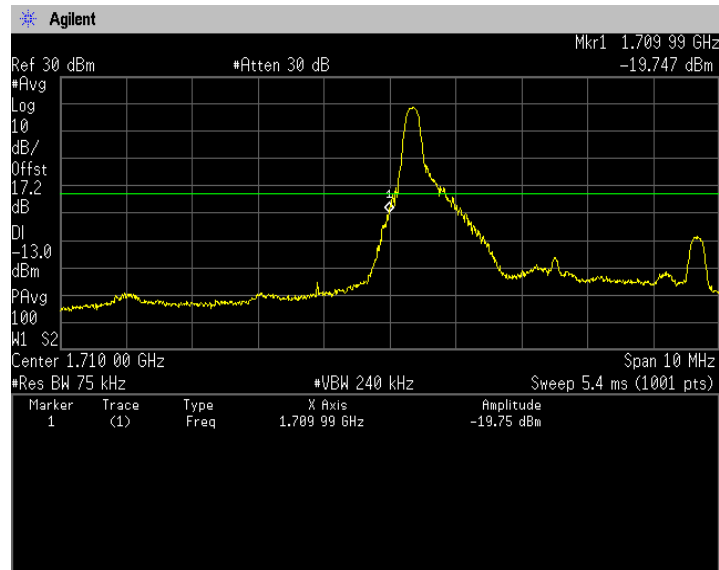

16QAM, BW 5MHz, RB1-24
Channel: High

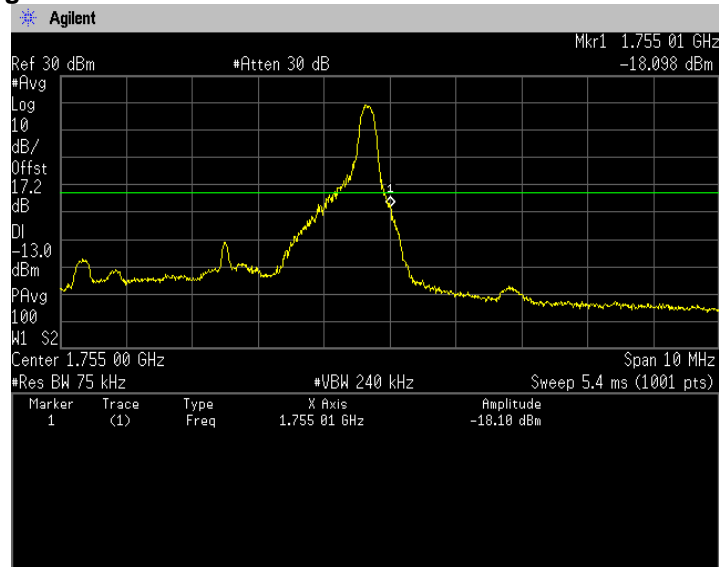



16QAM, BW 5MHz, RB25-0
Channel: Low

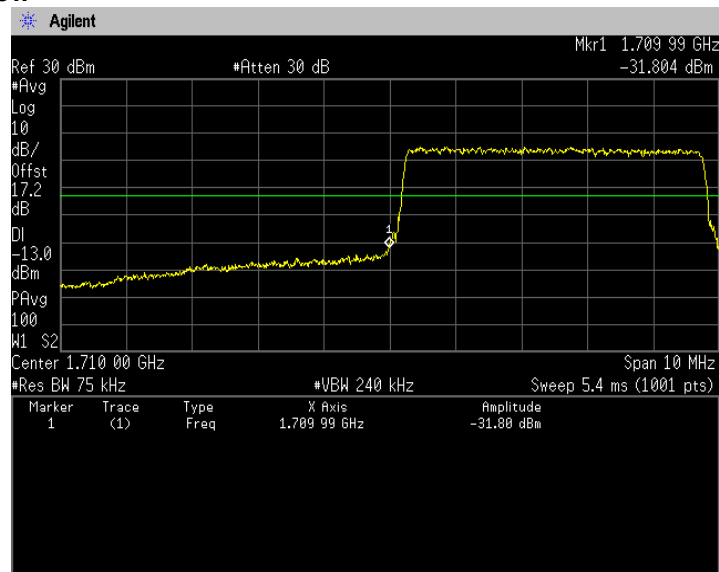

16QAM, BW 5MHz, RB25-0
Channel: High

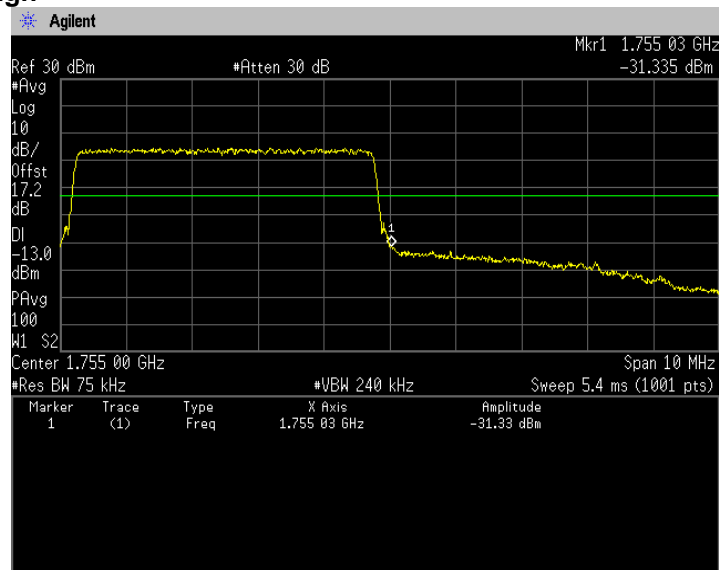



16QAM, BW 10MHz, RB1-0
Channel: Low

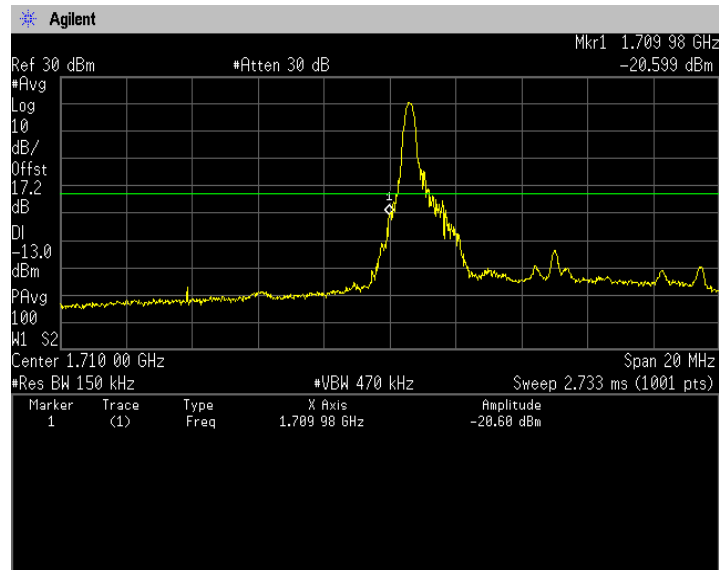

16QAM, BW 10MHz, RB1-49
Channel: High

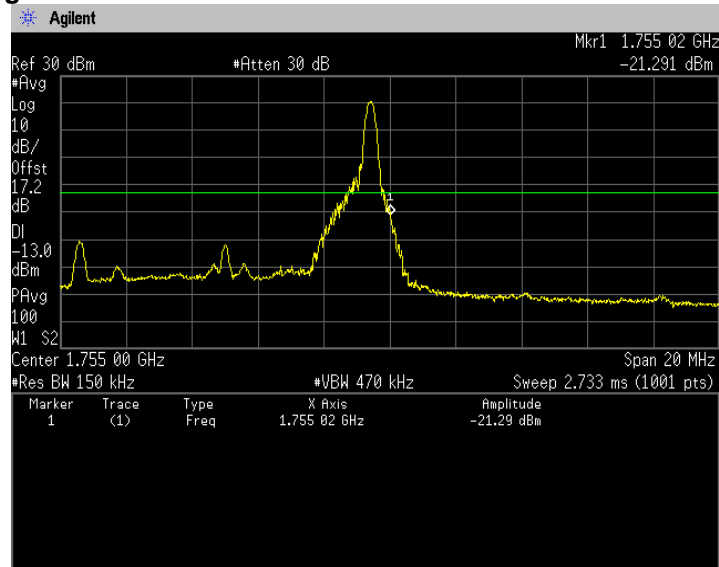



16QAM, BW 10MHz, RB50-0
Channel: Low

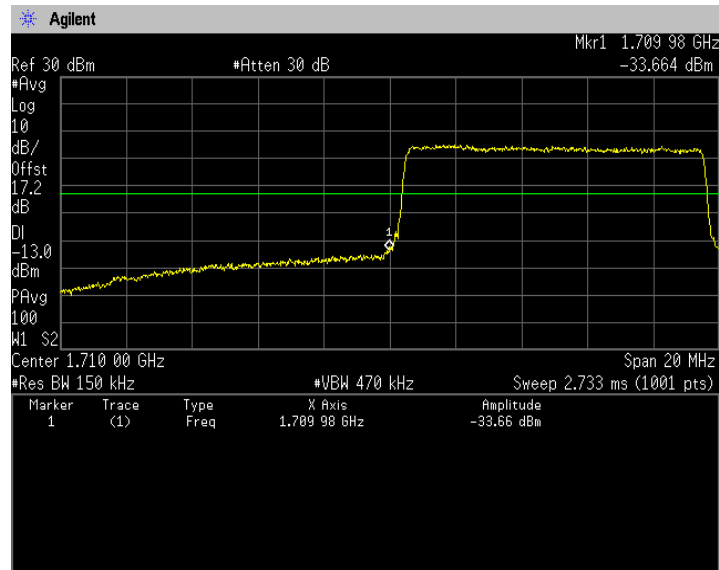

16QAM, BW 10MHz, RB50-0
Channel: High

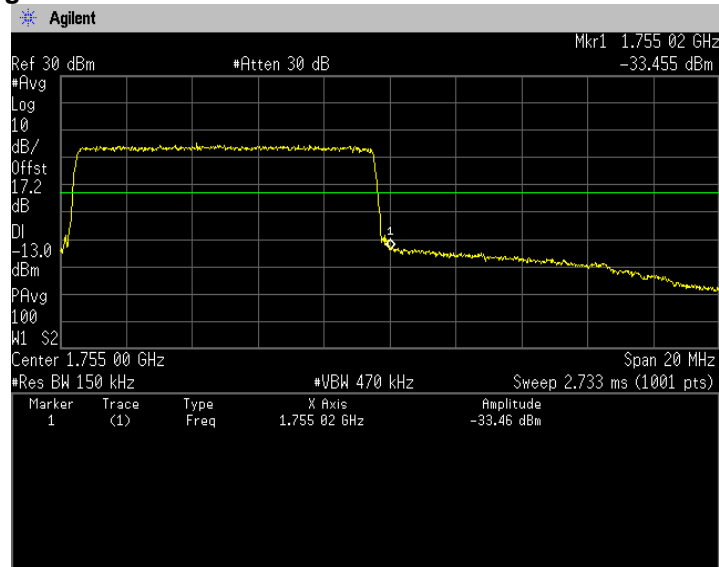



16QAM, BW 15MHz, RB1-0
Channel: Low

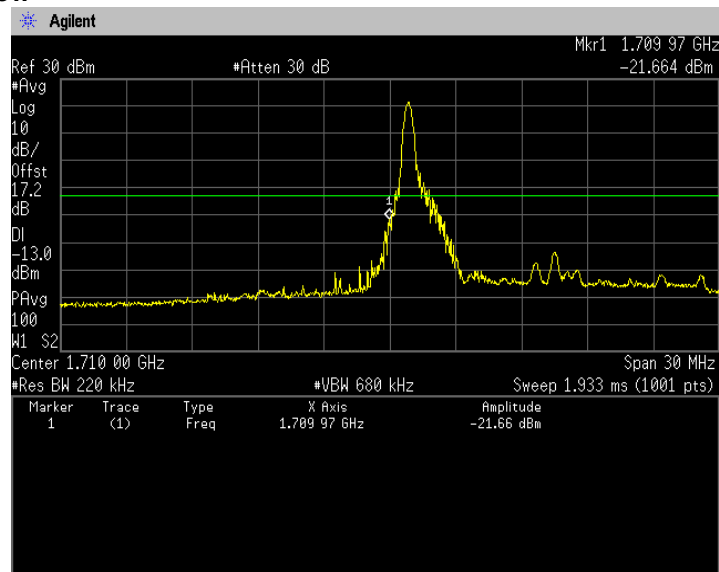

16QAM, BW 15MHz, RB1-74
Channel: High

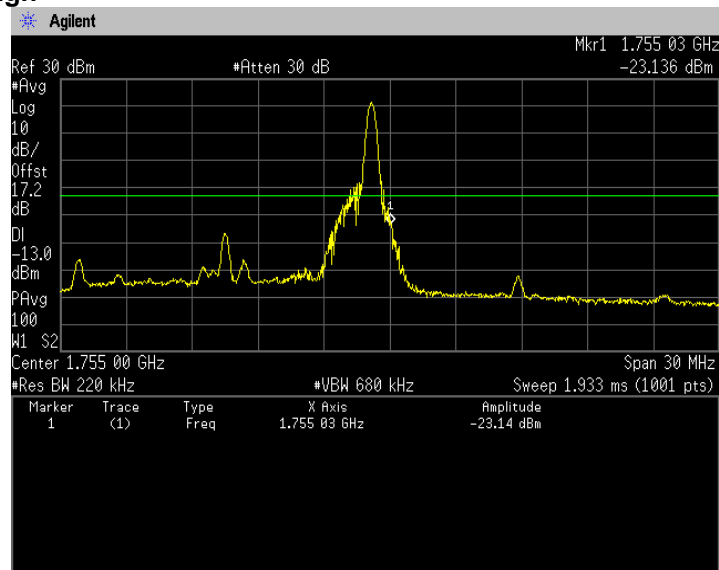



16QAM, BW 15MHz, RB75-0
Channel: Low

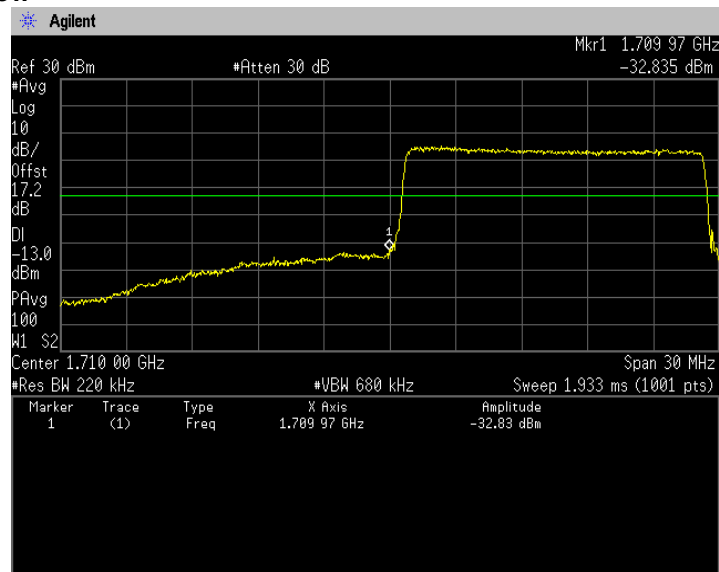

16QAM, BW 15MHz, RB75-0
Channel: High

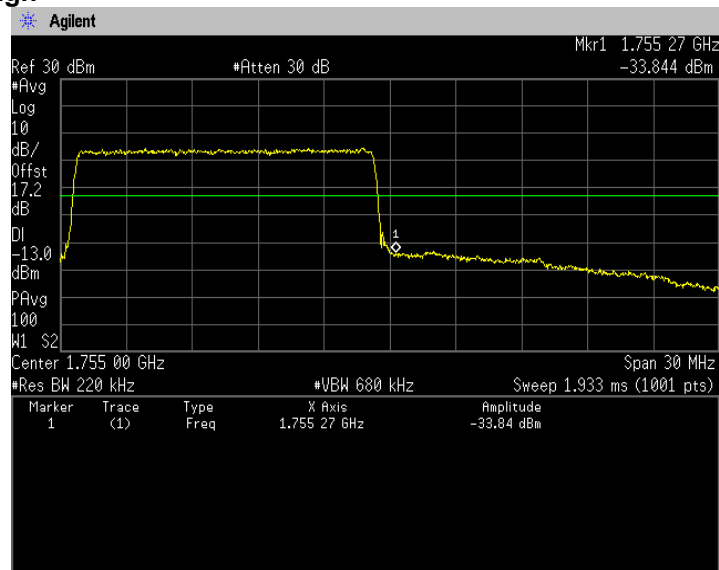



16QAM, BW 20MHz, RB1-0
Channel: Low

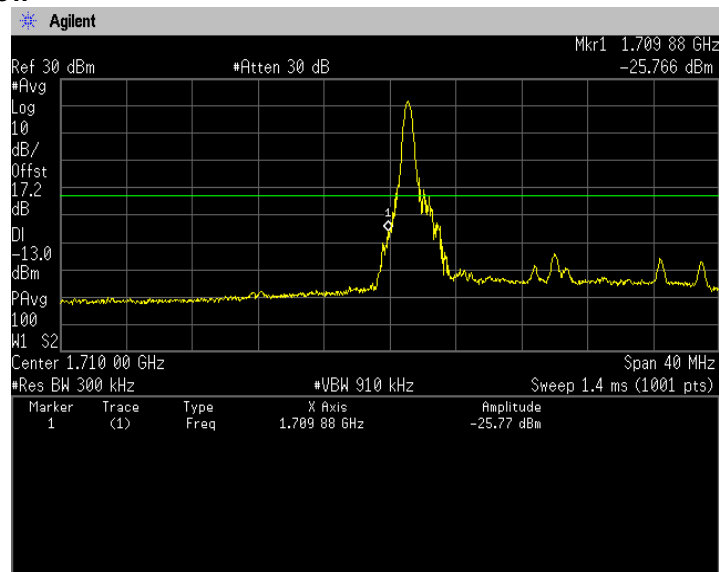

16QAM, BW 20MHz, RB1-99
Channel: High

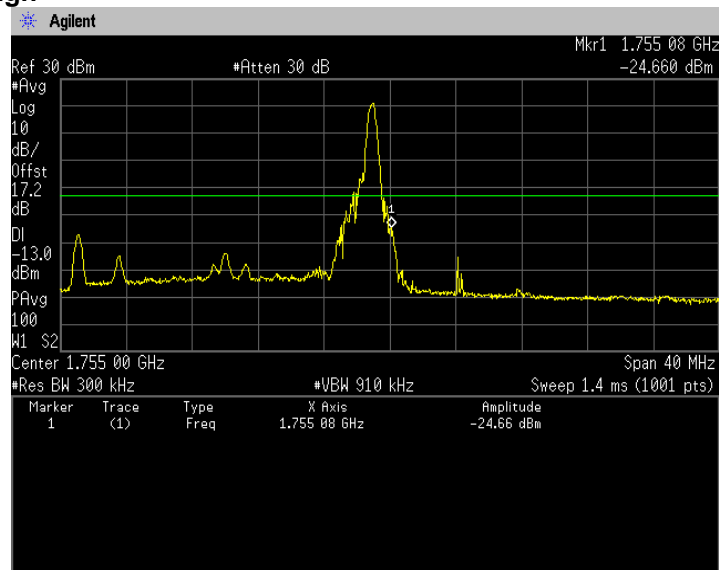



16QAM, BW 20MHz, RB100-0
Channel: Low

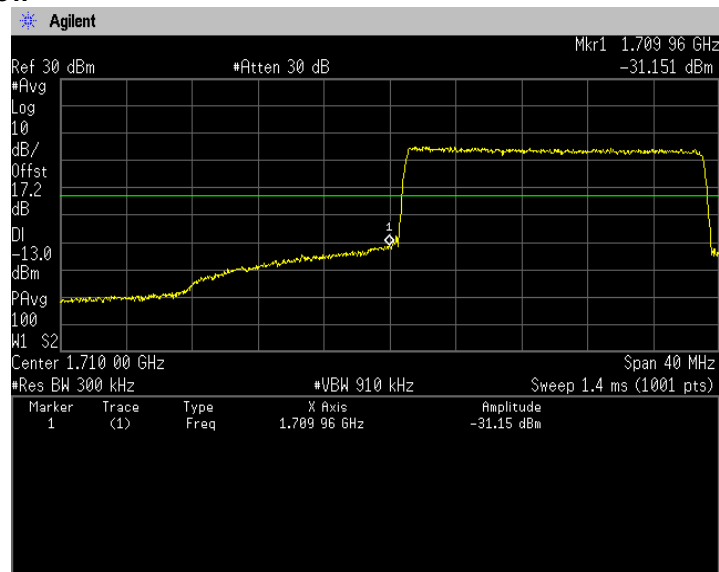

16QAM, BW 20MHz, RB100-0
Channel: High

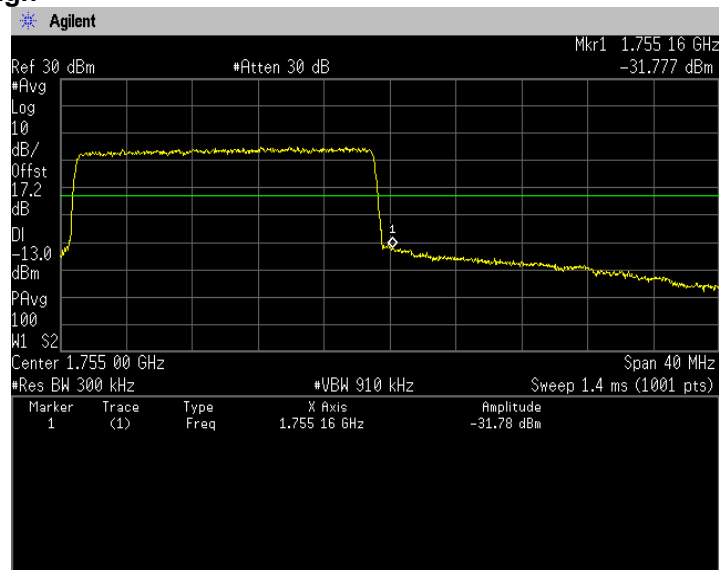



64QAM, BW 1.4MHz, RB1-0
Channel: Low

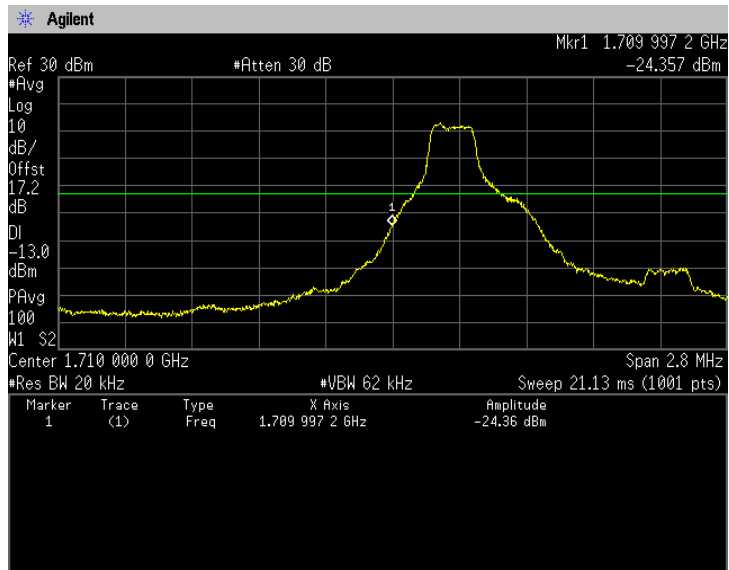

64QAM, BW 1.4MHz, RB1-5
Channel: High

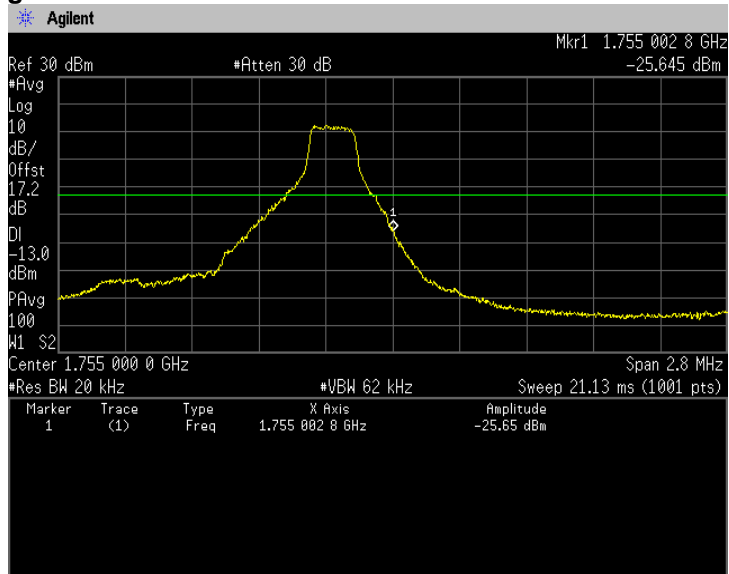



64QAM, BW 1.4MHz, RB6-0
Channel: Low

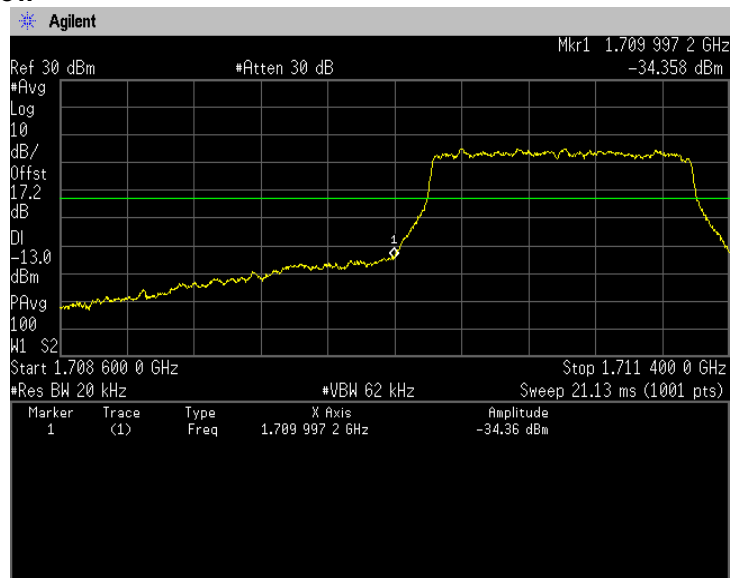

64QAM, BW 1.4MHz, RB6-0
Channel: High

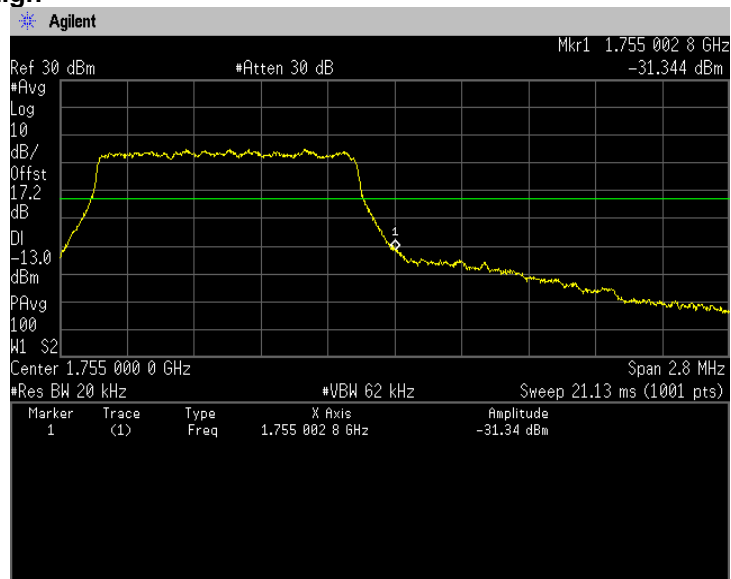



Japan

64QAM, BW 3MHz, RB1-0
Channel: Low

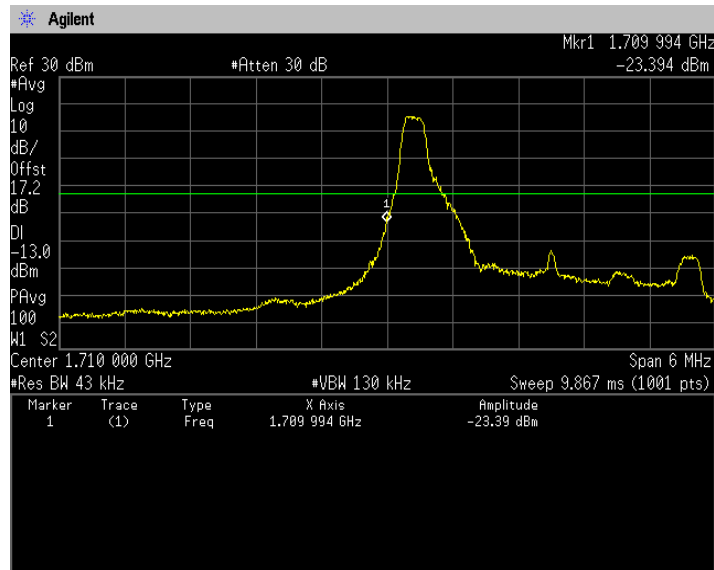

64QAM, BW 3MHz, RB1-14
Channel: High

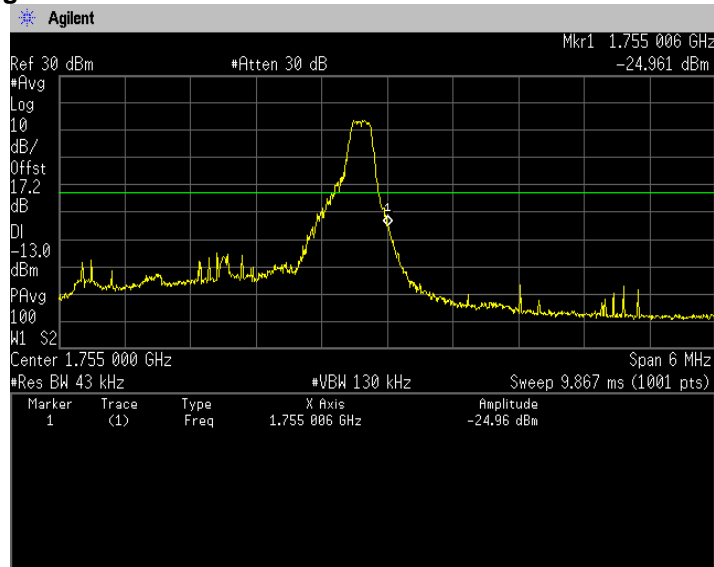



64QAM, BW 3MHz, RB15-0
Channel: Low

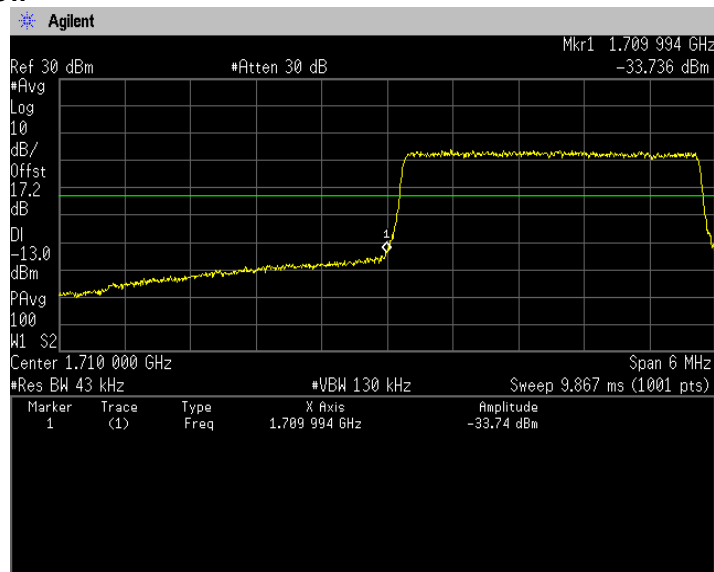

64QAM, BW 3MHz, RB15-0
Channel: High

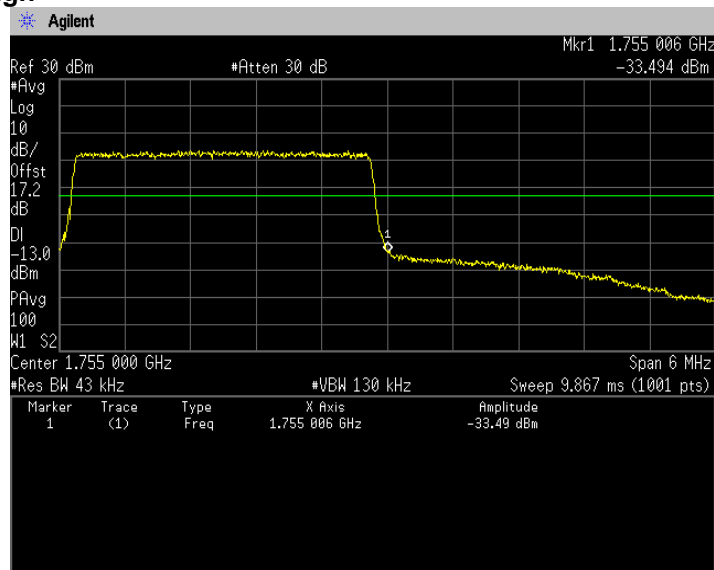



64QAM, BW 5MHz, RB1-0
Channel: Low

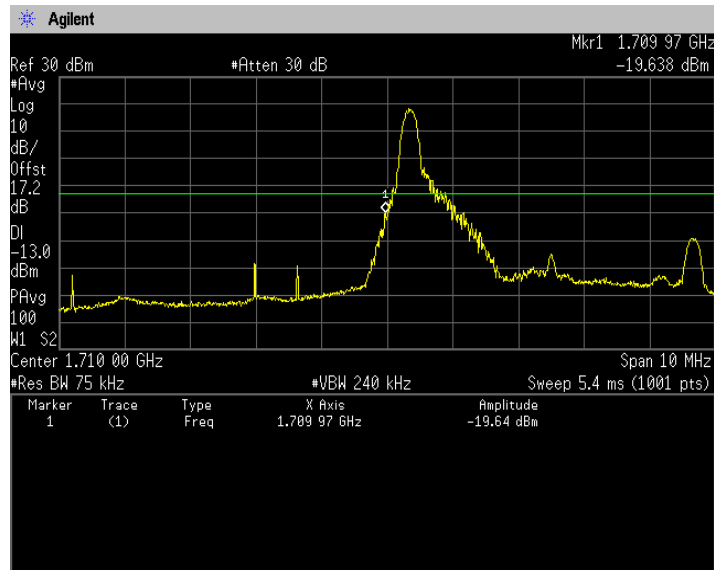

64QAM, BW 5MHz, RB1-24
Channel: High

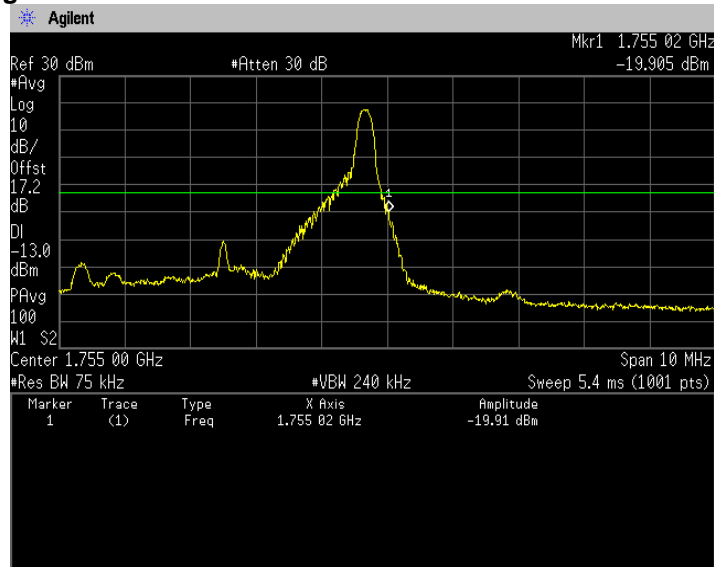



64QAM, BW 5MHz, RB25-0
Channel: Low

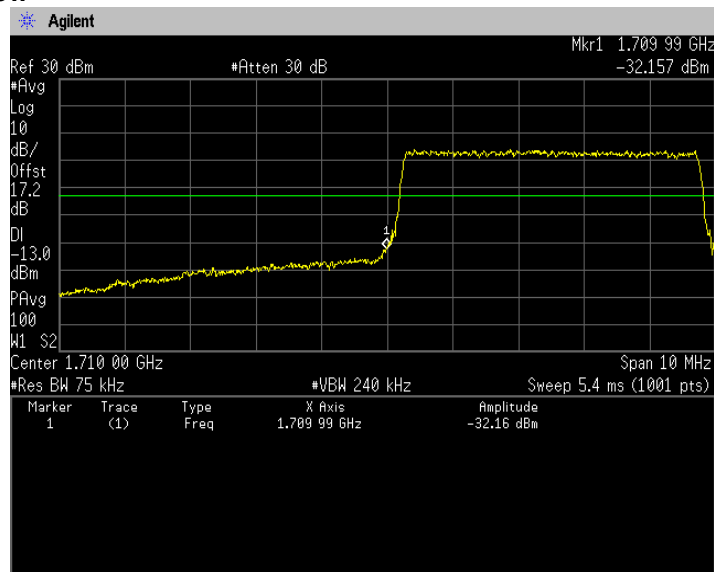

64QAM, BW 5MHz, RB25-0
Channel: High

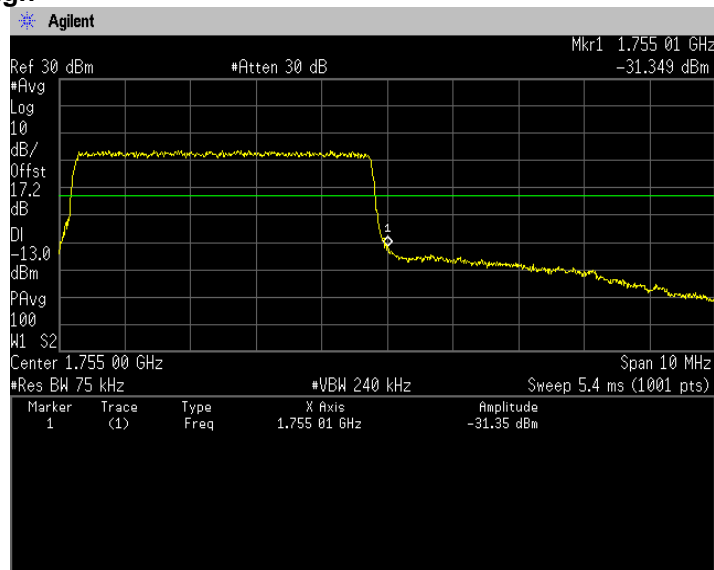



Japan

64QAM, BW 10MHz, RB1-0
Channel: Low

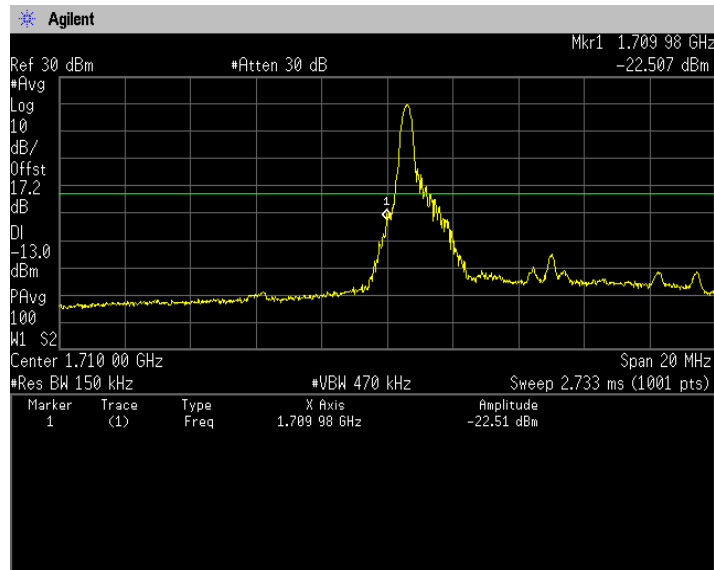

64QAM, BW 10MHz, RB1-49
Channel: High

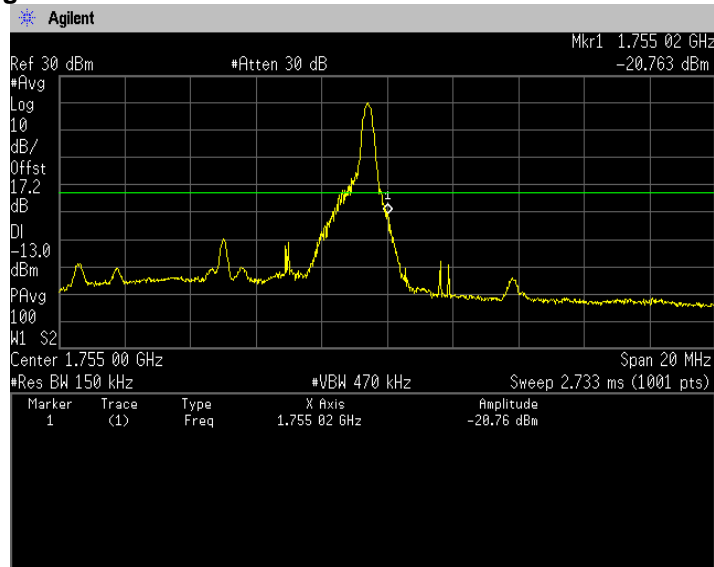



64QAM, BW 10MHz, RB50-0
Channel: Low

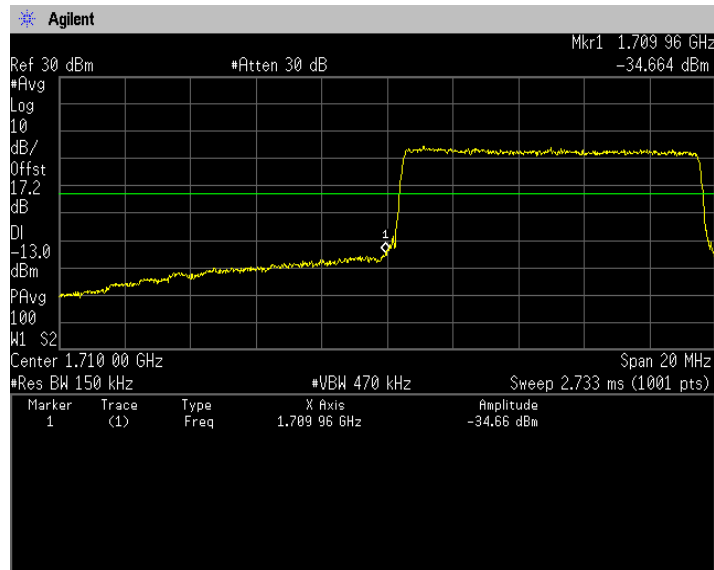

64QAM, BW 10MHz, RB50-0
Channel: High

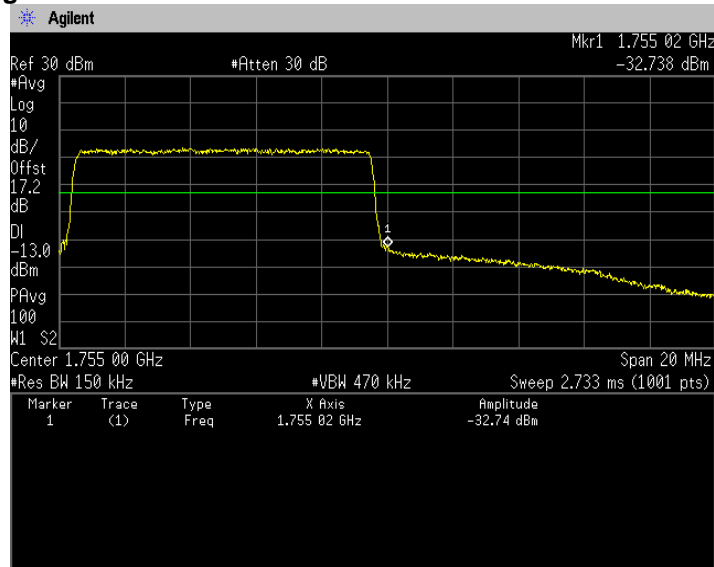



64QAM, BW 15MHz, RB1-0
Channel: Low

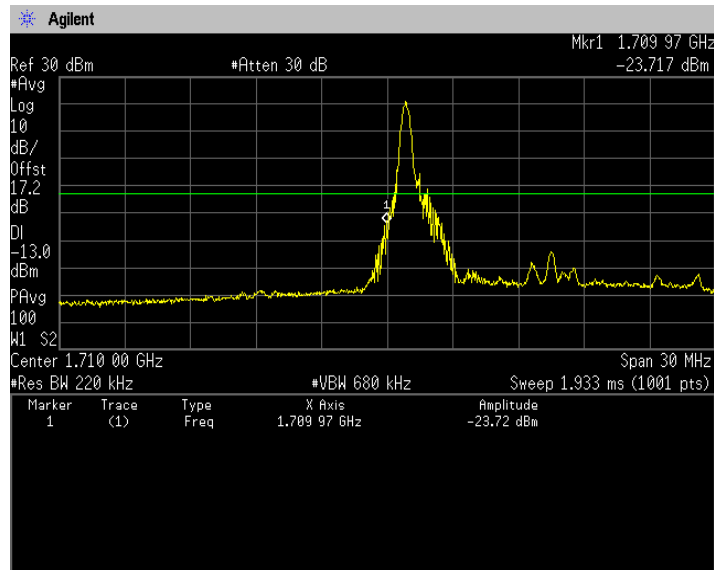

64QAM, BW 15MHz, RB1-74
Channel: High

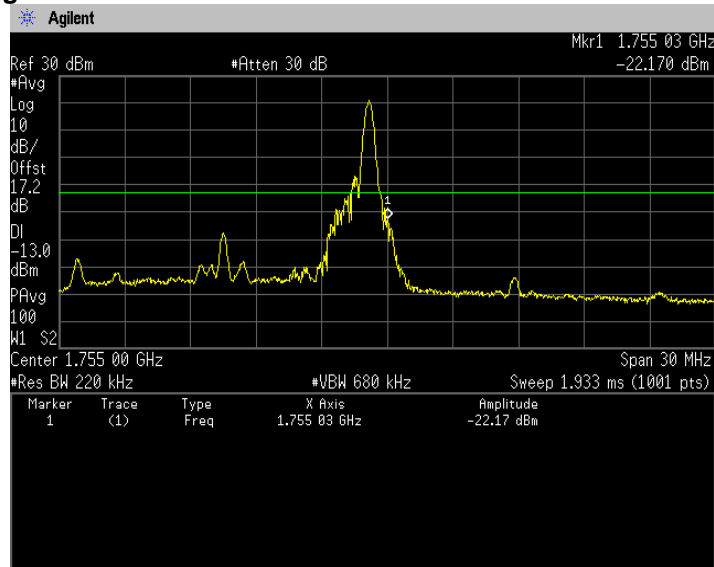



64QAM, BW 15MHz, RB75-0
Channel: Low

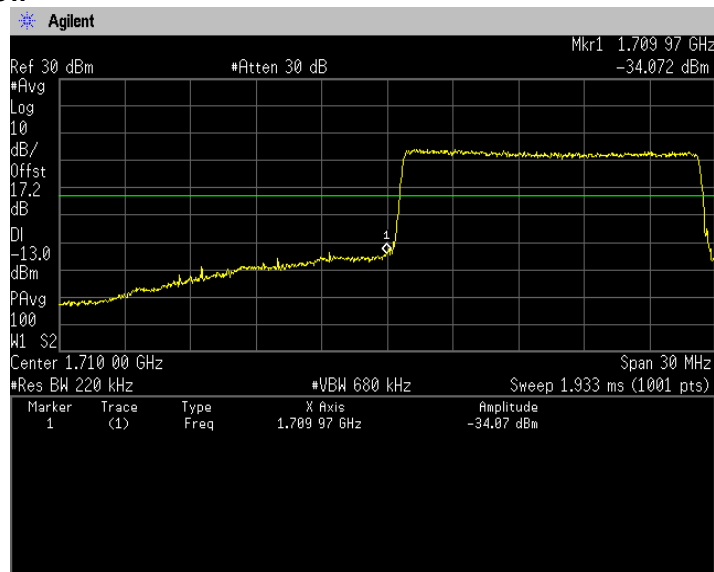

64QAM, BW 15MHz, RB75-0
Channel: High

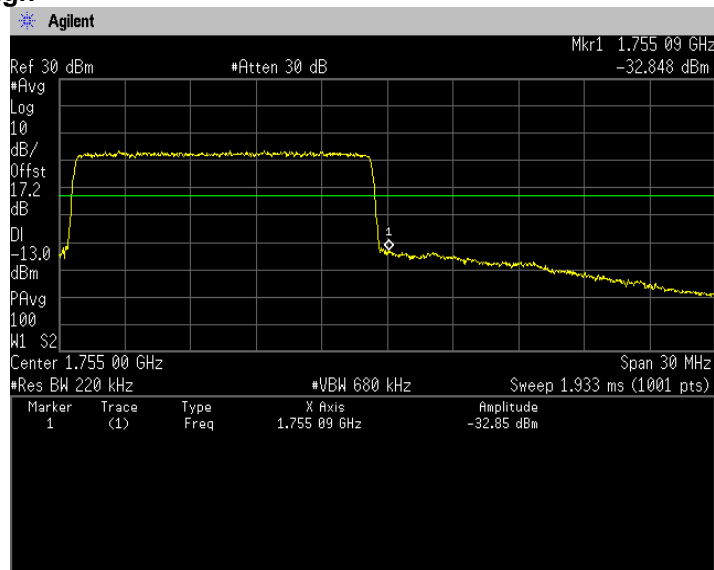



64QAM, BW 20MHz, RB1-0
Channel: Low

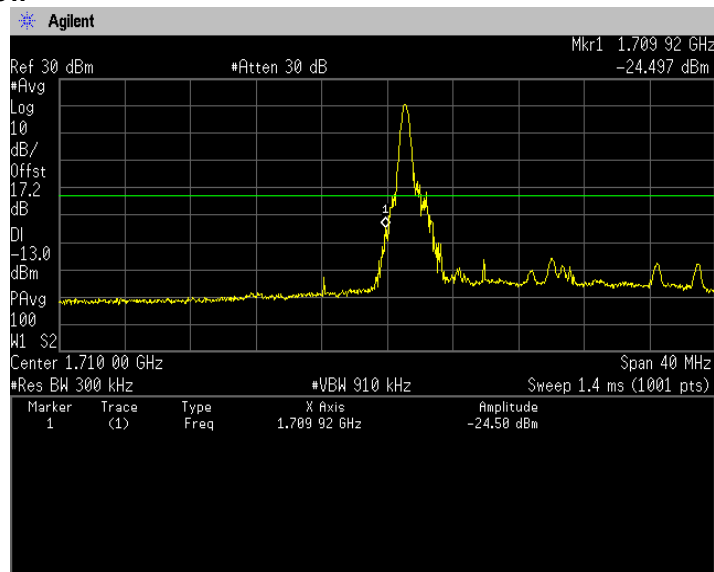

64QAM, BW 20MHz, RB1-99
Channel: High

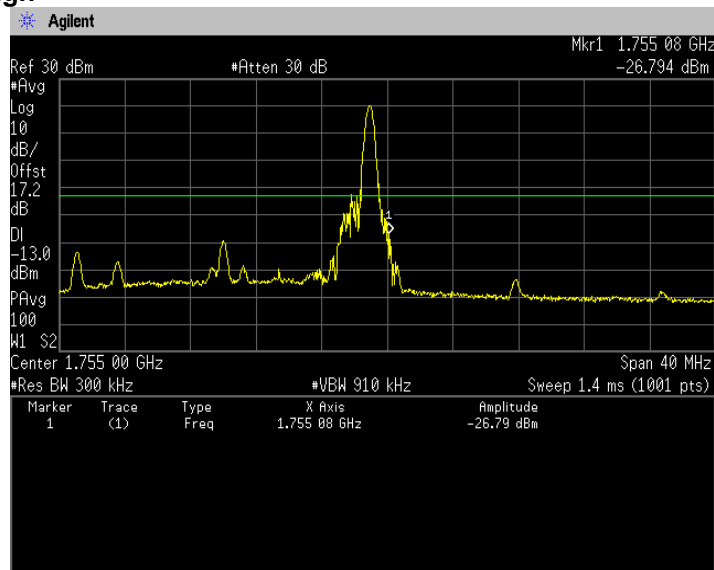



64QAM, BW 20MHz, RB100-0
Channel: Low

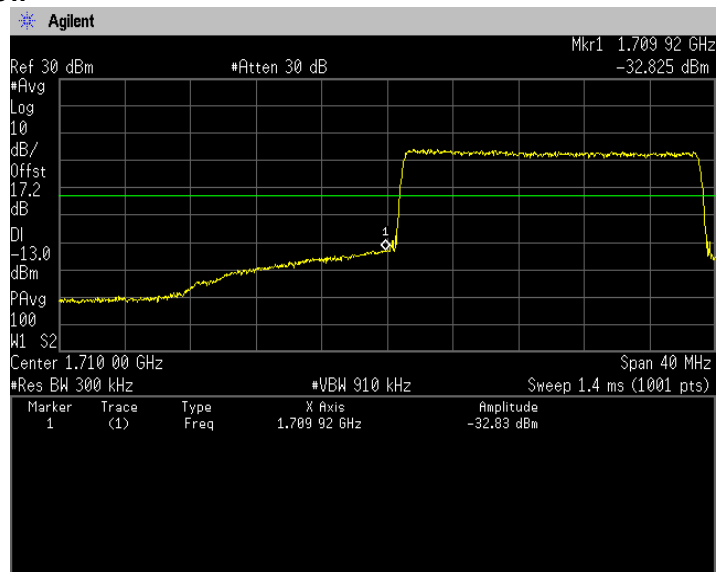

64QAM, BW 20MHz, RB100-0
Channel: High

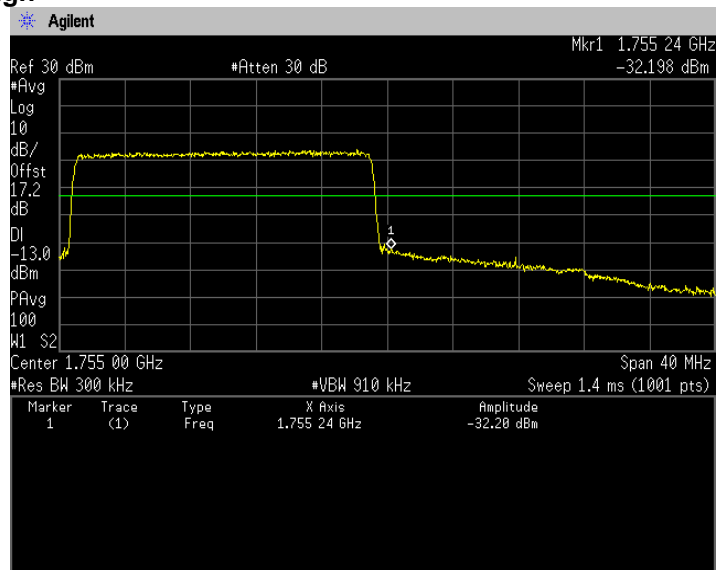

(Spurious Emissions)

Note: Conducted spurious test was measured in the worst case of Equivalent Isotropic Radiated power.

QPSK, BW 1.4MHz, RB 1-5

Channel: 19957

30MHz-5GHz

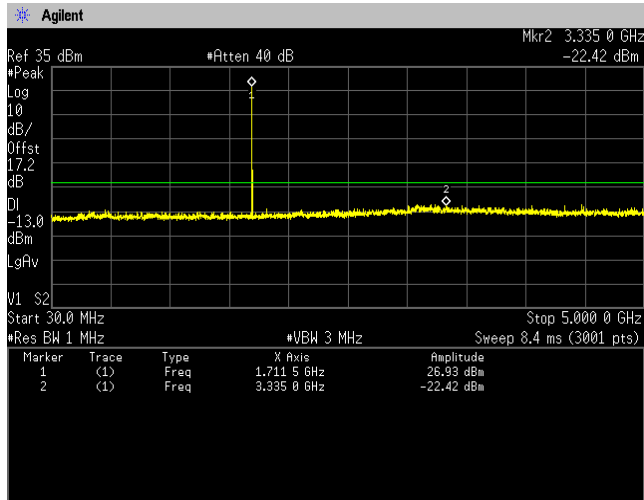

5GHz-10GHz

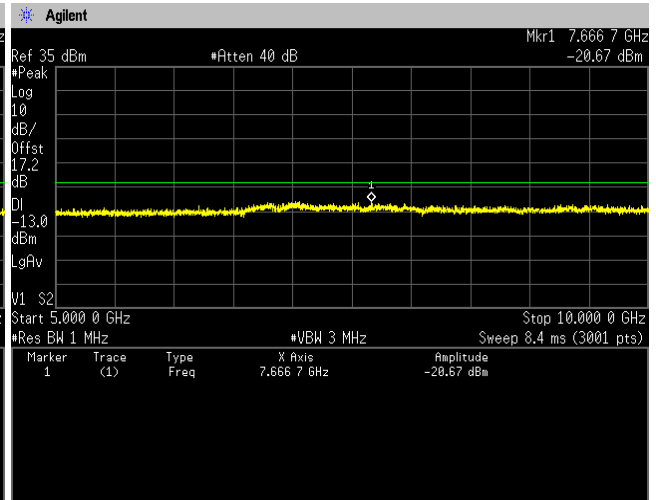

10GHz-15GHz

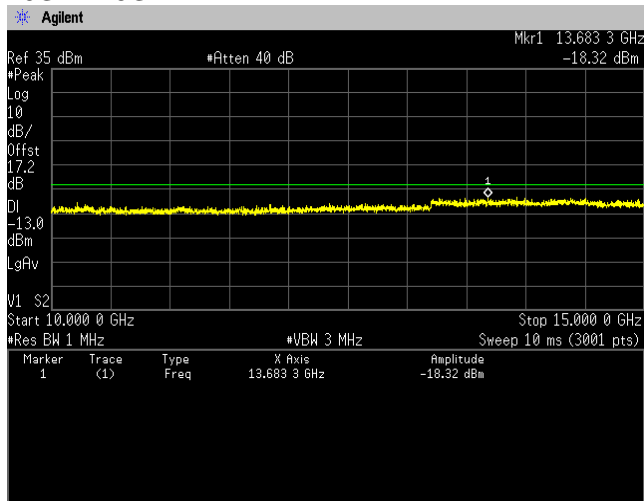

15GHz-20GHz

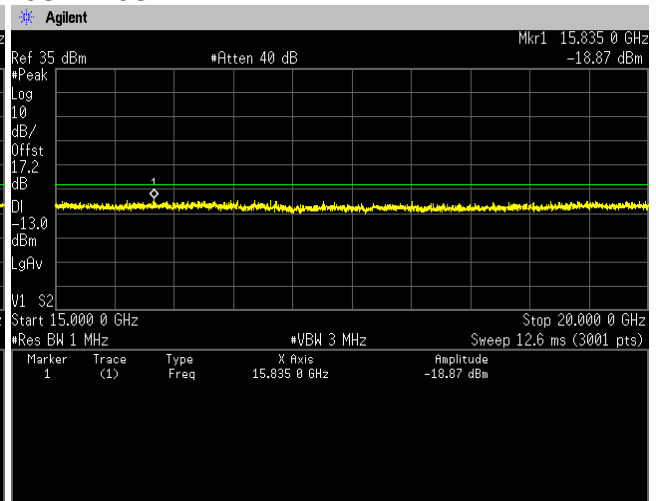



Channel: 20175
30MHz-5GHz

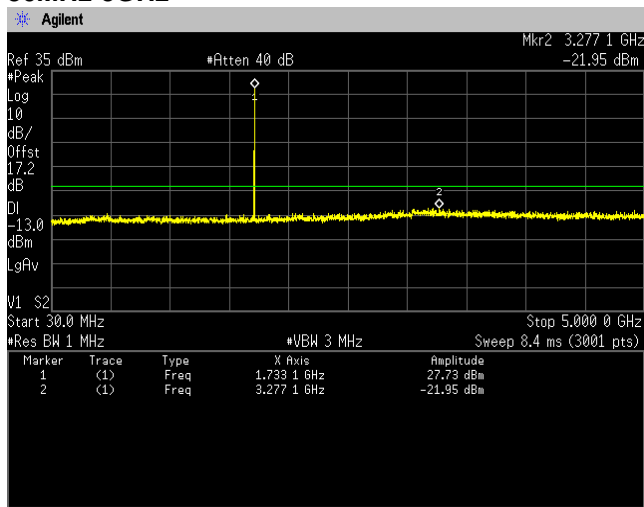

5GHz-10GHz

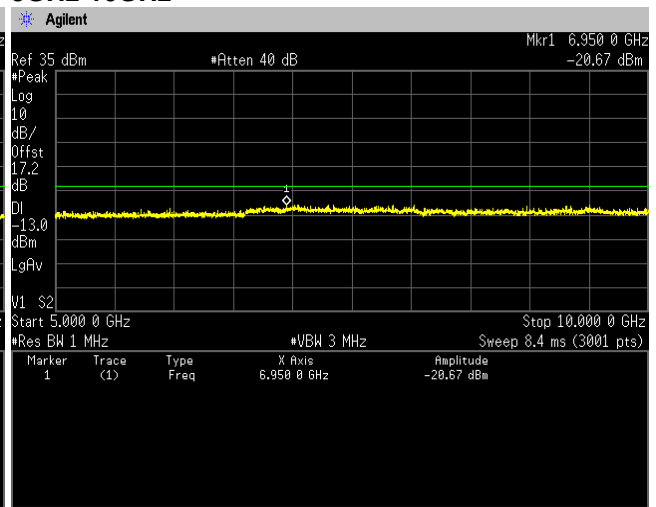

10GHz-15GHz

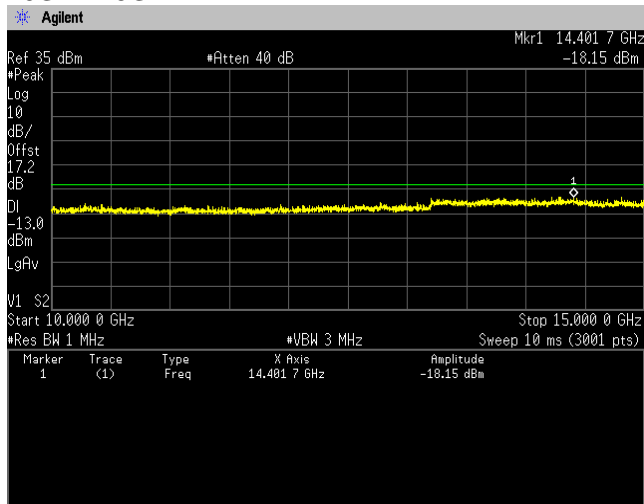

15GHz-20GHz

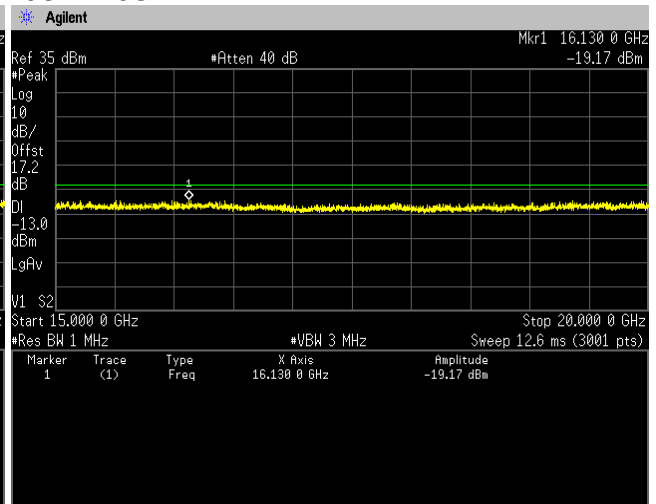



Channel: 20393
30MHz-5GHz

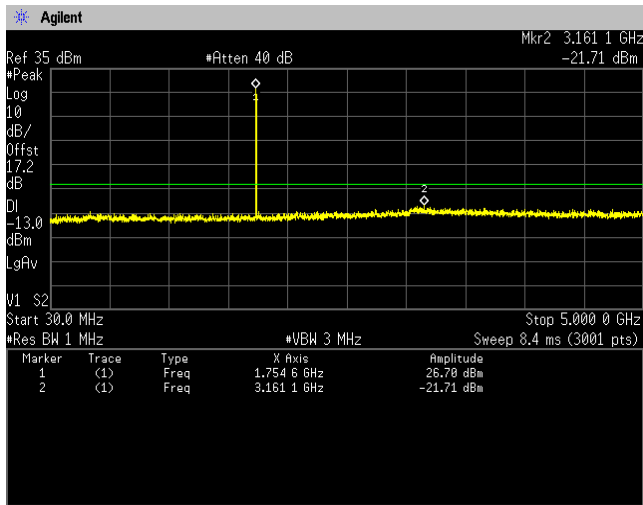

5GHz-10GHz

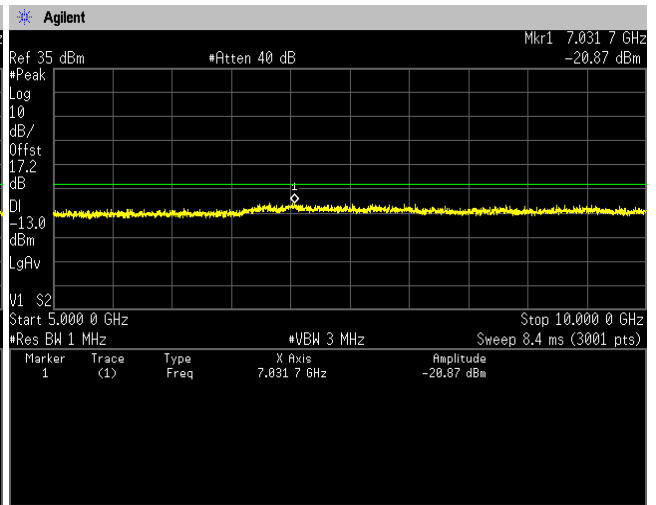

10GHz-15GHz

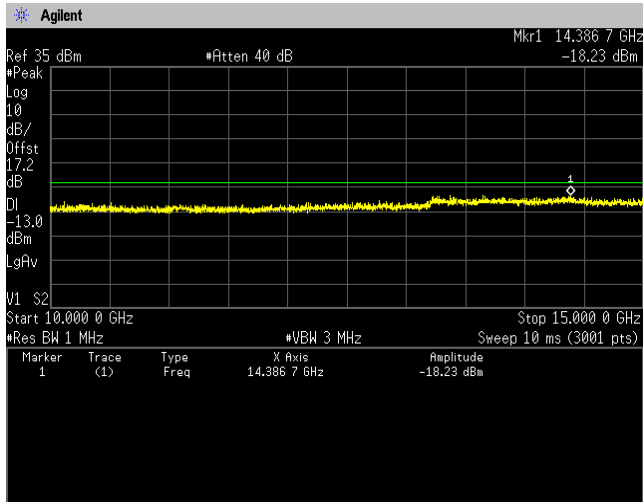

15GHz-20GHz

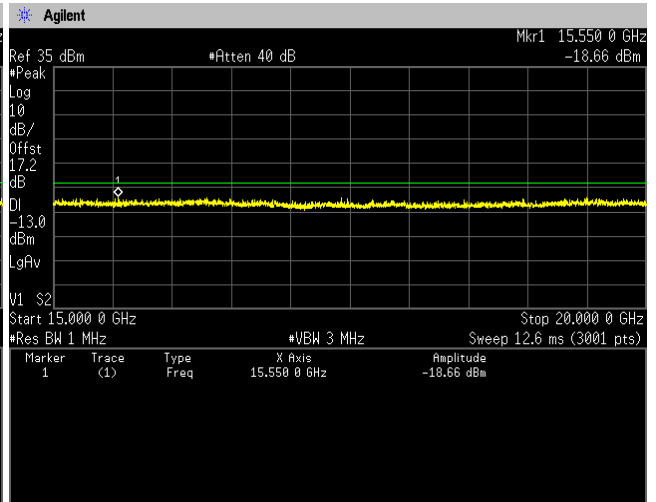

4.5 Radiated Emissions and Harmonic Emissions

4.5.1 Measurement procedure

[FCC 27.53, 2.1053]

<Step 1>

The EUT and support equipment are placed on 1.0 meter x 1.0 meter surface, 0.8 meter height (Below or equal 1GHz) or 0.6 meter x 0.6 meter surface, 1.5 meter height (Above 1GHz) styrene foam table. Radiated emission measurements are performed at 3 meter distance with the broadband antenna (Biconical antenna, Log periodic antenna and double ridged guide antenna). The antenna is positioned both the horizontal and vertical planes of polarization and height is varied 1 to 4 meters and stopped at height producing the maximum emission.

The bandwidth of the spectrum analyzer is set to 1 MHz. The turntable is rotated by 360 degrees and stopped at azimuth of producing the maximum emission. The frequency is investigated up to 20GHz.

<Step 2>

The substitution antenna is replaced by the transmitter antenna (EUT).

The frequency of the signal generator is adjusted to the measurement frequency.

Level of the signal generator is adjusted to the level that is obtained from step 1, and record the emission level of signal generator.

The spectrum analyzer is set to;

- RBW = 100 kHz for below 1GHz and 1MHz for above 1GHz / VBW \geq 3 x RBW
- Detector = Peak
- Trace mode = Max hold
- Sweep time = auto-couple

- Test configuration

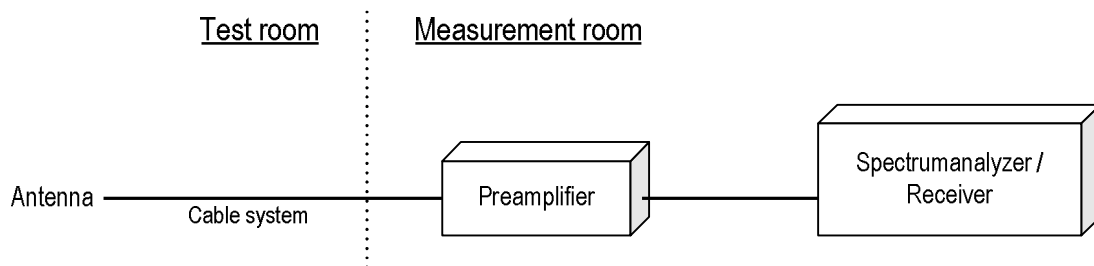



Japan

4.5.2 Calculation method

Result (EIRP) = Ant. Input - Cable loss + Antenna Gain
Margin = Limit – Result (EIRP)

Example:

Limit @ 1420 MHz : -13.0 dBm

Ant. Input = -55.6 dBm Cable loss = 1.0dB Ant. Gain = 5.9 dBi

Result = -55.6 - 1.0 + 5.9 = -50.7 dBm

Margin = -13.0 - (-50.7) = 37.7 dB

4.5.3 Limit

-13 dBm or less

4.5.4 Test data

Date	: 28~29-April-2022	Test engineer	:	Chiaki Kanno
Temperature	: 21.5 [°C]			
Humidity	: 27.1 [%]			
Test place	: 3m Semi-anechoic chamber			
Date	: 6-May-2022	Test engineer	:	Chiaki Kanno
Temperature	: 20.1 [°C]			
Humidity	: 33.0 [%]			
Test place	: 3m Semi-anechoic chamber			
Date	: 10~11-May-2022	Test engineer	:	Tadahiro Seino
Temperature	: 23.6 [°C]			
Humidity	: 20.9 [%]			
Test place	: 3m Semi-anechoic chamber			
Date	: 11~12-May-2022	Test engineer	:	Tadahiro Seino
Temperature	: 24.1 [°C]			
Humidity	: 28.1 [%]			
Test place	: 3m Semi-anechoic chamber			
Date	: 12~13-May-2022	Test engineer	:	Tadahiro Seino
Temperature	: 23.3 [°C]			
Humidity	: 46.6 [%]			
Test place	: 3m Semi-anechoic chamber			

[WCDMA Band IV - X-axis, Open, Without camera]**Channel: 1312**

H/V	Frequency [MHz]	S.A Reading [dBm]	Ant. Input [dBm]	Cable loss [dB]	Ant.Gain [dBi]	Result [dBm]	Limit [dBm]	Margin [dB]
H	3424.8	-54.5	-52.2	1.6	8.1	-45.7	-13.0	32.7

Channel: 1413

H/V	Frequency [MHz]	S.A Reading [dBm]	Ant. Input [dBm]	Cable loss [dB]	Ant.Gain [dBi]	Result [dBm]	Limit [dBm]	Margin [dB]
H	3465.2	-54.1	-51.8	1.6	8.3	-45.1	-13.0	32.1

Channel: 1513

H/V	Frequency [MHz]	S.A Reading [dBm]	Ant. Input [dBm]	Cable loss [dB]	Ant.Gain [dBi]	Result [dBm]	Limit [dBm]	Margin [dB]
H	3505.2	-54.5	-52.2	1.6	8.3	-45.5	-13.0	32.5

[LTE Band IV - Z-axis, Open, Without camera]**QPSK, BW 1.4MHz****Channel: 19957**

H/V	Frequency [MHz]	S.A Reading [dBm]	Ant. Input [dBm]	Cable loss [dB]	Ant.Gain [dBi]	Result [dBm]	Limit [dBm]	Margin [dB]
H	3421.4	-56.0	-57.0	1.6	8.1	-50.5	-13.0	37.5

Channel: 20175

H/V	Frequency [MHz]	S.A Reading [dBm]	Ant. Input [dBm]	Cable loss [dB]	Ant.Gain [dBi]	Result [dBm]	Limit [dBm]	Margin [dB]
H	3465.0	-55.8	-56.8	1.6	8.3	-50.1	-13.0	37.1

Channel: 20393

H/V	Frequency [MHz]	S.A Reading [dBm]	Ant. Input [dBm]	Cable loss [dB]	Ant.Gain [dBi]	Result [dBm]	Limit [dBm]	Margin [dB]
H	3508.6	-56.0	-57.0	1.6	8.2	-50.4	-13.0	37.4

16QAM, BW 1.4MHz**Channel: 19957**

H/V	Frequency [MHz]	S.A Reading [dBm]	Ant. Input [dBm]	Cable loss [dB]	Ant.Gain [dBi]	Result [dBm]	Limit [dBm]	Margin [dB]
H	3421.4	-56.1	-57.1	1.6	8.1	-50.6	-13.0	37.6

Channel: 20175

H/V	Frequency [MHz]	S.A Reading [dBm]	Ant. Input [dBm]	Cable loss [dB]	Ant.Gain [dBi]	Result [dBm]	Limit [dBm]	Margin [dB]
H	3465.0	-56.2	-57.2	1.6	8.3	-50.5	-13.0	37.5

Channel: 20393

H/V	Frequency [MHz]	S.A Reading [dBm]	Ant. Input [dBm]	Cable loss [dB]	Ant.Gain [dBi]	Result [dBm]	Limit [dBm]	Margin [dB]
H	3508.6	-56.1	-57.1	1.6	8.2	-50.5	-13.0	37.5

64QAM, BW 1.4MHz**Channel: 19957**

H/V	Frequency [MHz]	S.A Reading [dBm]	Ant. Input [dBm]	Cable loss [dB]	Ant.Gain [dBi]	Result [dBm]	Limit [dBm]	Margin [dB]
H	3421.4	-56.4	-57.4	1.6	8.1	-50.9	-13.0	37.9

Channel: 20175

H/V	Frequency [MHz]	S.A Reading [dBm]	Ant. Input [dBm]	Cable loss [dB]	Ant.Gain [dBi]	Result [dBm]	Limit [dBm]	Margin [dB]
H	3465.0	-56.3	-57.3	1.6	8.3	-50.6	-13.0	37.6

Channel: 20393

H/V	Frequency [MHz]	S.A Reading [dBm]	Ant. Input [dBm]	Cable loss [dB]	Ant.Gain [dBi]	Result [dBm]	Limit [dBm]	Margin [dB]
H	3508.6	-56.3	-57.3	1.6	8.2	-50.7	-13.0	37.7

[LTE Band IV - Z-axis, Open, Without camera]**QPSK, BW 3MHz****Channel: 19965**

H/V	Frequency [MHz]	S.A Reading [dBm]	Ant. Input [dBm]	Cable loss [dB]	Ant.Gain [dBi]	Result [dBm]	Limit [dBm]	Margin [dB]
H	3423.0	-55.8	-56.8	1.6	8.1	-50.3	-13.0	37.3

Channel: 20175

H/V	Frequency [MHz]	S.A Reading [dBm]	Ant. Input [dBm]	Cable loss [dB]	Ant.Gain [dBi]	Result [dBm]	Limit [dBm]	Margin [dB]
H	3465.0	-56.2	-57.2	1.6	8.3	-50.5	-13.0	37.5

Channel: 20385

H/V	Frequency [MHz]	S.A Reading [dBm]	Ant. Input [dBm]	Cable loss [dB]	Ant.Gain [dBi]	Result [dBm]	Limit [dBm]	Margin [dB]
H	3507.0	-56.1	-56.9	1.6	8.2	-50.3	-13.0	37.3

16QAM, BW 3MHz**Channel: 19965**

H/V	Frequency [MHz]	S.A Reading [dBm]	Ant. Input [dBm]	Cable loss [dB]	Ant.Gain [dBi]	Result [dBm]	Limit [dBm]	Margin [dB]
H	3423.0	-55.9	-56.9	1.6	8.1	-50.4	-13.0	37.4

Channel: 20175

H/V	Frequency [MHz]	S.A Reading [dBm]	Ant. Input [dBm]	Cable loss [dB]	Ant.Gain [dBi]	Result [dBm]	Limit [dBm]	Margin [dB]
H	3465.0	-56.2	-57.2	1.6	8.3	-50.5	-13.0	37.5

Channel: 20385

H/V	Frequency [MHz]	S.A Reading [dBm]	Ant. Input [dBm]	Cable loss [dB]	Ant.Gain [dBi]	Result [dBm]	Limit [dBm]	Margin [dB]
H	3507.0	-56.1	-56.9	1.6	8.2	-50.3	-13.0	37.3

64QAM, BW 3MHz**Channel: 19965**

H/V	Frequency [MHz]	S.A Reading [dBm]	Ant. Input [dBm]	Cable loss [dB]	Ant.Gain [dBi]	Result [dBm]	Limit [dBm]	Margin [dB]
H	3423.0	-56.0	-57.0	1.6	8.1	-50.5	-13.0	37.5

Channel: 20175

H/V	Frequency [MHz]	S.A Reading [dBm]	Ant. Input [dBm]	Cable loss [dB]	Ant.Gain [dBi]	Result [dBm]	Limit [dBm]	Margin [dB]
H	3465.0	-56.3	-57.3	1.6	8.3	-50.6	-13.0	37.6

Channel: 20385

H/V	Frequency [MHz]	S.A Reading [dBm]	Ant. Input [dBm]	Cable loss [dB]	Ant.Gain [dBi]	Result [dBm]	Limit [dBm]	Margin [dB]
H	3507.0	-56.2	-57.2	1.6	8.2	-50.6	-13.0	37.6

[LTE Band IV - Z-axis, Open, Without camera]**QPSK, BW 5MHz****Channel: 19975**

H/V	Frequency [MHz]	S.A Reading [dBm]	Ant. Input [dBm]	Cable loss [dB]	Ant.Gain [dBi]	Result [dBm]	Limit [dBm]	Margin [dB]
H	3425.0	-55.6	-56.6	1.6	8.1	-50.1	-13.0	37.1

Channel: 20175

H/V	Frequency [MHz]	S.A Reading [dBm]	Ant. Input [dBm]	Cable loss [dB]	Ant.Gain [dBi]	Result [dBm]	Limit [dBm]	Margin [dB]
H	3465.0	-55.5	-56.5	1.6	8.3	-49.8	-13.0	36.8

Channel: 20375

H/V	Frequency [MHz]	S.A Reading [dBm]	Ant. Input [dBm]	Cable loss [dB]	Ant.Gain [dBi]	Result [dBm]	Limit [dBm]	Margin [dB]
H	3505.0	-56.0	-57.0	1.6	8.3	-50.3	-13.0	37.3

16QAM, BW 5MHz**Channel: 19975**

H/V	Frequency [MHz]	S.A Reading [dBm]	Ant. Input [dBm]	Cable loss [dB]	Ant.Gain [dBi]	Result [dBm]	Limit [dBm]	Margin [dB]
H	3425.0	-55.7	-56.7	1.6	8.1	-50.2	-13.0	37.2

Channel: 20175

H/V	Frequency [MHz]	S.A Reading [dBm]	Ant. Input [dBm]	Cable loss [dB]	Ant.Gain [dBi]	Result [dBm]	Limit [dBm]	Margin [dB]
H	3465.0	-56.0	-57.0	1.6	8.3	-50.3	-13.0	37.3

Channel: 20375

H/V	Frequency [MHz]	S.A Reading [dBm]	Ant. Input [dBm]	Cable loss [dB]	Ant.Gain [dBi]	Result [dBm]	Limit [dBm]	Margin [dB]
H	3505.0	-56.4	-57.4	1.6	8.3	-50.7	-13.0	37.7

64QAM, BW 5MHz**Channel: 19975**

H/V	Frequency [MHz]	S.A Reading [dBm]	Ant. Input [dBm]	Cable loss [dB]	Ant.Gain [dBi]	Result [dBm]	Limit [dBm]	Margin [dB]
H	3425.0	-56.2	-57.2	1.6	8.1	-50.7	-13.0	37.7

Channel: 20175

H/V	Frequency [MHz]	S.A Reading [dBm]	Ant. Input [dBm]	Cable loss [dB]	Ant.Gain [dBi]	Result [dBm]	Limit [dBm]	Margin [dB]
H	3465.0	-56.5	-57.5	1.6	8.3	-50.8	-13.0	37.8

Channel: 20375

H/V	Frequency [MHz]	S.A Reading [dBm]	Ant. Input [dBm]	Cable loss [dB]	Ant.Gain [dBi]	Result [dBm]	Limit [dBm]	Margin [dB]
H	3505.0	-56.4	-57.4	1.6	8.3	-50.7	-13.0	37.7

[LTE Band IV - Z-axis, Open, Without camera]**QPSK, BW 10MHz****Channel: 20000**

H/V	Frequency [MHz]	S.A Reading [dBm]	Ant. Input [dBm]	Cable loss [dB]	Ant.Gain [dBi]	Result [dBm]	Limit [dBm]	Margin [dB]
H	3430.0	-56.1	-57.1	1.6	8.2	-50.5	-13.0	37.5

Channel: 20175

H/V	Frequency [MHz]	S.A Reading [dBm]	Ant. Input [dBm]	Cable loss [dB]	Ant.Gain [dBi]	Result [dBm]	Limit [dBm]	Margin [dB]
H	3465.0	-56.2	-57.2	1.6	8.3	-50.5	-13.0	37.5

Channel: 20350

H/V	Frequency [MHz]	S.A Reading [dBm]	Ant. Input [dBm]	Cable loss [dB]	Ant.Gain [dBi]	Result [dBm]	Limit [dBm]	Margin [dB]
H	3500.0	-56.0	-57.0	1.6	8.3	-50.3	-13.0	37.3

16QAM, BW 10MHz**Channel: 20000**

H/V	Frequency [MHz]	S.A Reading [dBm]	Ant. Input [dBm]	Cable loss [dB]	Ant.Gain [dBi]	Result [dBm]	Limit [dBm]	Margin [dB]
H	3430.0	-56.2	-57.2	1.6	8.2	-50.6	-13.0	37.6

Channel: 20175

H/V	Frequency [MHz]	S.A Reading [dBm]	Ant. Input [dBm]	Cable loss [dB]	Ant.Gain [dBi]	Result [dBm]	Limit [dBm]	Margin [dB]
H	3465.0	-56.3	-57.3	1.6	8.3	-50.6	-13.0	37.6

Channel: 20350

H/V	Frequency [MHz]	S.A Reading [dBm]	Ant. Input [dBm]	Cable loss [dB]	Ant.Gain [dBi]	Result [dBm]	Limit [dBm]	Margin [dB]
H	3500.0	-56.1	-57.1	1.6	8.3	-50.4	-13.0	37.4

64QAM, BW 10MHz**Channel: 20000**

H/V	Frequency [MHz]	S.A Reading [dBm]	Ant. Input [dBm]	Cable loss [dB]	Ant.Gain [dBi]	Result [dBm]	Limit [dBm]	Margin [dB]
H	3430.0	-56.5	-57.5	1.6	8.2	-50.9	-13.0	37.9

Channel: 20175

H/V	Frequency [MHz]	S.A Reading [dBm]	Ant. Input [dBm]	Cable loss [dB]	Ant.Gain [dBi]	Result [dBm]	Limit [dBm]	Margin [dB]
H	3465.0	-56.4	-57.4	1.6	8.3	-50.7	-13.0	37.7

Channel: 20350

H/V	Frequency [MHz]	S.A Reading [dBm]	Ant. Input [dBm]	Cable loss [dB]	Ant.Gain [dBi]	Result [dBm]	Limit [dBm]	Margin [dB]
H	3500.0	-56.4	-57.4	1.6	8.3	-50.7	-13.0	37.7

[LTE Band IV - Z-axis, Open, Without camera]**QPSK, BW 15MHz****Channel: 20025**

H/V	Frequency [MHz]	S.A Reading [dBm]	Ant. Input [dBm]	Cable loss [dB]	Ant.Gain [dBi]	Result [dBm]	Limit [dBm]	Margin [dB]
H	3435.0	-55.7	-56.7	1.6	8.2	-50.1	-13.0	37.1

Channel: 20175

H/V	Frequency [MHz]	S.A Reading [dBm]	Ant. Input [dBm]	Cable loss [dB]	Ant.Gain [dBi]	Result [dBm]	Limit [dBm]	Margin [dB]
H	3465.0	-56.0	-57.0	1.6	8.3	-50.3	-13.0	37.3

Channel: 20325

H/V	Frequency [MHz]	S.A Reading [dBm]	Ant. Input [dBm]	Cable loss [dB]	Ant.Gain [dBi]	Result [dBm]	Limit [dBm]	Margin [dB]
H	3495.0	-55.9	-56.9	1.6	8.3	-50.2	-13.0	37.2

16QAM, BW 15MHz**Channel: 20025**

H/V	Frequency [MHz]	S.A Reading [dBm]	Ant. Input [dBm]	Cable loss [dB]	Ant.Gain [dBi]	Result [dBm]	Limit [dBm]	Margin [dB]
H	3435.0	-55.8	-56.8	1.6	8.2	-50.2	-13.0	37.2

Channel: 20175

H/V	Frequency [MHz]	S.A Reading [dBm]	Ant. Input [dBm]	Cable loss [dB]	Ant.Gain [dBi]	Result [dBm]	Limit [dBm]	Margin [dB]
H	3465.0	-56.1	-56.9	1.6	8.3	-50.2	-13.0	37.2

Channel: 20325

H/V	Frequency [MHz]	S.A Reading [dBm]	Ant. Input [dBm]	Cable loss [dB]	Ant.Gain [dBi]	Result [dBm]	Limit [dBm]	Margin [dB]
H	3495.0	-56.1	-56.9	1.6	8.3	-50.2	-13.0	37.2

64QAM, BW 15MHz**Channel: 20025**

H/V	Frequency [MHz]	S.A Reading [dBm]	Ant. Input [dBm]	Cable loss [dB]	Ant.Gain [dBi]	Result [dBm]	Limit [dBm]	Margin [dB]
H	3435.0	-56.0	-57.0	1.6	8.2	-50.4	-13.0	37.4

Channel: 20175

H/V	Frequency [MHz]	S.A Reading [dBm]	Ant. Input [dBm]	Cable loss [dB]	Ant.Gain [dBi]	Result [dBm]	Limit [dBm]	Margin [dB]
H	3465.0	-56.3	-56.7	1.6	8.3	-50.0	-13.0	37.0

Channel: 20325

H/V	Frequency [MHz]	S.A Reading [dBm]	Ant. Input [dBm]	Cable loss [dB]	Ant.Gain [dBi]	Result [dBm]	Limit [dBm]	Margin [dB]
H	3495.0	-56.5	-56.5	1.6	8.3	-49.8	-13.0	36.8

[LTE Band IV - Z-axis, Open, Without camera]**QPSK, BW 20MHz****Channel: 20050**

H/V	Frequency [MHz]	S.A Reading [dBm]	Ant. Input [dBm]	Cable loss [dB]	Ant.Gain [dBi]	Result [dBm]	Limit [dBm]	Margin [dB]
H	3440.0	-55.5	-56.5	1.6	8.3	-49.8	-13.0	36.8

Channel: 20175

H/V	Frequency [MHz]	S.A Reading [dBm]	Ant. Input [dBm]	Cable loss [dB]	Ant.Gain [dBi]	Result [dBm]	Limit [dBm]	Margin [dB]
H	3465.0	-56.4	-57.4	1.6	8.3	-50.7	-13.0	37.7

Channel: 20300

H/V	Frequency [MHz]	S.A Reading [dBm]	Ant. Input [dBm]	Cable loss [dB]	Ant.Gain [dBi]	Result [dBm]	Limit [dBm]	Margin [dB]
H	3490.0	-55.3	-56.3	1.6	8.3	-49.6	-13.0	36.6

16QAM, BW 20MHz**Channel: 20050**

H/V	Frequency [MHz]	S.A Reading [dBm]	Ant. Input [dBm]	Cable loss [dB]	Ant.Gain [dBi]	Result [dBm]	Limit [dBm]	Margin [dB]
H	3440.0	-55.6	-56.6	1.6	10.5	-47.7	-13.0	34.7

Channel: 20175

H/V	Frequency [MHz]	S.A Reading [dBm]	Ant. Input [dBm]	Cable loss [dB]	Ant.Gain [dBi]	Result [dBm]	Limit [dBm]	Margin [dB]
H	3465.0	-56.5	-57.5	1.6	10.5	-48.6	-13.0	35.6

Channel: 20300

H/V	Frequency [MHz]	S.A Reading [dBm]	Ant. Input [dBm]	Cable loss [dB]	Ant.Gain [dBi]	Result [dBm]	Limit [dBm]	Margin [dB]
H	3490.0	-55.4	-56.4	1.6	10.5	-47.5	-13.0	34.5

64QAM, BW 20MHz**Channel: 20050**

H/V	Frequency [MHz]	S.A Reading [dBm]	Ant. Input [dBm]	Cable loss [dB]	Ant.Gain [dBi]	Result [dBm]	Limit [dBm]	Margin [dB]
H	3440.0	-55.9	-56.9	1.6	10.5	-48.0	-13.0	35.0

Channel: 20175

H/V	Frequency [MHz]	S.A Reading [dBm]	Ant. Input [dBm]	Cable loss [dB]	Ant.Gain [dBi]	Result [dBm]	Limit [dBm]	Margin [dB]
H	3465.0	-56.6	-57.6	1.6	10.5	-48.7	-13.0	35.7

Channel: 20300

H/V	Frequency [MHz]	S.A Reading [dBm]	Ant. Input [dBm]	Cable loss [dB]	Ant.Gain [dBi]	Result [dBm]	Limit [dBm]	Margin [dB]
H	3490.0	-55.8	-56.8	1.6	10.5	-47.9	-13.0	34.9

4.6 Frequency Stability

4.6.1 Measurement procedure

[FCC 27.54, 2.1055]

The EUT was placed of an inside of an constant temperature chamber as the temperature in the chamber was varied between -30°C and +50°C. The temperature was incremented by 10°C intervals and the unit was allowed to stabilize at each measurement. The frequency drift was measured with the normal Temperature and voltage tolerance and it is presented as the ppm unit.

- Test configuration

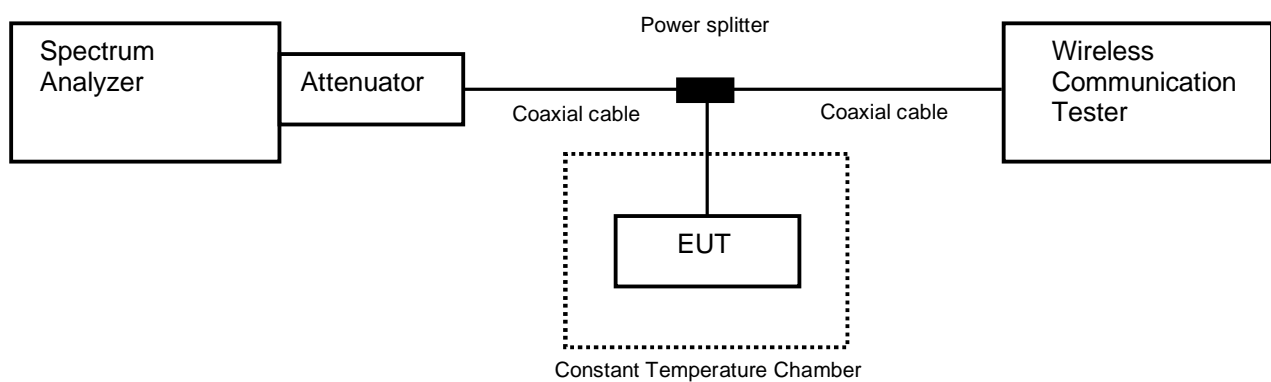

4.6.2 Limit

The frequency stability shall be sufficient to ensure that the fundamental emissions stay within the authorized bands of operation.

4.6.3 Measurement result

Date : 6-May-2022
 Temperature : 24.2 [°C]
 Humidity : 34.9 [%]
 Test place : Shielded room No.4

Test engineer : Tadahiro Seino

**[WCDMA Band IV]
Channel: 1413**

Power Supply [V]	Temperature [°C]	Measurements Frequency [Hz]	Frequency Tolerance [ppm]	Result
3.80	25(Ref.)	1,732,599,974	0.00000	Pass
	50	1,732,599,980	0.00350	Pass
	40	1,732,599,979	0.00302	Pass
	30	1,732,599,978	0.00195	Pass
	20	1,732,599,979	0.00256	Pass
	10	1,732,599,981	0.00421	Pass
	0	1,732,599,987	0.00724	Pass
	-10	1,732,599,980	0.00339	Pass
	-20	1,732,600,011	0.02112	Pass
	-30	1,732,600,013	0.02247	Pass
3.42	25	1,732,599,976	0.00128	Pass
4.18	25	1,732,599,983	0.00534	Pass

Calculation;

Frequency Tolerance (ppm) = Measurements Frequency (Hz) – Reference Frequency (Hz) / Reference Frequency (Hz) x 1000000

**[LTE Band IV]
QPSK, BW 10MHz, RB 50-0
Channel: 20175**

Power Supply [V]	Temperature [°C]	Measurements Frequency [Hz]	Frequency Tolerance [ppm]	Result
3.80	25(Ref.)	1,732,499,991	0.00000	Pass
	50	1,732,499,984	-0.00412	Pass
	40	1,732,499,982	-0.00526	Pass
	30	1,732,499,980	-0.00616	Pass
	20	1,732,499,988	-0.00167	Pass
	10	1,732,499,987	-0.00222	Pass
	0	1,732,499,982	-0.00503	Pass
	-10	1,732,499,980	-0.00614	Pass
	-20	1,732,499,978	-0.00769	Pass
	-30	1,732,500,021	0.01735	Pass
3.42	25	1,732,499,989	-0.00100	Pass
4.18	25	1,732,499,990	-0.00073	Pass



Calculation;

Frequency Tolerance (ppm) = Measurements Frequency (Hz) – Reference Frequency (Hz) / Reference Frequency (Hz) x 1000000

5 Measurement Uncertainty

Expanded uncertainties stated are calculated with a coverage Factor k=2.
 Please note that these results are not taken into account when measurement uncertainty considerations contained in ETSI TR 100 028 Parts 1 and 2 determining compliance or non-compliance with test result.

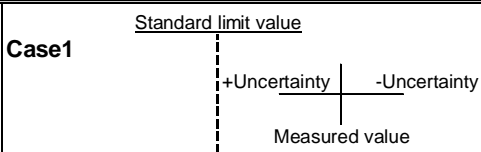
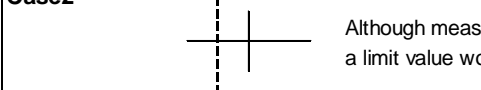
Test item	Measurement uncertainty
Conducted emission, AMN (9 kHz – 150 kHz)	±3.7 dB
Conducted emission, AMN (150 kHz – 30 MHz)	±3.3 dB
Radiated emission (9kHz – 30 MHz)	±3.2 dB
Radiated emission (30 MHz – 1000 MHz)	±5.5 dB
Radiated emission (1 GHz – 6 GHz)	±4.8 dB
Radiated emission (6 GHz – 18 GHz)	±4.4 dB
Radiated emission (18 GHz – 40 GHz)	±6.4 dB
Radio Frequency	±1.3 * 10 ⁻⁸
RF power, conducted	±0.7 dB
Adjacent channel power	±1.5 dB
Temperature	±0.6 °C
Humidity	±1.2 %
Voltage (DC)	±0.4 %
Voltage (AC, <10kHz)	±0.2 %

Judge	Measured value and standard limit value	
PASS	 <p>Standard limit value</p> <p>+Uncertainty -Uncertainty</p> <p>Measured value</p>	Even if it takes uncertainty into consideration, a standard limit value is fulfilled.
		Although measured value is in a standard limit value, a limit value won't be fulfilled if uncertainty is taken into consideration.
FAIL		Although measured value exceeds a standard limit value, a limit value will be fulfilled if uncertainty is taken into consideration.
		Even if it takes uncertainty into consideration, a standard limit value isn't fulfilled.



Japan

6 Laboratory Information

Testing was performed and the report was issued at:

TÜV SÜD Japan Ltd. Yonezawa Testing Center

Address: 5-4149-7 Hachimanpara, Yonezawa-shi, Yamagata, 992-1128 Japan

Phone: +81-238-28-2881

Accreditation and Registration

A2LA

Certificate #3686.03

VLAC

Accreditation No.: VLAC-013

BSMI

Laboratory Code: SL2-IN-E-6018, SL2-A1-E-6018

Innovation, Science and Economic Development Canada

ISED#: 4224A

VCCI Council

Registration number: A-0166

Appendix A. Test Equipment

Antenna port conducted test

Equipment	Company	Model No.	Serial No.	Cal. Due	Cal. Date
Spectrum analyzer	Agilent Technologies	E4440A	US44302655	30-Sep-2022	01-Sep-2021
Spectrum analyzer	ROHDE&SCHWARZ	FSV40	101731	30-Jun-2022	08-Jun-2021
Attenuator	HUBER+SUHNER	6810.19.A	N/A(S450)	31-Dec-2022	21-Dec-2021
Microwave cable	Junkosha Inc.	MWX221/1m	N/A(S400)	31-Mar-2023	02-Mar-2022
Power divider	Keysight	11636B	MY51360915	30-Sep-2022	15-Sep-2021
Wideband Radio Frequency Tester	ROHDE&SCHWARZ	CMW500	116338	31-Aug-2022	04-Aug-2021
Temperature and humidity chamber	ESPEC	PL1KP	14007261	30-Sep-2022	21-Sep-2021

Radiated emission

Equipment	Company	Model No.	Serial No.	Cal. Due	Cal. Date
EMI Receiver	ROHDE&SCHWARZ	ESCI	100765	30-Sep-2022	15-Sep-2021
Spectrum analyzer	Agilent Technologies	E4440A	US40420937	31-Dec-2022	13-Dec-2021
Preamplifier	SONOMA	310	372170	30-Sep-2022	15-Sep-2021
Biconical antenna	Schwarzbeck	VHBB9124/BBA9106	1333	31-Dec-2022	15-Dec-2021
Log periodic antenna	Schwarzbeck	VUSLP9111B	346	31-Oct-2022	15-Oct-2021
Attenuator	TOYO Connector	NA-PJ-6/6dB	N/A(S541)	30-Sep-2022	16-Sep-2021
Attenuator	TAMAGAWA.ELEC	CFA-10/3dB	N/A(S503)	31-Jul-2022	20-Jul-2021
Preamplifier	TSJ	MLA-100M18-B02-40	1929118	31-Dec-2022	22-Dec-2021
Attenuator	AEROFLEX	26A-10	081217-08	31-Dec-2022	22-Dec-2021
Double ridged guide antenna	ETS LINDGREN	3117	00052315	31-May-2022	24-May-2021
Attenuator	HUBER+SUHNER	6803.17.B	N/A(2340)	31-Dec-2022	23-Dec-2021
Double ridged guide antenna	A.H.Systems Inc.	SAS-574	469	31-Aug-2022	02-Aug-2021
Preamplifier	TSJ	MLA-1840-B03-35	1240332	31-Aug-2022	02-Aug-2021
Notch Filter	Micro-Tronics	BRC50719	014	31-Dec-2022	20-Dec-2021
Signal generator	ROHDE&SCHWARZ	SMB100A	177525	31-Dec-2022	08-Dec-2021
RF power amplifier	R&K	CGA020M602-2633R	B40240	30-Jun-2022	02-Jun-2021
Attenuator	HUBER+SUHNER	6820.19.A	N/A(2399)	30-Sep-2022	15-Sep-2021
Microwave cable	HUBER+SUHNER	SUCOFLEX102/2m	31648	31-Mar-2023	02-Mar-2022
Dipole antenna	Schwarzbeck	VHAP	1021	31-Jul-2022	28-Jul-2021
Dipole antenna	Schwarzbeck	UHAP	993	31-Jul-2022	28-Jul-2021
Double ridged guide antenna	ETS LINDGREN	3117	00218815	31-Dec-2022	06-Dec-2021
Wideband Radio Frequency Tester	ROHDE&SCHWARZ	CMW500	126079	30-Nov-2022	15-Nov-2021
Wideband Radio Frequency Tester	ROHDE&SCHWARZ	CMW500	116338	31-Aug-2022	04-Aug-2021
Microwave cable	HUBER+SUHNER	SUCOFLEX104/9m	MY30037/4	31-Dec-2022	22-Dec-2021
		SUCOFLEX104/1m	my24610/4	31-Dec-2022	22-Dec-2021
		SUCOFLEX104/8m	SN MY30033/4	31-Dec-2022	22-Dec-2021
		SUCOFLEX104/1m	MY32976/4	31-Dec-2022	22-Dec-2021
		SUCOFLEX104/2m	SN MY28404/4	31-Dec-2022	22-Dec-2021
		SUCOFLEX104/7m	41625/6	31-Dec-2022	22-Dec-2021
PC	DELL	DIMENSION E521	75465BX	N/A	N/A
Software	TOYO Corporation	EP5/RE-AJ	0611193/V6.0.140	N/A	N/A
Absorber	RIKEN	PFP30	N/A	N/A	N/A
3m Semi an-echoic Chamber	TOKIN	N/A	N/A(9002-NSA)	31-May-2022	20-May-2021
3m Semi an-echoic Chamber	TOKIN	N/A	N/A(9002-SVSWR)	31-May-2022	20-May-2021

*: The calibrations of the above equipment are traceable to NIST or equivalent standards of the reference organizations.