

Report on the RF Testing of:

KYOCERA Corporation
Mobile Phone, Model: EB1134
FCC ID: JOYEB1134

In accordance with FCC Part 24 Subpart E

Prepared for: KYOCERA Corporation
Yokohama Office 2-1-1 Kagahara, Tsuzuki-ku
Yokohama-shi, Kanagawa, Japan
Phone: +81-45-943-6253 Fax: +81-45-943-6314



Japan

**Add value.
Inspire trust.**

COMMERCIAL-IN-CONFIDENCE

Document Number: JPD-TR-22091-0

SIGNATURE

NAME	JOB TITLE	RESPONSIBLE FOR	ISSUE DATE
Hiroaki Suzuki	Deputy Manager of RF Group	Approved Signatory	2022.05.24

Signatures in this approval box have checked this document in line with the requirements of TÜV SÜD Japan Ltd. document control rules.

EXECUTIVE SUMMARY - Result: Complied

A sample(s) of this product was tested and the result above was confirmed in accordance with FCC Part 24 Subpart E.



DISCLAIMER AND COPYRIGHT

The results in this report are applicable only to the equipment tested.
This report shall not be re-produced except in full without the written approval of TÜV SÜD Japan Ltd.
Client provided data, for which TÜV SÜD Japan Ltd. take no responsibility, which can affect validity of results within this report is clearly identified.

ACCREDITATION

This test report must not be used by the client to claim product certification, approval, or endorsement by A2LA or any agency of the U.S. Government.

TÜV SÜD Japan Ltd.
Yonezawa Testing Center
5-4149-7 Hachimanpara,
Yonezawa-shi, Yamagata,
992-1128 Japan

Phone: +81 (0) 238 28 2881
www.tuvsud.com/ja-jp



Contents

1	Summary of Test	3
1.1	Modification history of the test report.....	3
1.2	Standards.....	3
1.3	Test methods.....	3
1.4	Deviation from standards.....	3
1.5	List of applied test(s) of the EUT.....	3
1.6	Test information.....	3
1.7	Test set up.....	3
1.8	Test period.....	3
2	Equipment Under Test	4
2.1	EUT information.....	4
2.2	Modification to the EUT.....	6
2.3	Variation of family model(s).....	6
2.4	Description of test mode.....	6
3	Configuration of Equipment	7
3.1	Equipment used.....	7
3.2	System configuration.....	7
4	Test Result	8
4.1	Equivalent Isotropic Radiated Power.....	8
4.2	Peak to Average Ratio.....	14
4.3	Occupied Bandwidth.....	24
4.4	Band Edge Spurious and Harmonic at Antenna Terminals.....	34
4.5	Radiated Emissions and Harmonic Emissions.....	84
4.6	Frequency Stability.....	93
5	Measurement Uncertainty	96
6	Laboratory Information	97
	Appendix A. Test Equipment	98

1 Summary of Test

1.1 Modification history of the test report

Document Number	Modification History	Issue Date
JPD-TR-22091-0	First Issue	Refer to the cover page

1.2 Standards

CFR47 FCC Part 24 Subpart E

1.3 Test methods

KDB 971168 D01 Power Meas License Digital Systems v03r01
ANSI/TIA/EIA 603-E-2016
ANSI C63.26-2015

1.4 Deviation from standards

None

1.5 List of applied test(s) of the EUT

Test item section	Test item	Condition	Result	Remark
2.1046	Conducted Output Power	Conducted	PASS	*1
24.232(c)	Equivalent Isotropic Radiated Power	Radiated	PASS	-
24.232(d)	Peak to Average Ratio	Conducted	PASS	-
24.238(a) 2.1049	Occupied Bandwidth	Conducted	PASS	-
24.238(a) 2.1051	Band Edge Spurious and Harmonic at Antenna Terminal	Conducted	PASS	-
24.238(a) 2.1053	Radiated emissions and Harmonic Emissions	Radiated	PASS	-
24.235 2.1055	Frequency Stability	Conducted	PASS	-

*1: Refer to RF Exposure Report (Test Report_SAR)

1.6 Test information

None

1.7 Test set up

Table-top

1.8 Test period

8-April-2022 - 11-May-2022

2 Equipment Under Test

All information in this chapter was provided by the applicant.

2.1 EUT information

Applicant	KYOCERA Corporation Yokohama Office 2-1-1 Kagahara, Tsuzuki-ku Yokohama-shi, Kanagawa, Japan Phone: +81-45-943-6253 Fax: +81-45-943-6314
Equipment Under Test (EUT)	Mobile Phone
Model number	EB1134
Serial number	358079740016730, 355161850001265, 358079740017217
Trade name	Kyocera
Number of sample(s)	3
EUT condition	Pre-Production
Power rating	Battery: DC 3.8 V
Size	(W) 112.9 mm × (D) 51.3 mm × (H) 18.0 mm
Environment	Indoor and Outdoor use
Terminal limitation	-20 °C to 60 °C
Hardware version	DMT1
Software version	0.021AL.0013.a
Firmware version	Not applicable
RF Specification	
Frequency of Operation	Up Link GSM1900: 1850.2-1909.8 MHz WCDMA Band II: 1852.4-1907.6MHz LTE Band II: 1850.0-1910.0MHz Down Link GSM1900: 1930.2-1989.8 MHz WCDMA Band II: 1932.4-1987.6MHz LTE Band II: 1930.0-1990.0MHz
Modulation type	GSM1900: GMSK WCDMA Band II: QPSK, 16QAM LTE Band II: QPSK, 16QAM, 64QAM
Emission designator	GSM1900: 245KGXW WCDMA Band II: 4M17F9W LTE Band II: BW 1.4M QPSK: 1M10G7D, 16QAM: 1M10W7D, 64QAM: 1M08W7D BW 3M QPSK: 2M70G7D, 16QAM: 2M69W7D, 64QAM: 2M71W7D BW 5M QPSK: 4M51G7D, 16QAM: 4M49W7D, 64QAM: 4M50W7D BW 10M QPSK: 8M99G7D, 16QAM: 9M00W7D, 64QAM: 8M97W7D BW 15M QPSK: 13M5G7D, 16QAM: 13M5W7D, 64QAM: 13M4W7D BW 20M QPSK: 18M0G7D, 16QAM: 18M0W7D, 64QAM: 18M0W7D



Japan

Equivalent Isotropic Radiated Power (E.I.R.P)	GSM1900: 1.9055 W (32.8dBm) WCDMA Band II: 0.5495W (27.4dBm) LTE Band II: 0.5248W (27.2dBm)
Antenna type	Internal antenna
Antenna gain	GSM1900: 0.94 dBi WCDMA Band II: 0.94 dBi LTE Band II: 0.94 dBi

2.2 Modification to the EUT

The table below details modifications made to the EUT during the test project.

Modification State	Description of Modification	Modification fitted by	Date of Modification
Model: EB1134, Serial Number: 358079740016730, 355161850001265, 358079740017217			
0	As supplied by the applicant	Not Applicable	Not Applicable

2.3 Variation of family model(s)

2.3.1 List of family model(s)

EB1134 has model with camera and without camera.

2.3.2 Reason for selection of EUT

Not applicable

2.4 Description of test mode

The EUT had been tested under operating condition.
There are three channels have been tested as following:

Band	Modulation	Bandwidth [MHz]	Channel	Frequency [MHz]
GSM1900	GMSK	-	512, 661, 810	1850.2, 1880.0, 1909.8
WCDMA Band II	QPSK	-	9262, 9400, 9538	1852.4, 1880.0, 1907.6
	16QAM	-	9262, 9400, 9538	1852.4, 1880.0, 1907.6
LTE Band II	QPSK, 16QAM, 64QAM	1.4	18607, 18900, 19193	1850.7, 1880.0, 1909.3
		3	18615, 18900, 19185	1851.5, 1880.0, 1908.5
		5	18625, 18900, 19175	1852.5, 1880.0, 1907.5
		10	18650, 18900, 19150	1855.0, 1880.0, 1905.0
		15	18675, 18900, 19125	1857.5, 1880.0, 1902.5
		20	18700, 18900, 19100	1860.0, 1880.0, 1900.0

The field strength of spurious emissions was measured at each position of all three axis X, Y and Z to compare the level, and the maximum noise.

The worst emission was found in X-axis, Open, Without camera (All Bands) and the worst case recorded.

Pre-scan has been conducted to determine the worst-case mode from all possible combinations between available modulations, data rates and antenna ports.

3 Configuration of Equipment

Numbers assigned to equipment on the diagram in “3.2 System configuration” correspond to the list in “3.1 Equipment used”.

This test configuration is based on the manufacture’s instruction.

Cabling and setup(s) were taken into consideration and test data was taken under worse case condition.

3.1 Equipment used

No.	Equipment	Company	Model No.	Serial No.	FCC ID/DoC	Comment
1	Mobile Phone	KYOCERA	EB1134	358079740016730, 355161850001265, 358079740017217	JOYEB1134	EUT

3.2 System configuration

1. Mobile Phone (EUT)

4 Test Result

4.1 Equivalent Isotropic Radiated Power

4.1.1 Measurement procedure

[FCC 24.232(c)]

<Step 1>

The EUT and support equipment are placed on 0.6 meter x 0.6 meter surface, 1.5 meter height (Above 1GHz) styrene foam table. Radiated emission measurements are performed at 3 meter distance with the broadband antenna (double ridged guide antenna). The antenna is positioned both the horizontal and vertical planes of polarization and height is varied 1 to 4 meters and stopped at height producing the maximum emission.

The bandwidth of the spectrum analyzer is set to 1 MHz. The turntable is rotated by 360 degrees and stopped at azimuth of producing the maximum emission.

<Step 2>

The substitution antenna is replaced by the transmitter antenna (EUT).

The frequency of the signal generator is adjusted to the measurement frequency.

Level of the signal generator is adjusted to the level that is obtained from step 1, and record the emission level of signal generator.

The spectrum analyzer is set to;

- a) Span = 1.5 times the OBW
- b) RBW = 1-5% of the expected OBW, not to exceed 1 MHz
- c) VBW $\geq 3 \times$ RBW
- d) Number of sweep points $\geq 2 \times$ span / RBW
- e) Sweep time = auto-couple
- f) Detector = RMS (power averaging)
- g) If the EUT can be configured to transmit continuously (i.e., burst duty cycle $\geq 98\%$), then set the trigger to free run.
- h) If the EUT cannot be configured to transmit continuously (i.e., burst duty cycle $< 98\%$), then use a sweep trigger with the level set to enable triggering only on full power bursts and configure the EUT to transmit at full power for the entire duration of each sweep. Ensure that the sweep time is less than or equal to the transmission burst duration.
- i) Trace average at least 100 traces in power averaging (i.e., RMS) mode.
- j) Compute the power by integrating the spectrum across the OBW of the signal using the instrument's band power measurement function, with the band limits set equal to the OBW band edges. If the instrument does not have a band power function, then sum the spectrum levels (in linear power units) at intervals equal to the RBW extending across the entire OBW of the spectrum.

- Test configuration

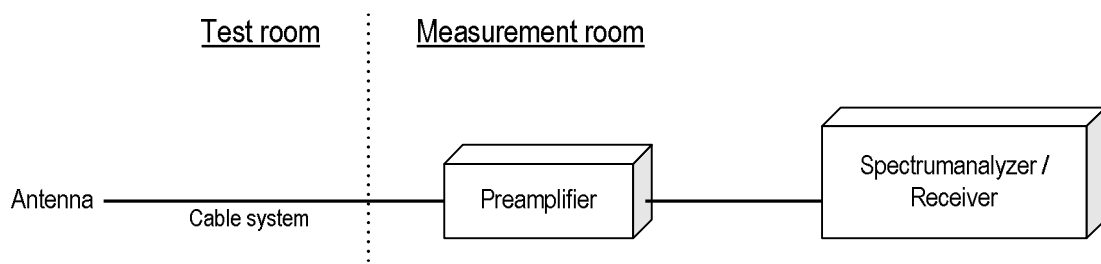



Japan

4.1.2 Calculation method

Result (EIRP) = Ant. Input - Cable loss + Antenna Gain
Margin = Limit - Result (EIRP)

Example:

Limit @ 1880 MHz : 33.0 dBm
Ant. Input = 25.0 dBm Cable loss = 1.1dB Ant. Gain = 4.7 dBi
Result = 25.0 - 1.1 + 4.7 = 28.6 dBm
Margin = 33.0 - 28.6 = 4.4 dB

4.1.3 Limit

2 W (33 dBm)

4.1.4 Test data

Date	: 8~9-April-2022	Test engineer	:	<u>Tadahiro Seino</u>
Temperature	: 21.3 [°C]			
Humidity	: 39.3 [%]			
Test place	: 3m Semi-anechoic chamber			
Date	: 11-April-2022	Test engineer	:	<u>Chiaki Kanno</u>
Temperature	: 21.6 [°C]			
Humidity	: 28.2 [%]			
Test place	: 3m Semi-anechoic chamber			
Date	: 11~12-April-2022	Test engineer	:	<u>Tadahiro Seino</u>
Temperature	: 22.1 [°C]			
Humidity	: 30.6 [%]			
Test place	: 3m Semi-anechoic chamber			
Date	: 12~13-April-2022	Test engineer	:	<u>Tadahiro Seino</u>
Temperature	: 21.8 [°C]			
Humidity	: 32.6 [%]			
Test place	: 3m Semi-anechoic chamber			
Date	: 13-April-2022	Test engineer	:	<u>Chiaki Kanno</u>
Temperature	: 22.2 [°C]			
Humidity	: 30.1 [%]			
Test place	: 3m Semi-anechoic chamber			
Date	: 13~14-April-2022	Test engineer	:	<u>Tadahiro Seino</u>
Temperature	: 22.2 [°C]			
Humidity	: 41.4 [%]			
Test place	: 3m Semi-anechoic chamber			
Date	: 27~28-April-2022	Test engineer	:	<u>Chiaki Kanno</u>
Temperature	: 22.9 [°C]			
Humidity	: 37.5 [%]			
Test place	: 3m Semi-anechoic chamber			

[GSM1900 - X-axis, Open, Without camera]

H/V	Frequency [MHz]	S.A Reading [dBm]	Ant. Input [dBm]	Cable loss [dB]	Ant. Gain [dBi]	Result [dBm]	Limit [dBm]	Margin [dB]
H	1850.2	-27.5	28.9	1.2	4.9	32.7	33.0	0.3
H	1880.0	-27.7	29.2	1.2	4.8	32.8	33.0	0.2
H	1909.8	-29.1	28.2	1.2	4.6	31.5	33.0	1.5

[WCDMA Band II - X-axis, Open, Without camera]

H/V	Frequency [MHz]	S.A Reading [dBm]	Ant. Input [dBm]	Cable loss [dB]	Ant. Gain [dBi]	Result [dBm]	Limit [dBm]	Margin [dB]
H	1852.4	-25.3	23.6	1.2	4.9	27.4	33.0	5.6
H	1880.0	-25.4	23.0	1.2	4.8	26.6	33.0	6.4
H	1907.6	-26.0	22.8	1.2	4.6	26.3	33.0	6.7

[LTE Band II - X-axis, Open, Without camera]**QPSK, BW 1.4MHz**

H/V	Frequency [MHz]	S.A Reading [dBm]	Ant. Input [dBm]	Cable loss [dB]	Ant.Gain [dBi]	Result [dBm]	Limit [dBm]	Margin [dB]
H	1850.7	-25.4	23.4	1.2	4.9	27.2	33.0	5.8
H	1880.0	-25.5	22.7	1.2	4.8	26.3	33.0	6.7
H	1909.3	-26.5	21.9	1.2	4.6	25.3	33.0	7.7

16QAM, BW 1.4MHz

H/V	Frequency [MHz]	S.A Reading [dBm]	Ant. Input [dBm]	Cable loss [dB]	Ant.Gain [dBi]	Result [dBm]	Limit [dBm]	Margin [dB]
H	1850.7	-26.5	22.3	1.2	4.9	26.1	33.0	6.9
H	1880.0	-26.5	21.7	1.2	4.8	25.3	33.0	7.7
H	1909.3	-27.5	21.9	1.2	4.6	25.3	33.0	7.7

64QAM, BW 1.4MHz

H/V	Frequency [MHz]	S.A Reading [dBm]	Ant. Input [dBm]	Cable loss [dB]	Ant.Gain [dBi]	Result [dBm]	Limit [dBm]	Margin [dB]
H	1850.7	-27.4	21.4	1.2	4.9	25.2	33.0	7.8
H	1880.0	-27.6	20.6	1.2	4.8	24.2	33.0	8.8
H	1909.3	-28.5	20.9	1.2	4.6	24.3	33.0	8.7

QPSK, BW 3MHz

H/V	Frequency [MHz]	S.A Reading [dBm]	Ant. Input [dBm]	Cable loss [dB]	Ant.Gain [dBi]	Result [dBm]	Limit [dBm]	Margin [dB]
H	1851.5	-25.5	23.3	1.2	4.9	27.1	33.0	5.9
H	1880.0	-25.8	22.4	1.2	4.8	26.0	33.0	7.0
H	1908.5	-26.9	21.6	1.2	4.6	25.0	33.0	8.0

16QAM, BW 3MHz

H/V	Frequency [MHz]	S.A Reading [dBm]	Ant. Input [dBm]	Cable loss [dB]	Ant.Gain [dBi]	Result [dBm]	Limit [dBm]	Margin [dB]
H	1851.5	-25.9	22.9	1.2	4.9	26.7	33.0	6.3
H	1880.0	-26.9	21.3	1.2	4.8	24.9	33.0	8.1
H	1908.5	-27.5	21.0	1.2	4.6	24.4	33.0	8.6

64QAM, BW 3MHz

H/V	Frequency [MHz]	S.A Reading [dBm]	Ant. Input [dBm]	Cable loss [dB]	Ant.Gain [dBi]	Result [dBm]	Limit [dBm]	Margin [dB]
H	1851.5	-27.7	21.1	1.2	4.9	24.9	33.0	8.1
H	1880.0	-27.4	20.8	1.2	4.8	24.4	33.0	8.6
H	1908.5	-28.9	19.6	1.2	4.6	23.0	33.0	10.0

[LTE Band II - X-axis, Open, Without camera]**QPSK, BW 5MHz**

H/V	Frequency [MHz]	S.A Reading [dBm]	Ant. Input [dBm]	Cable loss [dB]	Ant.Gain [dBi]	Result [dBm]	Limit [dBm]	Margin [dB]
H	1852.5	-25.6	23.2	1.2	4.9	27.0	33.0	6.0
H	1880.0	-26.0	22.2	1.2	4.8	25.8	33.0	7.2
H	1907.5	-26.8	21.9	1.2	4.6	25.4	33.0	7.6

16QAM, BW 5MHz

H/V	Frequency [MHz]	S.A Reading [dBm]	Ant. Input [dBm]	Cable loss [dB]	Ant.Gain [dBi]	Result [dBm]	Limit [dBm]	Margin [dB]
H	1852.5	-26.8	22.0	1.2	4.9	25.8	33.0	7.2
H	1880.0	-26.5	21.7	1.2	4.8	25.3	33.0	7.7
H	1907.5	-27.4	21.3	1.2	4.6	24.8	33.0	8.2

64QAM, BW 5MHz

H/V	Frequency [MHz]	S.A Reading [dBm]	Ant. Input [dBm]	Cable loss [dB]	Ant.Gain [dBi]	Result [dBm]	Limit [dBm]	Margin [dB]
H	1852.5	-28.0	20.8	1.2	4.9	24.6	33.0	8.4
H	1880.0	-27.6	20.6	1.2	4.8	24.2	33.0	8.8
H	1907.5	-28.9	19.8	1.2	4.6	23.3	33.0	9.7

QPSK, BW 10MHz

H/V	Frequency [MHz]	S.A Reading [dBm]	Ant. Input [dBm]	Cable loss [dB]	Ant.Gain [dBi]	Result [dBm]	Limit [dBm]	Margin [dB]
H	1855.0	-25.7	23.1	1.2	4.9	26.8	33.0	6.2
H	1880.0	-25.7	22.5	1.2	4.8	26.1	33.0	6.9
H	1905.0	-26.7	22.2	1.2	4.6	25.6	33.0	7.4

16QAM, BW 10MHz

H/V	Frequency [MHz]	S.A Reading [dBm]	Ant. Input [dBm]	Cable loss [dB]	Ant.Gain [dBi]	Result [dBm]	Limit [dBm]	Margin [dB]
H	1855.0	-26.7	22.1	1.2	4.9	25.8	33.0	7.2
H	1880.0	-26.7	21.5	1.2	4.8	25.1	33.0	7.9
H	1905.0	-27.7	21.2	1.2	4.6	24.6	33.0	8.4

64QAM, BW 10MHz

H/V	Frequency [MHz]	S.A Reading [dBm]	Ant. Input [dBm]	Cable loss [dB]	Ant.Gain [dBi]	Result [dBm]	Limit [dBm]	Margin [dB]
H	1855.0	-27.2	21.6	1.2	4.9	25.3	33.0	7.7
H	1880.0	-28.1	20.1	1.2	4.8	23.7	33.0	9.3
H	1905.0	-28.7	20.2	1.2	4.6	23.6	33.0	9.4

[LTE Band II - X-axis, Open, Without camera]**QPSK, BW 15MHz**

H/V	Frequency [MHz]	S.A Reading [dBm]	Ant. Input [dBm]	Cable loss [dB]	Ant.Gain [dBi]	Result [dBm]	Limit [dBm]	Margin [dB]
H	1857.5	-25.8	22.8	1.2	4.9	26.5	33.0	6.5
H	1880.0	-25.6	22.6	1.2	4.8	26.2	33.0	6.8
H	1902.5	-27.0	22.2	1.2	4.6	25.6	33.0	7.4

16QAM, BW 15MHz

H/V	Frequency [MHz]	S.A Reading [dBm]	Ant. Input [dBm]	Cable loss [dB]	Ant.Gain [dBi]	Result [dBm]	Limit [dBm]	Margin [dB]
H	1857.5	-26.7	21.9	1.2	4.9	25.6	33.0	7.4
H	1880.0	-26.3	21.9	1.2	4.8	25.5	33.0	7.5
H	1902.5	-27.9	21.3	1.2	4.6	24.7	33.0	8.3

64QAM, BW 15MHz

H/V	Frequency [MHz]	S.A Reading [dBm]	Ant. Input [dBm]	Cable loss [dB]	Ant.Gain [dBi]	Result [dBm]	Limit [dBm]	Margin [dB]
H	1857.5	-27.8	20.8	1.2	4.9	24.5	33.0	8.5
H	1880.0	-27.6	20.6	1.2	4.8	24.2	33.0	8.8
H	1902.5	-28.5	20.7	1.2	4.6	24.1	33.0	8.9

QPSK, BW 20MHz

H/V	Frequency [MHz]	S.A Reading [dBm]	Ant. Input [dBm]	Cable loss [dB]	Ant.Gain [dBi]	Result [dBm]	Limit [dBm]	Margin [dB]
H	1860.0	-26.1	22.3	1.2	4.9	26.0	33.0	7.0
H	1880.0	-25.6	22.6	1.2	4.8	26.2	33.0	6.8
H	1900.0	-26.5	22.7	1.2	4.7	26.1	33.0	6.9

16QAM, BW 20MHz

H/V	Frequency [MHz]	S.A Reading [dBm]	Ant. Input [dBm]	Cable loss [dB]	Ant.Gain [dBi]	Result [dBm]	Limit [dBm]	Margin [dB]
H	1860.0	-27.1	21.3	1.2	4.9	25.0	33.0	8.0
H	1880.0	-26.4	21.8	1.2	4.8	25.4	33.0	7.6
H	1900.0	-27.7	21.5	1.2	4.7	24.9	33.0	8.1

64QAM, BW 20MHz

H/V	Frequency [MHz]	S.A Reading [dBm]	Ant. Input [dBm]	Cable loss [dB]	Ant.Gain [dBi]	Result [dBm]	Limit [dBm]	Margin [dB]
H	1860.0	-28.0	20.4	1.2	4.9	24.1	33.0	8.9
H	1880.0	-27.4	20.8	1.2	4.8	24.4	33.0	8.6
H	1900.0	-28.6	20.6	1.2	4.7	24.0	33.0	9.0

4.2 Peak to Average Ratio

4.2.1 Measurement procedure

[FCC 24.232(d)]

The peak to average ratio was measured with a spectrum analyzer connected to the antenna terminal.

The spectrum analyzer is set to;

[GSM1900]

- a) Span = 5 MHz
- b) RBW = 1 MHz
- c) VBW $\geq 3 \times$ RBW
- d) Detector = Peak / Average
- e) Sweep time = auto-couple
- f) Trace mode=Max hold

[WCDMA Band II, LTE Band II]

- a) Power Stat CCDF mode
- b) Set resolution / measurement bandwidth \geq signal's occupied bandwidth.
- c) Set the number of counts to a value that stabilizes the measured CCDF curve.
- d) Set the measurement interval as follows:
 - 1) For continuous transmissions, set to 1ms.
 - 2) For burst transmissions, employ an external trigger that is synchronized with the EUT burst timing sequence, or use the internal burst trigger with a trigger level that allows the burst duration.
- e) Record the maximum PAPR level associated with a probability of 0.1%.

- Test configuration

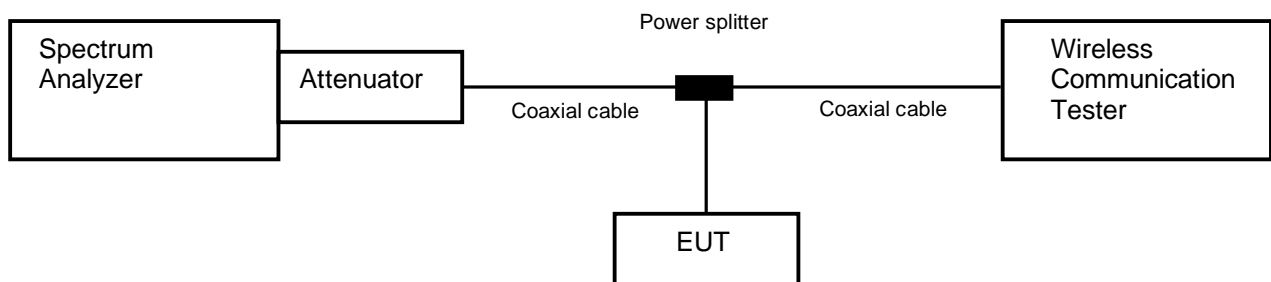

4.2.2 Limit

13 dB or less

4.2.3 Measurement result

Date : 28-April-2022
 Temperature : 22.9 [°C]
 Humidity : 36.1 [%]
 Test place : Shielded room No.4

Test engineer : Tadahiro Seino

Band	Channel	Frequency [MHz]	Peak to Average Power Ratio [dB]	Limit [dB]
GSM1900	512	1850.2	0.01	13.0
	661	1880.0	0.01	
	810	1909.8	0.03	
WCDMA Band II	9262	1852.4	3.10	13.0
	9400	1880.0	3.23	
	9538	1907.6	3.03	

Band	Channel	Frequency [MHz]	Modulation	Bandwidth [MHz]	RB	Peak to Average Power Ratio [dB]	Limit [dB]
LTE Band II	18900	1880.0	QPSK	1.4	6-0	5.61	13.0
				3	15-0	5.75	
				5	25-0	5.70	
				10	50-0	4.62	
				15	75-0	5.81	
				20	100-0	6.54	
			16QAM	1.4	6-0	6.37	
				3	15-0	6.45	
				5	25-0	6.34	
				10	50-0	6.20	
				15	75-0	6.90	
				20	100-0	7.33	
			64QAM	1.4	6-0	6.47	
				3	15-0	6.53	
				5	25-0	6.49	
				10	50-0	6.53	
				15	75-0	7.08	
				20	100-0	7.32	

4.2.4 Trace data

[GSM1900]

Channel: 512

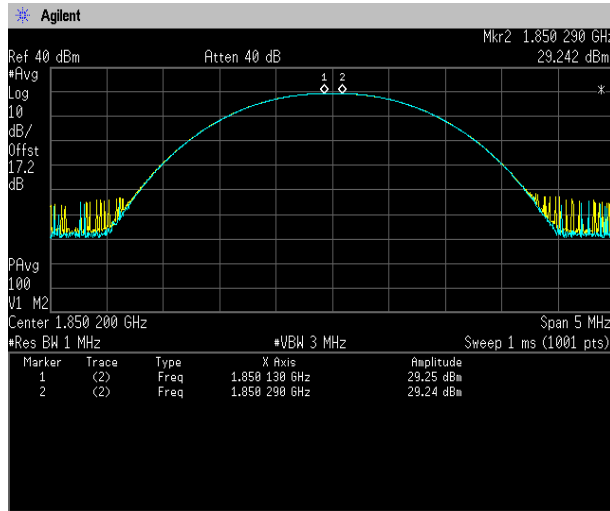

Channel: 661

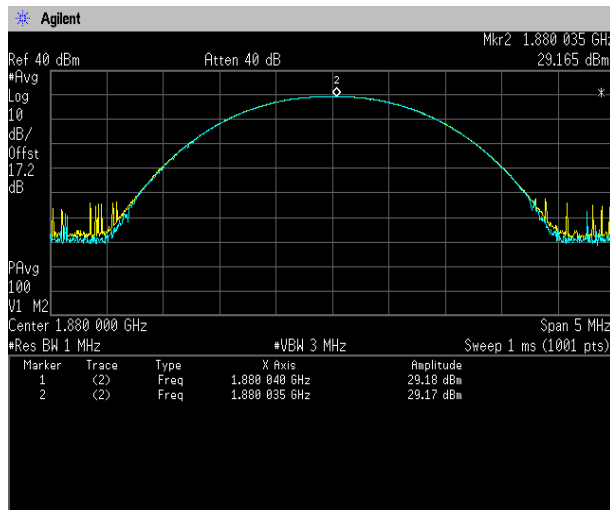

Channel: 810

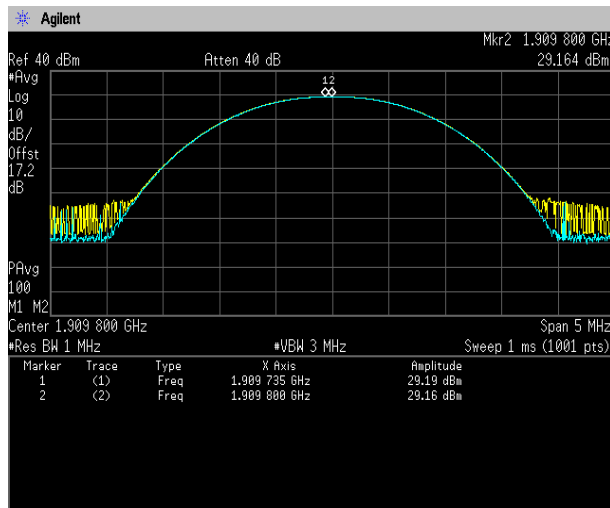

**[WCDMA Band II]
Channel: 9262**

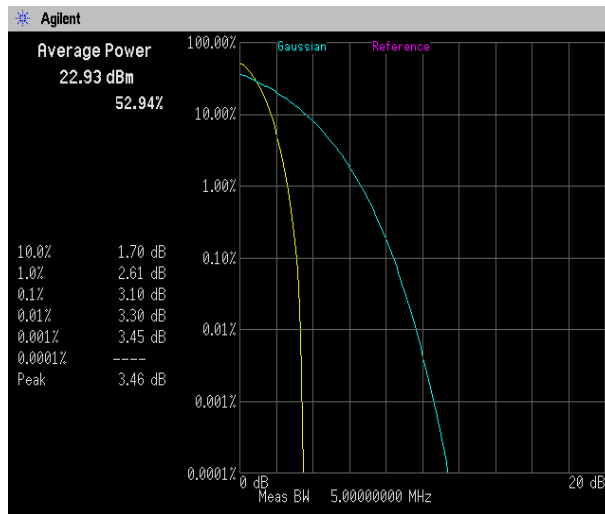

Channel: 9400

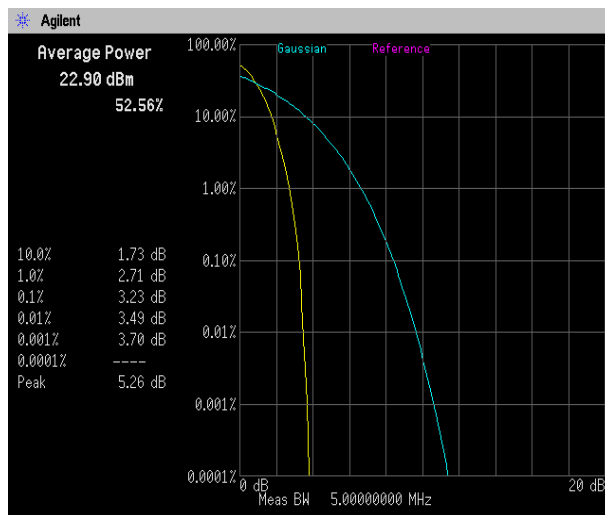

Channel: 9538

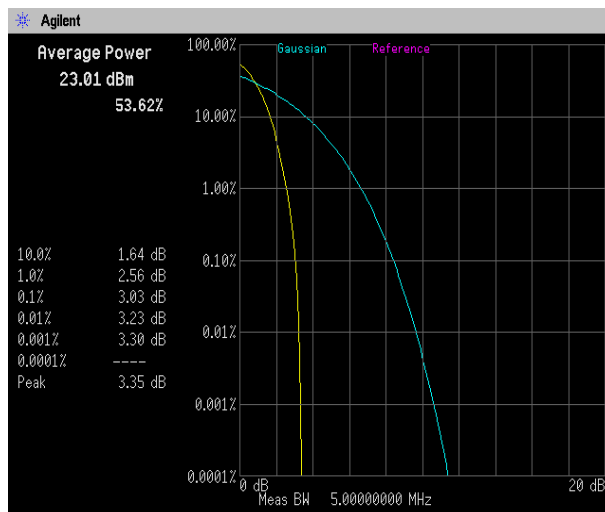

[LTE Band II]

Channel: 18900
 QPSK, BW 1.4MHz, RB6-0

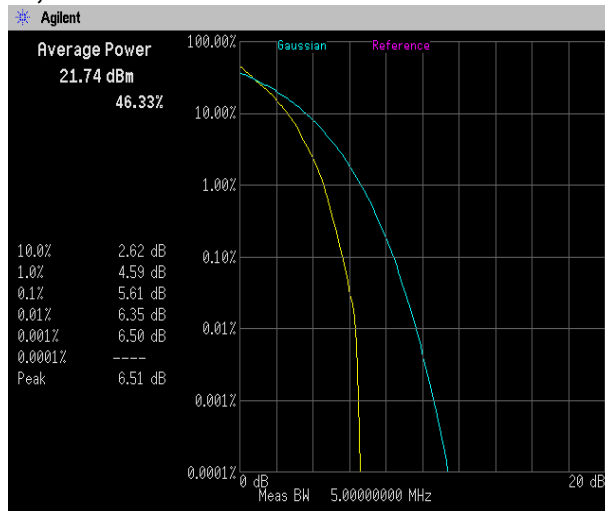

QPSK, BW 3MHz, RB15-0

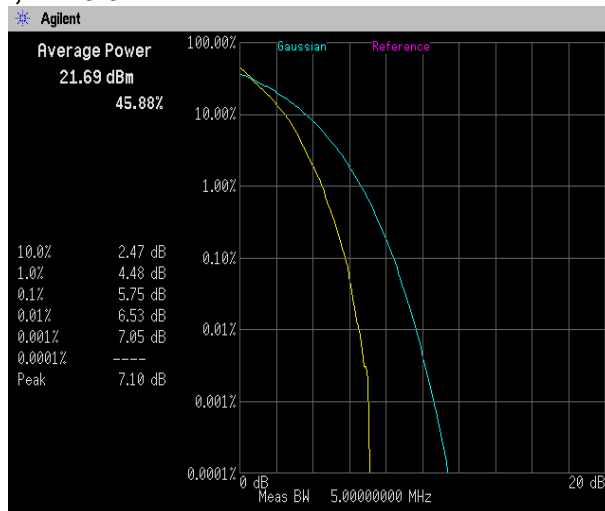

QPSK, BW 5MHz, RB25-0

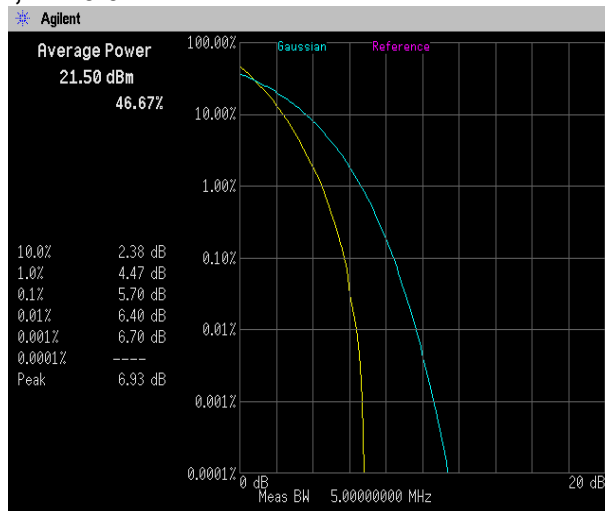



Channel: 18900
QPSK, BW 10MHz, RB50-0

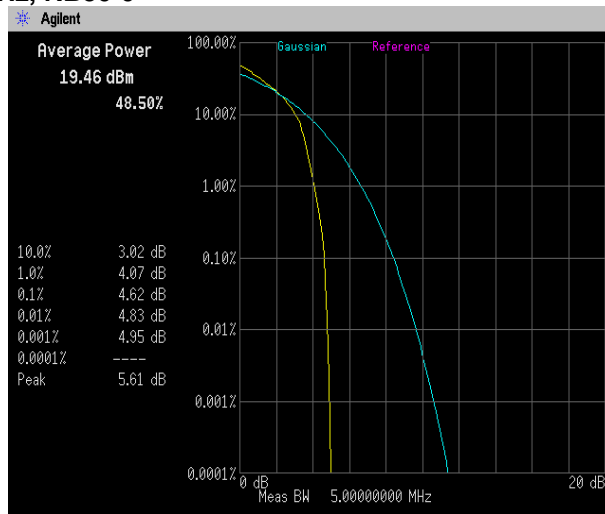

QPSK, BW 15MHz, RB75-0

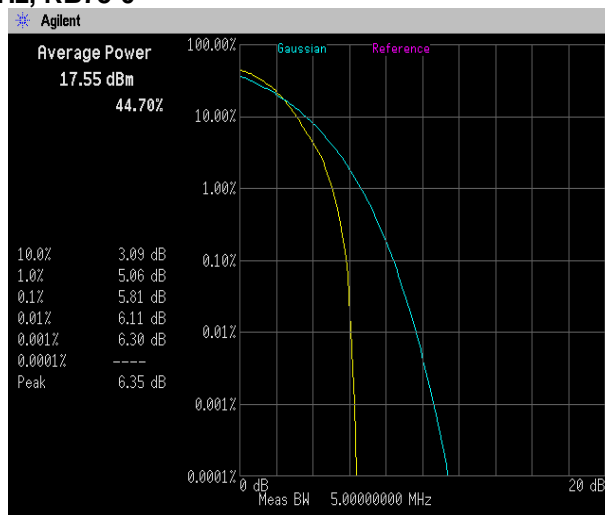

QPSK, BW 20MHz, RB100-0

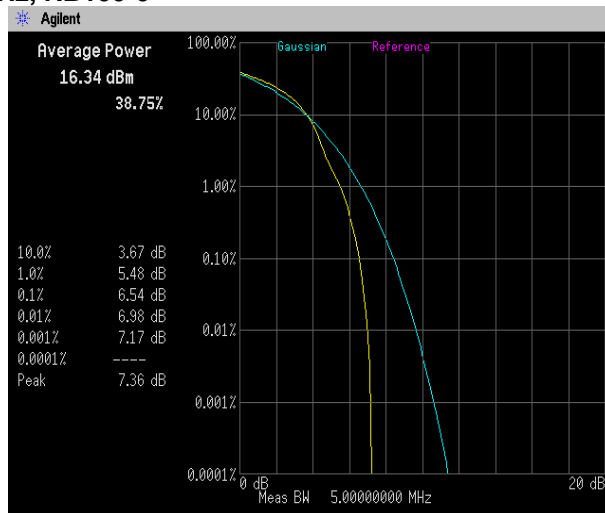



Channel: 18900
16QAM, BW 1.4MHz, RB6-0

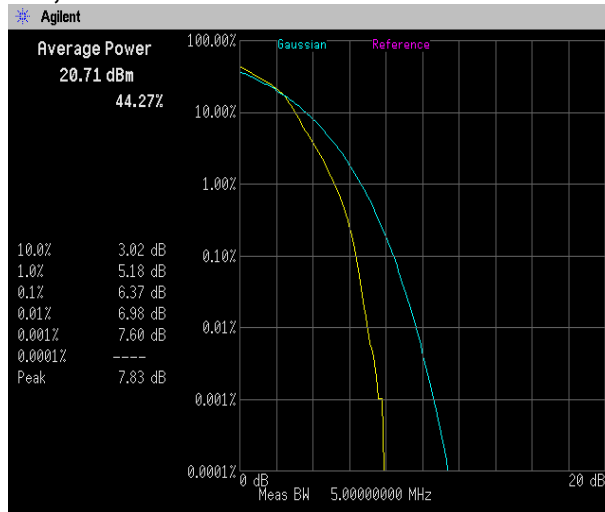

16QAM, BW 3MHz, RB15-0

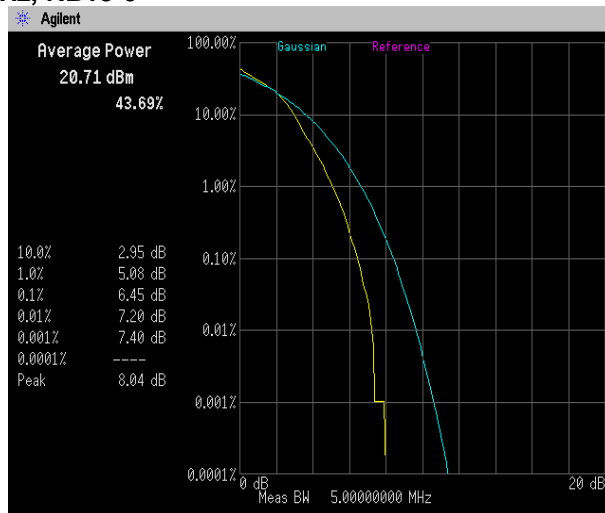

16QAM, BW 5MHz, RB25-0

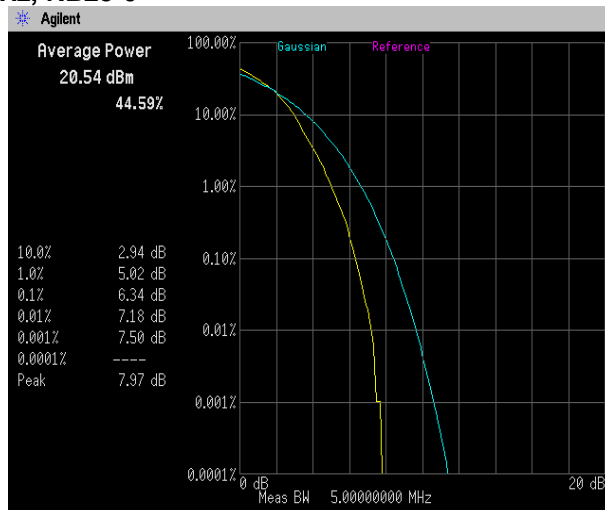

Channel: 18900
16QAM, BW 10MHz, RB50-0

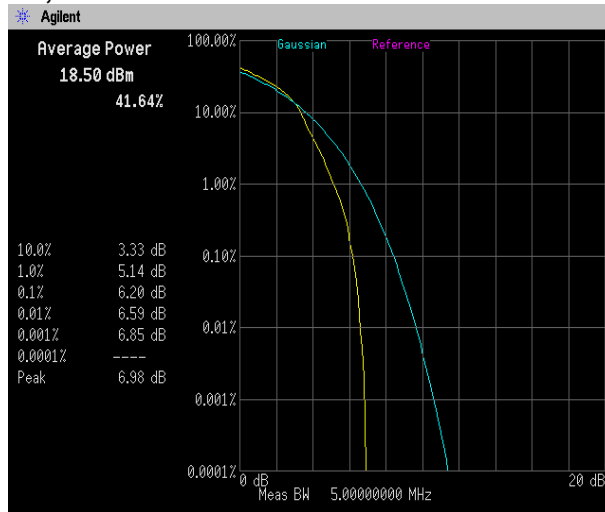

16QAM, BW 15MHz, RB75-0

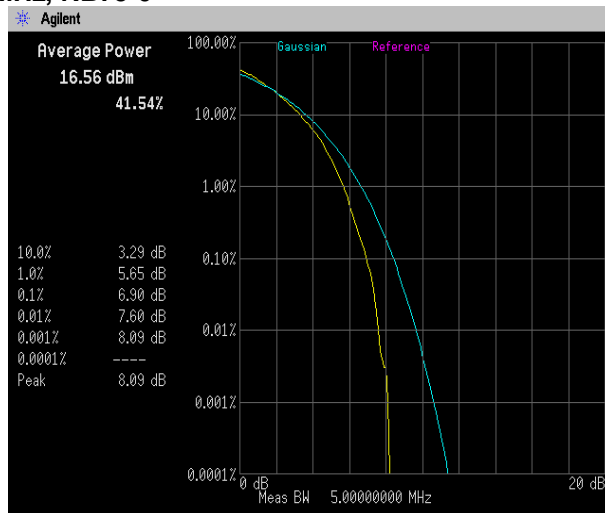

16QAM, BW 20MHz, RB100-0

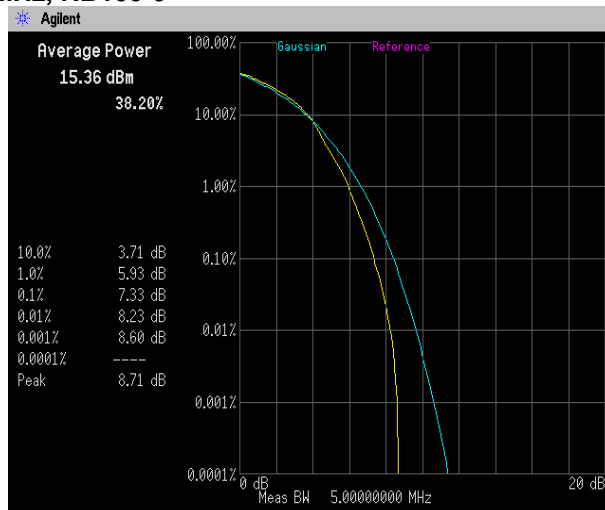

Channel: 18900
64QAM, BW 1.4MHz, RB6-0

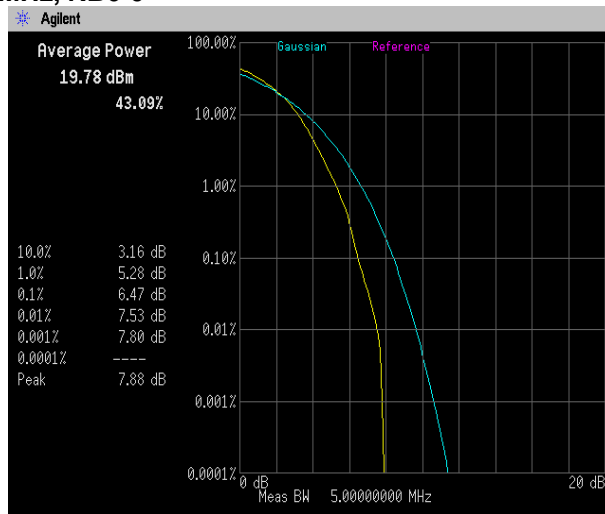

64QAM, BW 3MHz, RB15-0

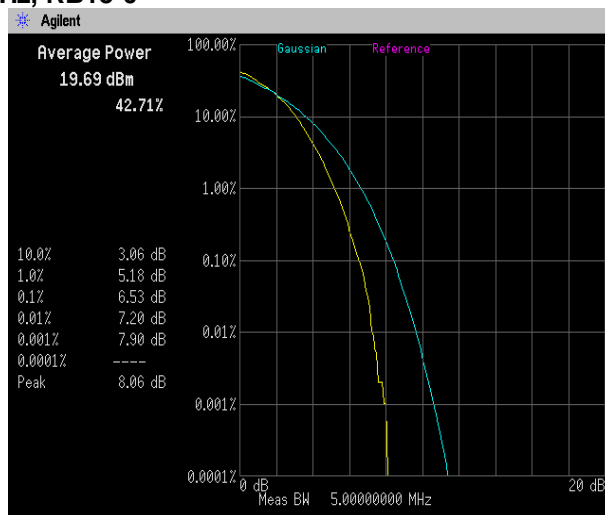

64QAM, BW 5MHz, RB25-0

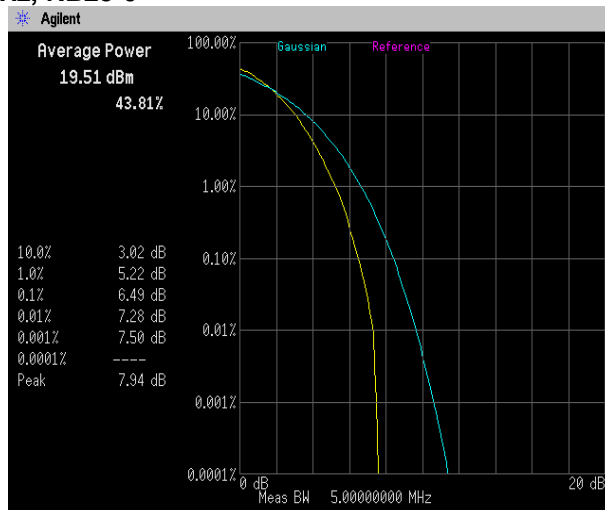

Channel: 18900
64QAM, BW 10MHz, RB50-0

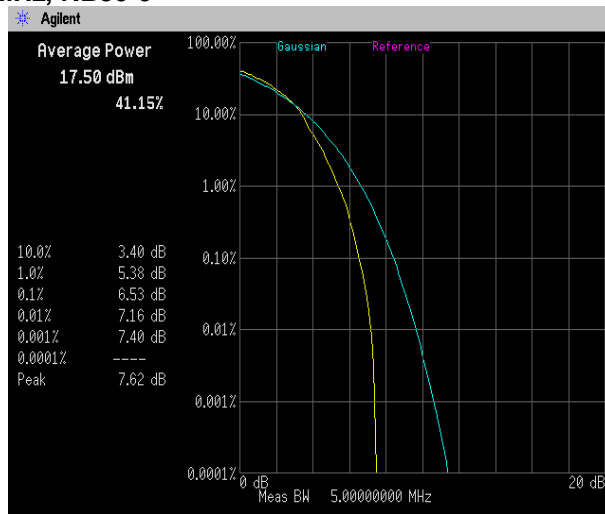

64QAM, BW 15MHz, RB75-0

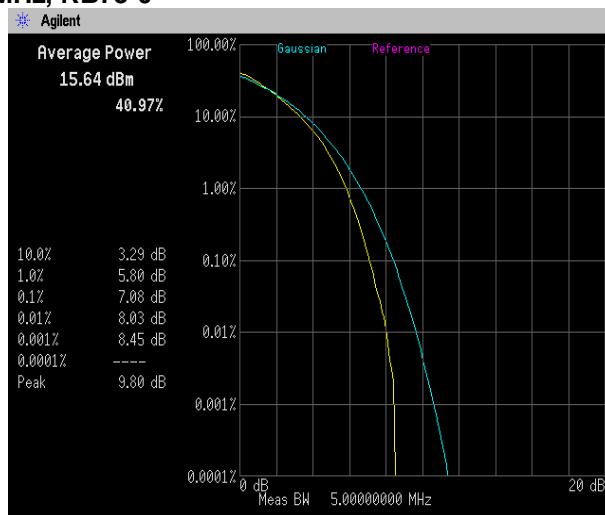

64QAM, BW 20MHz, RB100-0

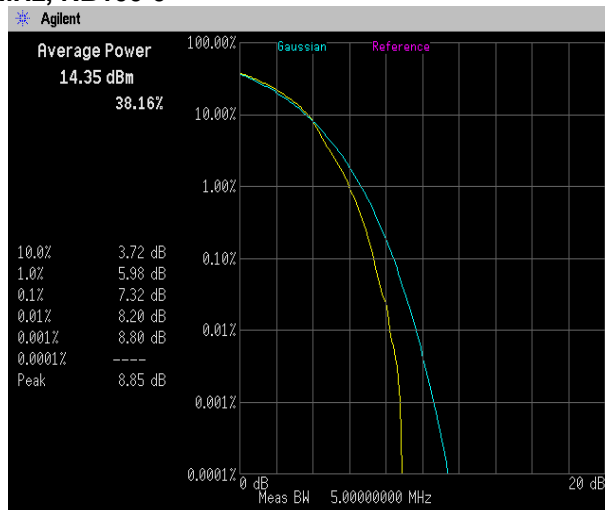

4.3 Occupied Bandwidth

4.3.1 Measurement procedure

[FCC 24.238(a), 2.1049]

The Occupied bandwidth was measured with a spectrum analyzer connected to the antenna terminal.

The spectrum analyzer is set to;

- a) RBW = 1-5% of the expected OBW & VBW ≥ 3 x RBW
- b) Detector = Peak
- c) Trace mode = Max hold
- d) Sweep time = auto-couple

- Test configuration

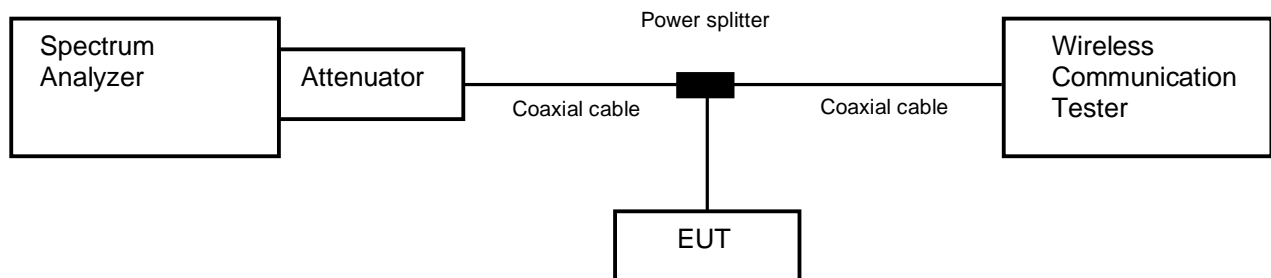

4.3.2 Limit

None

4.3.3 Measurement result

Date : 28-April-2022
 Temperature : 22.9 [°C]
 Humidity : 36.1 [%]
 Test place : Shielded room No.4

Test engineer :

Tadahiro Seino

Band	Channel	Frequency [MHz]	Test Result [kHz]
GSM1900	512	1850.2	243.7846
	661	1880.0	244.7056
	810	1909.8	243.2072

Band	Channel	Frequency [MHz]	Test Result [kHz]
WCDMA Band II	9262	1852.4	4160.9
	9400	1880.0	4165.7
	9538	1907.6	4154.0



Band	Channel	Frequency [MHz]	Bandwidth [MHz]	Modulation	RB	Test Result [MHz]
LTE Band II	18900	1880.0	1.4	QPSK	3-1	0.5967
					6-0	1.0960
				16QAM	3-1	0.6038
					6-0	1.0954
				64QAM	3-1	0.5930
					6-0	1.0848
			3	QPSK	8-4	1.5137
					15-0	2.6967
				16QAM	8-4	1.5205
					15-0	2.6928
				64QAM	8-4	1.5030
					15-0	2.7133
			5	QPSK	12-7	2.3122
					25-0	4.5132
				16QAM	12-7	2.3034
					25-0	4.4921
				64QAM	12-7	2.2672
					25-0	4.4970
			10	QPSK	25-12	4.6507
					50-0	8.9938
				16QAM	25-12	4.6522
					50-0	8.9966
				64QAM	25-12	4.6580
					50-0	8.9673
15	QPSK	36-20	6.6974			
		75-0	13.4782			
	16QAM	36-20	6.6794			
		75-0	13.4751			
	64QAM	36-20	6.7141			
		75-0	13.4430			
20	QPSK	50-24	9.2088			
		100-0	17.9535			
	16QAM	50-24	9.1921			
		100-0	18.0167			
	64QAM	50-24	9.1591			
		100-0	17.9641			

4.3.4 Trace data

[GSM1900]

Channel: 512

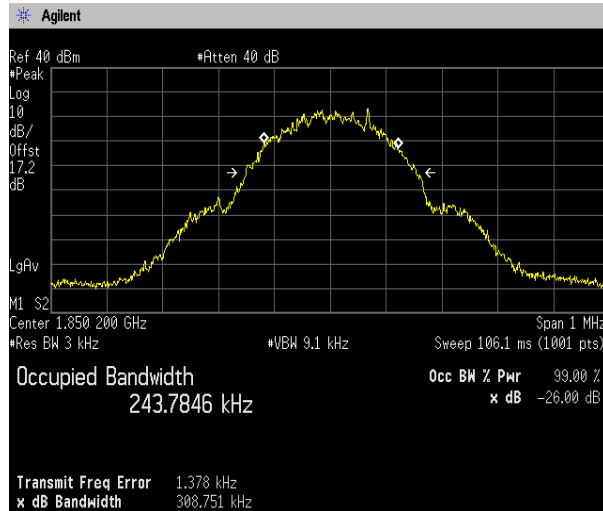

Channel: 661

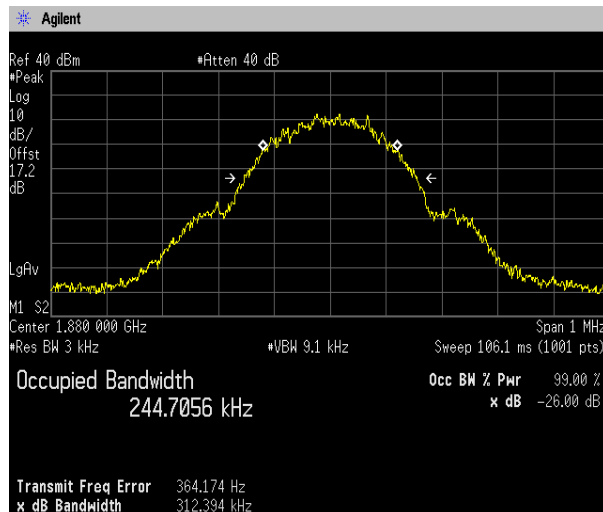

Channel: 810

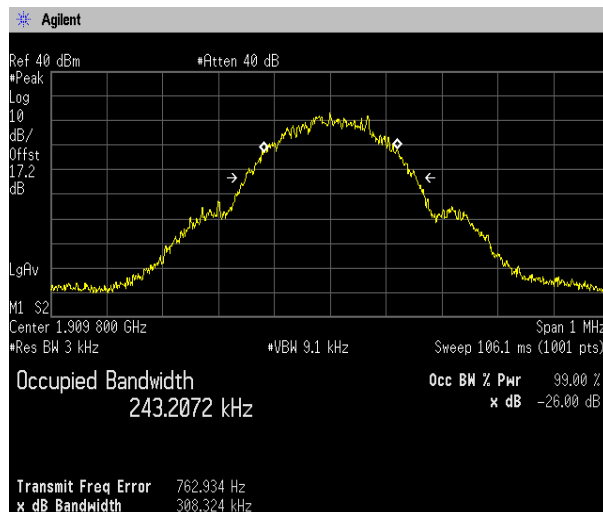

**[WCDMA Band II]
Channel: 9262**

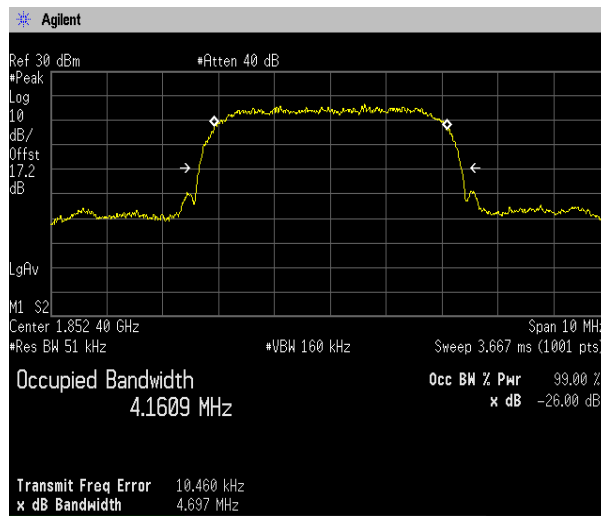

Channel: 9400

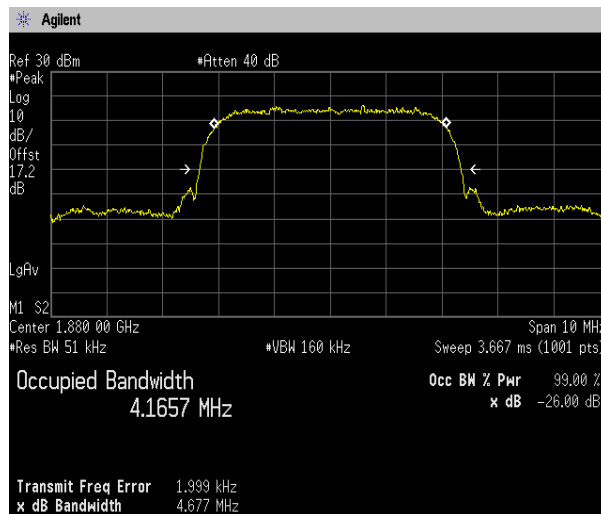

Channel: 9538

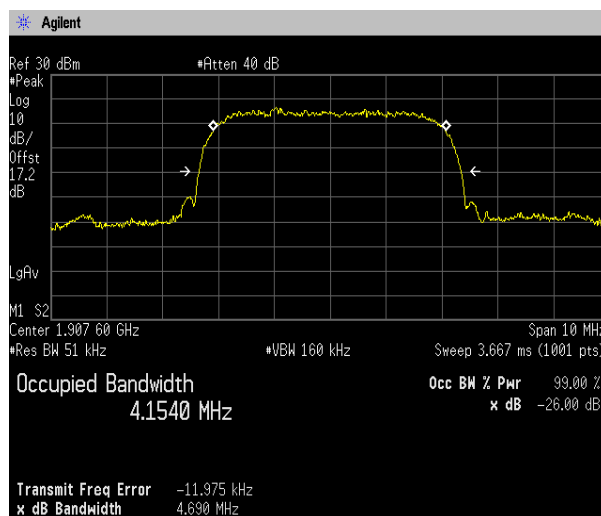



[LTE Band II]
Channel: 18900

QPSK, BW 1.4MHz

RB3-1

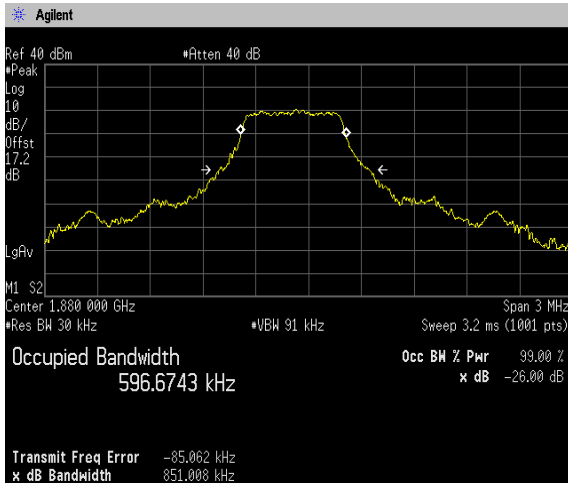

RB6-0

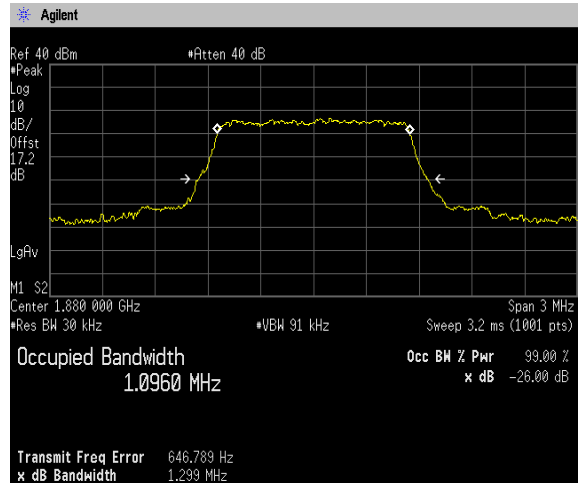

16QAM, BW 1.4MHz

RB3-1

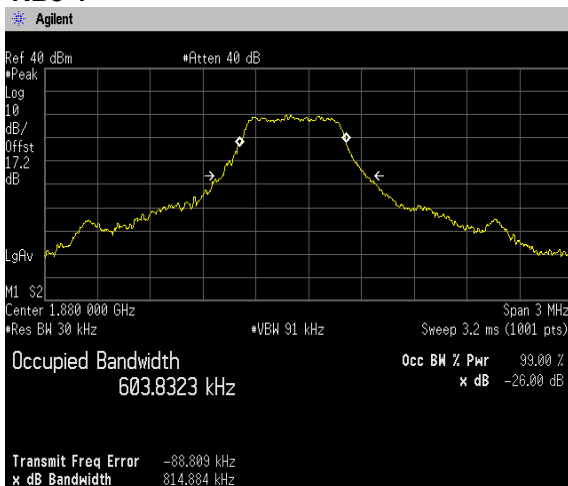

RB6-0

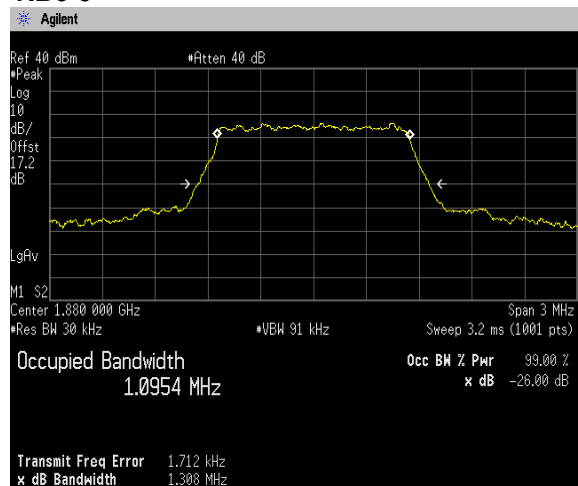

64QAM, BW 1.4MHz

RB3-1

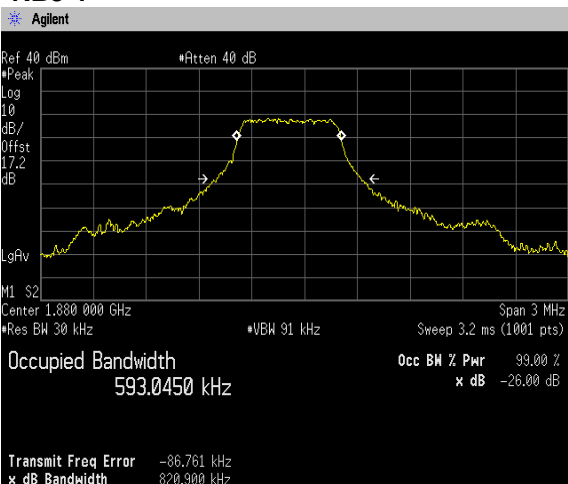

RB6-0

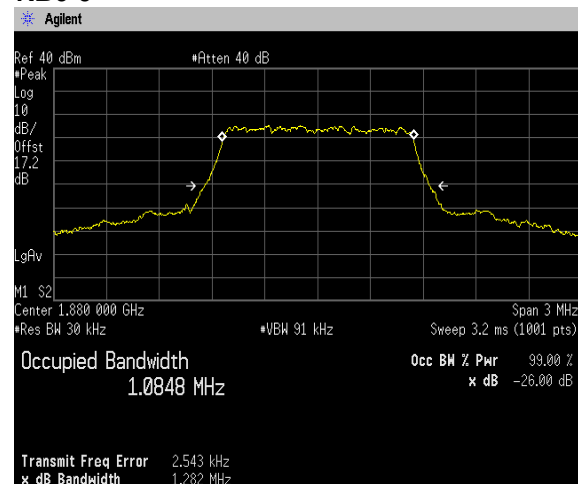



QPSK, BW 3MHz

RB8-4

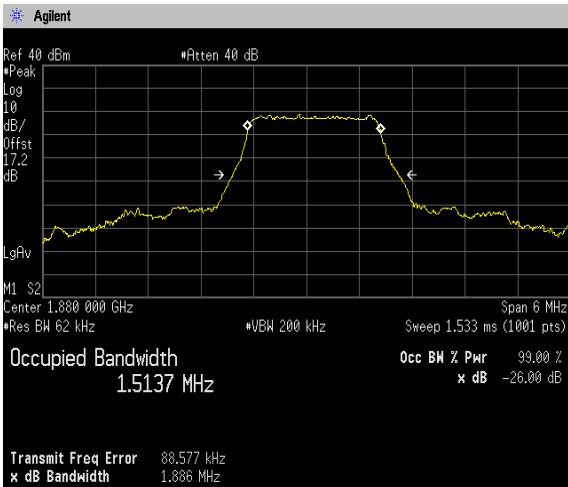

RB15-0

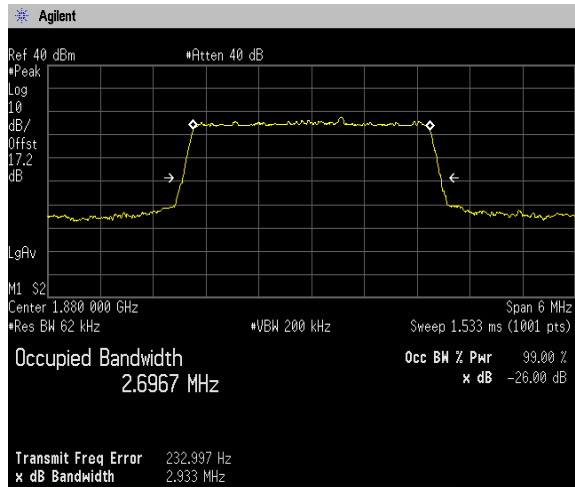

16QAM, BW 3MHz

RB8-4

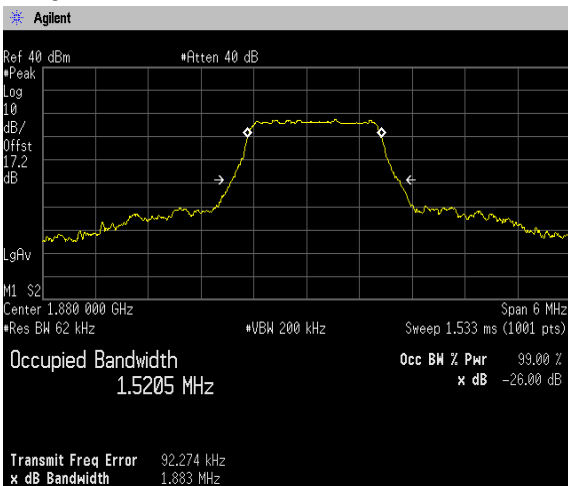

RB15-0

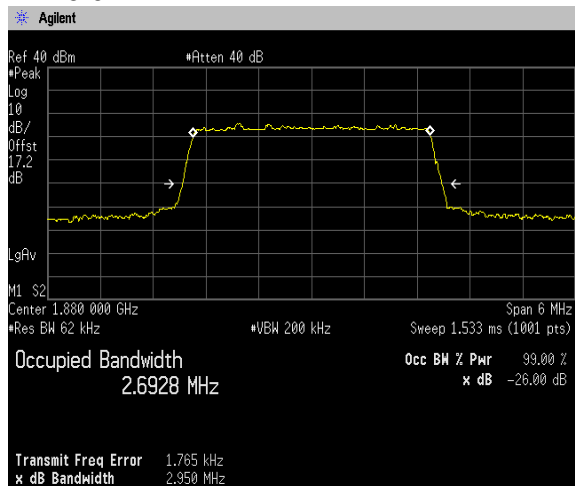

64QAM, BW 3MHz

RB8-4

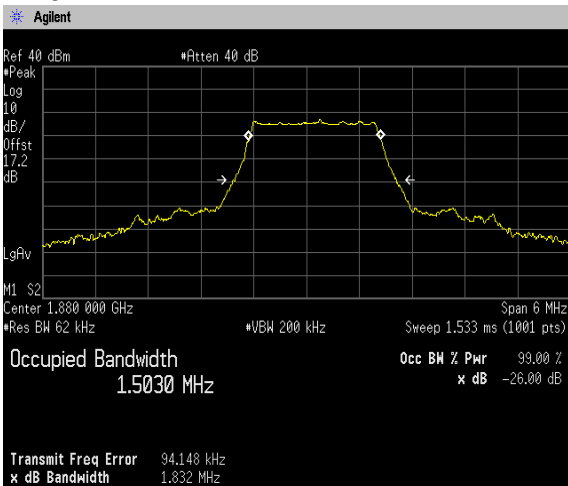

RB15-0

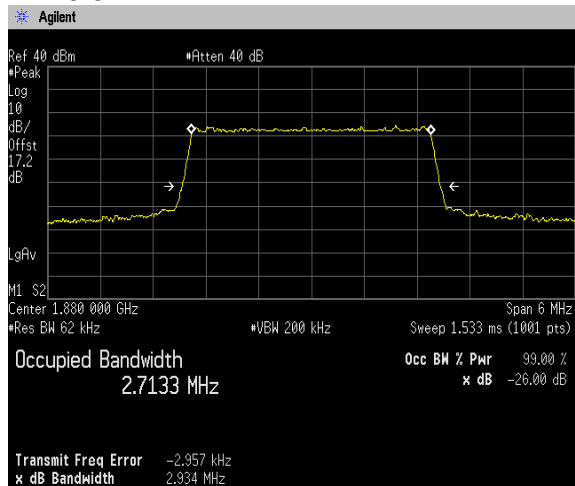



QPSK, BW 5MHz

RB12-7

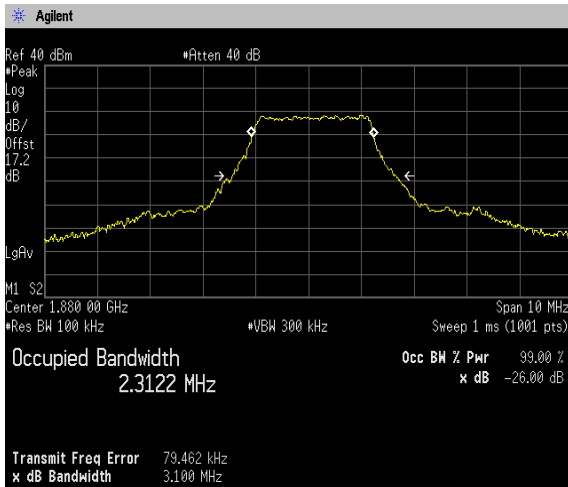

RB25-0

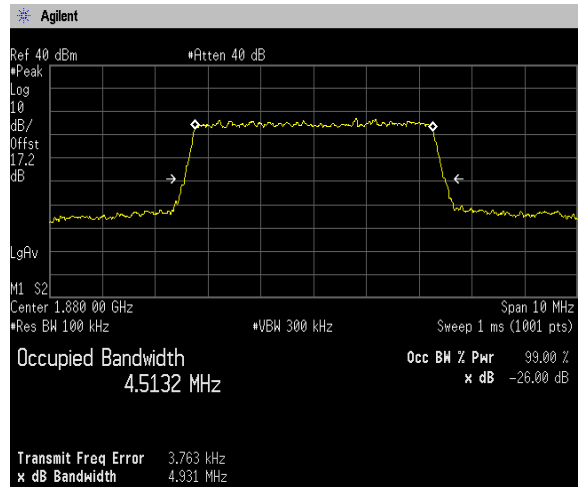

16QAM, BW 5MHz

RB12-7

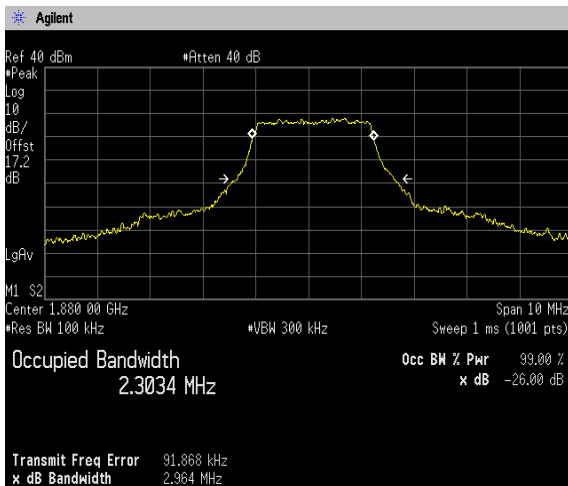

RB25-0

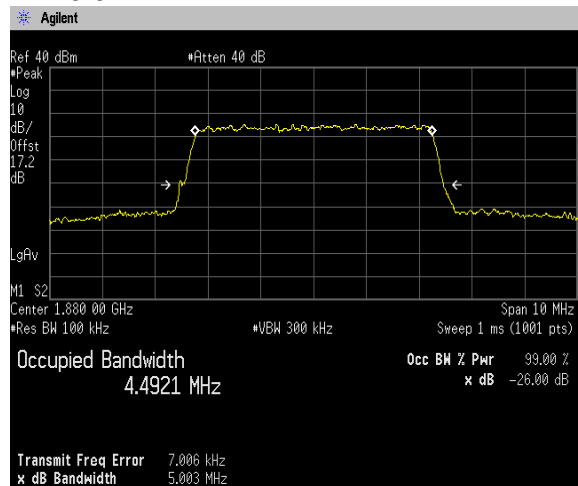

64QAM, BW 5MHz

RB12-7

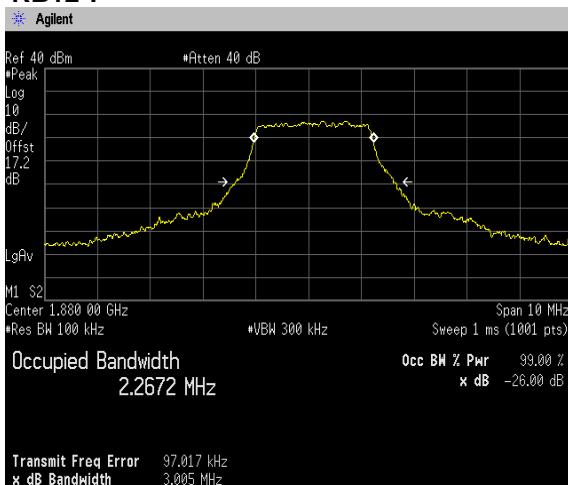

RB25-0

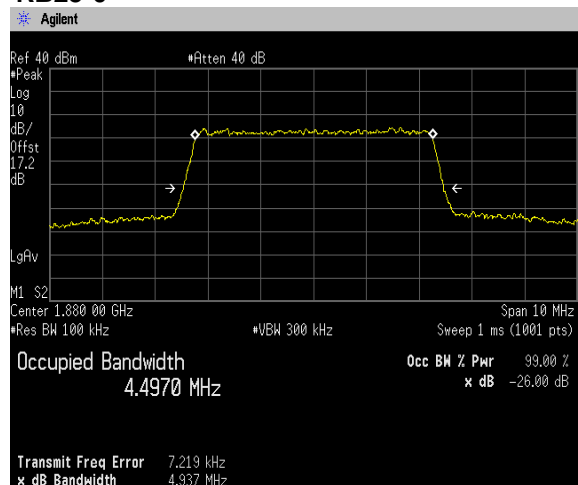



QPSK, BW 10MHz
RB25-12

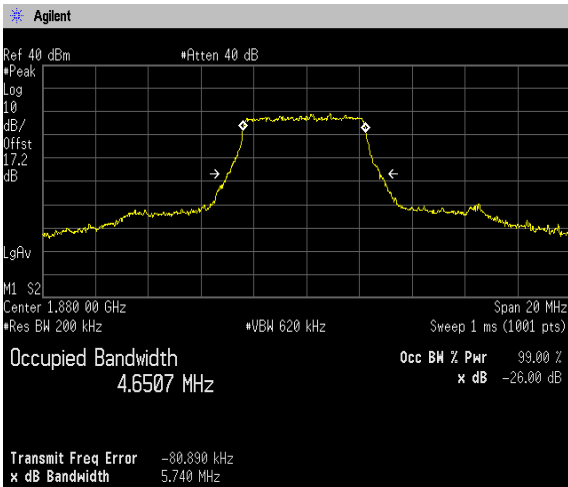

RB50-0

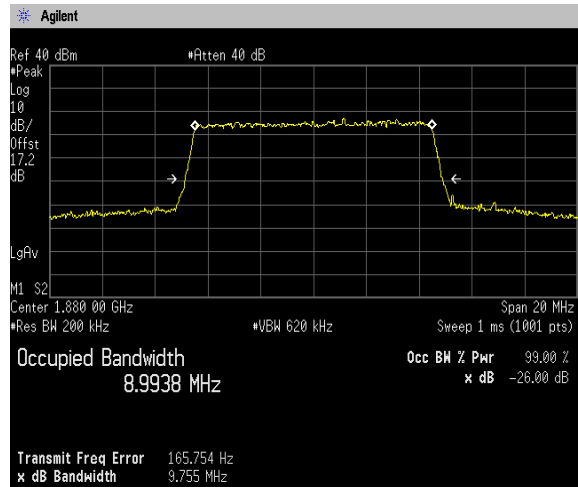

16QAM, BW 10MHz
RB25-12

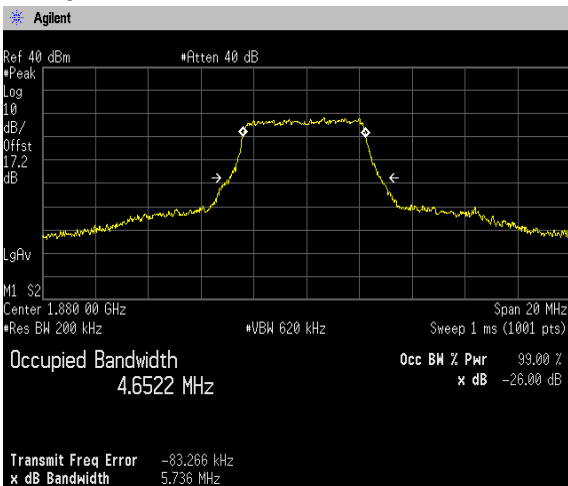

RB50-0

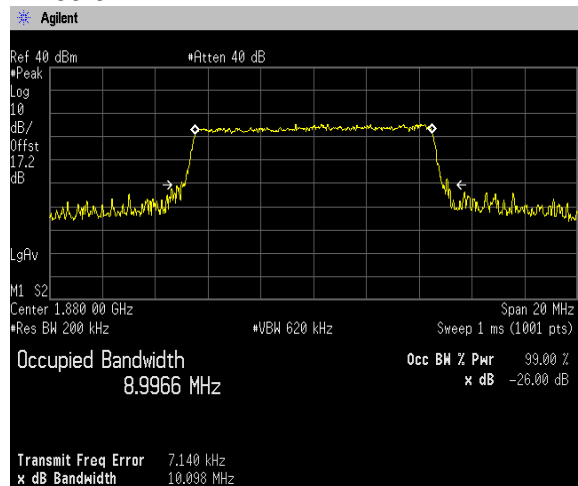

64QAM, BW 10MHz
RB25-12

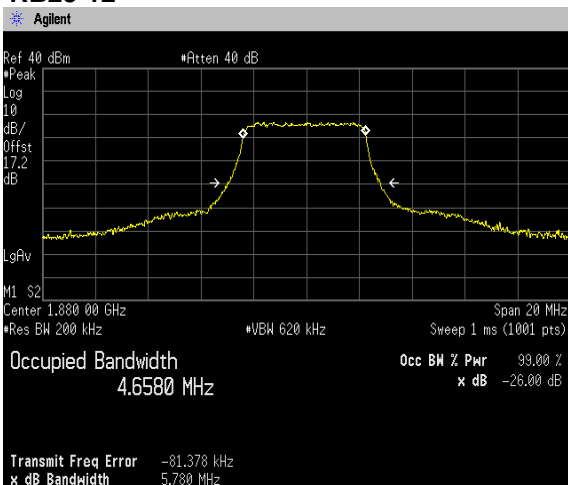

RB50-0

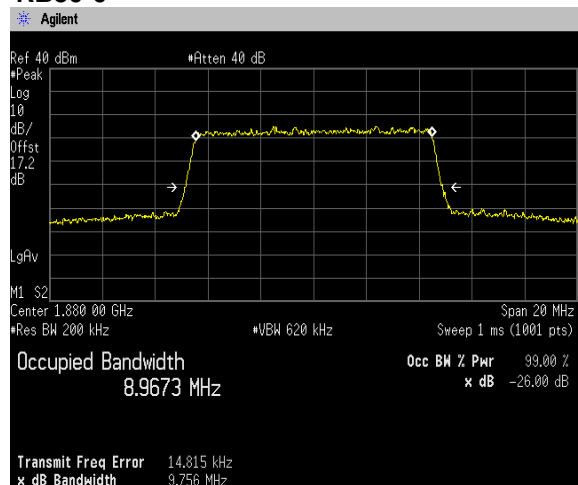



QPSK, BW 15MHz

RB36-20

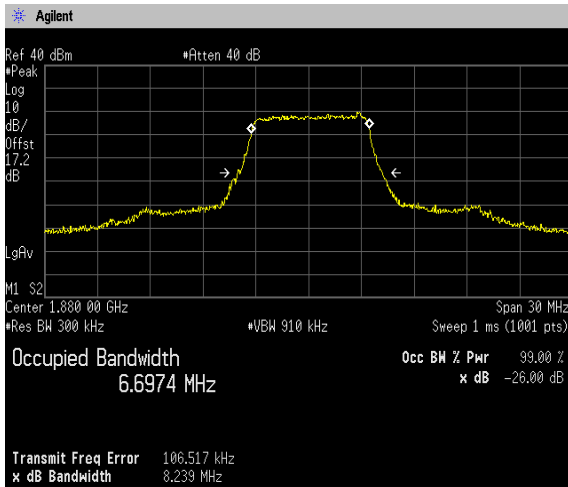

RB75-0

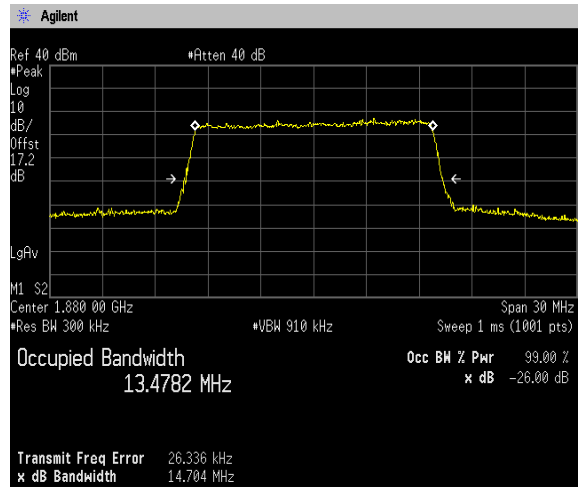

16QAM, BW 15MHz

RB36-20

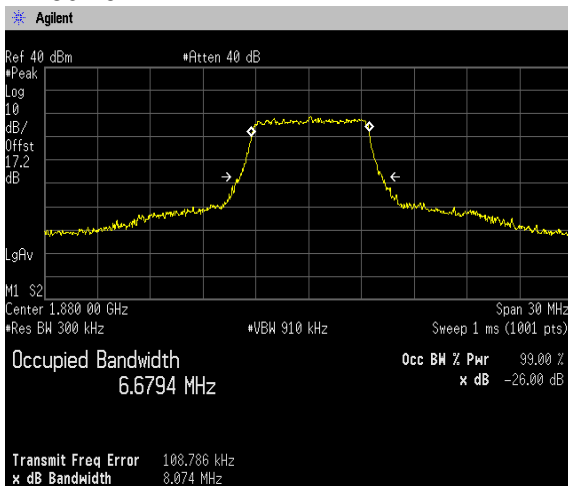

RB75-0

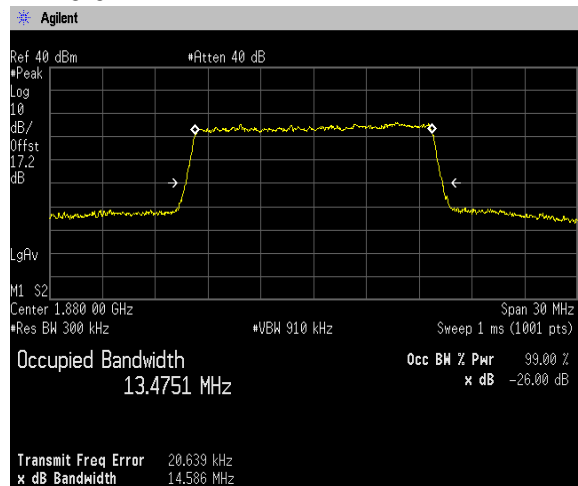

64QAM, BW 15MHz

RB36-20

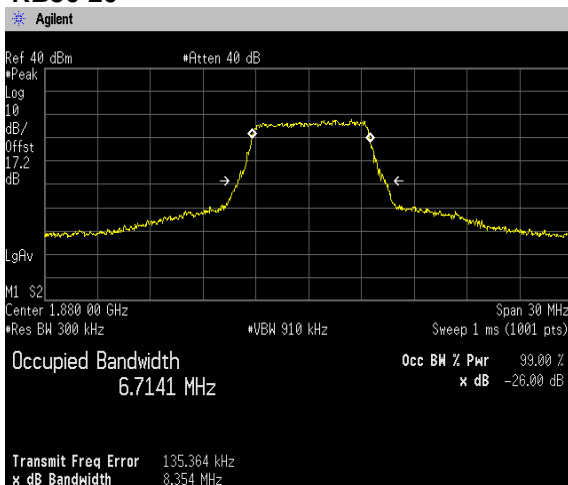

RB75-0

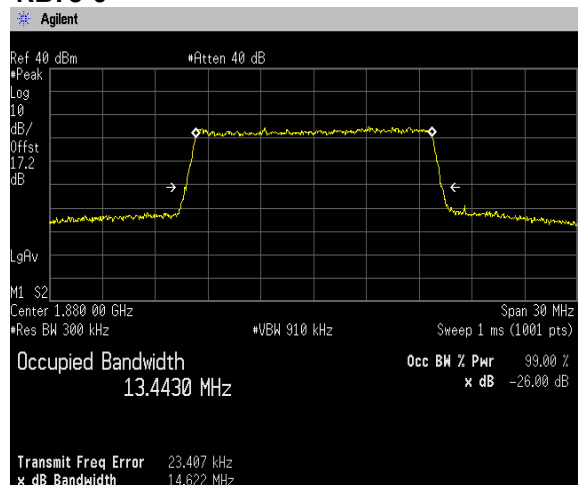

QPSK, BW 20MHz
RB50-24

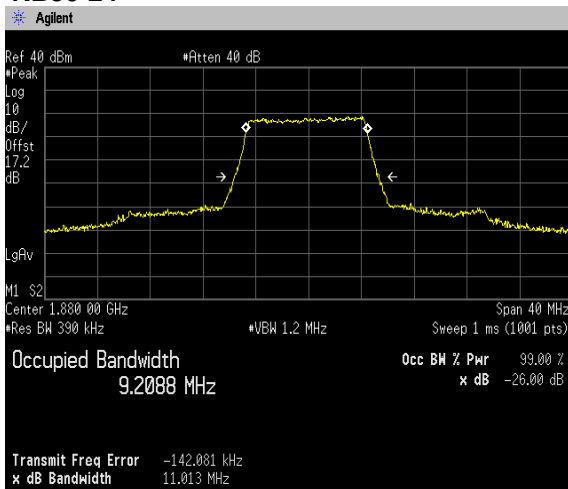

RB100-0

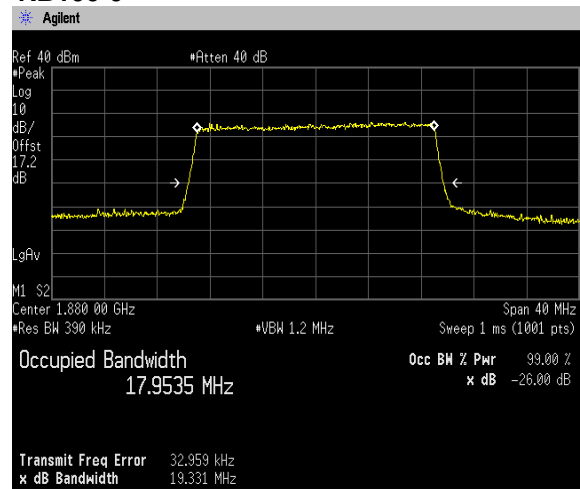

16QAM, BW 20MHz
RB50-24

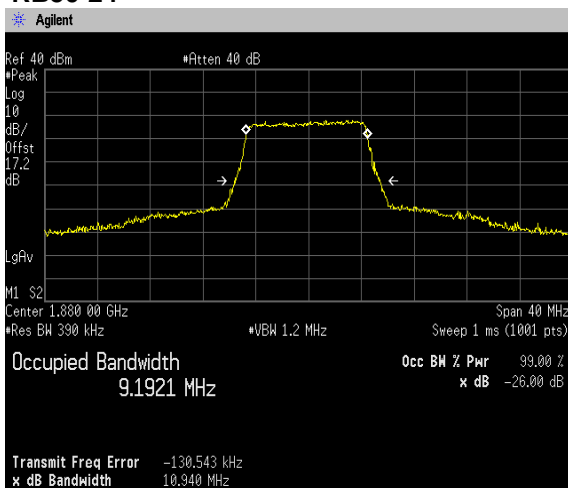

RB100-0

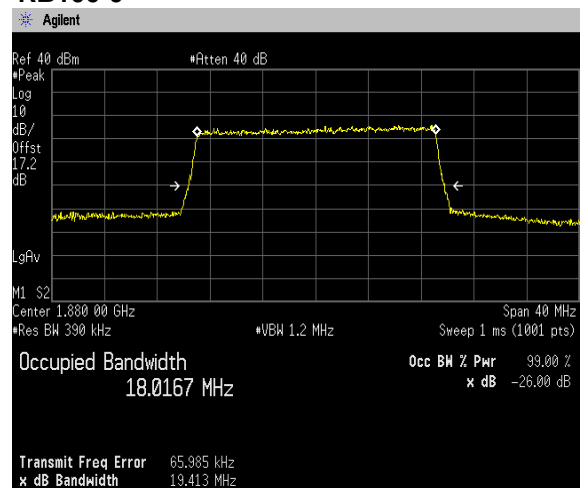

64QAM, BW 20MHz
RB50-24

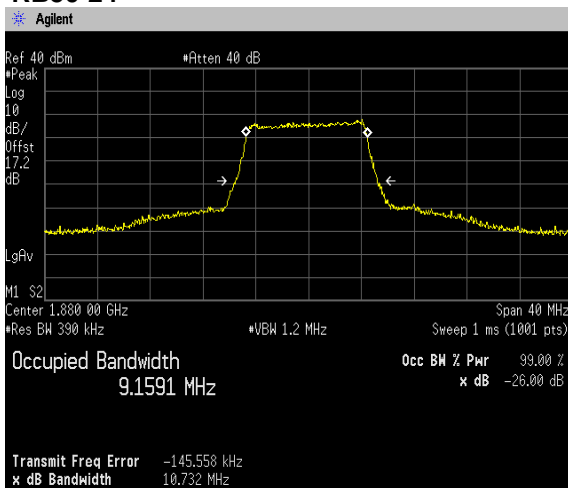

RB100-0

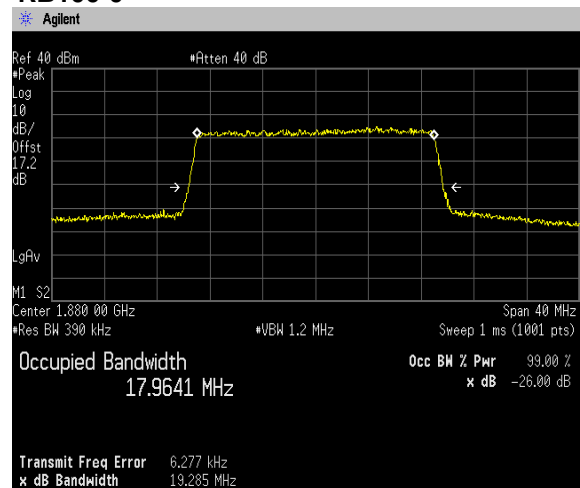

4.4 Band Edge Spurious and Harmonic at Antenna Terminals

4.4.1 Measurement procedure

[FCC 24.238(a), 2.1051]

The band edge spurious and harmonic was measured with a spectrum analyzer connected to the antenna terminal.

The spectrum analyzer is set to;

<Band Edge>

- Span was set large enough so as to capture all out of band emissions near the band edge
- $RBW \geq 1\%$ of the emission bandwidth or 2% of the emission bandwidth
- $VBW \geq 3 \times RBW$
- Detector = RMS
- Trace mode = Max hold
- Sweep time = auto-couple
- Number of sweep point $\geq 2 \times \text{span} / RBW$

<Spurious Emissions>

- $RBW = 1\text{MHz}$ & $VBW \geq 3 \times RBW$
- Detector = Peak
- Trace mode = Max hold
- Sweep time = auto-couple
- Number of sweep point $\geq 2 \times \text{span} / RBW$

- Test configuration

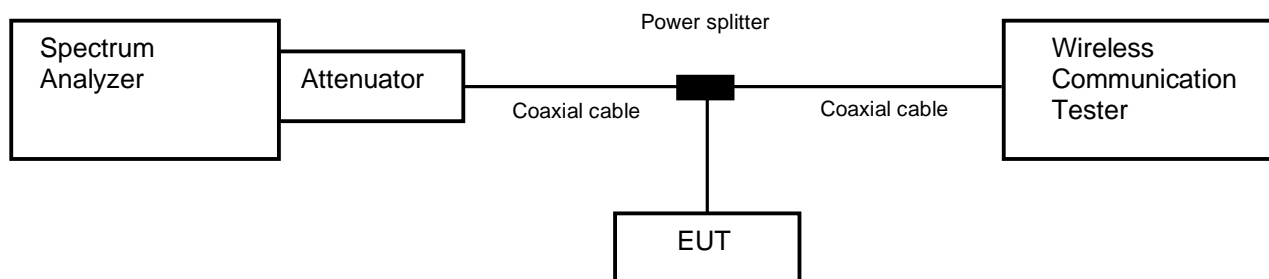

4.4.2 Limit

-13 dBm or less



4.4.3 Measurement result

Date : 28-April-2022
 Temperature : 22.9 [°C]
 Humidity : 36.1 [%]
 Test place : Shielded room No.4
 Test engineer : Tadahiro Seino

Date : 10-May-2022
 Temperature : 20.9 [°C]
 Humidity : 32.7 [%]
 Test place : Shielded room No.4
 Test engineer : Chiaki Kanno

Band	Channel	Frequency [MHz]	Limit [dBm]	Results	
GSM1900	512	1850.2	-13.0	See the trace data	PASS
	810	1909.8	-13.0	See the trace data	PASS
WCDMA Band II	9262	1852.4	-13.0	See the trace data	PASS
	9538	1907.6	-13.0	See the trace data	PASS

Band	Modulation	Bandwidth [MHz]	Channel	Frequency [MHz]	Limit [dBm]	Results	
LTE Band II	QPSK, 16QAM, 64QAM	1.4	18607	1850.7	-13.0	See the trace data	PASS
			19193	1909.3	-13.0	See the trace data	PASS
		3	18615	1851.5	-13.0	See the trace data	PASS
			19185	1908.5	-13.0	See the trace data	PASS
		5	18625	1852.5	-13.0	See the trace data	PASS
			19175	1907.5	-13.0	See the trace data	PASS
		10	18650	1855.0	-13.0	See the trace data	PASS
			19150	1905.0	-13.0	See the trace data	PASS
		15	18675	1857.5	-13.0	See the trace data	PASS
			19125	1902.5	-13.0	See the trace data	PASS
		20	18700	1860.0	-13.0	See the trace data	PASS
			19100	1900.0	-13.0	See the trace data	PASS

4.4.4 Trace data

[GSM1900]
(Band Edge)

Channel: 512

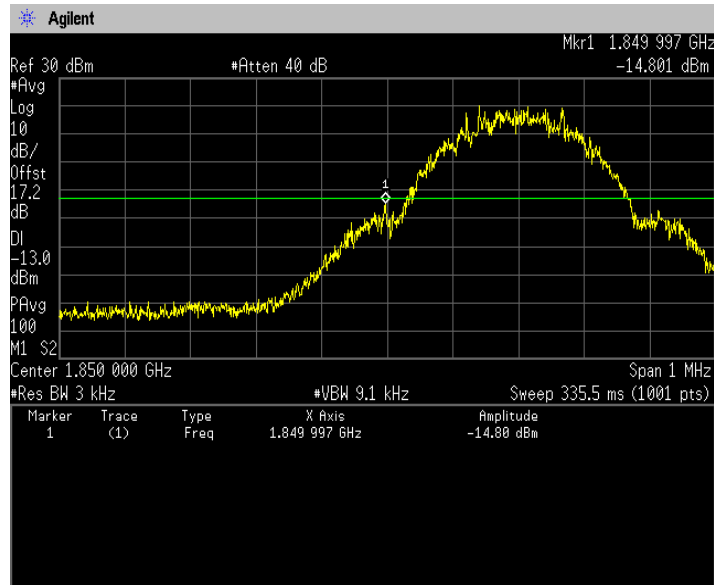

Channel: 810

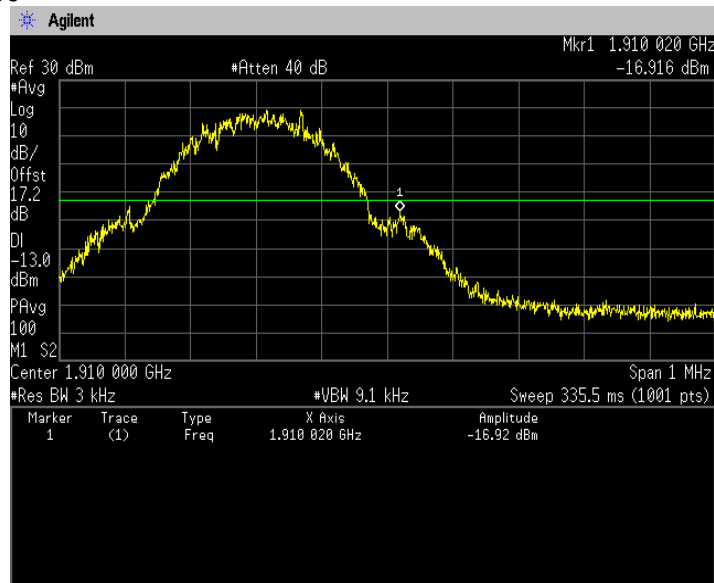

(Spurious Emissions)

Note: Conducted spurious test was measured in the worst case of conducted output power.

**Channel: 512
30MHz-5GHz**

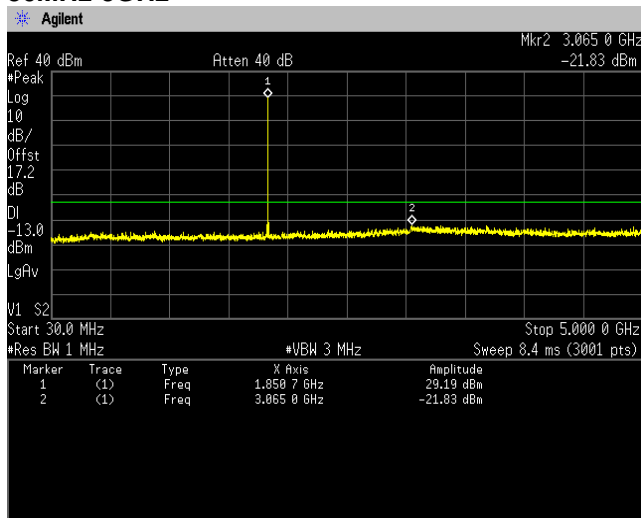

5GHz-10GHz

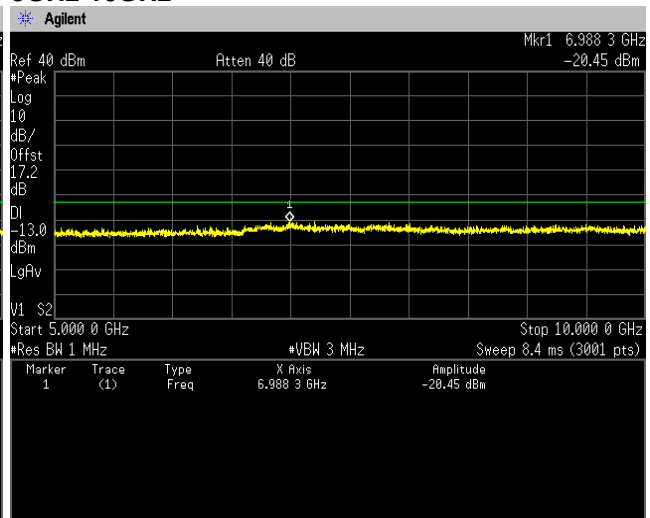

10GHz-15GHz

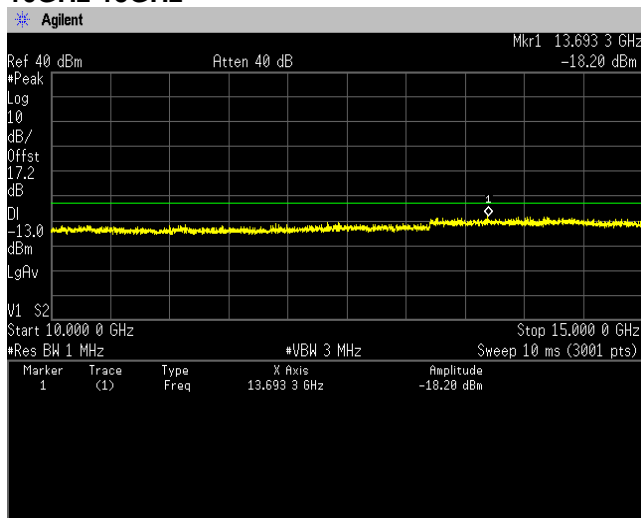

15GHz-20GHz

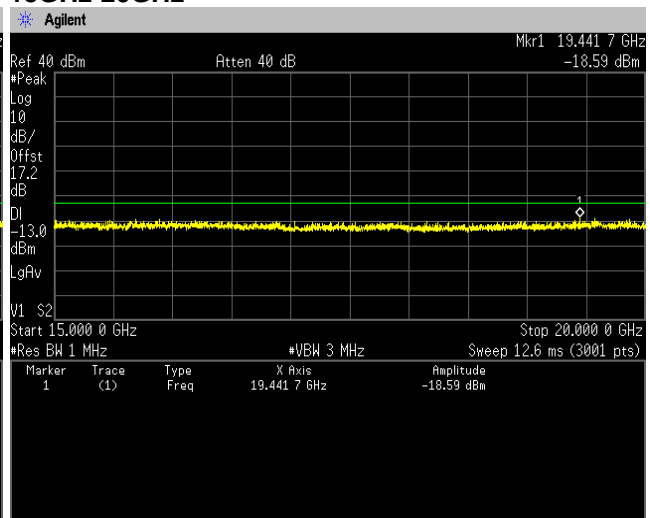



Channel: 661
30MHz-5GHz

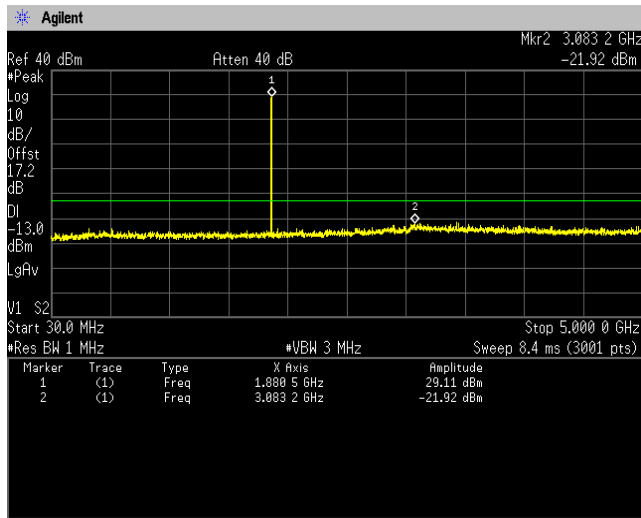

5GHz-10GHz

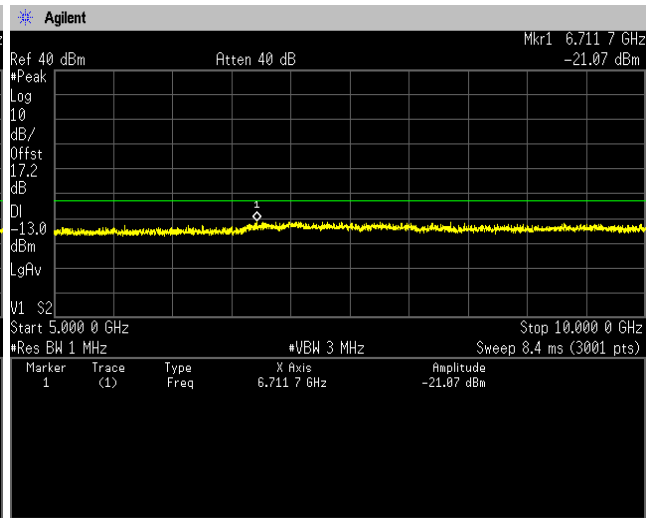

10GHz-15GHz

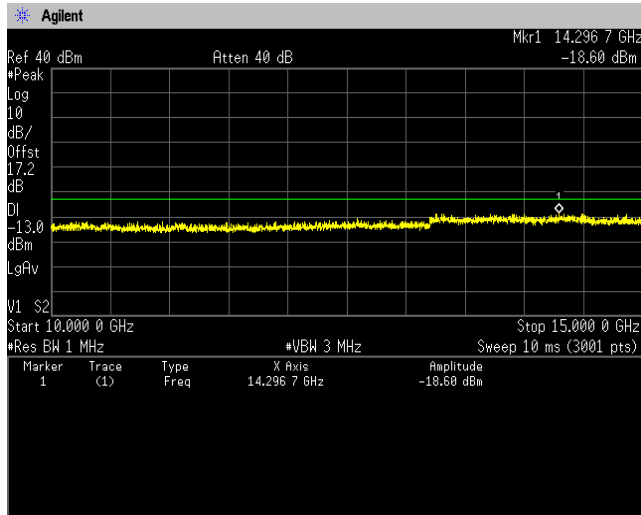

15GHz-20GHz

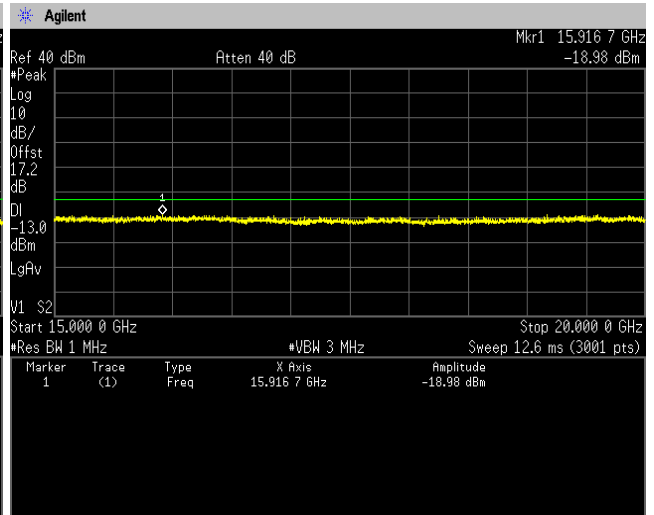



Channel: 810
30MHz-5GHz

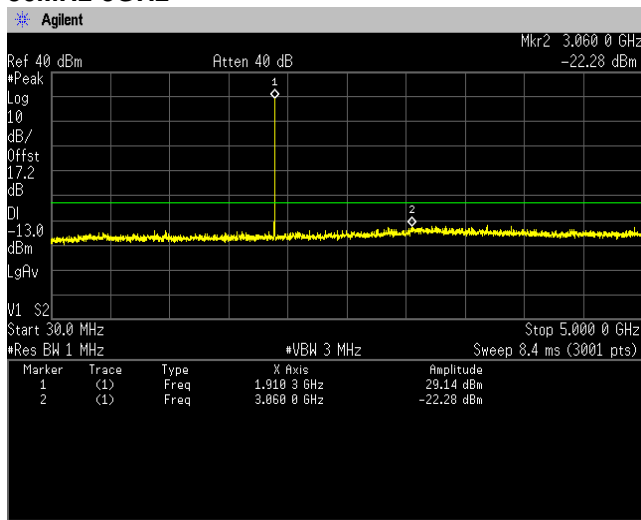

5GHz-10GHz

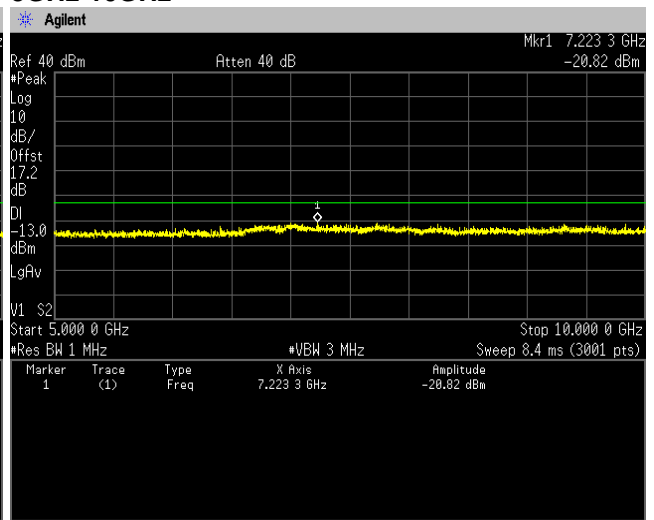

10GHz-15GHz

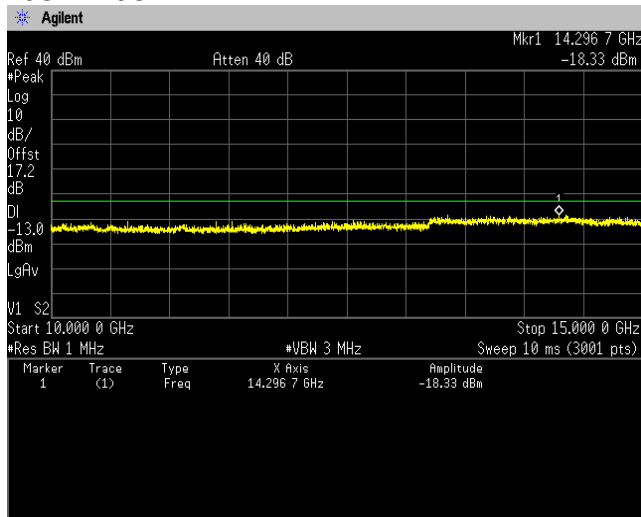

15GHz-20GHz

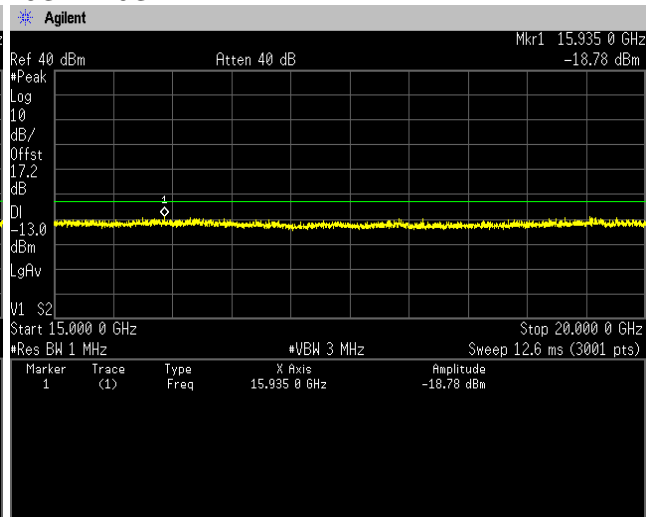



**[WCDMA Band II]
(Band Edge)
Channel: 9262**

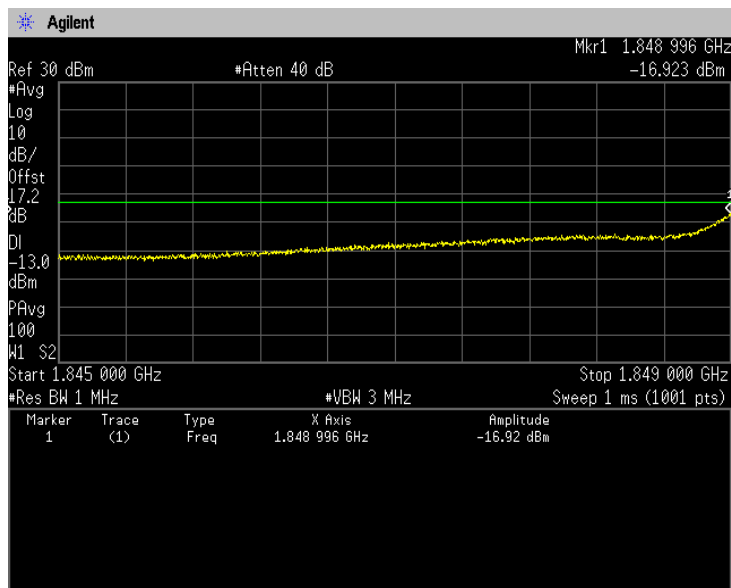
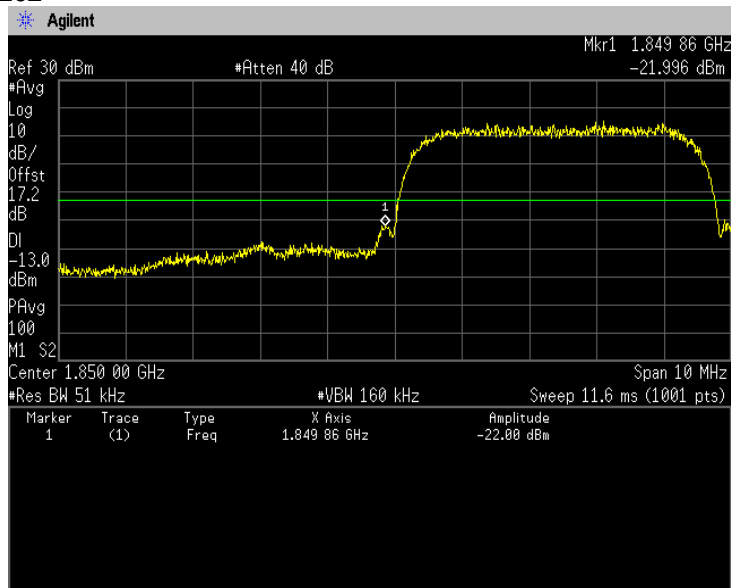



Channel: 9538

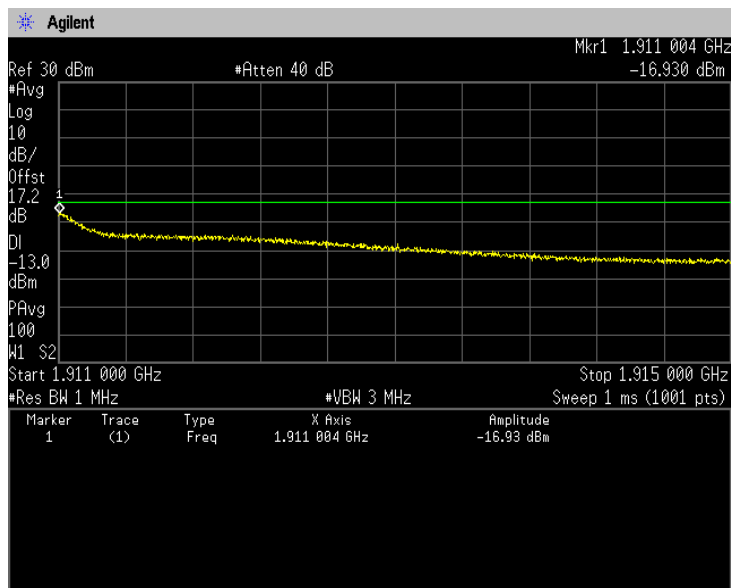
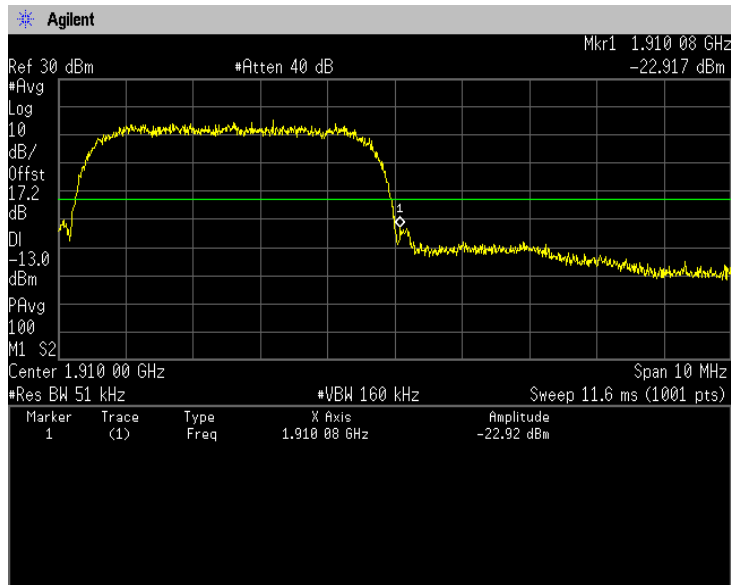



(Spurious Emissions)

Note: Conducted spurious test was measured in the worst case of conducted output power.

**Channel: 9262
30MHz-5GHz**

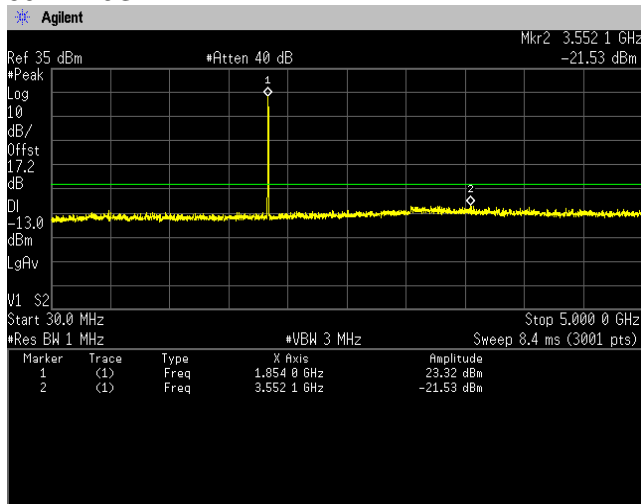

5GHz-10GHz

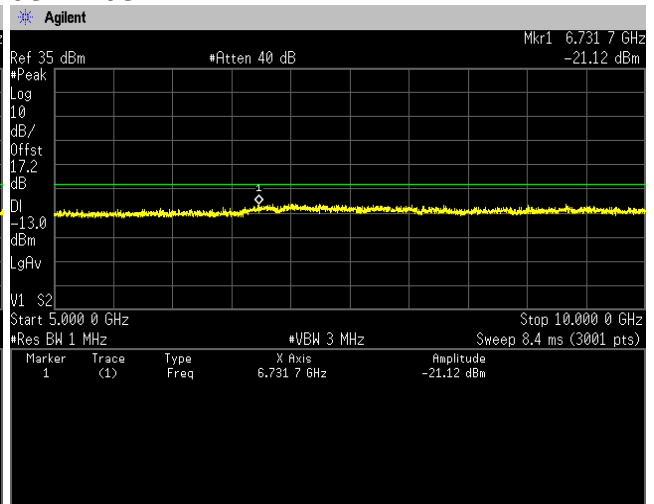

10GHz-15GHz

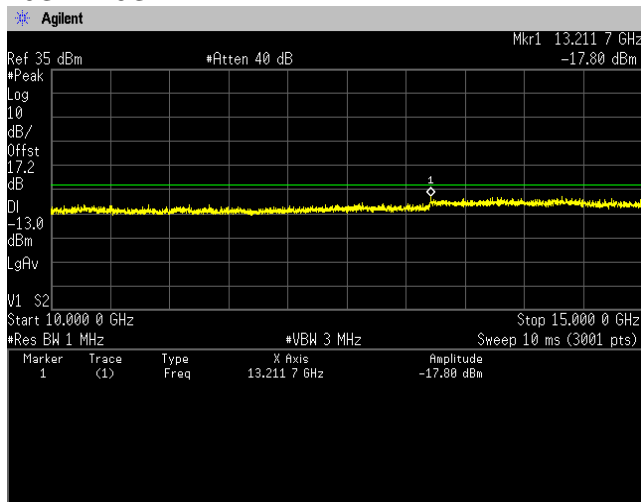

15GHz-20GHz

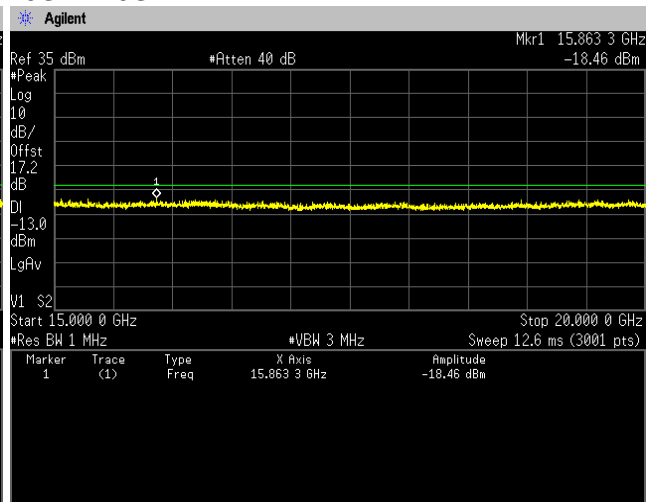



Channel: 9400
30MHz-5GHz

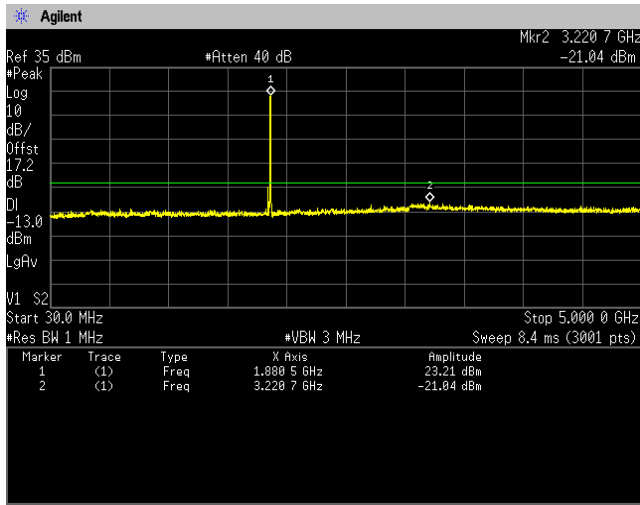

5GHz-10GHz

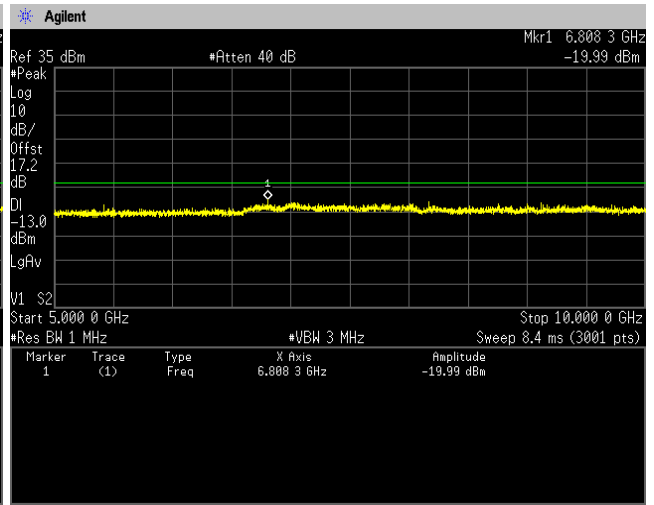

10GHz-15GHz

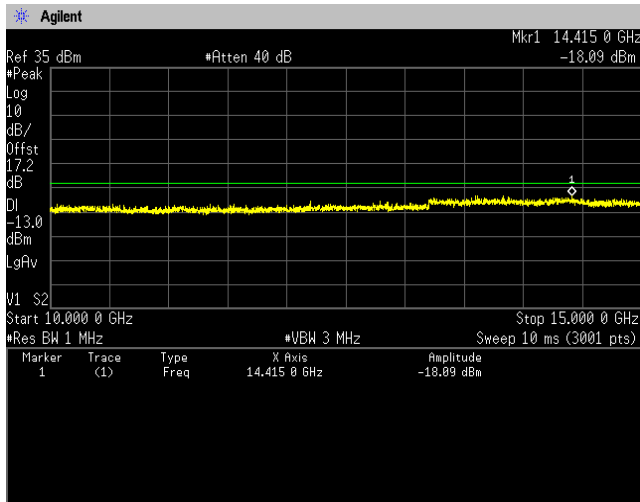

15GHz-20GHz

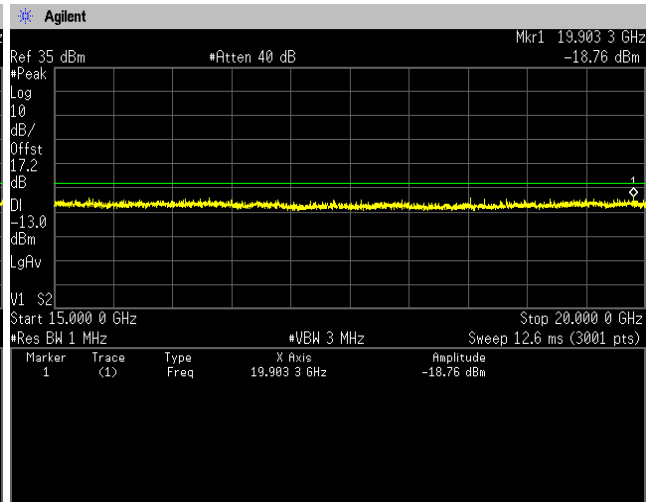



Channel: 9538
30MHz-5GHz

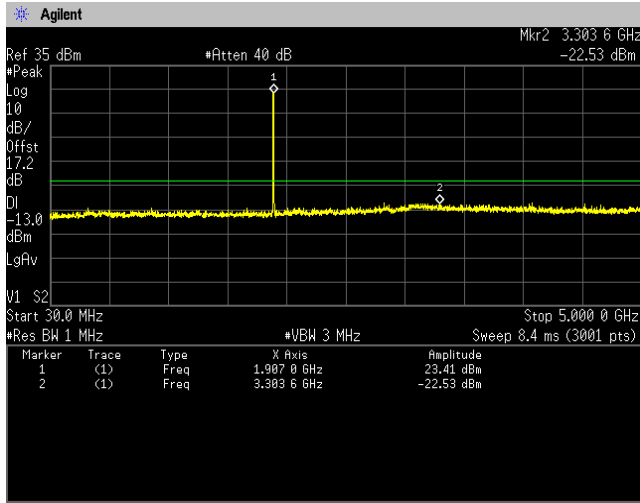

5GHz-10GHz

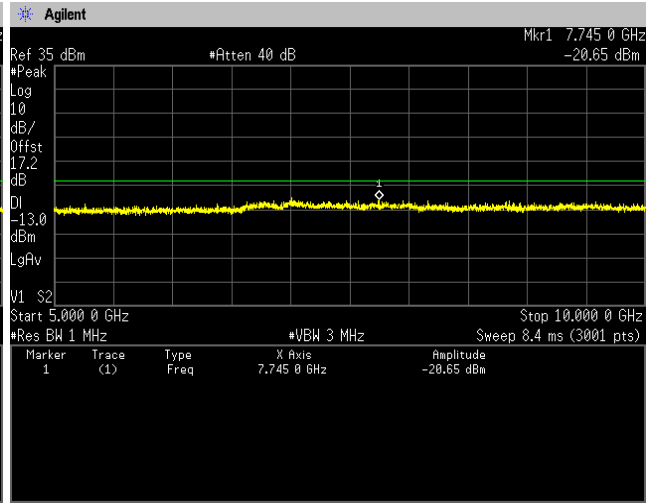

10GHz-15GHz

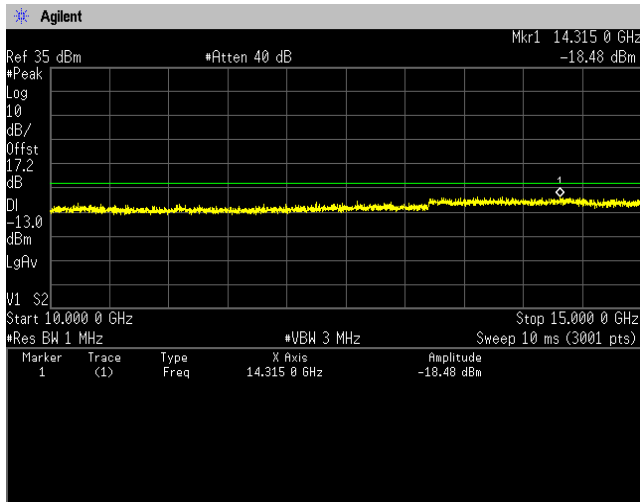

15GHz-20GHz

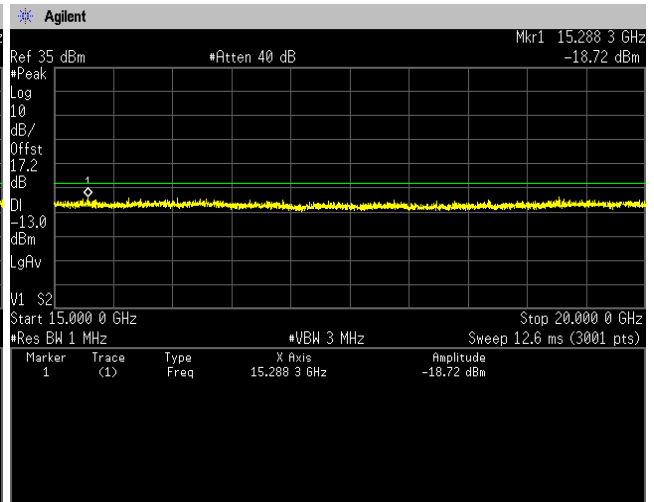



**[LTE Band II]
(Band Edge)
QPSK, BW 1.4MHz, RB1-0
Channel: Low**

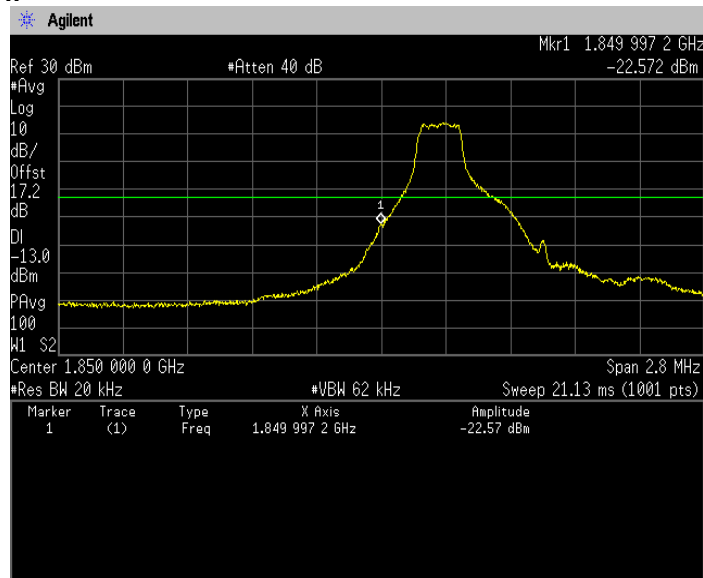

**QPSK, BW 1.4MHz, RB1-5
Channel: High**

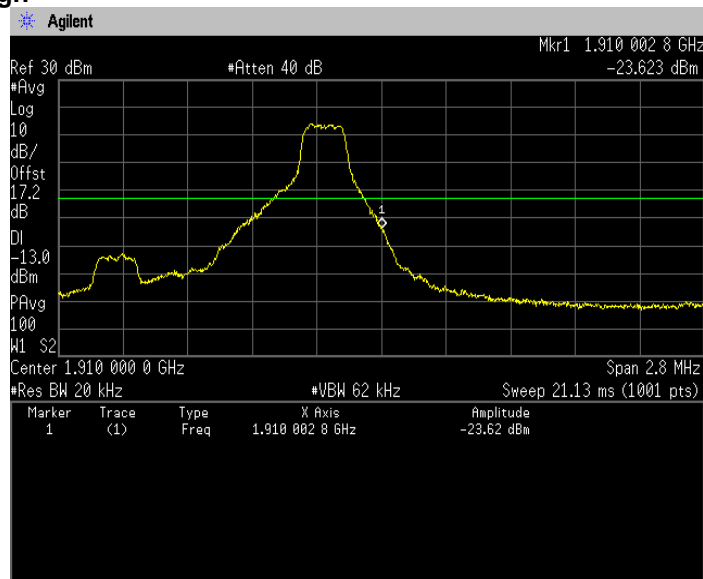



QPSK, BW 1.4MHz, RB6-0
Channel: Low

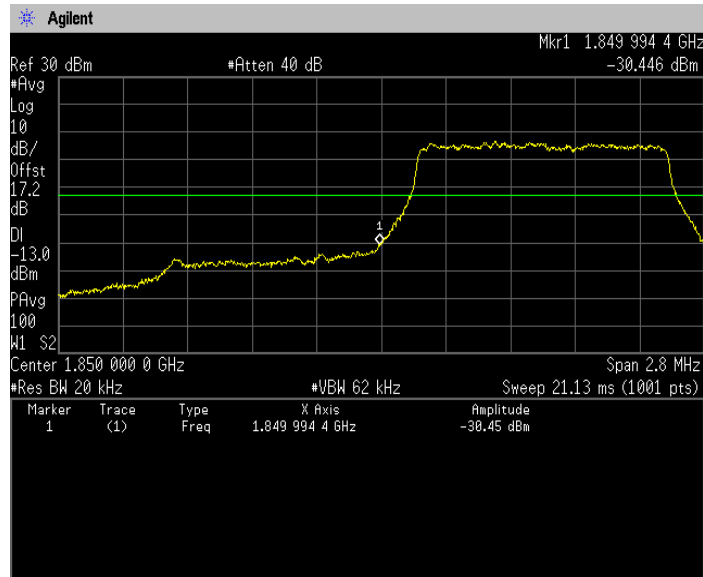

QPSK, BW 1.4MHz, RB6-0
Channel: High

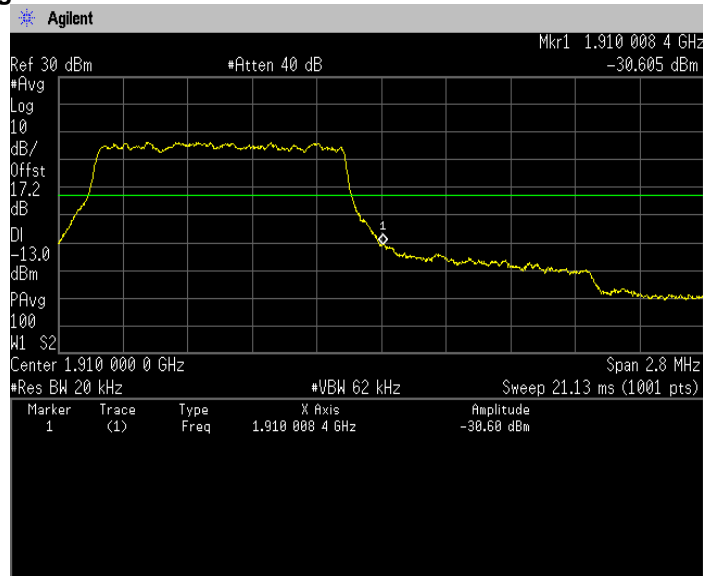

QPSK, BW 3MHz, RB1-0
Channel: Low

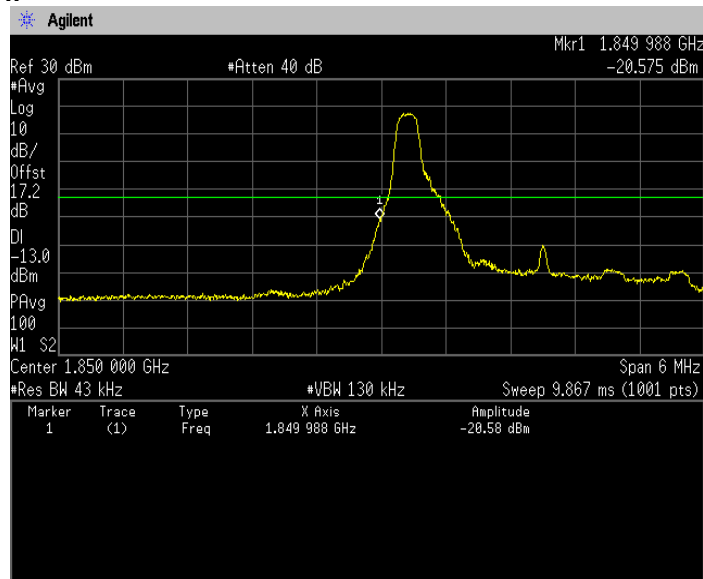

QPSK, BW 3MHz, RB1-14
Channel: High

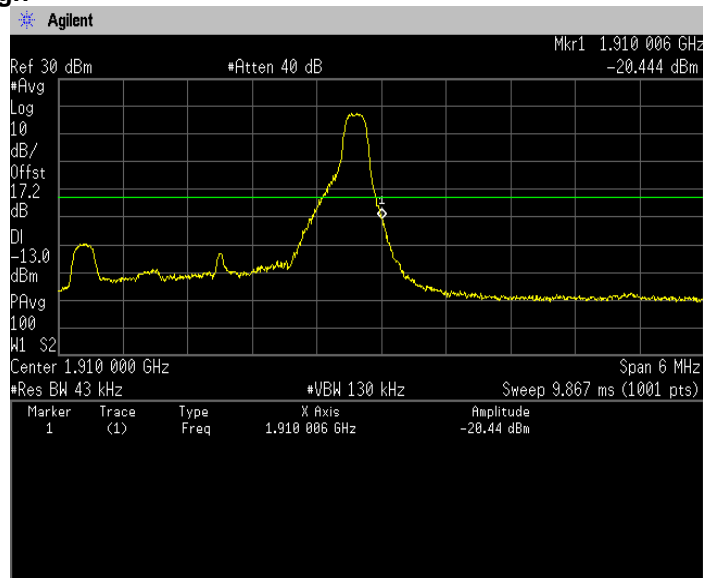



QPSK, BW 3MHz, RB15-0
Channel: Low

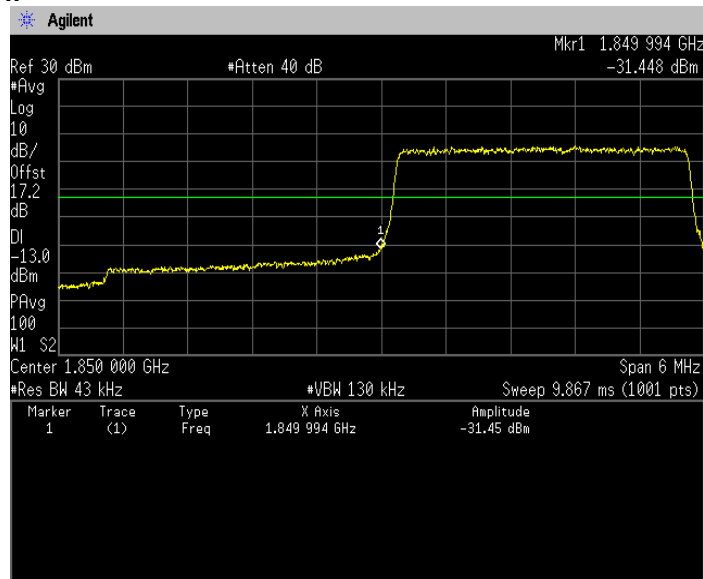

QPSK, BW 3MHz, RB15-0
Channel: High

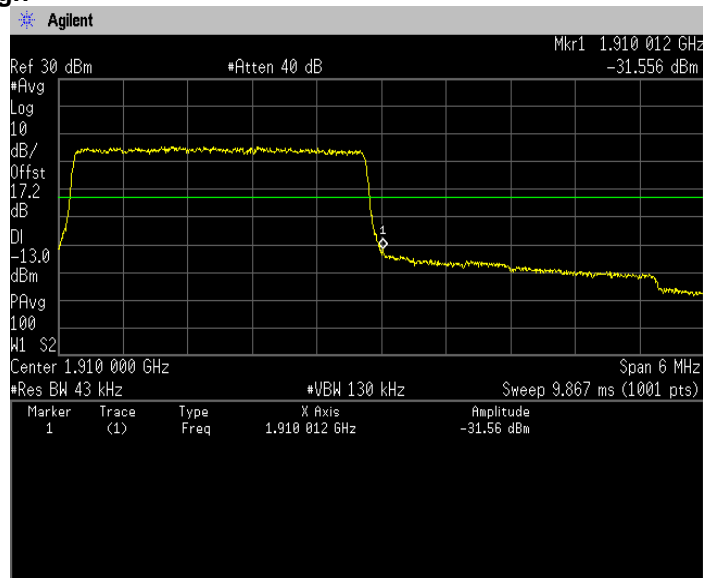

QPSK, BW 5MHz, RB1-0
Channel: Low

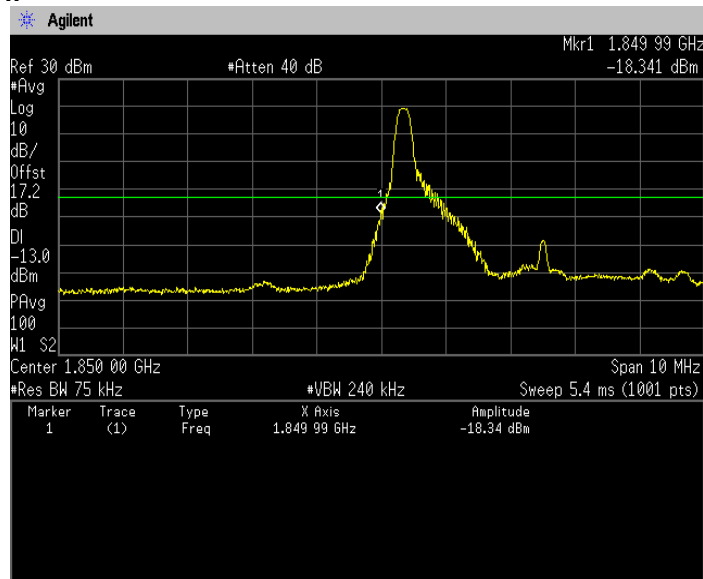

QPSK, BW 5MHz, RB1-24
Channel: High

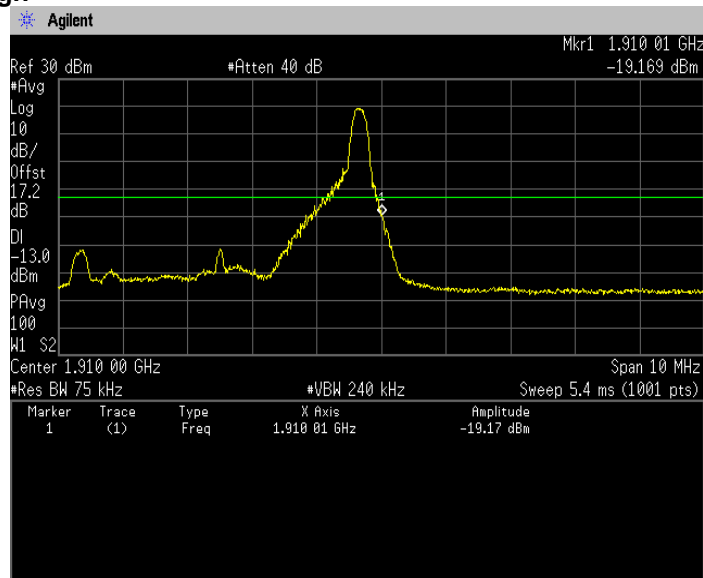



QPSK, BW 5MHz, RB25-0
Channel: Low

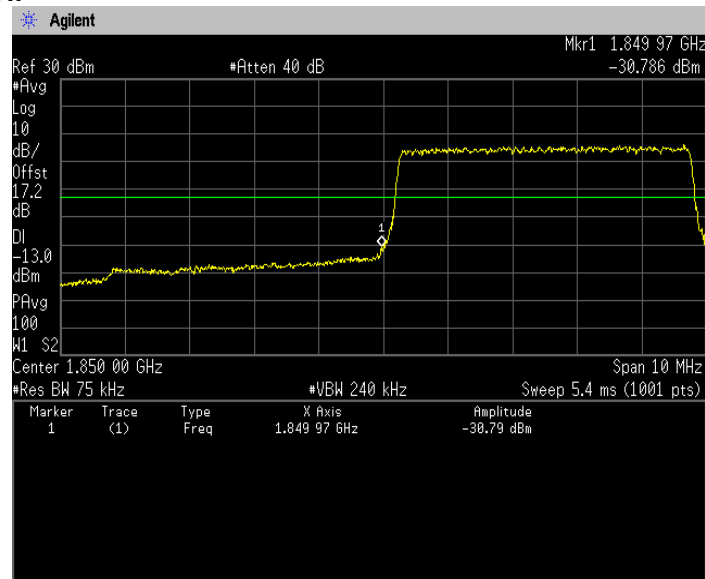

QPSK, BW 5MHz, RB25-0
Channel: High

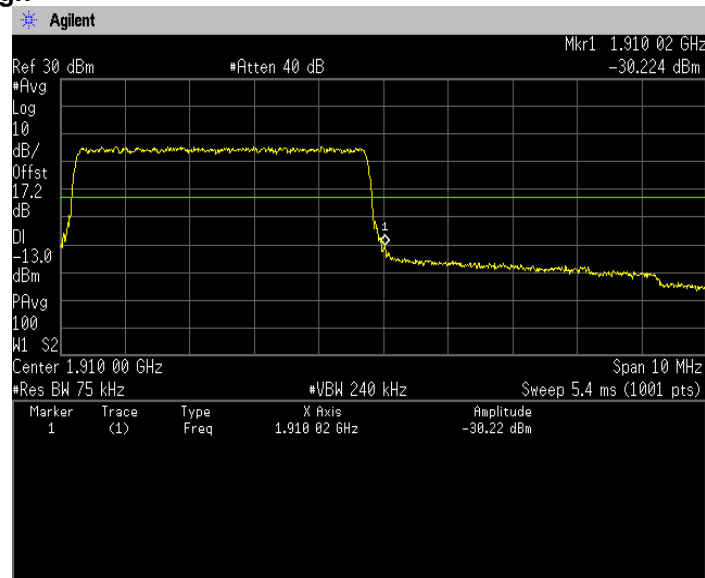



QPSK, BW 10MHz, RB1-0
Channel: Low

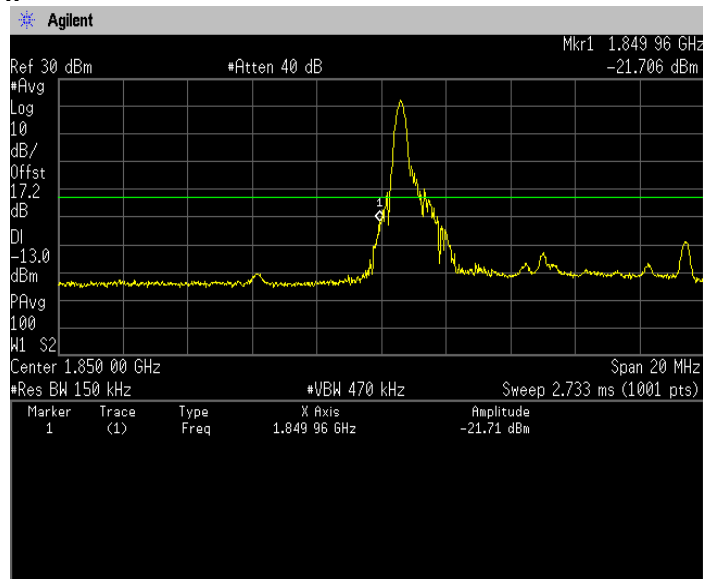

QPSK, BW 10MHz, RB1-49
Channel: High

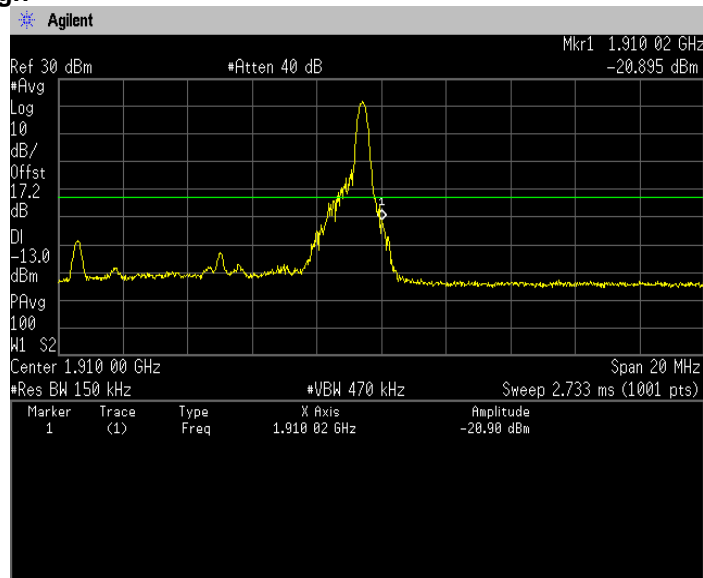



QPSK, BW 10MHz, RB50-0
Channel: Low

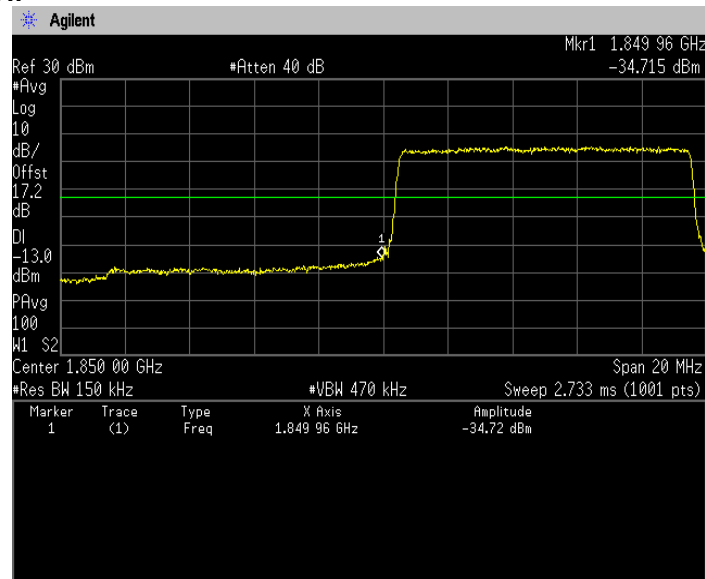

QPSK, BW 10MHz, RB50-0
Channel: High

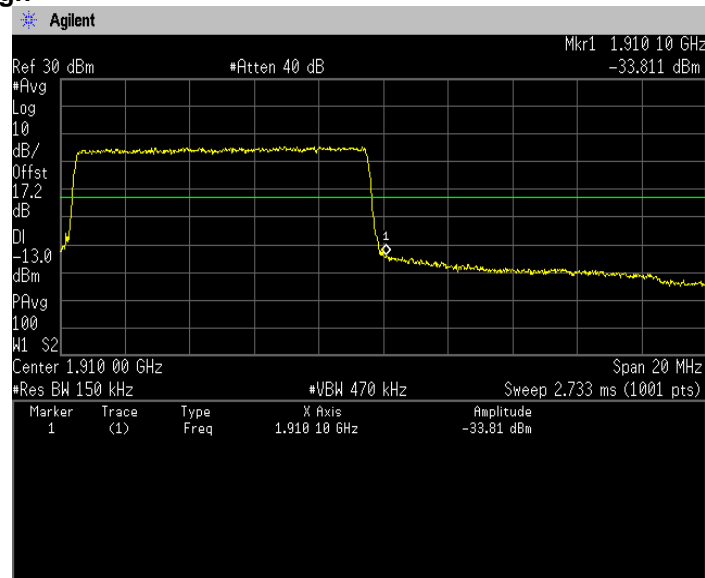

QPSK, BW 15MHz, RB1-0
Channel: Low

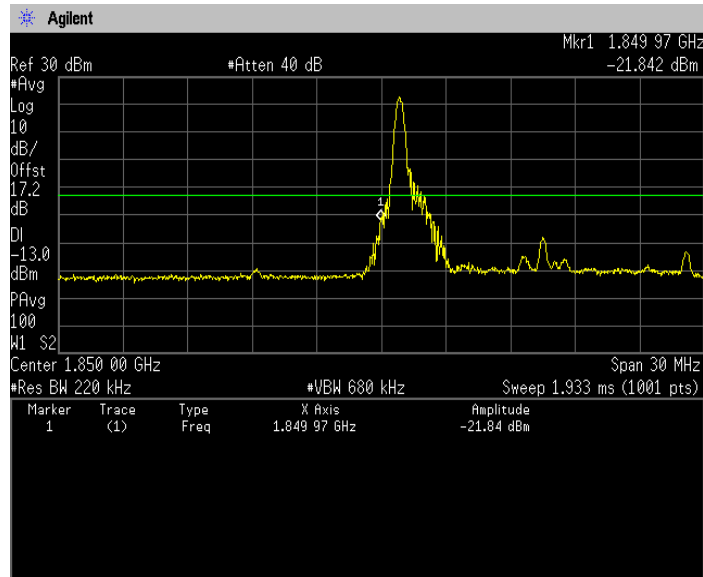

QPSK, BW 15MHz, RB1-74
Channel: High

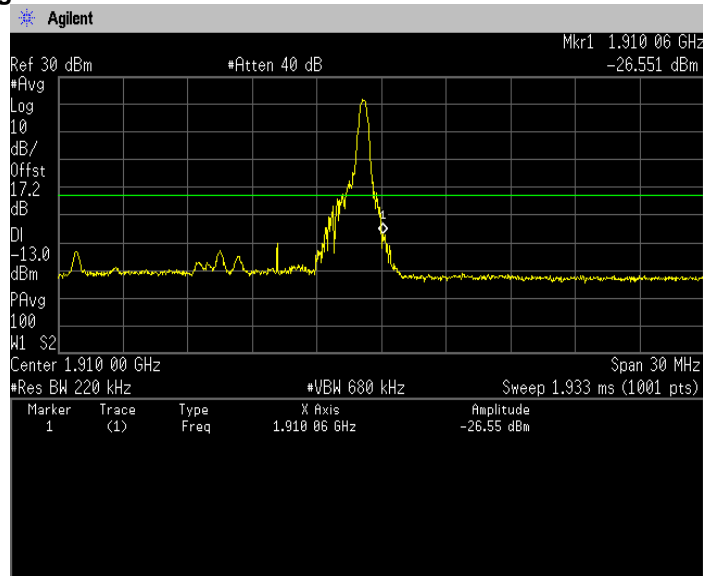



QPSK, BW 15MHz, RB75-0
Channel: Low

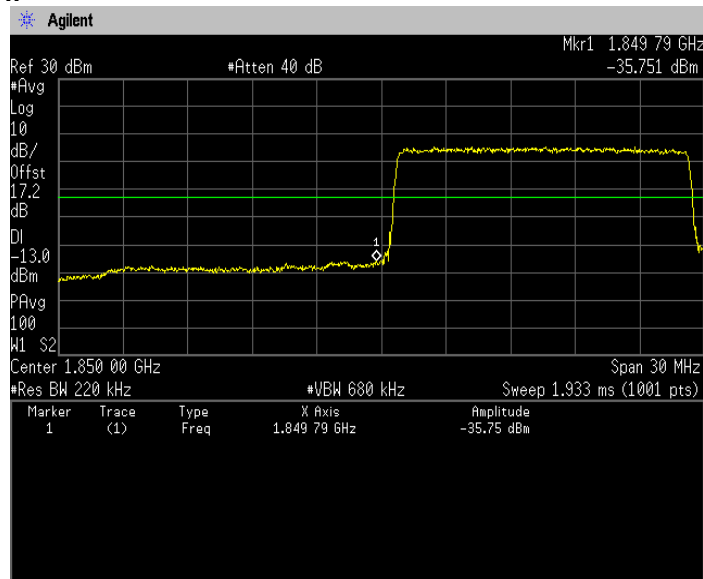

QPSK, BW 15MHz, RB75-0
Channel: High

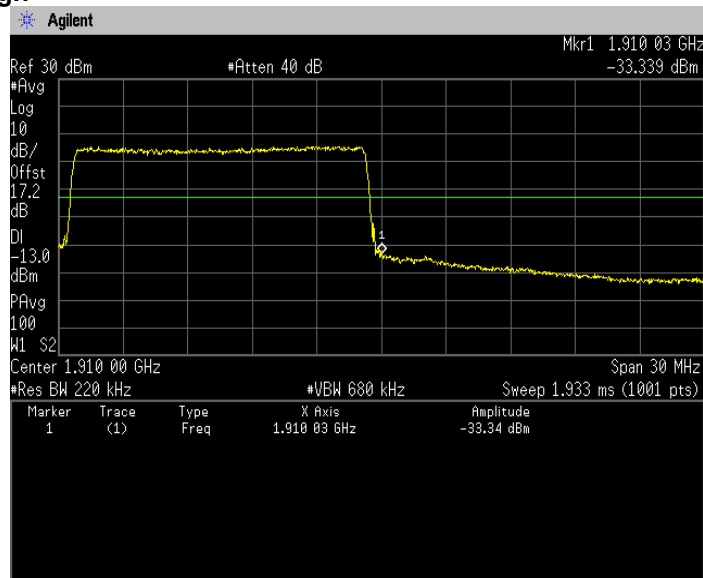

QPSK, BW 20MHz, RB1-0
Channel: Low

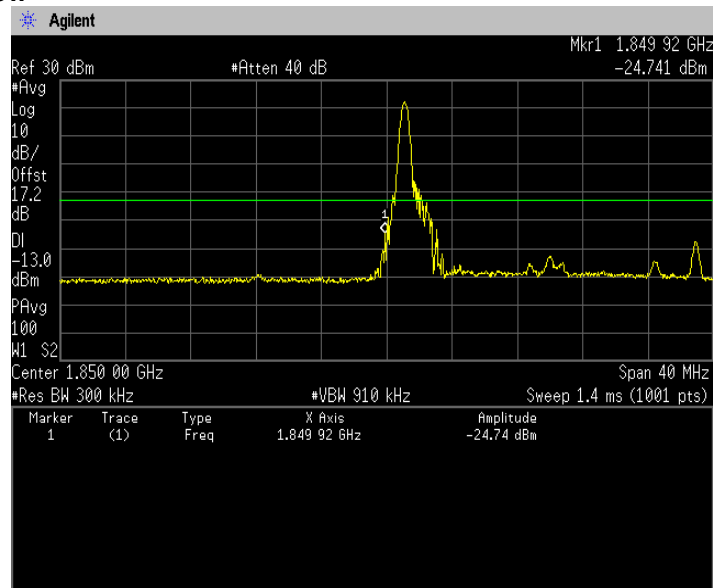

QPSK, BW 20MHz, RB1-99
Channel: High

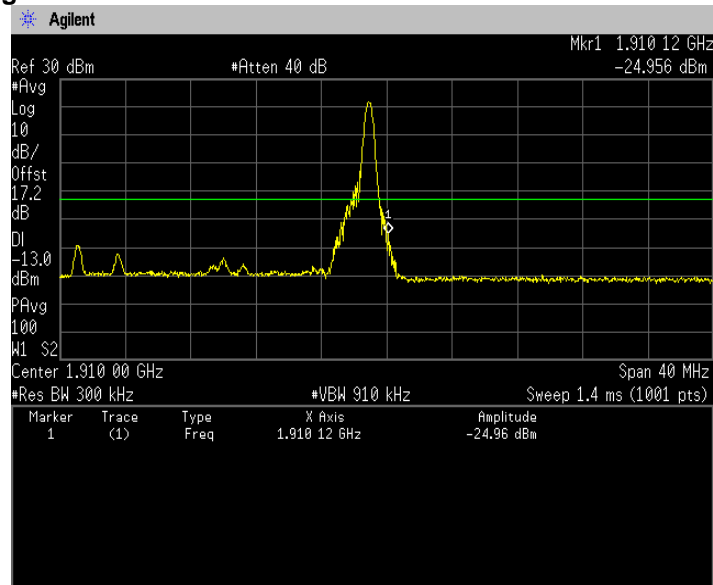



QPSK, BW 20MHz, RB100-0
Channel: Low

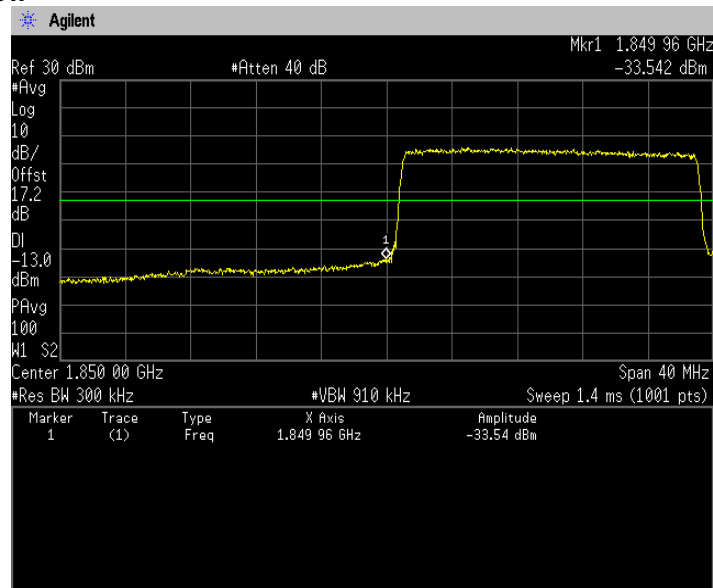

QPSK, BW 20MHz, RB100-0
Channel: High

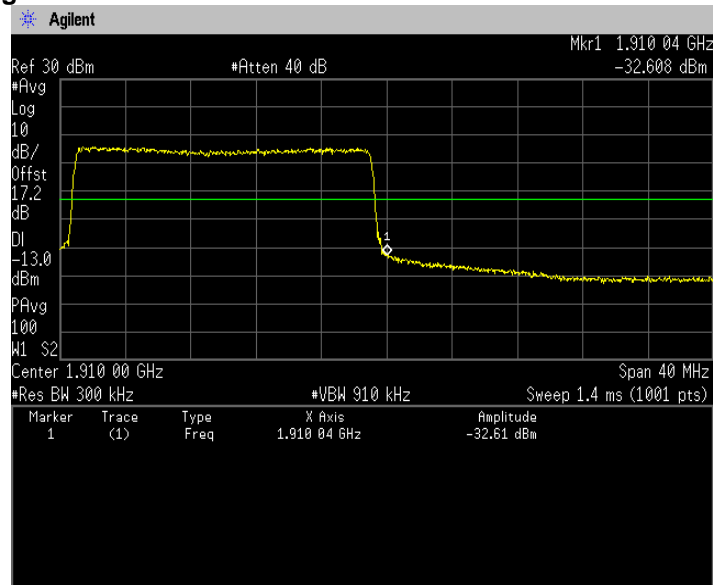



16QAM, BW 1.4MHz, RB1-0
Channel: Low

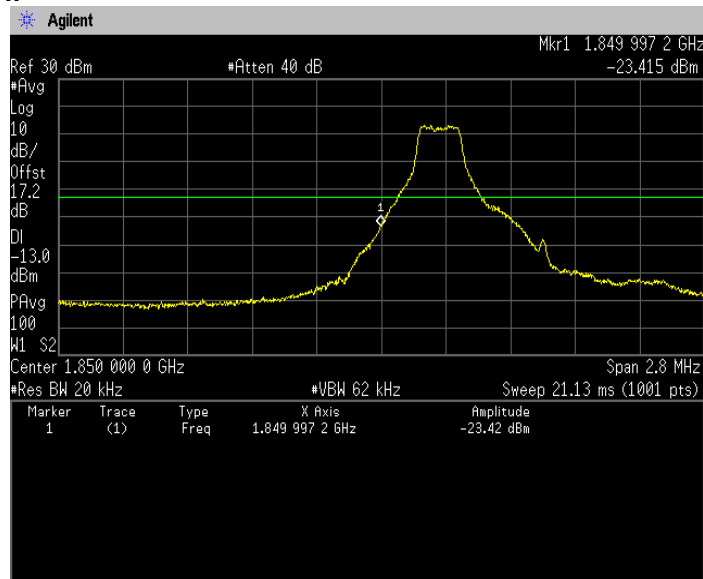

16QAM, BW 1.4MHz, RB1-5
Channel: High

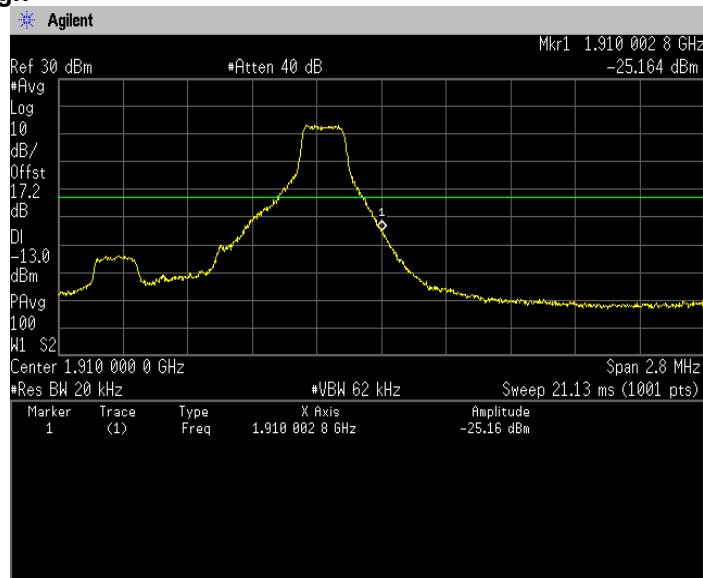



16QAM, BW 1.4MHz, RB6-0
Channel: Low

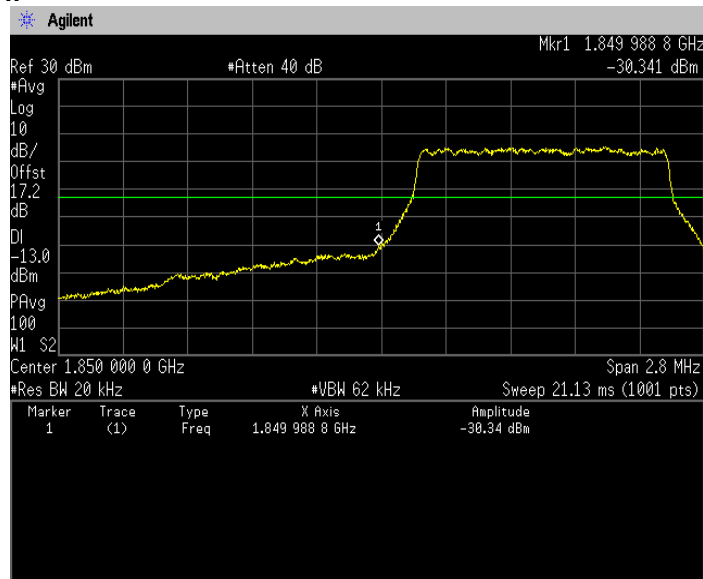

16QAM, BW 1.4MHz, RB6-0
Channel: High

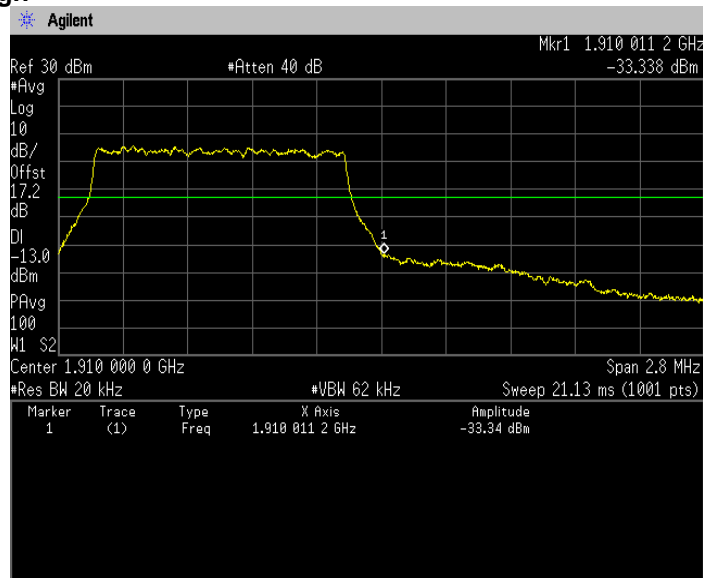

16QAM, BW 3MHz, RB1-0
Channel: Low

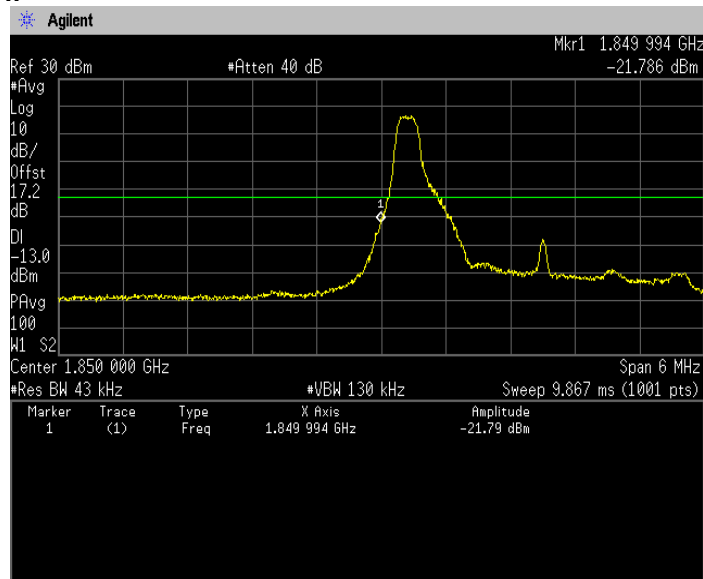

16QAM, BW 3MHz, RB1-14
Channel: High

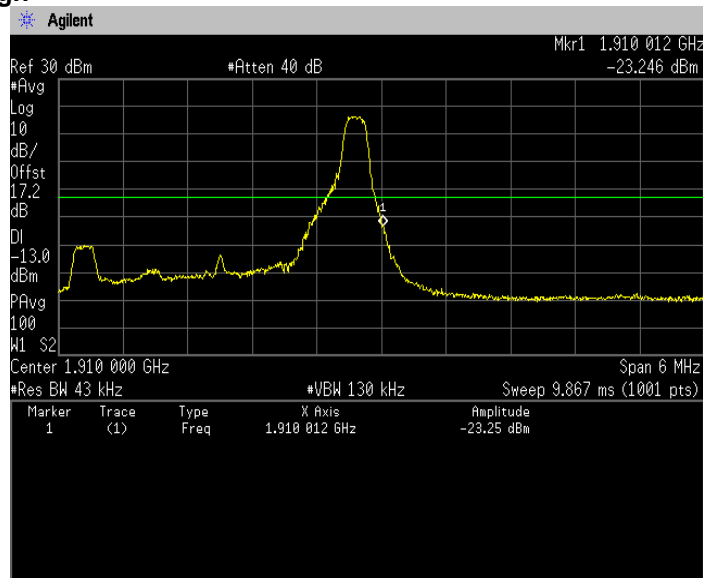



16QAM, BW 3MHz, RB15-0
Channel: Low

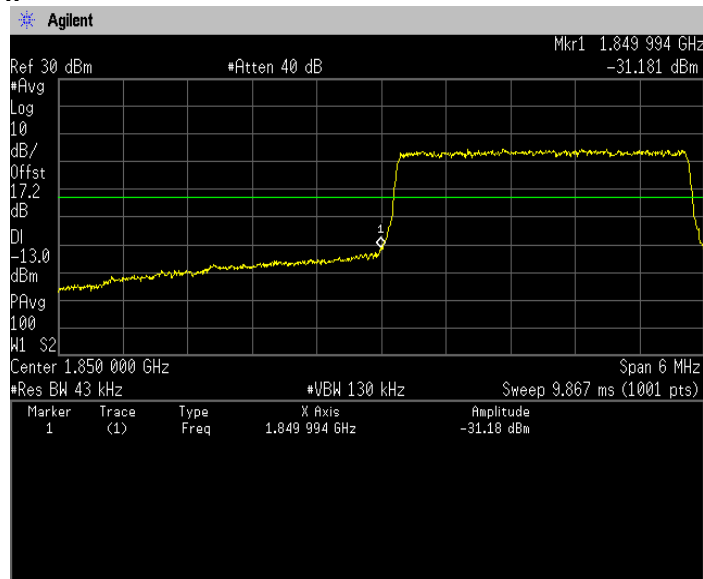

16QAM, BW 3MHz, RB15-0
Channel: High

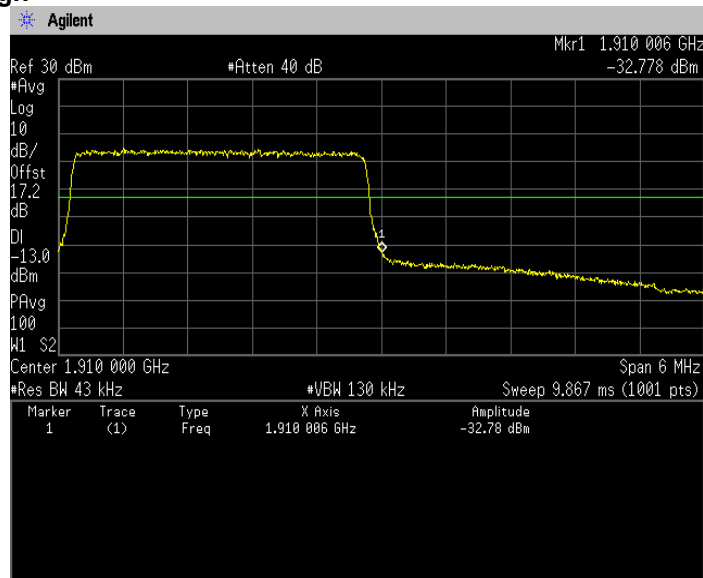



16QAM, BW 5MHz, RB1-0
Channel: Low

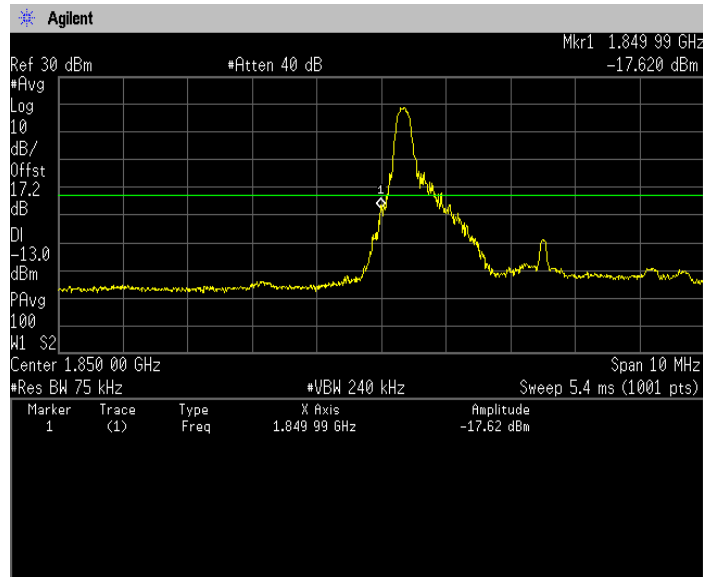

16QAM, BW 5MHz, RB1-24
Channel: High

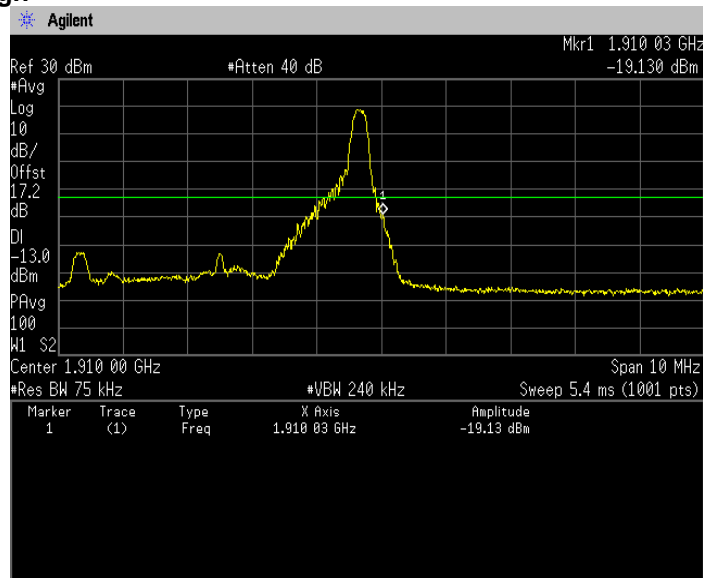



16QAM, BW 5MHz, RB25-0
Channel: Low

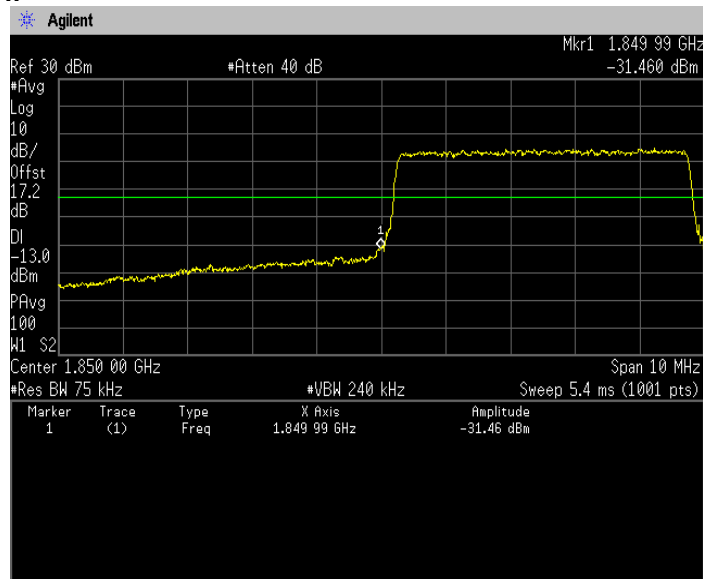

16QAM, BW 5MHz, RB25-0
Channel: High

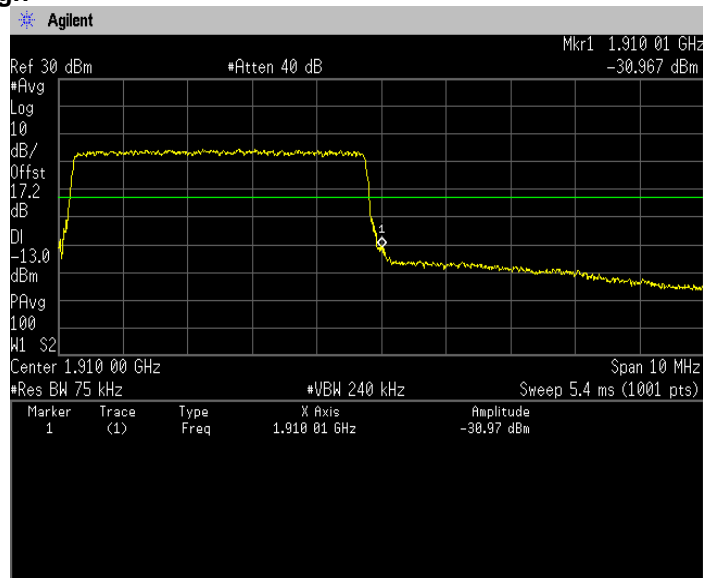



16QAM, BW 10MHz, RB1-0
Channel: Low

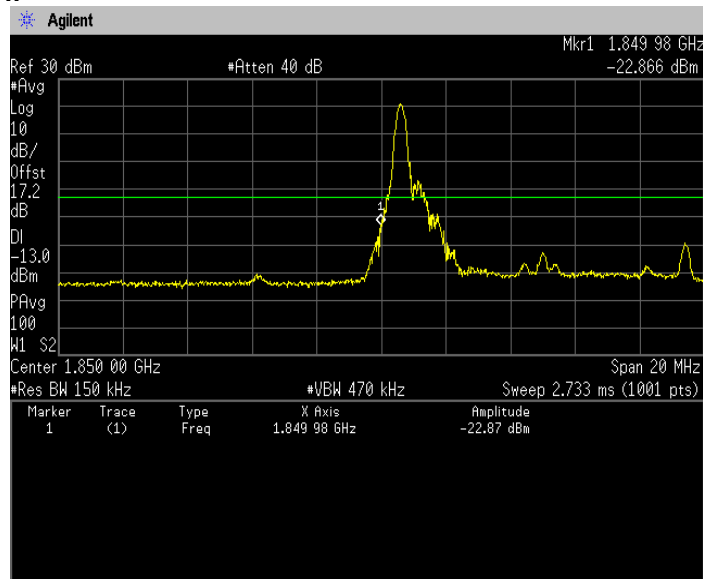

16QAM, BW 10MHz, RB1-49
Channel: High

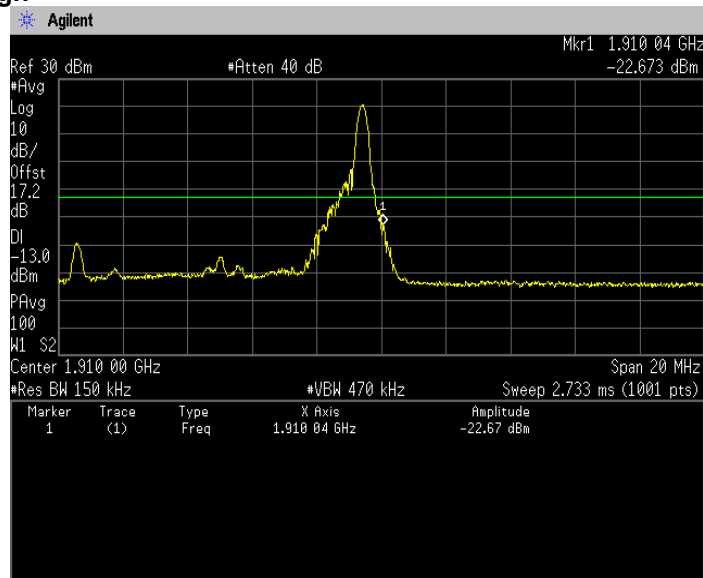



16QAM, BW 10MHz, RB50-0
Channel: Low

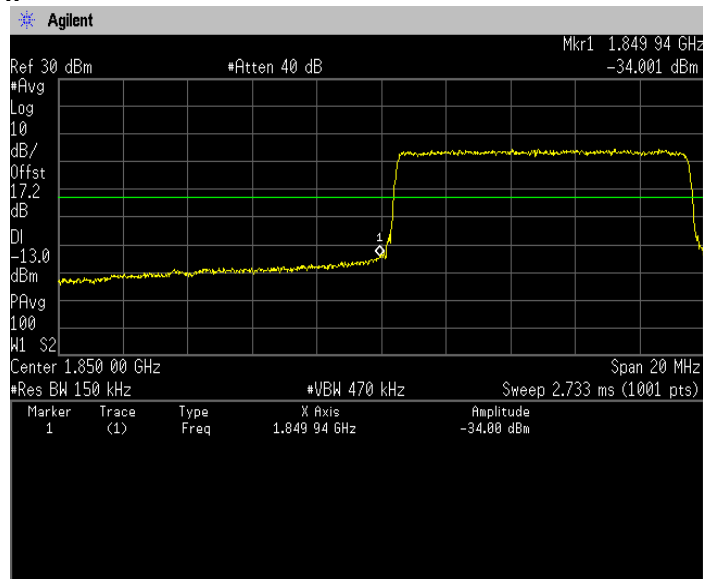

16QAM, BW 10MHz, RB50-0
Channel: High

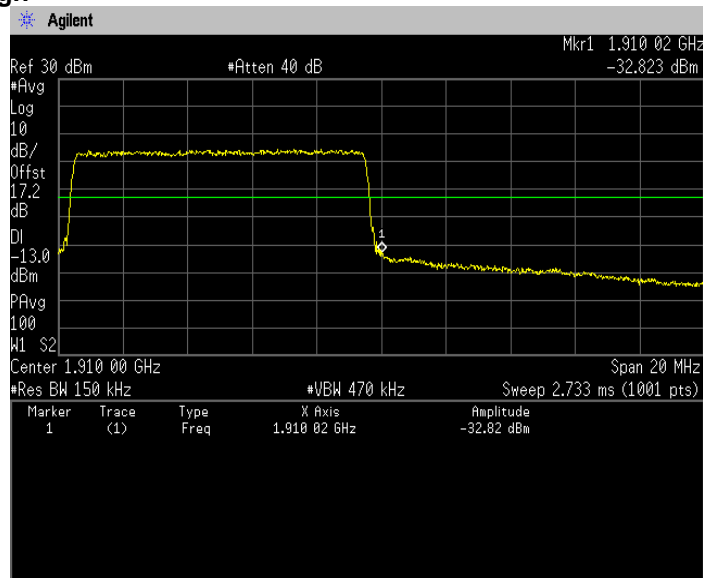



16QAM, BW 15MHz, RB1-0
Channel: Low

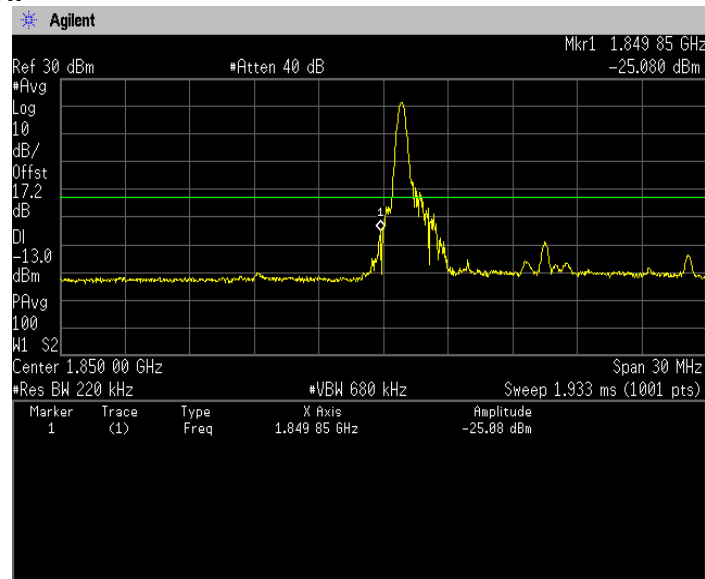

16QAM, BW 15MHz, RB1-74
Channel: High

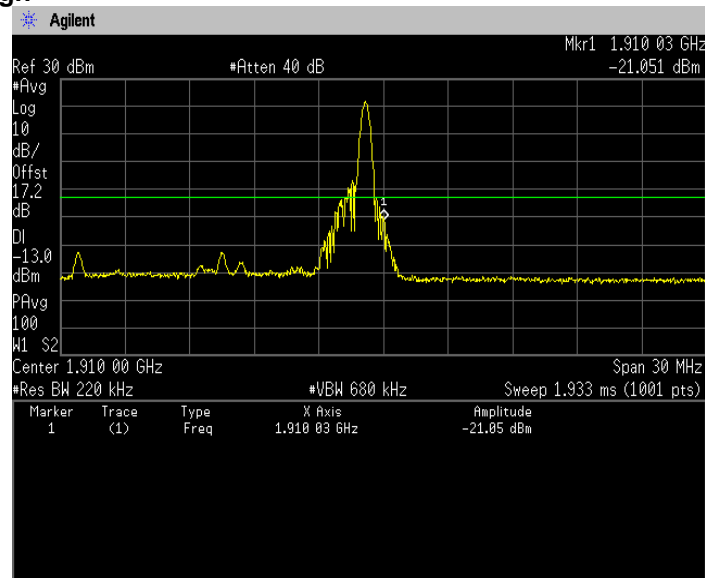



16QAM, BW 15MHz, RB75-0
Channel: Low

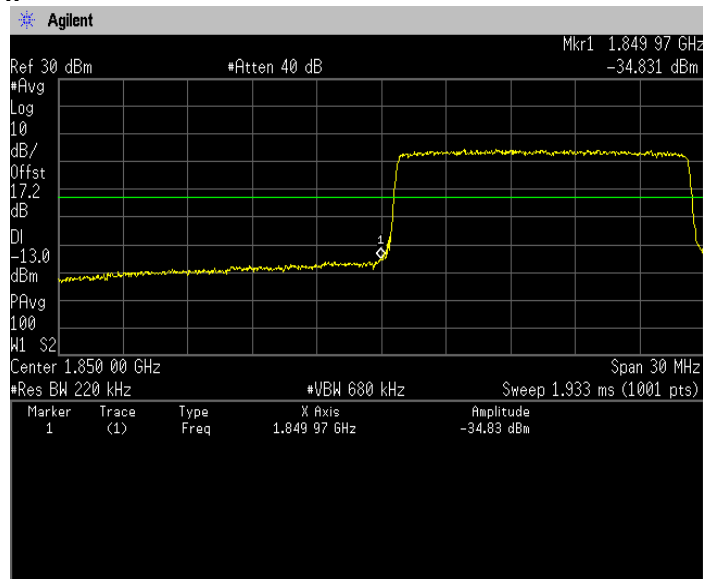

16QAM, BW 15MHz, RB75-0
Channel: High

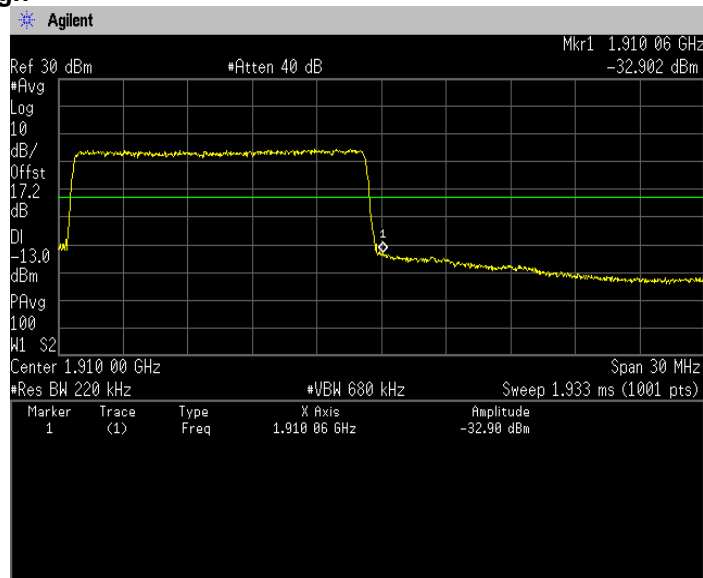



16QAM, BW 20MHz, RB1-0
Channel: Low

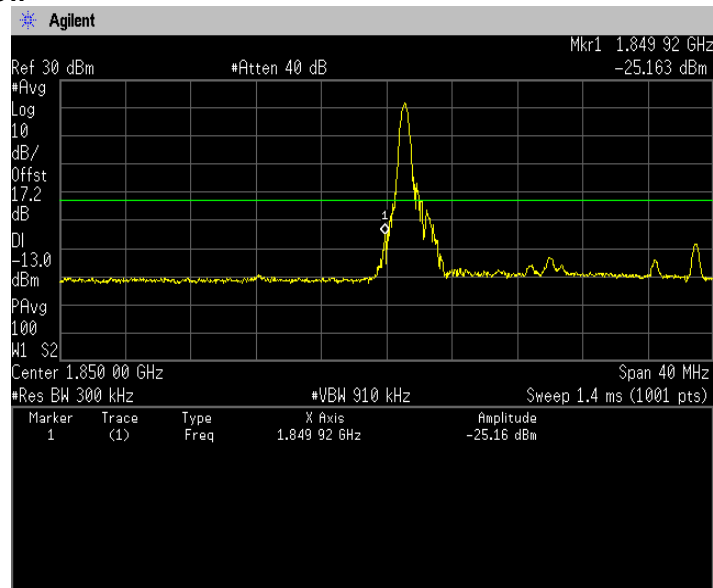

16QAM, BW 20MHz, RB1-99
Channel: High

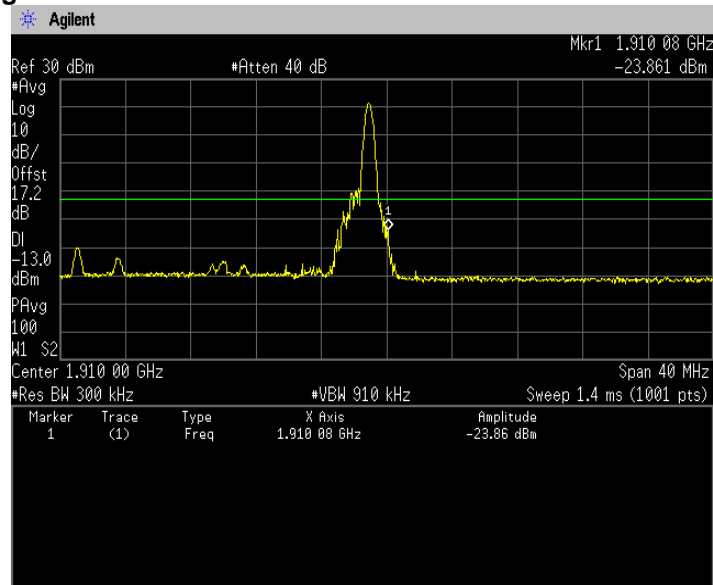



16QAM, BW 20MHz, RB100-0
Channel: Low

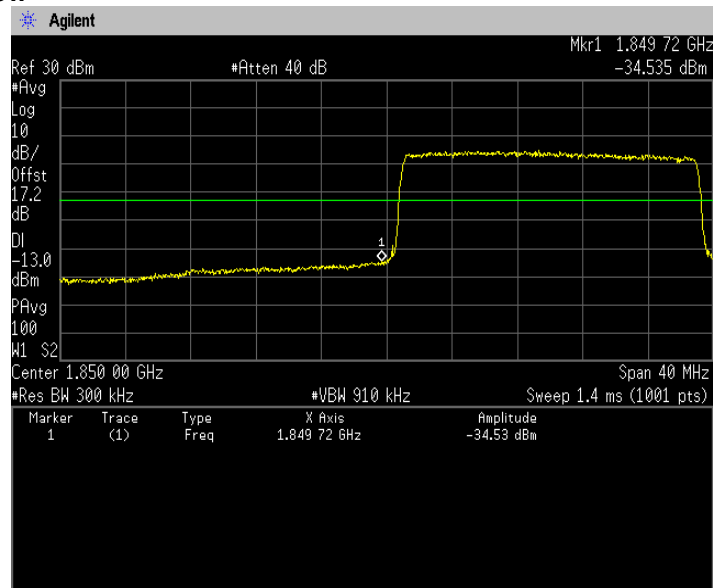

16QAM, BW 20MHz, RB100-0
Channel: High

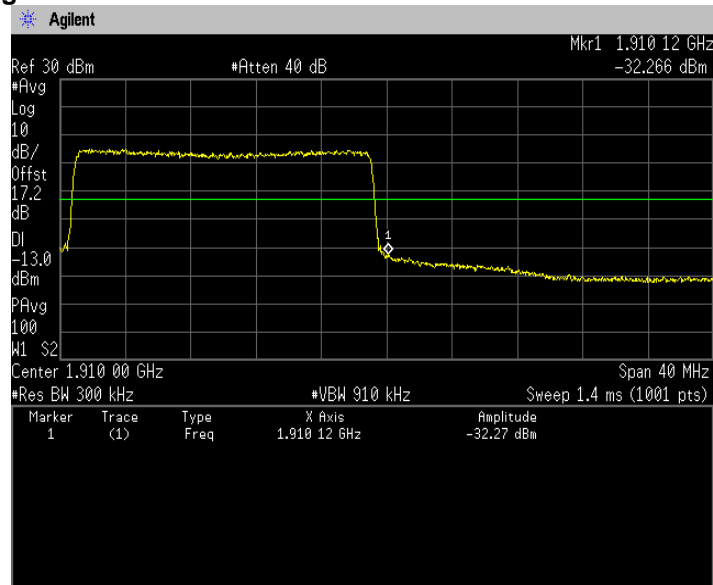



64QAM, BW 1.4MHz, RB1-0
Channel: Low

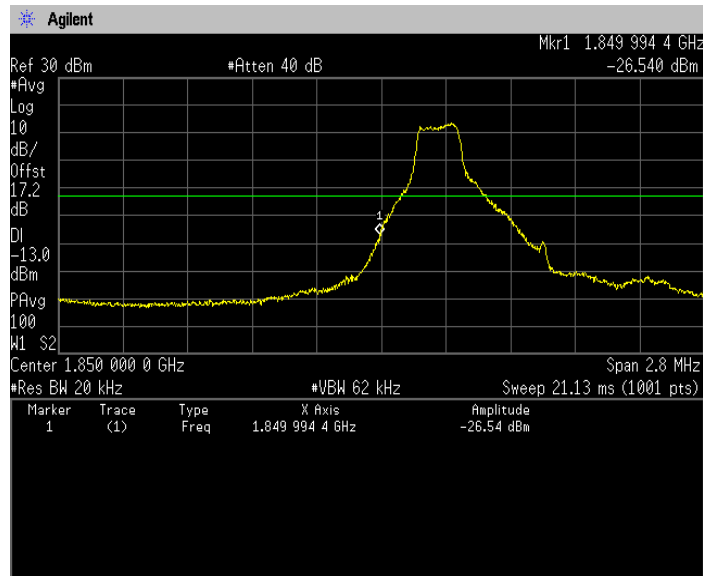

64QAM, BW 1.4MHz, RB1-5
Channel: High

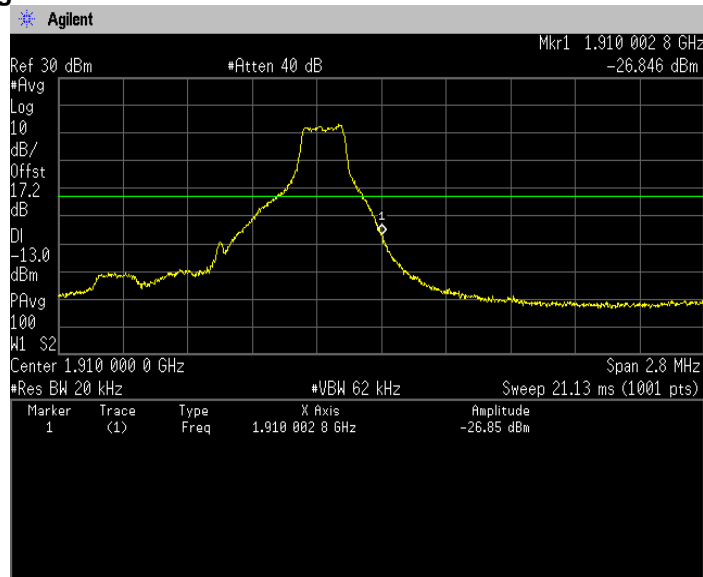



64QAM, BW 1.4MHz, RB6-0
Channel: Low

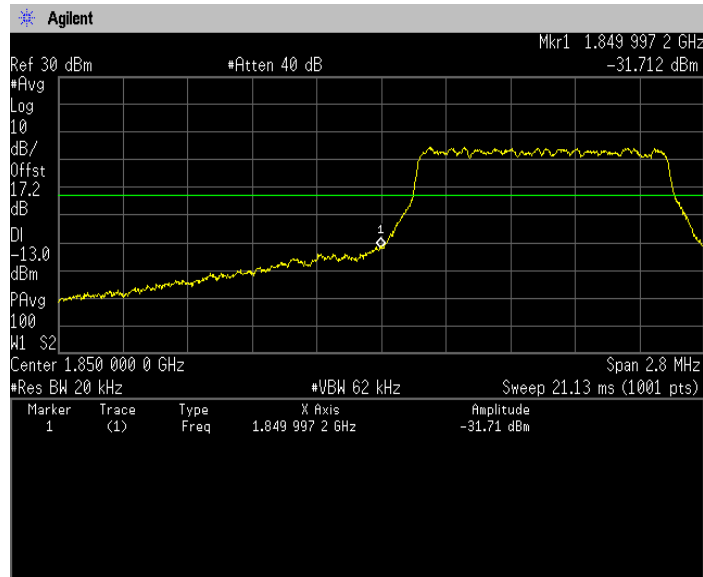

64QAM, BW 1.4MHz, RB6-0
Channel: High

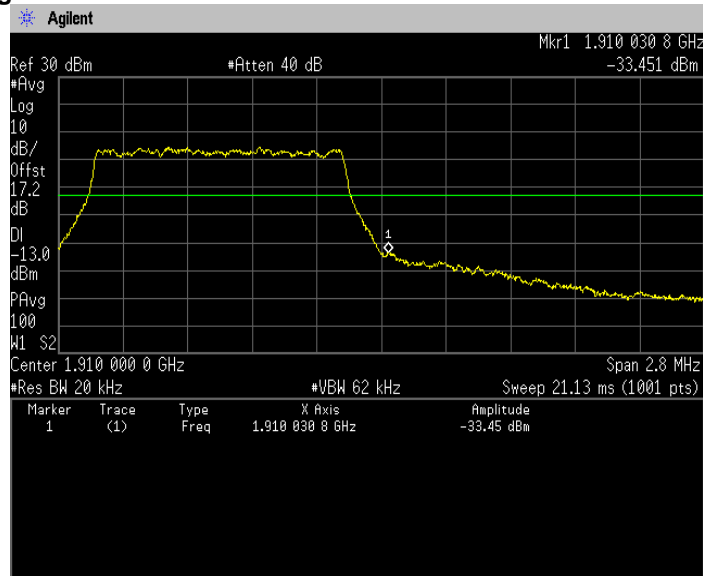



64QAM, BW 3MHz, RB1-0
Channel: Low

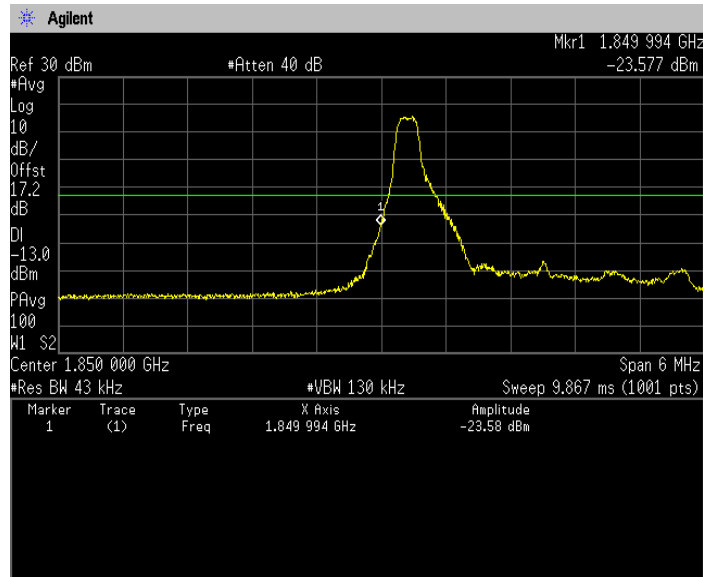

64QAM, BW 3MHz, RB1-14
Channel: High

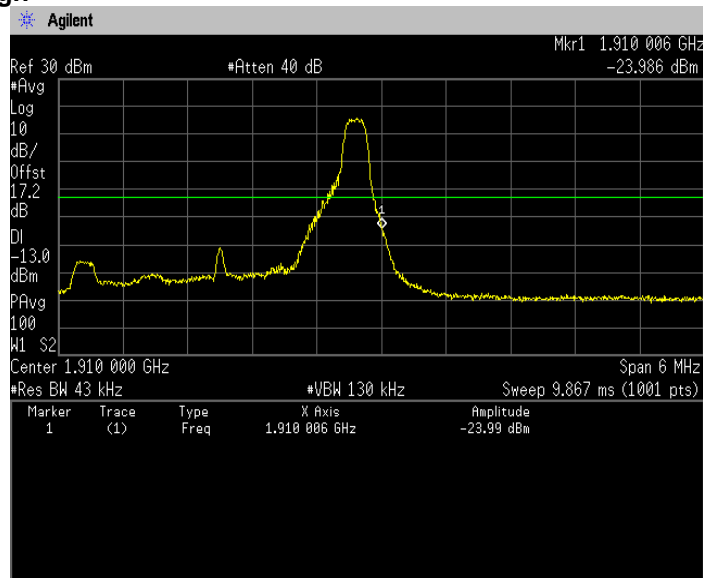



64QAM, BW 3MHz, RB15-0
Channel: Low

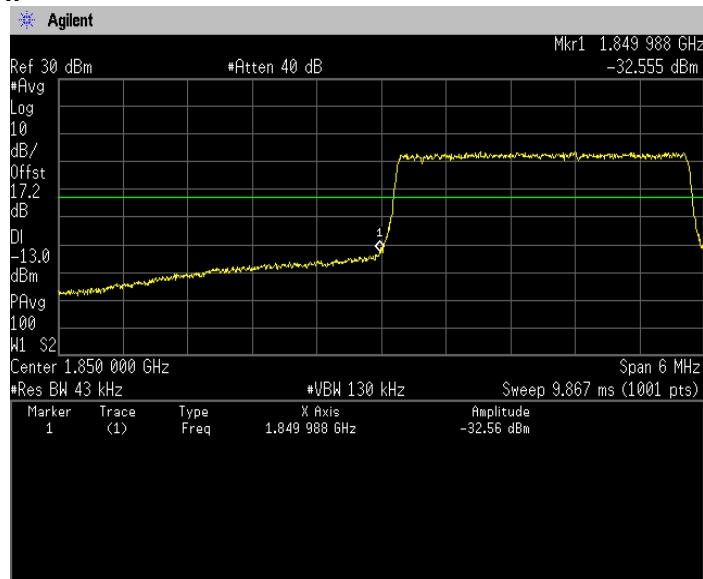

64QAM, BW 3MHz, RB15-0
Channel: High

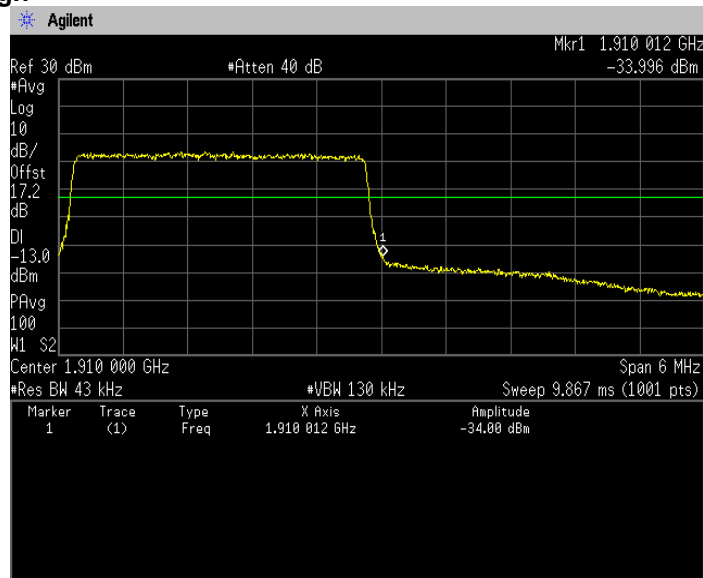



64QAM, BW 5MHz, RB1-0
Channel: Low

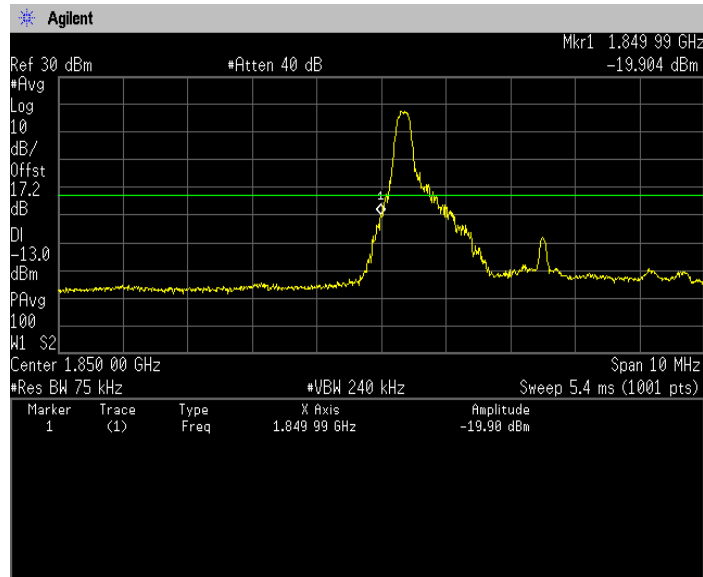

64QAM, BW 5MHz, RB1-24
Channel: High

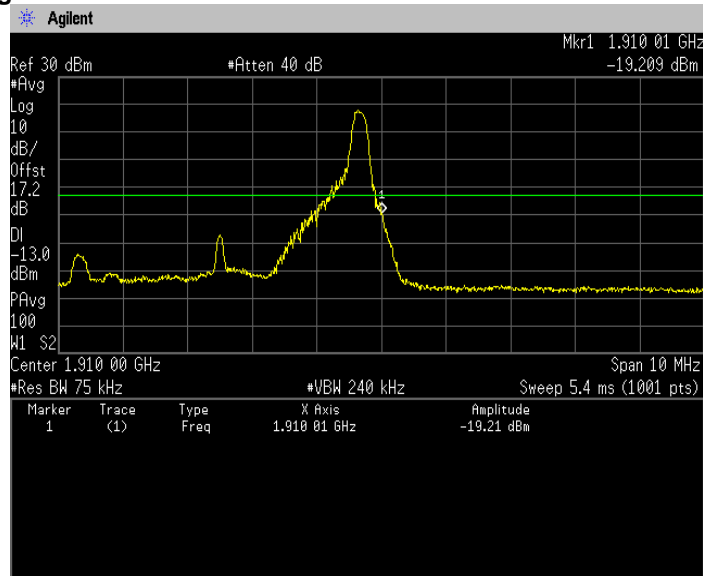



64QAM, BW 5MHz, RB25-0
Channel: Low

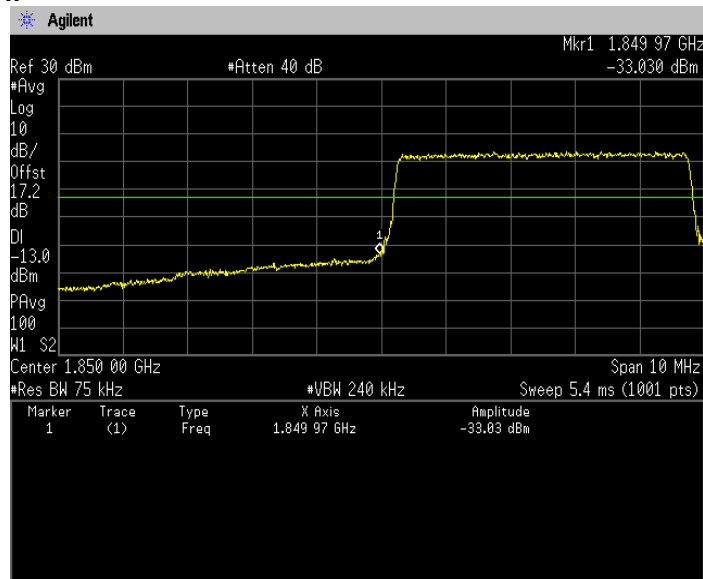

64QAM, BW 5MHz, RB25-0
Channel: High

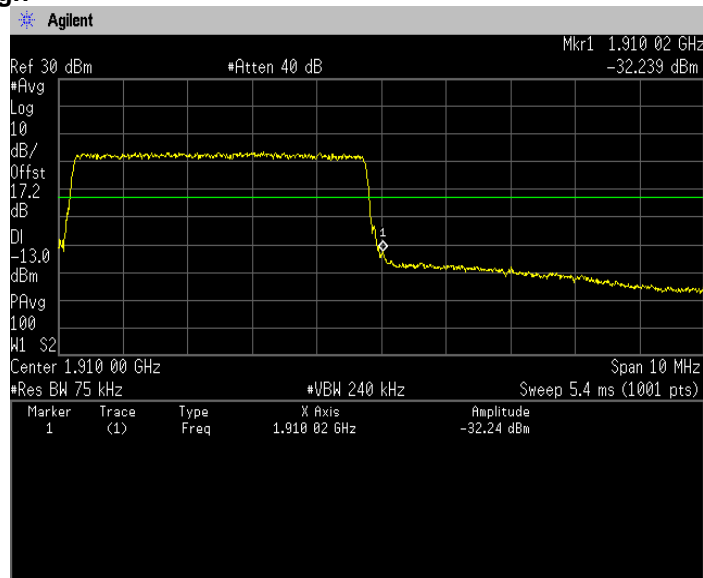



64QAM, BW 10MHz, RB1-0
Channel: Low

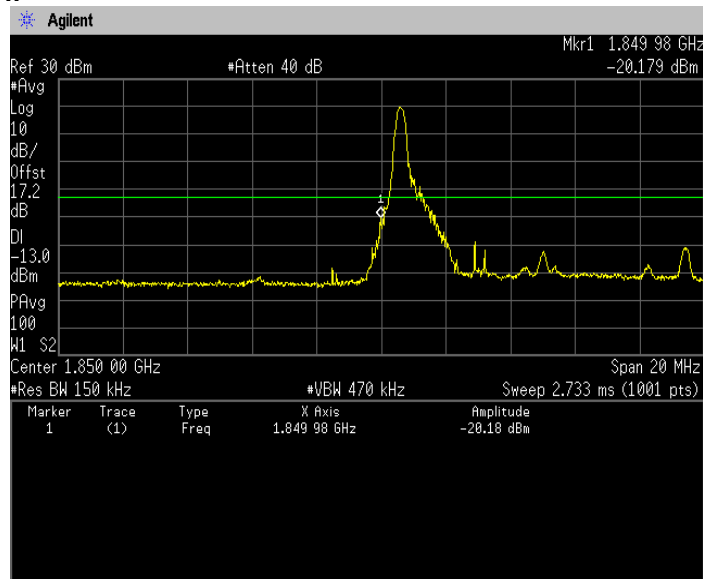

64QAM, BW 10MHz, RB1-49
Channel: High

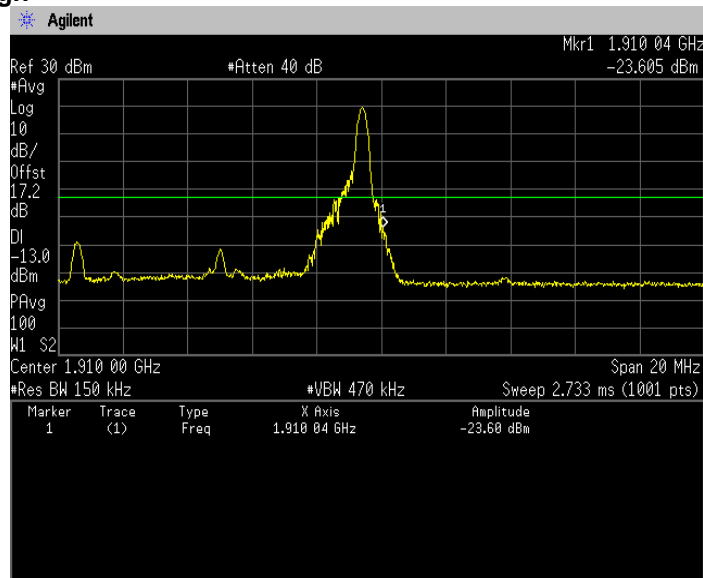



64QAM, BW 10MHz, RB50-0
Channel: Low

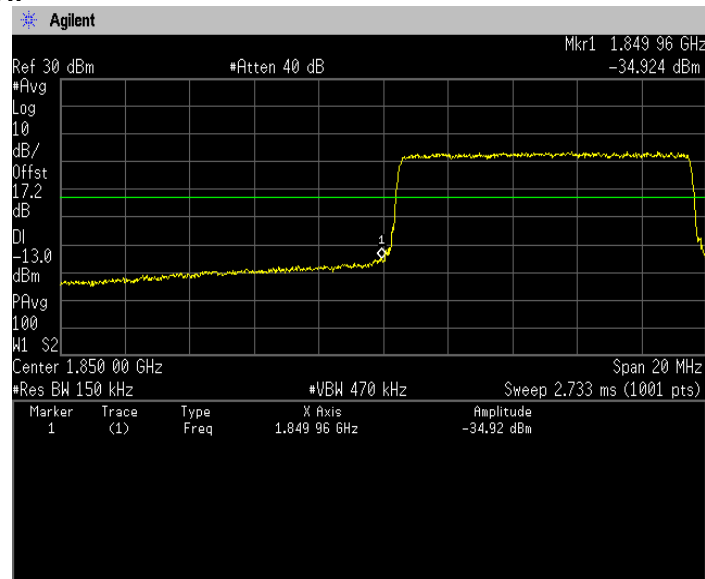

64QAM, BW 10MHz, RB50-0
Channel: High

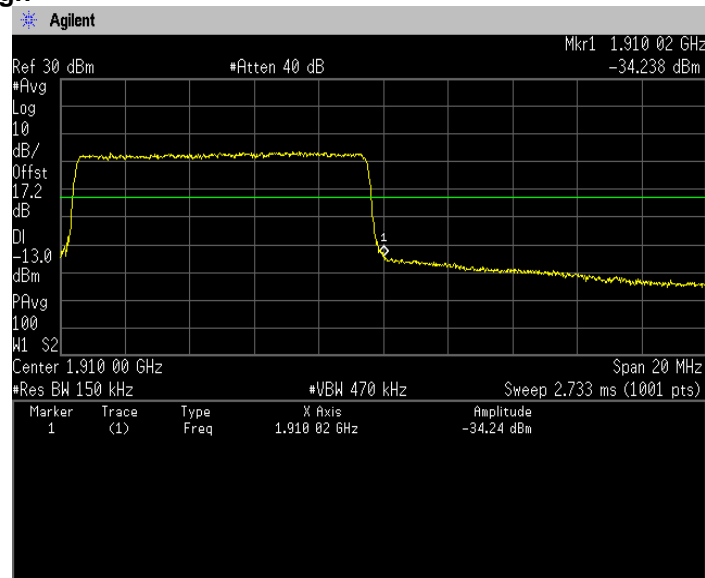



64QAM, BW 15MHz, RB1-0
Channel: Low

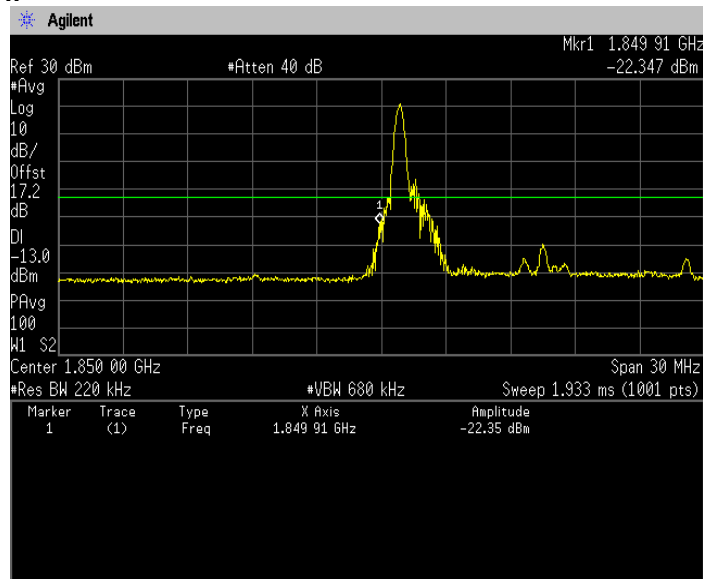

64QAM, BW 15MHz, RB1-74
Channel: High

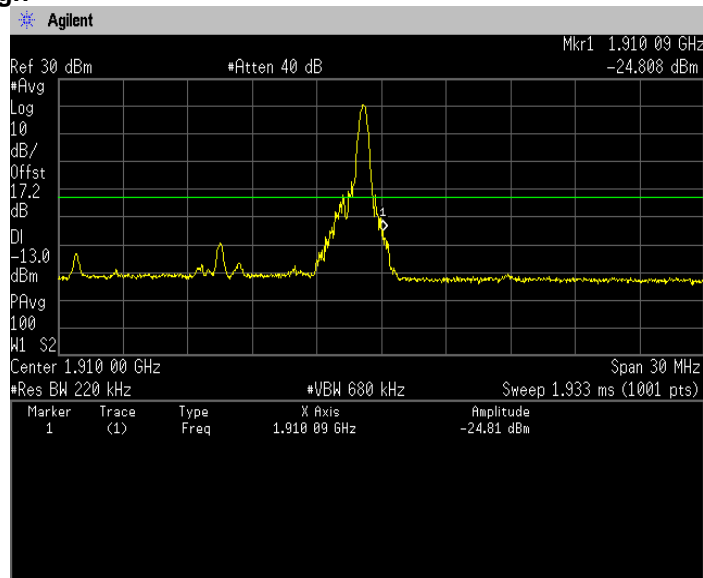



64QAM, BW 15MHz, RB75-0
Channel: Low

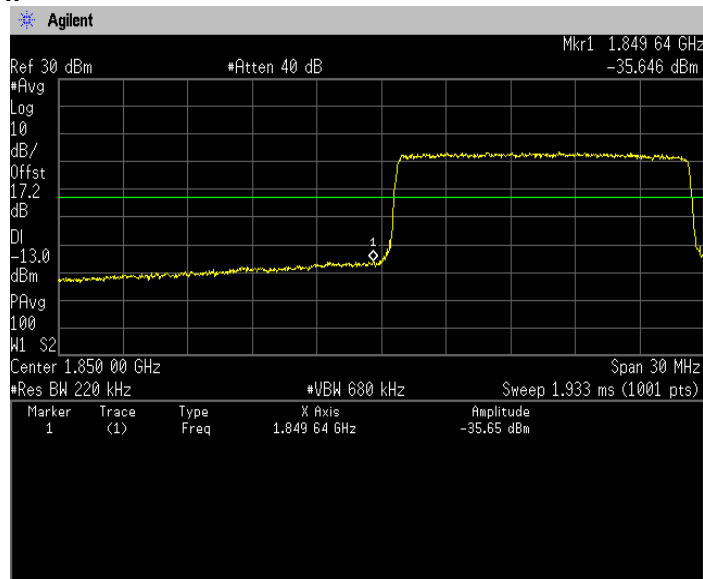

64QAM, BW 15MHz, RB75-0
Channel: High

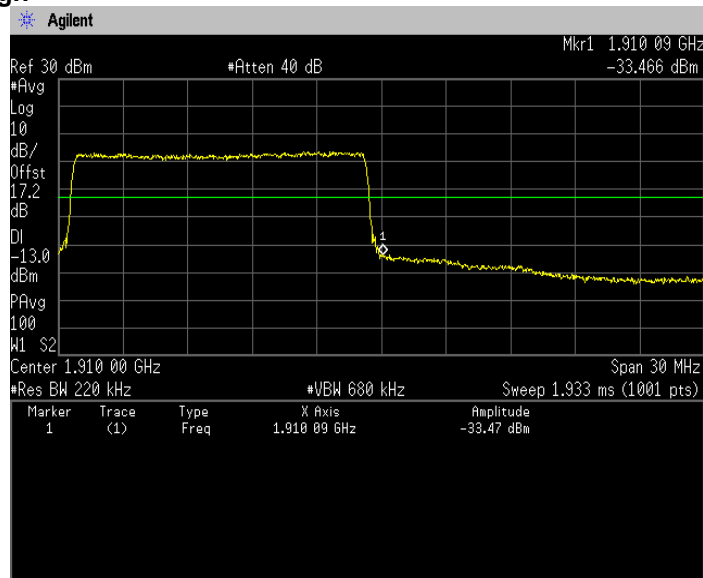



64QAM, BW 20MHz, RB1-0
Channel: Low

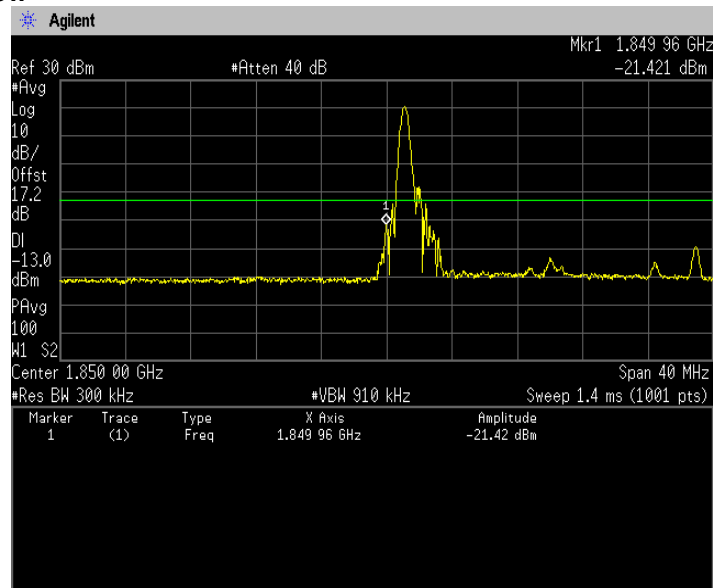

64QAM, BW 20MHz, RB1-99
Channel: High

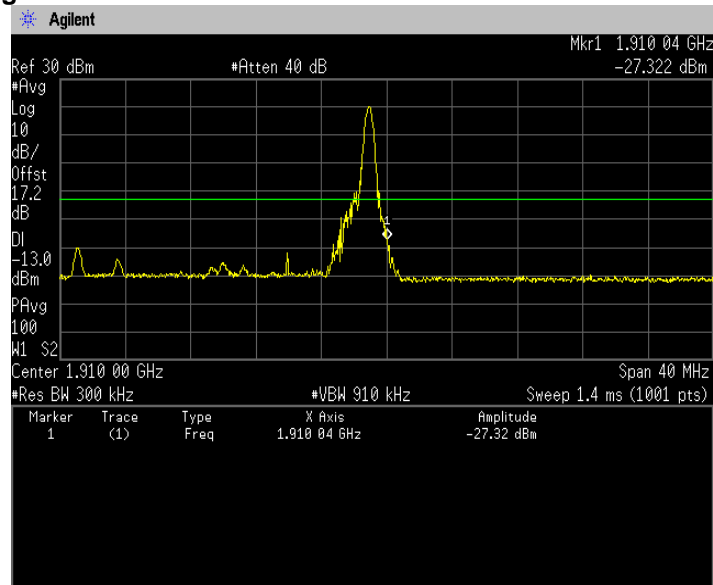



64QAM, BW 20MHz, RB100-0
Channel: Low

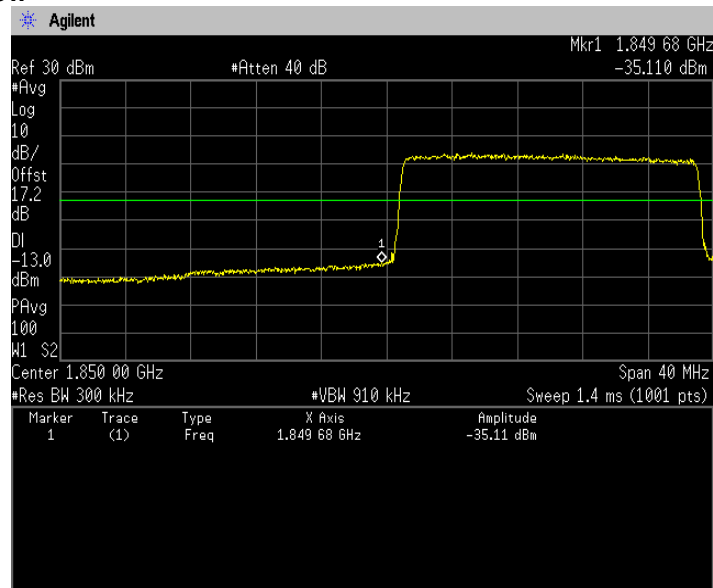

64QAM, BW 20MHz, RB100-0
Channel: High

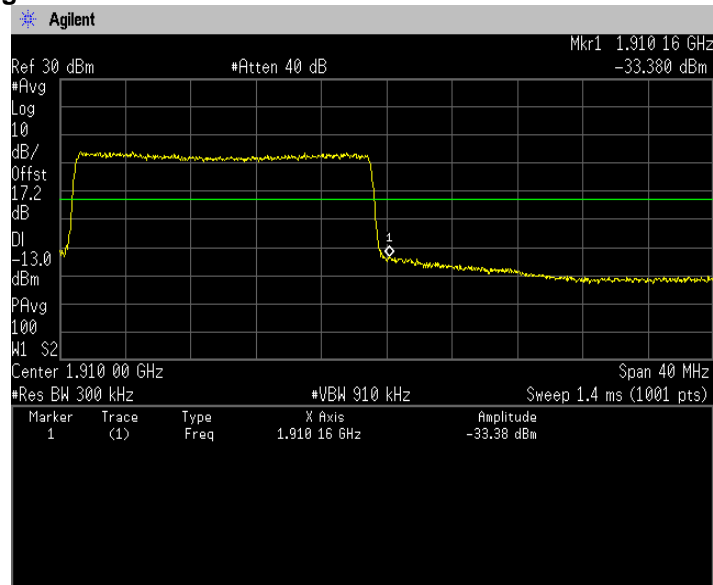

(Spurious Emissions)

Note: Conducted spurious test was measured in the worst case of Equivalent Isotropic Radiated Power.

**QPSK, BW 1.4MHz, RB 1-3
Channel: 18607
30MHz-5GHz**

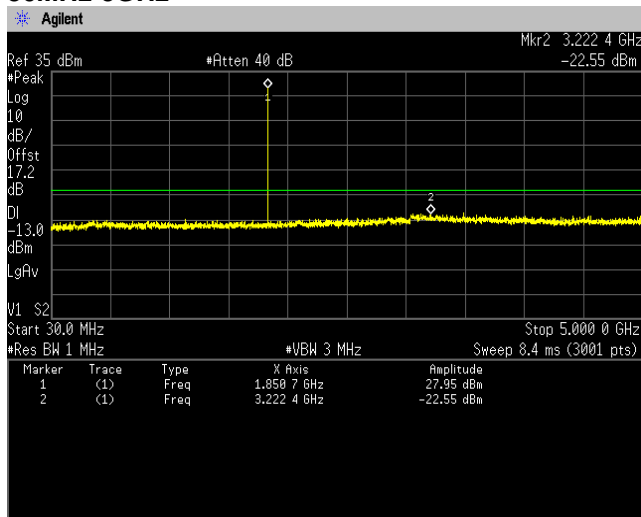

5GHz-10GHz

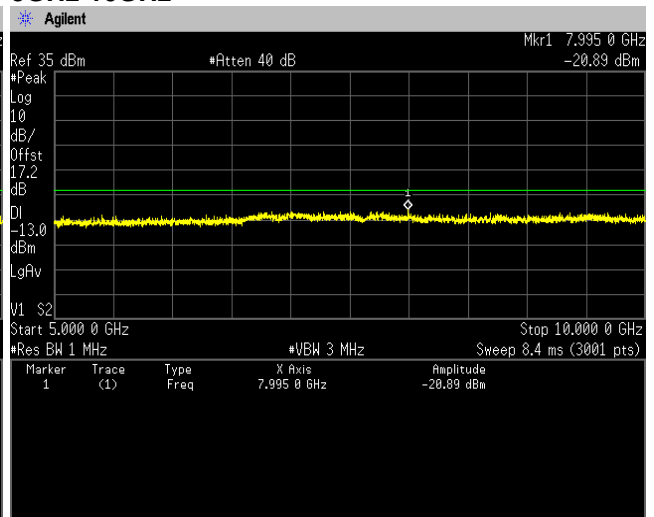

10GHz-15GHz

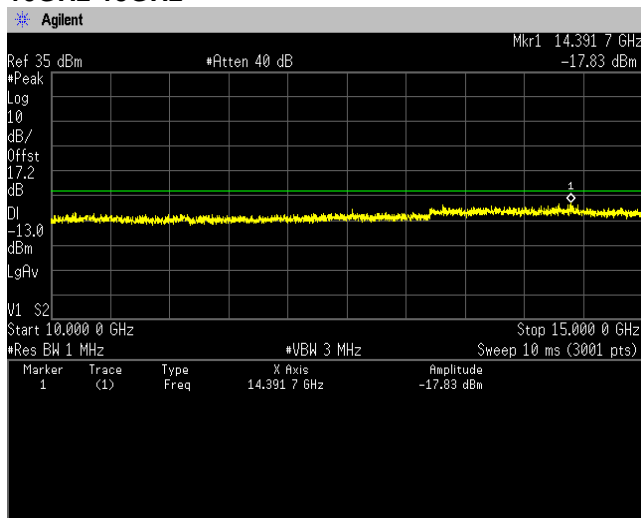

15GHz-20GHz

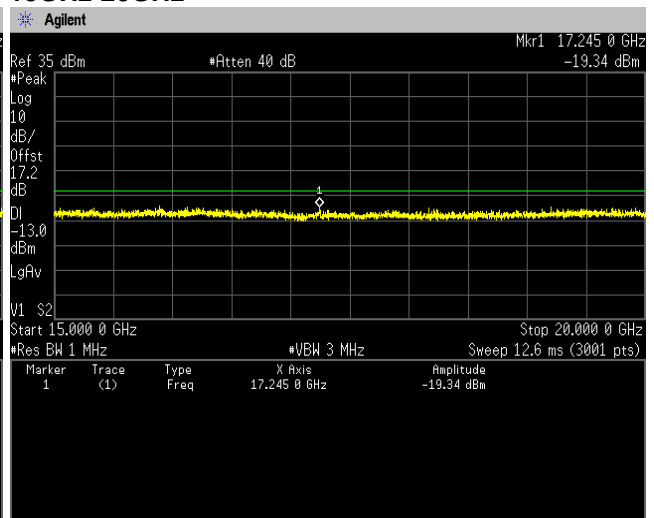



Channel: 18900
30MHz-5GHz

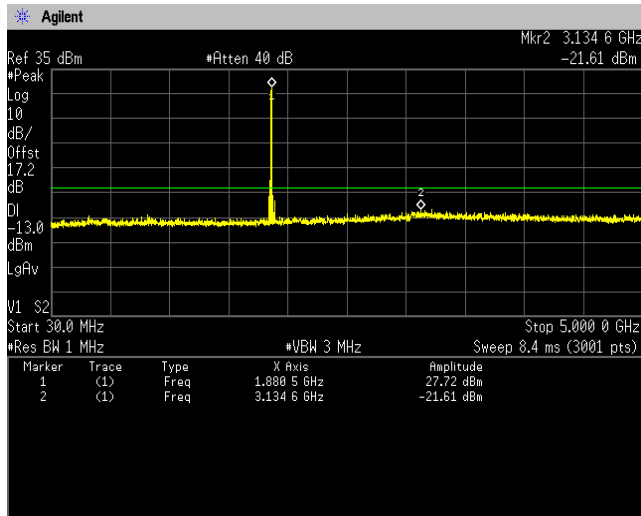

5GHz-10GHz

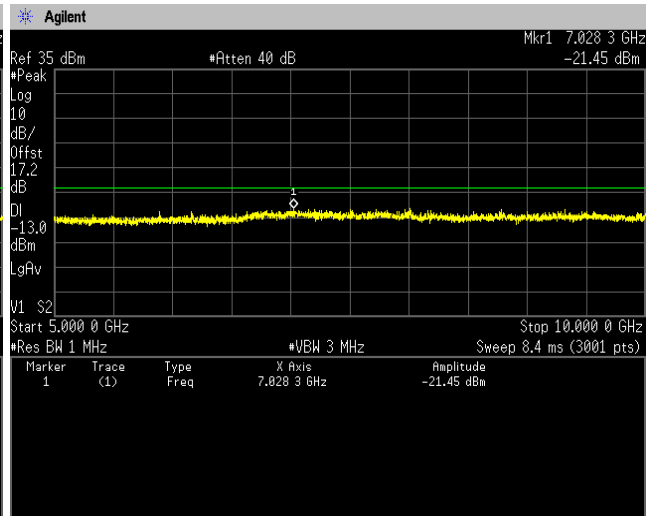

10GHz-15GHz

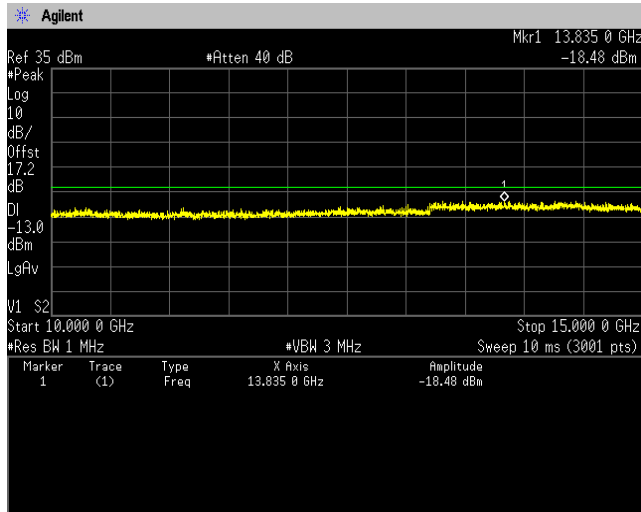

15GHz-20GHz

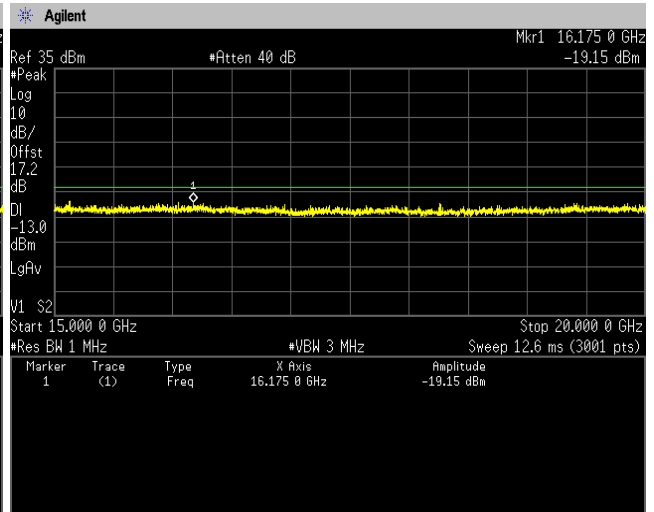



Channel: 19193
30MHz-5GHz

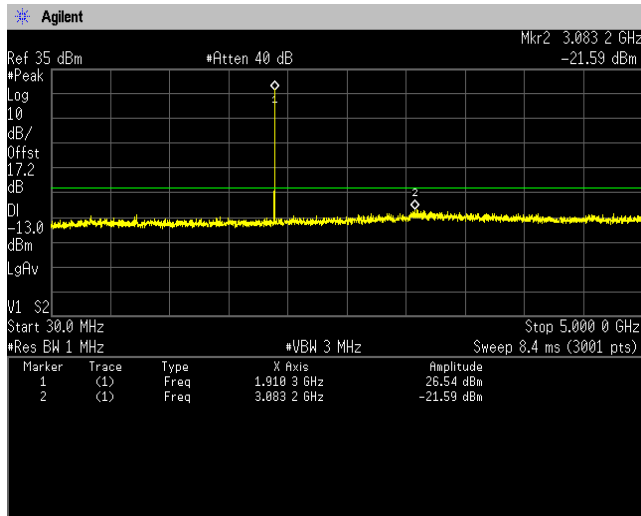

5GHz-10GHz

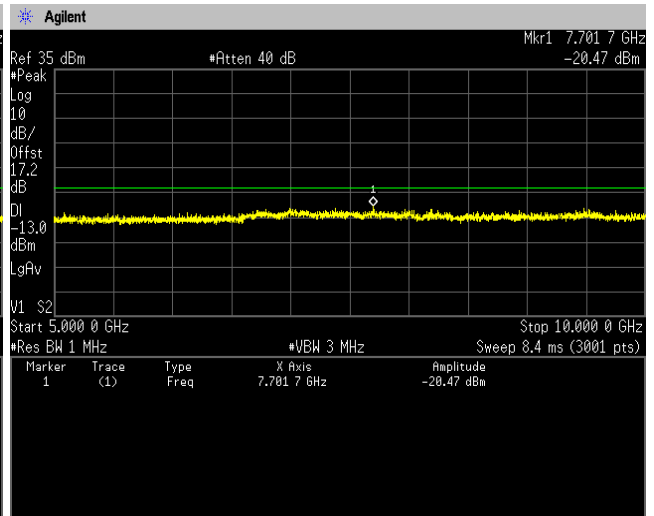

10GHz-15GHz

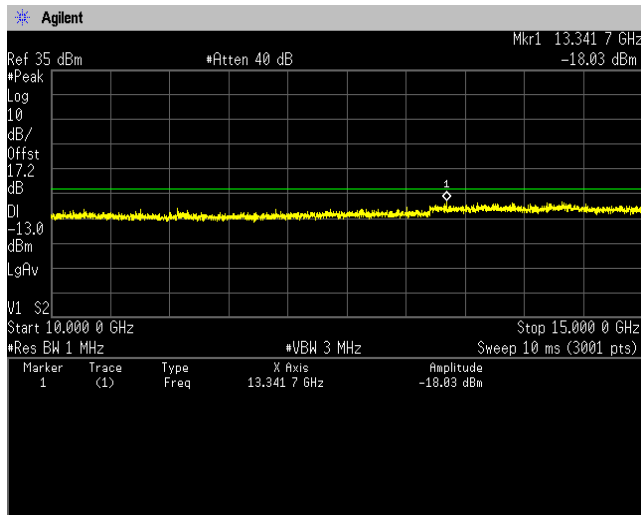

15GHz-20GHz

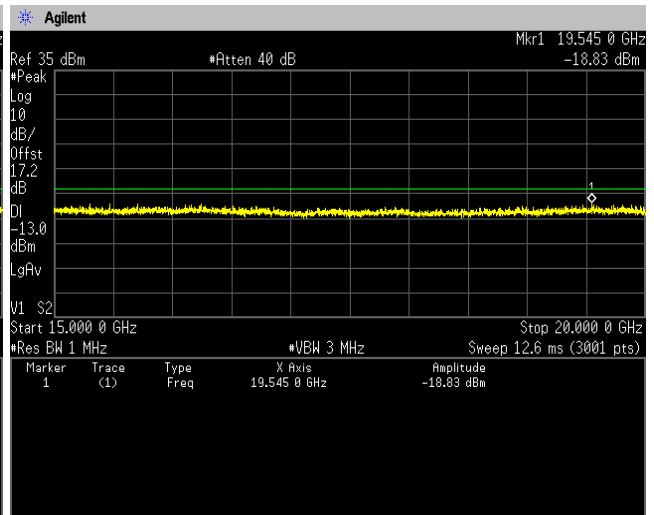

4.5 Radiated Emissions and Harmonic Emissions

4.5.1 Measurement procedure

[FCC 24.238(a), 2.1053]

<Step 1>

The EUT and support equipment are placed on 1.0 meter x 1.0 meter surface, 0.8 meter height (Below or equal 1GHz) or 0.6 meter x 0.6 meter surface, 1.5 meter height (Above 1GHz) styrene foam table. Radiated emission measurements are performed at 3 meter distance with the broadband antenna (Biconical antenna, Log periodic antenna and double ridged guide antenna). The antenna is positioned both the horizontal and vertical planes of polarization and height is varied 1 to 4 meters and stopped at height producing the maximum emission.

The bandwidth of the spectrum analyzer is set to 1 MHz. The turntable is rotated by 360 degrees and stopped at azimuth of producing the maximum emission. The frequency is investigated up to 20 GHz.

<Step 2>

The substitution antenna is replaced by the transmitter antenna (EUT).

The frequency of the signal generator is adjusted to the measurement frequency.

Level of the signal generator is adjusted to the level that is obtained from step 1, and record the emission level of signal generator.

The spectrum analyzer is set to;

- RBW = 100 kHz for below 1 GHz and 1 MHz for above 1 GHz / VBW $\geq 3 \times$ RBW
- Detector = Peak
- Trace mode = Max hold
- Sweep time = auto-couple

- Test configuration

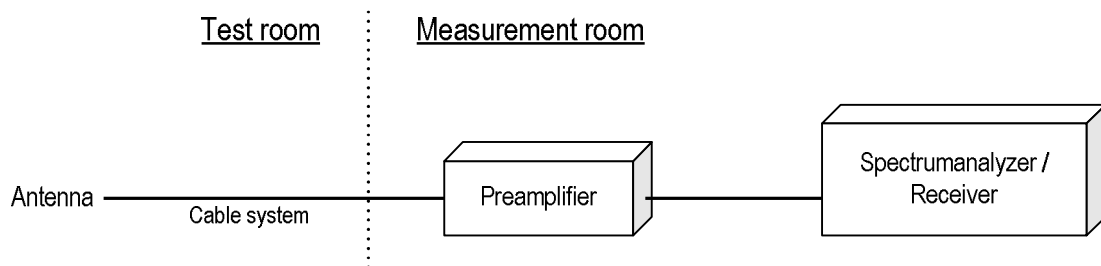

4.5.2 Calculation method

Result (EIRP) = Ant. Input - Cable loss + Antenna Gain
 Margin = Limit - Result (EIRP)

Example:

Limit @ 3760.0 MHz : -13.0 dBm
 Ant. Input = -55.6 dBm Cable loss = 1.6 dB Ant. Gain = 9.2 dBi
 Result = -55.6 - 1.6 + 9.2 = -48.0 dBm
 Margin = -13.0 - (-48.0) = 35.0 dB

4.5.3 Limit

-13 dBm or less

4.5.4 Test data

Date	: 18-April-2022		
Temperature	: 20.0 [°C]		
Humidity	: 22.6 [%]	Test engineer	:
Test place	: 3m Semi-anechoic chamber		<u>Kazunori Saito</u>
Date	: 27~28-April-2022		
Temperature	: 22.9 [°C]		
Humidity	: 37.5 [%]	Test engineer	:
Test place	: 3m Semi-anechoic chamber		<u>Chiaki Kanno</u>
Date	: 28~29-April-2022		
Temperature	: 21.5 [°C]		
Humidity	: 27.1 [%]	Test engineer	:
Test place	: 3m Semi-anechoic chamber		<u>Chiaki Kanno</u>
Date	: 10~11-May-2022		
Temperature	: 23.6 [°C]		
Humidity	: 20.9 [%]	Test engineer	:
Test place	: 3m Semi-anechoic chamber		<u>Tadahiro Seino</u>

[GSM1900 - X-axis, Open, Without camera]**Channel: 512**

H/V	Frequency [MHz]	S.A Reading [dBm]	Ant. Input [dBm]	Cable loss [dB]	Ant.Gain [dBi]	Result [dBm]	Limit [dBm]	Margin [dB]
H	3700.4	-54.5	-52.3	1.6	8.1	-45.8	-13.0	32.8

Channel: 661

H/V	Frequency [MHz]	S.A Reading [dBm]	Ant. Input [dBm]	Cable loss [dB]	Ant.Gain [dBi]	Result [dBm]	Limit [dBm]	Margin [dB]
H	3760.0	-54.2	-52.0	1.7	8.2	-45.4	-13.0	32.4

Channel: 810

H/V	Frequency [MHz]	S.A Reading [dBm]	Ant. Input [dBm]	Cable loss [dB]	Ant.Gain [dBi]	Result [dBm]	Limit [dBm]	Margin [dB]
H	3819.6	-54.3	-52.1	1.7	8.2	-45.5	-13.0	32.5

[WCDMA Band II - X-axis, Open, Without camera]**Channel: 9262**

H/V	Frequency [MHz]	S.A Reading [dBm]	Ant. Input [dBm]	Cable loss [dB]	Ant.Gain [dBi]	Result [dBm]	Limit [dBm]	Margin [dB]
H	3704.8	-56.5	-57.1	1.6	8.1	-50.6	-13.0	37.6

Channel: 9400

H/V	Frequency [MHz]	S.A Reading [dBm]	Ant. Input [dBm]	Cable loss [dB]	Ant.Gain [dBi]	Result [dBm]	Limit [dBm]	Margin [dB]
H	3760.0	-55.7	-56.5	1.7	8.2	-49.9	-13.0	36.9

Channel: 9538

H/V	Frequency [MHz]	S.A Reading [dBm]	Ant. Input [dBm]	Cable loss [dB]	Ant.Gain [dBi]	Result [dBm]	Limit [dBm]	Margin [dB]
H	3815.2	-55.9	-56.8	1.7	8.2	-50.3	-13.0	37.3

[LTE Band II - X-axis, Open, Without camera]**QPSK, BW 1.4MHz****Channel: 18607**

H/V	Frequency [MHz]	S.A Reading [dBm]	Ant. Input [dBm]	Cable loss [dB]	Ant.Gain [dBi]	Result [dBm]	Limit [dBm]	Margin [dB]
H	3701.4	-54.4	-51.2	1.6	8.1	-44.7	-13.0	31.7

Channel: 18900

H/V	Frequency [MHz]	S.A Reading [dBm]	Ant. Input [dBm]	Cable loss [dB]	Ant.Gain [dBi]	Result [dBm]	Limit [dBm]	Margin [dB]
H	3760.0	-54.3	-51.1	1.7	8.2	-44.5	-13.0	31.5

Channel: 19193

H/V	Frequency [MHz]	S.A Reading [dBm]	Ant. Input [dBm]	Cable loss [dB]	Ant.Gain [dBi]	Result [dBm]	Limit [dBm]	Margin [dB]
H	3818.6	-54.2	-51.0	1.7	8.2	-44.4	-13.0	31.4

16QAM, BW 1.4MHz**Channel: 18607**

H/V	Frequency [MHz]	S.A Reading [dBm]	Ant. Input [dBm]	Cable loss [dB]	Ant.Gain [dBi]	Result [dBm]	Limit [dBm]	Margin [dB]
H	3701.4	-54.7	-51.5	1.6	8.1	-45.0	-13.0	32.0

Channel: 18900

H/V	Frequency [MHz]	S.A Reading [dBm]	Ant. Input [dBm]	Cable loss [dB]	Ant.Gain [dBi]	Result [dBm]	Limit [dBm]	Margin [dB]
H	3760.0	-54.6	-51.4	1.7	8.2	-44.8	-13.0	31.8

Channel: 19193

H/V	Frequency [MHz]	S.A Reading [dBm]	Ant. Input [dBm]	Cable loss [dB]	Ant.Gain [dBi]	Result [dBm]	Limit [dBm]	Margin [dB]
H	3818.6	-54.5	-51.3	1.7	8.2	-44.7	-13.0	31.7

64QAM, BW 1.4MHz**Channel: 18607**

H/V	Frequency [MHz]	S.A Reading [dBm]	Ant. Input [dBm]	Cable loss [dB]	Ant.Gain [dBi]	Result [dBm]	Limit [dBm]	Margin [dB]
H	3701.4	-55.0	-51.8	1.6	8.1	-45.3	-13.0	32.3

Channel: 18900

H/V	Frequency [MHz]	S.A Reading [dBm]	Ant. Input [dBm]	Cable loss [dB]	Ant.Gain [dBi]	Result [dBm]	Limit [dBm]	Margin [dB]
H	3760.0	-54.7	-51.5	1.7	8.2	-44.9	-13.0	31.9

Channel: 19193

H/V	Frequency [MHz]	S.A Reading [dBm]	Ant. Input [dBm]	Cable loss [dB]	Ant.Gain [dBi]	Result [dBm]	Limit [dBm]	Margin [dB]
H	3818.6	-54.7	-51.5	1.7	8.2	-44.9	-13.0	31.9

[LTE Band II - X-axis, Open, Without camera]**QPSK, BW 3MHz****Channel: 18615**

H/V	Frequency [MHz]	S.A Reading [dBm]	Ant. Input [dBm]	Cable loss [dB]	Ant.Gain [dBi]	Result [dBm]	Limit [dBm]	Margin [dB]
H	3703.0	-54.1	-50.9	1.6	8.1	-44.4	-13.0	31.4

Channel: 18900

H/V	Frequency [MHz]	S.A Reading [dBm]	Ant. Input [dBm]	Cable loss [dB]	Ant.Gain [dBi]	Result [dBm]	Limit [dBm]	Margin [dB]
H	3760.0	-54.4	-51.2	1.7	8.2	-44.6	-13.0	31.6

Channel: 19185

H/V	Frequency [MHz]	S.A Reading [dBm]	Ant. Input [dBm]	Cable loss [dB]	Ant.Gain [dBi]	Result [dBm]	Limit [dBm]	Margin [dB]
H	3817.0	-54.6	-51.4	1.7	8.2	-44.8	-13.0	31.8

16QAM, BW 3MHz**Channel: 18615**

H/V	Frequency [MHz]	S.A Reading [dBm]	Ant. Input [dBm]	Cable loss [dB]	Ant.Gain [dBi]	Result [dBm]	Limit [dBm]	Margin [dB]
H	3703.0	-54.2	-51.0	1.6	8.1	-44.5	-13.0	31.5

Channel: 18900

H/V	Frequency [MHz]	S.A Reading [dBm]	Ant. Input [dBm]	Cable loss [dB]	Ant.Gain [dBi]	Result [dBm]	Limit [dBm]	Margin [dB]
H	3760.0	-54.5	-51.3	1.7	8.2	-44.7	-13.0	31.7

Channel: 19185

H/V	Frequency [MHz]	S.A Reading [dBm]	Ant. Input [dBm]	Cable loss [dB]	Ant.Gain [dBi]	Result [dBm]	Limit [dBm]	Margin [dB]
H	3817.0	-54.8	-51.6	1.7	8.2	-45.0	-13.0	32.0

64QAM, BW 3MHz**Channel: 18615**

H/V	Frequency [MHz]	S.A Reading [dBm]	Ant. Input [dBm]	Cable loss [dB]	Ant.Gain [dBi]	Result [dBm]	Limit [dBm]	Margin [dB]
H	3703.0	-54.3	-51.1	1.6	8.1	-44.6	-13.0	31.6

Channel: 18900

H/V	Frequency [MHz]	S.A Reading [dBm]	Ant. Input [dBm]	Cable loss [dB]	Ant.Gain [dBi]	Result [dBm]	Limit [dBm]	Margin [dB]
H	3760.0	-54.6	-51.4	1.7	8.2	-44.8	-13.0	31.8

Channel: 19185

H/V	Frequency [MHz]	S.A Reading [dBm]	Ant. Input [dBm]	Cable loss [dB]	Ant.Gain [dBi]	Result [dBm]	Limit [dBm]	Margin [dB]
H	3817.0	-54.9	-51.7	1.7	8.2	-45.1	-13.0	32.1

[LTE Band II - X-axis, Open, Without camera]**QPSK, BW 5MHz****Channel: 18625**

H/V	Frequency [MHz]	S.A Reading [dBm]	Ant. Input [dBm]	Cable loss [dB]	Ant.Gain [dBi]	Result [dBm]	Limit [dBm]	Margin [dB]
H	3700.7	-53.9	-50.7	1.6	8.1	-44.2	-13.0	31.2

Channel: 18900

H/V	Frequency [MHz]	S.A Reading [dBm]	Ant. Input [dBm]	Cable loss [dB]	Ant.Gain [dBi]	Result [dBm]	Limit [dBm]	Margin [dB]
H	3755.7	-53.9	-50.7	1.7	8.2	-44.1	-13.0	31.1

Channel: 19175

H/V	Frequency [MHz]	S.A Reading [dBm]	Ant. Input [dBm]	Cable loss [dB]	Ant.Gain [dBi]	Result [dBm]	Limit [dBm]	Margin [dB]
H	3810.7	-54.2	-51.0	1.7	8.2	-44.5	-13.0	31.5

16QAM, BW 5MHz**Channel: 18625**

H/V	Frequency [MHz]	S.A Reading [dBm]	Ant. Input [dBm]	Cable loss [dB]	Ant.Gain [dBi]	Result [dBm]	Limit [dBm]	Margin [dB]
H	3705.0	-54.6	-51.4	1.6	8.1	-44.9	-13.0	31.9

Channel: 18900

H/V	Frequency [MHz]	S.A Reading [dBm]	Ant. Input [dBm]	Cable loss [dB]	Ant.Gain [dBi]	Result [dBm]	Limit [dBm]	Margin [dB]
H	3760.0	-54.6	-51.4	1.7	8.2	-44.8	-13.0	31.8

Channel: 19175

H/V	Frequency [MHz]	S.A Reading [dBm]	Ant. Input [dBm]	Cable loss [dB]	Ant.Gain [dBi]	Result [dBm]	Limit [dBm]	Margin [dB]
H	3815.0	-54.5	-51.3	1.7	8.2	-44.8	-13.0	31.8

64QAM, BW 5MHz**Channel: 18625**

H/V	Frequency [MHz]	S.A Reading [dBm]	Ant. Input [dBm]	Cable loss [dB]	Ant.Gain [dBi]	Result [dBm]	Limit [dBm]	Margin [dB]
H	3705.0	-54.7	-51.5	1.6	8.1	-45.0	-13.0	32.0

Channel: 18900

H/V	Frequency [MHz]	S.A Reading [dBm]	Ant. Input [dBm]	Cable loss [dB]	Ant.Gain [dBi]	Result [dBm]	Limit [dBm]	Margin [dB]
H	3760.0	-54.7	-51.5	1.7	8.2	-44.9	-13.0	31.9

Channel: 19175

H/V	Frequency [MHz]	S.A Reading [dBm]	Ant. Input [dBm]	Cable loss [dB]	Ant.Gain [dBi]	Result [dBm]	Limit [dBm]	Margin [dB]
H	3815.0	-54.6	-51.3	1.7	8.2	-44.8	-13.0	31.8

[LTE Band II - X-axis, Open, Without camera]**QPSK, BW 10MHz****Channel: 18650**

H/V	Frequency [MHz]	S.A Reading [dBm]	Ant. Input [dBm]	Cable loss [dB]	Ant.Gain [dBi]	Result [dBm]	Limit [dBm]	Margin [dB]
H	3710.0	-54.4	-51.2	1.6	8.2	-44.7	-13.0	31.7

Channel: 18900

H/V	Frequency [MHz]	S.A Reading [dBm]	Ant. Input [dBm]	Cable loss [dB]	Ant.Gain [dBi]	Result [dBm]	Limit [dBm]	Margin [dB]
H	3760.0	-54.1	-50.9	1.7	8.2	-44.3	-13.0	31.3

Channel: 19150

H/V	Frequency [MHz]	S.A Reading [dBm]	Ant. Input [dBm]	Cable loss [dB]	Ant.Gain [dBi]	Result [dBm]	Limit [dBm]	Margin [dB]
H	3810.0	-54.0	-50.8	1.7	8.2	-44.3	-13.0	31.3

16QAM, BW 10MHz**Channel: 18650**

H/V	Frequency [MHz]	S.A Reading [dBm]	Ant. Input [dBm]	Cable loss [dB]	Ant.Gain [dBi]	Result [dBm]	Limit [dBm]	Margin [dB]
H	3710.0	-54.5	-51.3	1.6	8.2	-44.8	-13.0	31.8

Channel: 18900

H/V	Frequency [MHz]	S.A Reading [dBm]	Ant. Input [dBm]	Cable loss [dB]	Ant.Gain [dBi]	Result [dBm]	Limit [dBm]	Margin [dB]
H	3760.0	-54.2	-51.0	1.7	8.2	-44.4	-13.0	31.4

Channel: 19150

H/V	Frequency [MHz]	S.A Reading [dBm]	Ant. Input [dBm]	Cable loss [dB]	Ant.Gain [dBi]	Result [dBm]	Limit [dBm]	Margin [dB]
H	3810.0	-54.2	-51.0	1.7	8.2	-44.5	-13.0	31.5

64QAM, BW 10MHz**Channel: 18650**

H/V	Frequency [MHz]	S.A Reading [dBm]	Ant. Input [dBm]	Cable loss [dB]	Ant.Gain [dBi]	Result [dBm]	Limit [dBm]	Margin [dB]
H	3710.0	-54.6	-51.4	1.6	8.2	-44.9	-13.0	31.9

Channel: 18900

H/V	Frequency [MHz]	S.A Reading [dBm]	Ant. Input [dBm]	Cable loss [dB]	Ant.Gain [dBi]	Result [dBm]	Limit [dBm]	Margin [dB]
H	3760.0	-54.3	-51.1	1.7	8.2	-44.5	-13.0	31.5

Channel: 19150

H/V	Frequency [MHz]	S.A Reading [dBm]	Ant. Input [dBm]	Cable loss [dB]	Ant.Gain [dBi]	Result [dBm]	Limit [dBm]	Margin [dB]
H	3810.0	-54.3	-51.1	1.7	8.2	-44.6	-13.0	31.6

[LTE Band II - X-axis, Open, Without camera]**QPSK, BW 15MHz****Channel: 18675**

H/V	Frequency [MHz]	S.A Reading [dBm]	Ant. Input [dBm]	Cable loss [dB]	Ant.Gain [dBi]	Result [dBm]	Limit [dBm]	Margin [dB]
H	3715.0	-54.4	-51.2	1.6	8.2	-44.7	-13.0	31.7

Channel: 18900

H/V	Frequency [MHz]	S.A Reading [dBm]	Ant. Input [dBm]	Cable loss [dB]	Ant.Gain [dBi]	Result [dBm]	Limit [dBm]	Margin [dB]
H	3760.0	-54.2	-51.0	1.7	8.2	-44.4	-13.0	31.4

Channel: 19125

H/V	Frequency [MHz]	S.A Reading [dBm]	Ant. Input [dBm]	Cable loss [dB]	Ant.Gain [dBi]	Result [dBm]	Limit [dBm]	Margin [dB]
H	3805.0	-54.2	-51.0	1.7	8.2	-44.5	-13.0	31.5

16QAM, BW 15MHz**Channel: 18675**

H/V	Frequency [MHz]	S.A Reading [dBm]	Ant. Input [dBm]	Cable loss [dB]	Ant.Gain [dBi]	Result [dBm]	Limit [dBm]	Margin [dB]
H	3715.0	-54.7	-51.5	1.6	8.2	-45.0	-13.0	32.0

Channel: 18900

H/V	Frequency [MHz]	S.A Reading [dBm]	Ant. Input [dBm]	Cable loss [dB]	Ant.Gain [dBi]	Result [dBm]	Limit [dBm]	Margin [dB]
H	3760.0	-54.6	-51.4	1.7	8.2	-44.8	-13.0	31.8

Channel: 19125

H/V	Frequency [MHz]	S.A Reading [dBm]	Ant. Input [dBm]	Cable loss [dB]	Ant.Gain [dBi]	Result [dBm]	Limit [dBm]	Margin [dB]
H	3805.0	-54.5	-51.3	1.7	8.2	-44.8	-13.0	31.8

64QAM, BW 15MHz**Channel: 18675**

H/V	Frequency [MHz]	S.A Reading [dBm]	Ant. Input [dBm]	Cable loss [dB]	Ant.Gain [dBi]	Result [dBm]	Limit [dBm]	Margin [dB]
H	3715.0	-54.8	-51.6	1.6	8.2	-45.1	-13.0	32.1

Channel: 18900

H/V	Frequency [MHz]	S.A Reading [dBm]	Ant. Input [dBm]	Cable loss [dB]	Ant.Gain [dBi]	Result [dBm]	Limit [dBm]	Margin [dB]
H	3760.0	-55.0	-51.8	1.7	8.2	-45.2	-13.0	32.2

Channel: 19125

H/V	Frequency [MHz]	S.A Reading [dBm]	Ant. Input [dBm]	Cable loss [dB]	Ant.Gain [dBi]	Result [dBm]	Limit [dBm]	Margin [dB]
H	3805.0	-54.7	-51.5	1.7	8.2	-45.0	-13.0	32.0

[LTE Band II - X-axis, Open, Without camera]**QPSK, BW 20MHz****Channel: 18700**

H/V	Frequency [MHz]	S.A Reading [dBm]	Ant. Input [dBm]	Cable loss [dB]	Ant.Gain [dBi]	Result [dBm]	Limit [dBm]	Margin [dB]
H	3720.0	-54.1	-50.9	1.6	8.2	-44.4	-13.0	31.4

Channel: 18900

H/V	Frequency [MHz]	S.A Reading [dBm]	Ant. Input [dBm]	Cable loss [dB]	Ant.Gain [dBi]	Result [dBm]	Limit [dBm]	Margin [dB]
H	3760.0	-54.1	-50.9	1.7	8.2	-44.3	-13.0	31.3

Channel: 19100

H/V	Frequency [MHz]	S.A Reading [dBm]	Ant. Input [dBm]	Cable loss [dB]	Ant.Gain [dBi]	Result [dBm]	Limit [dBm]	Margin [dB]
H	3800.0	-54.3	-51.1	1.7	8.1	-44.6	-13.0	31.6

16QAM, BW 20MHz**Channel: 18700**

H/V	Frequency [MHz]	S.A Reading [dBm]	Ant. Input [dBm]	Cable loss [dB]	Ant.Gain [dBi]	Result [dBm]	Limit [dBm]	Margin [dB]
H	3720.0	-54.6	-51.4	1.6	10.4	-42.7	-13.0	29.7

Channel: 18900

H/V	Frequency [MHz]	S.A Reading [dBm]	Ant. Input [dBm]	Cable loss [dB]	Ant.Gain [dBi]	Result [dBm]	Limit [dBm]	Margin [dB]
H	3760.0	-54.3	-51.1	1.7	10.4	-42.3	-13.0	29.3

Channel: 19100

H/V	Frequency [MHz]	S.A Reading [dBm]	Ant. Input [dBm]	Cable loss [dB]	Ant.Gain [dBi]	Result [dBm]	Limit [dBm]	Margin [dB]
H	3800.0	-54.4	-51.2	1.7	10.3	-42.5	-13.0	29.5

64QAM, BW 20MHz**Channel: 18700**

H/V	Frequency [MHz]	S.A Reading [dBm]	Ant. Input [dBm]	Cable loss [dB]	Ant.Gain [dBi]	Result [dBm]	Limit [dBm]	Margin [dB]
H	3720.0	-54.9	-51.7	1.6	10.4	-43.0	-13.0	30.0

Channel: 18900

H/V	Frequency [MHz]	S.A Reading [dBm]	Ant. Input [dBm]	Cable loss [dB]	Ant.Gain [dBi]	Result [dBm]	Limit [dBm]	Margin [dB]
H	3760.0	-54.6	-51.3	1.7	10.4	-42.5	-13.0	29.5

Channel: 19100

H/V	Frequency [MHz]	S.A Reading [dBm]	Ant. Input [dBm]	Cable loss [dB]	Ant.Gain [dBi]	Result [dBm]	Limit [dBm]	Margin [dB]
H	3800.0	-54.7	-51.5	1.7	10.3	-42.8	-13.0	29.8

4.6 Frequency Stability

4.6.1 Measurement procedure

[FCC 24.235, 2.1055]

The EUT was placed of an inside of an constant temperature chamber as the temperature in the chamber was varied between -30°C and $+50^{\circ}\text{C}$. The temperature was incremented by 10°C intervals and the unit was allowed to stabilize at each measurement. The frequency drift was measured with the normal Temperature and voltage tolerance and it is presented as the ppm unit.

- Test configuration

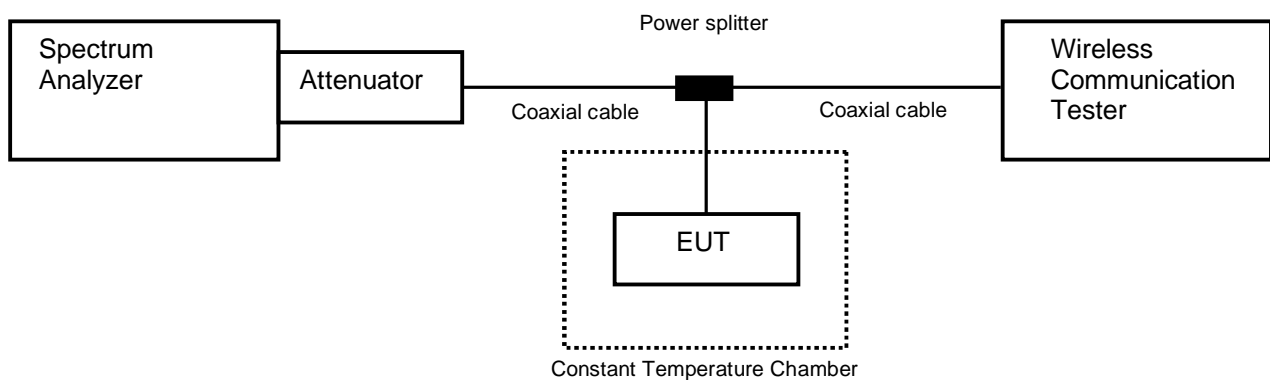

4.6.2 Limit

The frequency stability shall be sufficient to ensure that the fundamental emission stays within the authorized frequency block.

4.6.3 Measurement result

Date : 6-May-2022
 Temperature : 24.0 [°C]
 Humidity : 35.8 [%]
 Test place : Shielded room No.4

Test engineer : Tadahiro Seino

[GSM1900]

Channel: 661

Power Supply [V]	Temperature [°C]	Measurements Frequency [Hz]	Frequency Tolerance [ppm]	Result
3.80	25(Ref.)	1,880,000,029	0.00000	Pass
	50	1,880,000,033	0.00218	Pass
	40	1,880,000,026	-0.00163	Pass
	30	1,880,000,035	0.00301	Pass
	20	1,880,000,025	-0.00242	Pass
	10	1,880,000,025	-0.00196	Pass
	0	1,880,000,015	-0.00757	Pass
	-10	1,879,999,988	-0.02171	Pass
	-20	1,879,999,988	-0.02161	Pass
	-30	1,879,999,980	-0.02605	Pass
3.42	25	1,880,000,034	0.00275	Pass
4.18	25	1,880,000,026	-0.00173	Pass

Calculation;

Frequency Tolerance (ppm) = Measurements Frequency (Hz) – Reference Frequency (Hz) / Reference Frequency (Hz) x 1000000

[WCDMA Band II]
Channel: 9400

Power Supply [V]	Temperature [°C]	Measurements Frequency [Hz]	Frequency Tolerance [ppm]	Result
3.80	25(Ref.)	1,879,999,970	0.00000	Pass
	50	1,879,999,985	0.00770	Pass
	40	1,879,999,976	0.00316	Pass
	30	1,879,999,980	0.00526	Pass
	20	1,879,999,975	0.00259	Pass
	10	1,879,999,979	0.00483	Pass
	0	1,879,999,982	0.00602	Pass
	-10	1,879,999,993	0.01190	Pass
	-20	1,879,999,988	0.00962	Pass
	-30	1,880,000,016	0.02434	Pass
3.42	25	1,879,999,981	0.00557	Pass
4.18	25	1,879,999,976	0.00323	Pass

Calculation;

Frequency Tolerance (ppm) = Measurements Frequency (Hz) – Reference Frequency (Hz) / Reference Frequency (Hz) x 1000000

[LTE Band II]
QPSK, BW 10MHz, RB 50-0
Channel: 18900

Power Supply [V]	Temperature [°C]	Measurements Frequency [Hz]	Frequency Tolerance [ppm]	Result
3.80	25(Ref.)	1,879,999,985	0.00000	Pass
	50	1,879,999,978	-0.00355	Pass
	40	1,879,999,975	-0.00504	Pass
	30	1,879,999,988	0.00171	Pass
	20	1,879,999,990	0.00248	Pass
	10	1,879,999,979	-0.00302	Pass
	0	1,879,999,977	-0.00418	Pass
	-10	1,879,999,975	-0.00510	Pass
	-20	1,880,000,027	0.02229	Pass
	-30	1,879,999,984	-0.00023	Pass
3.42	25	1,879,999,989	0.00227	Pass
4.18	25	1,879,999,984	-0.00019	Pass



Calculation;

Frequency Tolerance (ppm) = Measurements Frequency (Hz) – Reference Frequency (Hz) / Reference Frequency (Hz) x 1000000

5 Measurement Uncertainty

Expanded uncertainties stated are calculated with a coverage Factor k=2.
 Please note that these results are not taken into account when measurement uncertainty considerations contained in ETSI TR 100 028 Parts 1 and 2 determining compliance or non-compliance with test result.

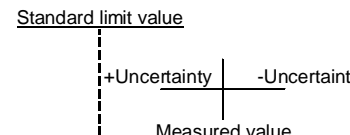
Test item	Measurement uncertainty
Conducted emission, AMN (9 kHz – 150 kHz)	±3.7 dB
Conducted emission, AMN (150 kHz – 30 MHz)	±3.3 dB
Radiated emission (9kHz – 30 MHz)	±3.2 dB
Radiated emission (30 MHz – 1000 MHz)	±5.5 dB
Radiated emission (1 GHz – 6 GHz)	±4.8 dB
Radiated emission (6 GHz – 18 GHz)	±4.4 dB
Radiated emission (18 GHz – 40 GHz)	±6.4 dB
Radio Frequency	±1.3 * 10 ⁻⁸
RF power, conducted	±0.7 dB
Adjacent channel power	±1.5 dB
Temperature	±0.6 °C
Humidity	±1.2 %
Voltage (DC)	±0.4 %
Voltage (AC, <10kHz)	±0.2 %

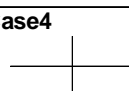
Judge	Measured value and standard limit value
PASS	<p>Case1</p>  <p>Even if it takes uncertainty into consideration, a standard limit value is fulfilled.</p>
	<p>Case2</p>  <p>Although measured value is in a standard limit value, a limit value won't be fulfilled if uncertainty is taken into consideration.</p>
FAIL	<p>Case3</p>  <p>Although measured value exceeds a standard limit value, a limit value will be fulfilled if uncertainty is taken into consideration.</p>
	<p>Case4</p>  <p>Even if it takes uncertainty into consideration, a standard limit value isn't fulfilled.</p>



Japan

6 Laboratory Information

Testing was performed and the report was issued at:

TÜV SÜD Japan Ltd. Yonezawa Testing Center

Address: 5-4149-7 Hachimanpara, Yonezawa-shi, Yamagata, 992-1128 Japan

Phone: +81-238-28-2881

Accreditation and Registration

A2LA

Certificate #3686.03

VLAC

Accreditation No.: VLAC-013

BSMI

Laboratory Code: SL2-IN-E-6018, SL2-A1-E-6018

Innovation, Science and Economic Development Canada

ISED#: 4224A

VCCI Council

Registration number: A-0166

Appendix A. Test Equipment

Antenna port conducted test

Equipment	Company	Model No.	Serial No.	Cal. Due	Cal. Date
Spectrum analyzer	Agilent Technologies	E4440A	US44302655	30-Sep-2022	01-Sep-2021
Attenuator	HUBER+SUHNER	6810.19.A	N/A(S450)	31-Dec-2022	21-Dec-2021
Microwave cable	Junkosha Inc.	MWX221/1m	N/A(S400)	31-Mar-2023	02-Mar-2022
Power divider	Keysight	11636B	MY51360915	30-Sep-2022	15-Sep-2021
Wideband Radio Frequency Tester	ROHDE&SCHWARZ	CMW500	116338	31-Aug-2022	04-Aug-2021
Temperature and humidity chamber	ESPEC	PL1KP	14007261	30-Sep-2022	21-Sep-2021

Radiated emission

Equipment	Company	Model No.	Serial No.	Cal. Due	Cal. Date
EMI Receiver	ROHDE&SCHWARZ	ESCI	100765	30-Sep-2022	15-Sep-2021
Spectrum analyzer	Agilent Technologies	E4440A	US40420937	31-Dec-2022	13-Dec-2021
Preamplifier	SONOMA	310	372170	30-Sep-2022	15-Sep-2021
Biconical antenna	Schwarzbeck	VHBB9124/BBA9106	1333	31-Dec-2022	15-Dec-2021
Log periodic antenna	Schwarzbeck	VUSLP9111B	346	31-Oct-2022	15-Oct-2021
Attenuator	TOYO Connector	NA-PJ-6/6dB	N/A(S541)	30-Sep-2022	16-Sep-2021
Attenuator	TAMAGAWA.ELEC	CFA-10/3dB	N/A(S503)	31-Jul-2022	20-Jul-2021
Preamplifier	TSJ	MLA-100M18-B02-40	1929118	31-Dec-2022	22-Dec-2021
Attenuator	AEROFLEX	26A-10	081217-08	31-Dec-2022	22-Dec-2021
Double ridged guide antenna	ETS LINDGREN	3117	00052315	31-May-2022	24-May-2021
Attenuator	HUBER+SUHNER	6803.17.B	N/A(2340)	31-Dec-2022	23-Dec-2021
Double ridged guide antenna	A.H.Systems Inc.	SAS-574	469	31-Aug-2022	02-Aug-2021
Preamplifier	TSJ	MLA-1840-B03-35	1240332	31-Aug-2022	02-Aug-2021
Band rejection filter	Micro-Tronics	BRC50720	014	31-Dec-2022	20-Dec-2021
Signal generator	ROHDE&SCHWARZ	SMB100A	177525	31-Dec-2022	08-Dec-2021
RF power amplifier	R&K	CGA020M602-2633R	B40240	30-Jun-2022	02-Jun-2021
Attenuator	HUBER+SUHNER	6820.19.A	N/A(2399)	30-Sep-2022	15-Sep-2021
Microwave cable	HUBER+SUHNER	SUCOFELX102/2m	31648	31-Mar-2023	02-Mar-2022
Dipole antenna	Schwarzbeck	VHAP	1021	31-Jul-2022	28-Jul-2021
Dipole antenna	Schwarzbeck	UHAP	993	31-Jul-2022	28-Jul-2021
Double ridged guide antenna	ETS LINDGREN	3117	00218815	31-Dec-2022	06-Dec-2021
Wideband Radio Frequency Tester	ROHDE&SCHWARZ	CMW500	126079	30-Nov-2022	15-Nov-2021
Wideband Radio Frequency Tester	ROHDE&SCHWARZ	CMW500	116338	31-Aug-2022	04-Aug-2021
Microwave cable	HUBER+SUHNER	SUCOFLEX104/9m	MY30037/4	31-Dec-2022	22-Dec-2021
		SUCOFLEX104/1m	my24610/4	31-Dec-2022	22-Dec-2021
		SUCOFLEX104/8m	SN MY30033/4	31-Dec-2022	22-Dec-2021
		SUCOFLEX104/1m	MY32976/4	31-Dec-2022	22-Dec-2021
		SUCOFLEX104/2m	SN MY28404/4	31-Dec-2022	22-Dec-2021
		SUCOFLEX104/7m	41625/6	31-Dec-2022	22-Dec-2021
PC	DELL	DIMENSION E521	75465BX	N/A	N/A
Software	TOYO Corporation	EP5/RE-AJ	0611193/V6.0.140	N/A	N/A
Absorber	RIKEN	PPF30	N/A	N/A	N/A
3m Semi an-echoic Chamber	TOKIN	N/A	N/A(9002-NSA)	31-May-2022	20-May-2021
3m Semi an-echoic Chamber	TOKIN	N/A	N/A(9002-SVSWR)	31-May-2022	20-May-2021

*: The calibrations of the above equipment are traceable to NIST or equivalent standards of the reference organizations.