

Report on the EMC Testing of:

KYOCERA Corporation
Mobile Phone, Model: EB1086

In accordance with FCC Part 15 Subpart B Class B

Prepared for: KYOCERA Corporation
Yokohama Office 2-1-1 Kagahara, Tsuzuki-ku,
Yokohama-shi, Kanagawa, 224-8502 Japan
Phone: +81-45-943-6253 Fax: +81-45-943-6314



Japan

**Add value.
Inspire trust.**

COMMERCIAL-IN-CONFIDENCE

Document Number: JPD-TR-21140-0

SIGNATURE

--	--	--	--

NAME	JOB TITLE	RESPONSIBLE FOR	ISSUE DATE
Hiroaki Suzuki	Deputy Manager of RF Group	Approved Signatory	

Signatures in this approval box have checked this document in line with the requirements of TÜV SÜD Japan Ltd. document control rules.

EXECUTIVE SUMMARY – Result: Complied

A sample of this product was tested and the result above was confirmed in accordance with FCC Part 15 Subpart B (excluding the deviations mentioned in section 1.4 of this document).



DISCLAIMER AND COPYRIGHT

The results in this report are applicable only to the equipment tested.
This report shall not be re-produced except in full without the written approval of TÜV SÜD Japan Ltd.

Client provided data, for which TÜV SÜD Japan Ltd. takes no responsibility, which can affect validity of results within this report is clearly identified.

ACCREDITATION

This test report must not be used by the client to claim product certification, approval, or endorsement by A2LA or any agency of the federal government.

TÜV SÜD Japan Ltd.
Yonezawa Testing Center
5-4149-7 Hachimanpara,
Yonezawa-shi, Yamagata,
992-1128 Japan

Phone: +81 (0) 238 28 2881
Fax: +81 (0) 238 28 2888
www.tuv-sud.jp

**Additional signatures required by FCC 47 CFR Part 2, § 2.938 (b) (10)****Signatures of the individuals responsible for testing the product**

ENGINEERING STATEMENT

The measurements shown in this report were made in accordance with the procedures described on test pages. All reported testing was carried out on a sample equipment to demonstrate limited compliance with FCC Part 15 Subpart B. The sample tested was found Complied compliant with the requirements defined in the applied rules.

NAME	RESPONSIBLE FOR	SIGNATURE
Tsuyoshi Okumura	Testing	
Nobuhiko Iwasawa	Testing	

Contents

1	Summary of Test	4
1.1	Modification history of the test report	4
1.2	Standards	4
1.3	Measurement standards	4
1.4	Deviation from standards	4
1.5	List of applied test(s) of the EUT	4
1.6	Test information	4
1.7	Test set up	4
1.8	Test period	4
2	Equipment Under Test	5
2.1	EUT information	5
2.2	Modification to the EUT	5
2.3	Variation of family model(s)	5
2.4	Operation mode	6
3	Configuration of Equipment	7
3.1	Equipment used	7
3.2	Cable(s) used	7
3.3	System configuration	8
4	Test Result	9
4.1	Conducted emission at mains port	9
4.2	Radiated emission (below 1 GHz)	11
4.3	Radiated emission (above 1 GHz)	16
5	Measurement Uncertainty	22
6	Laboratory Information	23
	Appendix A. Test Equipment	24



1 Summary of Test

1.1 Modification history of the test report

Document Number	Modification History	Issue Date
JPD-TR-21140-0	First Issue	Refer to the cover page

1.2 Standards

FCC Part 15 Subpart B

1.3 Measurement standards

ANSI C63.4 2014

1.4 Deviation from standards

None

1.5 List of applied test(s) of the EUT

Regarding judgment of conformance to Emission test, a value of measurement uncertainty was not taken in account.

Test Name	Classification of EUT	Test	Worst Point (Margin)	Result	Remarks
Conducted emission at mains port	Class B	Applied	MP4(No earphone) + USB Read with PC mode L2 0.150 MHz QP 13.2 dB	Pass	-
Radiated emission (below 1 GHz)	Class B	Applied	Out Camera with ADP mode V 60.575 MHz QP 5.7 dB	Pass	-
Radiated emission (above 1 GHz)	Class B	Applied	MP4(No earphone) + USB Read with PC mode V 2999.901 MHz AV 14.3 dB	Pass	-

1.6 Test information

The following contents were tested based on the conditions specified by the applicant.

- Tested supply voltage and supply frequency
- Operation mode

1.7 Test set up

Table-top

1.8 Test period

17-August-2021 - 19-August-2021

2 Equipment Under Test

All information in this chapter was provided by the applicant.

2.1 EUT information

Applicant	KYOCERA Corporation Yokohama Office 2-1-1 Kagahara, Tsuzuki-ku, Yokohama-shi, Kanagawa, 224-8502 Japan Phone: +81-45-943-6253 Fax: +81-45-943-6314
Equipment Under Test (EUT)	Mobile Phone
Model number	EB1086
Serial number	EMC①
Trade name	KYOCERA
Authorization	JOYEB1086
Number of sample(s)	1
EUT condition	Pre-production
Maximum frequency	2.0 GHz
Power rating	Battery: DC 3.87 V
Size	(W) 161 × (D) 71 × (H) 8.9 mm

2.2 Modification to the EUT

The table below details modifications made to the EUT during the test project.

Modification State	Description of Modification	Modification fitted by	Date of Modification
EB1086, S/N: EMC①			
0	As supplied by the applicant	Not Applicable	Not Applicable

2.3 Variation of family model(s)

2.3.1 List of family model(s)

Not applicable

2.3.2 Reason for selection of EUT

Not applicable



Japan

2.4 Operation mode

1. In Camera with ADP mode

- i) Power ON
- ii) Record

2. Out Camera with ADP mode

- i) Power ON
- ii) Record

3. MP4 with Earphone mode

- i) Power ON
- ii) Execution of Color Bar moving picture data

4. MP4 (No earphone) + USB Read with PC mode

- i) Power ON
- ii) EUT connects to PC via USB cable
- iii) Read / write of MP4 moving picture data
- iv) Execution of Color Bar moving picture data

3 Configuration of Equipment

Numbers assigned to equipment or cables in "3.1 Equipment(s) used" and "3.2 Cable(s) used" correspond to numbers in "3.3 System configuration".

Cabling and setup(s) were taken into consideration and test data was taken under worse case condition.

3.1 Equipment used

No.	Equipment	Company	Model No.	Serial No.	FCC ID /DoC	Remarks
EUT1	Mobile Phone	KYOCERA	EB1086	EMC1	JOYEB1086	EUT
AE1	AC adapter	KDDI	0602PQA	NKA	N/A	*1
AE2	Earphone	N/A	N/A	N/A	N/A	-
AE3	Personal Computer	Lenovo	TYPE 7854-CTO	LR-0GDNF	DoC	*2
AE4	AC adapter	Lenovo	42T4418	11S42T4418ZGWW21 2MKX REV:H	N/A	*2

*1: AC adapter is connected to keep operating.

*2: The property of TÜV SÜD Japan was used.

3.2 Cable(s) used

No.	Cable	Length (m)	Shield	EUT accessory Ferrite core	Remarks
a	DC cable	1.5	Yes	-	-
b	USB cable	0.1	Yes	-	-
c	Earphone cable	0.7	No	-	-
d	USB cable	1.0	Yes	-	-
e	DC cable for PC AC adapter	1.8	No	-	*1
f	AC power cord for PC AC adapter	0.8	No	-	*1

*1: The property of TÜV SÜD Japan was used.

3.3 System configuration

1. In Camera with ADP mode
2. Out Camera with ADP mode

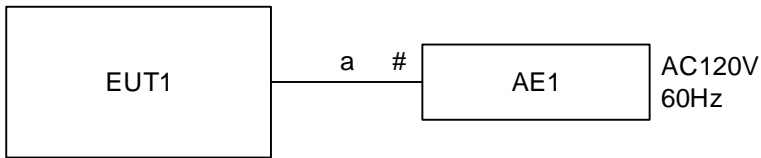

: Un-detachable cable

3. MP4 with Earphone mode

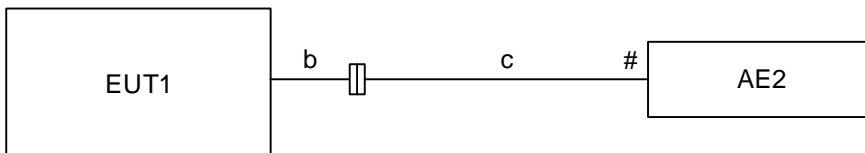

☐ : Connector
: Un-detachable cable

4. MP4 (No earphone) + USB Read with PC mode

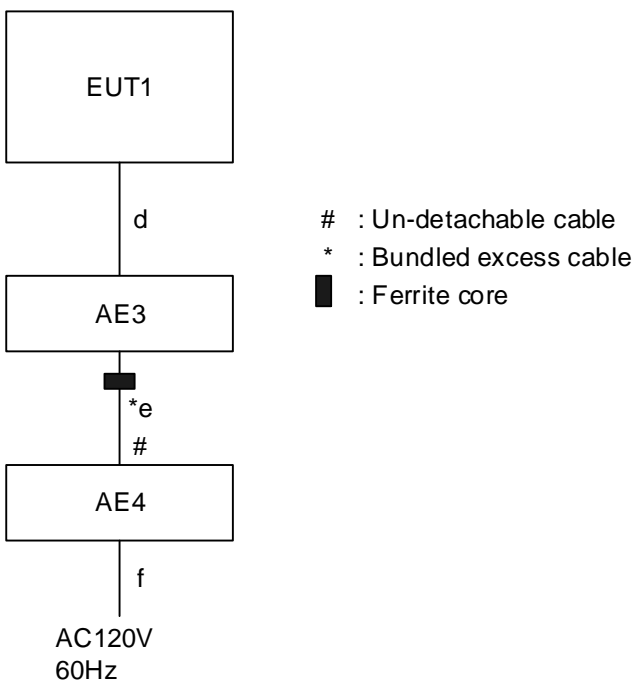

: Un-detachable cable
* : Bundled excess cable
■ : Ferrite core

4 Test Result

4.1 Conducted emission at mains port

4.1.1 Measurement condition

Frequency range	0.15 MHz-30 MHz
Test place	10 m Semi-Anechoic Chamber No. 1
EUT was placed on	FRP table (W) 2.0 × (D) 1.0 × (H) 0.8 m
Metal reference plane	Vertical
Test receiver setting	Detector: Quasi-peak, Average Bandwidth: 9 kHz
Line Impedance Stabilization Network (LISN)	Specification: 50 Ω/50 μH Distance from EUT: 0.8 m

EUT is placed on a non-conducting table for table-top equipment or on insulation material for a floor-standing equipment. In addition, a table-top equipment is located 0.4 m to a metal reference plane.

Line Impedance Stabilization Network (LISN) is placed 0.8 m away from the EUT. The power code of the EUT is connected to LISN and its excess part is bundled in the center. The length of bundling is 0.3-0.4 m.

A power code of a peripheral is connected to LISN and terminated into 50 Ω.

Excess cables between equipment are bundled in the center. The length of bundling is 0.3-0.4 m.

Where LISN cannot be applied, the test is performed using a voltage probe.

After overall frequency range is investigated with spectrum analyzer using peak detector, measurements are performed with test receiver in setting to the defined values.

4.1.2 Calculation method

Emission level = Reading + c.f. (correction factor)*

Margin = Limit – Emission level

*Note: c.f. = LISN factor + Cable system loss + Attenuator loss

Example)

Limit @ 6.770 MHz:	60.0 dBμV (Quasi-peak) 50.0 dBμV (Average)
Quasi-peak	Reading = 41.2 dBμV c.f. = 10.3 dB Emission level = 41.2 + 10.3 = 51.5 dBμV Margin = 60.0 - 51.5 = 8.5 dB
Average	Reading = 35.0 dBμV c.f. = 10.3 dB Emission level = 35.0 + 10.3 = 45.3 dBμV Margin = 50.0 - 45.3 = 4.7 dB



4.1.3 Test data and Configuration photographs

Operation mode	MP4 (No earphone) + USB Read with PC mode
EUT	EB1086, S/N: EMC① - Modification State 0

Date of test: 17-August-2021 Supply voltage: AC 120 V Supply frequency: 60 Hz

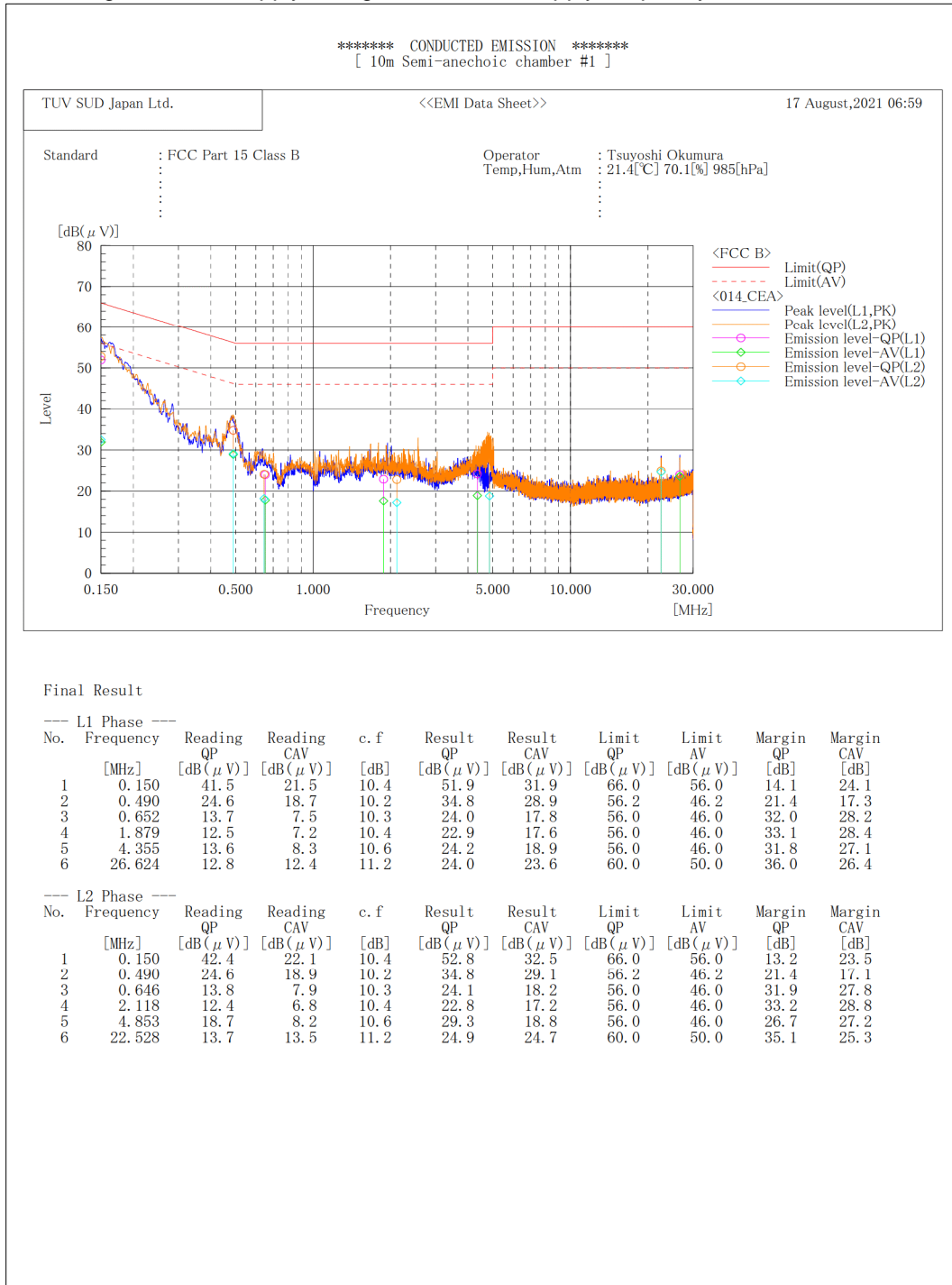

4.2 Radiated emission (below 1 GHz)

4.2.1 Measurement condition

Frequency range	30 MHz-1000 MHz
Test place	10 m Semi-Anechoic Chamber No. 1
EUT was placed on	FRP table (W) 2.0 × (D) 1.0 × (H) 0.8 m
Axis	0°-360°
Antenna	Distance from EUT: 3 m Height: 1-4 m Polarity: Horizontal/Vertical
Test receiver setting	Detector: Quasi-peak Bandwidth: 120 kHz

EUT is placed on a non-conducting table for table-top equipment or on insulation material for a floor-standing equipment. The non-conducting table or the insulation material is placed on a rotating turn table.

Excess cables between equipment are bundled in the center. The length of bundling is 0.3-0.4 m.

An antenna is adjusted between 1-4 m in height and varied its polarization (horizontal and vertical), and the EUT azimuth is varied by the rotating turntable 0 to 360 degrees.

After overall frequency range is investigated with spectrum analyzer using peak detector, measurements are performed with test receiver in setting to the defined values.

4.2.2 Calculation method

Emission level = Reading + c.f. (correction factor)*

Margin = Limit - Emission level

*Note: c.f. = Antenna factor + Cable system loss + Attenuator loss - Amplifier Gain

Example)

Limit @ 350.0 MHz: 37.0 dB μ V/m

Reading = 41.1 dB μ V c.f. = -11.8 dB/m

Emission level = 41.1 - 11.8 = 29.3 dB μ V/m

Margin = 37.0 - 29.3 = 7.7 dB



4.2.3 Test data and Configuration photographs

Operation mode	In Camera with ADP mode
EUT	EB1086, S/N: EMC① - Modification State 0

Date of test: 18-August-2021 Supply voltage: AC 120 V Supply frequency: 60 Hz

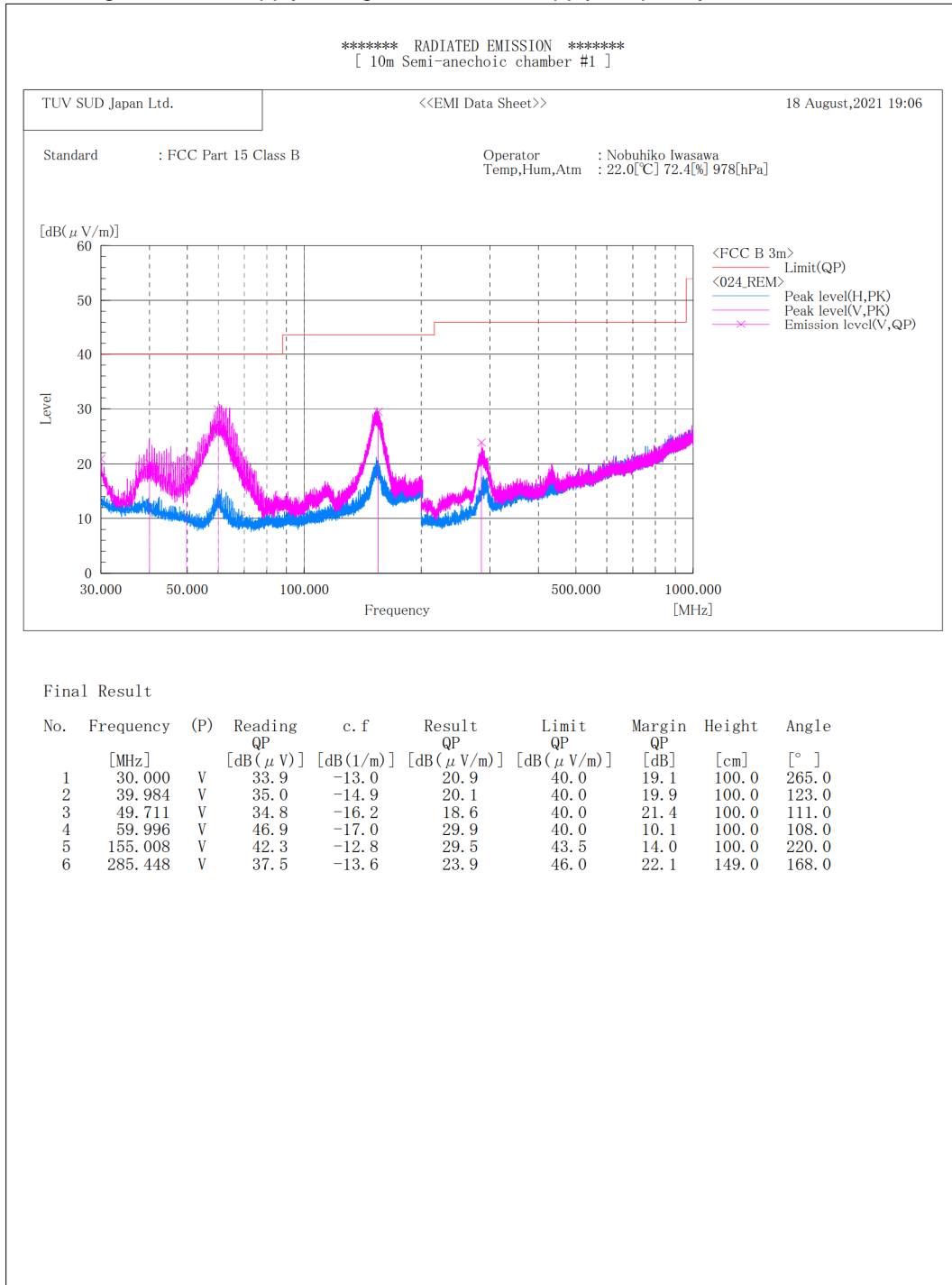



Japan

Operation mode	Out Camera with ADP mode
EUT	EB1086, S/N: EMC① - Modification State 0

Date of test: 18-August-2021 Supply voltage: AC 120 V Supply frequency: 60 Hz

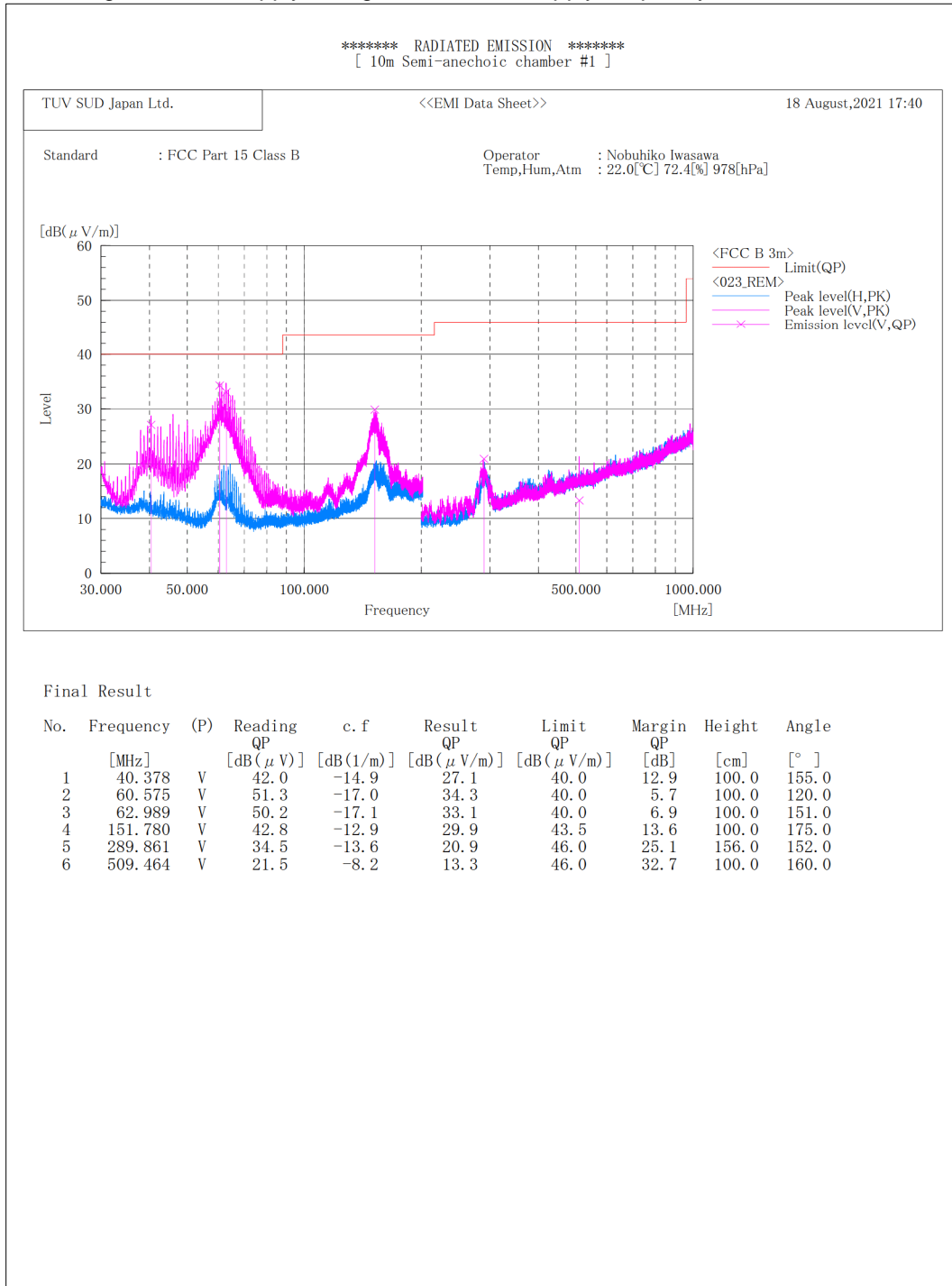



Japan

Operation mode	MP4 with Earphone mode
EUT	EB1086, S/N: EMC① - Modification State 0

Date of test: 17-August-2021 Supply voltage: DC 3.87 V

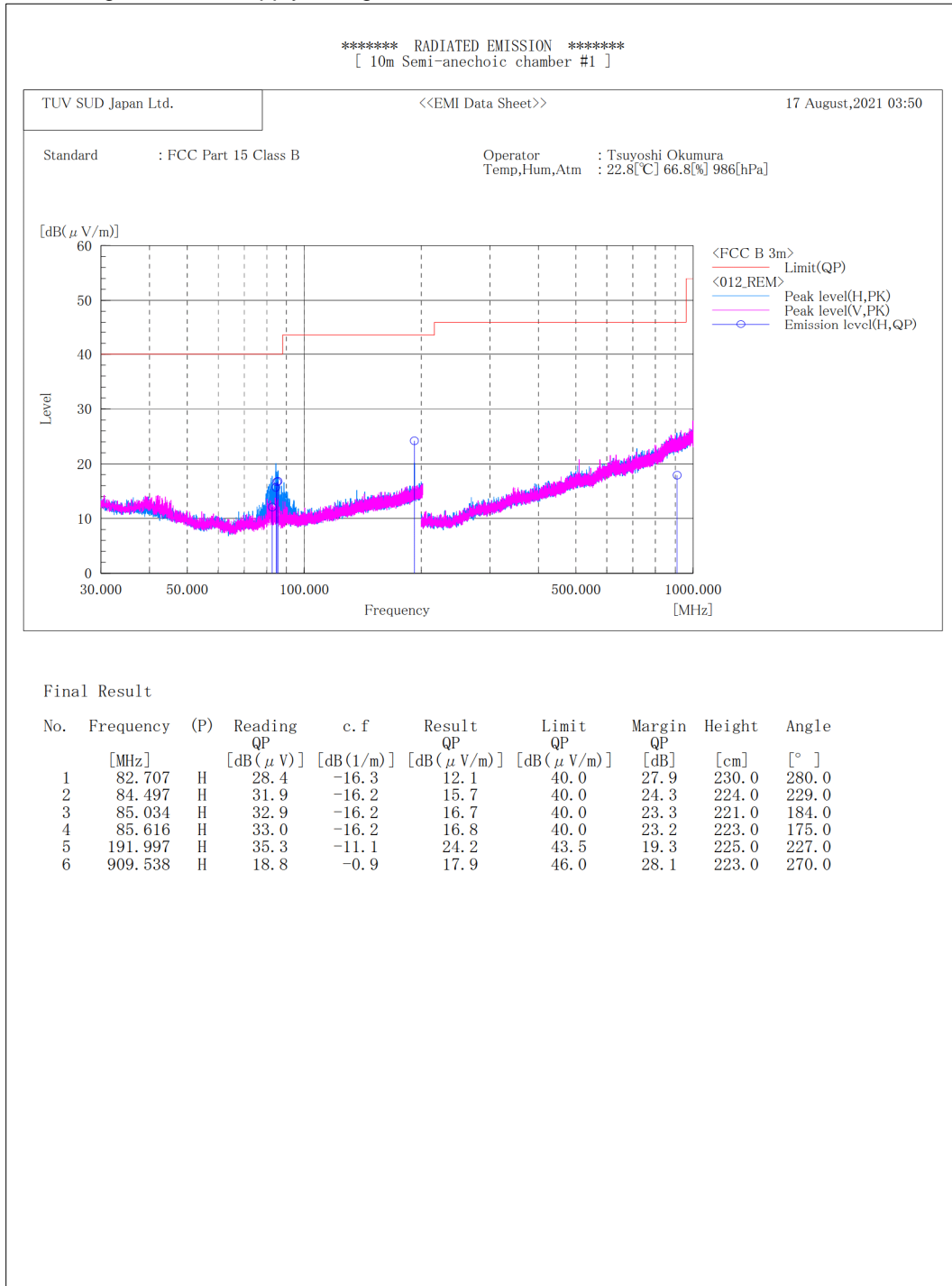



Japan

Operation mode	MP4 (No earphone) + USB Read with PC mode
EUT	EB1086, S/N: EMC① - Modification State 0

Date of test: 17-August-2021 Supply voltage: AC 120 V Supply frequency: 60 Hz

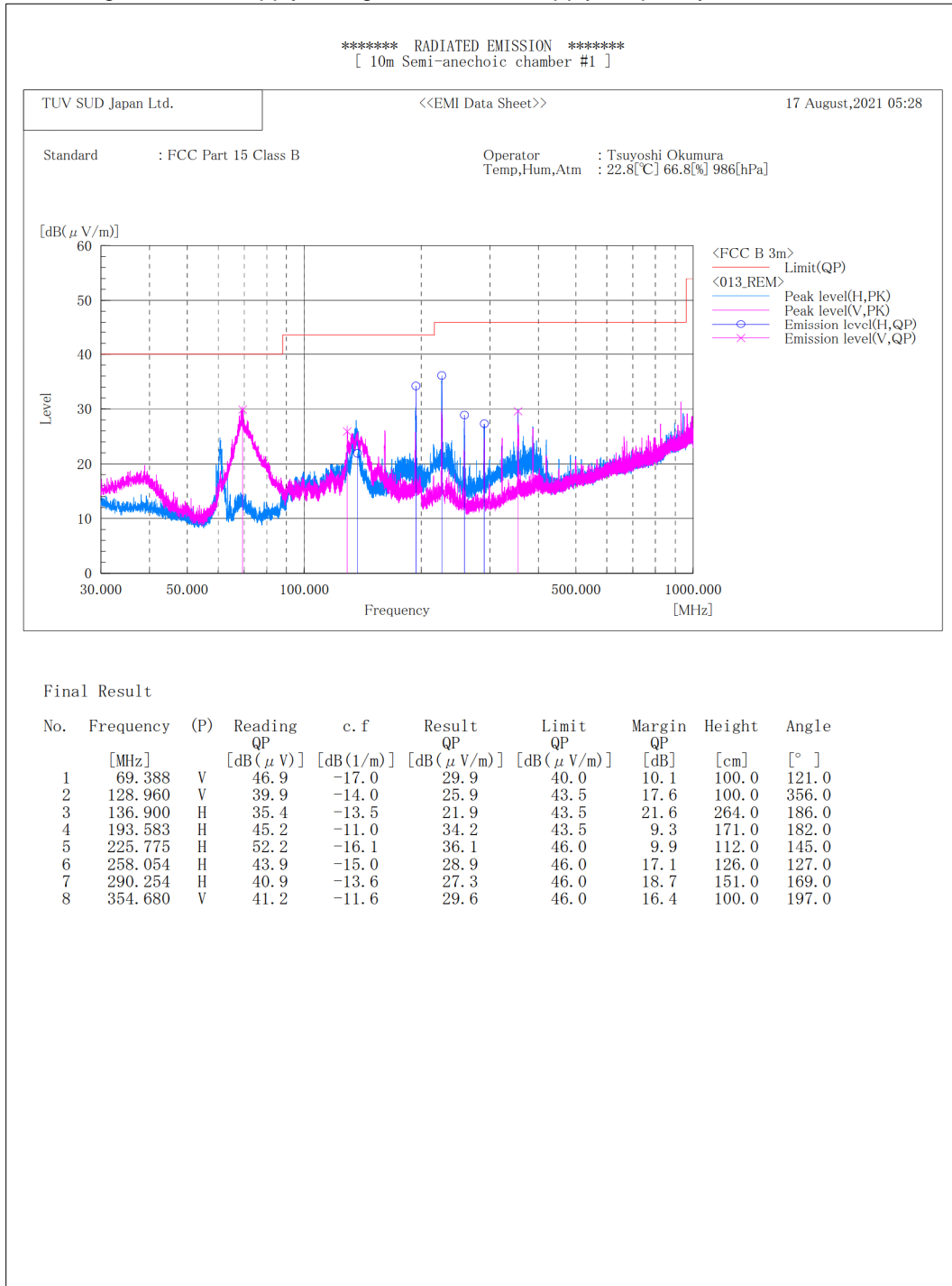

4.3 Radiated emission (above 1 GHz)

4.3.1 Measurement condition

Frequency range	1000 MHz-10000 MHz
Test place	10 m Semi-Anechoic Chamber No. 1
EUT was placed on	Styrene foam table (W) 2.0 × (D) 1.0 × (H) 0.8 m
Axis	0°-360°
Antenna	Distance: 3.90 m, 4.07 m, 4.09 m Height: 1-4 m Polarity: Horizontal/Vertical
Test receiver setting	Detector: Peak, Average Bandwidth: 1 MHz

EUT is placed on a styrene form table for table-top equipment or on insulation material for a floor-standing equipment. The styrene form table or the insulation material is placed on a rotating turn table.

Excess cables between equipment are bundled in the center. The length of bundling is 0.3-0.4 m.

Absorbers are placed between the EUT and an antenna.

The antenna is adjusted between 1-4 m in height and varied its polarization (horizontal and vertical), and the EUT azimuth is varied by the rotating turntable 0 to 360 degrees. Where height of the antenna is changed, its angle is also adjusted to the position of the EUT.

After overall frequency range is investigated with spectrum analyzer using peak detector, measurements are performed with test receiver in setting to the defined values.

The antenna is positioned from the test volume that was predetermined by the site VSWR measurement. Since this predetermined test volume is different from maximum circumference where the EUT and the peripheral devices are actually placed, the measurement distance conversion factor is added to the measurement data.

Antenna 3 dB beamwidth (antenna used: 3117)

Antenna: 3115

Frequency (GHz)	θ3 dB (°)	3 dB beamwidth w (m)
1.0	63	3.68
2.0	47	2.61
3.0	38	2.07
4.0	36	1.95
5.0	40	2.18
6.0	44	2.42

Antenna: 3117

Frequency (GHz)	θ3 dB (°)	3 dB beamwidth w (m)
1.0	82	5.22
2.0	60	3.46
3.0	76	4.69
4.0	56	3.19
5.0	54	3.06
6.0	50	2.80

Measurement distance: $d = 3.0$ m

$W = 2 \times d \times \tan(0.5 \times \theta_{3 \text{ dB}})$

4.3.2 Calculation method

Emission level = Reading + Measurement distance conversion factor + c.f. (correction factor)*

Margin = Limit - Emission level

*Note: c.f. = Antenna factor + Cable system loss + Attenuator loss - Amplifier Gain

Example)

Limit @ 1100.0 MHz: 70.0 dB μ V/m (Peak)
50.0 dB μ V/m (Average)

Measurement distance: 3.25 m

Measurement distance conversion factor: $20 \log (3.25\text{m}/3.0\text{m}) = 0.7 \text{ dB}$

Peak	Reading = 50.2 dB μ V, Measurement distance conversion factor = 0.7 dB, c.f. = 1.7 dB/m Emission level = $50.2 + 0.7 + 1.7 = 52.6 \text{ dB}\mu\text{V/m}$ Margin = $70.0 - 52.6 = 17.4 \text{ dB}$
Average	Reading = 32.0 dB μ V, Measurement distance conversion factor = 0.7 dB, c.f. = 1.7 dB/m Emission level = $32.0 + 0.7 + 1.7 = 34.4 \text{ dB}\mu\text{V/m}$ Margin = $50.0 - 34.4 = 15.6 \text{ dB}$

4.3.3 Test data and Configuration photographs

Operation mode	In Camera with ADP mode
EUT	EB1086, S/N: EMC① - Modification State 0

Date of test: 18-August-2021 Supply voltage: AC 120 V Supply frequency: 60 Hz

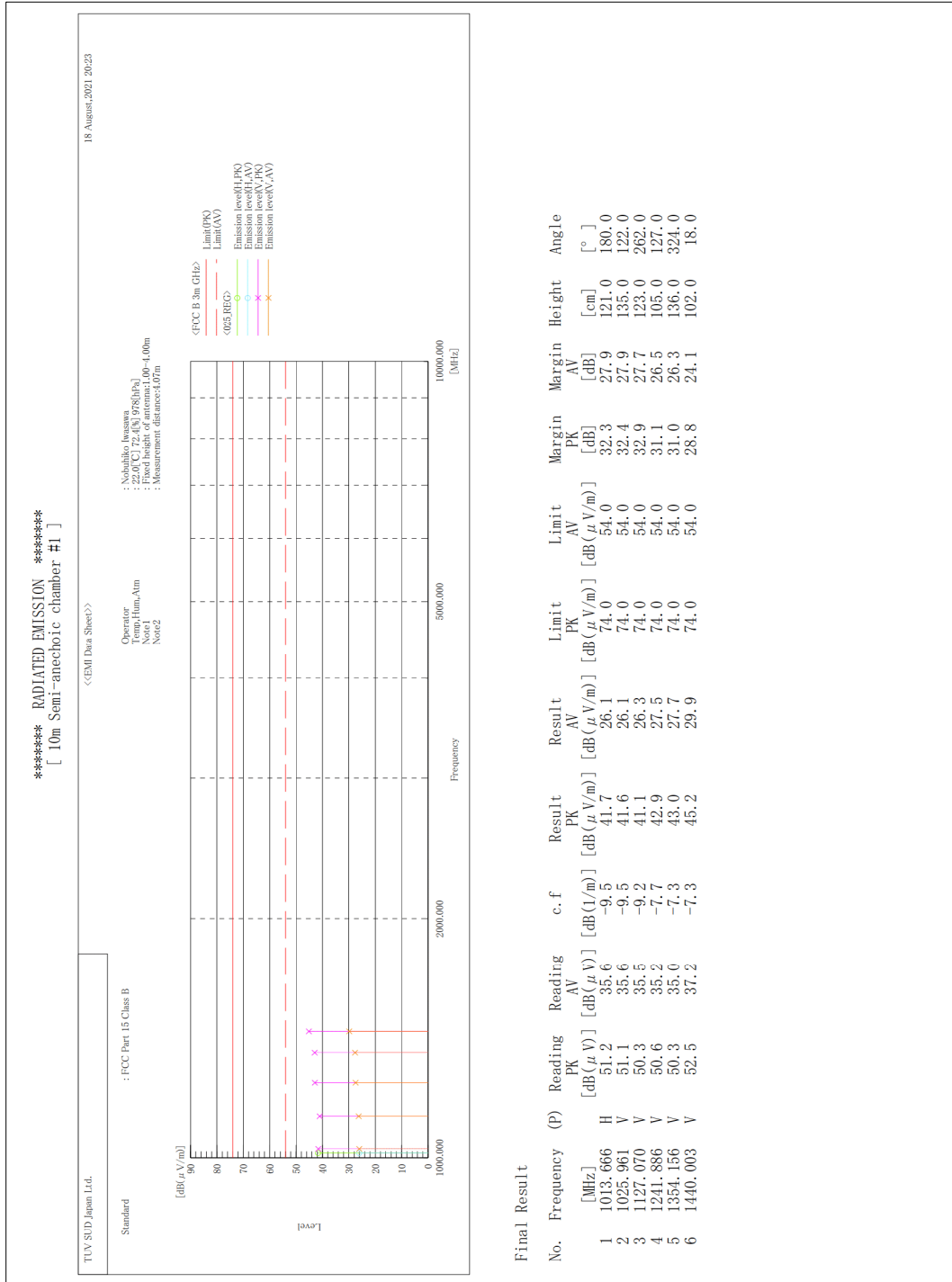

Operation mode	Out Camera with ADP mode
EUT	EB1086, S/N: EMC① - Modification State 0

Date of test: 18-August-2021 Supply voltage: AC 120 V Supply frequency: 60 Hz

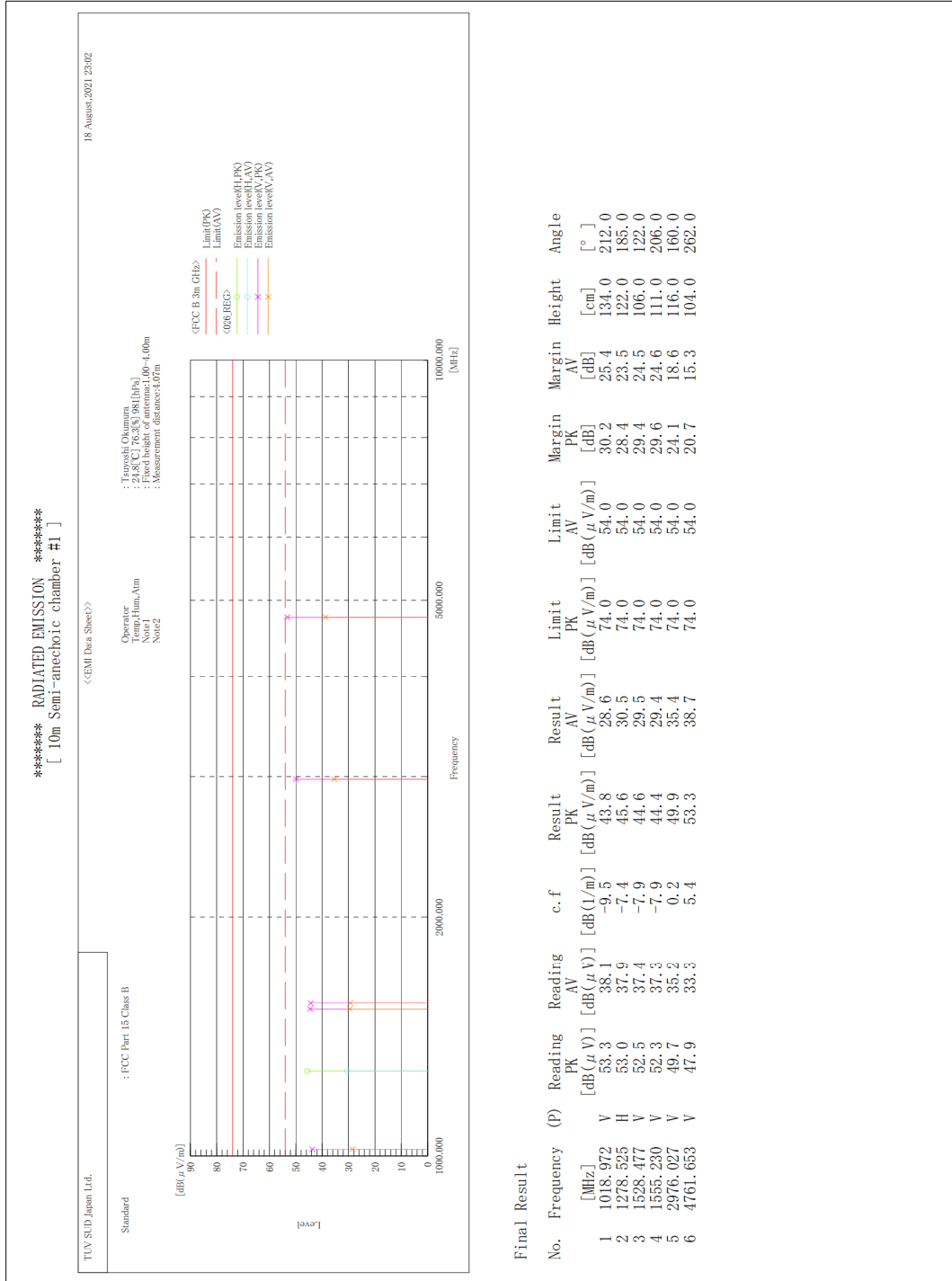

Operation mode	MP4 with Earphone mode
EUT	EB1086, S/N: EMC① - Modification State 0

Date of test: 19-August-2021 Supply voltage: DC 3.87 V

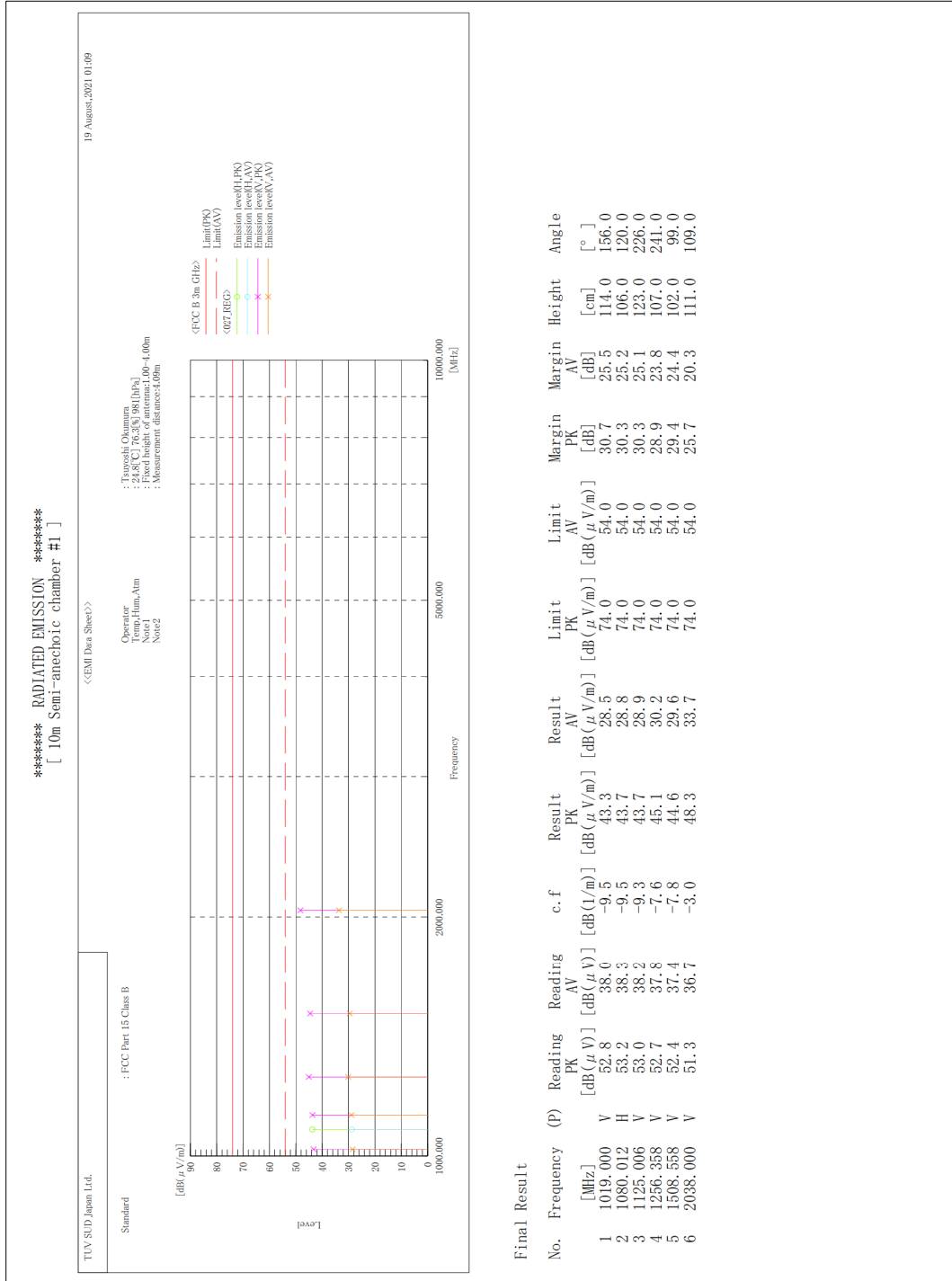

Operation mode	MP4 (No earphone) + USB Read with PC mode
EUT	EB1086, S/N: EMC① - Modification State 0



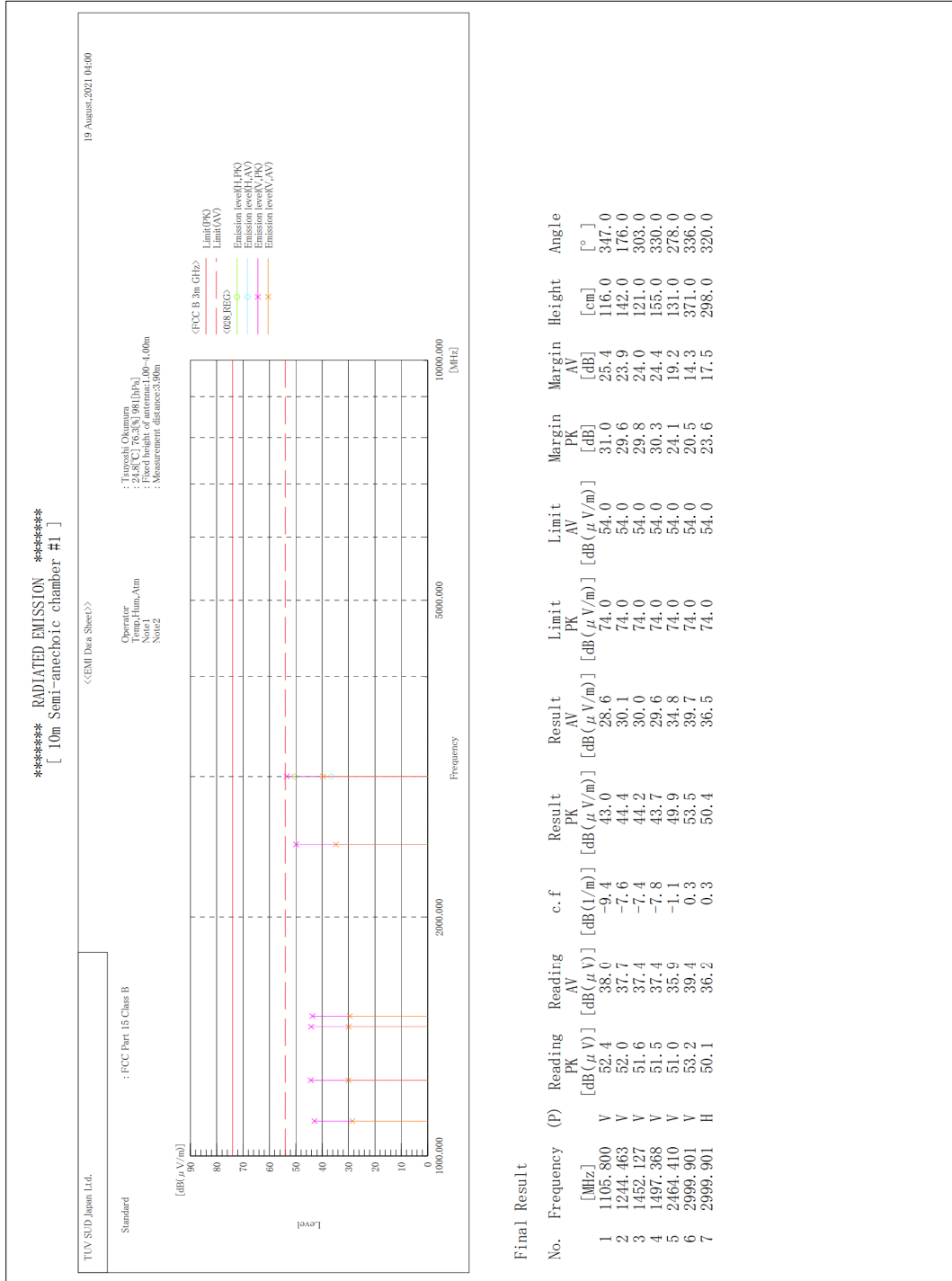

Date of test: 19-August-2021 Supply voltage: AC 120 V Supply frequency: 60 Hz

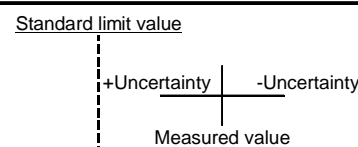

5 Measurement Uncertainty

The reported measurement uncertainty is based on a value obtained by multiplying standard uncertainty by coverage factor of $k=2$, and a level of confidence becomes 95 %.

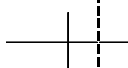
Item	Parameter	U_{lab}	U_{cispr}
Conducted Emission, V-AMN	9kHz to 150kHz	± 3.7 dB	± 3.8 dB
Conducted Emission, V-AMN	150kHz to 30MHz	± 3.3 dB	± 3.4 dB
Conducted Emission, Δ -AN	150kHz to 30MHz	± 4.9 dB	-
Conducted Emission, AN	150kHz to 30MHz	± 4.3 dB	-
Conducted Emission, AAN	150kHz to 30MHz	± 4.8 dB	± 5.0 dB
Conducted Emission, Voltage Probe	9kHz to 30MHz	± 2.8 dB	± 2.9 dB
Conducted Emission, Current Probe	150kHz to 30MHz	± 2.9 dB	± 2.9 dB
Disturbance Power	30MHz to 300MHz	± 3.8 dB	± 4.5 dB
Radiated Emission	30MHz to 1000MHz	± 5.5 dB	± 6.3 dB
Radiated Emission	1GHz to 6GHz	± 4.9 dB	± 5.2 dB
Radiated Emission	6GHz to 18GHz	± 4.6 dB	± 5.5 dB
Radiated Emission	9kHz to 30MHz	± 3.2 dB	-

Judge	Measured value and standard limit value	
PASS	<p>Case1</p>  <p>Standard limit value</p> <p>+Uncertainty -Uncertainty</p> <p>Measured value</p>	Even if it takes uncertainty into consideration, a standard limit value is fulfilled.
	<p>Case2</p> 	Although measured value is in a standard limit value, a limit value won't be fulfilled if uncertainty is taken into consideration.
FAIL	<p>Case3</p> 	Although measured value exceeds a standard limit value, a limit value will be fulfilled if uncertainty is taken into consideration.
	<p>Case4</p> 	Even if it takes uncertainty into consideration, a standard limit value isn't fulfilled.



Japan

6 Laboratory Information

Testing was performed and the report was issued at:

TÜV SÜD Japan Ltd. Yonezawa Testing Center

Address: 5-4149-7 Hachimanpara, Yonezawa-shi, Yamagata, 992-1128 Japan
Phone: +81-238-28-2881
Fax: +81-238-28-2888

Accreditation and Registration

A2LA
Certificate #3686.03

VLAC
Accreditation No.: VLAC-013

BSMI
Laboratory Code: SL2-IN-E-6018, SL2-A1-E-6018

Innovation, Science and Economic Development Canada
ISED#: 4224A

VCCI Council
Registration number: A-0166

Appendix A. Test Equipment

Conducted emission at mains port

Equipment	Company	Model No.	Serial No.	Cal. due	Cal. Date
EMI Receiver	ROHDE&SCHWARZ	ESR7	101187	30-Apr-2022	27-Apr-2021
Line impedance stabilization network	Kyoritsu Technology Corporation	TNW-407F2	12-17-110-2	30-Jun-2022	17-Jun-2021
Attenuator	HUBER+SUHNER	6810.01.A	N/A(S420)	30-Jun-2022	03-Jun-2021
Coaxial cable	FUJIKURA	5D-2W/4m	N/A(S349)	31-Oct-2021	28-Oct-2020
Microwave cable	HUBER+SUHNER	SUCOFLEX104/2m	317672/4	31-Oct-2021	28-Oct-2020
Coaxial cable	HUBER+SUHNER	RG214/U/25m	N/A(S191)	31-Oct-2021	28-Oct-2020
Software	TOYO Corporation	EP5/CE-AJ	0611193/V5.4.11	N/A	N/A

Radiated emission (below 1 GHz)

Equipment	Company	Model No.	Serial No.	Cal. due	Cal. date
EMI Receiver	ROHDE&SCHWARZ	ESR7	101187	30-Apr-2022	27-Apr-2021
Biconical antenna	Schwarzbeck	VHBB9124/BBA9106	1332	31-Oct-2021	19-Oct-2020
Log-periodic antenna	Schwarzbeck	VUSLP9111B	346	30-Sep-2021	09-Sep-2020
Attenuator	TDC	TAT-43B-06	N/A(S209)	31-Jul-2022	20-Jul-2021
Attenuator	TAMAGAWA.ELEC	CFA-10/3dB	N/A(S504)	31-Jul-2022	20-Jul-2021
Microwave cable	HUBER+SUHNER	SUCOFLEX104/9m	MY23758/4	31-Oct-2021	28-Oct-2020
Microwave cable	HUBER+SUHNER	SUCOFLEX104/1m	MY24628/4	31-Oct-2021	28-Oct-2020
Microwave cable	HUBER+SUHNER	SUCOFLEX104/2m	SN MY28398/4	31-Oct-2021	28-Oct-2020
Microwave cable	HUBER+SUHNER	SUCOFLEX106/13m	MY1159/6	31-Oct-2021	28-Oct-2020
Preamplifier	SONOMA	310	400315	31-Mar-2022	11-Mar-2021
10m Semi-anechoic Chamber	TOKIN	N/A	N/A(9001-NSA3m)	31-May-2022	21-May-2021
Software	TOYO Corporation	EP5/RE-AJ	0611193/V5.6.0	N/A	N/A

Radiated emission (above 1 GHz)

Equipment	Company	Model No.	Serial No.	Cal. due	Cal. date
Spectrum analyzer	ROHDE&SCHWARZ	FSV40	101732	31-Mar-2022	18-Mar-2021
Preamplifier	TSJ	MLA-0118-J02-40	14882	31-Oct-2021	28-Oct-2020
Double ridged guide antenna	ETS LINDGREN	3117	00209352	31-Dec-2021	21-Dec-2020
Attenuator	Agilent Technologies	8491B	MY39268632	30-Jun-2022	02-Jun-2021
Microwave cable	HUBER+SUHNER	SUCOFLEX104/9m	800693/4	30-Jun-2022	03-Jun-2021
Microwave cable	HUBER+SUHNER	SUCOFLEX104/1.5m	SN MY19304/4	31-Oct-2021	28-Oct-2020
Microwave cable	HUBER+SUHNER	SUCOFLEX104/2m	SN MY28398/4	31-Oct-2021	28-Oct-2020
Microwave cable	HUBER+SUHNER	SUCOFLEX106/13m	MY1159/6	31-Oct-2021	27-Oct-2020
Absorber	RIKEN	PFP30	N/A	N/A	N/A
10m Semi-anechoic Chamber	TOKIN	N/A	N/A(9001-SVSWR)	31-May-2022	21-May-2021
Software	TOYO Corporation	EP5/RE-AJ	0611193/V6.0.140	N/A	N/A