

## Report on the RF Testing of:

KYOCERA Corporation  
Mobile Phone, Model: DB62  
FCC ID: JOYDB62

In accordance with FCC Part 27 Subpart C  
and FCC Part 27 Subpart L

Prepared for: KYOCERA Corporation  
Yokohama Office 2-1-1 Kagahara, Tsuzuki-ku  
Yokohama-shi, Kanagawa, Japan  
Phone: +81-45-943-6253 Fax: +81-45-943-6314



Japan

Add value.  
Inspire trust.

## COMMERCIAL-IN-CONFIDENCE

Document Number: JPD-TR-19170-0

### SIGNATURE

NAME	JOB TITLE	RESPONSIBLE FOR	ISSUE DATE
Hiroaki Suzuki	Deputy Manager of RF Group	Approved Signatory	28 OCT 2019

Signatures in this approval box have checked this document in line with the requirements of TÜV SÜD Japan Ltd. document control rules.

### EXECUTIVE SUMMARY

A sample(s) of this product was tested and found to be compliant with FCC Part 27 Subpart C and FCC Part 27 Subpart L.



### DISCLAIMER AND COPYRIGHT

The results in this report are applicable only to the equipment tested.  
This report shall not be re-produced except in full without the written approval of TÜV SÜD Japan Ltd.

### ACCREDITATION

This test report must not be used by the client to claim product certification, approval, or endorsement by NVLAP, NIST, or any agency of the federal government.

TÜV SÜD Japan Ltd.  
Yonezawa Testing Center  
5-4149-7 Hachimanpara,  
Yonezawa-shi, Yamagata,  
992-1128 Japan

Phone: +81 (0) 238 28 2881  
Fax: +81 (0) 238 28 2888  
[www.tuv-sud.jp](http://www.tuv-sud.jp)



## Contents

<b>1</b>	<b>Summary of Test</b> .....	<b>3</b>
1.1	Modification history of the test report.....	3
1.2	Standards.....	3
1.3	Test methods.....	3
1.4	Deviation from standards.....	3
1.5	List of applied test(s) of the EUT.....	3
1.6	Test information.....	3
1.7	Test set up.....	3
1.8	Test period.....	3
<b>2</b>	<b>Equipment Under Test</b> .....	<b>4</b>
2.1	EUT information.....	4
2.2	Modification to the EUT.....	5
2.3	Variation of family model(s).....	5
2.4	Description of test mode.....	5
<b>3</b>	<b>Configuration of Equipment</b> .....	<b>6</b>
3.1	Equipment used.....	6
3.2	System configuration.....	6
<b>4</b>	<b>Test Result</b> .....	<b>7</b>
4.1	Effective Radiated Power.....	7
4.2	Peak to Average Ratio.....	14
4.3	Occupied Bandwidth.....	21
4.4	Band Edge Spurious and Harmonic at Antenna Terminals.....	30
4.5	Radiated Emissions and Harmonic Emissions.....	63
4.6	Frequency Stability.....	74
<b>5</b>	<b>Measurement Uncertainty</b> .....	<b>76</b>
<b>6</b>	<b>Laboratory Information</b> .....	<b>77</b>
	<b>Appendix A. Test Equipment</b> .....	<b>78</b>

## 1 Summary of Test

### 1.1 Modification history of the test report

Document Number	Modification History	Issue Date
JPD-TR-19170-0	First Issue	Refer to the cover page

### 1.2 Standards

CFR47 FCC Part 27 Subpart C  
CFR47 FCC Part 27 Subpart L

### 1.3 Test methods

KDB 971168 D01 Power Meas License Digital Systems v03r01  
ANSI/TIA/EIA-603-D-2010

### 1.4 Deviation from standards

None

### 1.5 List of applied test(s) of the EUT

Test item section	Test item	Condition	Result	Remark
2.1046	Conducted Output Power	Conducted	PASS	*1
27.50	Effective Radiated Power	Radiated	PASS	-
27.50	Peak to Average Ratio	Conducted	PASS	-
2.1049	Occupied Bandwidth	Conducted	PASS	-
27.53 2.1051	Band Edge Spurious and Harmonic at Antenna Terminal	Conducted	PASS	-
27.53 2.1053	Radiated emissions and Harmonic Emissions	Radiated	PASS	-
27.54 2.1055	Frequency Stability	Conducted	PASS	-

\*1: Refer to RF Exposure Report (Test Report\_SAR)

### 1.6 Test information

None

### 1.7 Test set up

Table-top

### 1.8 Test period

5-August-2019 - 8-October-2019

## 2 Equipment Under Test

### 2.1 EUT information

Applicant	KYOCERA Corporation Yokohama Office 2-1-1 Kagahara, Tsuzuki-ku Yokohama-shi, Kanagawa, Japan Phone: +81-45-943-6253 Fax: +81-45-943-6314
Equipment Under Test (EUT)	Mobile Phone
Model number	DB62
Serial number	N/A
Trade name	Kyocera
Number of sample(s)	1
EUT condition	Pre-Production
Power rating	Battery: DC 3.8 V
Size	(W) 51.3 × (D) 17.9 × (H) 112.3 mm
Environment	Indoor and Outdoor use
Terminal limitation	-20°C to 60°C
Hardware version	DMT1
Software version	V0.030AN.0015.a
Firmware version	Not applicable
RF Specification	
Frequency of Operation	Up Link WCDMA Band IV: 1712.4-1752.6 MHz LTE Band IV: 1710.0-1755.0 MHz Down Link WCDMA Band IV: 2112.4-2152.6 MHz LTE Band IV: 2110.0-2155.0 MHz
Modulation type	WCDMA Band IV: QPSK, 16QAM LTE Band IV: QPSK, 16QAM
Emission designator	WCDMA Band IV: 4M18F9W LTE Band IV: BW 1.4M QPSK: 1M10G7D, 16QAM: 1M10W7D BW 3M QPSK: 2M71G7D, 16QAM: 2M71W7D BW 5M QPSK: 4M56G7D, 16QAM: 4M53W7D BW 10M QPSK: 8M99G7D, 16QAM: 8M99W7D BW 15M QPSK: 13M5G7D, 16QAM: 13M5W7D BW 20M QPSK: 17M9G7D, 16QAM: 18M0W7D
Effective Radiated Power (E.R.P.)	WCDMA Band IV: 0.302 W (24.8 dBm) LTE Band IV: 0.490 W (26.9 dBm)
Antenna type	Internal antenna





### 3 Configuration of Equipment

Numbers assigned to equipment on the diagram in “3.2 System configuration” correspond to the list in “3.1 Equipment used”.

Cabling and setup(s) were taken into consideration and test data was taken under worse case condition.

#### 3.1 Equipment used

No.	Equipment	Company	Model No.	Serial No.	FCC ID/DoC	Comment
1	Mobile Phone	KYOCERA	DB62	N/A	JOYDB62	EUT

#### 3.2 System configuration

1. Mobile Phone (EUT)
--------------------------

## 4 Test Result

### 4.1 Effective Radiated Power

#### 4.1.1 Measurement procedure

##### [FCC 27.50]

##### <Step 1>

The EUT and support equipment are placed on a 1 meter x 1 meter surface, 0.8 meter height styrene foam table. Radiated emission measurements are performed at 3 meter distance with the broadband antenna (Log periodic antenna). The antenna is positioned both the horizontal and vertical planes of polarization and height is varied 1 to 4 meters and stopped at height producing the maximum emission. The bandwidth of the spectrum analyzer is set to 1 MHz. The turntable is rotated by 360 degrees and stopped at azimuth of producing the maximum emission.

##### <Step 2>

The substitution antenna is replaced by the transmitter antenna (EUT).

The frequency of the signal generator is adjusted to the measurement frequency.

Level of the signal generator is adjusted to the level that is obtained from step 1, and record the emission level of signal generator.

The spectrum analyzer is set to;

- a) Span = 1.5 times the OBW
- b) RBW = 1-5% of the expected OBW, not to exceed 1 MHz
- c) VBW  $\geq 3 \times$  RBW
- d) Number of sweep points  $\geq 2 \times$  span / RBW
- e) Sweep time = auto-couple
- f) Detector = RMS (power averaging)
- g) If the EUT can be configured to transmit continuously (i.e., burst duty cycle  $\geq 98\%$ ), then set the trigger to free run.
- h) If the EUT cannot be configured to transmit continuously (i.e., burst duty cycle  $< 98\%$ ), then use a sweep trigger with the level set to enable triggering only on full power bursts and configure the EUT to transmit at full power for the entire duration of each sweep. Ensure that the sweep time is less than or equal to the transmission burst duration.
- i) Trace average at least 100 traces in power averaging (i.e., RMS) mode.
- j) Compute the power by integrating the spectrum across the OBW of the signal using the instrument's band power measurement function, with the band limits set equal to the OBW band edges.

If the instrument does not have a band power function, then sum the spectrum levels (in linear power units) at intervals equal to the RBW extending across the entire OBW of the spectrum.

- Test configuration

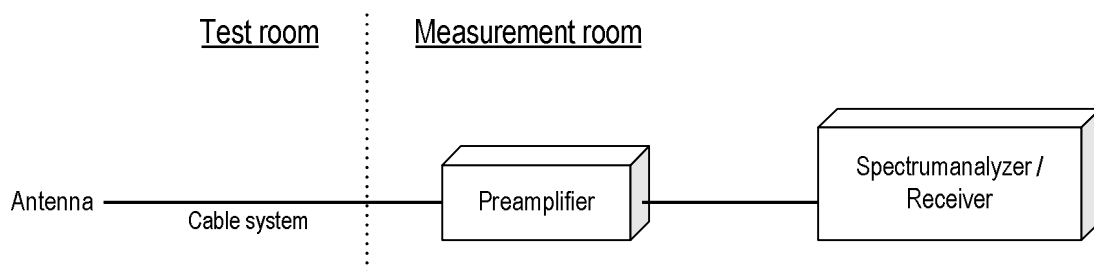

#### 4.1.2 Calculation method

Result (ERP) = S.G Reading - Cable loss + Antenna Gain

Margin = Limit – Result (ERP)

Example:

Limit @ 1732.5 MHz : 30.0 dBm

Ant. Input = 15.0 dBm Cable loss = 1.1 dB Ant. Gain = 8.0 dBi

Result = 15.0 – 1.1 + 8.0 = 21.9 dBm

Margin = 30.0 – 21.9 = 8.1 dB

#### 4.1.3 Limit

1 W (30.0 dBm)

#### 4.1.4 Test data

Date	: 5-August-2019		
Temperature	: 22.9 [°C]		
Humidity	: 53.1 [%]	Test engineer	:
Test place	: 3m Semi-anechoic chamber		: <u>Chiaki Kanno</u>
Date	: 6-August-2019		
Temperature	: 22.1 [°C]		
Humidity	: 56.3 [%]	Test engineer	:
Test place	: 3m Semi-anechoic chamber		: <u>Chiaki Kanno</u>
Date	: 17-September-2019		
Temperature	: 21.1 [°C]		
Humidity	: 59.8 [%]	Test engineer	:
Test place	: 3m Semi-anechoic chamber		: <u>Chiaki Kanno</u>
Date	: 18-September-2019		
Temperature	: 22.0 [°C]		
Humidity	: 55.2 [%]	Test engineer	:
Test place	: 3m Semi-anechoic chamber		: <u>Chiaki Kanno</u>
Date	: 19-September-2019		
Temperature	: 21.9 [°C]		
Humidity	: 56.8 [%]	Test engineer	:
Test place	: 3m Semi-anechoic chamber		: <u>Chiaki Kanno</u>
Date	: 24-September-2019		
Temperature	: 22.5 [°C]		
Humidity	: 55.3 [%]	Test engineer	:
Test place	: 3m Semi-anechoic chamber		: <u>Chiaki Kanno</u>
Date	: 26-September-2019		
Temperature	: 23.0 [°C]		
Humidity	: 48.6 [%]	Test engineer	:
Test place	: 3m Semi-anechoic chamber		: <u>Chiaki Kanno</u>



Date : 30-September-2019  
 Temperature : 20.3 [°C]  
 Humidity : 57.9 [%]  
 Test place : 3m Semi-anechoic chamber  
 Test engineer : Tadahiro Seino

Date : 1-October-2019  
 Temperature : 22.8 [°C]  
 Humidity : 53.9 [%]  
 Test place : 3m Semi-anechoic chamber  
 Test engineer : Chiaki Kanno

**[WCDMA Band IV - With camera]**

H/V	Frequency [MHz]	S.A Reading [dBm]	Ant. Input [dBm]	Cable loss [dB]	Ant.Gain [dBi]	Result [dBm]	Limit [dBm]	Margin [dB]
H	1712.4	-25.7	15.0	1.1	8.5	22.5	30.0	7.5
H	1732.6	-25.7	17.3	1.1	8.3	24.5	30.0	5.5
H	1752.6	-25.6	16.5	1.1	8.2	23.6	30.0	6.4

**[WCDMA Band IV - Without camera]**

H/V	Frequency [MHz]	S.A Reading [dBm]	Ant. Input [dBm]	Cable loss [dB]	Ant.Gain [dBi]	Result [dBm]	Limit [dBm]	Margin [dB]
H	1712.4	-25.8	14.9	1.1	8.5	22.4	30.0	7.6
H	1732.6	-25.4	17.6	1.1	8.3	24.8	30.0	5.2
H	1752.6	-25.8	16.3	1.1	8.2	23.4	30.0	6.6

**[LTE Band IV - With camera]****QPSK, BW 1.4MHz**

H/V	Frequency [MHz]	S.A Reading [dBm]	Ant. Input [dBm]	Cable loss [dB]	Ant.Gain [dBi]	Result [dBm]	Limit [dBm]	Margin [dB]
H	1710.7	-24.5	17.1	1.1	8.5	24.6	30.0	5.4
H	1732.5	-24.4	18.7	1.1	8.3	25.9	30.0	4.1
H	1754.3	-25.1	16.9	1.1	8.2	24.0	30.0	6.0

**16QAM, BW 1.4MHz**

H/V	Frequency [MHz]	S.A Reading [dBm]	Ant. Input [dBm]	Cable loss [dB]	Ant.Gain [dBi]	Result [dBm]	Limit [dBm]	Margin [dB]
H	1710.7	-25.7	15.9	1.1	8.5	23.4	30.0	6.6
H	1732.5	-24.7	18.4	1.1	8.3	25.6	30.0	4.4
H	1754.3	-25.5	16.5	1.1	8.2	23.6	30.0	6.4

**QPSK, BW 3MHz**

H/V	Frequency [MHz]	S.A Reading [dBm]	Ant. Input [dBm]	Cable loss [dB]	Ant.Gain [dBi]	Result [dBm]	Limit [dBm]	Margin [dB]
H	1711.5	-24.6	16.9	1.1	8.5	24.4	30.0	5.6
H	1732.5	-24.2	18.9	1.1	8.3	26.1	30.0	3.9
H	1753.5	-24.9	17.2	1.1	8.2	24.3	30.0	5.7

**16QAM, BW 3MHz**

H/V	Frequency [MHz]	S.A Reading [dBm]	Ant. Input [dBm]	Cable loss [dB]	Ant.Gain [dBi]	Result [dBm]	Limit [dBm]	Margin [dB]
H	1711.5	-25.7	15.8	1.1	8.5	23.3	30.0	6.7
H	1732.5	-24.6	18.5	1.1	8.3	25.7	30.0	4.3
H	1753.5	-26.1	16.0	1.1	8.2	23.1	30.0	6.9

**QPSK, BW 5MHz**

H/V	Frequency [MHz]	S.A Reading [dBm]	Ant. Input [dBm]	Cable loss [dB]	Ant.Gain [dBi]	Result [dBm]	Limit [dBm]	Margin [dB]
H	1712.5	-24.8	16.6	1.1	8.5	24.1	30.0	5.9
H	1732.5	-24.2	18.9	1.1	8.3	26.1	30.0	3.9
H	1752.5	-24.3	17.9	1.1	8.2	25.0	30.0	5.0

**16QAM, BW 5MHz**

H/V	Frequency [MHz]	S.A Reading [dBm]	Ant. Input [dBm]	Cable loss [dB]	Ant.Gain [dBi]	Result [dBm]	Limit [dBm]	Margin [dB]
H	1712.5	-25.9	15.5	1.1	8.5	23.0	30.0	7.0
H	1732.5	-25.3	17.8	1.1	8.3	25.0	30.0	5.0
H	1752.5	-25.9	16.3	1.1	8.2	23.4	30.0	6.6

**QPSK, BW 10MHz**

H/V	Frequency [MHz]	S.A Reading [dBm]	Ant. Input [dBm]	Cable loss [dB]	Ant.Gain [dBi]	Result [dBm]	Limit [dBm]	Margin [dB]
H	1715.0	-24.5	16.9	1.1	8.5	24.3	30.0	5.7
H	1732.5	-23.6	19.5	1.1	8.3	26.7	30.0	3.3
H	1750.0	-25.0	17.2	1.1	8.2	24.3	30.0	5.7

**16QAM, BW 10MHz**

H/V	Frequency [MHz]	S.A Reading [dBm]	Ant. Input [dBm]	Cable loss [dB]	Ant.Gain [dBi]	Result [dBm]	Limit [dBm]	Margin [dB]
H	1715.0	-25.8	15.6	1.1	8.5	23.0	30.0	7.0
H	1732.5	-24.5	18.6	1.1	8.3	25.8	30.0	4.2
H	1750.0	-25.7	16.5	1.1	8.2	23.6	30.0	6.4

**QPSK, BW 15MHz**

H/V	Frequency [MHz]	S.A Reading [dBm]	Ant. Input [dBm]	Cable loss [dB]	Ant.Gain [dBi]	Result [dBm]	Limit [dBm]	Margin [dB]
H	1717.5	-24.7	16.7	1.1	8.5	24.1	30.0	5.9
H	1732.5	-23.9	19.2	1.1	8.3	26.4	30.0	3.6
H	1747.5	-24.7	18.2	1.1	8.2	25.3	30.0	4.7

**16QAM, BW 15MHz**

H/V	Frequency [MHz]	S.A Reading [dBm]	Ant. Input [dBm]	Cable loss [dB]	Ant.Gain [dBi]	Result [dBm]	Limit [dBm]	Margin [dB]
H	1717.5	-26.3	15.1	1.1	8.5	22.5	30.0	7.5
H	1732.5	-24.9	18.2	1.1	8.3	25.4	30.0	4.6
H	1747.5	-26.7	16.2	1.1	8.2	23.3	30.0	6.7

**QPSK, BW 20MHz**

H/V	Frequency [MHz]	S.A Reading [dBm]	Ant. Input [dBm]	Cable loss [dB]	Ant.Gain [dBi]	Result [dBm]	Limit [dBm]	Margin [dB]
H	1720.0	-24.9	16.8	1.1	8.4	24.2	30.0	5.8
H	1732.5	-24.0	19.1	1.1	8.3	26.3	30.0	3.7
H	1745.0	-25.3	17.9	1.1	8.2	25.0	30.0	5.0

**16QAM, BW 20MHz**

H/V	Frequency [MHz]	S.A Reading [dBm]	Ant. Input [dBm]	Cable loss [dB]	Ant.Gain [dBi]	Result [dBm]	Limit [dBm]	Margin [dB]
H	1720.0	-25.8	15.4	1.1	8.4	22.8	30.0	7.2
H	1732.5	-25.3	17.8	1.1	8.3	25.0	30.0	5.0
H	1745.0	-26.8	16.4	1.1	8.2	23.5	30.0	6.5

**[LTE Band IV - Without camera]****QPSK, BW 1.4MHz**

H/V	Frequency [MHz]	S.A Reading [dBm]	Ant. Input [dBm]	Cable loss [dB]	Ant.Gain [dBi]	Result [dBm]	Limit [dBm]	Margin [dB]
H	1710.7	-24.7	16.9	1.1	8.5	24.4	30.0	5.6
H	1732.5	-23.7	19.4	1.1	8.3	26.6	30.0	3.4
H	1754.3	-24.8	17.2	1.1	8.2	24.3	30.0	5.7

**16QAM, BW 1.4MHz**

H/V	Frequency [MHz]	S.A Reading [dBm]	Ant. Input [dBm]	Cable loss [dB]	Ant.Gain [dBi]	Result [dBm]	Limit [dBm]	Margin [dB]
H	1710.7	-25.3	16.3	1.1	8.5	23.8	30.0	6.2
H	1732.5	-24.7	18.4	1.1	8.3	25.6	30.0	4.4
H	1754.3	-25.6	16.4	1.1	8.2	23.5	30.0	6.5

**QPSK, BW 3MHz**

H/V	Frequency [MHz]	S.A Reading [dBm]	Ant. Input [dBm]	Cable loss [dB]	Ant.Gain [dBi]	Result [dBm]	Limit [dBm]	Margin [dB]
H	1711.5	-24.5	17.0	1.1	8.5	24.5	30.0	5.5
H	1732.5	-24.0	19.1	1.1	8.3	26.3	30.0	3.7
H	1753.5	-24.5	17.6	1.1	8.2	24.7	30.0	5.3

**16QAM, BW 3MHz**

H/V	Frequency [MHz]	S.A Reading [dBm]	Ant. Input [dBm]	Cable loss [dB]	Ant.Gain [dBi]	Result [dBm]	Limit [dBm]	Margin [dB]
H	1711.5	-25.4	16.1	1.1	8.5	23.6	30.0	6.4
H	1732.5	-24.7	18.4	1.1	8.3	25.6	30.0	4.4
H	1753.5	-25.6	16.5	1.1	8.2	23.6	30.0	6.4

**QPSK, BW 5MHz**

H/V	Frequency [MHz]	S.A Reading [dBm]	Ant. Input [dBm]	Cable loss [dB]	Ant.Gain [dBi]	Result [dBm]	Limit [dBm]	Margin [dB]
H	1712.5	-24.3	17.1	1.1	8.5	24.6	30.0	5.4
H	1732.5	-24.3	18.8	1.1	8.3	26.0	30.0	4.0
H	1752.5	-24.6	17.6	1.1	8.2	24.7	30.0	5.3

**16QAM, BW 5MHz**

H/V	Frequency [MHz]	S.A Reading [dBm]	Ant. Input [dBm]	Cable loss [dB]	Ant.Gain [dBi]	Result [dBm]	Limit [dBm]	Margin [dB]
H	1712.5	-25.8	15.6	1.1	8.5	23.1	30.0	6.9
H	1732.5	-25.5	17.6	1.1	8.3	24.8	30.0	5.2
H	1752.5	-25.7	16.5	1.1	8.2	23.6	30.0	6.4

**QPSK, BW 10MHz**

H/V	Frequency [MHz]	S.A Reading [dBm]	Ant. Input [dBm]	Cable loss [dB]	Ant.Gain [dBi]	Result [dBm]	Limit [dBm]	Margin [dB]
H	1715.0	-24.9	16.5	1.1	8.5	23.9	30.0	6.1
H	1732.5	-24.2	18.9	1.1	8.3	26.1	30.0	3.9
H	1750.0	-25.2	17.0	1.1	8.2	24.1	30.0	5.9

**16QAM, BW 10MHz**

H/V	Frequency [MHz]	S.A Reading [dBm]	Ant. Input [dBm]	Cable loss [dB]	Ant.Gain [dBi]	Result [dBm]	Limit [dBm]	Margin [dB]
H	1715.0	-25.9	15.5	1.1	8.5	22.9	30.0	7.1
H	1732.5	-24.8	18.3	1.1	8.3	25.5	30.0	4.5
H	1750.0	-26.1	16.1	1.1	8.2	23.2	30.0	6.8

**QPSK, BW 15MHz**

H/V	Frequency [MHz]	S.A Reading [dBm]	Ant. Input [dBm]	Cable loss [dB]	Ant.Gain [dBi]	Result [dBm]	Limit [dBm]	Margin [dB]
H	1717.5	-24.8	16.6	1.1	8.5	24.0	30.0	6.0
H	1732.5	-24.7	18.4	1.1	8.3	25.6	30.0	4.4
H	1747.5	-25.1	17.8	1.1	8.2	24.9	30.0	5.1

**16QAM, BW 15MHz**

H/V	Frequency [MHz]	S.A Reading [dBm]	Ant. Input [dBm]	Cable loss [dB]	Ant.Gain [dBi]	Result [dBm]	Limit [dBm]	Margin [dB]
H	1717.5	-26.0	15.4	1.1	8.5	22.8	30.0	7.2
H	1732.5	-25.7	17.4	1.1	8.3	24.6	30.0	5.4
H	1747.5	-25.8	17.1	1.1	8.2	24.2	30.0	5.8

**QPSK, BW 20MHz**

H/V	Frequency [MHz]	S.A Reading [dBm]	Ant. Input [dBm]	Cable loss [dB]	Ant.Gain [dBi]	Result [dBm]	Limit [dBm]	Margin [dB]
H	1720.0	-24.0	17.7	1.1	8.4	25.1	30.0	4.9
H	1732.5	-23.4	19.7	1.1	8.3	26.9	30.0	3.1
H	1745.0	-24.5	18.7	1.1	8.2	25.8	30.0	4.2

**16QAM, BW 20MHz**

H/V	Frequency [MHz]	S.A Reading [dBm]	Ant. Input [dBm]	Cable loss [dB]	Ant.Gain [dBi]	Result [dBm]	Limit [dBm]	Margin [dB]
H	1720.0	-25.0	16.7	1.1	8.4	24.1	30.0	5.9
H	1732.5	-24.8	18.3	1.1	8.3	25.5	30.0	4.5
H	1745.0	-24.9	18.3	1.1	8.2	25.4	30.0	4.6

## 4.2 Peak to Average Ratio

### 4.2.1 Measurement procedure

#### [FCC 27.50]

The peak to average ratio was measured with a spectrum analyzer connected to the antenna terminal.

The spectrum analyzer is set to;

- a) Power Stat CCDF mode
- b) Set resolution / measurement bandwidth  $\geq$  signal's occupied bandwidth.
- c) Set the number of counts to a value that stabilizes the measured CCDF curve.
- d) Set the measurement interval as follows:
  - 1) For continuous transmissions, set to 1ms.
  - 2) For burst transmissions, employ an external trigger that is synchronized with the EUT burst timing sequence, or use the internal burst trigger with a trigger level that allows the burst duration.
- e) Record the maximum PAPR level associated with a probability of 0.1%.

- Test configuration

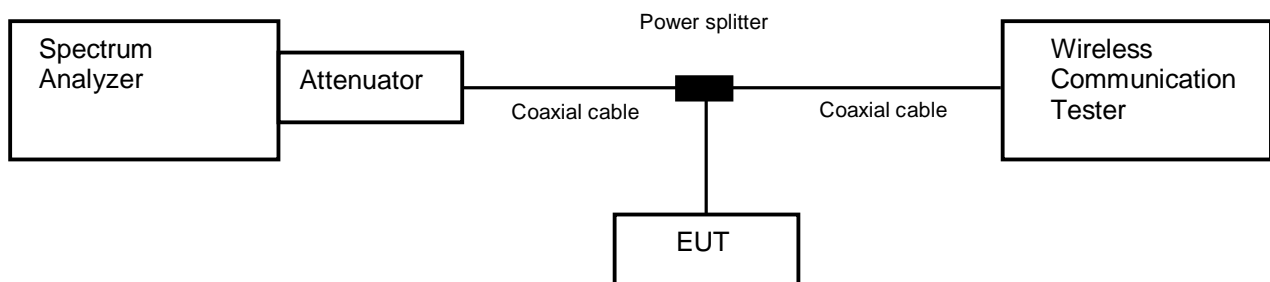

### 4.2.2 Limit

13 dB or less



**4.2.3 Measurement result**

Date : 25-September-2019  
 Temperature : 22.3 [°C]  
 Humidity : 49.5 [%]  
 Test place : Shielded room No.4  
 Test engineer : Chiaki Kanno

Band	Channel	Frequency [MHz]	Peak to Average Power Ratio [dB]	Limit [dB]
WCDMA Band IV	1312	1712.4	2.85	13.0
	1413	1732.6	3.11	
	1513	1752.6	2.50	

Band	Channel	Frequency [MHz]	Modulation	Bandwidth [MHz]	RB	Peak to Average Power Ratio [dB]	Limit [dB]
LTE Band IV	20175	1732.5	QPSK	1.4	6-0	4.75	13.0
				3	15-0	4.91	
				5	25-0	5.05	
				10	50-0	4.64	
				15	75-0	5.83	
				20	100-0	6.61	
			16QAM	1.4	6-0	5.58	
				3	15-0	5.76	
				5	25-0	5.81	
				10	50-0	6.09	
				15	75-0	6.77	
				20	100-0	7.28	

4.2.4 Trace data

[WCDMA Band IV]  
Channel: 1312

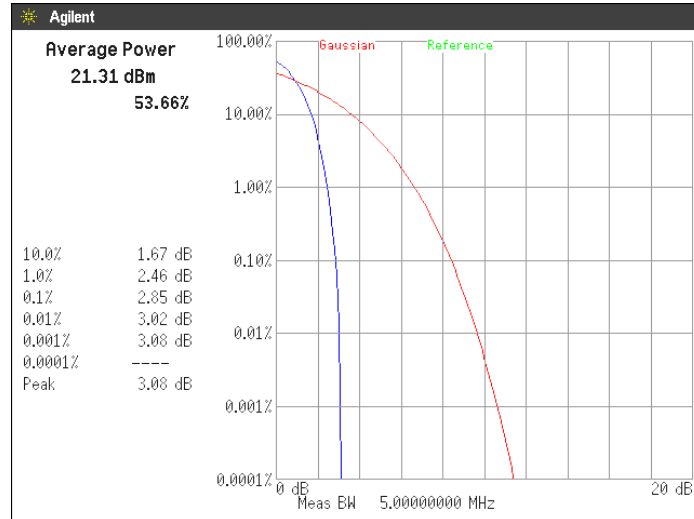

Channel: 1413

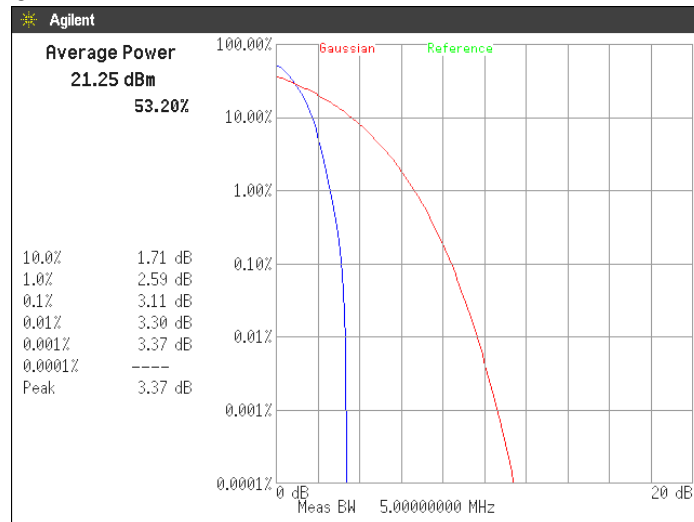

Channel: 1513

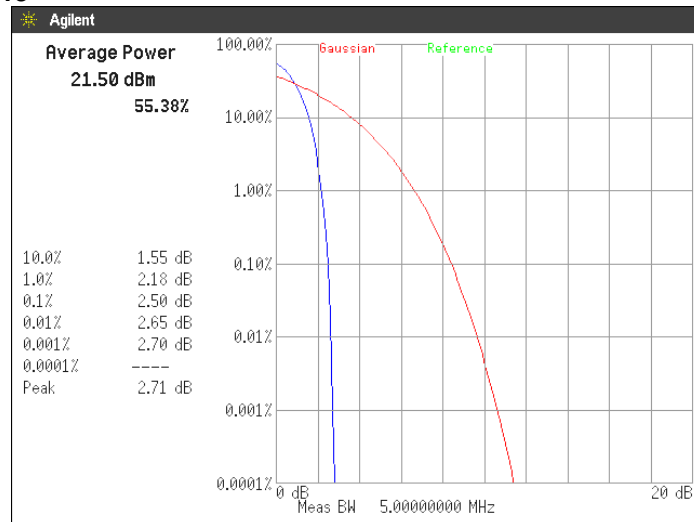



[LTE Band IV]

Channel: 20175  
 QPSK, BW 1.4MHz, RB6-0

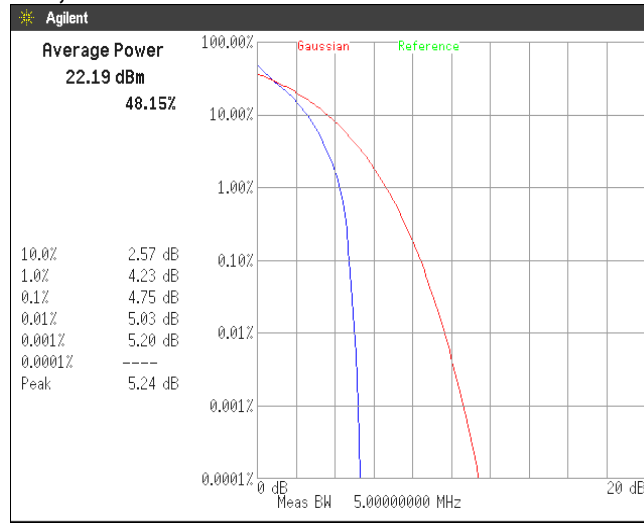

QPSK, BW 3MHz, RB15-0

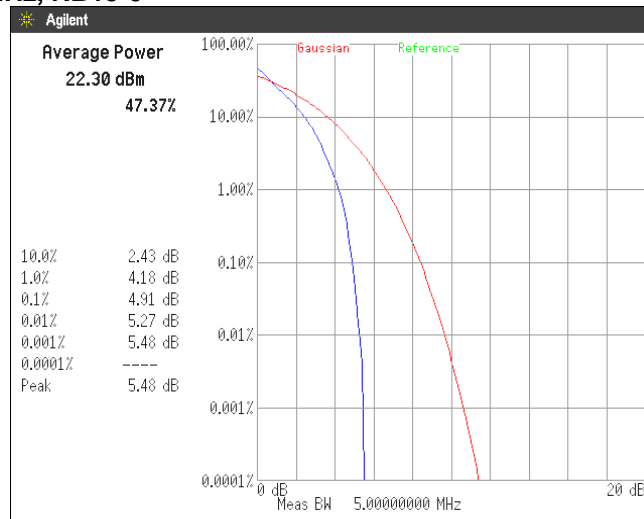

QPSK, BW 5MHz, RB25-0

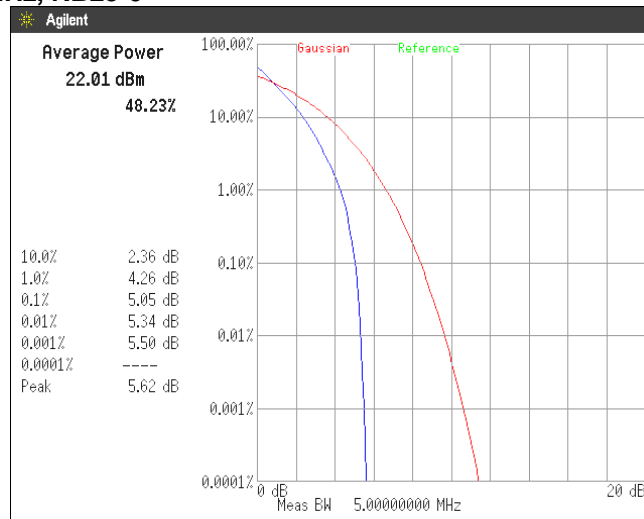

**Channel: 20175**  
**QPSK, BW 10MHz, RB50-0**

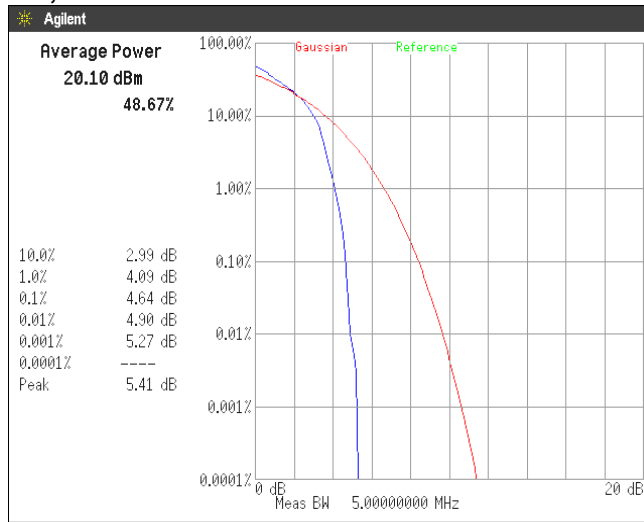

**QPSK, BW 15MHz, RB75-0**

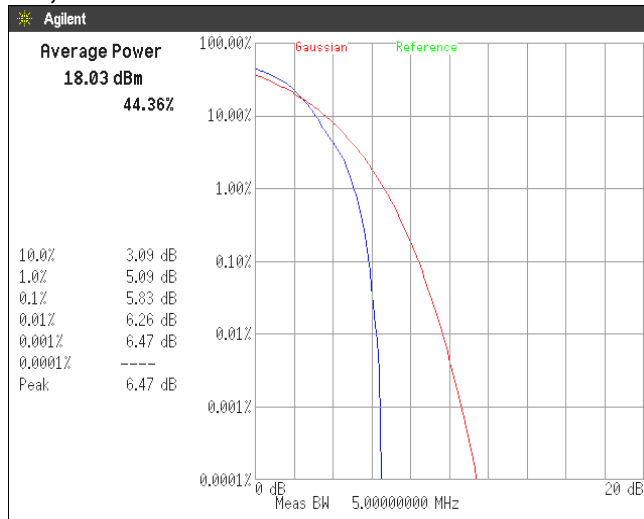

**QPSK, BW 20MHz, RB100-0**

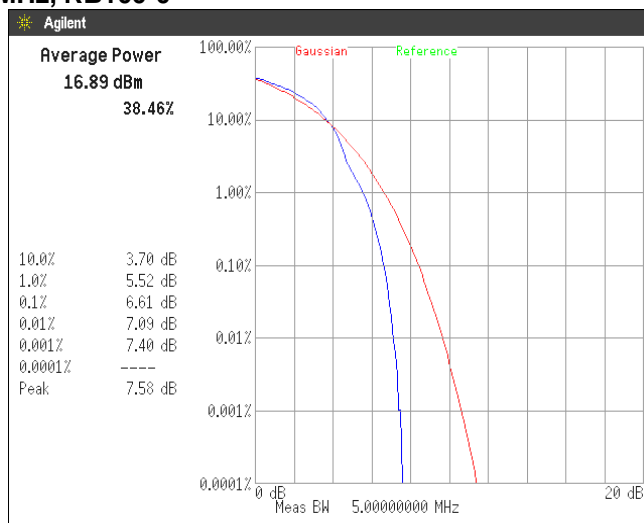

**Channel: 20175**  
**16QAM, BW 1.4MHz, RB6-0**

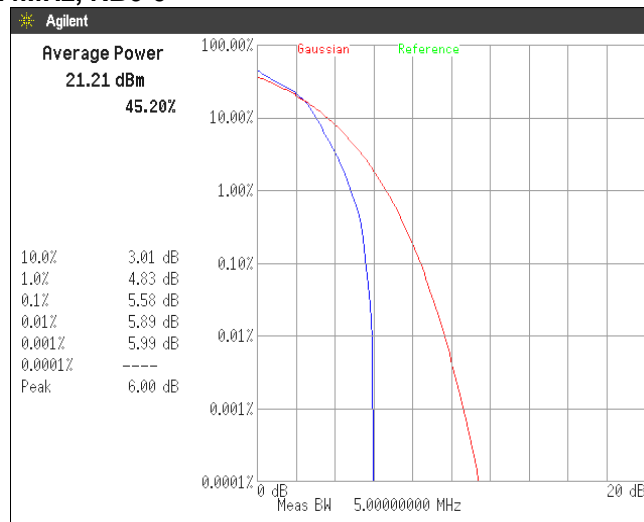

**16QAM, BW 3MHz, RB15-0**

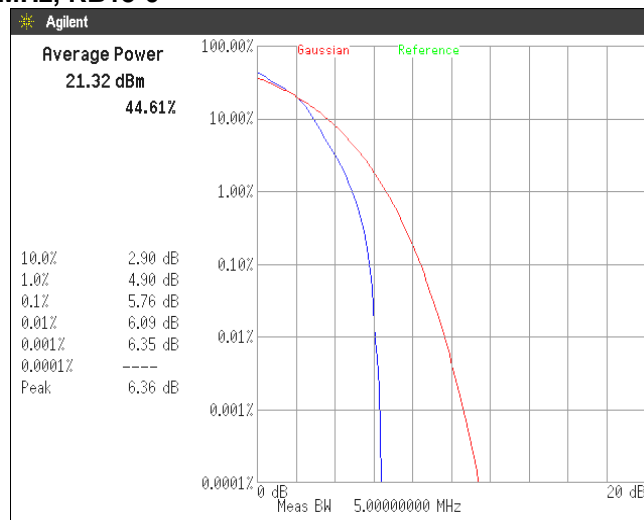

**16QAM, BW 5MHz, RB25-0**

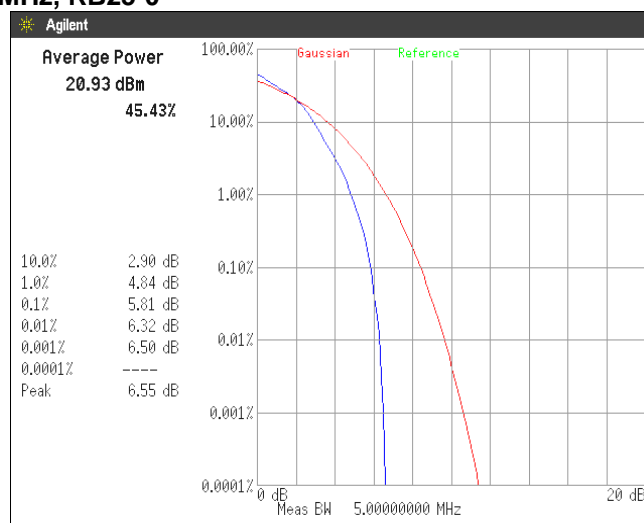

**Channel: 20175**  
**16QAM, BW 10MHz, RB50-0**

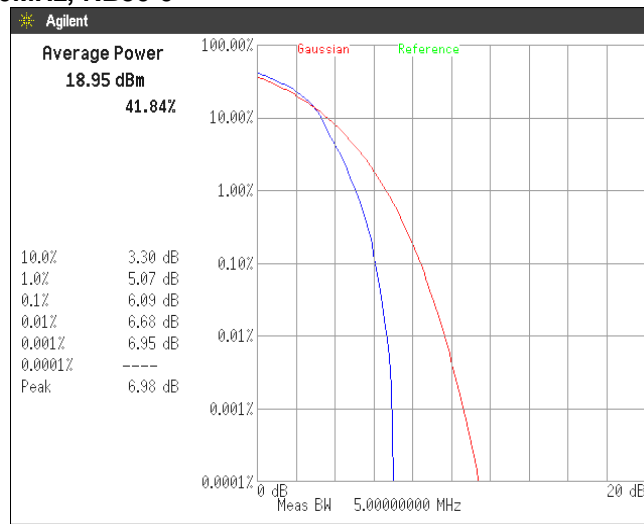

**16QAM, BW 15MHz, RB75-0**

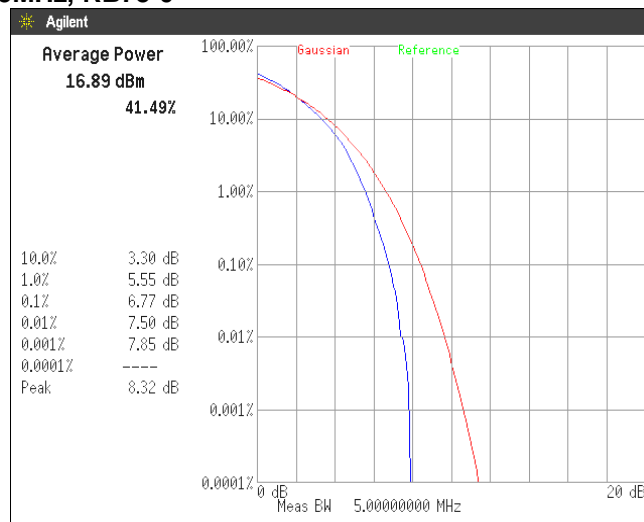

**16QAM, BW 20MHz, RB100-0**

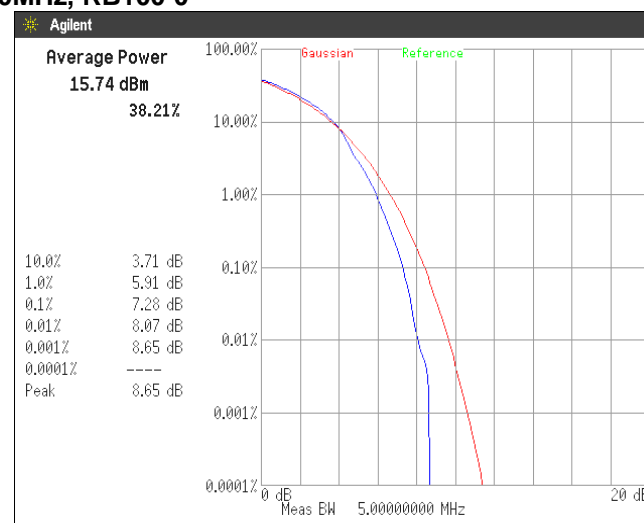

### 4.3 Occupied Bandwidth

#### 4.3.1 Measurement procedure

##### [FCC 2.1049]

The Occupied bandwidth was measured with a spectrum analyzer connected to the antenna terminal.

The spectrum analyzer is set to;

- RBW = 1-5% of the expected OBW & VBW  $\geq 3 \times$  RBW
- Detector = Peak
- Trace mode = Max hold
- Sweep time = auto-couple

- Test configuration

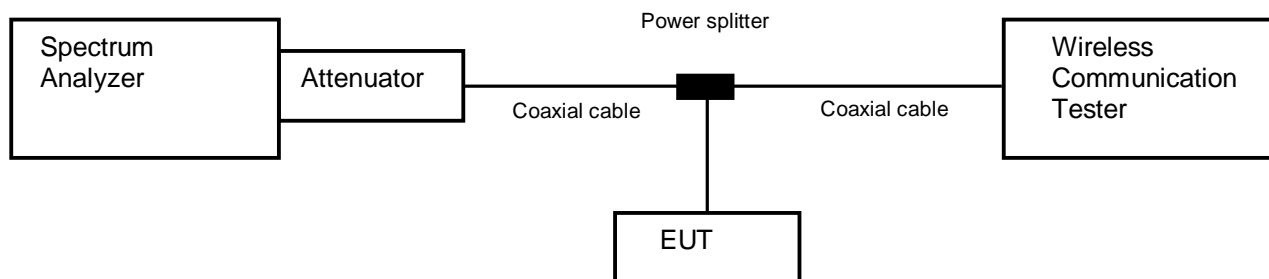

#### 4.3.2 Limit

None



**4.3.3 Measurement result**

Date : 25-September-2019  
 Temperature : 22.3 [°C]  
 Humidity : 49.5 [%]  
 Test place : Shielded room No.4  
 Test engineer : Chiaki Kanno

Band	Channel	Frequency [MHz]	Test Result [MHz]
WCDMA Band IV	1312	1712.4	4.1691
	1413	1732.6	4.1520
	1513	1752.6	4.1761

Band	Channel	Frequency [MHz]	Bandwidth [MHz]	Modulation	RB	Test Result [MHz]
LTE Band IV	20175	1732.5	1.4	QPSK	3-1	0.6299
					6-0	1.1014
				16QAM	3-1	0.6275
					6-0	1.1043
			3	QPSK	8-4	1.5398
					15-0	2.7136
				16QAM	8-4	1.5600
					15-0	2.7077
			5	QPSK	12-7	2.3683
					25-0	4.5623
				16QAM	12-7	2.3450
					25-0	4.5298
			10	QPSK	25-12	4.6536
					50-0	8.9911
				16QAM	25-12	4.6630
					50-0	8.9894
			15	QPSK	36-20	6.8533
					75-0	13.5023
				16QAM	36-20	6.7991
					75-0	13.5142
			20	QPSK	50-24	9.3140
					100-0	17.9755
				16QAM	50-24	9.4364
					100-0	18.0045

### 4.3.4 Trace data

[WCDMA Band IV]  
Channel: 1312

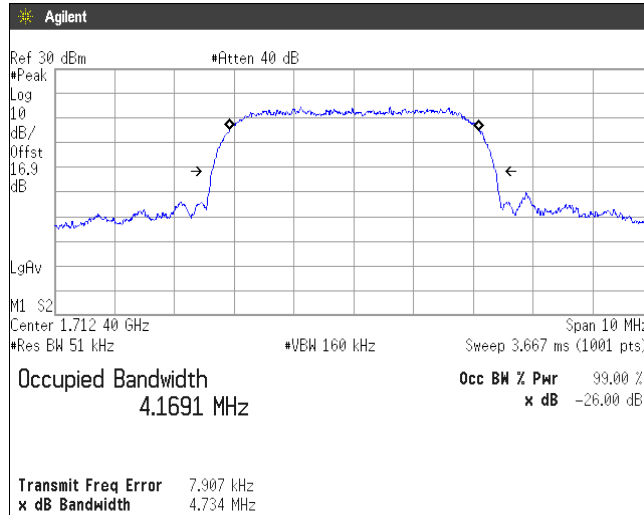

Channel: 1413

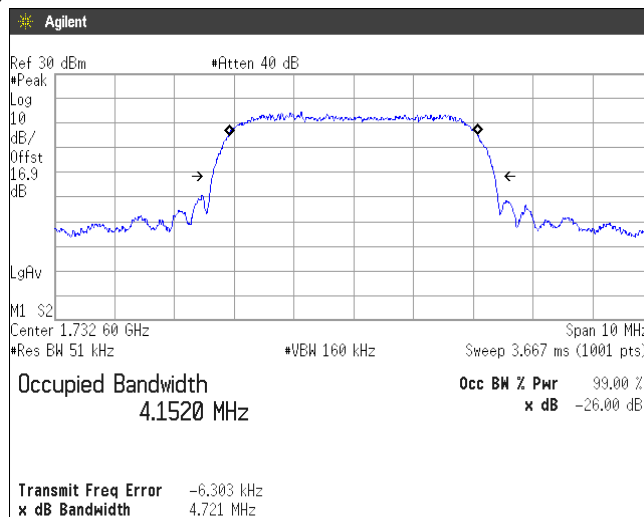

Channel: 1513

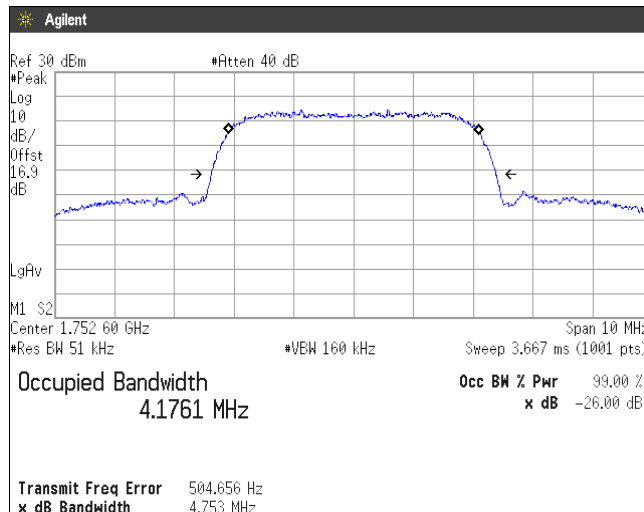



[LTE Band IV]  
Channel: 20175

QPSK, BW 1.4MHz  
RB3-1

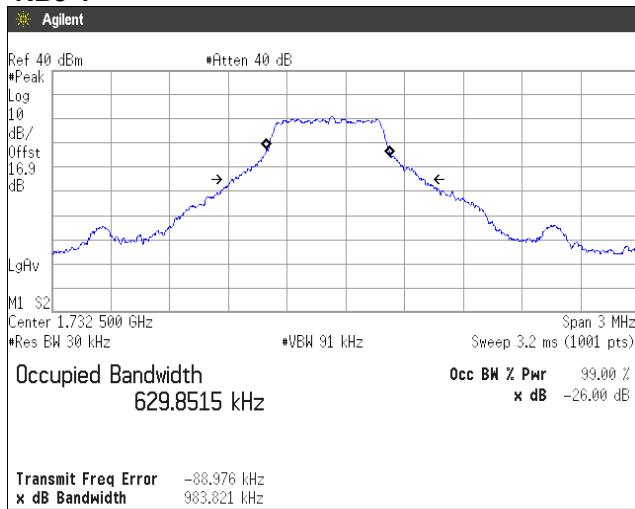

RB6-0

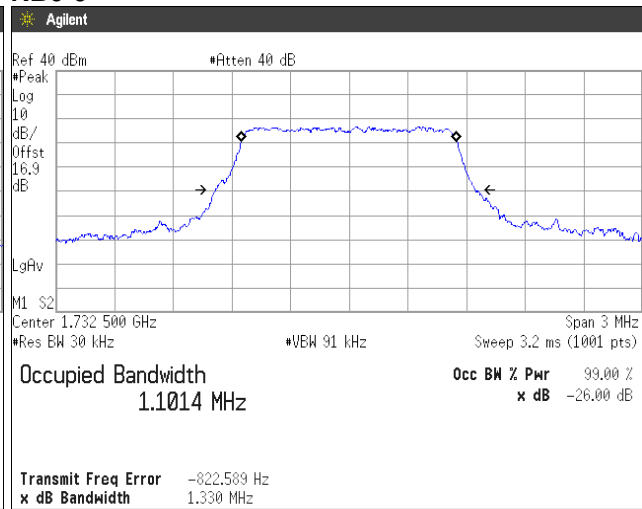

16QAM, BW 1.4MHz  
RB3-1

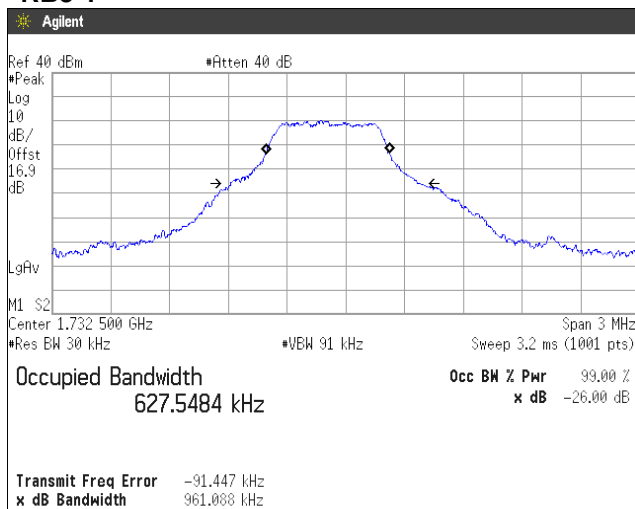

RB6-0

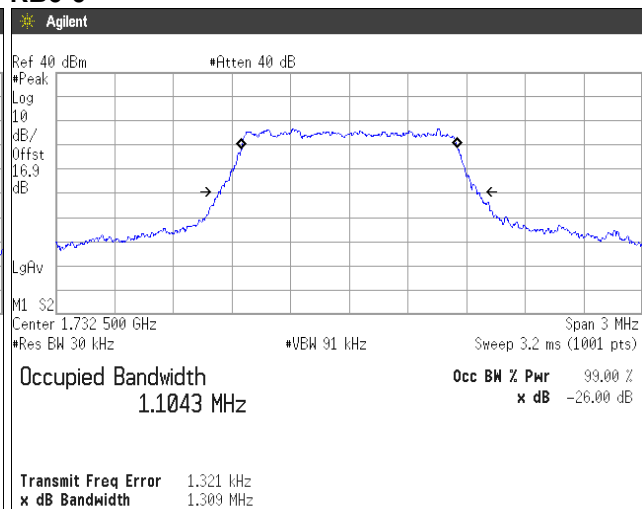





**QPSK, BW 3MHz**

**RB8-4**

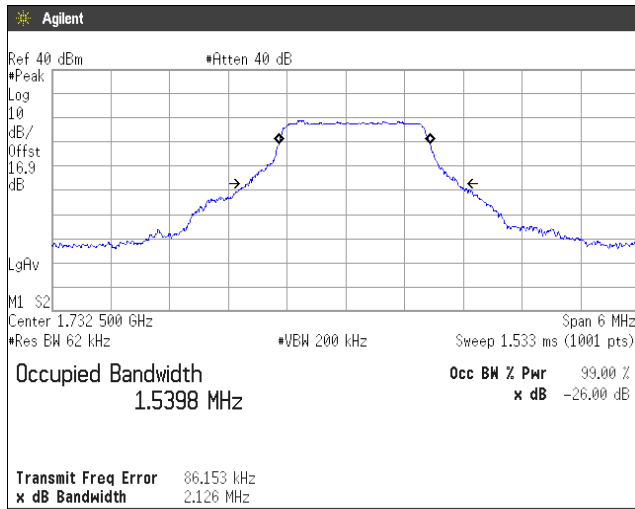

**RB15-0**

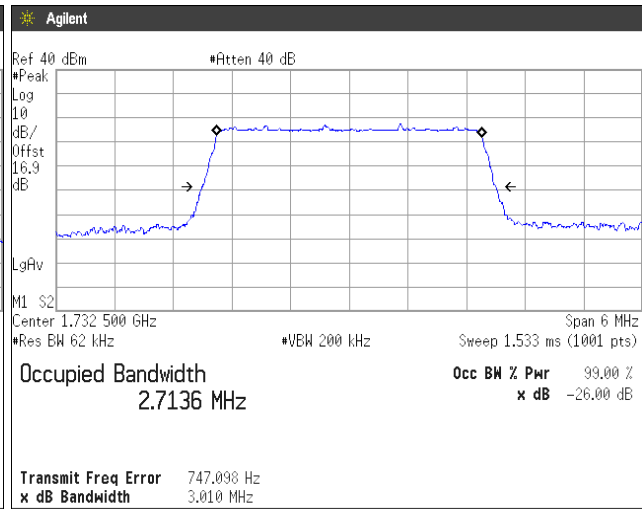

**16QAM, BW 3MHz**

**RB8-4**

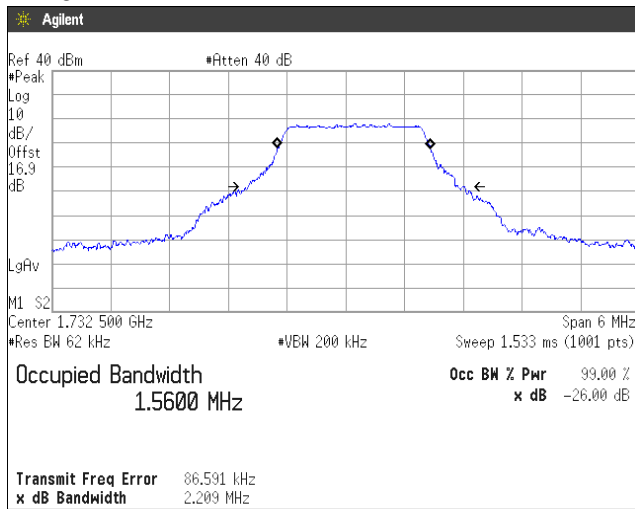

**RB15-0**

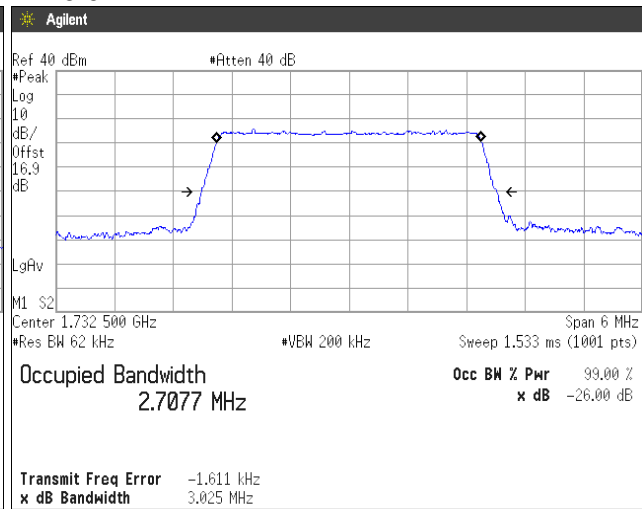



**QPSK, BW 5MHz**

**RB12-7**

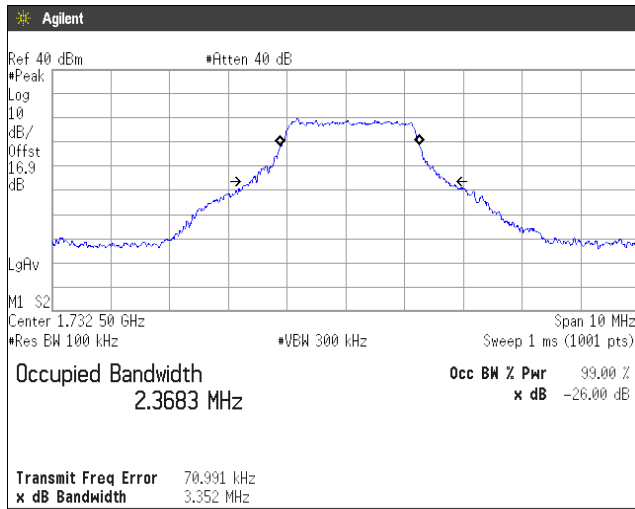

**RB25-0**

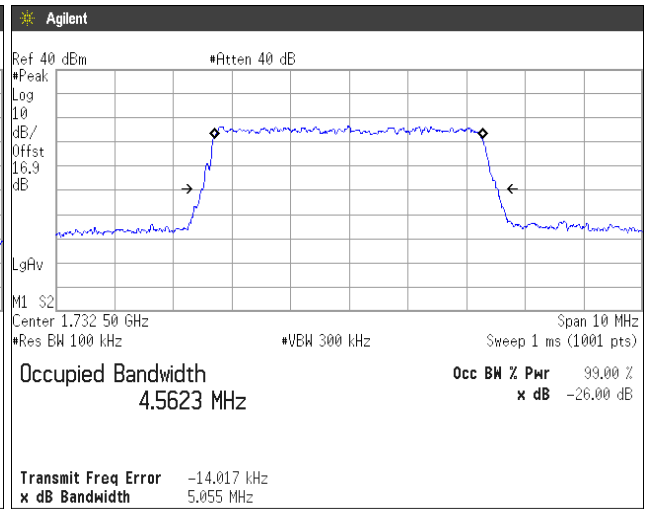

**16QAM, BW 5MHz**

**RB12-7**

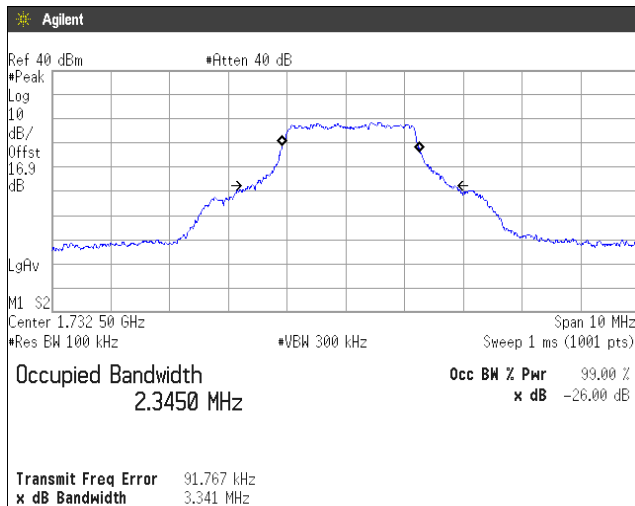

**RB25-0**

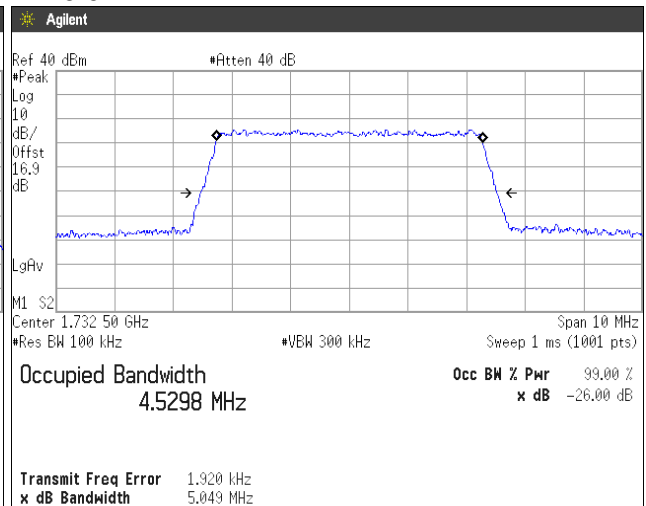



**QPSK, BW 10MHz  
RB25-12**

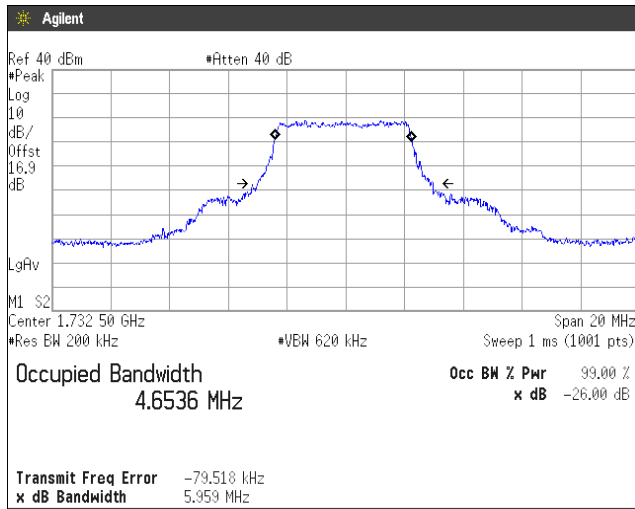

**RB50-0**

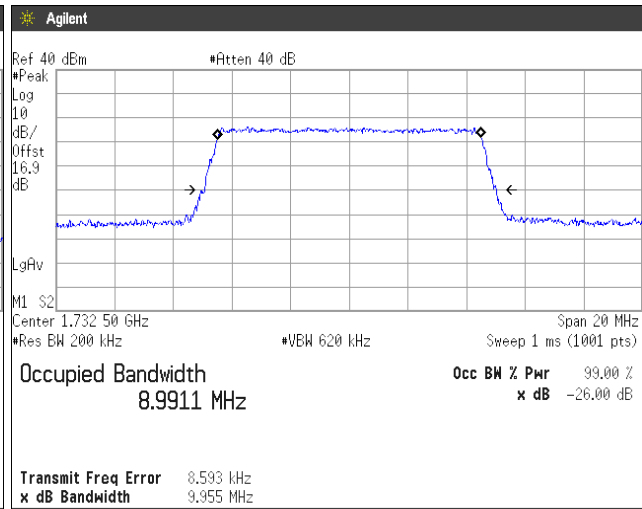

**16QAM, BW 10MHz  
RB25-12**

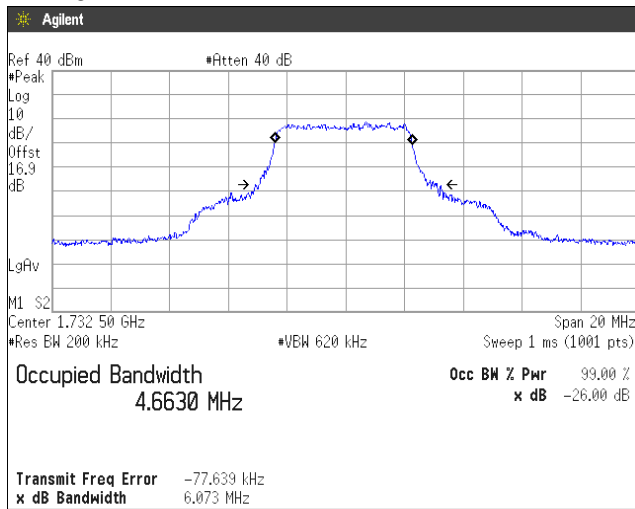

**RB50-0**

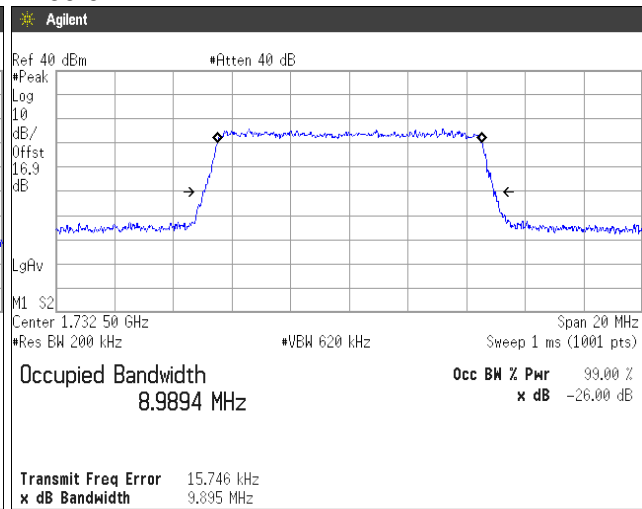



**QPSK, BW 15MHz  
RB36-20**

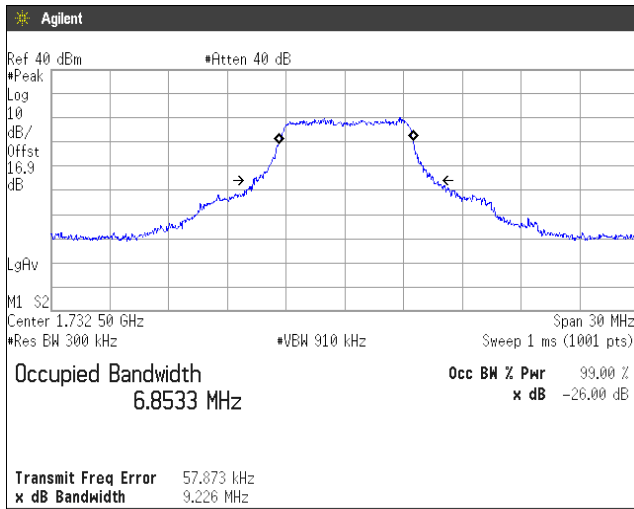

**RB75-0**

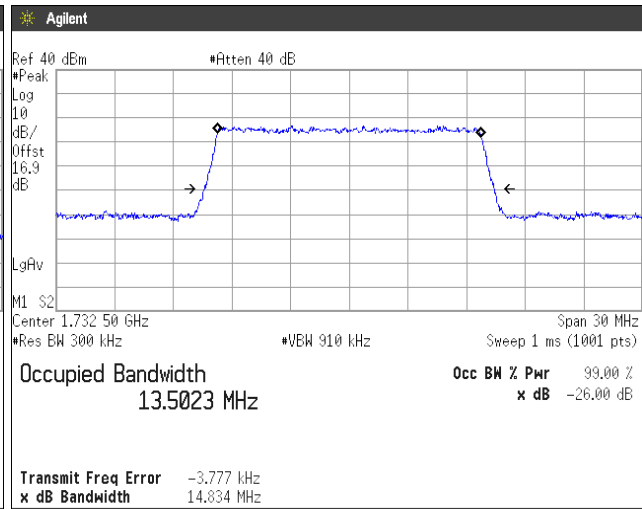

**16QAM, BW 15MHz  
RB36-20**

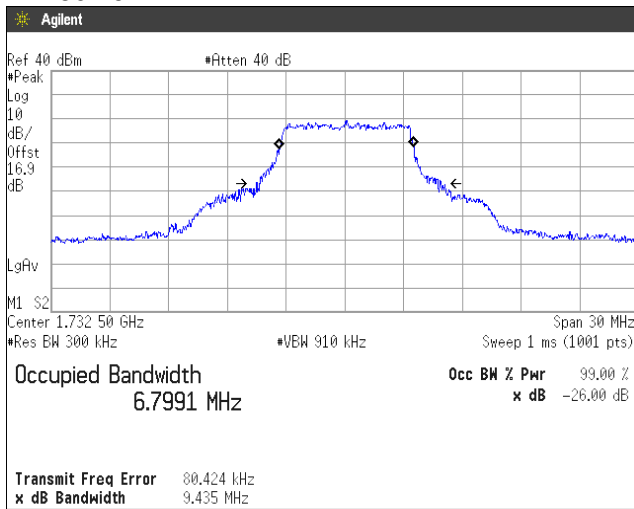

**RB75-0**

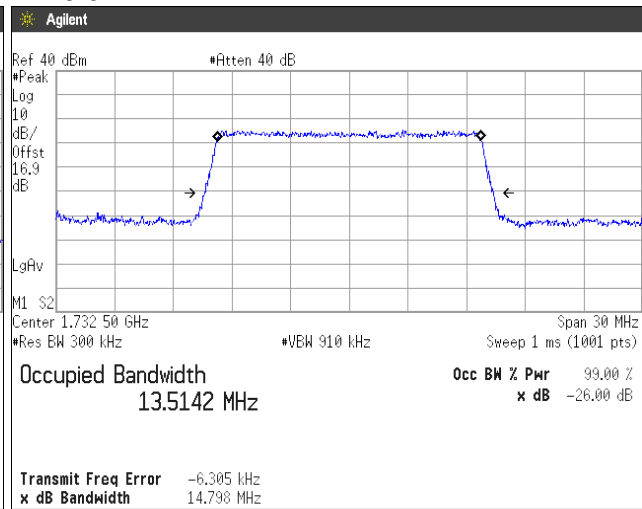



**QPSK, BW 20MHz**  
**RB50-24**

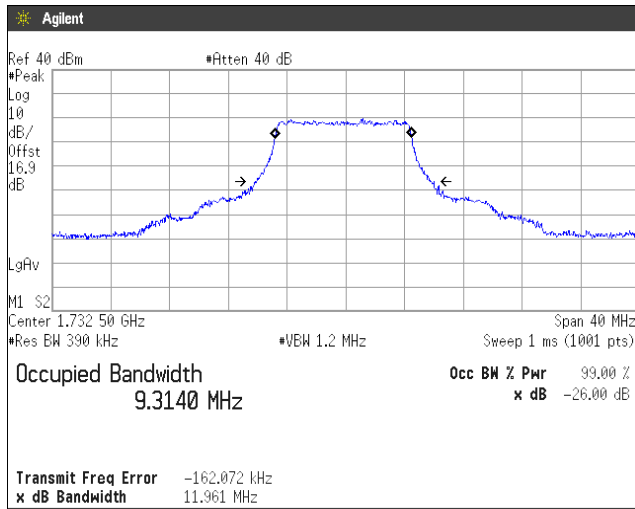

**RB100-0**

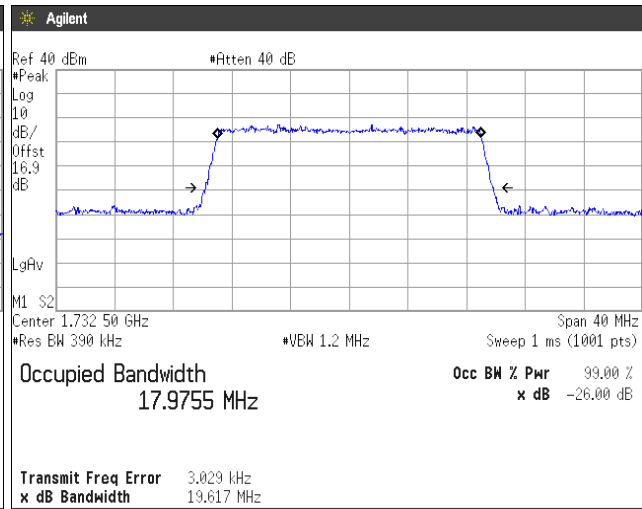

**16QAM, BW 20MHz**  
**RB50-24**

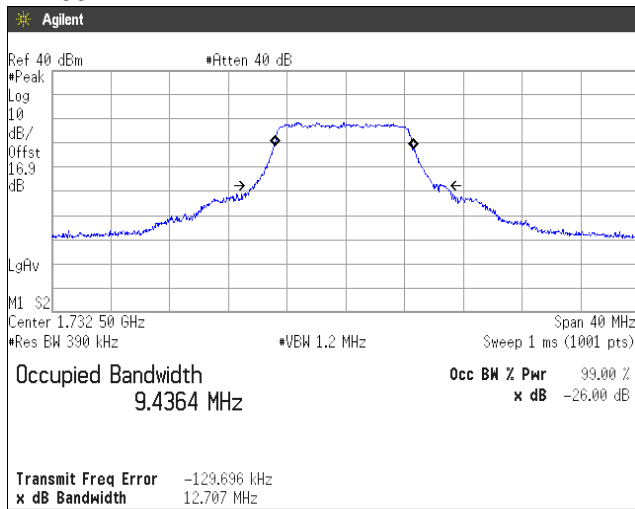

**RB100-0**

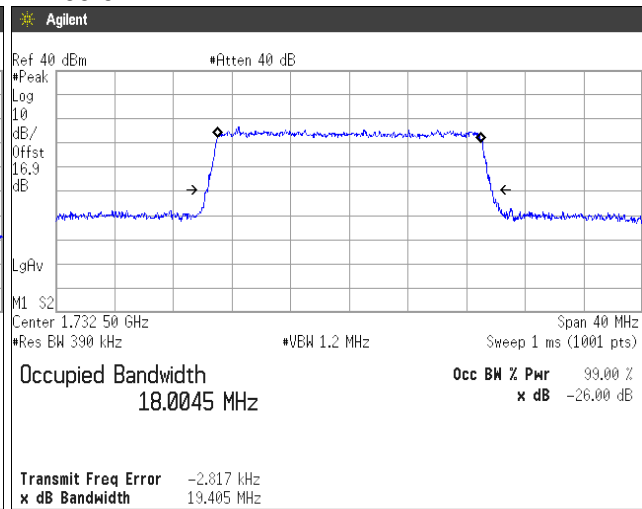

#### 4.4 Band Edge Spurious and Harmonic at Antenna Terminals

##### 4.4.1 Measurement procedure

###### [FCC 27.53, 2.1051]

The band edge spurious and harmonic was measured with a spectrum analyzer connected to the antenna terminal.

The spectrum analyzer is set to;

<Band Edge>

- Span was set large enough so as to capture all out of band emissions near the band edge
- RBW  $\geq$  1% of the emission bandwidth or 2% of the emission bandwidth
- VBW  $\geq$  3 x RBW
- Detector = RMS
- Trace mode = Max hold
- Sweep time = auto-couple
- Number of sweep point  $\geq$  2 x span / RBW

<Spurious Emissions>

- RBW = 1MHz & VBW  $\geq$  3 x RBW
- Detector = Peak
- Trace mode = Max hold
- Sweep time = auto-couple
- Number of sweep point  $\geq$  2 x span / RBW

- Test configuration

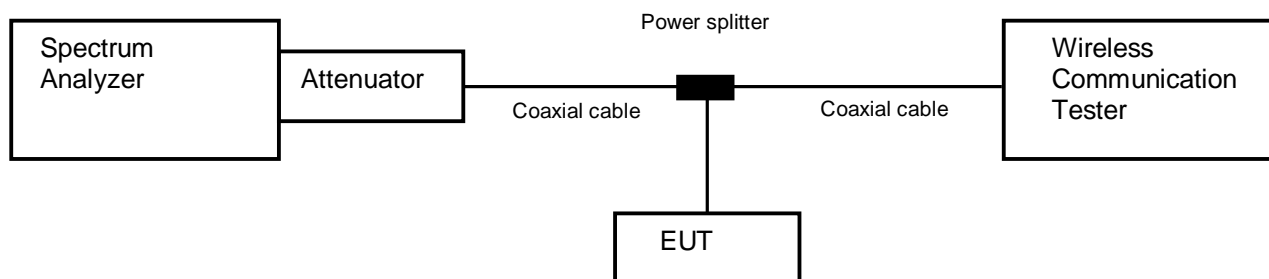

##### 4.4.2 Limit

-13 dB or less



**4.4.3 Measurement result**

Date : 25-September-2019  
 Temperature : 22.3 [°C]  
 Humidity : 49.5 [%]  
 Test place : Shielded room No.4

Test engineer : Chiaki Kanno

Date : 7-October-2019  
 Temperature : 22.9 [°C]  
 Humidity : 52.9 [%]  
 Test place : Shielded room No.4

Test engineer : Chiaki Kanno

Band	Channel	Frequency [MHz]	Limit [dB]	Results	
WCDMA Band IV	1312	1712.4	-13.0	See the trace data	PASS
	1513	1752.6	-13.0	See the trace data	PASS

Band	Modulation	Bandwidth [MHz]	Channel	Frequency [MHz]	Limit [dB]	Results	
LTE Band IV	QPSK, 16QAM	1.4	19957	1710.7	-13.0	See the trace data	PASS
			20393	1754.3	-13.0	See the trace data	PASS
		3	19965	1711.5	-13.0	See the trace data	PASS
			20385	1753.5	-13.0	See the trace data	PASS
		5	19975	1712.5	-13.0	See the trace data	PASS
			20375	1752.5	-13.0	See the trace data	PASS
		10	20000	1715.0	-13.0	See the trace data	PASS
			20350	1750.0	-13.0	See the trace data	PASS
		15	20025	1717.5	-13.0	See the trace data	PASS
			20325	1747.5	-13.0	See the trace data	PASS
		20	20050	1720.0	-13.0	See the trace data	PASS
			20300	1745.0	-13.0	See the trace data	PASS

4.4.4 Trace data

[WCDMA Band IV]  
(Band Edge)

Channel: 1312

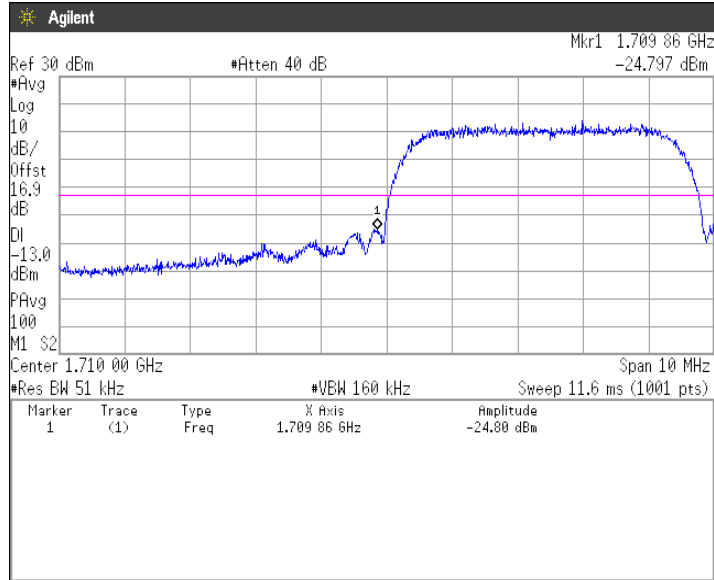

Channel: 1513

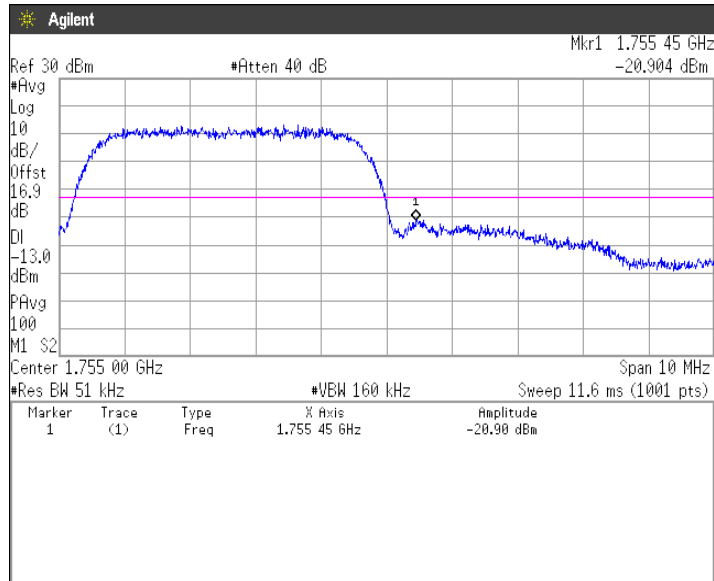



**(Spurious Emissions)**

**Note: Conducted spurious test was measured in the worst case of conducted output power.**

**Channel: 1312  
30MHz-5GHz**

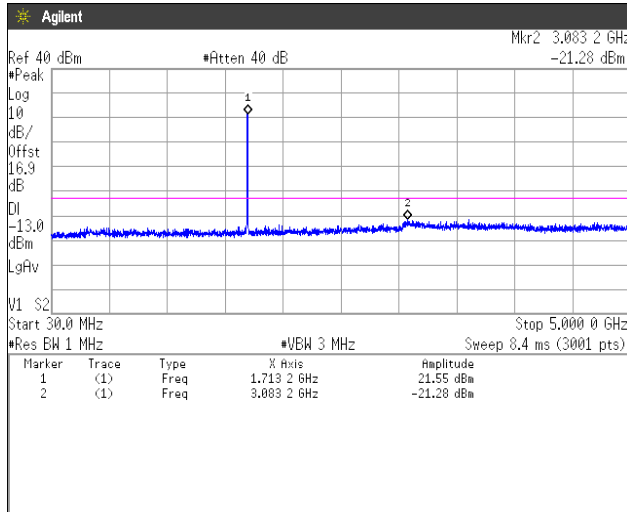

**5GHz-10GHz**

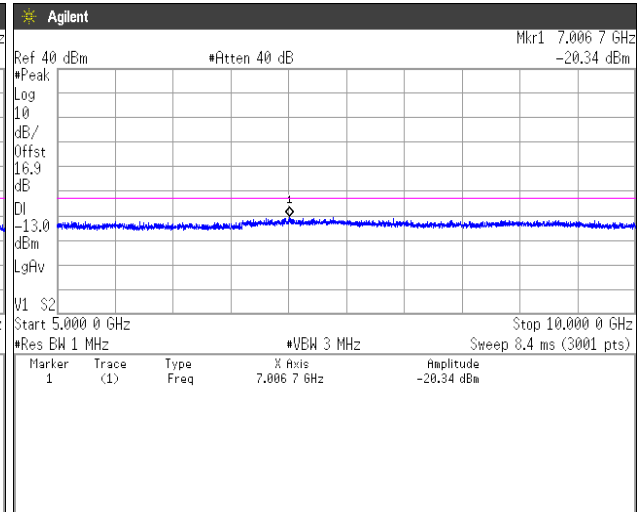

**10GHz-15GHz**

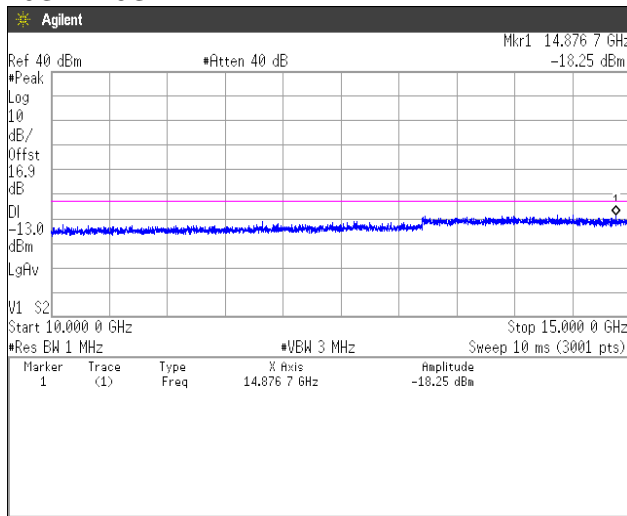

**15GHz-20GHz**

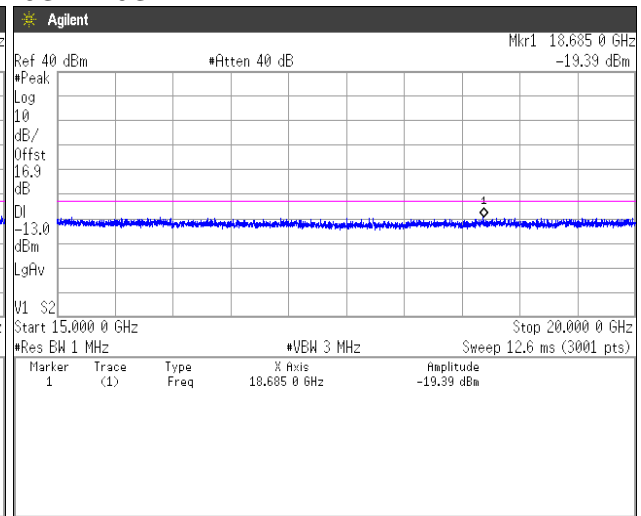



**Channel: 1413**  
**30MHz-5GHz**

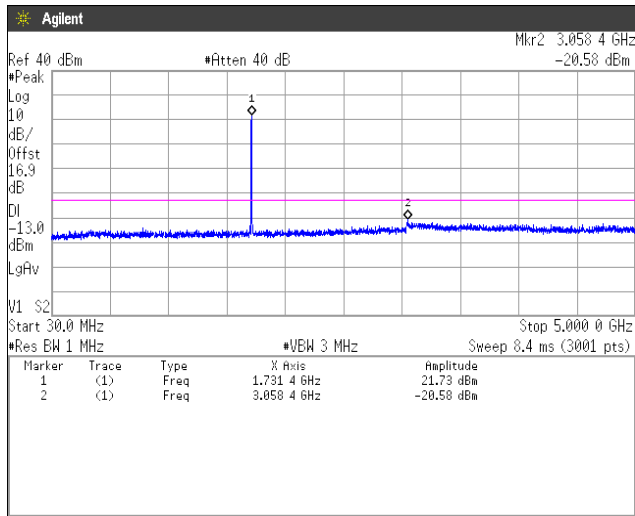

**5GHz-10GHz**

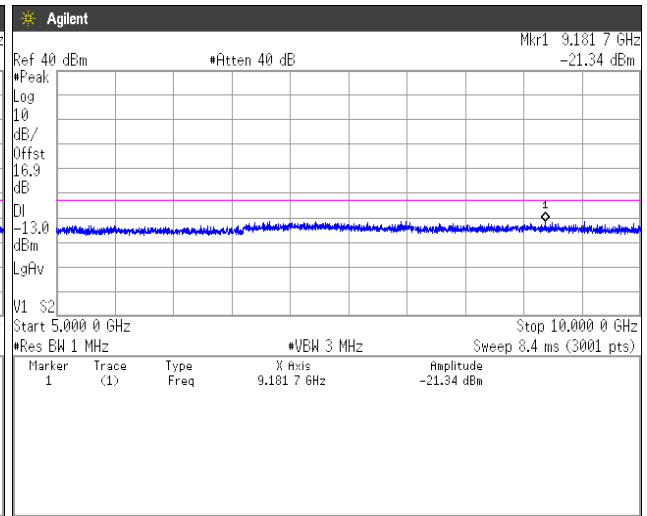

**10GHz-15GHz**

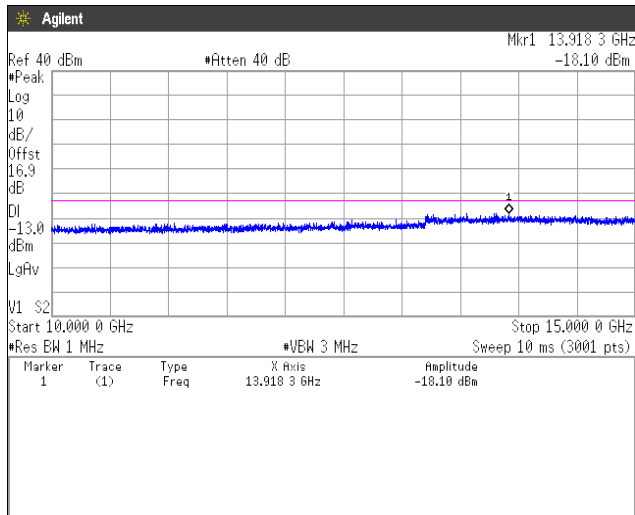

**15GHz-20GHz**

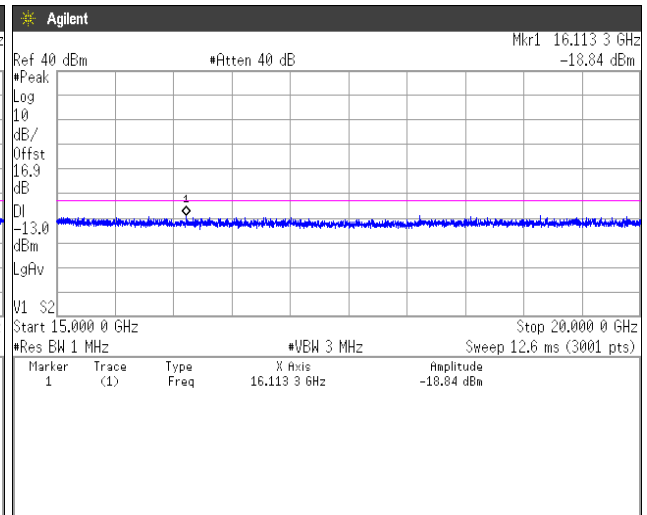



**Channel: 1513**  
**30MHz-5GHz**

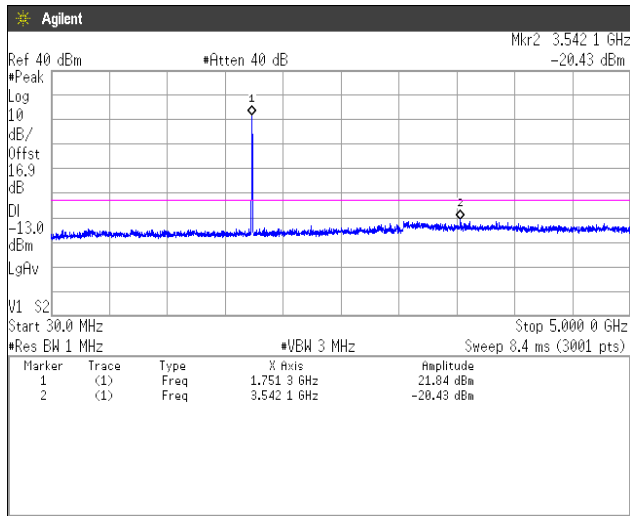

**5GHz-10GHz**

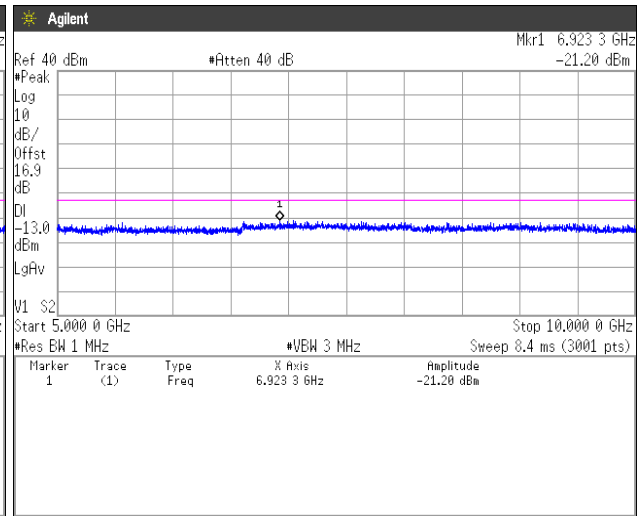

**10GHz-15GHz**

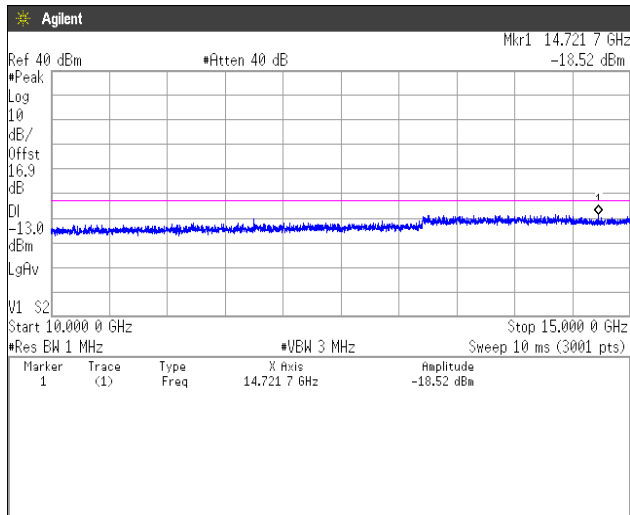

**15GHz-20GHz**

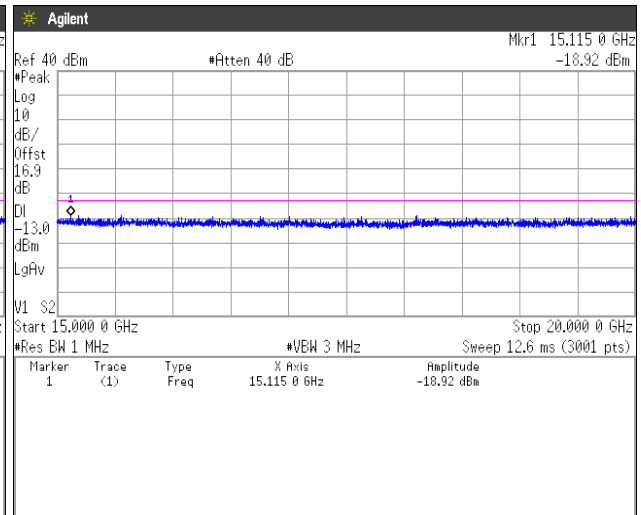



**[LTE Band IV]  
(Band Edge)  
QPSK, BW 1.4MHz, RB1-0  
Channel: Low**

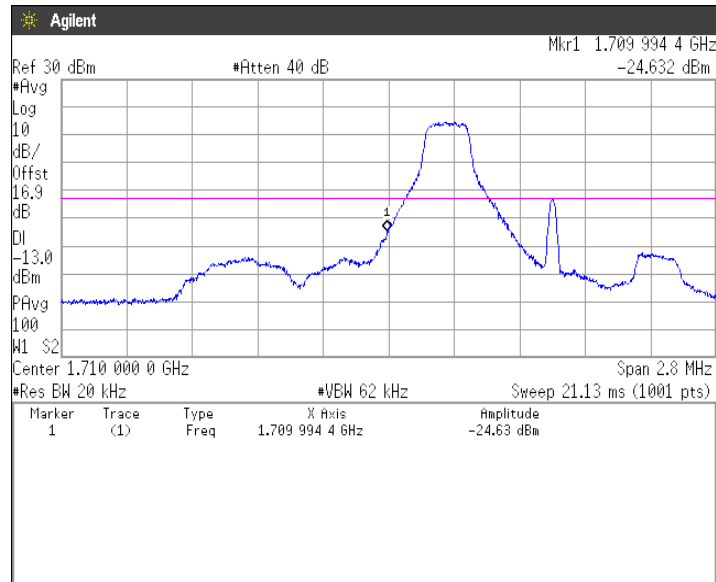

**QPSK, BW 1.4MHz, RB1-5  
Channel: High**

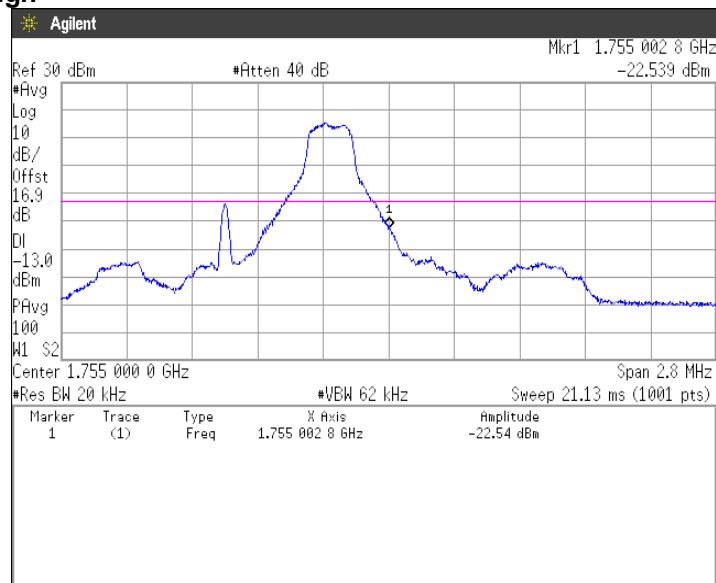



**QPSK, BW 1.4MHz, RB6-0**  
**Channel: Low**

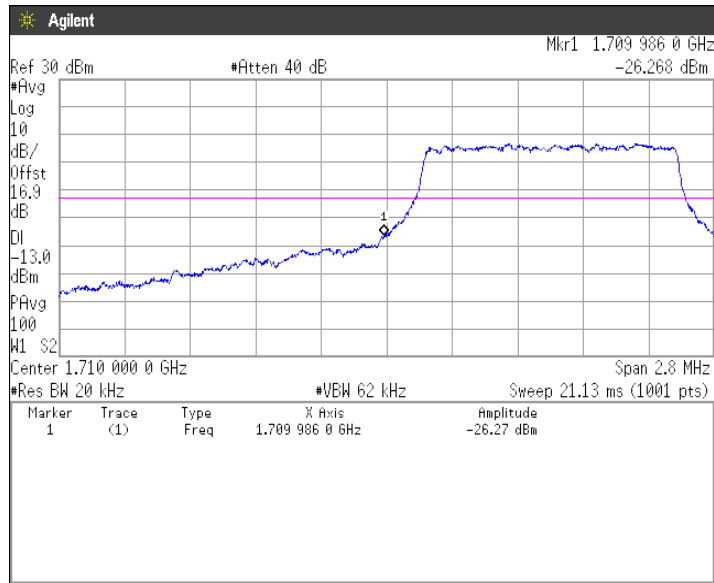

**QPSK, BW 1.4MHz, RB6-0**  
**Channel: High**

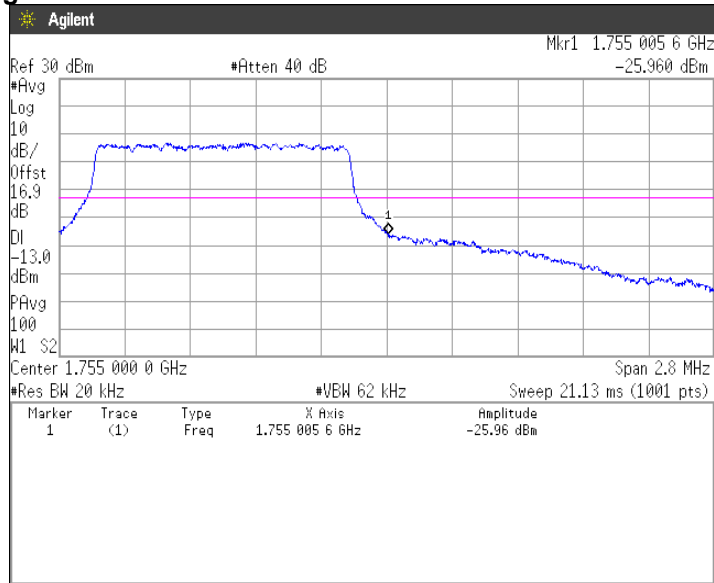



Japan

**QPSK, BW 3MHz, RB1-0**  
**Channel: Low**

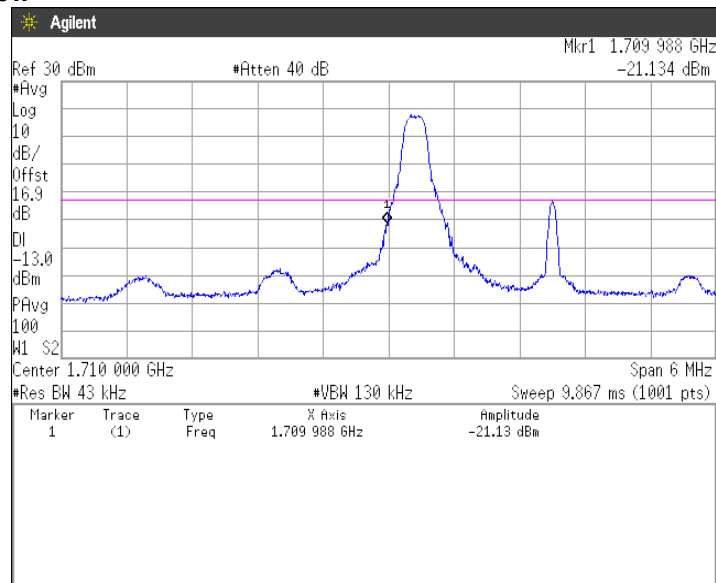

**QPSK, BW 3MHz, RB1-14**  
**Channel: High**

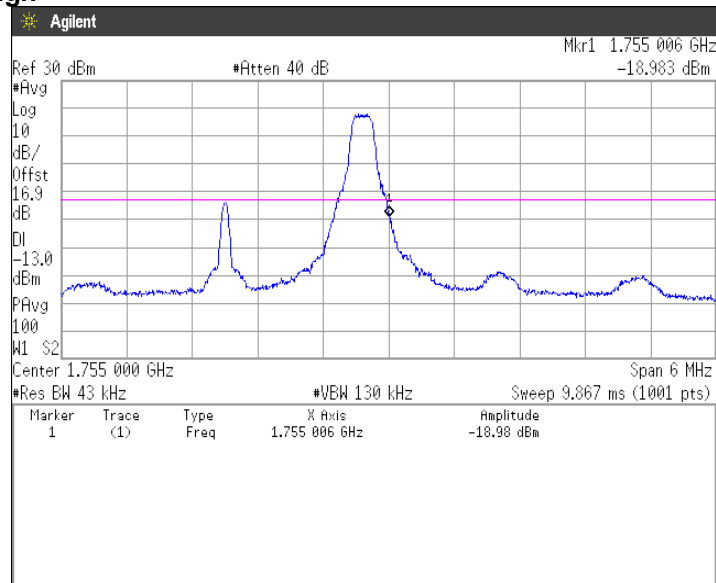



**QPSK, BW 3MHz, RB15-0**  
**Channel: Low**

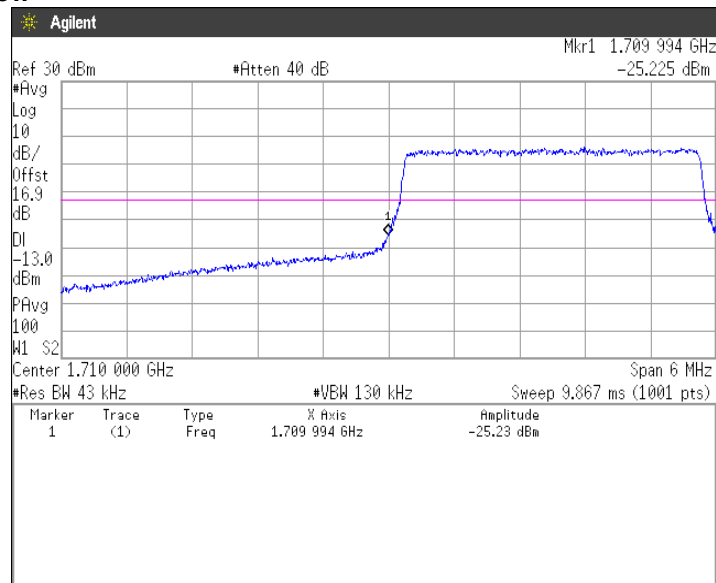

**QPSK, BW 3MHz, RB15-0**  
**Channel: High**

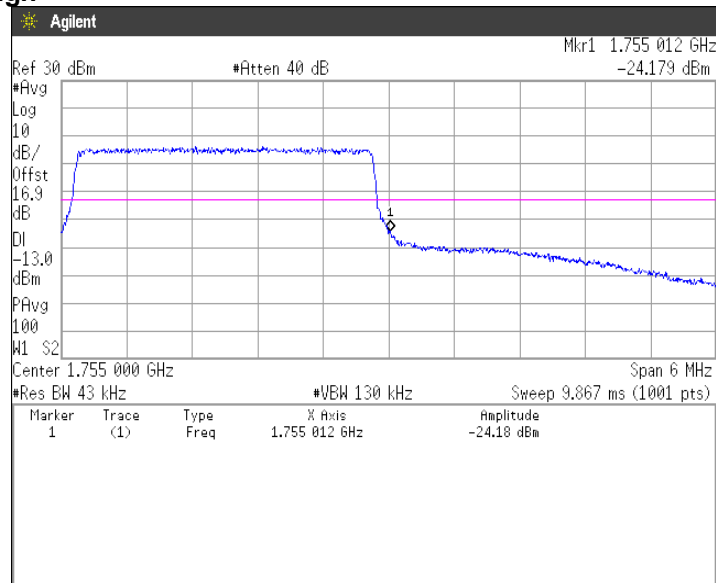



**QPSK, BW 5MHz, RB1-0**  
**Channel: Low**

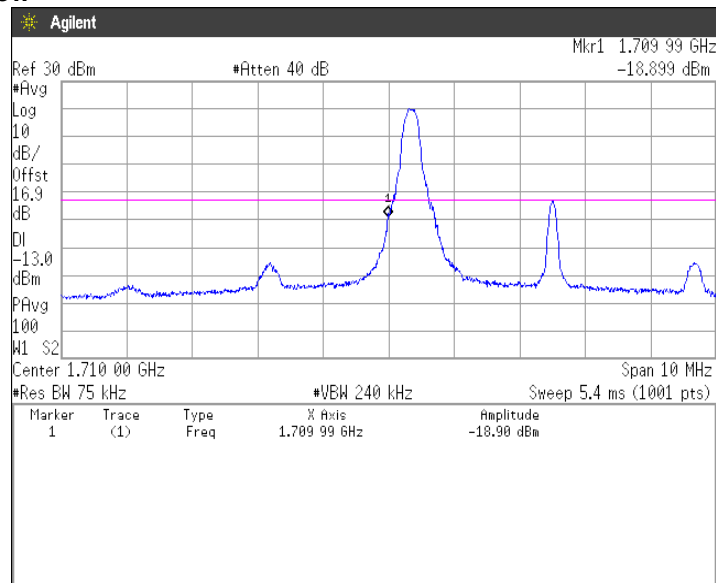

**QPSK, BW 5MHz, RB1-24**  
**Channel: High**

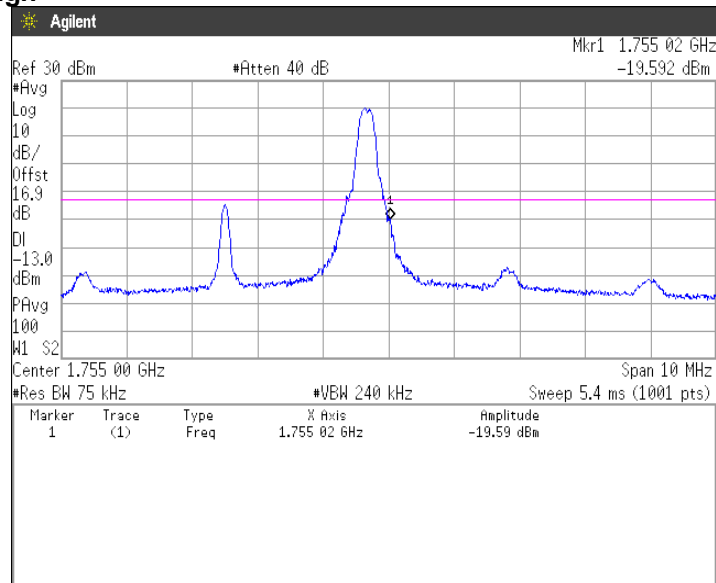





**QPSK, BW 5MHz, RB25-0**  
**Channel: Low**

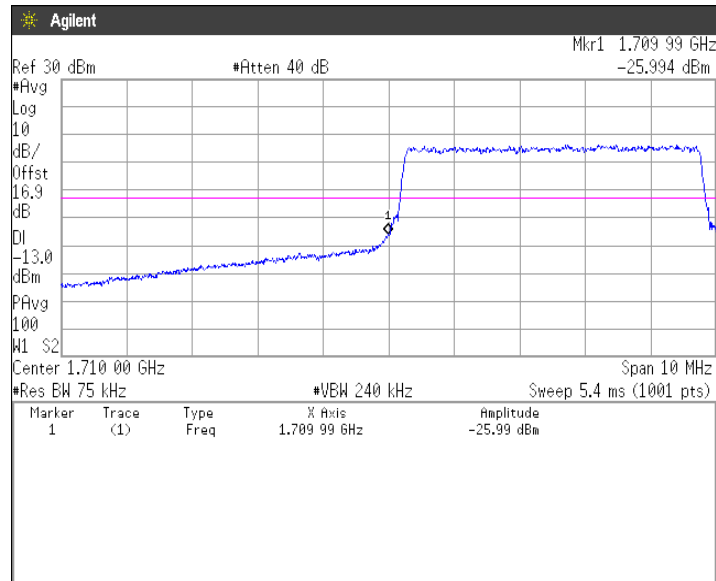

**QPSK, BW 5MHz, RB25-0**  
**Channel: High**

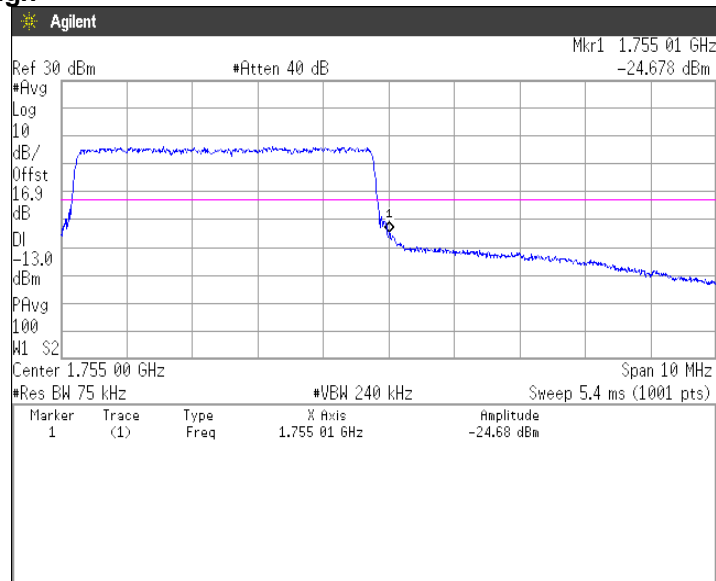



**QPSK, BW 10MHz, RB1-0**  
**Channel: Low**

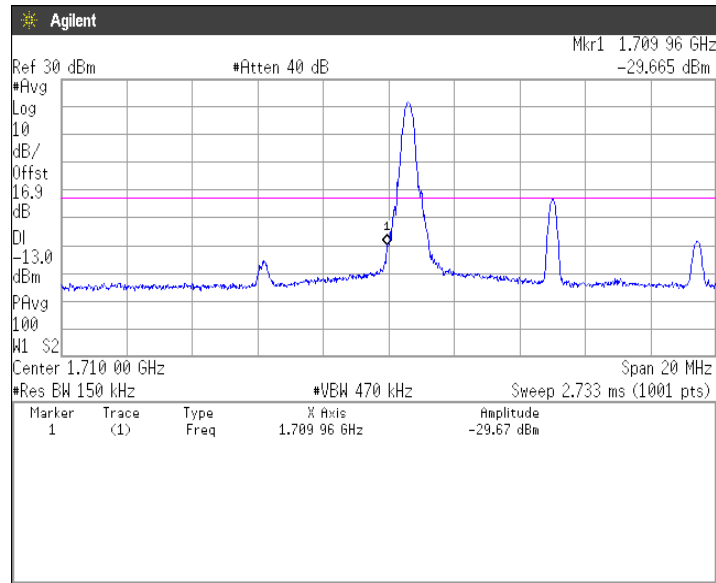

**QPSK, BW 10MHz, RB1-49**  
**Channel: High**

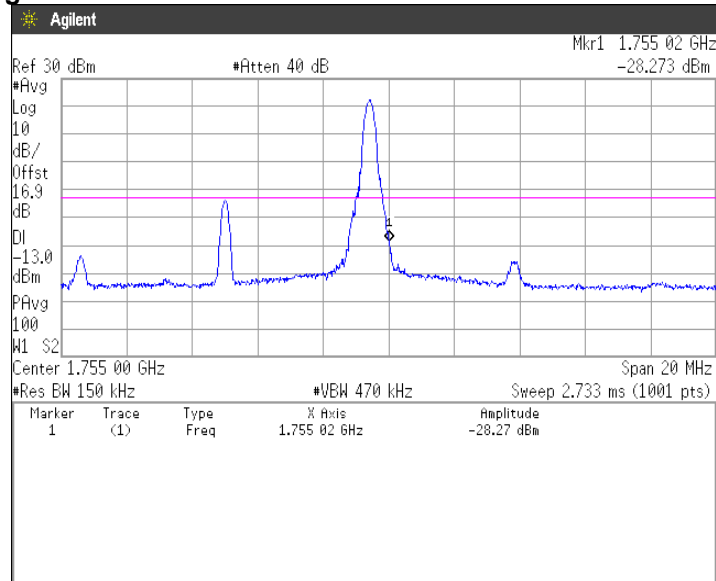



**QPSK, BW 10MHz, RB50-0**  
**Channel: Low**

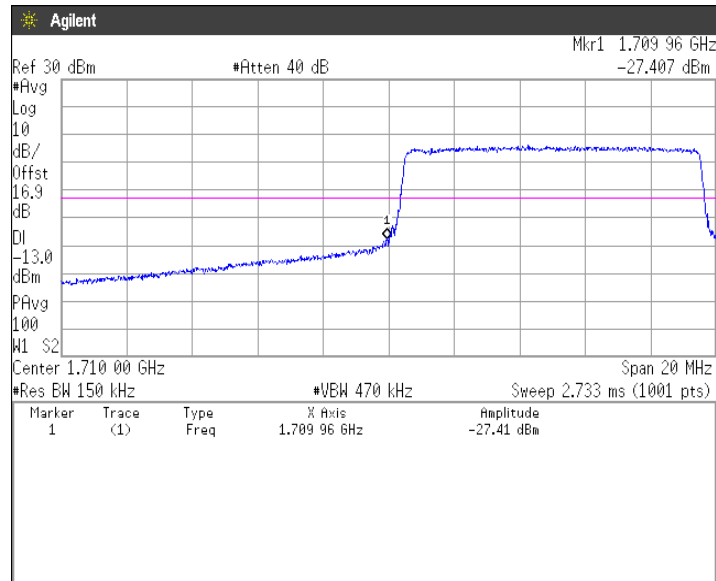

**QPSK, BW 10MHz, RB50-0**  
**Channel: High**

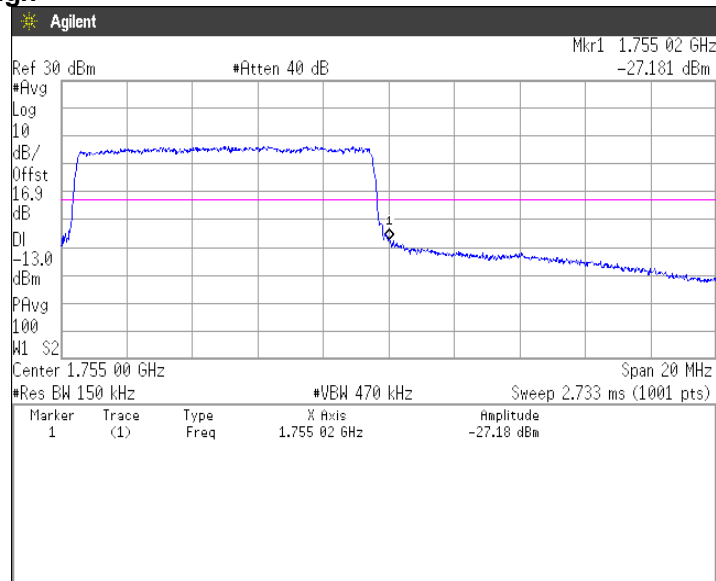



**QPSK, BW 15MHz, RB1-0**  
**Channel: Low**

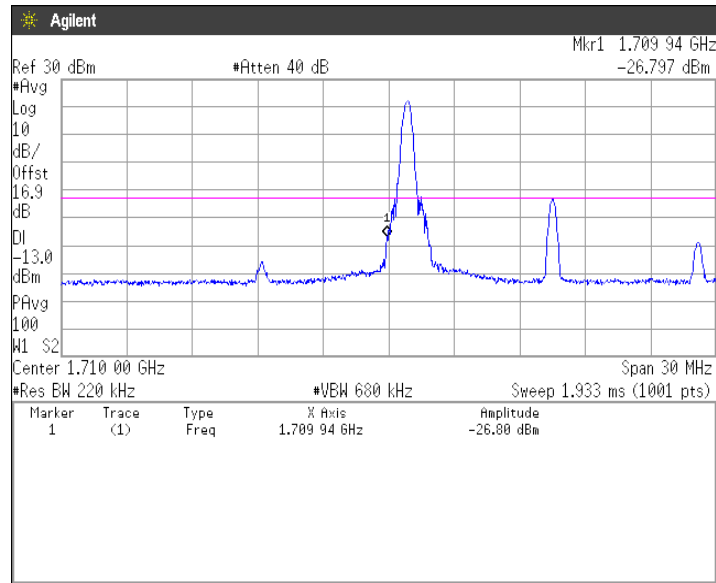

**QPSK, BW 15MHz, RB1-74**  
**Channel: High**

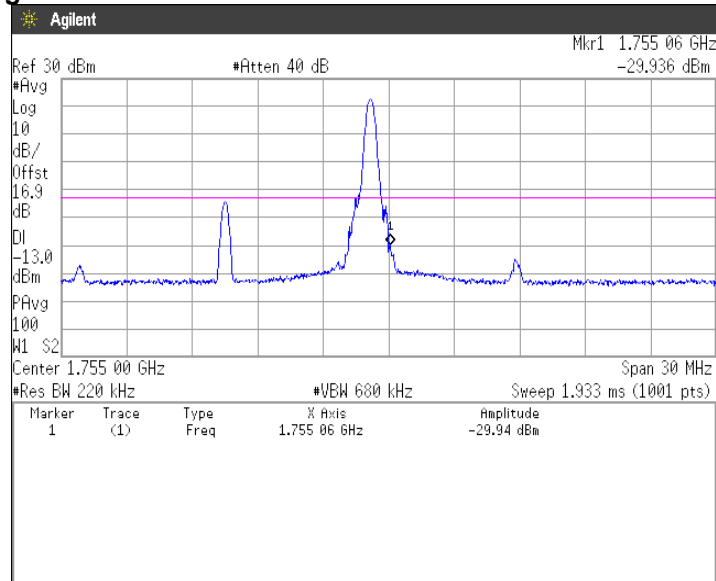



**QPSK, BW 15MHz, RB75-0**  
**Channel: Low**

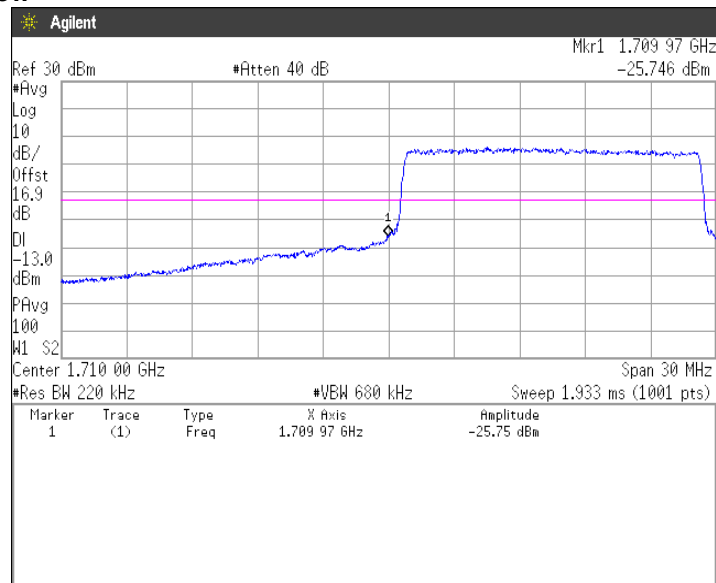

**QPSK, BW 15MHz, RB75-0**  
**Channel: High**

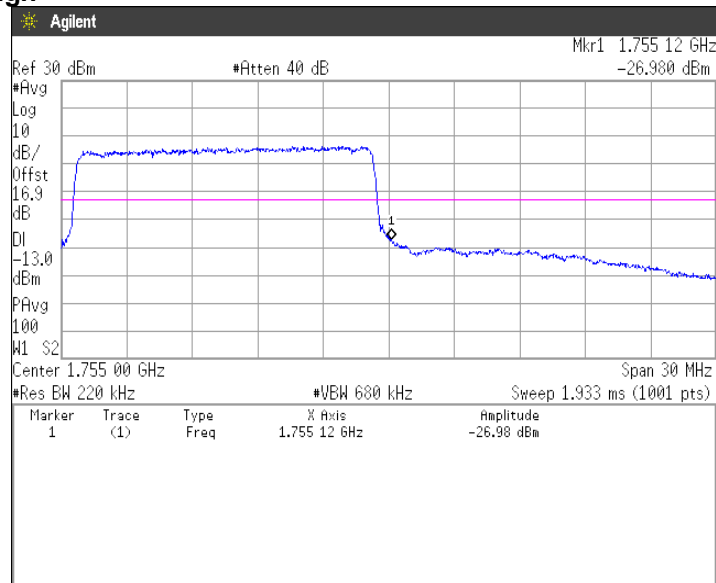



Japan

**QPSK, BW 20MHz, RB1-0**  
**Channel: Low**

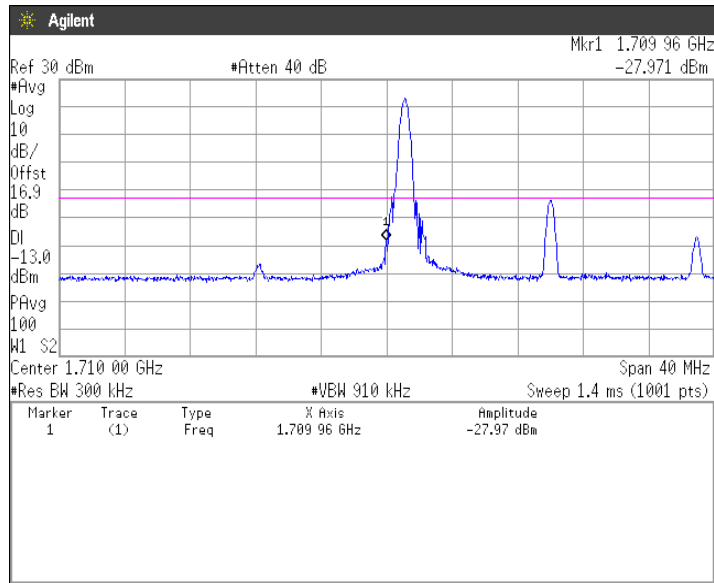

**QPSK, BW 20MHz, RB1-99**  
**Channel: High**

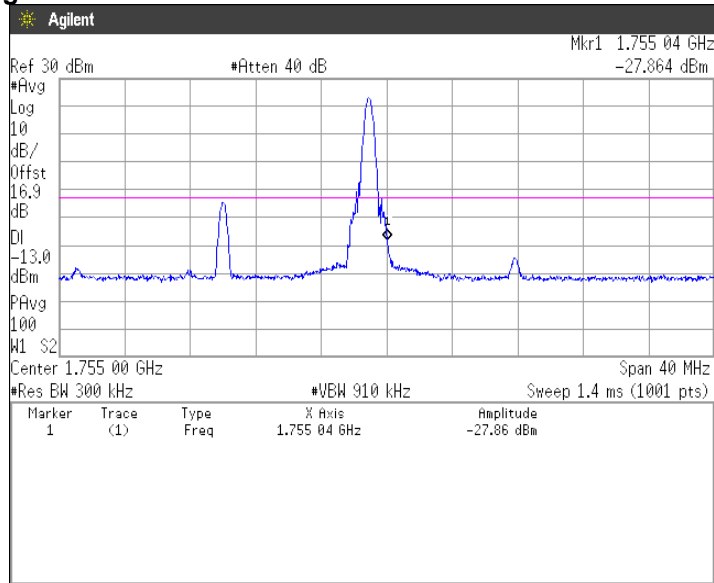



**QPSK, BW 20MHz, RB100-0**  
**Channel: Low**

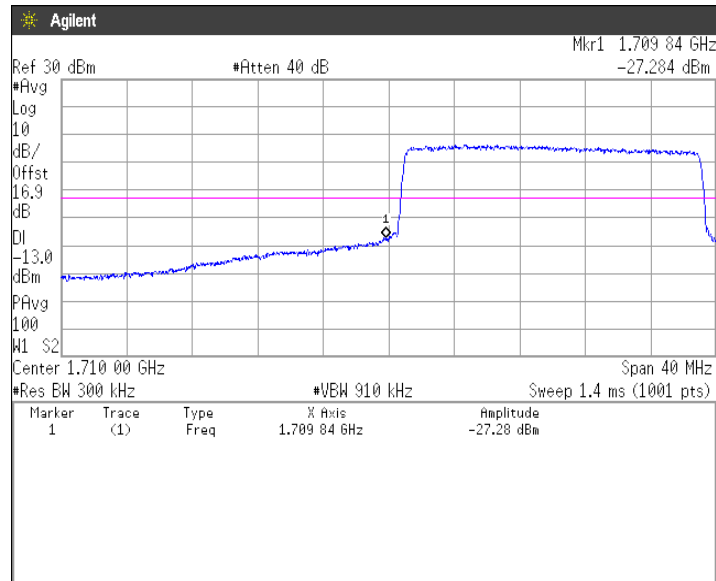

**QPSK, BW 20MHz, RB100-0**  
**Channel: High**

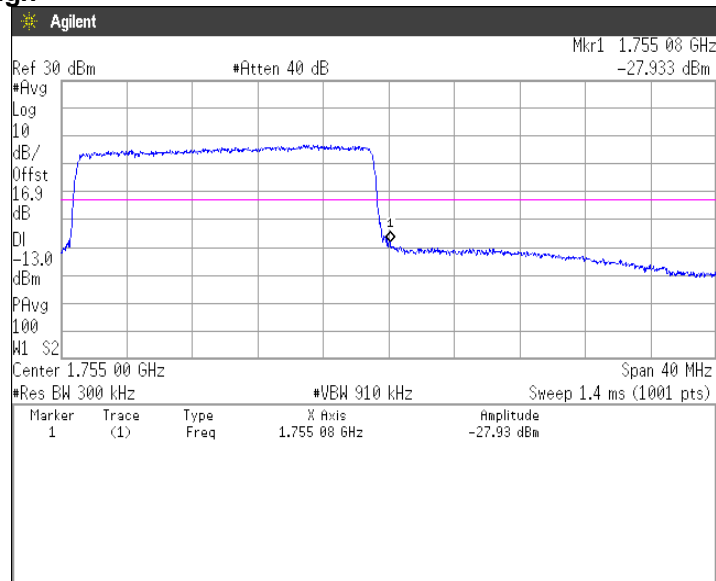



**16QAM, BW 1.4MHz, RB1-0**  
**Channel: Low**

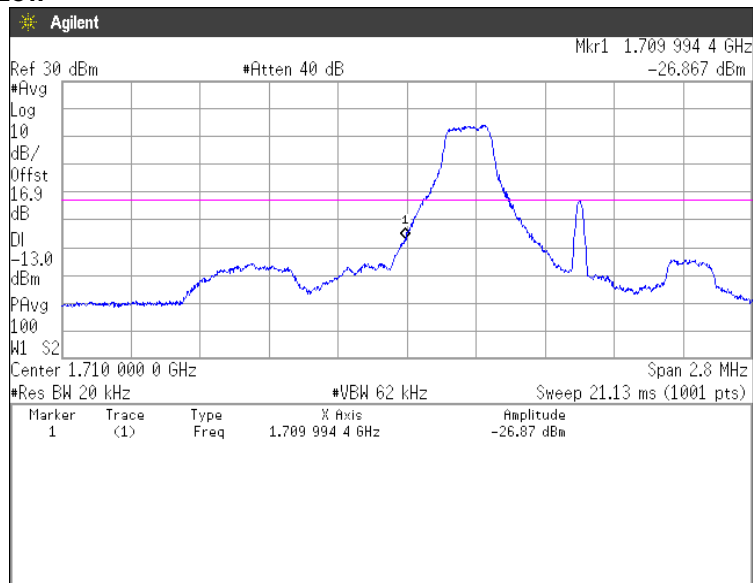

**16QAM, BW 1.4MHz, RB1-5**  
**Channel: High**

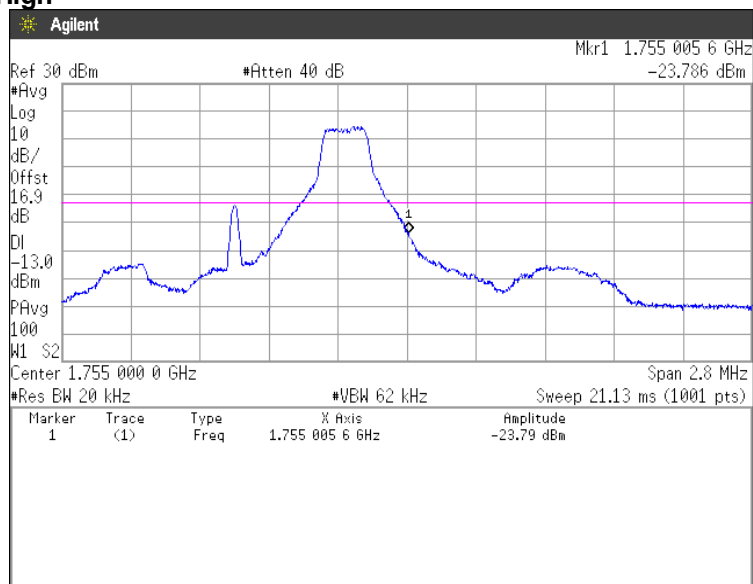





**16QAM, BW 1.4MHz, RB6-0**  
**Channel: Low**

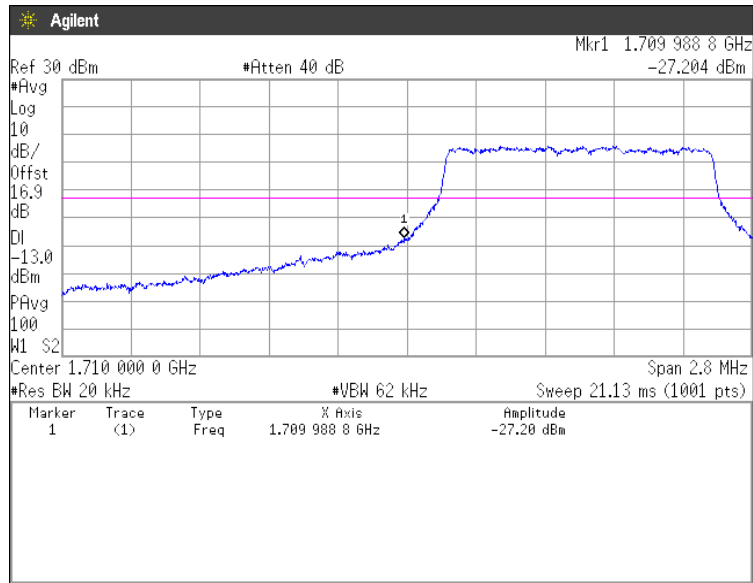

**16QAM, BW 1.4MHz, RB6-0**  
**Channel: High**

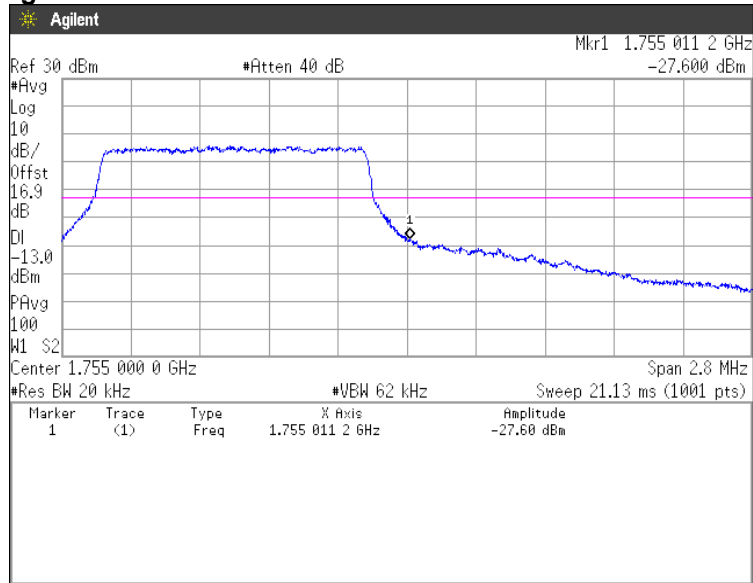



**16QAM, BW 3MHz, RB1-0**  
**Channel: Low**

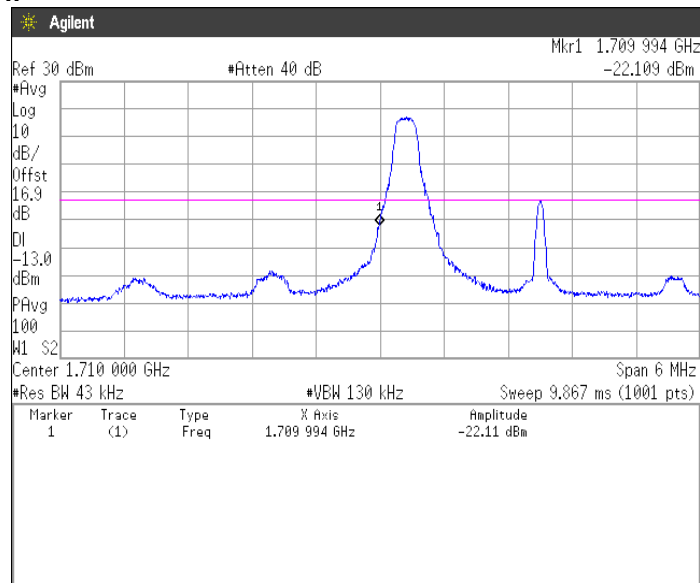

**16QAM, BW 3MHz, RB1-14**  
**Channel: High**

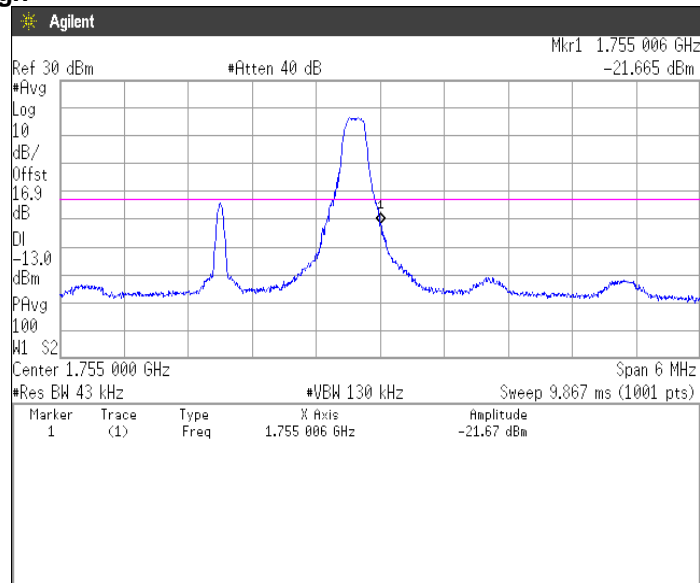



**16QAM, BW 3MHz, RB15-0**  
**Channel: Low**

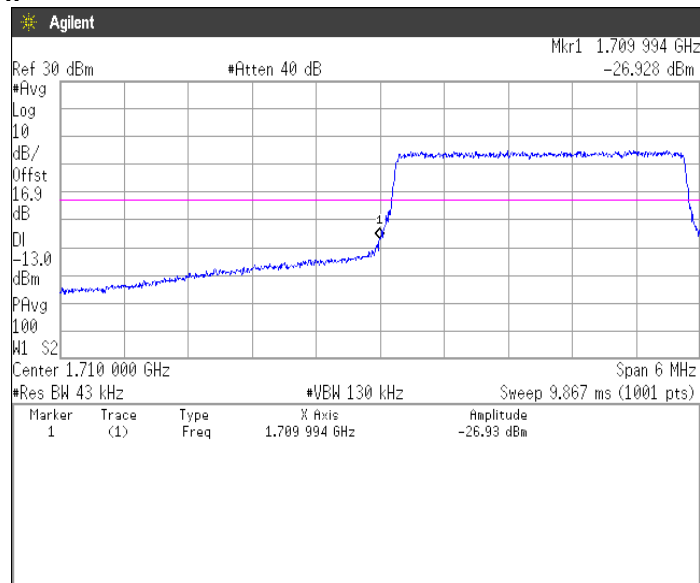

**16QAM, BW 3MHz, RB15-0**  
**Channel: High**

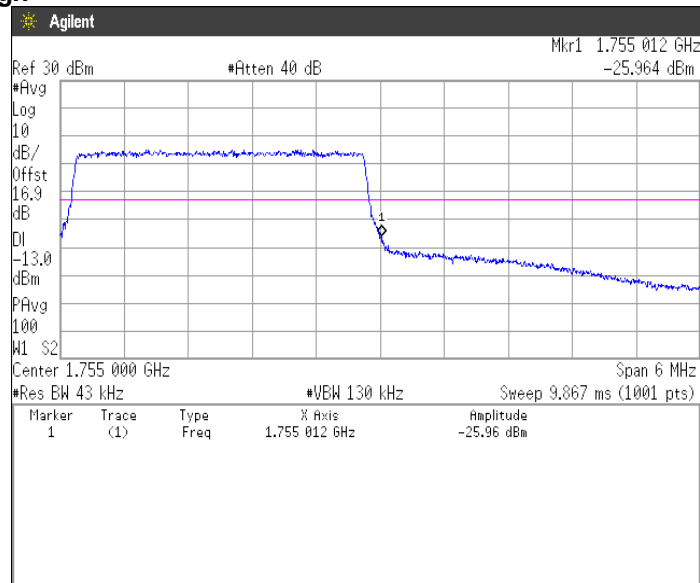



**16QAM, BW 5MHz, RB1-0**  
**Channel: Low**

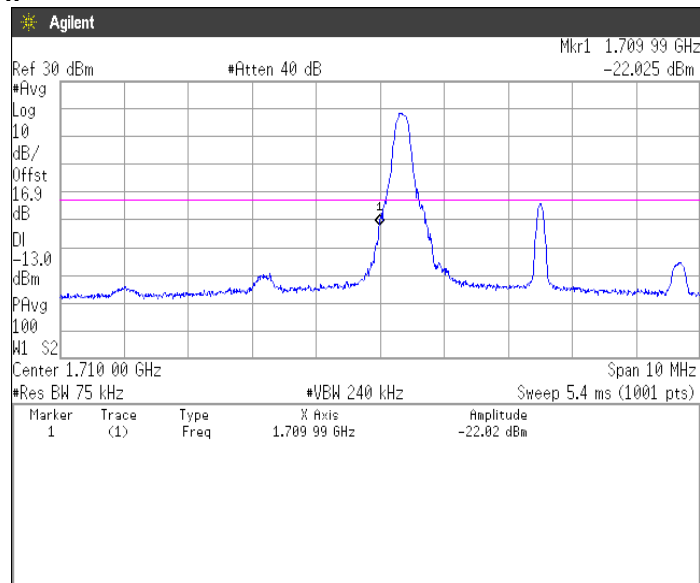

**16QAM, BW 5MHz, RB1-24**  
**Channel: High**

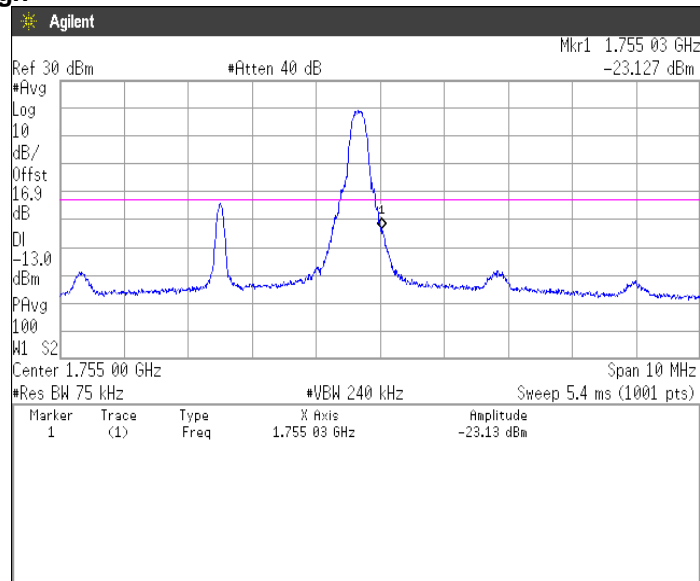



**16QAM, BW 5MHz, RB25-0**  
**Channel: Low**

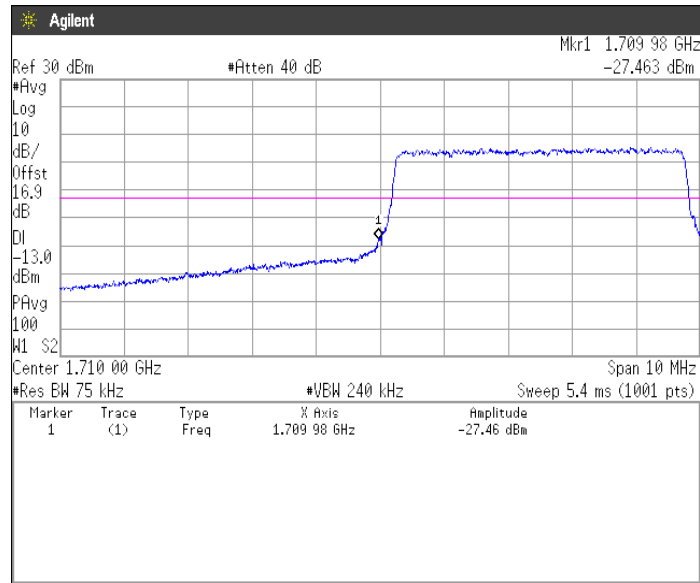

**16QAM, BW 5MHz, RB25-0**  
**Channel: High**

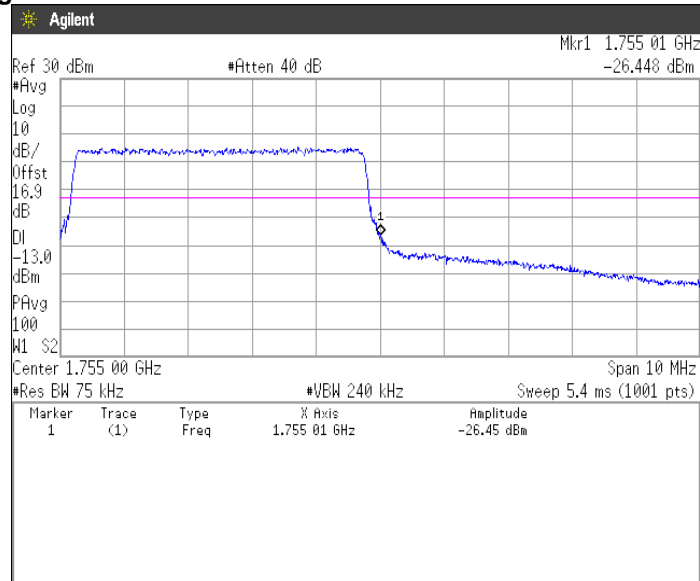



**16QAM, BW 10MHz, RB1-0**  
**Channel: Low**

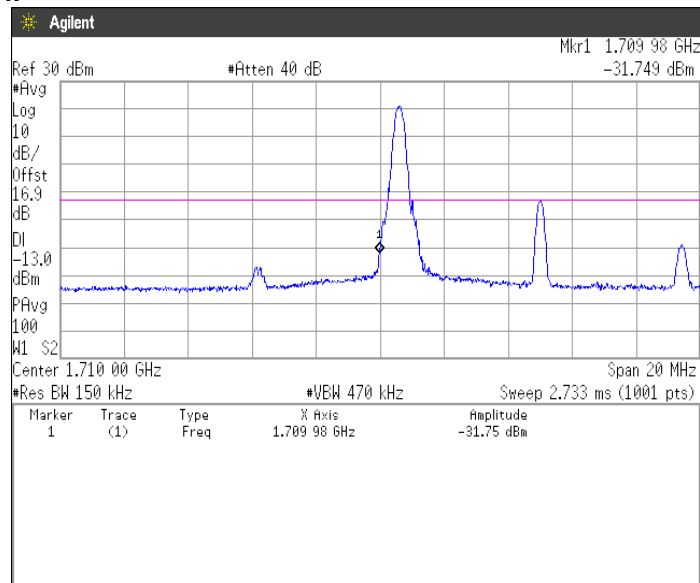

**16QAM, BW 10MHz, RB1-49**  
**Channel: High**

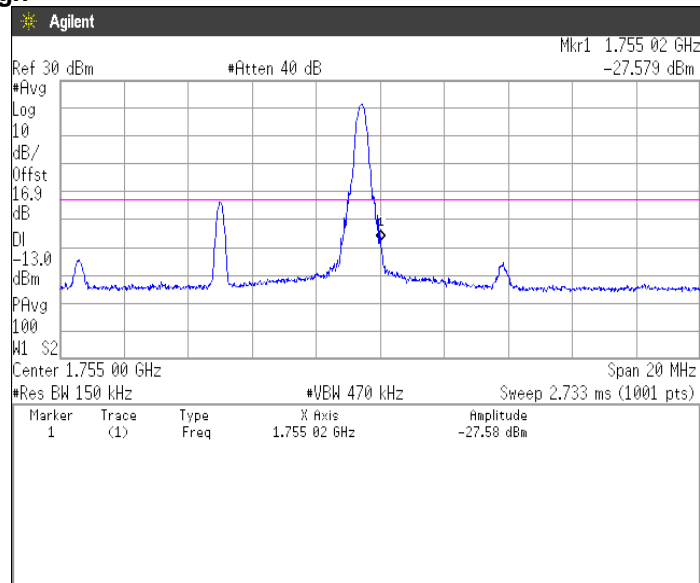



Japan

**16QAM, BW 10MHz, RB50-0**  
**Channel: Low**

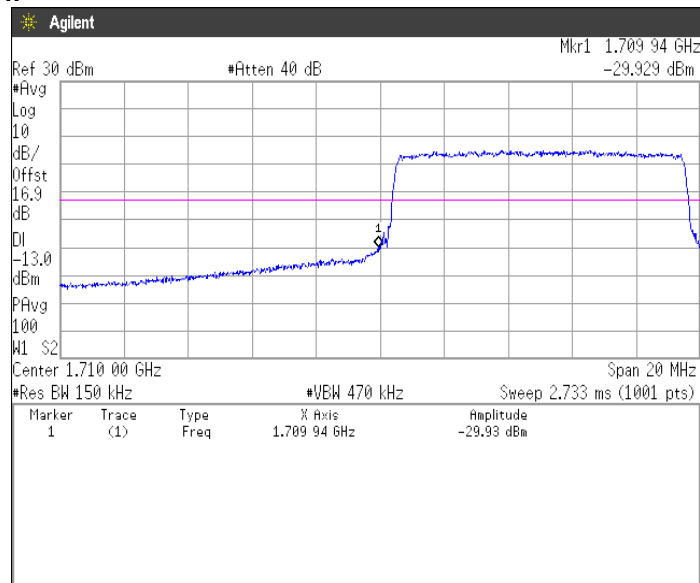

**16QAM, BW 10MHz, RB50-0**  
**Channel: High**

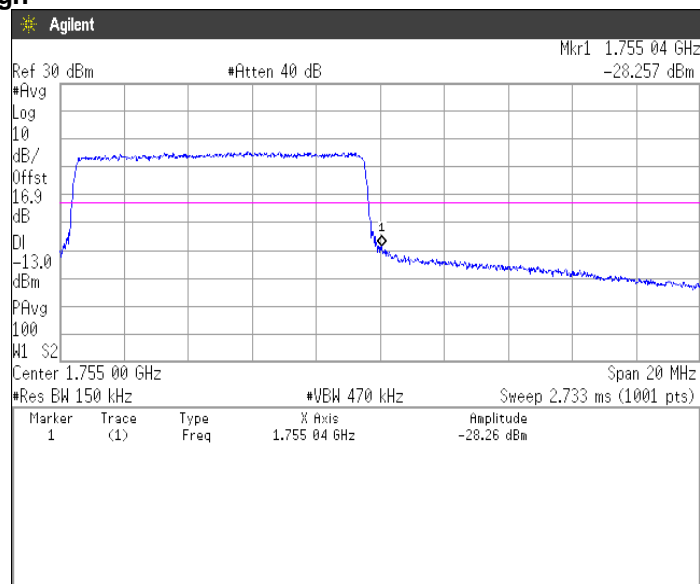



**16QAM, BW 15MHz, RB1-0**  
**Channel: Low**

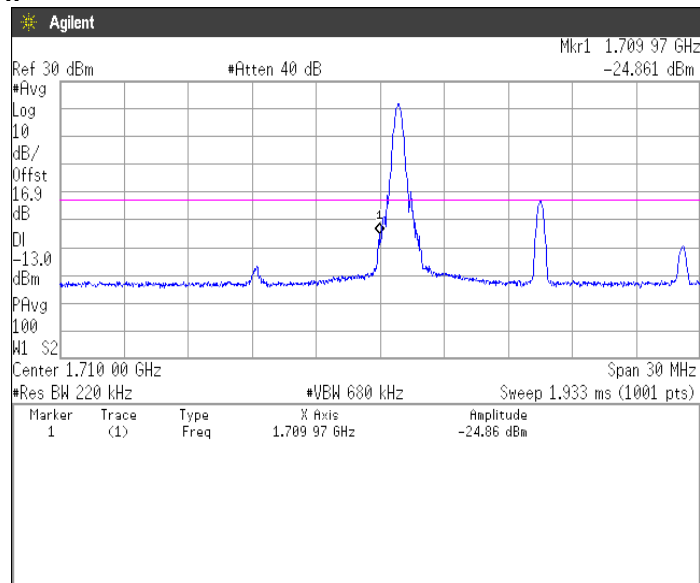

**16QAM, BW 15MHz, RB1-74**  
**Channel: High**

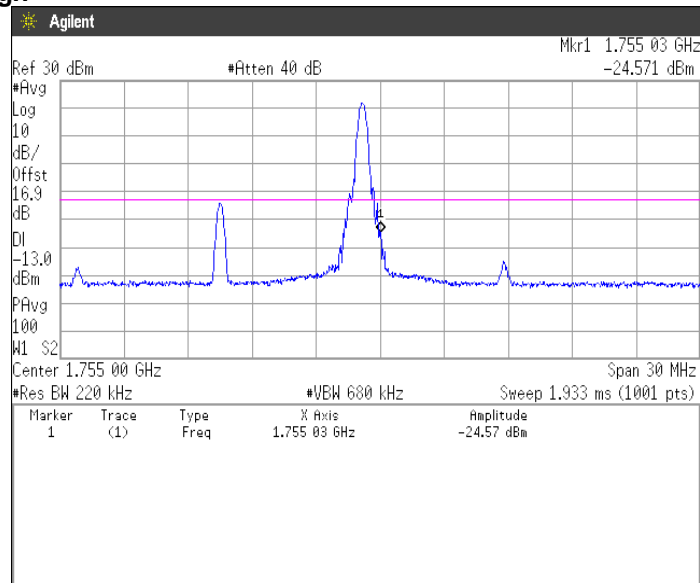





Japan

**16QAM, BW 15MHz, RB75-0**  
**Channel: Low**

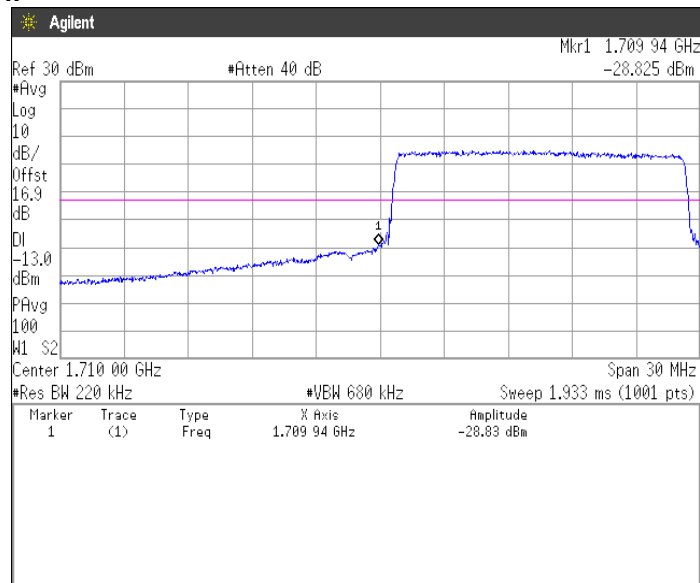

**16QAM, BW 15MHz, RB75-0**  
**Channel: High**

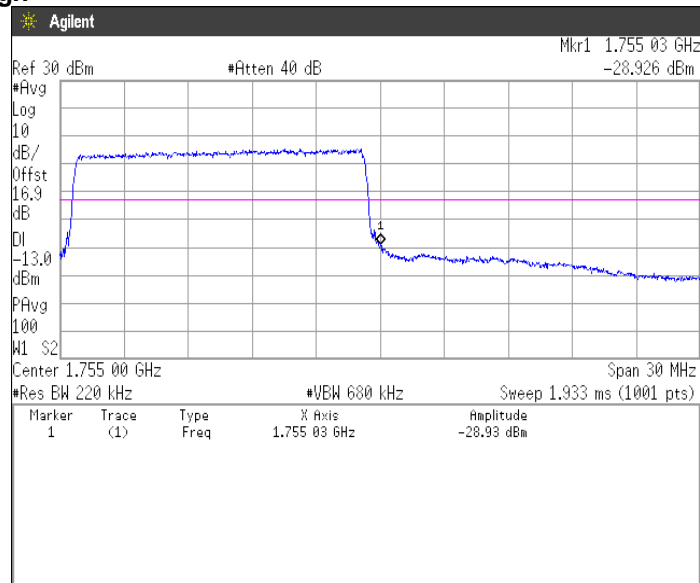



**16QAM, BW 20MHz, RB1-0**  
**Channel: Low**

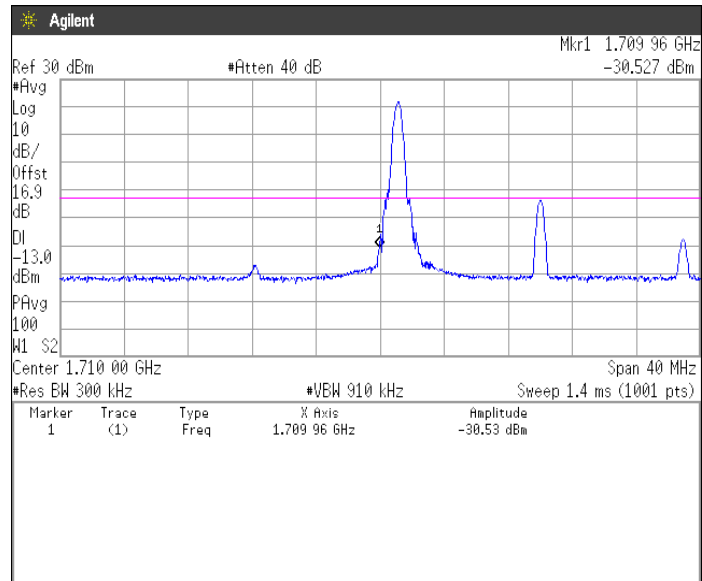

**16QAM, BW 20MHz, RB1-99**  
**Channel: High**

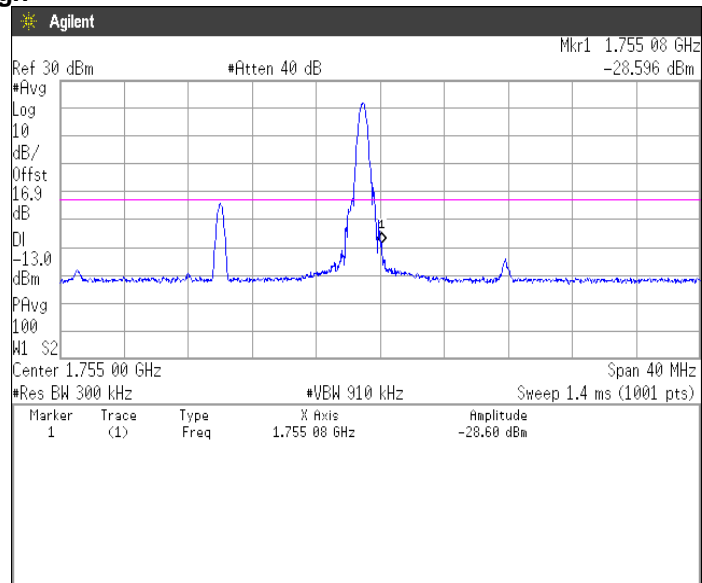



**16QAM, BW 20MHz, RB100-0**  
**Channel: Low**

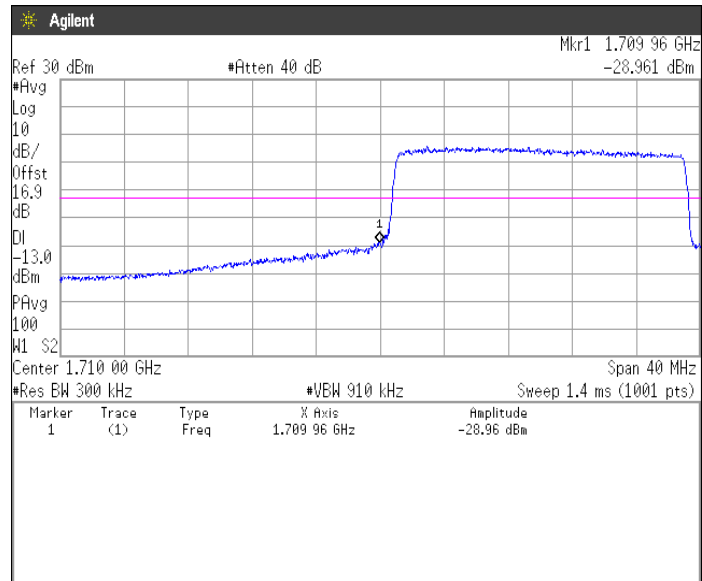

**16QAM, BW 20MHz, RB100-0**  
**Channel: High**

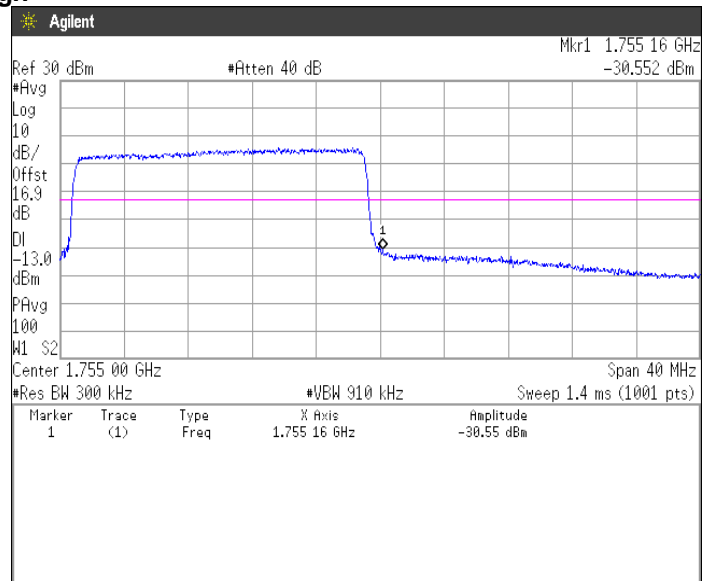



**(Spurious Emissions)**

**Note: Conducted spurious test was measured in the worst case of conducted output power.**

**QPSK, BW 20MHz  
Channel: 20050  
30MHz-5GHz**

**5GHz-10GHz**

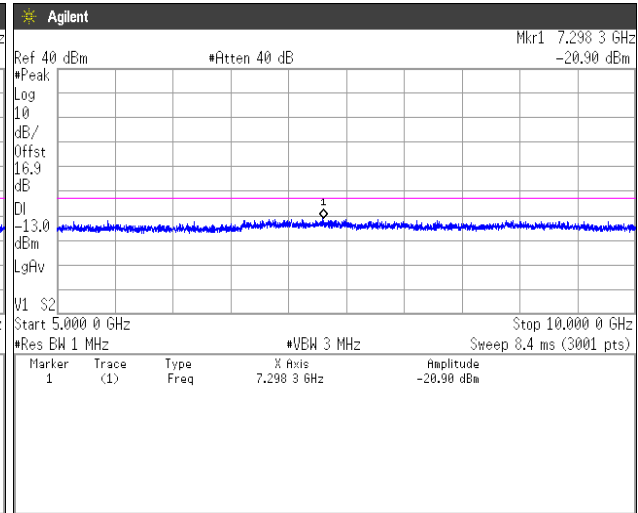
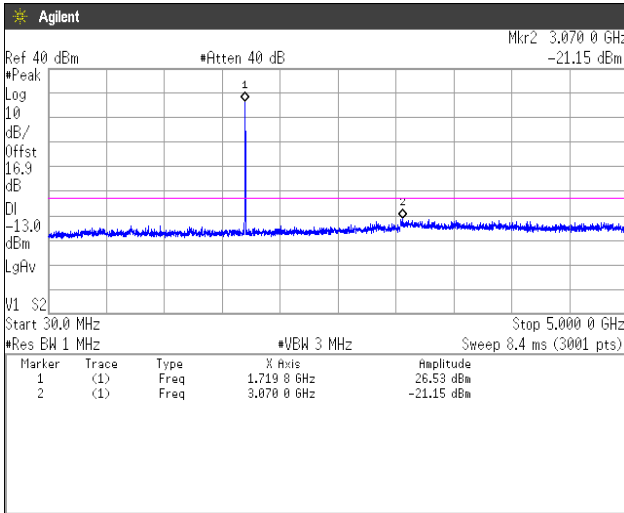

**10GHz-15GHz**

**15GHz-20GHz**

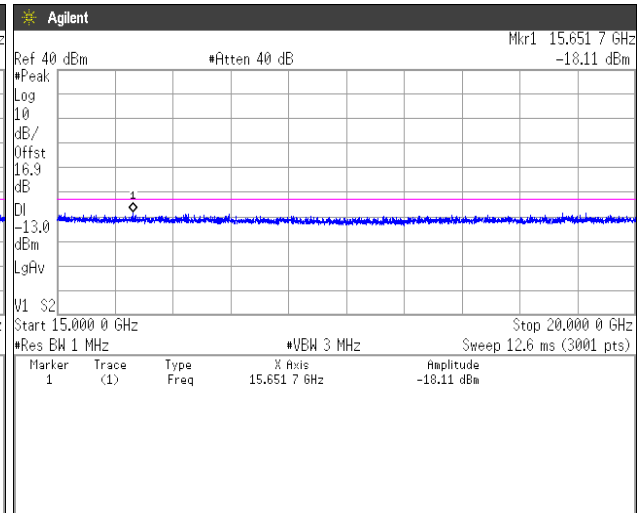
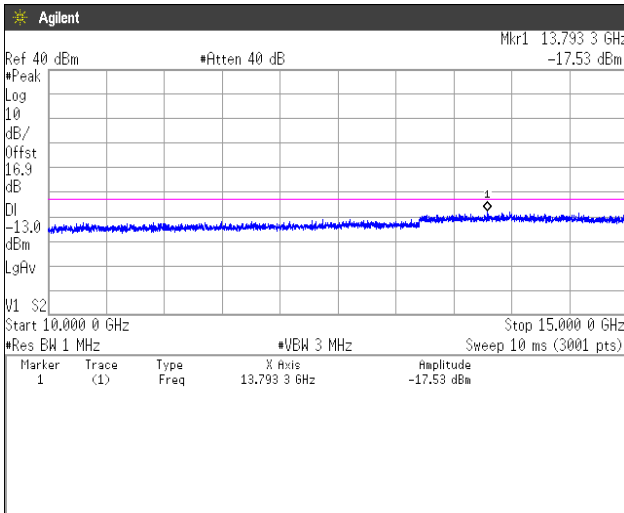



**Channel: 20175**  
**30MHz-5GHz**

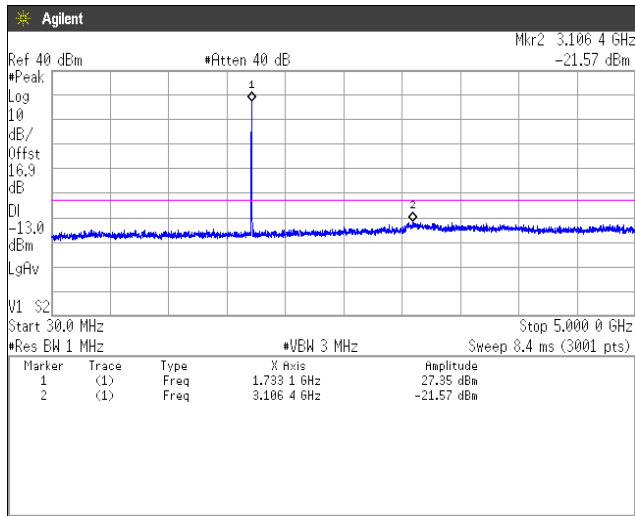

**5GHz-10GHz**

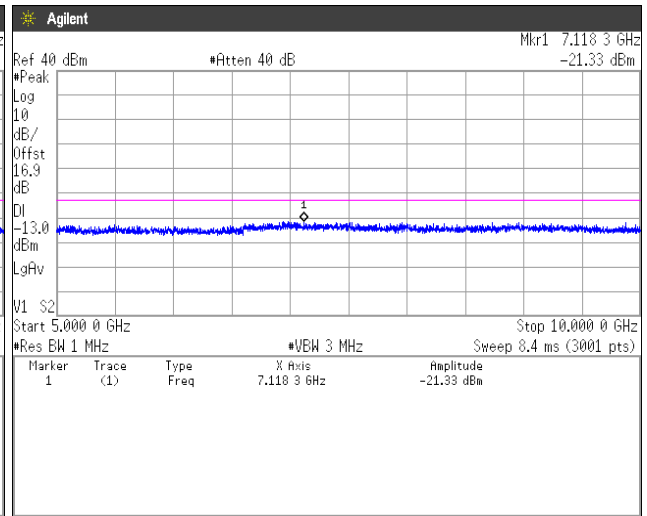

**10GHz-15GHz**

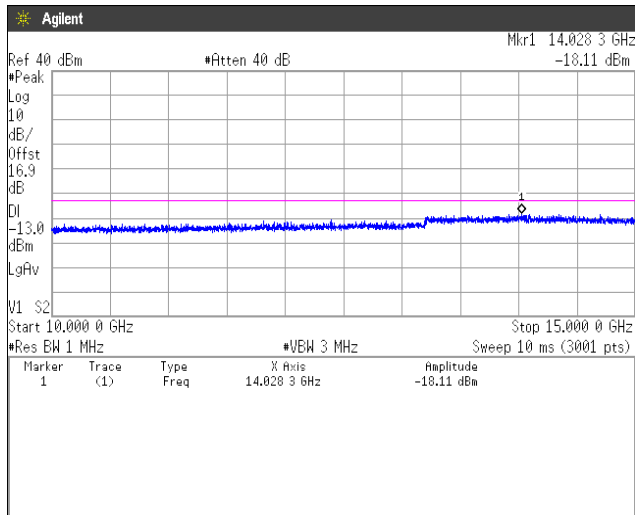

**15GHz-20GHz**

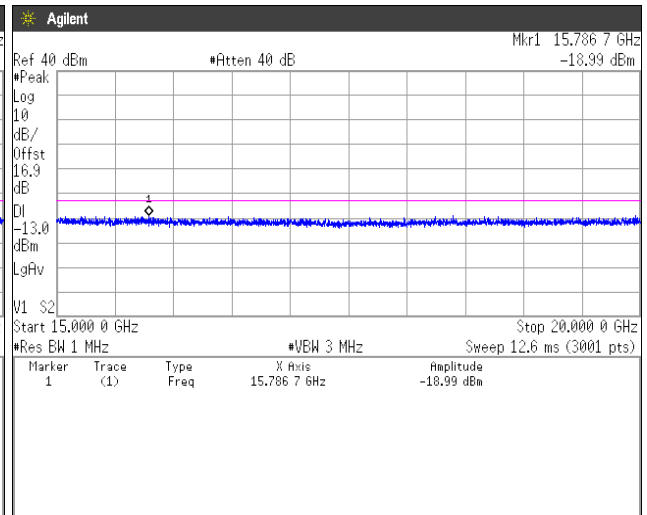



**Channel: 20300**  
**30MHz-5GHz**

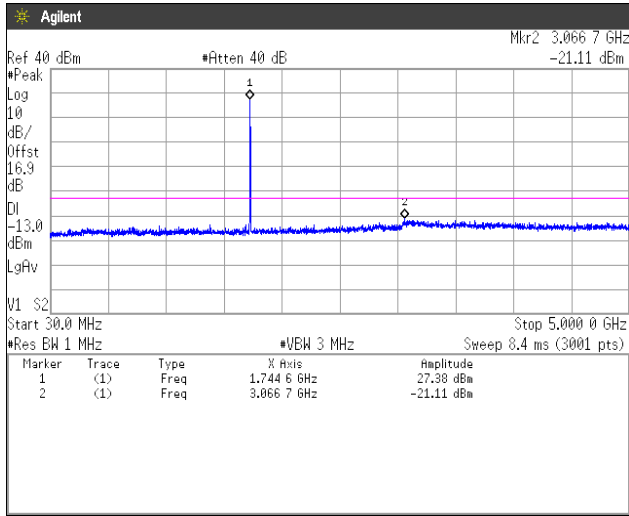

**5GHz-10GHz**

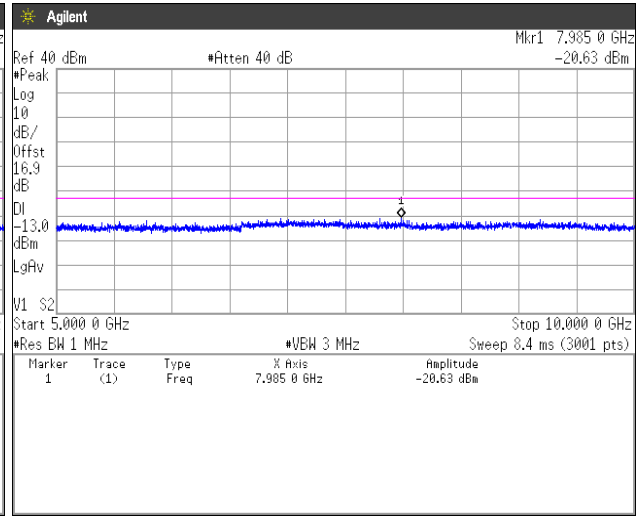

**10GHz-15GHz**

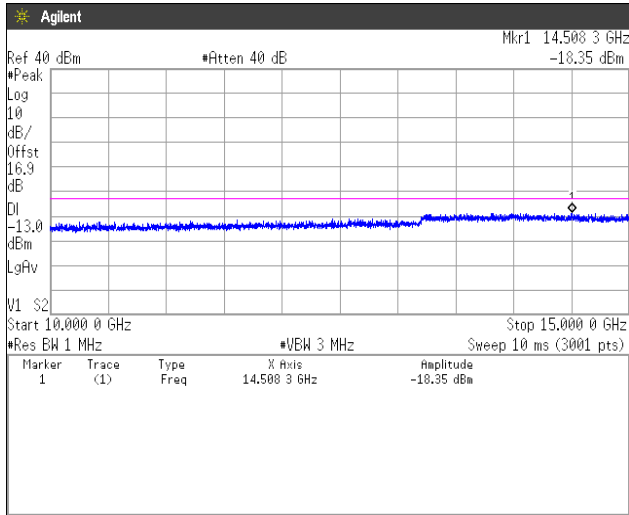

**15GHz-20GHz**

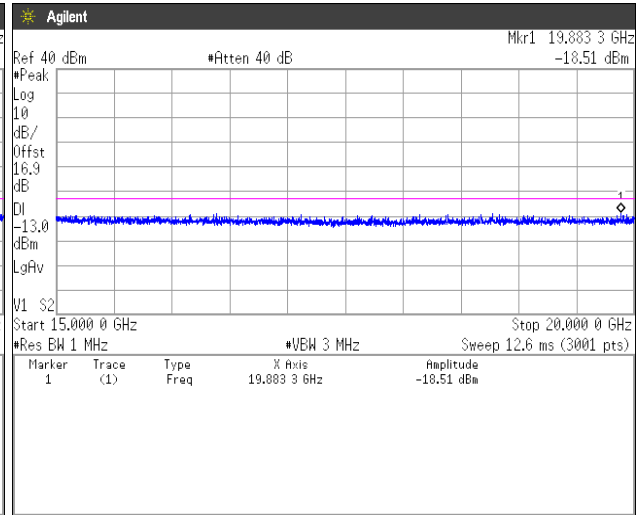

## 4.5 Radiated Emissions and Harmonic Emissions

### 4.5.1 Measurement procedure

#### [FCC 27.53, 2.1053]

##### <Step 1>

The EUT and support equipment are placed on a 1 meter x 1 meter surface, 0.8 meter height styrene foam table. Radiated emission measurements are performed at 3 meter distance with the broadband antenna (Biconical antenna, Log periodic antenna and double ridged guide antenna). The antenna is positioned both the horizontal and vertical planes of polarization and height is varied 1 to 4 meters and stopped at height producing the maximum emission.

The bandwidth of the spectrum analyzer is set to 1 MHz. The turntable is rotated by 360 degrees and stopped at azimuth of producing the maximum emission. The frequency is investigated up to 20GHz.

##### <Step 2>

The substitution antenna is replaced by the transmitter antenna (EUT).

The frequency of the signal generator is adjusted to the measurement frequency.

Level of the signal generator is adjusted to the level that is obtained from step 1, and record the emission level of signal generator.

The spectrum analyzer is set to;

- RBW = 100 kHz for below 1GHz and 1MHz for above 1GHz / VBW  $\geq 3 \times$  RBW
- Detector = Peak
- Trace mode = Max hold
- Sweep time = auto-couple

- Test configuration

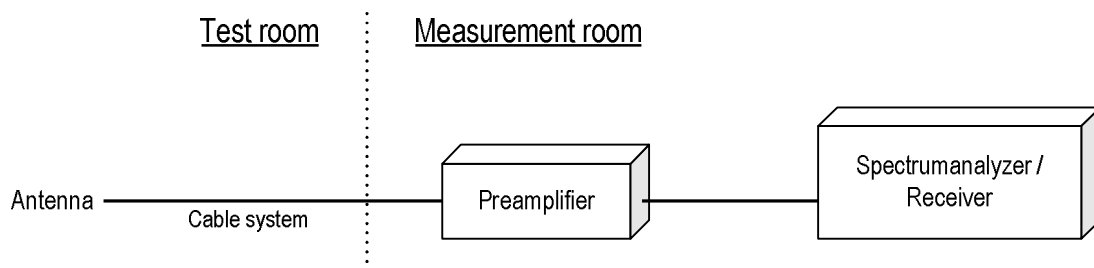

#### 4.5.2 Calculation method

Result (EIRP) = Ant. Input - Cable loss + Antenna Gain  
 Margin = Limit - Result (EIRP)

Example:

Limit @ 3465.0 MHz : -13.0 dBm  
 Ant. Input = -50.7 dBm Cable loss = 1.6 dB Ant. Gain = 9.1 dBi  
 Result = -50.7 - 1.6 + 9.1 = -43.2 dBm  
 Margin = -13.0 - (-43.2) = 30.2 dB

#### 4.5.3 Limit

-13 dBm or less

#### 4.5.4 Test data

Date	: 12-September-2019		
Temperature	: 21.5 [°C]		
Humidity	: 57.3 [%]	Test engineer	:
Test place	: 3m Semi-anechoic chamber		<u>Chiaki Kanno</u>
Date	: 13~14-September-2019		
Temperature	: 22.2 [°C]		
Humidity	: 51.9 [%]	Test engineer	:
Test place	: 3m Semi-anechoic chamber		<u>Tadahiro Seino</u>
Date	: 24~25-September-2019		
Temperature	: 22.9 [°C]		
Humidity	: 56.0 [%]	Test engineer	:
Test place	: 3m Semi-anechoic chamber		<u>Tadahiro Seino</u>
Date	: 25~26-September-2019		
Temperature	: 21.9 [°C]		
Humidity	: 50.4 [%]	Test engineer	:
Test place	: 3m Semi-anechoic chamber		<u>Tadahiro Seino</u>
Date	: 26~27-September-2019		
Temperature	: 22.4 [°C]		
Humidity	: 44.1 [%]	Test engineer	:
Test place	: 3m Semi-anechoic chamber		<u>Tadahiro Seino</u>
Date	: 27~28-September-2019		
Temperature	: 22.8 [°C]		
Humidity	: 44.8 [%]	Test engineer	:
Test place	: 3m Semi-anechoic chamber		<u>Tadahiro Seino</u>
Date	: 30-September-2019		
Temperature	: 20.3 [°C]		
Humidity	: 57.9 [%]	Test engineer	:
Test place	: 3m Semi-anechoic chamber		<u>Tadahiro Seino</u>



Date : 1-October-2019  
 Temperature : 22.8 [°C]  
 Humidity : 53.9 [%]  
 Test place : 3m Semi-anechoic chamber

Test engineer : Chiaki Kanno

**[WCDMA Band IV - With camera]****Channel: 1312**

H/V	Frequency [MHz]	S.A Reading [dBm]	Ant. Input [dBm]	Cable loss [dB]	Ant.Gain [dBi]	Result [dBm]	Limit [dBm]	Margin [dB]
H	3424.8	-54.6	-57.4	1.6	9.7	-49.2	-13.0	36.2

**Channel: 1413**

H/V	Frequency [MHz]	S.A Reading [dBm]	Ant. Input [dBm]	Cable loss [dB]	Ant.Gain [dBi]	Result [dBm]	Limit [dBm]	Margin [dB]
H	3465.2	-54.5	-56.1	1.6	9.8	-47.9	-13.0	34.9

**Channel: 1513**

H/V	Frequency [MHz]	S.A Reading [dBm]	Ant. Input [dBm]	Cable loss [dB]	Ant.Gain [dBi]	Result [dBm]	Limit [dBm]	Margin [dB]
H	3505.2	-54.3	-56.2	1.6	9.9	-47.9	-13.0	34.9

**[WCDMA Band IV - Without camera]****Channel: 1312**

H/V	Frequency [MHz]	S.A Reading [dBm]	Ant. Input [dBm]	Cable loss [dB]	Ant.Gain [dBi]	Result [dBm]	Limit [dBm]	Margin [dB]
H	3424.8	-54.7	-57.5	1.6	9.7	-49.3	-13.0	36.3

**Channel: 1413**

H/V	Frequency [MHz]	S.A Reading [dBm]	Ant. Input [dBm]	Cable loss [dB]	Ant.Gain [dBi]	Result [dBm]	Limit [dBm]	Margin [dB]
H	3465.2	-54.5	-56.1	1.6	9.8	-47.9	-13.0	34.9

**Channel: 1513**

H/V	Frequency [MHz]	S.A Reading [dBm]	Ant. Input [dBm]	Cable loss [dB]	Ant.Gain [dBi]	Result [dBm]	Limit [dBm]	Margin [dB]
H	3505.2	-54.5	-56.2	1.6	9.9	-47.9	-13.0	34.9

**[LTE Band IV - With camera]****QPSK, BW 1.4MHz****Channel: 19957**

H/V	Frequency [MHz]	S.A Reading [dBm]	Ant. Input [dBm]	Cable loss [dB]	Ant.Gain [dBi]	Result [dBm]	Limit [dBm]	Margin [dB]
H	3421.4	-54.5	-53.5	1.6	9.7	-45.3	-13.0	32.3

**Channel: 20175**

H/V	Frequency [MHz]	S.A Reading [dBm]	Ant. Input [dBm]	Cable loss [dB]	Ant.Gain [dBi]	Result [dBm]	Limit [dBm]	Margin [dB]
H	3465.0	-54.8	-54.8	1.6	9.8	-46.6	-13.0	33.6

**Channel: 20393**

H/V	Frequency [MHz]	S.A Reading [dBm]	Ant. Input [dBm]	Cable loss [dB]	Ant.Gain [dBi]	Result [dBm]	Limit [dBm]	Margin [dB]
H	3508.6	-54.6	-54.2	1.6	9.9	-45.9	-13.0	32.9

**16QAM, BW 1.4MHz****Channel: 19957**

H/V	Frequency [MHz]	S.A Reading [dBm]	Ant. Input [dBm]	Cable loss [dB]	Ant.Gain [dBi]	Result [dBm]	Limit [dBm]	Margin [dB]
H	3421.4	-54.8	-53.8	1.6	9.7	-45.6	-13.0	32.6

**Channel: 20175**

H/V	Frequency [MHz]	S.A Reading [dBm]	Ant. Input [dBm]	Cable loss [dB]	Ant.Gain [dBi]	Result [dBm]	Limit [dBm]	Margin [dB]
H	3465.0	-54.6	-54.6	1.6	9.8	-46.4	-13.0	33.4

**Channel: 20393**

H/V	Frequency [MHz]	S.A Reading [dBm]	Ant. Input [dBm]	Cable loss [dB]	Ant.Gain [dBi]	Result [dBm]	Limit [dBm]	Margin [dB]
H	3508.6	-54.8	-54.4	1.6	9.9	-46.1	-13.0	33.1

**QPSK, BW 3MHz****Channel: 19965**

H/V	Frequency [MHz]	S.A Reading [dBm]	Ant. Input [dBm]	Cable loss [dB]	Ant.Gain [dBi]	Result [dBm]	Limit [dBm]	Margin [dB]
H	3420.5	-54.9	-55.1	1.6	9.7	-46.9	-13.0	33.9

**Channel: 20175**

H/V	Frequency [MHz]	S.A Reading [dBm]	Ant. Input [dBm]	Cable loss [dB]	Ant.Gain [dBi]	Result [dBm]	Limit [dBm]	Margin [dB]
H	3462.5	-54.5	-54.5	1.6	9.8	-46.3	-13.0	33.3

**Channel: 20385**

H/V	Frequency [MHz]	S.A Reading [dBm]	Ant. Input [dBm]	Cable loss [dB]	Ant.Gain [dBi]	Result [dBm]	Limit [dBm]	Margin [dB]
H	3504.5	-54.5	-54.1	1.6	9.9	-45.8	-13.0	32.8

**16QAM, BW 3MHz****Channel: 19965**

H/V	Frequency [MHz]	S.A Reading [dBm]	Ant. Input [dBm]	Cable loss [dB]	Ant.Gain [dBi]	Result [dBm]	Limit [dBm]	Margin [dB]
H	3420.5	-55.0	-55.2	1.6	9.7	-47.0	-13.0	34.0

**Channel: 20175**

H/V	Frequency [MHz]	S.A Reading [dBm]	Ant. Input [dBm]	Cable loss [dB]	Ant.Gain [dBi]	Result [dBm]	Limit [dBm]	Margin [dB]
H	3462.5	-54.8	-54.8	1.6	9.8	-46.6	-13.0	33.6

**Channel: 20385**

H/V	Frequency [MHz]	S.A Reading [dBm]	Ant. Input [dBm]	Cable loss [dB]	Ant.Gain [dBi]	Result [dBm]	Limit [dBm]	Margin [dB]
H	3504.5	-54.8	-54.4	1.6	9.9	-46.1	-13.0	33.1

**QPSK, BW 5MHz****Channel: 19975**

H/V	Frequency [MHz]	S.A Reading [dBm]	Ant. Input [dBm]	Cable loss [dB]	Ant.Gain [dBi]	Result [dBm]	Limit [dBm]	Margin [dB]
H	3425.0	-54.8	-55.0	1.6	9.7	-46.8	-13.0	33.8

**Channel: 20175**

H/V	Frequency [MHz]	S.A Reading [dBm]	Ant. Input [dBm]	Cable loss [dB]	Ant.Gain [dBi]	Result [dBm]	Limit [dBm]	Margin [dB]
H	3465.0	-54.6	-54.6	1.6	9.8	-46.4	-13.0	33.4

**Channel: 20375**

H/V	Frequency [MHz]	S.A Reading [dBm]	Ant. Input [dBm]	Cable loss [dB]	Ant.Gain [dBi]	Result [dBm]	Limit [dBm]	Margin [dB]
H	3505.0	-54.5	-54.6	1.6	9.9	-46.3	-13.0	33.3

**16QAM, BW 5MHz****Channel: 19975**

H/V	Frequency [MHz]	S.A Reading [dBm]	Ant. Input [dBm]	Cable loss [dB]	Ant.Gain [dBi]	Result [dBm]	Limit [dBm]	Margin [dB]
H	3425.0	-55.0	-55.2	1.6	9.7	-47.0	-13.0	34.0

**Channel: 20175**

H/V	Frequency [MHz]	S.A Reading [dBm]	Ant. Input [dBm]	Cable loss [dB]	Ant.Gain [dBi]	Result [dBm]	Limit [dBm]	Margin [dB]
H	3465.0	-54.5	-54.5	1.6	9.8	-46.3	-13.0	33.3

**Channel: 20375**

H/V	Frequency [MHz]	S.A Reading [dBm]	Ant. Input [dBm]	Cable loss [dB]	Ant.Gain [dBi]	Result [dBm]	Limit [dBm]	Margin [dB]
H	3505.0	-54.9	-55.0	1.6	9.9	-46.7	-13.0	33.7

**QPSK, BW 10MHz****Channel: 20000**

H/V	Frequency [MHz]	S.A Reading [dBm]	Ant. Input [dBm]	Cable loss [dB]	Ant.Gain [dBi]	Result [dBm]	Limit [dBm]	Margin [dB]
H	3430.0	-54.5	-54.6	1.6	9.7	-46.4	-13.0	33.4

**Channel: 20175**

H/V	Frequency [MHz]	S.A Reading [dBm]	Ant. Input [dBm]	Cable loss [dB]	Ant.Gain [dBi]	Result [dBm]	Limit [dBm]	Margin [dB]
H	3465.0	-54.5	-54.5	1.6	9.8	-46.3	-13.0	33.3

**Channel: 20350**

H/V	Frequency [MHz]	S.A Reading [dBm]	Ant. Input [dBm]	Cable loss [dB]	Ant.Gain [dBi]	Result [dBm]	Limit [dBm]	Margin [dB]
H	3500.0	-54.8	-54.4	1.6	9.9	-46.1	-13.0	33.1

**16QAM, BW 10MHz****Channel: 20000**

H/V	Frequency [MHz]	S.A Reading [dBm]	Ant. Input [dBm]	Cable loss [dB]	Ant.Gain [dBi]	Result [dBm]	Limit [dBm]	Margin [dB]
H	3430.0	-54.8	-54.9	1.6	9.7	-46.7	-13.0	33.7

**Channel: 20175**

H/V	Frequency [MHz]	S.A Reading [dBm]	Ant. Input [dBm]	Cable loss [dB]	Ant.Gain [dBi]	Result [dBm]	Limit [dBm]	Margin [dB]
H	3465.0	-54.6	-54.6	1.6	9.8	-46.4	-13.0	33.4

**Channel: 20350**

H/V	Frequency [MHz]	S.A Reading [dBm]	Ant. Input [dBm]	Cable loss [dB]	Ant.Gain [dBi]	Result [dBm]	Limit [dBm]	Margin [dB]
H	3500.0	-54.6	-54.2	1.6	9.9	-45.9	-13.0	32.9

**QPSK, BW 15MHz****Channel: 20025**

H/V	Frequency [MHz]	S.A Reading [dBm]	Ant. Input [dBm]	Cable loss [dB]	Ant.Gain [dBi]	Result [dBm]	Limit [dBm]	Margin [dB]
H	3435.0	-54.7	-54.6	1.6	9.7	-46.4	-13.0	33.4

**Channel: 20175**

H/V	Frequency [MHz]	S.A Reading [dBm]	Ant. Input [dBm]	Cable loss [dB]	Ant.Gain [dBi]	Result [dBm]	Limit [dBm]	Margin [dB]
H	3465.0	-54.8	-54.8	1.6	9.8	-46.6	-13.0	33.6

**Channel: 20325**

H/V	Frequency [MHz]	S.A Reading [dBm]	Ant. Input [dBm]	Cable loss [dB]	Ant.Gain [dBi]	Result [dBm]	Limit [dBm]	Margin [dB]
H	3495.0	-54.6	-54.2	1.6	9.9	-45.9	-13.0	32.9

**16QAM, BW 15MHz****Channel: 20025**

H/V	Frequency [MHz]	S.A Reading [dBm]	Ant. Input [dBm]	Cable loss [dB]	Ant.Gain [dBi]	Result [dBm]	Limit [dBm]	Margin [dB]
H	3435.0	-54.7	-54.6	1.6	9.7	-46.4	-13.0	33.4

**Channel: 20175**

H/V	Frequency [MHz]	S.A Reading [dBm]	Ant. Input [dBm]	Cable loss [dB]	Ant.Gain [dBi]	Result [dBm]	Limit [dBm]	Margin [dB]
H	3465.0	-54.6	-54.6	1.6	9.8	-46.4	-13.0	33.4

**Channel: 20325**

H/V	Frequency [MHz]	S.A Reading [dBm]	Ant. Input [dBm]	Cable loss [dB]	Ant.Gain [dBi]	Result [dBm]	Limit [dBm]	Margin [dB]
H	3495.0	-54.8	-54.4	1.6	9.9	-46.1	-13.0	33.1

**QPSK, BW 20MHz****Channel: 20050**

H/V	Frequency [MHz]	S.A Reading [dBm]	Ant. Input [dBm]	Cable loss [dB]	Ant.Gain [dBi]	Result [dBm]	Limit [dBm]	Margin [dB]
H	3440.0	-54.6	-54.6	1.6	9.7	-46.4	-13.0	33.4

**Channel: 20175**

H/V	Frequency [MHz]	S.A Reading [dBm]	Ant. Input [dBm]	Cable loss [dB]	Ant.Gain [dBi]	Result [dBm]	Limit [dBm]	Margin [dB]
H	3465.0	-53.7	-53.7	1.6	9.8	-45.5	-13.0	32.5

**Channel: 20300**

H/V	Frequency [MHz]	S.A Reading [dBm]	Ant. Input [dBm]	Cable loss [dB]	Ant.Gain [dBi]	Result [dBm]	Limit [dBm]	Margin [dB]
H	3490.0	-54.3	-54.4	1.6	9.8	-46.1	-13.0	33.1

**16QAM, BW 20MHz****Channel: 20050**

H/V	Frequency [MHz]	S.A Reading [dBm]	Ant. Input [dBm]	Cable loss [dB]	Ant.Gain [dBi]	Result [dBm]	Limit [dBm]	Margin [dB]
H	3440.0	-54.6	-54.6	1.6	11.9	-44.2	-13.0	31.2

**Channel: 20175**

H/V	Frequency [MHz]	S.A Reading [dBm]	Ant. Input [dBm]	Cable loss [dB]	Ant.Gain [dBi]	Result [dBm]	Limit [dBm]	Margin [dB]
H	3465.0	-54.0	-54.0	1.6	12.0	-43.6	-13.0	30.6

**Channel: 20300**

H/V	Frequency [MHz]	S.A Reading [dBm]	Ant. Input [dBm]	Cable loss [dB]	Ant.Gain [dBi]	Result [dBm]	Limit [dBm]	Margin [dB]
H	3490.0	-54.4	-54.5	1.6	12.0	-44.0	-13.0	31.0

**[LTE Band IV - Without camera]****QPSK, BW 1.4MHz****Channel: 19957**

H/V	Frequency [MHz]	S.A Reading [dBm]	Ant. Input [dBm]	Cable loss [dB]	Ant.Gain [dBi]	Result [dBm]	Limit [dBm]	Margin [dB]
H	3421.4	-54.0	-54.1	1.6	9.7	-45.9	-13.0	32.9

**Channel: 20175**

H/V	Frequency [MHz]	S.A Reading [dBm]	Ant. Input [dBm]	Cable loss [dB]	Ant.Gain [dBi]	Result [dBm]	Limit [dBm]	Margin [dB]
H	3465.0	-53.0	-53.0	1.6	9.8	-44.8	-13.0	31.8

**Channel: 20393**

H/V	Frequency [MHz]	S.A Reading [dBm]	Ant. Input [dBm]	Cable loss [dB]	Ant.Gain [dBi]	Result [dBm]	Limit [dBm]	Margin [dB]
H	3508.6	-54.4	-54.0	1.6	9.9	-45.7	-13.0	32.7

**16QAM, BW 1.4MHz****Channel: 19957**

H/V	Frequency [MHz]	S.A Reading [dBm]	Ant. Input [dBm]	Cable loss [dB]	Ant.Gain [dBi]	Result [dBm]	Limit [dBm]	Margin [dB]
H	3421.4	-54.2	-54.3	1.6	9.7	-46.1	-13.0	33.1

**Channel: 20175**

H/V	Frequency [MHz]	S.A Reading [dBm]	Ant. Input [dBm]	Cable loss [dB]	Ant.Gain [dBi]	Result [dBm]	Limit [dBm]	Margin [dB]
H	3465.0	-53.4	-53.4	1.6	9.8	-45.2	-13.0	32.2

**Channel: 20393**

H/V	Frequency [MHz]	S.A Reading [dBm]	Ant. Input [dBm]	Cable loss [dB]	Ant.Gain [dBi]	Result [dBm]	Limit [dBm]	Margin [dB]
H	3508.6	-54.4	-54.0	1.6	9.9	-45.7	-13.0	32.7

**QPSK, BW 3MHz****Channel: 19965**

H/V	Frequency [MHz]	S.A Reading [dBm]	Ant. Input [dBm]	Cable loss [dB]	Ant.Gain [dBi]	Result [dBm]	Limit [dBm]	Margin [dB]
H	3423.0	-53.7	-53.8	1.6	9.7	-45.6	-13.0	32.6

**Channel: 20175**

H/V	Frequency [MHz]	S.A Reading [dBm]	Ant. Input [dBm]	Cable loss [dB]	Ant.Gain [dBi]	Result [dBm]	Limit [dBm]	Margin [dB]
H	3465.0	-52.7	-52.7	1.6	9.8	-44.5	-13.0	31.5

**Channel: 20385**

H/V	Frequency [MHz]	S.A Reading [dBm]	Ant. Input [dBm]	Cable loss [dB]	Ant.Gain [dBi]	Result [dBm]	Limit [dBm]	Margin [dB]
H	3507.0	-54.1	-53.9	1.6	9.9	-45.6	-13.0	32.6

**16QAM, BW 3MHz****Channel: 19965**

H/V	Frequency [MHz]	S.A Reading [dBm]	Ant. Input [dBm]	Cable loss [dB]	Ant. Gain [dBi]	Result [dBm]	Limit [dBm]	Margin [dB]
H	3423.0	-54.8	-54.9	1.6	9.7	-46.7	-13.0	33.7

**Channel: 20175**

H/V	Frequency [MHz]	S.A Reading [dBm]	Ant. Input [dBm]	Cable loss [dB]	Ant. Gain [dBi]	Result [dBm]	Limit [dBm]	Margin [dB]
H	3465.0	-52.8	-52.8	1.6	9.8	-44.6	-13.0	31.6

**Channel: 20385**

H/V	Frequency [MHz]	S.A Reading [dBm]	Ant. Input [dBm]	Cable loss [dB]	Ant. Gain [dBi]	Result [dBm]	Limit [dBm]	Margin [dB]
H	3507.0	-54.4	-54.2	1.6	9.9	-45.9	-13.0	32.9

**QPSK, BW 5MHz****Channel: 19975**

H/V	Frequency [MHz]	S.A Reading [dBm]	Ant. Input [dBm]	Cable loss [dB]	Ant. Gain [dBi]	Result [dBm]	Limit [dBm]	Margin [dB]
H	3425.0	-53.6	-53.8	1.6	9.7	-45.6	-13.0	32.6

**Channel: 20175**

H/V	Frequency [MHz]	S.A Reading [dBm]	Ant. Input [dBm]	Cable loss [dB]	Ant. Gain [dBi]	Result [dBm]	Limit [dBm]	Margin [dB]
H	3465.0	-52.7	-52.7	1.6	9.8	-44.5	-13.0	31.5

**Channel: 20375**

H/V	Frequency [MHz]	S.A Reading [dBm]	Ant. Input [dBm]	Cable loss [dB]	Ant. Gain [dBi]	Result [dBm]	Limit [dBm]	Margin [dB]
H	3505.0	-54.0	-54.1	1.6	9.9	-45.8	-13.0	32.8

**16QAM, BW 5MHz****Channel: 19975**

H/V	Frequency [MHz]	S.A Reading [dBm]	Ant. Input [dBm]	Cable loss [dB]	Ant. Gain [dBi]	Result [dBm]	Limit [dBm]	Margin [dB]
H	3425.0	-53.6	-53.8	1.6	9.7	-45.6	-13.0	32.6

**Channel: 20175**

H/V	Frequency [MHz]	S.A Reading [dBm]	Ant. Input [dBm]	Cable loss [dB]	Ant. Gain [dBi]	Result [dBm]	Limit [dBm]	Margin [dB]
H	3465.0	-53.3	-53.3	1.6	9.8	-45.1	-13.0	32.1

**Channel: 20375**

H/V	Frequency [MHz]	S.A Reading [dBm]	Ant. Input [dBm]	Cable loss [dB]	Ant. Gain [dBi]	Result [dBm]	Limit [dBm]	Margin [dB]
H	3505.0	-54.1	-54.2	1.6	9.9	-45.9	-13.0	32.9

**QPSK, BW 10MHz****Channel: 20000**

H/V	Frequency [MHz]	S.A Reading [dBm]	Ant. Input [dBm]	Cable loss [dB]	Ant.Gain [dBi]	Result [dBm]	Limit [dBm]	Margin [dB]
H	3430.0	-53.8	-53.9	1.6	9.7	-45.7	-13.0	32.7

**Channel: 20175**

H/V	Frequency [MHz]	S.A Reading [dBm]	Ant. Input [dBm]	Cable loss [dB]	Ant.Gain [dBi]	Result [dBm]	Limit [dBm]	Margin [dB]
H	3465.0	-52.8	-52.8	1.6	9.8	-44.6	-13.0	31.6

**Channel: 20350**

H/V	Frequency [MHz]	S.A Reading [dBm]	Ant. Input [dBm]	Cable loss [dB]	Ant.Gain [dBi]	Result [dBm]	Limit [dBm]	Margin [dB]
H	3500.0	-54.1	-53.7	1.6	9.9	-45.4	-13.0	32.4

**16QAM, BW 10MHz****Channel: 20000**

H/V	Frequency [MHz]	S.A Reading [dBm]	Ant. Input [dBm]	Cable loss [dB]	Ant.Gain [dBi]	Result [dBm]	Limit [dBm]	Margin [dB]
H	3430.0	-53.8	-53.9	1.6	9.7	-45.7	-13.0	32.7

**Channel: 20175**

H/V	Frequency [MHz]	S.A Reading [dBm]	Ant. Input [dBm]	Cable loss [dB]	Ant.Gain [dBi]	Result [dBm]	Limit [dBm]	Margin [dB]
H	3465.0	-52.8	-52.8	1.6	9.8	-44.6	-13.0	31.6

**Channel: 20350**

H/V	Frequency [MHz]	S.A Reading [dBm]	Ant. Input [dBm]	Cable loss [dB]	Ant.Gain [dBi]	Result [dBm]	Limit [dBm]	Margin [dB]
H	3500.0	-54.2	-53.8	1.6	9.9	-45.5	-13.0	32.5

**QPSK, BW 15MHz****Channel: 20025**

H/V	Frequency [MHz]	S.A Reading [dBm]	Ant. Input [dBm]	Cable loss [dB]	Ant.Gain [dBi]	Result [dBm]	Limit [dBm]	Margin [dB]
H	3435.0	-53.4	-53.3	1.6	9.7	-45.1	-13.0	32.1

**Channel: 20175**

H/V	Frequency [MHz]	S.A Reading [dBm]	Ant. Input [dBm]	Cable loss [dB]	Ant.Gain [dBi]	Result [dBm]	Limit [dBm]	Margin [dB]
H	3465.0	-53.0	-53.0	1.6	9.8	-44.8	-13.0	31.8

**Channel: 20325**

H/V	Frequency [MHz]	S.A Reading [dBm]	Ant. Input [dBm]	Cable loss [dB]	Ant.Gain [dBi]	Result [dBm]	Limit [dBm]	Margin [dB]
H	3495.0	-53.6	-53.2	1.6	9.9	-44.9	-13.0	31.9



**16QAM, BW 15MHz****Channel: 20025**

H/V	Frequency [MHz]	S.A Reading [dBm]	Ant. Input [dBm]	Cable loss [dB]	Ant. Gain [dBi]	Result [dBm]	Limit [dBm]	Margin [dB]
H	3435.0	-53.6	-53.5	1.6	9.7	-45.3	-13.0	32.3

**Channel: 20175**

H/V	Frequency [MHz]	S.A Reading [dBm]	Ant. Input [dBm]	Cable loss [dB]	Ant. Gain [dBi]	Result [dBm]	Limit [dBm]	Margin [dB]
H	3465.0	-53.3	-53.3	1.6	9.8	-45.1	-13.0	32.1

**Channel: 20325**

H/V	Frequency [MHz]	S.A Reading [dBm]	Ant. Input [dBm]	Cable loss [dB]	Ant. Gain [dBi]	Result [dBm]	Limit [dBm]	Margin [dB]
H	3495.0	-53.7	-53.3	1.6	9.9	-45.0	-13.0	32.0

**QPSK, BW 20MHz****Channel: 20050**

H/V	Frequency [MHz]	S.A Reading [dBm]	Ant. Input [dBm]	Cable loss [dB]	Ant. Gain [dBi]	Result [dBm]	Limit [dBm]	Margin [dB]
H	3440.0	-53.3	-53.3	1.6	9.7	-45.1	-13.0	32.1

**Channel: 20175**

H/V	Frequency [MHz]	S.A Reading [dBm]	Ant. Input [dBm]	Cable loss [dB]	Ant. Gain [dBi]	Result [dBm]	Limit [dBm]	Margin [dB]
H	3465.0	-52.7	-52.7	1.6	9.8	-44.5	-13.0	31.5

**Channel: 20300**

H/V	Frequency [MHz]	S.A Reading [dBm]	Ant. Input [dBm]	Cable loss [dB]	Ant. Gain [dBi]	Result [dBm]	Limit [dBm]	Margin [dB]
H	3490.0	-53.9	-54.0	1.6	9.8	-45.7	-13.0	32.7

**16QAM, BW 20MHz****Channel: 20050**

H/V	Frequency [MHz]	S.A Reading [dBm]	Ant. Input [dBm]	Cable loss [dB]	Ant. Gain [dBi]	Result [dBm]	Limit [dBm]	Margin [dB]
H	3440.0	-53.4	-53.4	1.6	11.9	-43.0	-13.0	30.0

**Channel: 20175**

H/V	Frequency [MHz]	S.A Reading [dBm]	Ant. Input [dBm]	Cable loss [dB]	Ant. Gain [dBi]	Result [dBm]	Limit [dBm]	Margin [dB]
H	3465.0	-53.0	-53.0	1.6	12.0	-42.6	-13.0	29.6

**Channel: 20300**

H/V	Frequency [MHz]	S.A Reading [dBm]	Ant. Input [dBm]	Cable loss [dB]	Ant. Gain [dBi]	Result [dBm]	Limit [dBm]	Margin [dB]
H	3490.0	-53.9	-54.0	1.6	12.0	-43.5	-13.0	30.5

## 4.6 Frequency Stability

### 4.6.1 Measurement procedure

#### [FCC 27.54, 2.1055]

The EUT was placed of an inside of an constant temperature chamber as the temperature in the chamber was varied between -30°C and +50°C. The temperature was incremented by 10°C intervals and the unit was allowed to stabilize at each measurement. The frequency drift was measured with the normal Temperature and voltage tolerance and it is presented as the ppm unit.

- Test configuration

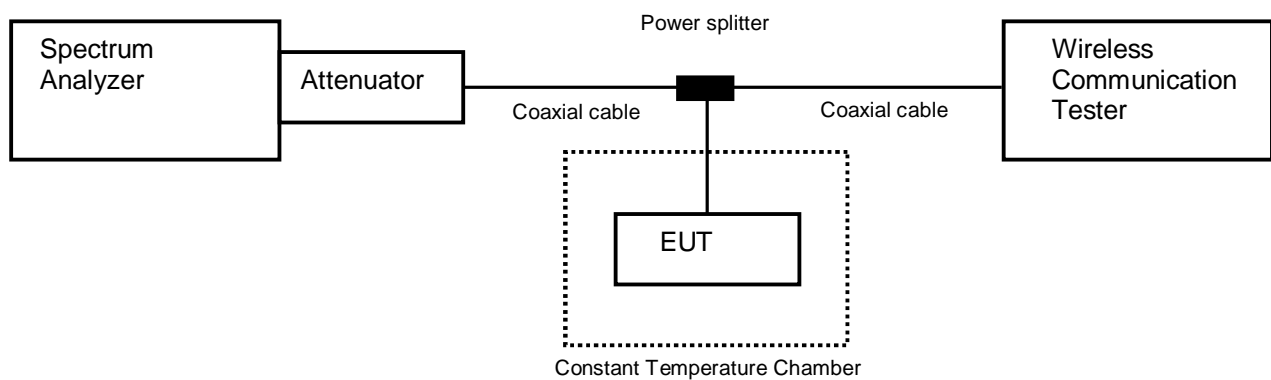

### 4.6.2 Limit

±2.5 ppm

### 4.6.3 Measurement result

Date : 8-October-2019  
 Temperature : 21.7 [°C]  
 Humidity : 52.6 [%]  
 Test place : Shielded room No.4

Test engineer : Chiaki Kanno

**[WCDMA Band IV]  
Channel: 1413**

Limit: $\pm 0.00025\% = \pm 2.5\text{ppm}$					
Power Supply	Temperature	Measurements Frequency	Frequency Tolerance	Limit	Result
[V]	[°C]	[Hz]	[ppm]	[ppm]	
3.80	25(Ref.)	1,732,599,993	0.00000	$\pm 2.5$	Pass
	50	1,732,599,996	0.00148	$\pm 2.5$	Pass
	40	1,732,599,996	0.00149	$\pm 2.5$	Pass
	30	1,732,599,994	0.00031	$\pm 2.5$	Pass
	20	1,732,599,993	-0.00005	$\pm 2.5$	Pass
	10	1,732,600,004	0.00601	$\pm 2.5$	Pass
	0	1,732,600,002	0.00489	$\pm 2.5$	Pass
	-10	1,732,600,004	0.00616	$\pm 2.5$	Pass
	-20	1,732,599,995	0.00085	$\pm 2.5$	Pass
	-30	1,732,600,003	0.00540	$\pm 2.5$	Pass
3.42	25	1,732,600,004	0.00589	$\pm 2.5$	Pass
4.18	25	1,732,600,004	0.00597	$\pm 2.5$	Pass

**[LTE Band IV]  
QPSK, BW 20MHz  
Channel: 20175**

Limit: $\pm 0.00025\% = \pm 2.5\text{ppm}$					
Power Supply	Temperature	Measurements Frequency	Frequency Tolerance	Limit	Result
[V]	[°C]	[Hz]	[ppm]	[ppm]	
3.80	25(Ref.)	1,732,499,995	0.00000	$\pm 2.5$	Pass
	50	1,732,499,990	-0.00304	$\pm 2.5$	Pass
	40	1,732,499,992	-0.00193	$\pm 2.5$	Pass
	30	1,732,499,991	-0.00204	$\pm 2.5$	Pass
	20	1,732,499,994	-0.00051	$\pm 2.5$	Pass
	10	1,732,499,995	-0.00007	$\pm 2.5$	Pass
	0	1,732,499,991	-0.00244	$\pm 2.5$	Pass
	-10	1,732,499,995	0.00036	$\pm 2.5$	Pass
	-20	1,732,499,996	0.00063	$\pm 2.5$	Pass
	-30	1,732,499,997	0.00120	$\pm 2.5$	Pass
3.42	25	1,732,499,996	0.00089	$\pm 2.5$	Pass
4.18	25	1,732,499,997	0.00111	$\pm 2.5$	Pass

Calculation;

Frequency Tolerance (ppm) = Measurements Frequency (Hz) – Reference Frequency (Hz) / Reference Frequency (Hz) x 1000000

## 5 Measurement Uncertainty

Expanded uncertainties stated are calculated with a coverage Factor  $k=2$ .  
 Please note that these results are not taken into account when measurement uncertainty considerations contained in ETSI TR 100 028 Parts 1 and 2 determining compliance or non-compliance with test result.

Test item	Measurement uncertainty
Conducted emission, AMN (9 kHz – 150 kHz)	±3.8 dB
Conducted emission, AMN (150 kHz – 30 MHz)	±3.3 dB
Radiated emission (9kHz – 30 MHz)	±3.1 dB
Radiated emission (30 MHz – 1000 MHz)	±4.9 dB
Radiated emission (1 GHz – 6 GHz)	±4.8 dB
Radiated emission (6 GHz – 18 GHz)	±5.1 dB
Radiated emission (18 GHz – 40 GHz)	±5.8 dB
Radio Frequency	±1.4 * 10 <sup>-8</sup>
RF power, conducted	±0.6 dB
Temperature	±0.6 °C
Humidity	±1.2 %
Voltage (DC)	±0.4 %
Voltage (AC, <10kHz)	±0.2 %

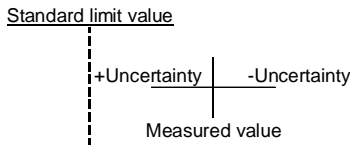
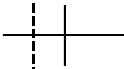
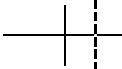
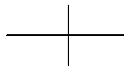
Judge	Measured value and standard limit value	
PASS	<b>Case1</b> 	Even if it takes uncertainty into consideration, a standard limit value is fulfilled.
	<b>Case2</b> 	Although measured value is in a standard limit value, a limit value won't be fulfilled if uncertainty is taken into consideration.
FAIL	<b>Case3</b> 	Although measured value exceeds a standard limit value, a limit value will be fulfilled if uncertainty is taken into consideration.
	<b>Case4</b> 	Even if it takes uncertainty into consideration, a standard limit value isn't fulfilled.

## 6 Laboratory Information

Testing was performed and the report was issued at:

### TÜV SÜD Japan Ltd. Yonezawa Testing Center

Address: 5-4149-7 Hachimanpara, Yonezawa-shi, Yamagata, 992-1128 Japan  
 Phone: +81-238-28-2881  
 Fax: +81-238-28-2888

### Accreditation and Registration

NVLAP  
 LAB CODE: 200306-0

VLAC  
 Accreditation No.: VLAC-013

BSMI  
 Laboratory Code: SL2-IN-E-6018, SL2-A1-E-6018

Innovation, Science and Economic Development Canada

Site number	Facility	Expiration date
4224A-4	3 m Semi-anechoic chamber	27-November-2020
4224A-5	10 m Semi-anechoic chamber No. 1	27-November-2020
4224A-6	10 m Semi-anechoic chamber No. 2	14-December-2019

VCCI Council

Registration number	Expiration date
A-0166	03-July-2021

## Appendix A. Test Equipment

### Antenna port conducted test

Equipment	Company	Model No.	Serial No.	Cal. Due	Cal. Date
Spectrum analyzer	Agilent Technologies	E4440A	US44302655	31-Aug-2020	05-Aug-2019
Attenuator	Weinschel	56-10	J4180	31-Jul-2020	18-Jul-2019
Microwave cable	HUBER+SUHNER	SUCOFLEX 104/1m	199120/4	31-Dec-2019	18-Dec-2018
Microwave cable	HUBER+SUHNER	SUCOFELX102/2m	MY3385/2	31-Mar-2020	08-Mar-2019
Power divider	ANRITSU	K240B	020205	31-Jul-2020	19-Jul-2019
Wideband Radio Frequency Tester	ROHDE&SCHWARZ	CMW500	126079	31-Oct-2019	12-Oct-2018
Wideband Radio Frequency Tester	ROHDE&SCHWARZ	CMW500	116338	31-Aug-2019	13-Aug-2018
				31-Aug-2020	27-Aug-2019
Temperature and humidity chamber	ESPEC	PL1KP	14007261	31-Dec-2019	07-Dec-2018
				30-Sep-2020	03-Sep-2019

### Radiated emission

Equipment	Company	Model No.	Serial No.	Cal. Due	Cal. Date
EMI Receiver	ROHDE&SCHWARZ	ESCI	100765	30-Sep-2019	20-Sep-2018
				30-Sep-2020	26-Sep-2019
Spectrum analyzer	Agilent Technologies	E4447A	MY46180188	30-Apr-2020	16-Apr-2019
Spectrum analyzer	Agilent Technologies	E4440A	US40420937	31-Oct-2019	12-Oct-2018
Preamplifier	SONOMA	310	372170	30-Sep-2019	20-Sep-2018
				30-Sep-2020	26-Sep-2019
Biconical antenna	Schwarzbeck	VHA9103/BBA9106	VHA91031308	31-May-2020	16-May-2019
Log periodic antenna	Schwarzbeck	UHALP9108A	0728	31-May-2020	16-May-2019
Attenuator	TAMAGAWA.ELEC	CFA-01/6dB	N/A(S465)	31-May-2020	17-May-2019
Attenuator	TAMAGAWA.ELEC	CFA-10/3dB	N/A(S503)	31-Jul-2020	17-Jul-2019
Preamplifier	TSJ	MLA-100M18-B02-40	1929118	31-Jan-2020	17-Jan-2019
Attenuator	AEROFLEX	26A-10	081217-08	31-Jan-2020	17-Jan-2019
Double ridged guide antenna	ETS LINDGREN	3117	00224193	31-Jan-2020	23-Jan-2019
Attenuator	Agilent Technologies	8491B	MY39268633	31-Mar-2020	08-Mar-2019
Double ridged guide antenna	A.H.Systems Inc.	SAS-574	469	31-Aug-2019	24-Aug-2018
				31-Aug-2020	28-Aug-2019
Preamplifier	TSJ	MLA-1840-B03-35	1240332	31-Aug-2019	24-Aug-2018
				31-Aug-2020	28-Aug-2019
Band rejection filter	Micro-Tronics	BRC50719	014	31-Dec-2019	20-Dec-2018
High Pass Filter	Wainwright	WHKX2.8/18G-6SS	1	31-Jul-2020	18-Jul-2019
Signal generator	ROHDE&SCHWARZ	SMB100A	177525	31-Jul-2020	18-Jul-2019
RF power amplifier	R&K	CGA020M602-2633R	B40240	31-May-2020	16-May-2019
Microwave cable	HUBER+SUHNER	SUCOFELX102/2m	31648	31-Mar-2020	08-Mar-2019
Dipole antenna	Schwarzbeck	VHAP	1020	31-Aug-2019	03-Aug-2018
Dipole antenna	Schwarzbeck	VHAP	1021	31-Aug-2020	15-Aug-2019
Dipole antenna	Schwarzbeck	UHAP	994	31-Aug-2019	03-Aug-2018
Dipole antenna	Schwarzbeck	UHAP	993	31-Aug-2020	15-Aug-2019
Double ridged guide antenna	EMCO	3115	00058532	29-Feb-2020	12-Feb-2019
Double ridged guide antenna	ETS LINDGREN	3117	00218815	31-Dec-2019	27-Dec-2018
Wideband Radio Frequency Tester	ROHDE&SCHWARZ	CMW500	126079	31-Oct-2019	12-Oct-2018
Wideband Radio Frequency Tester	ROHDE&SCHWARZ	CMW500	116338	31-Aug-2019	13-Aug-2018
				31-Aug-2020	27-Aug-2019

Microwave cable	HUBER+SUHNER	SUCOFLEX104/9m	MY30037/4	31-Jan-2020	16-Jan-2019
		SUCOFLEX104/1m	my24610/4	31-Jan-2020	16-Jan-2019
		SUCOFLEX104/8m	SN MY30031/4	31-Jan-2020	16-Jan-2019
		SUCOFLEX104	MY32976/4	31-Jan-2020	16-Jan-2019
		SUCOFLEX104/1.5m	MY19309/4	31-Jan-2020	16-Jan-2019
		SUCOFLEX104/7m	41625/6	31-Jan-2020	16-Jan-2019
PC	DELL	DIMENSION E521	75465BX	N/A	N/A
Software	TOYO Corporation	EP5/RE-AJ	0611193/V5.6.0	N/A	N/A
Absorber	RIKEN	PPF30	N/A	N/A	N/A
3m Semi an-echoic Chamber	TOKIN	N/A	N/A(9002-NSA)	31-May-2020	14-May-2019
3m Semi an-echoic Chamber	TOKIN	N/A	N/A(9002-SVSWR)	31-May-2020	13-May-2019

\*: The calibrations of the above equipment are traceable to NIST or equivalent standards of the reference organizations.