

FCC Test Report (Part 24)

Report No.: RF180129C24-1

FCC ID: JOYDA39

Test Model: AL-T52V1

Received Date: Jan. 29, 2018

Test Date: Jan. 31 ~ Feb. 07, 2018

Issued Date: Feb. 27, 2018

Applicant: Kyocera Corporation

Address: 2-1-1 Kagahara, Tsuzuki-ku Yokohama-city Kanagawa 224-8502 Japan

Issued By: Bureau Veritas Consumer Products Services (H.K.) Ltd., Taoyuan Branch

Lab Address: No. 47-2, 14th Ling, Chia Pau Vil., Lin Kou Dist., New Taipei City, Taiwan (R.O.C.)

Test Location: No. 19, Hwa Ya 2nd Rd., Wen Hwa Vil., Kwei Shan Dist., Taoyuan City 33383, TAIWAN (R.O.C.)



This report is for your exclusive use. Any copying or replication of this report to or for any other person or entity, or use of our name or trademark, is permitted only with our prior written permission. This report sets forth our findings solely with respect to the test samples identified herein. The results set forth in this report are not indicative or representative of the quality or characteristics of the lot from which a test sample was taken or any similar or identical product unless specifically and expressly noted. Our report includes all of the tests requested by you and the results thereof based upon the information that you provided to us. You have 60 days from date of issuance of this report to notify us of any material error or omission caused by our negligence, provided, however, that such notice shall be in writing and shall specifically address the issue you wish to raise. A failure to raise such issue within the prescribed time shall constitute your unqualified acceptance of the completeness of this report, the tests conducted and the correctness of the report contents. Unless specific mention, the uncertainty of measurement has been explicitly taken into account to declare the compliance or non-compliance to the specification. The report must not be used by the client to claim product certification, approval, or endorsement by TAF or any government agencies

Table of Contents

Release Control Record	4
1 Certificate of Conformity	5
2 Summary of Test Results	6
2.1 Measurement Uncertainty.....	6
2.2 Test Site and Instruments.....	7
3 General Information	8
3.1 General Description of EUT.....	8
3.2 Configuration of System under Test.....	9
3.2.1 Description of Support Units.....	10
3.3 Test Mode Applicability and Tested Channel Detail.....	11
3.4 EUT Operating Conditions.....	14
3.5 General Description of Applied Standards.....	14
4 Test Types and Results	15
4.1 Output Power Measurement.....	15
4.1.1 Limits of Output Power Measurement.....	15
4.1.2 Test Procedures.....	15
4.1.3 Test Setup.....	16
4.1.4 Test Results.....	17
4.2 Modulation Characteristics Measurement.....	27
4.2.1 Limits of Modulation Characteristics.....	27
4.2.2 Test Procedure.....	27
4.2.3 Test Setup.....	27
4.2.4 Test Results.....	28
4.3 Frequency Stability Measurement.....	30
4.3.1 Limits of Frequency Stability Measurement.....	30
4.3.2 Test Procedure.....	30
4.3.3 Test Setup.....	30
4.3.4 Test Results.....	31
4.4 Occupied Bandwidth Measurement.....	32
4.4.1 Test Procedure.....	32
4.4.2 Test Setup.....	32
4.4.3 Test Result.....	33
4.5 Band Edge Measurement.....	39
4.5.1 Limits of Band Edge Measurement.....	39
4.5.2 Test Setup.....	39
4.5.3 Test Procedures.....	39
4.5.4 Test Results.....	40
4.6 Peak to Average Ratio.....	47
4.6.1 Limits of Peak to Average Ratio Measurement.....	47
4.6.2 Test Setup.....	47
4.6.3 Test Procedures.....	47
4.6.4 Test Results.....	48
4.7 Conducted Spurious Emissions.....	51
4.7.1 Limits of Conducted Spurious Emissions Measurement.....	51
4.7.2 Test Setup.....	51
4.7.3 Test Procedure.....	51
4.7.4 Test Results.....	52
4.8 Radiated Emission Measurement.....	79
4.8.1 Limits of Radiated Emission Measurement.....	79
4.8.2 Test Procedure.....	79
4.8.3 Deviation from Test Standard.....	79
4.8.4 Test Setup.....	80
4.8.5 Test Results.....	81

5	Pictures of Test Arrangements.....	102
	Appendix – Information on the Testing Laboratories	103

Release Control Record

Issue No.	Description	Date Issued
RF180129C24-1	Original release	Feb. 27, 2018

1 Certificate of Conformity

Product: Telematics Module

Brand: Kyocera

Test Model: AL-T52V1

Sample Status: Engineering sample

Applicant: Kyocera Corporation

Test Date: Jan. 31 ~ Feb. 07, 2018

Standards: FCC Part 24, Subpart E

The above equipment has been tested by **Bureau Veritas Consumer Products Services (H.K.) Ltd., Taoyuan Branch**, and found compliance with the requirement of the above standards. The test record, data evaluation & Equipment Under Test (EUT) configurations represented herein are true and accurate accounts of the measurements of the sample's RF characteristics under the conditions specified in this report.

Prepared by :



, Date:

Feb. 27, 2018

Suntee Liu / Specialist

Approved by :



, Date:

Feb. 27, 2018

Bruce Chen / Project Engineer

2 Summary of Test Results

Applied Standard: FCC Part 24 & Part 2			
FCC Clause	Test Item	Result	Remarks
2.1046 24.232	Effective radiated power	Pass	Meet the requirement of limit.
2.1046 24.232(d)	Peak To Average Ratio	Pass	Meet the requirement of limit.
2.1047	Modulation Characteristics	Pass	Meet the requirement
2.1055 24.235	Frequency Stability	Pass	Meet the requirement of limit.
2.1049 24.238(b)	Occupied Bandwidth	Pass	Meet the requirement of limit.
24.238(b)	Band Edge Measurements	Pass	Meet the requirement of limit.
2.1051 24.238	Conducted Spurious Emissions	Pass	Meet the requirement of limit.
2.1053 24.238	Radiated Spurious Emissions	Pass	Meet the requirement of limit. Minimum passing margin is -26.2dB at 30.97MHz.

2.1 Measurement Uncertainty

Where relevant, the following measurement uncertainty levels have been estimated for tests performed on the EUT as specified in CISPR 16-4-2:

Measurement	Frequency	Expanded Uncertainty (k=2) (\pm)
Radiated Emissions up to 1 GHz	30MHz ~ 200MHz	3.59 dB
	200MHz ~1000MHz	3.60 dB
Radiated Emissions above 1 GHz	1GHz ~ 18GHz	2.29 dB
	18GHz ~ 40GHz	2.29 dB

2.2 Test Site and Instruments

Description & Manufacturer	Model No.	Serial No.	Cal. Date	Cal. Due
Test Receiver KEYSIGHT	N9038A	MY55420137	Mar. 27, 2017	Mar. 26, 2018
Spectrum Analyzer ROHDE & SCHWARZ	FSP40	100269	May 11, 2017	May 10, 2018
BILOG Antenna SCHWARZBECK	VULB9168	9168-148	Dec. 11, 2017	Dec. 10, 2018
HORN Antenna SCHWARZBECK	BBHA 9120 D	9120D-1169	Dec. 12, 2017	Dec. 11, 2018
HORN Antenna SCHWARZBECK	BBHA 9170	BBHA9170241	Dec. 01, 2017	Nov. 30, 2018
Loop Antenna EMCI	EM-6879	269	Aug. 11, 2017	Aug. 10, 2018
Preamplifier Agilent (Below 1GHz)	8447D	2944A10638	Aug. 08, 2017	Aug. 07, 2018
Preamplifier Agilent (Above 1GHz)	8449B	3008A01638	Feb. 22, 2017	Feb. 21, 2018
RF signal cable HUBER+SUHNER&EMCI	SUCOFLEX 104 & EMC104-SM-SM8000	CABLE-CH9-02 (248780+171006)	Jan. 15, 2018	Jan. 14, 2019
RF signal cable HUBER+SUHNER	SUCOFLEX 104	CABLE-CH9-(250795/4)	Aug. 08, 2017	Aug. 07, 2018
RF signal cable Woken	8D-FB	Cable-CH9-01	Aug. 01, 2017	Jul. 31, 2018
Software BV ADT	ADT_Radiated_ V7.6.15.9.4	NA	NA	NA
Antenna Tower EMCO	2070/2080	512.835.4684	NA	NA
Turn Table EMCO	2087-2.03	NA	NA	NA
Antenna Tower & Turn BV ADT	AT100	AT93021705	NA	NA
Turn Table BV ADT	TT100	TT93021705	NA	NA
Turn Table Controller BV ADT	SC100	SC93021705	NA	NA
WIT Standard Temperature And Humidity Chamber	TH-4S-C	W981030	Jun. 07, 2017	Jun. 06, 2018
JFW 20dB attenuation	50HF-020-SMA	NA	NA	NA

- Note:
1. The calibration interval of the above test instruments is 12 months and the calibrations are traceable to NML/ROC and NIST/USA.
 2. The test was performed in HwaYa Chamber 9.
 3. The FCC Designation Number is TW0003. The number will be varied with the Lab location and scope as attached.
 4. The IC Site Registration No. is IC 7450F-9.

3 General Information

3.1 General Description of EUT

Product	Telematics Module	
Brand	Kyocera	
Test Model	AL-T52V1	
Sample Status	Engineering sample	
Power Supply Rating	5Vdc	
Modulation Type	WCDMA: BPSK, QPSK HSDPA: BPSK HSUPA: QPSK LTE: QPSK, 16QAM	
Operating Frequency	WCDMA Band 2	1852.4~1907.6MHz
	LTE Band 2 (Channel Bandwidth 1.4MHz)	1850.7~1909.3MHz
	LTE Band 2 (Channel Bandwidth 3MHz)	1851.5~1908.5MHz
	LTE Band 2 (Channel Bandwidth 5MHz)	1852.5~1907.5MHz
	LTE Band 2 (Channel Bandwidth 10MHz)	1855.0~1905.0MHz
	LTE Band 2 (Channel Bandwidth 15MHz)	1857.5~1902.5MHz
	LTE Band 2 (Channel Bandwidth 20MHz)	1860.0~1900.0MHz
Max. EIRP Power	WCDMA Band 2	190.546mW (22.8dBm)
	LTE Band 2 (Channel Bandwidth 1.4MHz)	758.578mW (28.8dBm)
	LTE Band 2 (Channel Bandwidth 3MHz)	588.844mW (27.7dBm)
	LTE Band 2 (Channel Bandwidth 5MHz)	524.807mW (27.2dBm)
	LTE Band 2 (Channel Bandwidth 10MHz)	630.957mW (28.0dBm)
	LTE Band 2 (Channel Bandwidth 15MHz)	537.032mW (27.3dBm)
	LTE Band 2 (Channel Bandwidth 20MHz)	501.187mW (27.0dBm)
Antenna Type	Refer to Note	
Antenna Connector	Refer to Note	
Accessory Device	Refer to Note	
Cable Supplied	0.08m module cable	

Note:

1. The EUT uses following antennas (support units).

Antenna 1					
Antenna Type	AUX		Connector Type		SMA
Manufacturer	YOKOWO		Part Number		86769-459B1
Band	B12	B13	B5 / B26	B4	B2
Frequency (MHz)	704	782	832	1730	1880
Gain (dBi)	3.1	3.2	3.8	2.6	2.0

Antenna 2					
Antenna Type	AUX		Connector Type		SMA
Manufacturer	taoglas		Part Number		TG.30.8113
Band	B12 / B13	B5 / B26	B4	B2	
Frequency (MHz)	700-800	824-960	1710-1880	1850-1990	
Free Space Straight Gain (dBi)	1.1	0.3	1.9	2.7	
Free Space Bent Gain (dBi)	2.6	1.5	2.7	3.1	

For WCDMA Band 2 and LTE Band 2: Antenna 2 was chosen for final test according to manufacturer's requirement.

For WCDMA Band 4, 5 and LTE Band 4, 5, 12, 13, 26: Antenna 1 was chosen for final test according to manufacturer's requirement.

3.2 Configuration of System under Test

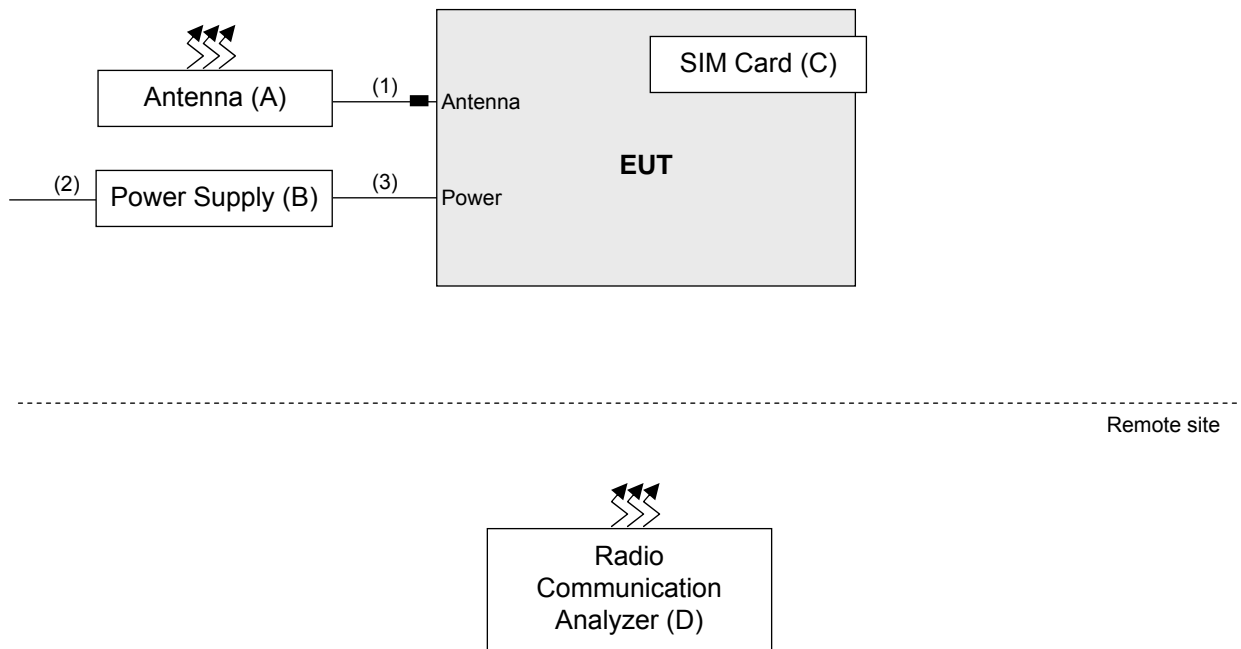

3.2.1 Description of Support Units

The EUT has been tested as an independent unit together with other necessary accessories or support units. The following support units or accessories were used to form a representative test configuration during the tests.

ID	Product	Brand	Model No.	Serial No.	FCC ID	Remarks
A.	Antenna	taoglas	TG.30.8113	NA	NA	Provided by manufacturer
B.	Power Supply	Inspower	DC400-20D	212004	FCC DoC Approved	Provided by manufacturer Input:100-240Vac, 0.4A, 50-60Hz Output: 5Vdc, 3A
C.	SIM Card	NA	NA	NA	NA	Provided by manufacturer
D.	Radio Communication Tester	R&S	CMU200	123112	NA	-

Note:

1. All power cords of the above support units are non-shielded (1.8m).
2. Item D acted as a communication partner to transfer data.

ID	Descriptions	Qty.	Length (m)	Shielding (Yes/No)	Cores (Qty.)	Remarks
1.	Antenna	1	3	N	1	Provided by manufacturer
2.	Power	1	1.75	N	0	Provided by manufacturer
3.	Module cable	2	0.08	N	0	Attached on EUT

Note: The core(s) is(are) originally attached to the cable(s).

3.3 Test Mode Applicability and Tested Channel Detail

Pre-Scan has been conducted to determine the worst-case mode from all possible combinations between available modulations, data rates, XYZ axis and antenna ports. The worst case was found when positioned on Y-plane for WCDMA and Z-plane for LTE. Following channel(s) was (were) selected for the final test as listed below:

WCDMA Band 2

EUT Configure Mode	Test Item	Available Channel	Tested Channel	Mode
-	EIRP	9262 to 9538	9262 (1852.4MHz), 9400 (1880.0MHz), 9538 (1907.6MHz)	WCDMA
-	Modulation Characteristics	9262 to 9538	9400 (1880.0MHz)	WCDMA, HSDPA, HSUPA
-	Frequency Stability	9262 to 9538	9400 (1880.0MHz)	WCDMA
-	Occupied Bandwidth	9262 to 9538	9262 (1852.4MHz), 9400 (1880.0MHz), 9538 (1907.6MHz)	WCDMA, HSDPA, HSUPA
-	Band Edge	9262 to 9538	9262 (1852.4MHz), 9538 (1907.6MHz)	WCDMA, HSDPA, HSUPA
-	Peak To Average Ratio	9262 to 9538	9262 (1852.4MHz), 9400 (1880.0MHz), 9538 (1907.6MHz)	WCDMA, HSDPA, HSUPA
-	Conducted Emission	9262 to 9538	9262 (1852.4MHz), 9400 (1880.0MHz), 9538 (1907.6MHz)	WCDMA, HSDPA, HSUPA
-	Radiated Emission Below 1GHz	9262 to 9538	9262 (1852.4MHz)	WCDMA
-	Radiated Emission Above 1GHz	9262 to 9538	9262 (1852.4MHz), 9400 (1880.0MHz), 9538 (1907.6MHz)	WCDMA

LTE Band 2

EUT Configure Mode	Test item	Available channel	Tested Channel	Channel Bandwidth	Modulation	Mode
-	EIRP	18607 to 19193	18607 (1850.70MHz), 18900 (1880.00MHz), 19193 (1909.30MHz)	1.4MHz	QPSK	1 RB / 5 RB Offset
		18615 to 19185	18615 (1851.50MHz), 18900 (1880.00MHz), 19185 (1908.50MHz)	3MHz	QPSK	1 RB / 14 RB Offset
		18625 to 19175	18625 (1852.50MHz), 18900 (1880.00MHz), 19175 (1907.50MHz)	5MHz	QPSK	1 RB / 24 RB Offset
		18650 to 19150	18650 (1855.00MHz), 18900 (1880.00MHz), 19150 (1905.00MHz)	10MHz	QPSK	1 RB / 49 RB Offset
		18675 to 19125	18675 (1857.50MHz), 18900 (1880.00MHz), 19125 (1902.50MHz)	15MHz	QPSK	1 RB / 74 RB Offset
		18700 to 19100	18700 (1860.00MHz), 18900 (1880.00MHz), 19100 (1900.00MHz)	20MHz	QPSK	1 RB / 99 RB Offset
-	Modulation Characteristics	18700 to 19100	18900 (1880.00MHz)	20MHz	QPSK	1 RB / 99 RB Offset
-	Frequency Stability	18607 to 19193	18900 (1880.00MHz)	1.4MHz	QPSK	1 RB / 5 RB Offset
-	Occupied Bandwidth	18607 to 19193	18607 (1850.70MHz), 18900 (1880.00MHz), 19193 (1909.30MHz)	1.4MHz	QPSK / 16QAM	1 RB / 5 RB Offset
		18615 to 19185	18615 (1851.50MHz), 18900 (1880.00MHz), 19185 (1908.50MHz)	3MHz	QPSK / 16QAM	1 RB / 14 RB Offset
		18625 to 19175	18625 (1852.50MHz), 18900 (1880.00MHz), 19175 (1907.50MHz)	5MHz	QPSK / 16QAM	1 RB / 24 RB Offset
		18650 to 19150	18650 (1855.00MHz), 18900 (1880.00MHz), 19150 (1905.00MHz)	10MHz	QPSK / 16QAM	1 RB / 49 RB Offset
		18675 to 19125	18675 (1857.50MHz), 18900 (1880.00MHz), 19125 (1902.50MHz)	15MHz	QPSK / 16QAM	1 RB / 74 RB Offset
		18700 to 19100	18700 (1860.00MHz), 18900 (1880.00MHz), 19100 (1900.00MHz)	20MHz	QPSK / 16QAM	1 RB / 99 RB Offset
-	Band Edge	18607 to 19193	18607 (1850.70MHz), 19193 (1909.30MHz)	1.4MHz	QPSK	1 RB / 0 RB Offset 1 RB / 5 RB Offset 6 RB / 0 RB Offset
		18615 to 19185	18615 (1851.50MHz), 19185 (1908.50MHz)	3MHz	QPSK	1 RB / 0 RB Offset 1 RB / 14 RB Offset 15 RB / 0 RB Offset
		18625 to 19175	18625 (1852.50MHz), 19175 (1907.50MHz)	5MHz	QPSK	1 RB / 0 RB Offset 1 RB / 24 RB Offset 25 RB / 0 RB Offset
		18650 to 19150	18650 (1855.00MHz), 19150 (1905.00MHz)	10MHz	QPSK	1 RB / 0 RB Offset 1 RB / 49 RB Offset 50 RB / 0 RB Offset
		18675 to 19125	18675 (1857.50MHz), 19125 (1902.50MHz)	15MHz	QPSK	1 RB / 0 RB Offset 1 RB / 74 RB Offset 75 RB / 0 RB Offset
		18700 to 19100	18700 (1860.00MHz), 19100 (1900.00MHz)	20MHz	QPSK	1 RB / 0 RB Offset 1 RB / 99 RB Offset 100 RB / 0 RB Offset

EUT Configure Mode	Test item	Available channel	Tested Channel	Channel Bandwidth	Modulation	Mode
-	Peak to Average Ratio	18607 to 19193	18607 (1850.70MHz), 18900 (1880.00MHz), 19193 (1909.30MHz)	1.4MHz	QPSK / 16QAM	1 RB / 5 RB Offset
		18615 to 19185	18615 (1851.50MHz), 18900 (1880.00MHz), 19185 (1908.50MHz)	3MHz	QPSK / 16QAM	1 RB / 14 RB Offset
		18625 to 19175	18625 (1852.50MHz), 18900 (1880.00MHz), 19175 (1907.50MHz)	5MHz	QPSK / 16QAM	1 RB / 24 RB Offset
		18650 to 19150	18650 (1855.00MHz), 18900 (1880.00MHz), 19150 (1905.00MHz)	10MHz	QPSK / 16QAM	1 RB / 49 RB Offset
		18675 to 19125	18675 (1857.50MHz), 18900 (1880.00MHz), 19125 (1902.50MHz)	15MHz	QPSK / 16QAM	1 RB / 74 RB Offset
		18700 to 19100	18700 (1860.00MHz), 18900 (1880.00MHz), 19100 (1900.00MHz)	20MHz	QPSK / 16QAM	1 RB / 99 RB Offset
-	Conducted Emission	18607 to 19193	18607 (1850.70MHz), 18900 (1880.00MHz), 19193 (1909.30MHz)	1.4MHz	QPSK	1 RB / 5 RB Offset
		18615 to 19185	18615 (1851.50MHz), 18900 (1880.00MHz), 19185 (1908.50MHz)	3MHz	QPSK	1 RB / 14 RB Offset
		18625 to 19175	18625 (1852.50MHz), 18900 (1880.00MHz), 19175 (1907.50MHz)	5MHz	QPSK	1 RB / 24 RB Offset
		18650 to 19150	18650 (1855.00MHz), 18900 (1880.00MHz), 19150 (1905.00MHz)	10MHz	QPSK	1 RB / 49 RB Offset
		18675 to 19125	18675 (1857.50MHz), 18900 (1880.00MHz), 19125 (1902.50MHz)	15MHz	QPSK	1 RB / 74 RB Offset
		18700 to 19100	18700 (1860.00MHz), 18900 (1880.00MHz), 19100 (1900.00MHz)	20MHz	QPSK	1 RB / 99 RB Offset
-	Radiated Emission Below 1GHz	18607 to 19193	18607 (1850.70MHz)	1.4MHz	QPSK	1 RB / 5 RB Offset
		18615 to 19185	18615 (1851.50MHz)	3MHz	QPSK	1 RB / 14 RB Offset
		18625 to 19175	18625 (1852.50MHz)	5MHz	QPSK	1 RB / 24 RB Offset
		18650 to 19150	18650 (1855.00MHz)	10MHz	QPSK	1 RB / 49 RB Offset
		18675 to 19125	18675 (1857.50MHz)	15MHz	QPSK	1 RB / 74 RB Offset
		18700 to 19100	18700 (1860.00MHz)	20MHz	QPSK	1 RB / 99 RB Offset
-	Radiated Emission Above 1GHz	18607 to 19193	18607 (1850.70MHz), 18900 (1880.00MHz), 19193 (1909.30MHz)	1.4MHz	QPSK	1 RB / 5 RB Offset
		18615 to 19185	18615 (1851.50MHz), 18900 (1880.00MHz), 19185 (1908.50MHz)	3MHz	QPSK	1 RB / 14 RB Offset
		18625 to 19175	18625 (1852.50MHz), 18900 (1880.00MHz), 19175 (1907.50MHz)	5MHz	QPSK	1 RB / 24 RB Offset
		18650 to 19150	18650 (1855.00MHz), 18900 (1880.00MHz), 19150 (1905.00MHz)	10MHz	QPSK	1 RB / 49 RB Offset
		18675 to 19125	18675 (1857.50MHz), 18900 (1880.00MHz), 19125 (1902.50MHz)	15MHz	QPSK	1 RB / 74 RB Offset
		18700 to 19100	18700 (1860.00MHz), 18900 (1880.00MHz), 19100 (1900.00MHz)	20MHz	QPSK	1 RB / 99 RB Offset

Note:

1. For radiated emission below 1GHz, low, mid and high channels were pre-tested in chamber. Low channel was the worst case for all final tests.
2. The conducted output power for QPSK and 16QAM, measured value of QPSK is higher than 16QAM mode. Therefore, Occupied bandwidth and Peak to average ratio items were tested under QPSK and 16QAM modes, and the other test items were tested under QPSK mode only.

Test Condition:

Test Item	Environmental Conditions	Input Power (system)	Tested By
EIRP	25deg. C, 65%RH 25deg. C, 66%RH	120Vac, 60Hz	Greg Lin James Yang
Modulation Characteristics	24deg. C, 64%RH	120Vac, 60Hz	Match Tsui
Frequency Stability	24deg. C, 64%RH	120Vac, 60Hz	Match Tsui
Occupied Bandwidth	24deg. C, 64%RH	120Vac, 60Hz	Match Tsui
Band Edge	24deg. C, 64%RH	120Vac, 60Hz	Match Tsui
Peak To Average Ratio	24deg. C, 64%RH	120Vac, 60Hz	Match Tsui
Conducted Emission	24deg. C, 64%RH	120Vac, 60Hz	Match Tsui
Radiated Emission	25deg. C, 66%RH 25deg. C, 65%RH	120Vac, 60Hz	James Yang Greg Lin

3.4 EUT Operating Conditions

The EUT makes a call to the communication simulator. The communication simulator station system controlled a EUT to export maximum output power under transmission mode and specific channel frequency

3.5 General Description of Applied Standards

The EUT is a RF Product. According to the specifications of the manufacturer, it must comply with the requirements of the following standards:

- FCC 47 CFR Part 2**
- FCC 47 CFR Part 24**
- KDB 971168 D01 Power Meas License Digital Systems v02r02**
- ANSI/TIA/EIA-603-E 2016**
- ANSI 63.26-2015**

All test items have been performed and recorded as per the above standards.

4 Test Types and Results

4.1 Output Power Measurement

4.1.1 Limits of Output Power Measurement

Mobile / Portable station are limited to 2 watts e.r.p.

4.1.2 Test Procedures

EIRP / ERP Measurement:

- a. All measurements were done at low, middle and high operational frequency range. RBW and VBW is 5MHz for WCDMA mode and 10MHz for LTE mode.
- b. Substitution method is used for E.I.R.P measurement. In the semi-anechoic chamber, EUT placed on the 0.8m(below or equal 1GHz) and/or 1.5m(above 1GHz) height of Turn Table, rotated the table around 360 degrees to search the maximum radiation power and receiver antenna shall be rotated vertical and horizontal polarization and moved height from 1m to 4m to find the maximum polar radiated power. The "Read Value" is the spectrum reading the maximum power value.
- c. The substitution horn antenna is substituted for EUT at the same position and signals generator export the CW signal to the substitution antenna via a TX cable. Rotated the Turn Table and moved receiving antenna to find the maximum radiation power. Adjust output power level of S.G to get a Value of spectrum reading equal to "Read Value" of step b. Record the power level of S.G
- d. EIRP = Output power level of S.G – TX cable loss + Antenna gain of substitution horn.E.R.P power can be calculated form E.I.R.P power by subtracting the gain of dipole, E.R.P power = E.I.R.P power - 2.15dBi.

Where:

$$ERP/EIRP = P_{Meas} + G_T - L_C$$

P_{Meas} : Measure transmitter output power.

G_T : Gain of the transmitting antenna.

L_C : signal attenuation in the connecting cable between the transmitter and antenna.

Conducted Power Measurement:

The EUT was set up for the maximum power with WCDMA, LTE link data modulation and link up with simulator. Set the EUT to transmit under low, middle and high channel and record the power level shown on simulator.

4.1.3 Test Setup

EIRP / ERP Measurement:

For radiated emission 30MHz to 1GHz

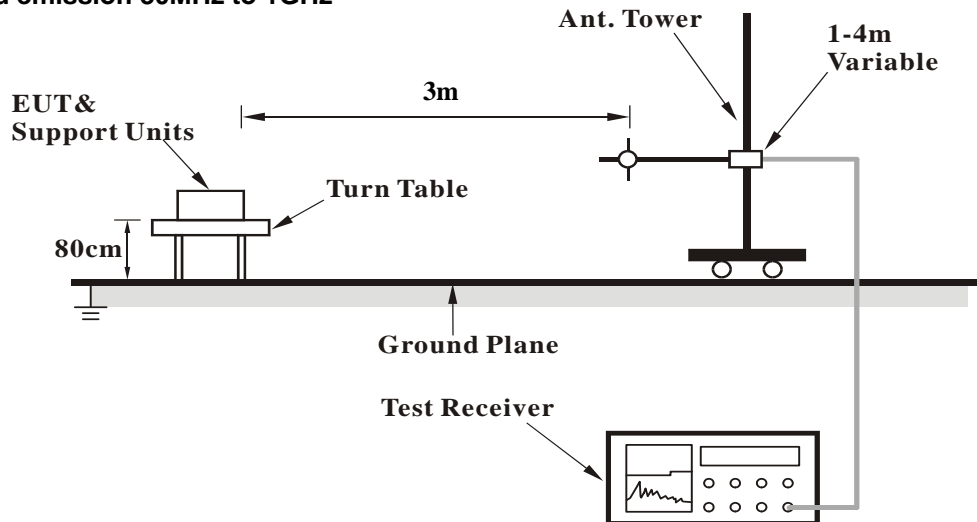

For radiated emission above 1GHz

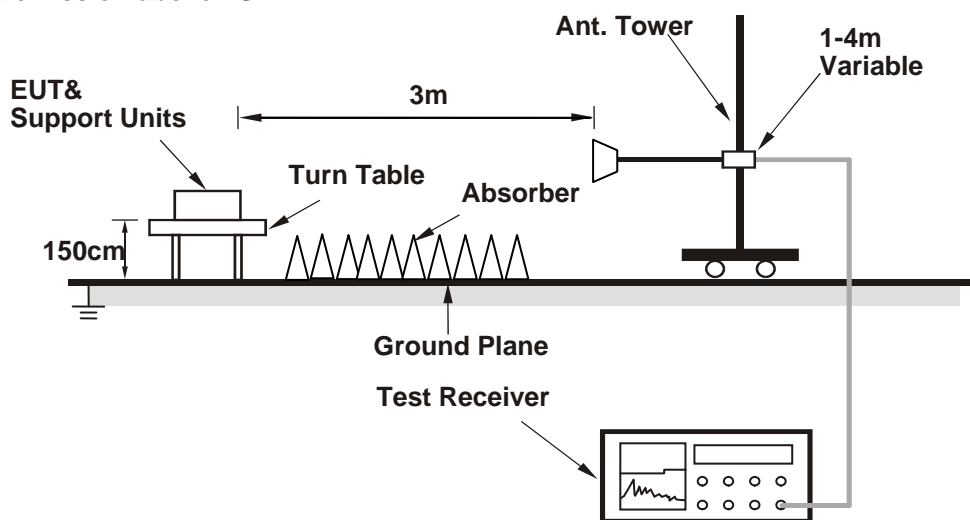

For the actual test configuration, please refer to the attached file (Test Setup Photo).

Conducted Power Measurement:



For the actual test configuration, please refer to the attached file (Test Setup Photo).

4.1.4 Test Results

Conducted Output Power (dBm)

Band	WCDMA II		
Channel	9262	9400	9538
Frequency	1852.4	1880	1907.6
RMC 12.2K	23.24	23.17	23.35
HSDPA Subtest-1	22.18	22.16	22.21
HSUPA Subtest-1	21.26	21.20	21.18

Band / BW	RB Size	RB Offset	QPSK			16QAM		
			CH 18607	CH 18900	CH 19193	CH 18607	CH 18900	CH 19193
			1850.7 MHz	1880 MHz	1909.3 MHz	1850.7 MHz	1880 MHz	1909.3 MHz
2 / 1.4MHz	1	0	21.08	21.23	21.30	19.74	20.01	20.03
	1	2	20.99	21.18	21.25	19.68	20.00	20.01
	1	5	20.95	21.13	21.23	19.66	19.97	20.02
	3	0	20.87	21.09	21.18	19.62	19.85	19.99
	3	1	20.83	21.14	21.20	19.64	19.83	19.98
	3	3	20.85	21.14	21.21	19.61	19.82	19.96
	6	0	19.92	20.11	20.35	18.86	19.11	19.31
Band / BW	RB Size	RB Offset	QPSK			16QAM		
			CH 18615	CH 18900	CH 19185	CH 18615	CH 18900	CH 19185
			1851.5 MHz	1880 MHz	1908.5 MHz	1851.5 MHz	1880 MHz	1908.5 MHz
2 / 3MHz	1	0	21.11	21.26	21.34	19.86	19.88	19.89
	1	7	21.05	21.25	21.28	19.73	19.79	19.75
	1	14	21.03	21.13	21.30	19.65	19.76	19.77
	8	0	20.02	20.15	20.28	18.76	18.92	19.03
	8	3	20.11	20.20	20.20	18.80	18.88	19.01
	8	7	19.97	20.08	20.11	18.81	18.90	19.05
	15	0	19.87	20.06	20.29	18.53	18.77	18.92
Band / BW	RB Size	RB Offset	QPSK			16QAM		
			CH 18625	CH 18900	CH 19175	CH 18625	CH 18900	CH 19175
			1852.5 MHz	1880 MHz	1907.5 MHz	1852.5 MHz	1880 MHz	1907.5 MHz
2 / 5MHz	1	0	21.17	21.27	21.41	19.90	19.99	20.01
	1	12	21.11	21.25	21.38	19.86	19.95	19.96
	1	24	21.13	21.22	21.33	19.88	19.96	19.98
	12	0	20.18	20.33	20.52	18.81	18.87	18.92
	12	6	20.15	20.35	20.57	18.79	18.85	18.99
	12	13	20.16	20.30	20.55	18.82	18.85	18.93
	25	0	20.11	20.28	20.46	18.55	18.62	18.84
Band / BW	RB Size	RB Offset	QPSK			16QAM		
			CH 18650	CH 18900	CH 19150	CH 18650	CH 18900	CH 19150
			1855 MHz	1880 MHz	1905 MHz	1855 MHz	1880 MHz	1905 MHz
2 / 10MHz	1	0	21.32	21.50	21.52	19.96	20.20	20.23
	1	24	21.28	21.44	21.45	19.91	20.11	20.18
	1	49	21.26	21.15	21.33	19.93	20.16	20.20
	25	0	20.33	20.56	20.62	19.15	19.25	19.45
	25	12	20.34	20.40	20.47	19.11	19.21	19.33
	25	25	20.31	20.28	20.36	19.15	19.27	19.35
	50	0	20.08	20.27	20.33	18.92	19.05	19.21
Band / BW	RB Size	RB Offset	QPSK			16QAM		
			CH 18675	CH 18900	CH 19125	CH 18675	CH 18900	CH 19125
			1857.5 MHz	1880 MHz	1902.5 MHz	1857.5 MHz	1880 MHz	1902.5 MHz
2 / 15MHz	1	0	21.15	21.45	21.53	19.93	20.20	20.27
	1	37	21.11	21.33	21.48	19.87	20.15	20.25
	1	74	21.12	21.32	21.42	19.85	20.18	20.20
	36	0	20.38	20.50	20.77	19.23	19.33	19.55
	36	19	20.36	20.33	20.72	19.20	19.38	19.52
	36	39	20.33	20.26	20.80	19.21	19.36	19.58
	75	0	20.05	20.24	20.39	18.97	19.18	19.33

Band / BW	RB Size	RB Offset	QPSK			16QAM		
			CH 18700	CH 18900	CH 19100	CH 18700	CH 18900	CH 19100
			1860 MHz	1880 MHz	1900 MHz	1860 MHz	1880 MHz	1900 MHz
2 / 20MHz	1	0	21.15	21.35	21.42	19.83	19.94	20.04
	1	50	21.13	21.28	21.38	19.70	19.82	19.92
	1	99	21.12	21.16	21.35	19.77	19.92	19.91
	50	0	20.15	20.33	20.56	18.52	18.87	19.15
	50	25	20.18	20.34	20.61	18.53	18.90	19.13
	50	50	20.16	20.21	20.62	18.49	18.79	19.08
	100	0	20.11	20.23	20.45	18.33	18.62	18.78

EIRP Power

WCDMA Band 2

MODE		TX channel 9262					
Antenna Polarity & Test Distance: Horizontal at 3 M							
No.	Freq. (MHz)	Reading (dBm)	S.G Power Value (dBm)	Correction Factor (dB)	EIRP (dBm)	Limit (dBm)	Margin (dB)
1	1852.40	-18.0	22.2	0.1	22.3	33.0	-10.7
Antenna Polarity & Test Distance: Vertical at 3 M							
No.	Freq. (MHz)	Reading (dBm)	S.G Power Value (dBm)	Correction Factor (dB)	EIRP (dBm)	Limit (dBm)	Margin (dB)
1	1852.40	-23.6	16.8	0.1	16.9	33.0	-16.1

MODE		TX channel 9400					
Antenna Polarity & Test Distance: Horizontal at 3 M							
No.	Freq. (MHz)	Reading (dBm)	S.G Power Value (dBm)	Correction Factor (dB)	EIRP (dBm)	Limit (dBm)	Margin (dB)
1	1880.00	-17.9	22.6	0.0	22.6	33.0	-10.4
Antenna Polarity & Test Distance: Vertical at 3 M							
No.	Freq. (MHz)	Reading (dBm)	S.G Power Value (dBm)	Correction Factor (dB)	EIRP (dBm)	Limit (dBm)	Margin (dB)
1	1880.00	-24.3	16.3	0.0	16.3	33.0	-16.7

MODE		TX channel 9538					
Antenna Polarity & Test Distance: Horizontal at 3 M							
No.	Freq. (MHz)	Reading (dBm)	S.G Power Value (dBm)	Correction Factor (dB)	EIRP (dBm)	Limit (dBm)	Margin (dB)
1	1907.60	-17.8	22.9	-0.1	22.8	33.0	-10.2
Antenna Polarity & Test Distance: Vertical at 3 M							
No.	Freq. (MHz)	Reading (dBm)	S.G Power Value (dBm)	Correction Factor (dB)	EIRP (dBm)	Limit (dBm)	Margin (dB)
1	1907.60	-24.2	16.6	-0.1	16.5	33.0	-16.5

Note: EIRP (dBm) = S.G Power Value (dBm) + Correction Factor (dB).

LTE Band 2, Channel Bandwidth 1.4MHz

MODE		TX channel 18607					
Antenna Polarity & Test Distance: Horizontal at 3 M							
No.	Freq. (MHz)	Reading (dBm)	S.G Power Value (dBm)	Correction Factor (dB)	EIRP (dBm)	Limit (dBm)	Margin (dB)
1	1850.70	-24.0	16.2	0.1	16.3	33.0	-16.7
Antenna Polarity & Test Distance: Vertical at 3 M							
No.	Freq. (MHz)	Reading (dBm)	S.G Power Value (dBm)	Correction Factor (dB)	EIRP (dBm)	Limit (dBm)	Margin (dB)
1	1850.70	-13.9	26.5	0.1	26.6	33.0	-6.4

MODE		TX channel 18900					
Antenna Polarity & Test Distance: Horizontal at 3 M							
No.	Freq. (MHz)	Reading (dBm)	S.G Power Value (dBm)	Correction Factor (dB)	EIRP (dBm)	Limit (dBm)	Margin (dB)
1	1880.00	-26.5	14.0	0.0	14.0	33.0	-19.0
Antenna Polarity & Test Distance: Vertical at 3 M							
No.	Freq. (MHz)	Reading (dBm)	S.G Power Value (dBm)	Correction Factor (dB)	EIRP (dBm)	Limit (dBm)	Margin (dB)
1	1880.00	-15.6	25.0	0.0	25.0	33.0	-8.0

MODE		TX channel 19193					
Antenna Polarity & Test Distance: Horizontal at 3 M							
No.	Freq. (MHz)	Reading (dBm)	S.G Power Value (dBm)	Correction Factor (dB)	EIRP (dBm)	Limit (dBm)	Margin (dB)
1	1909.30	-27.0	13.7	-0.1	13.6	33.0	-19.4
Antenna Polarity & Test Distance: Vertical at 3 M							
No.	Freq. (MHz)	Reading (dBm)	S.G Power Value (dBm)	Correction Factor (dB)	EIRP (dBm)	Limit (dBm)	Margin (dB)
1	1909.30	-11.9	28.9	-0.1	28.8	33.0	-4.2

Note: EIRP (dBm) = S.G Power Value (dBm) + Correction Factor (dB).

LTE Band 2, Channel Bandwidth 3MHz

MODE		TX channel 18615					
Antenna Polarity & Test Distance: Horizontal at 3 M							
No.	Freq. (MHz)	Reading (dBm)	S.G Power Value (dBm)	Correction Factor (dB)	EIRP (dBm)	Limit (dBm)	Margin (dB)
1	1851.50	-24.2	16.0	0.1	16.1	33.0	-16.9
Antenna Polarity & Test Distance: Vertical at 3 M							
No.	Freq. (MHz)	Reading (dBm)	S.G Power Value (dBm)	Correction Factor (dB)	EIRP (dBm)	Limit (dBm)	Margin (dB)
1	1851.50	-13.8	26.6	0.1	26.7	33.0	-6.3

MODE		TX channel 18900					
Antenna Polarity & Test Distance: Horizontal at 3 M							
No.	Freq. (MHz)	Reading (dBm)	S.G Power Value (dBm)	Correction Factor (dB)	EIRP (dBm)	Limit (dBm)	Margin (dB)
1	1880.00	-27.7	12.8	0.0	12.8	33.0	-20.2
Antenna Polarity & Test Distance: Vertical at 3 M							
No.	Freq. (MHz)	Reading (dBm)	S.G Power Value (dBm)	Correction Factor (dB)	EIRP (dBm)	Limit (dBm)	Margin (dB)
1	1880.00	-15.4	25.2	0.0	25.2	33.0	-7.8

MODE		TX channel 19185					
Antenna Polarity & Test Distance: Horizontal at 3 M							
No.	Freq. (MHz)	Reading (dBm)	S.G Power Value (dBm)	Correction Factor (dB)	EIRP (dBm)	Limit (dBm)	Margin (dB)
1	1908.50	-31.0	9.7	-0.1	9.6	33.0	-23.4
Antenna Polarity & Test Distance: Vertical at 3 M							
No.	Freq. (MHz)	Reading (dBm)	S.G Power Value (dBm)	Correction Factor (dB)	EIRP (dBm)	Limit (dBm)	Margin (dB)
1	1908.50	-13.0	27.8	-0.1	27.7	33.0	-5.3

Note: EIRP (dBm) = S.G Power Value (dBm) + Correction Factor (dB).

LTE Band 2, Channel Bandwidth 5MHz

MODE		TX channel 18625					
Antenna Polarity & Test Distance: Horizontal at 3 M							
No.	Freq. (MHz)	Reading (dBm)	S.G Power Value (dBm)	Correction Factor (dB)	EIRP (dBm)	Limit (dBm)	Margin (dB)
1	1852.50	-24.3	15.9	0.1	16.0	33.0	-17.0
Antenna Polarity & Test Distance: Vertical at 3 M							
No.	Freq. (MHz)	Reading (dBm)	S.G Power Value (dBm)	Correction Factor (dB)	EIRP (dBm)	Limit (dBm)	Margin (dB)
1	1852.50	-13.5	26.9	0.1	27.0	33.0	-6.0

MODE		TX channel 18900					
Antenna Polarity & Test Distance: Horizontal at 3 M							
No.	Freq. (MHz)	Reading (dBm)	S.G Power Value (dBm)	Correction Factor (dB)	EIRP (dBm)	Limit (dBm)	Margin (dB)
1	1880.00	-24.3	16.2	0.0	16.2	33.0	-16.8
Antenna Polarity & Test Distance: Vertical at 3 M							
No.	Freq. (MHz)	Reading (dBm)	S.G Power Value (dBm)	Correction Factor (dB)	EIRP (dBm)	Limit (dBm)	Margin (dB)
1	1880.00	-15.0	25.6	0.0	25.6	33.0	-7.4

MODE		TX channel 19175					
Antenna Polarity & Test Distance: Horizontal at 3 M							
No.	Freq. (MHz)	Reading (dBm)	S.G Power Value (dBm)	Correction Factor (dB)	EIRP (dBm)	Limit (dBm)	Margin (dB)
1	1907.50	-27.4	13.3	-0.1	13.2	33.0	-19.8
Antenna Polarity & Test Distance: Vertical at 3 M							
No.	Freq. (MHz)	Reading (dBm)	S.G Power Value (dBm)	Correction Factor (dB)	EIRP (dBm)	Limit (dBm)	Margin (dB)
1	1907.50	-13.5	27.3	-0.1	27.2	33.0	-5.8

Note: EIRP (dBm) = S.G Power Value (dBm) + Correction Factor (dB).

LTE Band 2, Channel Bandwidth 10MHz

MODE		TX channel 18650					
Antenna Polarity & Test Distance: Horizontal at 3 M							
No.	Freq. (MHz)	Reading (dBm)	S.G Power Value (dBm)	Correction Factor (dB)	EIRP (dBm)	Limit (dBm)	Margin (dB)
1	1855.00	-23.8	16.5	0.0	16.5	33.0	-16.5
Antenna Polarity & Test Distance: Vertical at 3 M							
No.	Freq. (MHz)	Reading (dBm)	S.G Power Value (dBm)	Correction Factor (dB)	EIRP (dBm)	Limit (dBm)	Margin (dB)
1	1855.00	-14.4	26.1	0.0	26.1	33.0	-6.9

MODE		TX channel 18900					
Antenna Polarity & Test Distance: Horizontal at 3 M							
No.	Freq. (MHz)	Reading (dBm)	S.G Power Value (dBm)	Correction Factor (dB)	EIRP (dBm)	Limit (dBm)	Margin (dB)
1	1880.00	-25.5	15.0	0.0	15.0	33.0	-18.0
Antenna Polarity & Test Distance: Vertical at 3 M							
No.	Freq. (MHz)	Reading (dBm)	S.G Power Value (dBm)	Correction Factor (dB)	EIRP (dBm)	Limit (dBm)	Margin (dB)
1	1880.00	-15.0	25.6	0.0	25.6	33.0	-7.4

MODE		TX channel 19150					
Antenna Polarity & Test Distance: Horizontal at 3 M							
No.	Freq. (MHz)	Reading (dBm)	S.G Power Value (dBm)	Correction Factor (dB)	EIRP (dBm)	Limit (dBm)	Margin (dB)
1	1905.00	-26.0	14.7	-0.1	14.6	33.0	-18.4
Antenna Polarity & Test Distance: Vertical at 3 M							
No.	Freq. (MHz)	Reading (dBm)	S.G Power Value (dBm)	Correction Factor (dB)	EIRP (dBm)	Limit (dBm)	Margin (dB)
1	1905.00	-12.7	28.1	-0.1	28.0	33.0	-5.0

Note: EIRP (dBm) = S.G Power Value (dBm) + Correction Factor (dB).

LTE Band 2, Channel Bandwidth 15MHz

MODE		TX channel 18675					
Antenna Polarity & Test Distance: Horizontal at 3 M							
No.	Freq. (MHz)	Reading (dBm)	S.G Power Value (dBm)	Correction Factor (dB)	EIRP (dBm)	Limit (dBm)	Margin (dB)
1	1857.50	-27.7	12.6	0.0	12.6	33.0	-20.4
Antenna Polarity & Test Distance: Vertical at 3 M							
No.	Freq. (MHz)	Reading (dBm)	S.G Power Value (dBm)	Correction Factor (dB)	EIRP (dBm)	Limit (dBm)	Margin (dB)
1	1857.50	-13.8	26.7	0.0	26.7	33.0	-6.3

MODE		TX channel 18900					
Antenna Polarity & Test Distance: Horizontal at 3 M							
No.	Freq. (MHz)	Reading (dBm)	S.G Power Value (dBm)	Correction Factor (dB)	EIRP (dBm)	Limit (dBm)	Margin (dB)
1	1880.00	-27.5	13.0	0.0	13.0	33.0	-20.0
Antenna Polarity & Test Distance: Vertical at 3 M							
No.	Freq. (MHz)	Reading (dBm)	S.G Power Value (dBm)	Correction Factor (dB)	EIRP (dBm)	Limit (dBm)	Margin (dB)
1	1880.00	-13.9	26.7	0.0	26.7	33.0	-6.3

MODE		TX channel 19125					
Antenna Polarity & Test Distance: Horizontal at 3 M							
No.	Freq. (MHz)	Reading (dBm)	S.G Power Value (dBm)	Correction Factor (dB)	EIRP (dBm)	Limit (dBm)	Margin (dB)
1	1902.50	-32.0	8.7	-0.1	8.6	33.0	-24.4
Antenna Polarity & Test Distance: Vertical at 3 M							
No.	Freq. (MHz)	Reading (dBm)	S.G Power Value (dBm)	Correction Factor (dB)	EIRP (dBm)	Limit (dBm)	Margin (dB)
1	1902.50	-13.4	27.4	-0.1	27.3	33.0	-5.7

Note: EIRP (dBm) = S.G Power Value (dBm) + Correction Factor (dB).

LTE Band 2, Channel Bandwidth 20MHz

MODE		TX channel 18700					
Antenna Polarity & Test Distance: Horizontal at 3 M							
No.	Freq. (MHz)	Reading (dBm)	S.G Power Value (dBm)	Correction Factor (dB)	EIRP (dBm)	Limit (dBm)	Margin (dB)
1	1860.00	-29.0	11.3	0.0	11.3	33.0	-21.7
Antenna Polarity & Test Distance: Vertical at 3 M							
No.	Freq. (MHz)	Reading (dBm)	S.G Power Value (dBm)	Correction Factor (dB)	EIRP (dBm)	Limit (dBm)	Margin (dB)
1	1860.00	-14.1	26.4	0.0	26.4	33.0	-6.6

MODE		TX channel 18900					
Antenna Polarity & Test Distance: Horizontal at 3 M							
No.	Freq. (MHz)	Reading (dBm)	S.G Power Value (dBm)	Correction Factor (dB)	EIRP (dBm)	Limit (dBm)	Margin (dB)
1	1880.00	-29.0	11.5	0.0	11.5	33.0	-21.5
Antenna Polarity & Test Distance: Vertical at 3 M							
No.	Freq. (MHz)	Reading (dBm)	S.G Power Value (dBm)	Correction Factor (dB)	EIRP (dBm)	Limit (dBm)	Margin (dB)
1	1880.00	-15.1	25.5	0.0	25.5	33.0	-7.5

MODE		TX channel 19100					
Antenna Polarity & Test Distance: Horizontal at 3 M							
No.	Freq. (MHz)	Reading (dBm)	S.G Power Value (dBm)	Correction Factor (dB)	EIRP (dBm)	Limit (dBm)	Margin (dB)
1	1900.00	-29.0	11.7	-0.1	11.6	33.0	-21.4
Antenna Polarity & Test Distance: Vertical at 3 M							
No.	Freq. (MHz)	Reading (dBm)	S.G Power Value (dBm)	Correction Factor (dB)	EIRP (dBm)	Limit (dBm)	Margin (dB)
1	1900.00	-13.7	27.1	-0.1	27.0	33.0	-6.0

Note: EIRP (dBm) = S.G Power Value (dBm) + Correction Factor (dB).

4.2 Modulation Characteristics Measurement

4.2.1 Limits of Modulation Characteristics

N/A

4.2.2 Test Procedure

Connect the EUT to Communication Simulator via the antenna connector, The frequency band is set as EUT supported Modulation and Channels, the EUT output is matched with 50 ohm load, the waveform quality and constellation of the EUT was tested.

4.2.3 Test Setup



4.2.4 Test Results

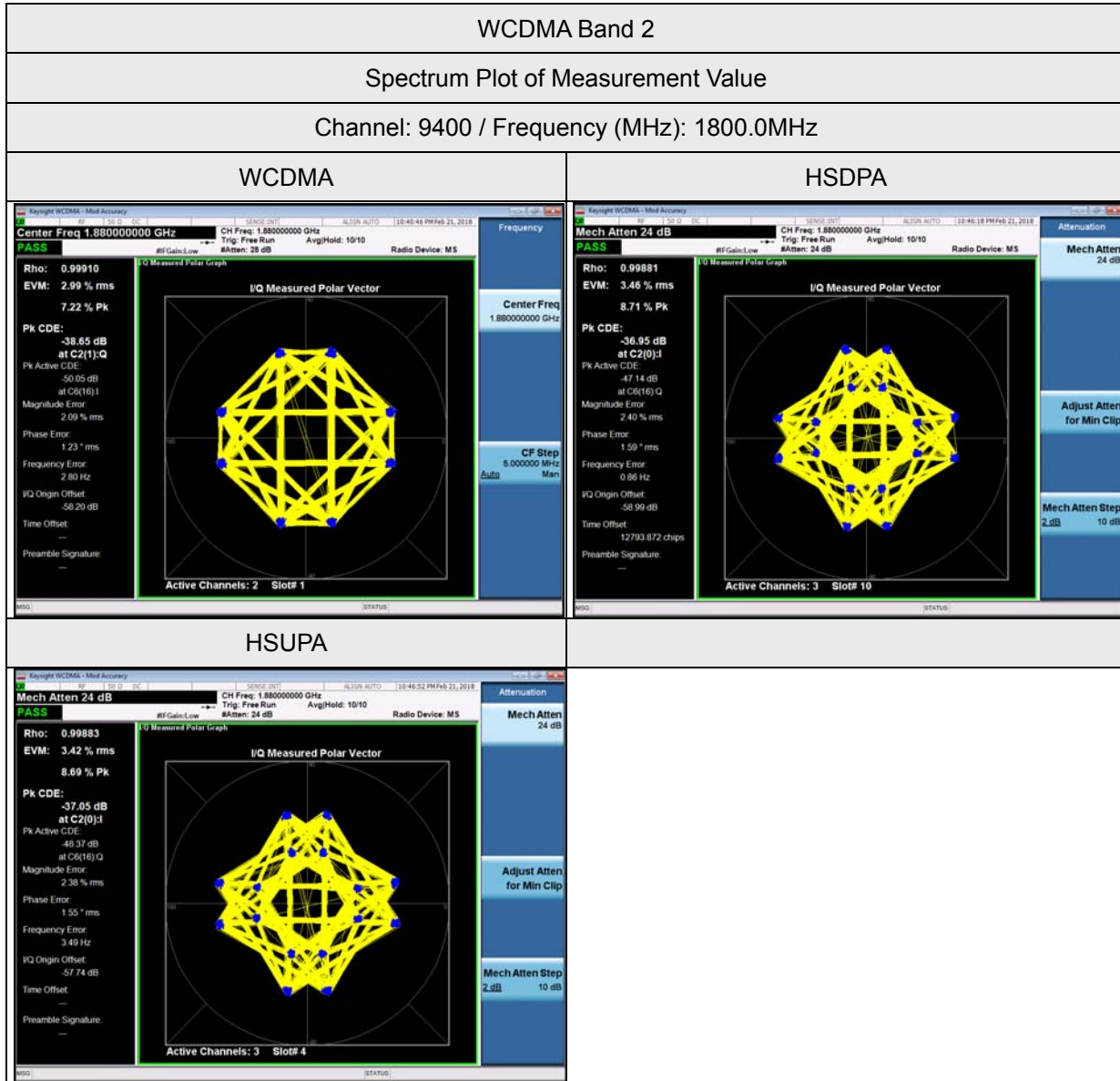

LTE Band 2

Spectrum Plot of Measurement Value

Channel: 18900 / Frequency (MHz): 1880.0MHz

Channel Bandwidth 20MHz / QPSK

Channel Bandwidth 20MHz / 16QAM

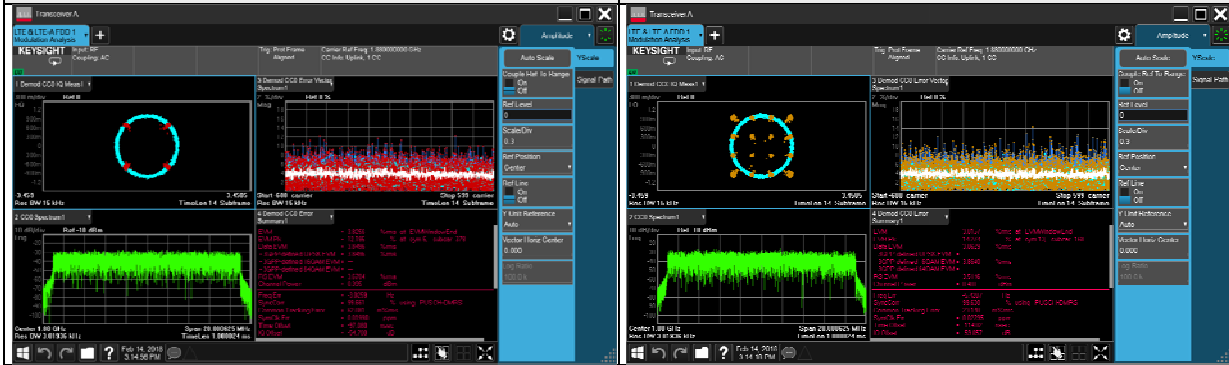

4.3 Frequency Stability Measurement

4.3.1 Limits of Frequency Stability Measurement

1.5 ppm is for base and fixed station. 2.5 ppm is for mobile station.

4.3.2 Test Procedure

- a. Device is placed at the oven room. The oven room could control the temperatures and humidity. Power warm up is at least 15 min and power applied should perform before recording frequency error.
- b. EUT is connected the external power supply to control the DC input power. The test voltage range is from minimum to maximum working voltage. Each step shall be record the frequency error rate.
- c. The temperature range step is 10 degrees in this test items. All temperature levels shall be hold the ± 0.5 °C during the measurement testing. The each temperature step shall be at least 0.5 hours, consider the EUT could be test under the stability condition.

Note: The frequency error was recorded frequency error from the communication simulator.

4.3.3 Test Setup

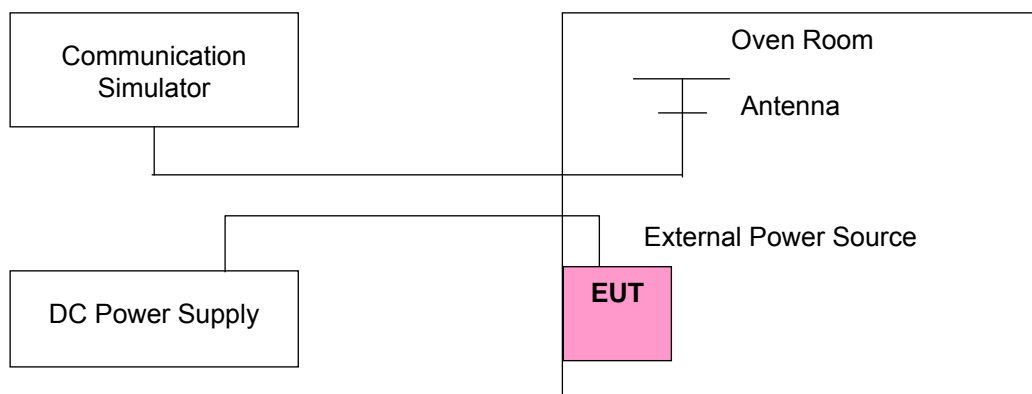

4.3.4 Test Results

Frequency Error vs. Voltage

Voltage (Volts)	Frequency Error (ppm)		Limit (ppm)
	WCDMA Band 2	LTE Band 2	
4.3	0.02059	0.11296	2.5
3.8	0.07716	0.02164	2.5
3.4	0.09085	0.10797	2.5

Note: The applicant defined the normal working voltage is from 3.4Vdc to 4.3Vdc.

Frequency Error vs. Temperature.

Temp. (°C)	Frequency Error (ppm)		Limit (ppm)
	WCDMA Band 2	LTE Band 2	
50	0.08897	0.12205	2.5
40	0.00327	0.04781	2.5
30	0.11656	0.02334	2.5
20	0.07716	0.02164	2.5
10	0.04694	0.01496	2.5
0	0.07315	0.11168	2.5
-10	0.02462	0.00175	2.5
-20	0.10179	0.00261	2.5

4.4 Occupied Bandwidth Measurement

4.4.1 Test Procedure

The EUT makes a call to the communication simulator. All measurements were done at low, middle and high operational frequency range. The communication simulator station system controlled a EUT to export maximum output power under transmission mode and specific channel frequency. Use OBW measurement function of Spectrum analyzer to measure 99 % occupied bandwidth.

4.4.2 Test Setup

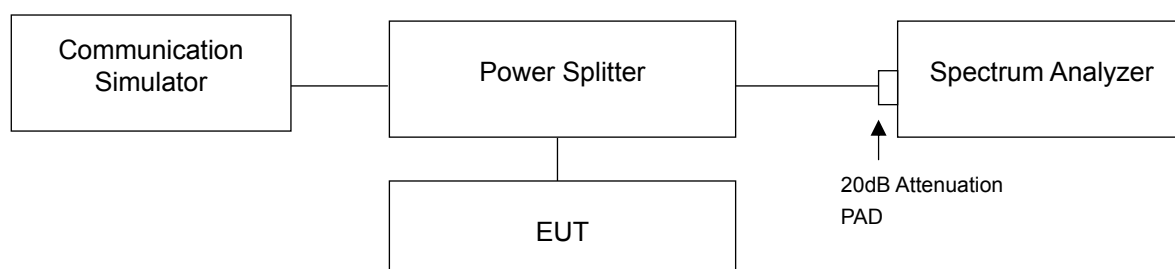

4.4.3 Test Result

Occupied Bandwidth

WCDMA Band 2				
Channel	Frequency (MHz)	99% Occupied Bandwidth (MHz)		
		WCDMA	HSDPA	HSUPA
9262	1852.4	4.14	4.14	4.12
9400	1880.0	4.16	4.14	4.14
9538	1907.6	4.14	4.14	4.14

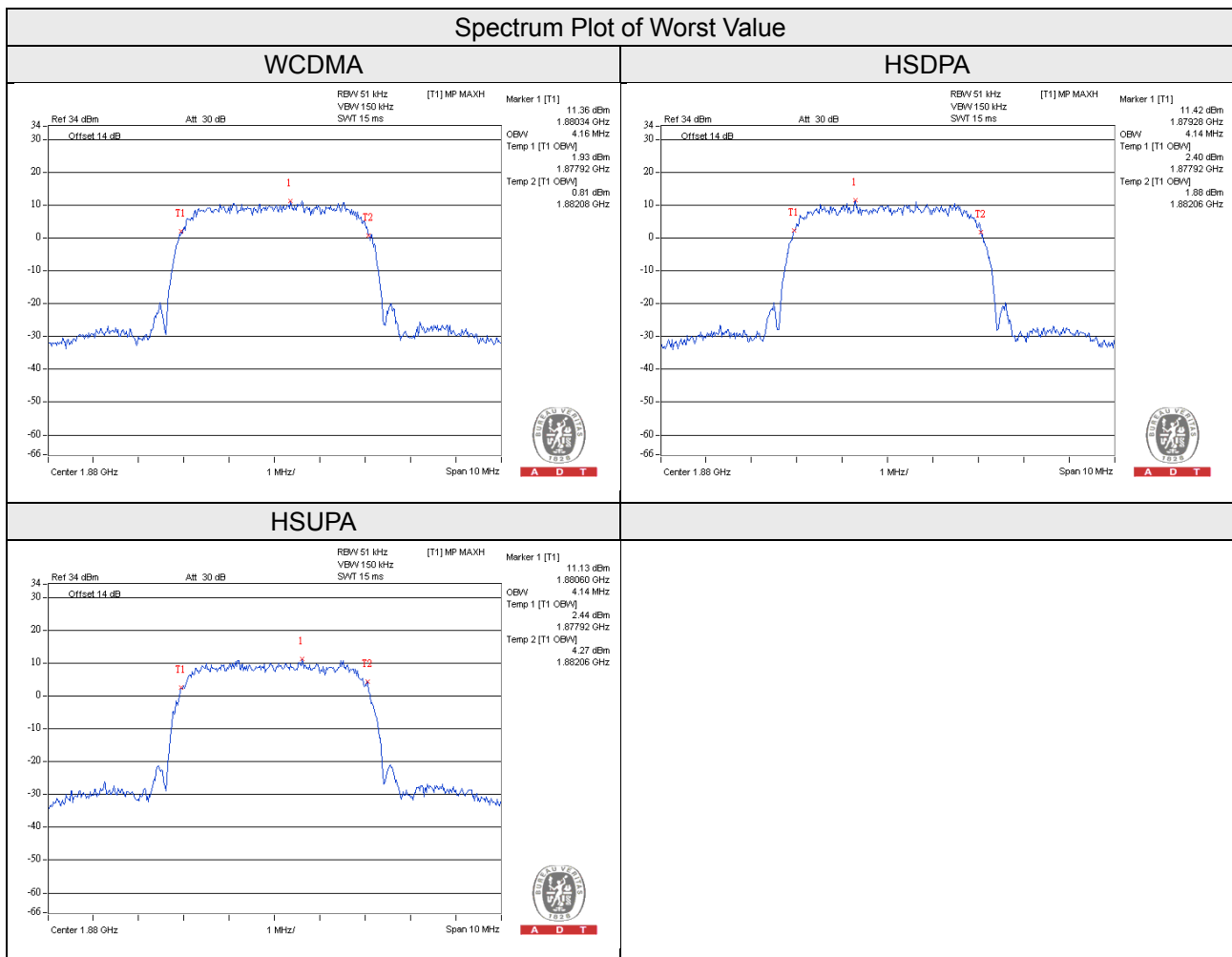

LTE Band 2, Channel Bandwidth 1.4MHz			
Channel	Frequency (MHz)	99% Occupied Bandwidth (MHz)	
		QPSK	16QAM
18607	1850.7	1.09	1.10
18900	1880.0	1.10	1.09
19193	1909.3	1.09	1.10

LTE Band 2, Channel Bandwidth 3MHz			
Channel	Frequency (MHz)	99% Occupied Bandwidth (MHz)	
		QPSK	16QAM
18615	1851.5	2.68	2.68
18900	1880.0	2.68	2.68
19185	1908.5	2.68	2.69

LTE Band 2, Channel Bandwidth 5MHz			
Channel	Frequency (MHz)	99% Occupied Bandwidth (MHz)	
		QPSK	16QAM
18625	1852.5	4.46	4.46
18900	1880.0	4.46	4.48
19175	1907.5	4.48	4.48

LTE Band 2, Channel Bandwidth 10MHz			
Channel	Frequency (MHz)	99% Occupied Bandwidth (MHz)	
		QPSK	16QAM
18650	1855.0	8.92	8.96
18900	1880.0	8.96	8.96
19150	1905.0	8.96	8.96

LTE Band 2, Channel Bandwidth 15MHz			
Channel	Frequency (MHz)	99% Occupied Bandwidth (MHz)	
		QPSK	16QAM
18675	1857.5	13.48	13.48
18900	1880.0	13.48	13.52
19125	1902.5	13.56	13.52

LTE Band 2, Channel Bandwidth 20MHz			
Channel	Frequency (MHz)	99% Occupied Bandwidth (MHz)	
		QPSK	16QAM
18700	1860.0	17.92	17.92
18900	1880.0	17.92	17.92
19100	1900.0	17.92	17.92

Spectrum Plot of Worst Value

1.4MHz / QPSK

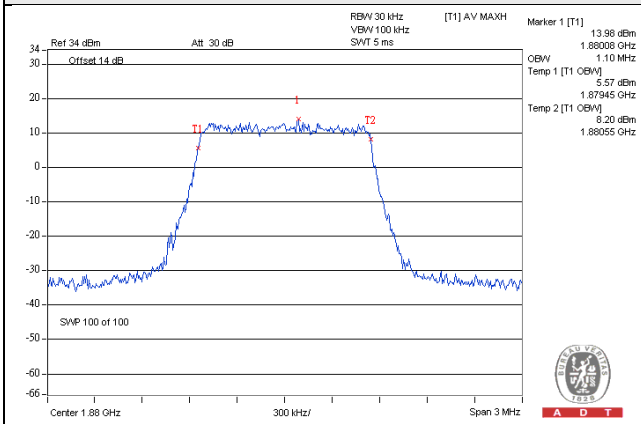

3MHz / QPSK

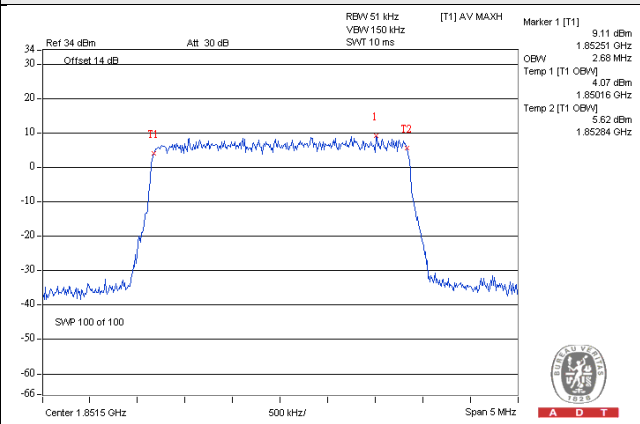

5MHz / QPSK

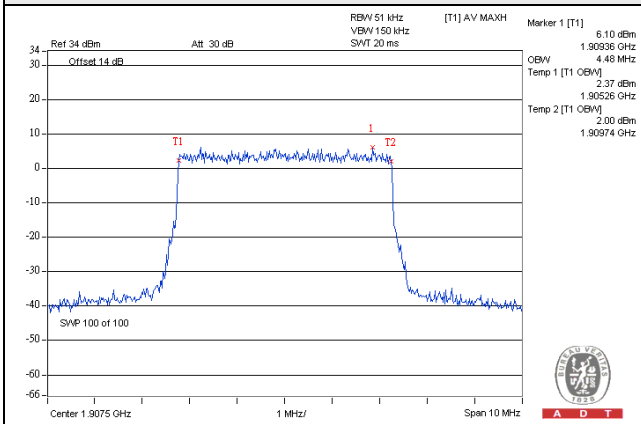

10MHz / QPSK

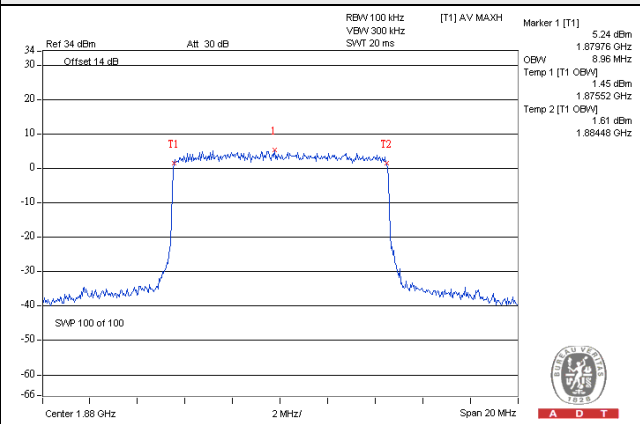

15MHz / QPSK

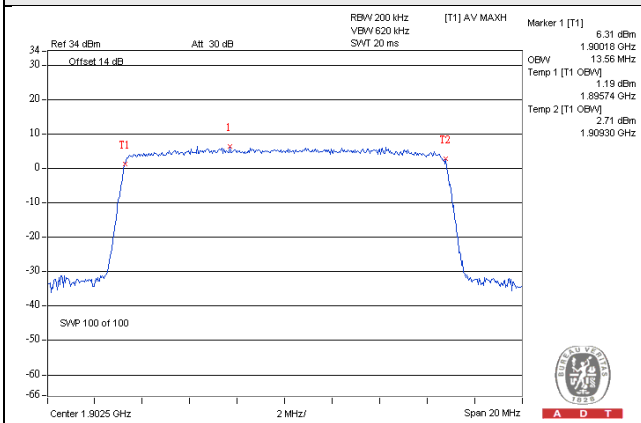

20MHz / QPSK

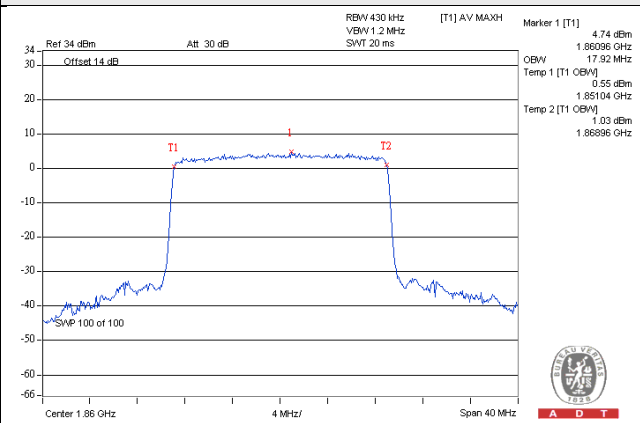

26dB Bandwidth

WCDMA Band 2				
Channel	Frequency (MHz)	26dBc Bandwidth (MHz)		
		WCDMA	HSDPA	HSUPA
9262	1852.4	4.676	4.666	4.683
9400	1880.0	4.676	4.679	4.697
9538	1907.6	4.693	4.682	4.662

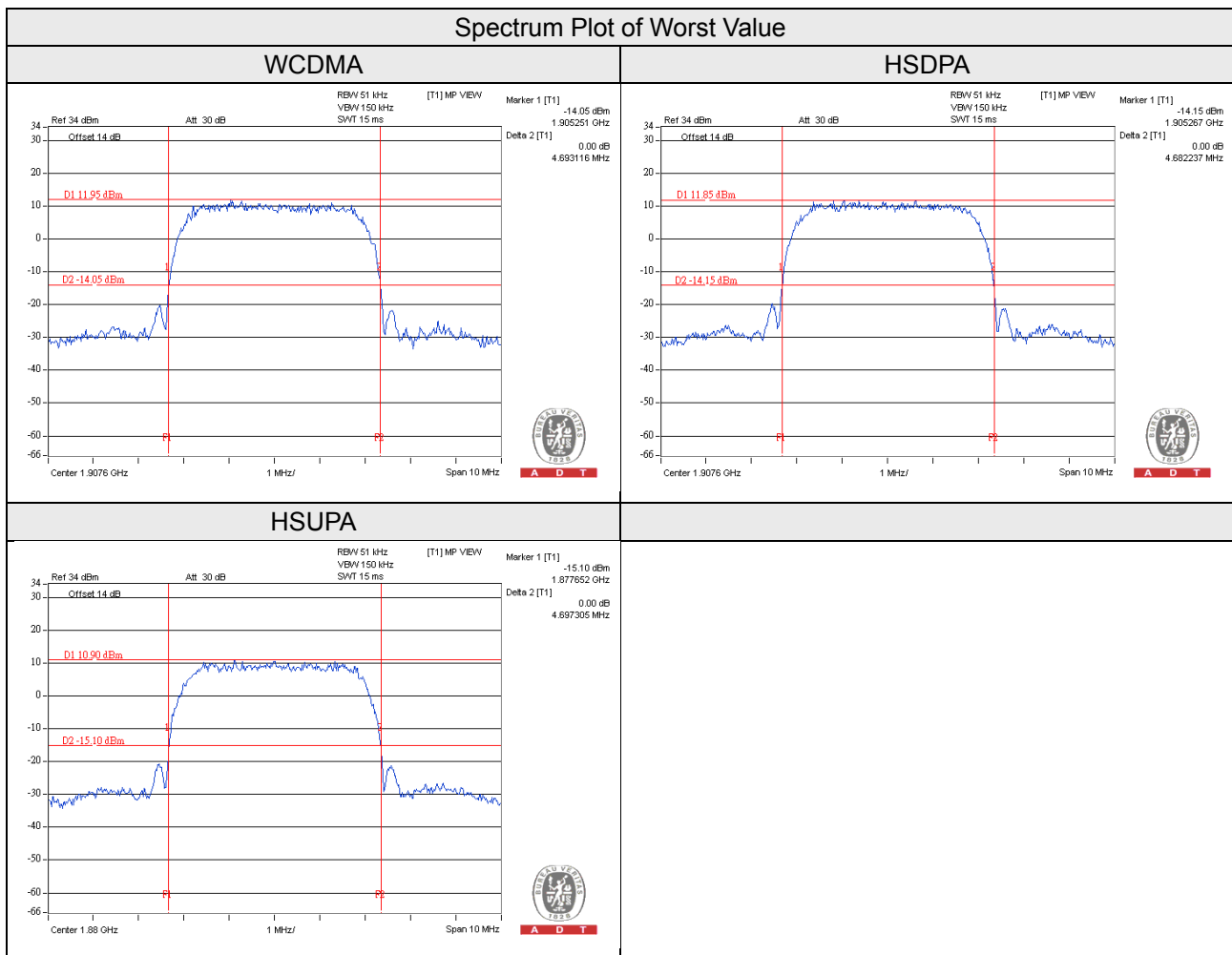

LTE Band 2, Channel Bandwidth 1.4MHz			
Channel	Frequency (MHz)	26dBc Bandwidth (MHz)	
		QPSK	16QAM
18607	1850.7	1.282	1.287
18900	1880.0	1.286	1.277
19193	1909.3	1.278	1.289

LTE Band 2, Channel Bandwidth 3MHz			
Channel	Frequency (MHz)	26dBc Bandwidth (MHz)	
		QPSK	16QAM
18615	1851.5	2.927	2.906
18900	1880.0	2.944	2.924
19185	1908.5	2.895	2.947

LTE Band 2, Channel Bandwidth 5MHz			
Channel	Frequency (MHz)	26dBc Bandwidth (MHz)	
		QPSK	16QAM
18625	1852.5	4.796	4.839
18900	1880.0	4.872	4.864
19175	1907.5	4.859	4.815

LTE Band 2, Channel Bandwidth 10MHz			
Channel	Frequency (MHz)	26dBc Bandwidth (MHz)	
		QPSK	16QAM
18650	1855.0	9.705	9.684
18900	1880.0	9.655	9.668
19150	1905.0	9.647	9.705

LTE Band 2, Channel Bandwidth 15MHz			
Channel	Frequency (MHz)	26dBc Bandwidth (MHz)	
		QPSK	16QAM
18675	1857.5	14.698	14.738
18900	1880.0	14.650	14.672
19125	1902.5	14.692	14.685

LTE Band 2, Channel Bandwidth 20MHz			
Channel	Frequency (MHz)	26dBc Bandwidth (MHz)	
		QPSK	16QAM
18700	1860.0	19.446	19.399
18900	1880.0	19.489	19.457
19100	1900.0	19.409	19.483

Spectrum Plot of Worst Value

1.4MHz / 16QAM

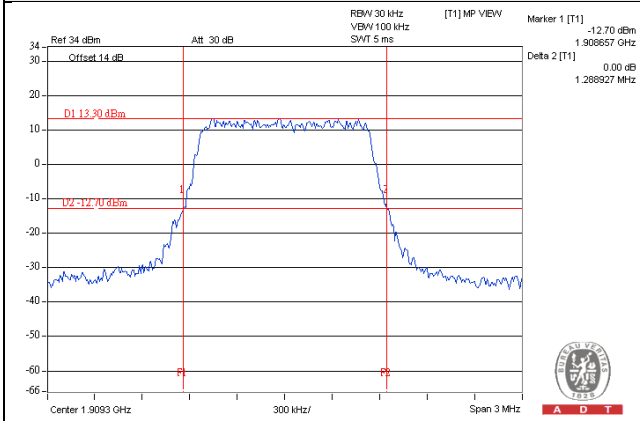

3MHz / 16QAM

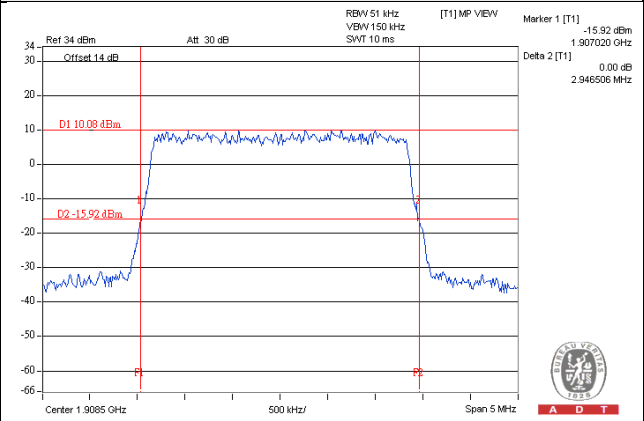

5MHz / QPSK

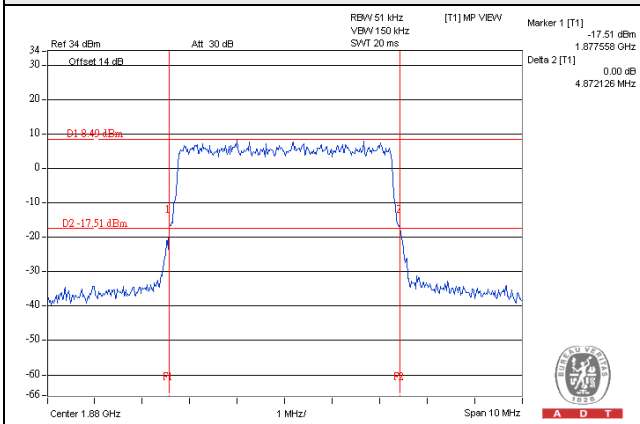

10MHz / QPSK

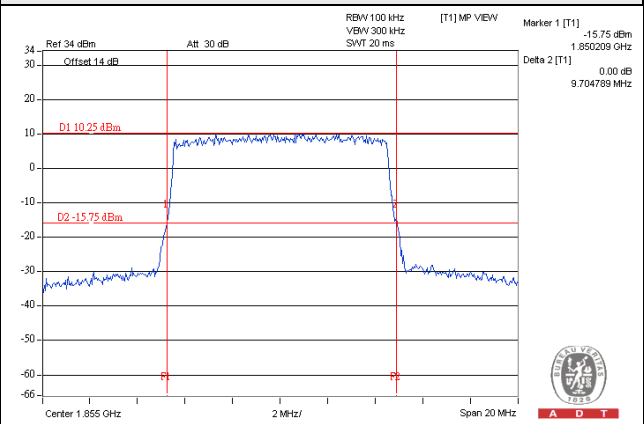

15MHz / 16QAM

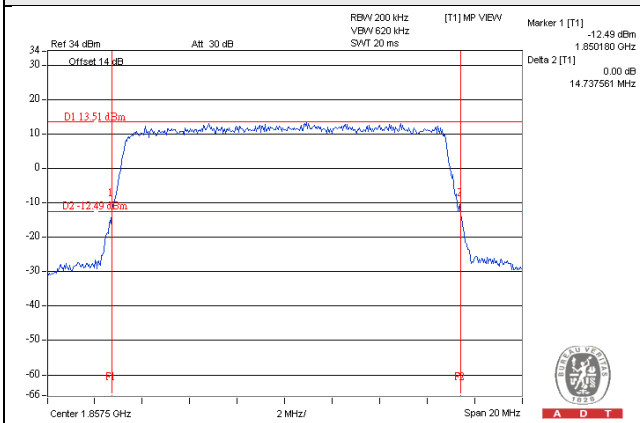

20MHz / QPSK

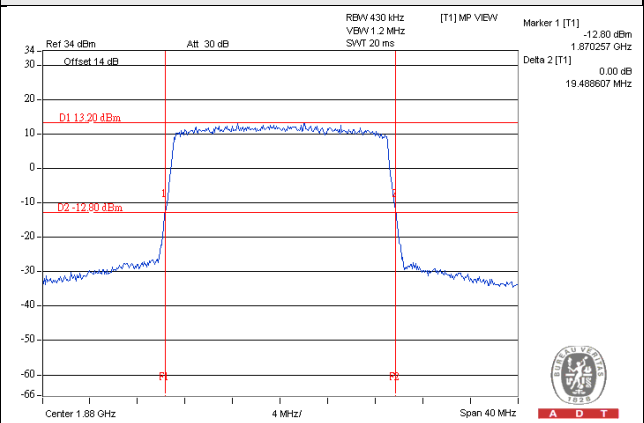

4.5 Band Edge Measurement

4.5.1 Limits of Band Edge Measurement

Power of any emission outside of the authorized operating frequency ranges must be attenuated below the transmitting power (P) by a factor of at least $43 + 10 \log(P)$ dB. In the 1 MHz bands immediately outside and adjacent to the frequency block a resolution bandwidth of at least one percent of the emission bandwidth of the fundamental emission of the transmitter may be employed.

4.5.2 Test Setup

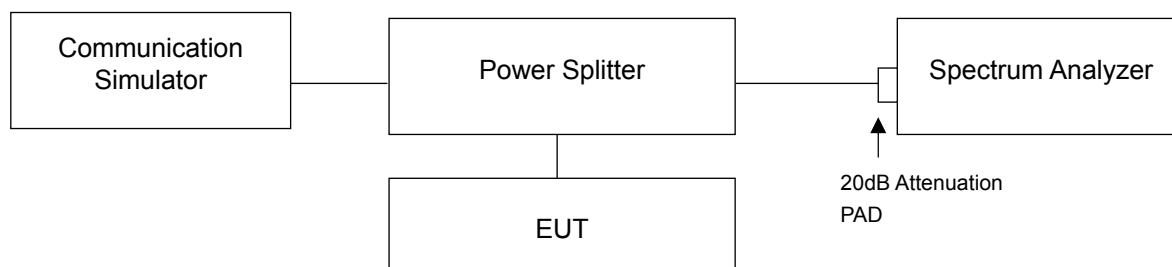

4.5.3 Test Procedures

- All measurements were done at low and high operational frequency range.
- The center frequency of spectrum is the band edge frequency and span is 1.5MHz. RB of the spectrum is 51kHz and VB of the spectrum is 150kHz (WCDMA / HSDPA / HSUPA).
- The center frequency of spectrum is the band edge frequency and span is 1.5MHz. RB of the spectrum is 30kHz and VB of the spectrum is 100kHz (LTE Channel Bandwidth 1.4MHz).
- The center frequency of spectrum is the band edge frequency and span is 1.5MHz. RB of the spectrum is 51kHz and VB of the spectrum is 150kHz (LTE Channel Bandwidth 3MHz and 5MHz).
- The center frequency of spectrum is the band edge frequency and span is 1.5MHz. RB of the spectrum is 100kHz and VB of the spectrum is 300kHz (LTE Channel Bandwidth 10MHz).
- The center frequency of spectrum is the band edge frequency and span is 1MHz. RB of the spectrum is 200kHz and VB of the spectrum is 620kHz (LTE Channel Bandwidth 15MHz).
- The center frequency of spectrum is the band edge frequency and span is 1MHz. RB of the spectrum is 430kHz and VB of the spectrum is 1200kHz (LTE Channel Bandwidth 20MHz).
- Record the max trace plot into the test report.

4.5.4 Test Results

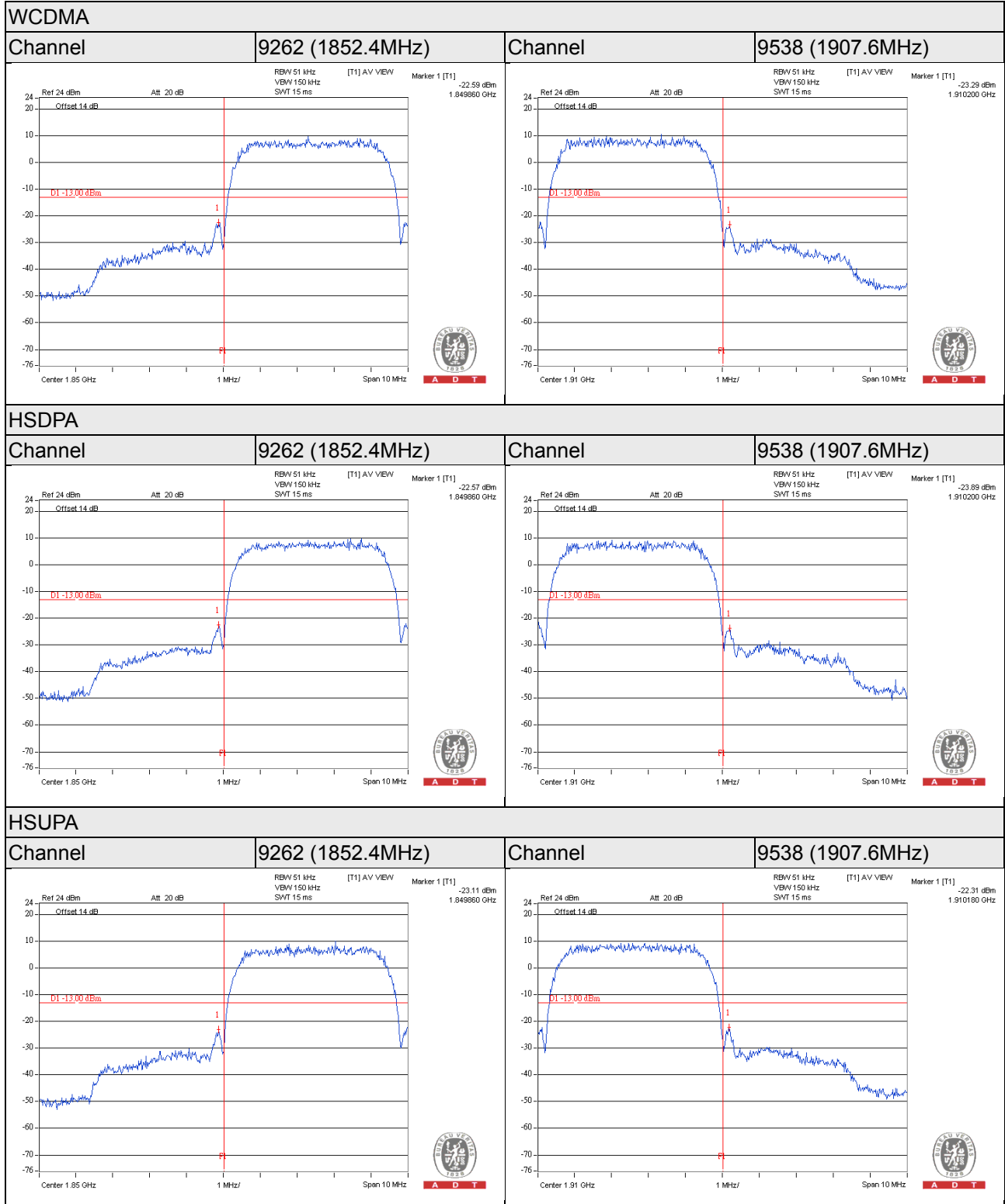

LTE Band 2, Channel Bandwidth 1.4MHz

**Channel 18607
(1850.70MHz)**

QPSK

1 RB / 0 RB Offset

**Channel 19193
(1909.30MHz)**

QPSK

1 RB / 5 RB Offset

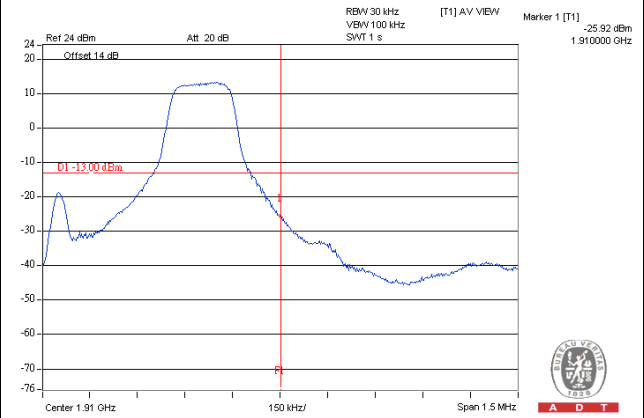
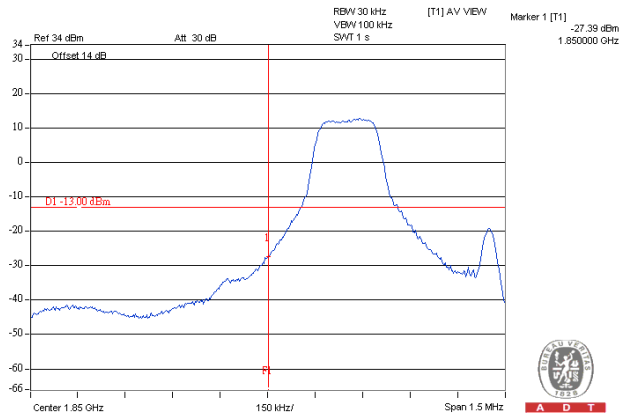

**Channel 18607
(1850.70MHz)**

QPSK

6 RB / 0 RB Offset

**Channel 19193
(1909.30MHz)**

QPSK

6 RB / 0 RB Offset

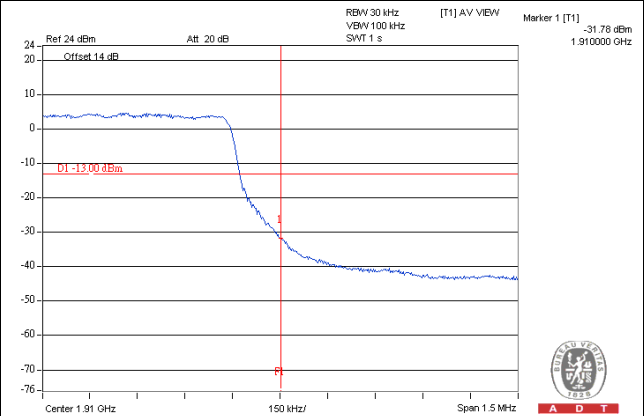
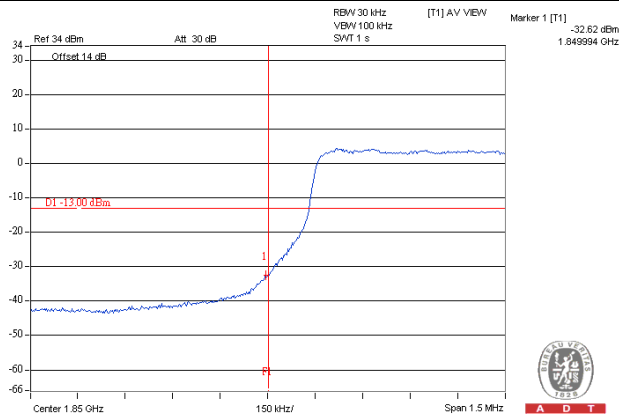

LTE Band 2, Channel Bandwidth 3MHz

Channel 18615 (1851.50MHz)	QPSK	1 RB / 0 RB Offset	Channel 19185 (1908.50MHz)	QPSK	1 RB / 14 RB Offset
---------------------------------------	-------------	---------------------------	---------------------------------------	-------------	----------------------------

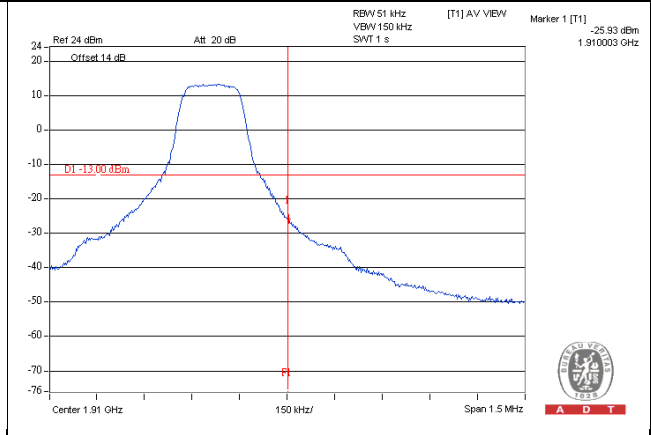
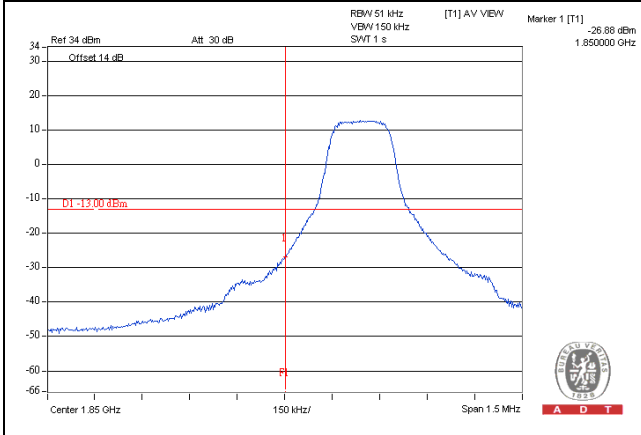

Channel 18615 (1851.50MHz)	QPSK	15 RB / 0 RB Offset	Channel 19185 (1908.50MHz)	QPSK	15 RB / 0 RB Offset
---------------------------------------	-------------	----------------------------	---------------------------------------	-------------	----------------------------

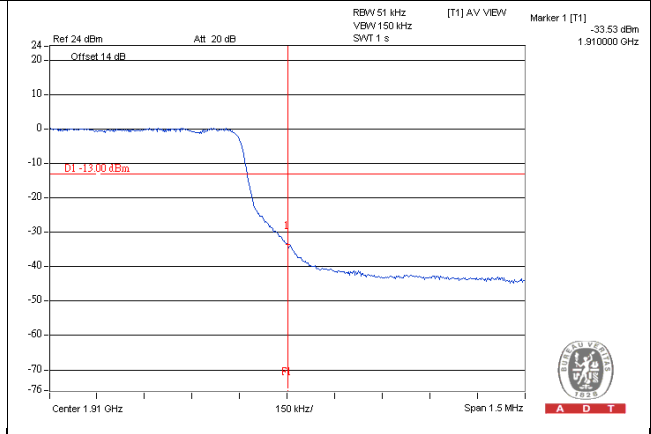
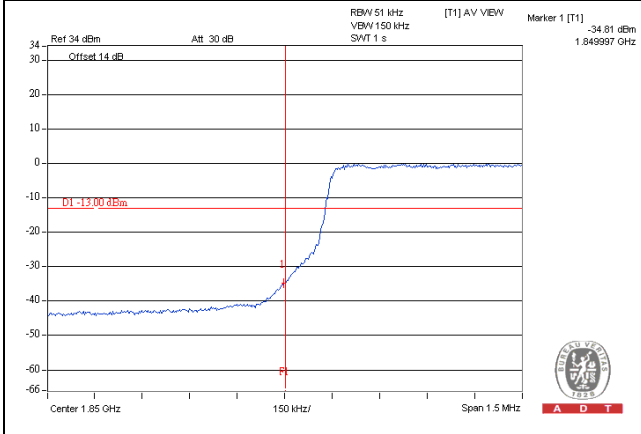

LTE Band 2, Channel Bandwidth 5MHz

Channel 18625 (1852.50MHz)	QPSK	1 RB / 0 RB Offset	Channel 19175 (1907.50MHz)	QPSK	1 RB / 24 RB Offset
---------------------------------------	-------------	---------------------------	---------------------------------------	-------------	----------------------------

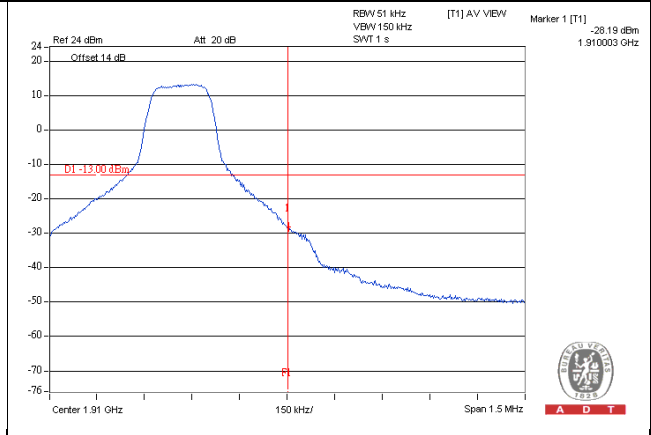
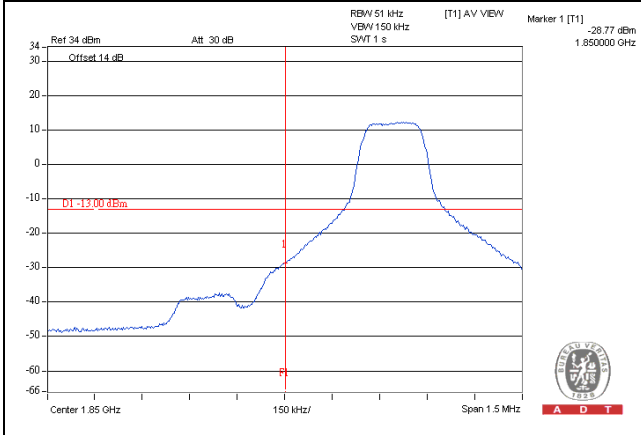

Channel 18625 (1852.50MHz)	QPSK	25 RB / 0 RB Offset	Channel 19175 (1907.50MHz)	QPSK	25 RB / 0 RB Offset
---------------------------------------	-------------	----------------------------	---------------------------------------	-------------	----------------------------

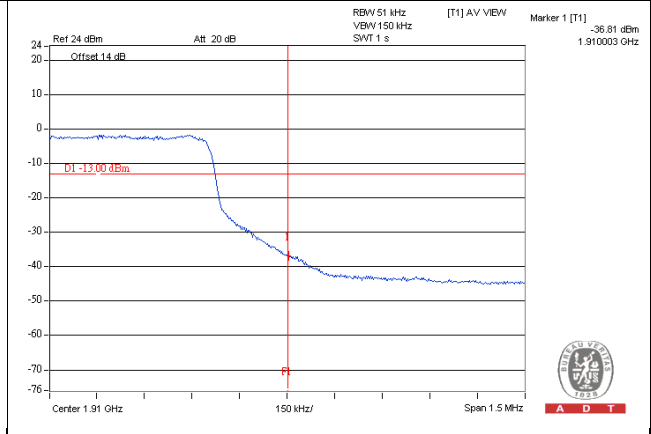
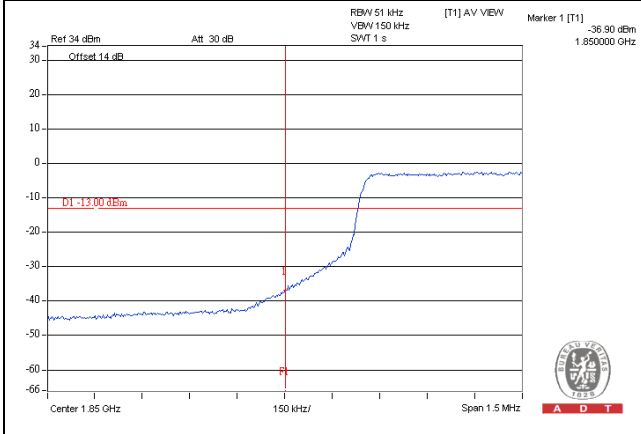

LTE Band 2, Channel Bandwidth 10MHz

Channel 18650 (1855.00MHz)	QPSK	1 RB / 0 RB Offset	Channel 19150 (1905.00MHz)	QPSK	1 RB / 49 RB Offset
---------------------------------------	-------------	---------------------------	---------------------------------------	-------------	----------------------------

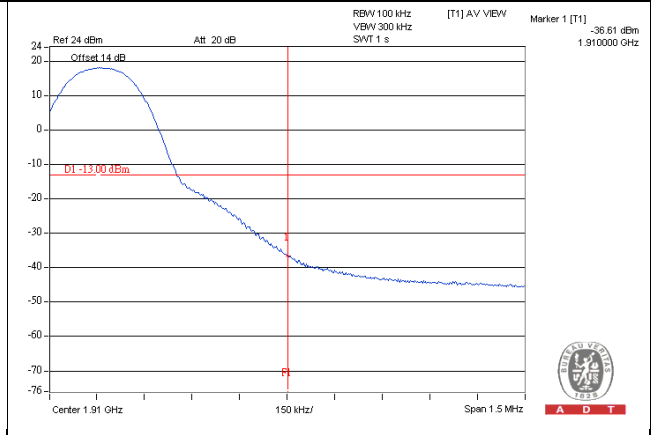
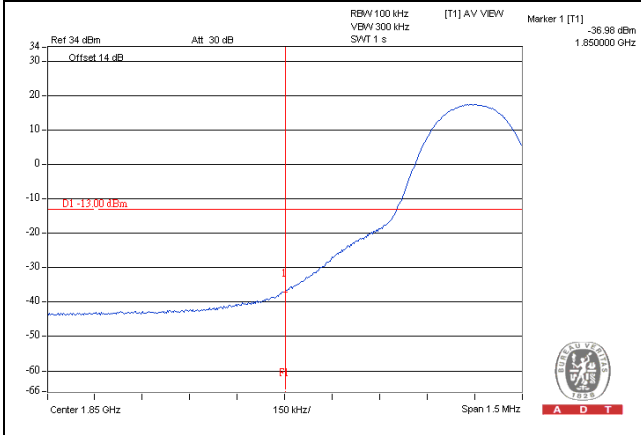

Channel 18650 (1855.00MHz)	QPSK	50 RB / 0 RB Offset	Channel 19150 (1905.00MHz)	QPSK	50 RB / 0 RB Offset
---------------------------------------	-------------	----------------------------	---------------------------------------	-------------	----------------------------

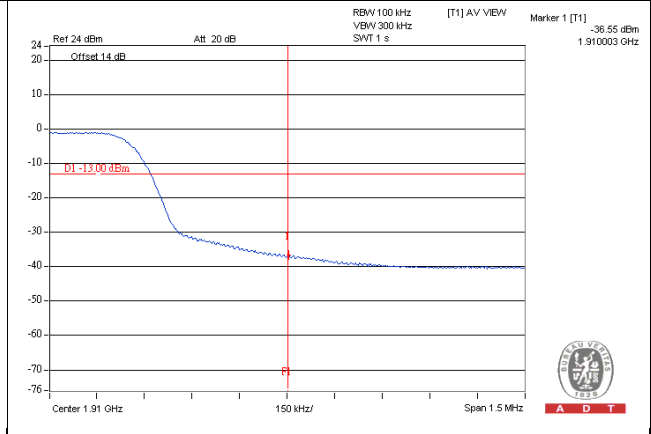
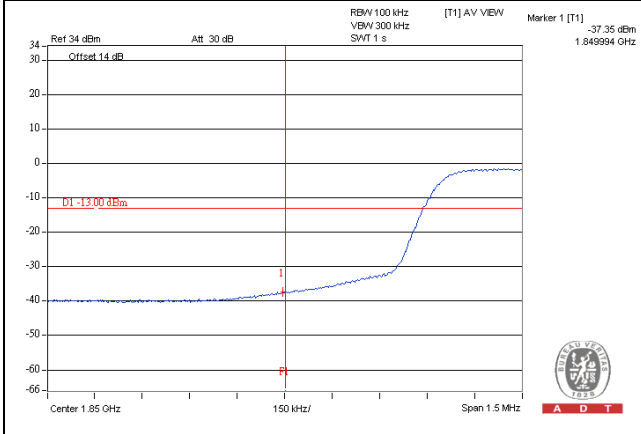

LTE Band 2, Channel Bandwidth 15MHz

**Channel 18675
(1857.50MHz)**

QPSK

1 RB / 0 RB Offset

**Channel 19125
(1902.50MHz)**

QPSK

1 RB / 74 RB Offset

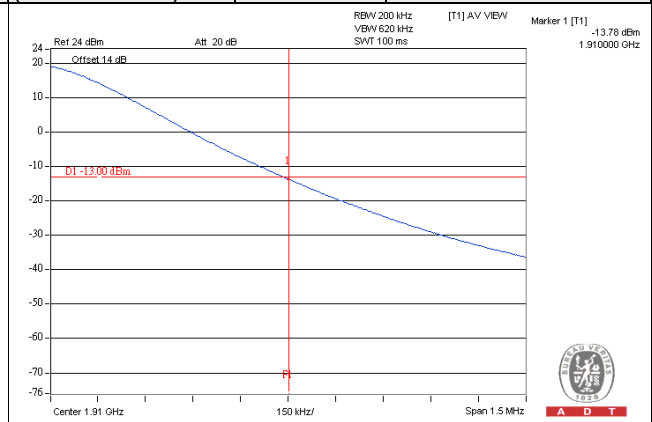
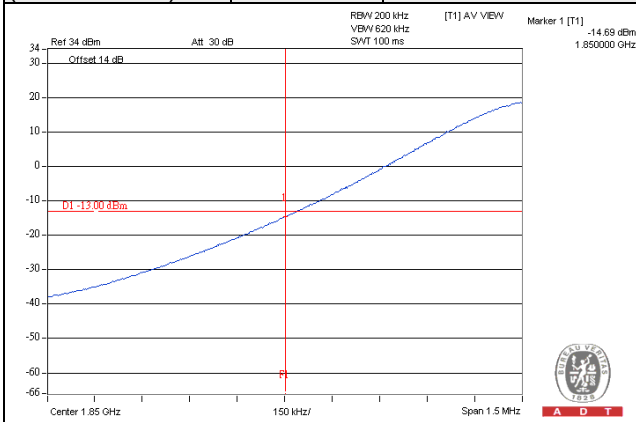

**Channel 18675
(1857.50MHz)**

QPSK

75 RB / 0 RB Offset

**Channel 19125
(1902.50MHz)**

QPSK

75 RB / 0 RB Offset

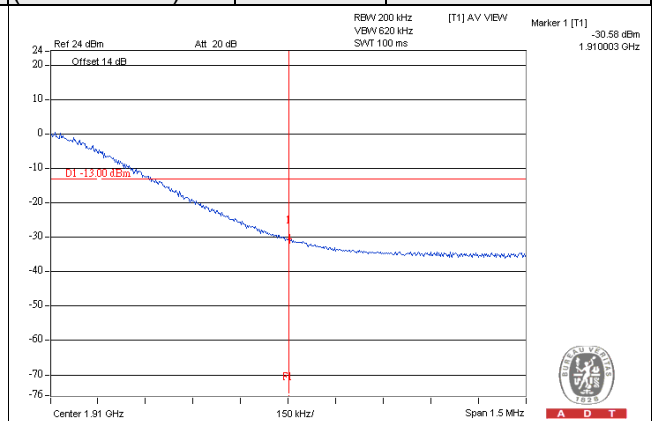
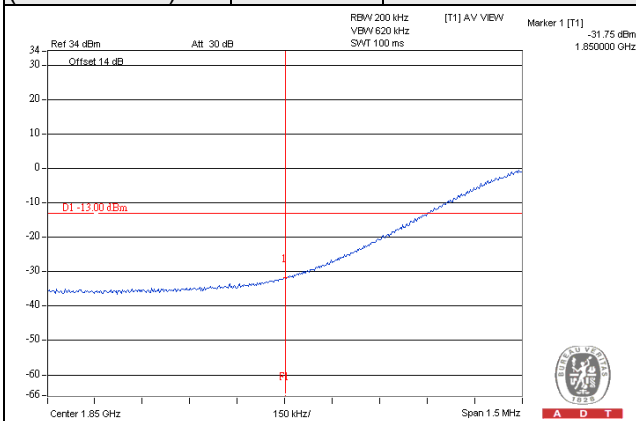

LTE Band 2, Channel Bandwidth 20MHz

**Channel 18700
(1860.00MHz)**

QPSK

1 RB / 0 RB Offset

**Channel 19100
(1900.00 MHz)**

QPSK

1 RB / 99 RB Offset

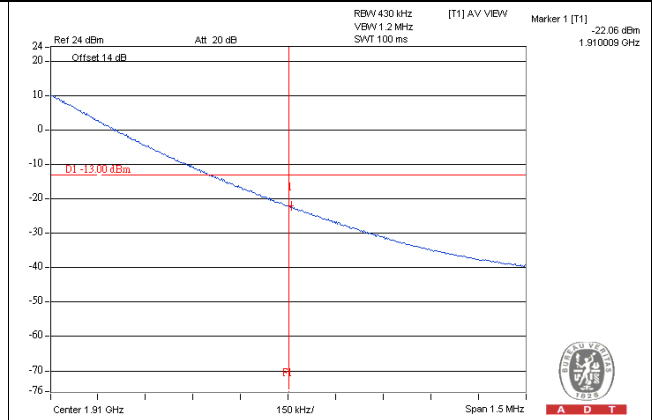
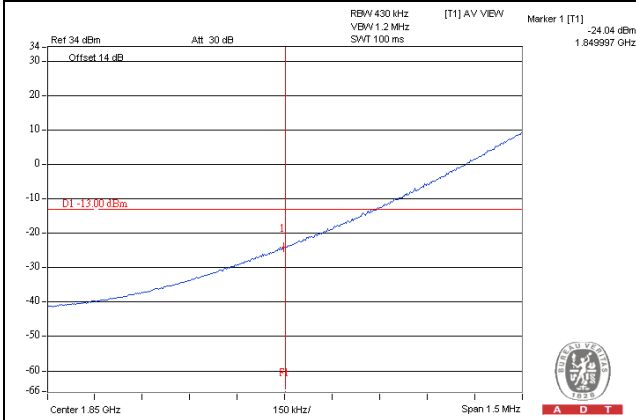

**Channel 18700
(1860.00MHz)**

QPSK

100 RB / 0 RB Offset

**Channel 19100
(1900.00 MHz)**

QPSK

100 RB / 0 RB Offset

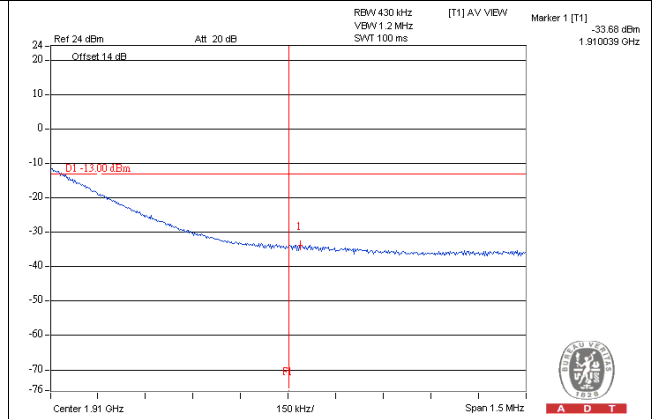
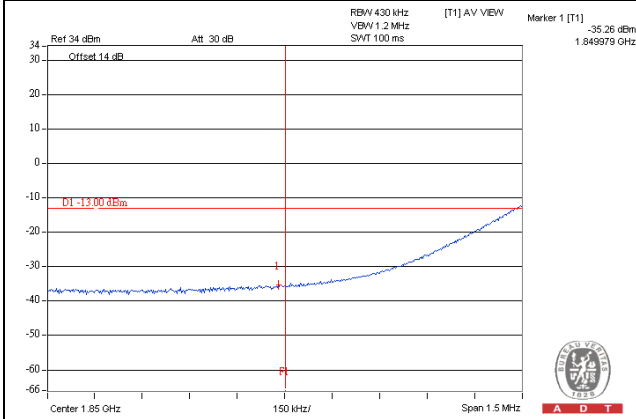

4.6 Peak to Average Ratio

4.6.1 Limits of Peak to Average Ratio Measurement

In measuring transmissions in this band using an average power technique, the peak to-average ratio (PAR) of the transmission may not exceed 13 dB

4.6.2 Test Setup

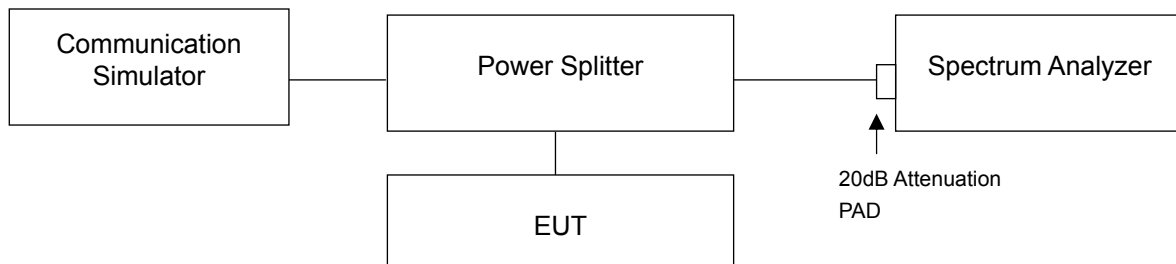

4.6.3 Test Procedures

- Set resolution/measurement bandwidth \geq signal's occupied bandwidth;
- Set the number of counts to a value that stabilizes the measured CCDF curve;
- Record the maximum PAPR level associated with a probability of 0.1%.

4.6.4 Test Results

WCDMA Band 2				
Channel	Frequency (MHz)	Peak To Average Ratio (dB)		
		WCDMA	HSDPA	HSUPA
9262	1852.4	3.31	3.31	3.31
9400	1880.0	3.15	3.15	3.15
9538	1907.6	3.14	3.15	3.15

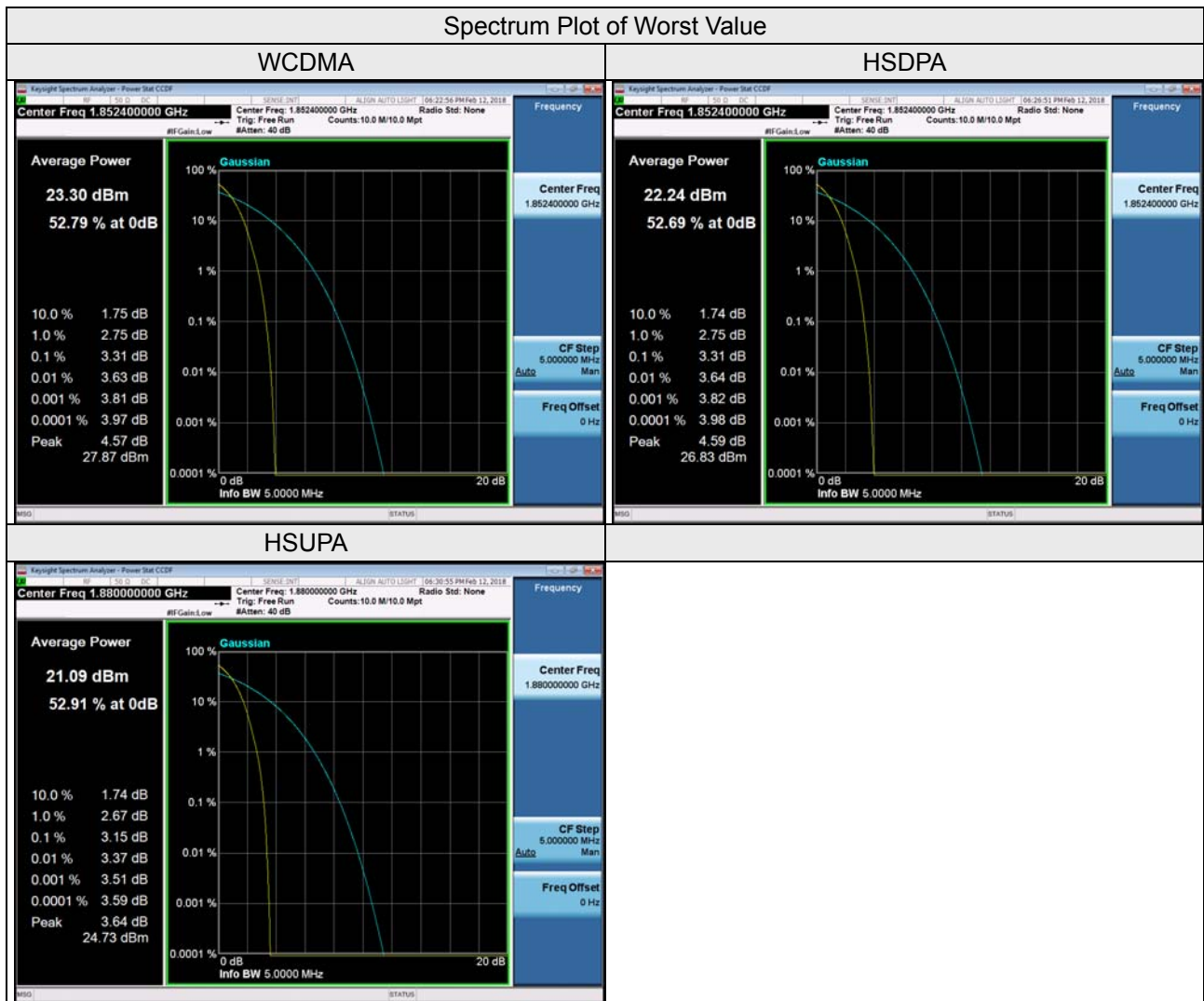

LTE Band 2, Channel Bandwidth 1.4MHz			
Channel	Frequency (MHz)	Peak To Average Ratio (dB)	
		QPSK	16QAM
18607	1850.7	4.71	4.79
18900	1880.0	4.56	4.59
19193	1909.3	4.61	4.61

LTE Band 2, Channel Bandwidth 3MHz			
Channel	Frequency (MHz)	Peak To Average Ratio (dB)	
		QPSK	16QAM
18615	1851.5	5.43	5.48
18900	1880.0	5.35	5.38
19185	1908.5	5.42	5.41

LTE Band 2, Channel Bandwidth 5MHz			
Channel	Frequency (MHz)	Peak To Average Ratio (dB)	
		QPSK	16QAM
18625	1852.5	5.44	5.40
18900	1880.0	5.37	5.33
19175	1907.5	5.32	5.35

LTE Band 2, Channel Bandwidth 10MHz			
Channel	Frequency (MHz)	Peak To Average Ratio (dB)	
		QPSK	16QAM
18650	1855.0	5.49	5.49
18900	1880.0	5.36	5.31
19150	1905.0	5.29	5.30

LTE Band 2, Channel Bandwidth 15MHz			
Channel	Frequency (MHz)	Peak To Average Ratio (dB)	
		QPSK	16QAM
18675	1857.5	5.39	5.37
18900	1880.0	5.25	5.25
19125	1902.5	5.15	5.15

LTE Band 2, Channel Bandwidth 20MHz			
Channel	Frequency (MHz)	Peak To Average Ratio (dB)	
		QPSK	16QAM
18700	1860.0	5.38	5.39
18900	1880.0	5.22	5.24
19100	1900.0	5.20	5.21

Spectrum Plot of Worst Value

1.4MHz / 16QAM

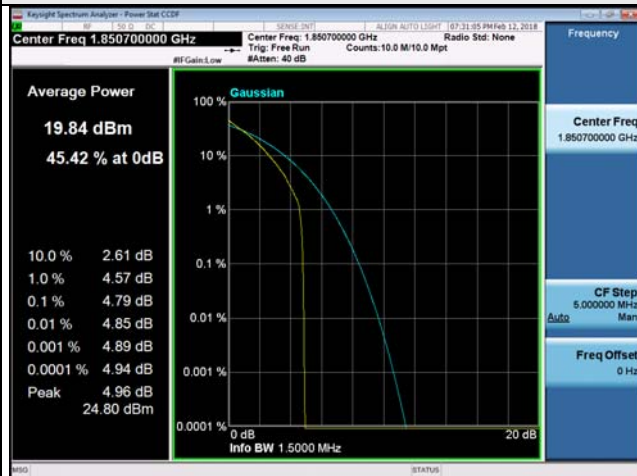

3MHz / 16QAM

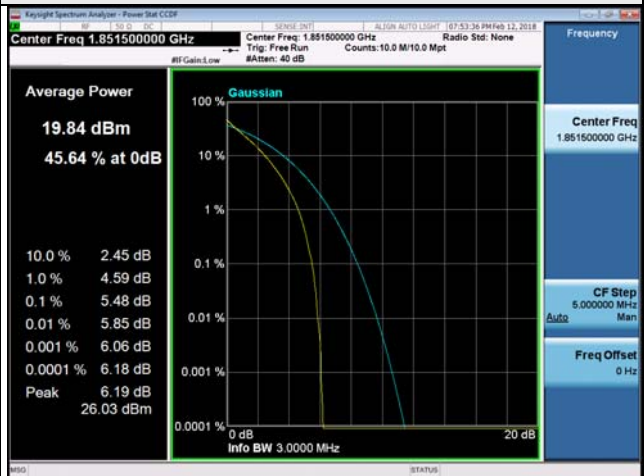

5MHz / QPSK

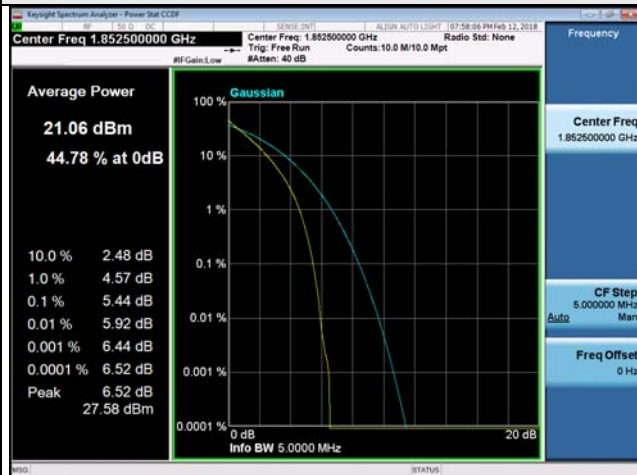

10MHz / QPSK

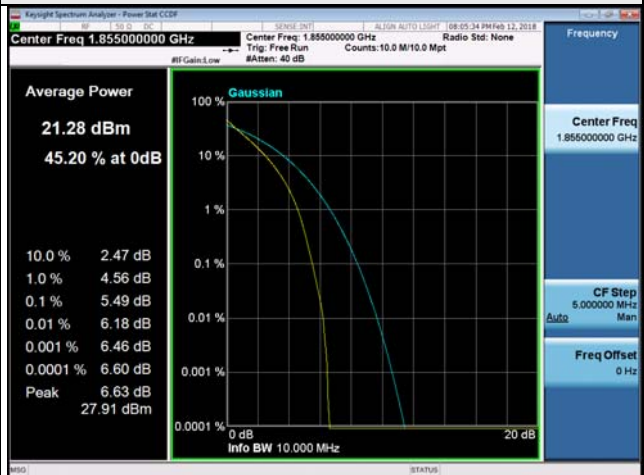

15MHz / QPSK

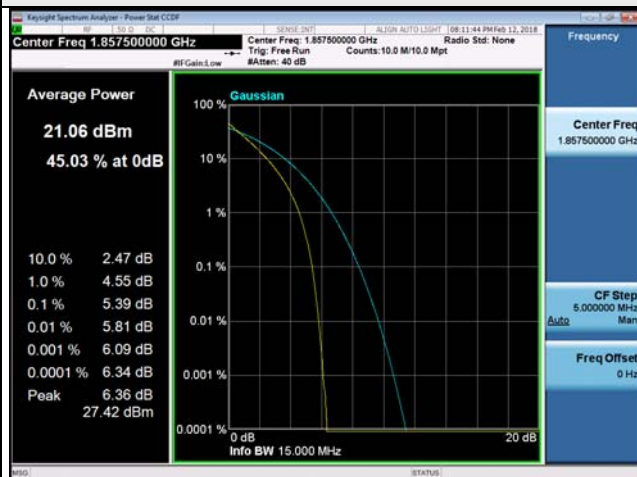

20MHz / 16QAM

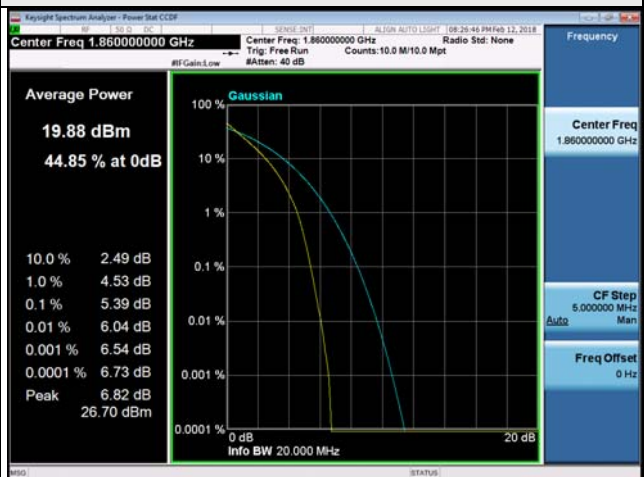

4.7 Conducted Spurious Emissions

4.7.1 Limits of Conducted Spurious Emissions Measurement

The power of any emission outside of the authorized operating frequency ranges must be attenuated below the transmitting power (P) by a factor of at least $43 + 10 \log(P)$ dB. The emission limit equal to -13dBm .

4.7.2 Test Setup

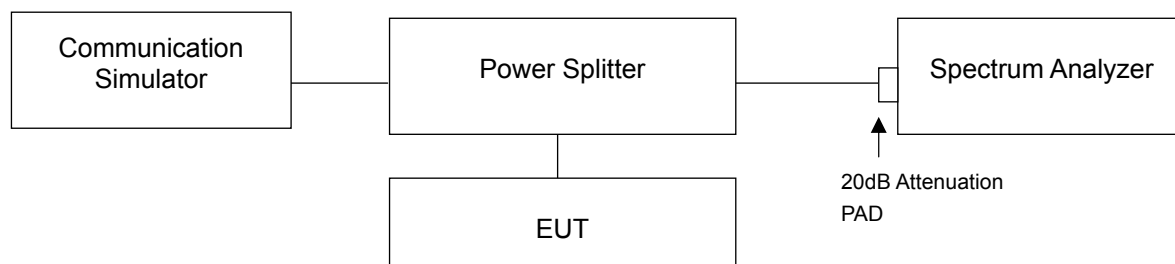

4.7.3 Test Procedure

- The EUT makes a phone call to the communication simulator. All measurements were done at low, middle and high operational frequency range.
- Measuring frequency range is from 9 kHz to 1GHz. 20dB attenuation pad is connected with spectrum. RBW=100kHz and VBW=300kHz is used for conducted emission measurement.
- Measuring frequency range is from 1GHz to 26.5GHz. 20dB attenuation pad is connected with spectrum. RBW=1MHz and VBW=3MHz is used for conducted emission measurement.

4.7.4 Test Results

WCDMA

Channel 9262 (1852.4MHz)

Frequency Range : 9kHz~1GHz

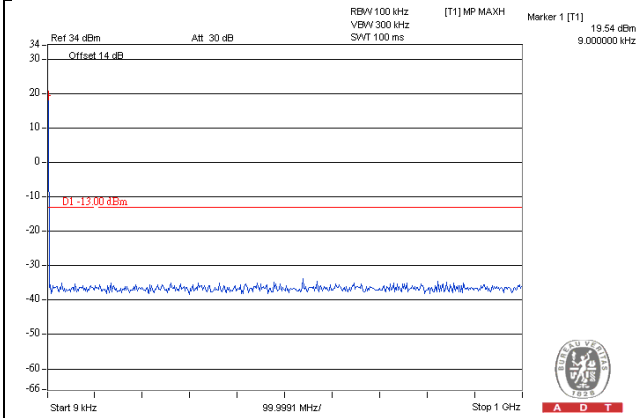

Frequency Range : 1GHz~10GHz

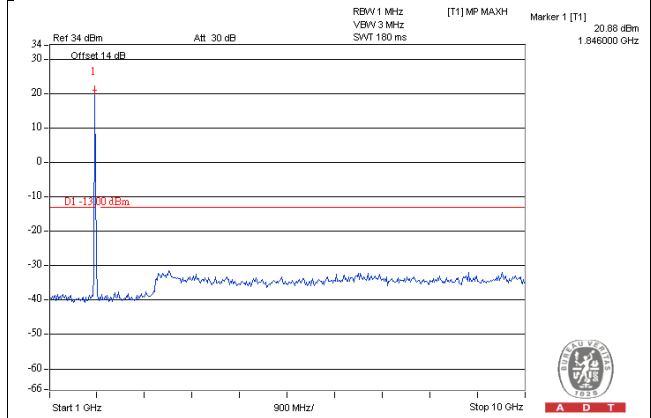

Frequency Range : 10GHz~26.5GHz

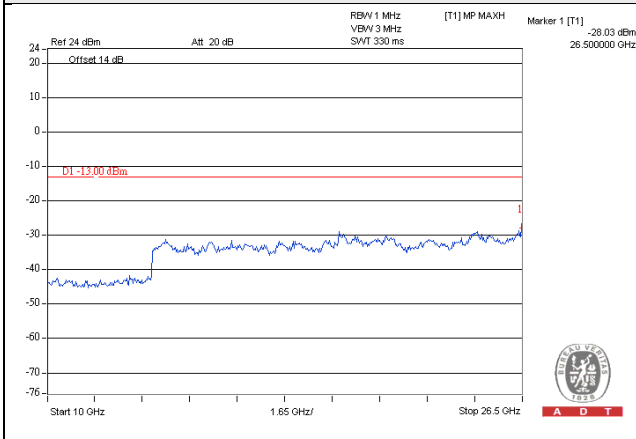

WCDMA

Channel 9400 (1880.0MHz)

Frequency Range : 9kHz~1GHz

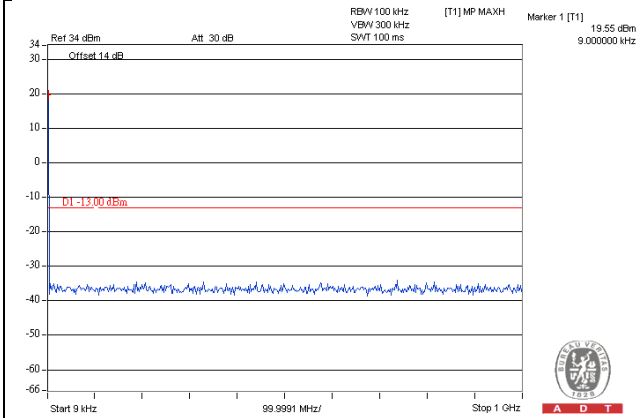

Frequency Range : 1GHz~10GHz

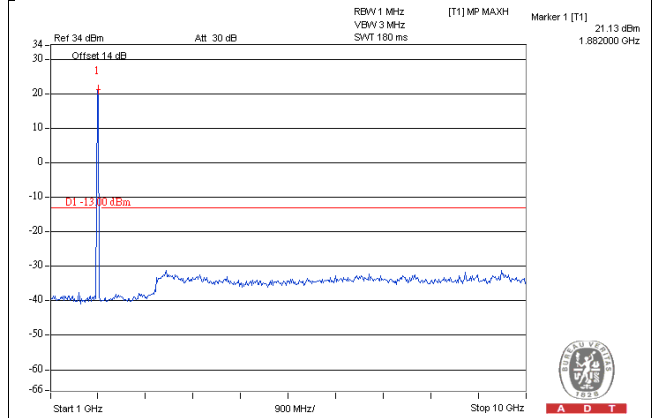

Frequency Range : 10GHz~26.5GHz

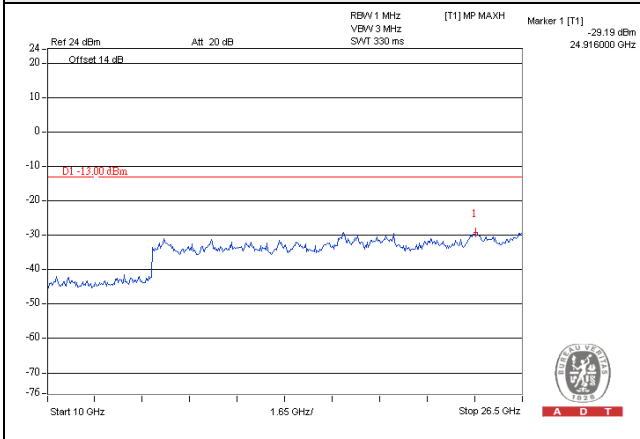

WCDMA

Channel 9538 (1907.6MHz)

Frequency Range : 9kHz~1GHz

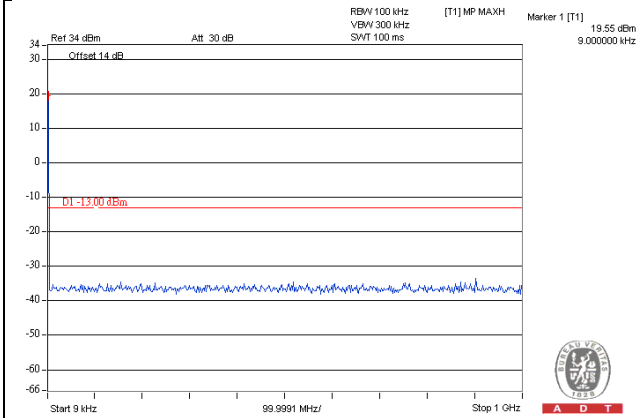

Frequency Range : 1GHz~10GHz

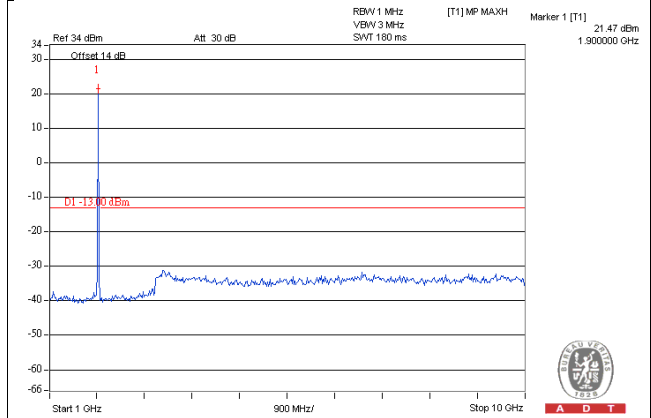

Frequency Range : 10GHz~26.5GHz

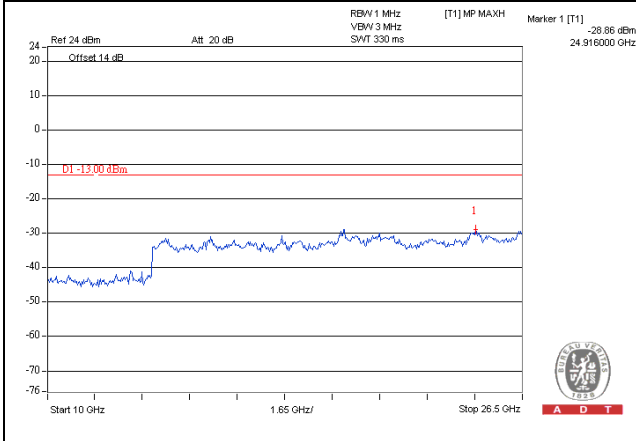

HSDPA

Channel 9262 (1852.4MHz)

Frequency Range : 9kHz~1GHz

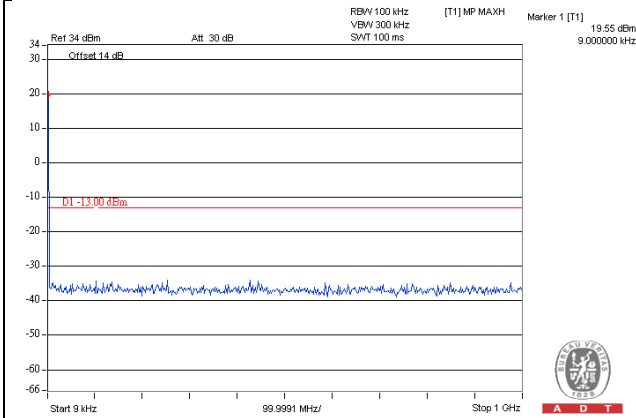

Frequency Range : 1GHz~10GHz

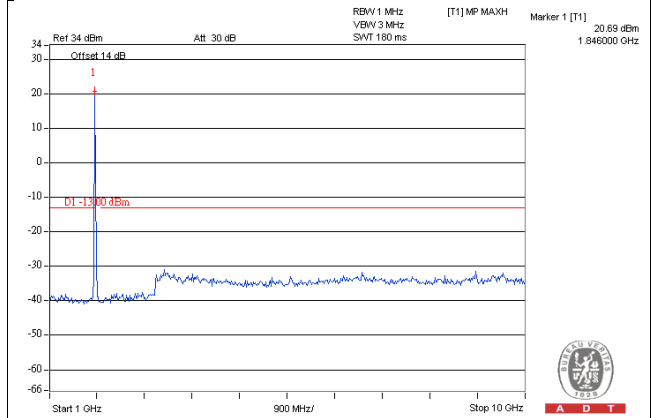

Frequency Range : 10GHz~26.5GHz

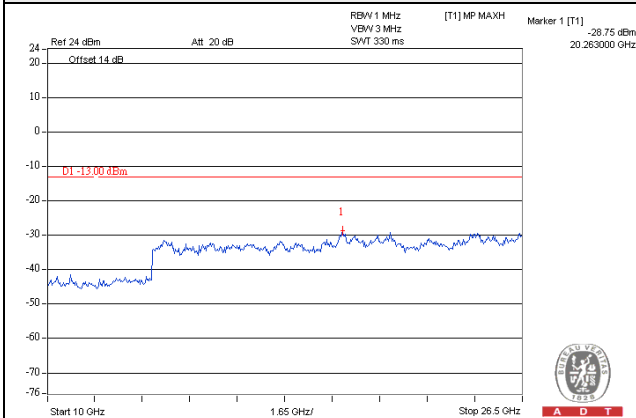

HSDPA

Channel 9400 (1880.0MHz)

Frequency Range : 9kHz~1GHz

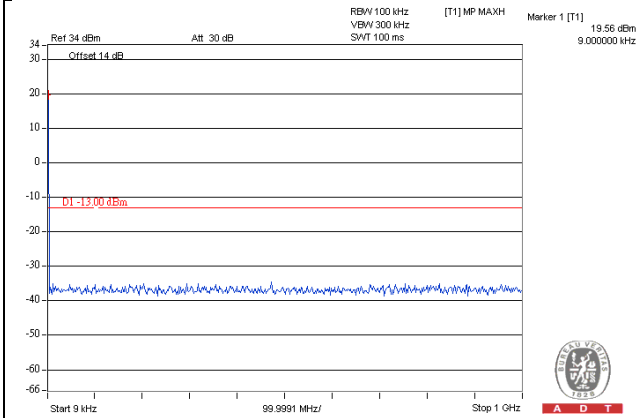

Frequency Range : 1GHz~10GHz

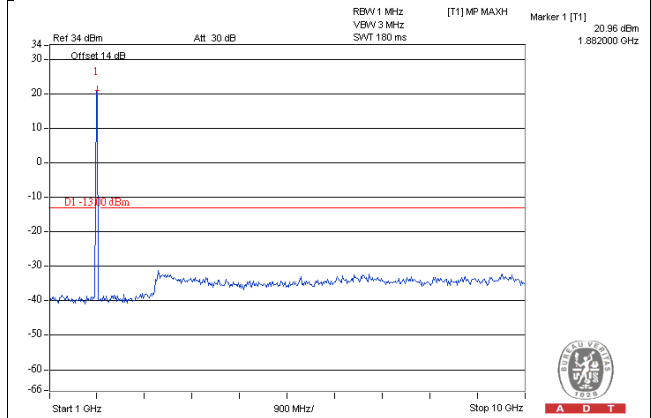

Frequency Range : 10GHz~26.5GHz

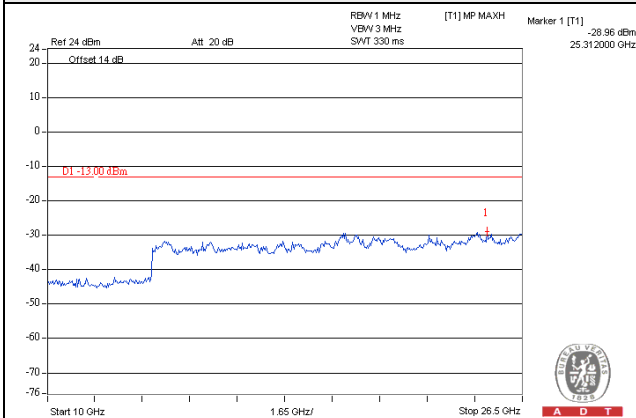

HSDPA

Channel 9538 (1907.6MHz)

Frequency Range : 9kHz~1GHz

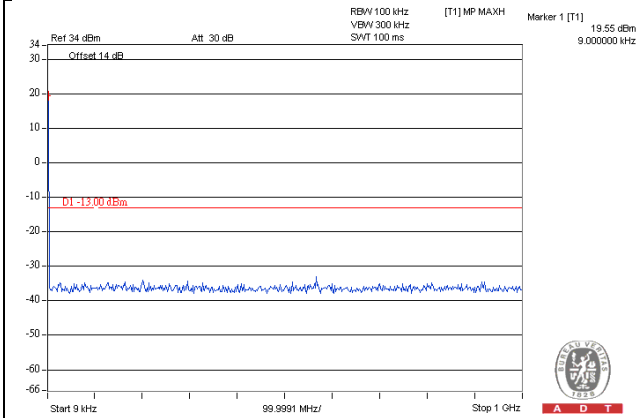

Frequency Range : 1GHz~10GHz

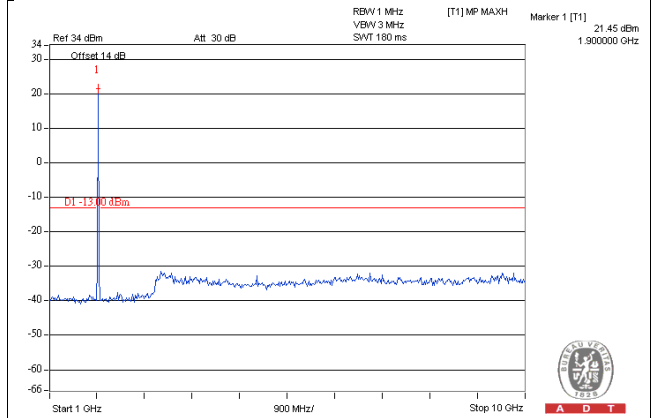

Frequency Range : 10GHz~26.5GHz

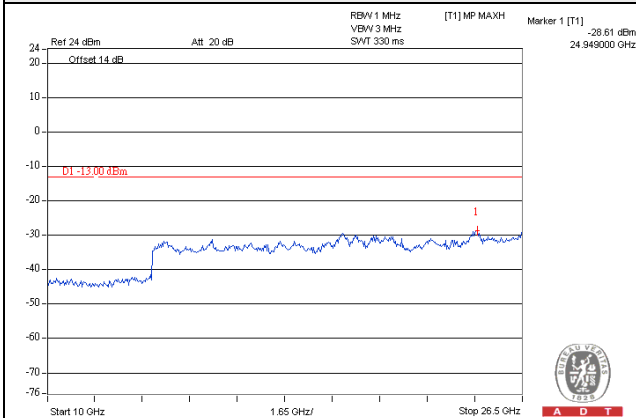

HSUPA

Channel 9262 (1852.4MHz)

Frequency Range : 9kHz~1GHz

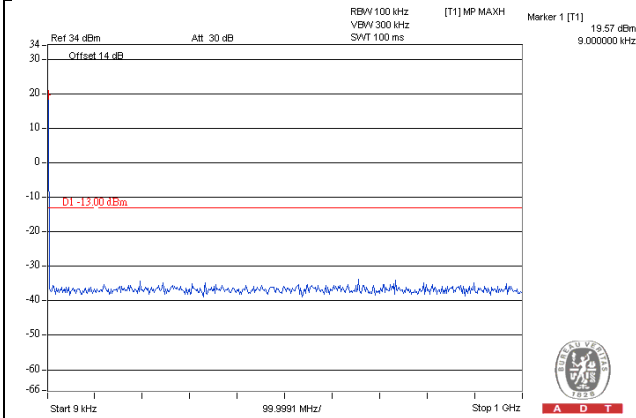

Frequency Range : 1GHz~10GHz

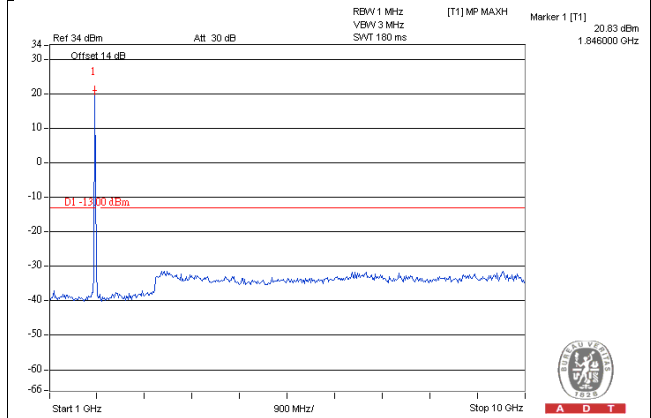

Frequency Range : 10GHz~26.5GHz

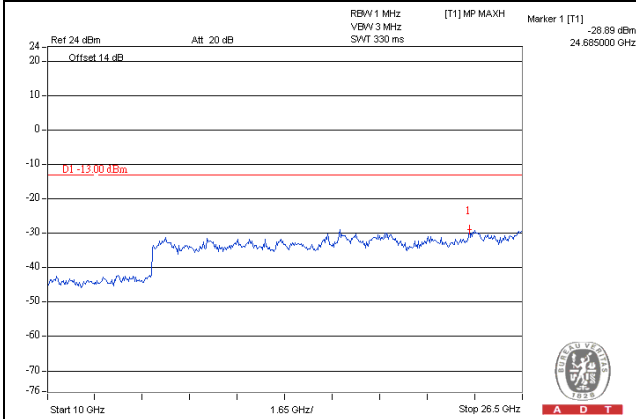

HSUPA

Channel 9400 (1880.0MHz)

Frequency Range : 9kHz~1GHz

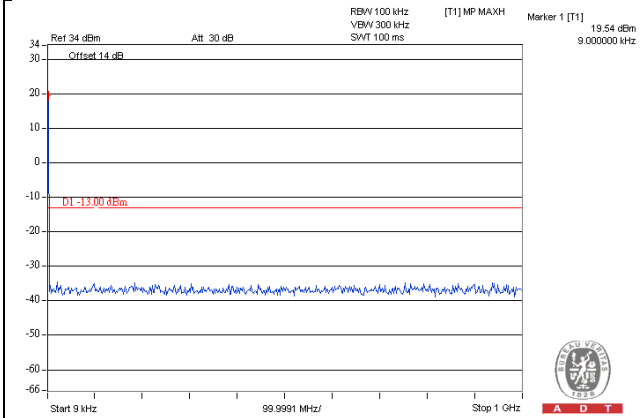

Frequency Range : 1GHz~10GHz

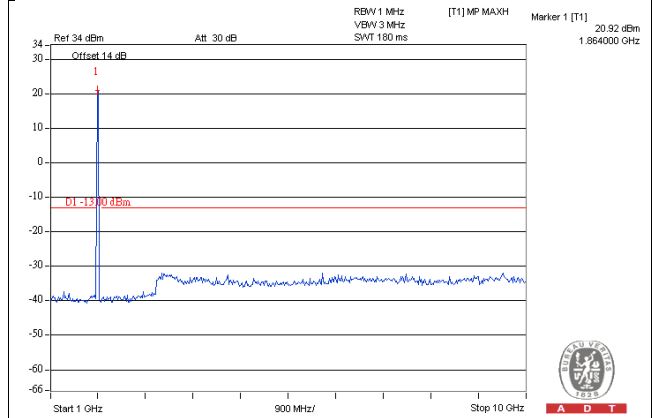

Frequency Range : 10GHz~26.5GHz

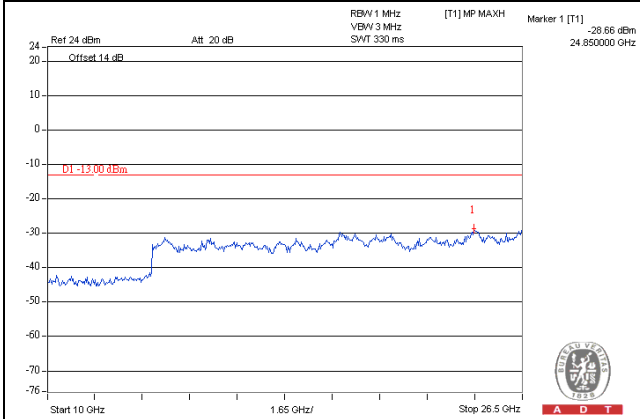

HSUPA

Channel 9538 (1907.6MHz)

Frequency Range : 9kHz~1GHz

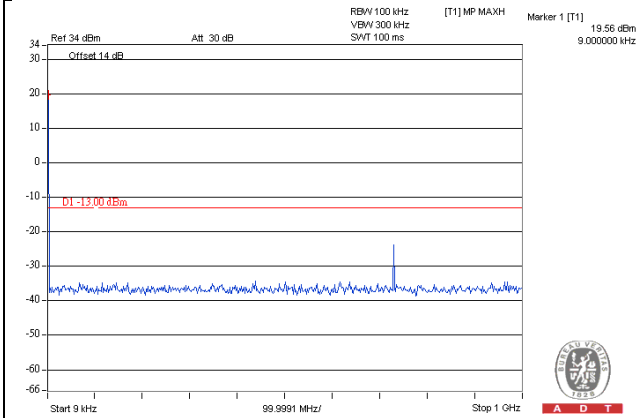

Frequency Range : 1GHz~10GHz

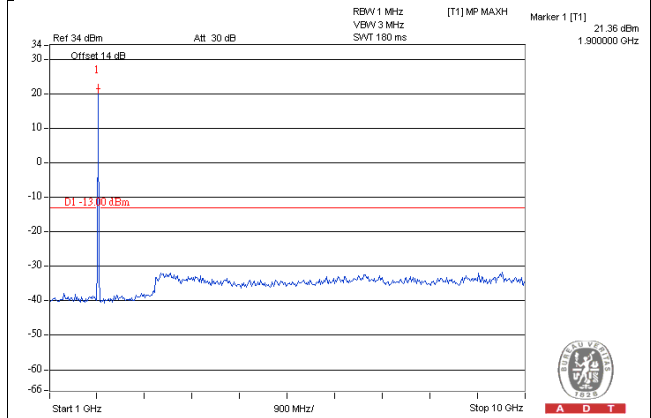

Frequency Range : 10GHz~26.5GHz

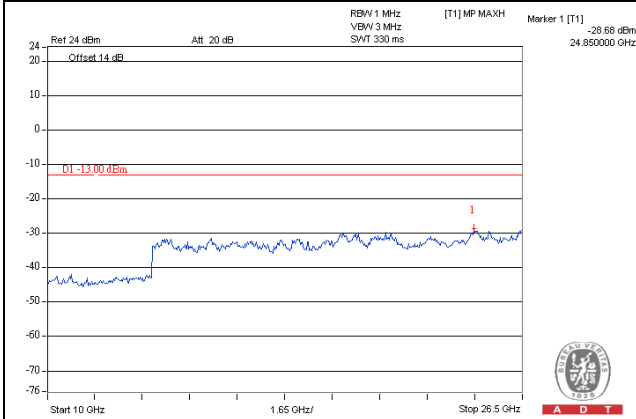

LTE Band 2, Channel Bandwidth 1.4MHz

Channel 18607 (1850.70MHz)

Frequency Range : 9kHz~1GHz

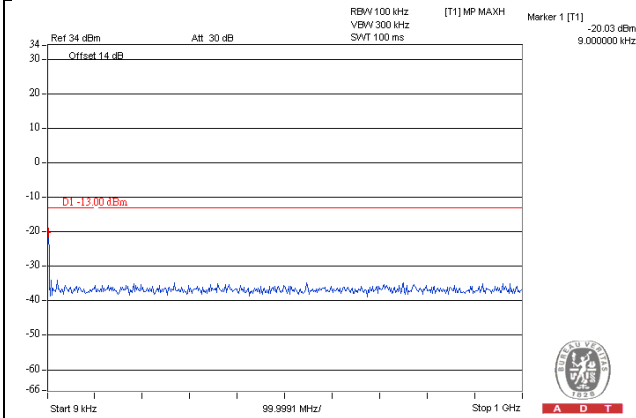

Frequency Range : 1GHz~10GHz

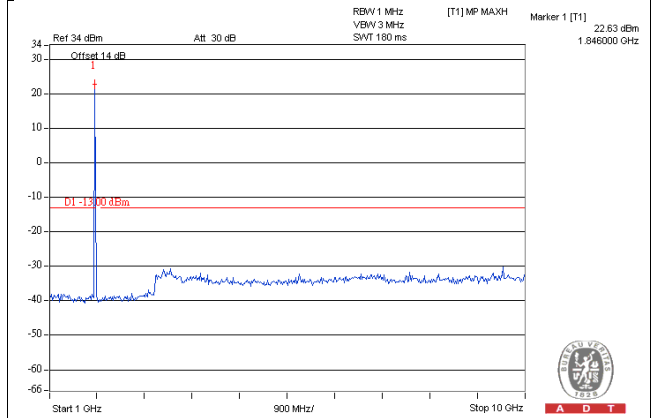

Frequency Range : 10GHz~26.5GHz

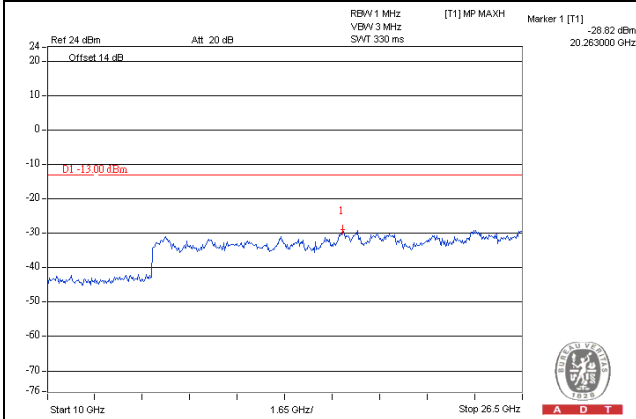

LTE Band 2, Channel Bandwidth 1.4MHz

Channel 18900 (1880.00MHz)

Frequency Range : 9kHz~1GHz

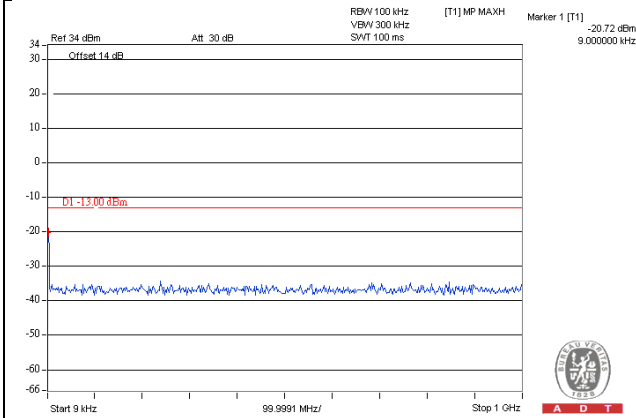

Frequency Range : 1GHz~10GHz

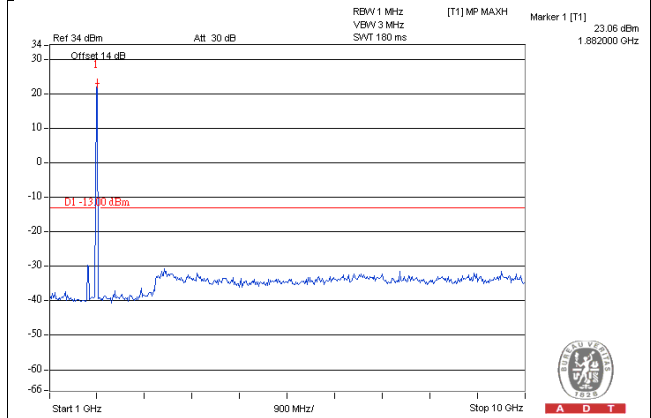

Frequency Range : 10GHz~26.5GHz

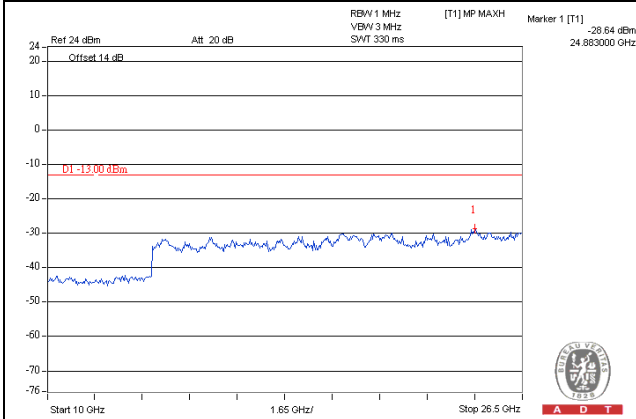

LTE Band 2, Channel Bandwidth 1.4MHz

Channel 19193 (1909.30MHz)

Frequency Range : 9kHz~1GHz

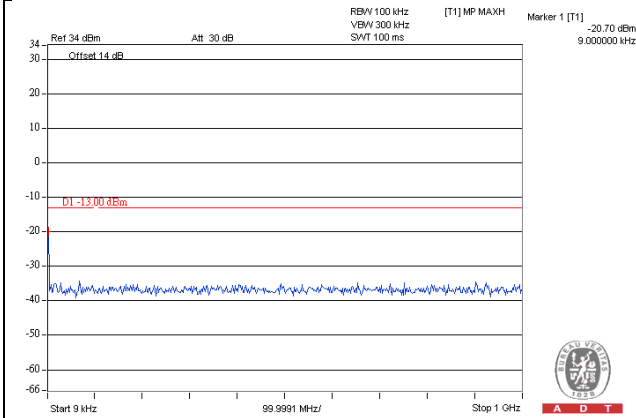

Frequency Range : 1GHz~10GHz

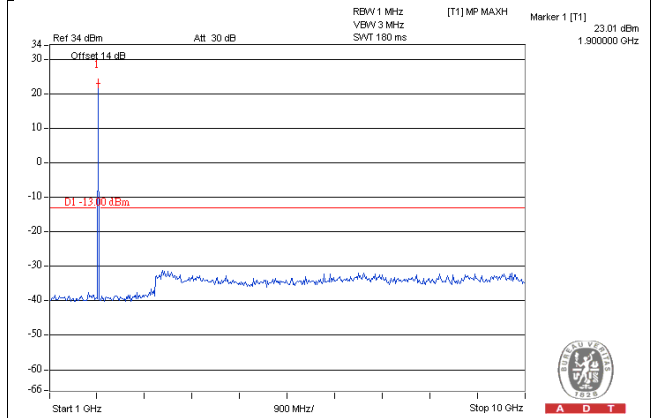

Frequency Range : 10GHz~26.5GHz

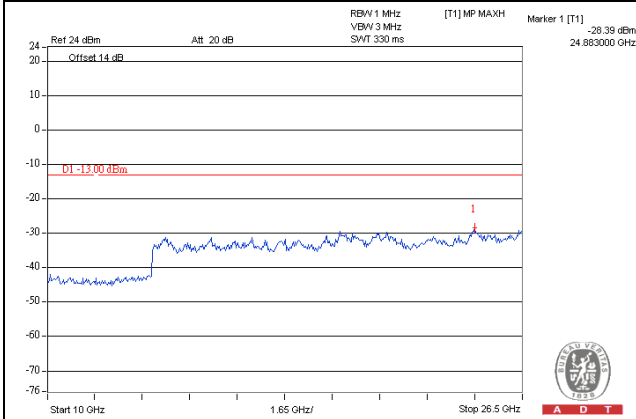

LTE Band 2, Channel Bandwidth 3MHz

Channel 18615 (1851.50MHz)

Frequency Range : 9kHz~1GHz

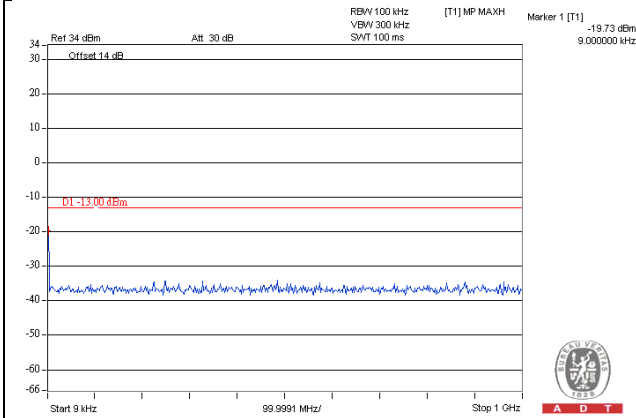

Frequency Range : 1GHz~10GHz

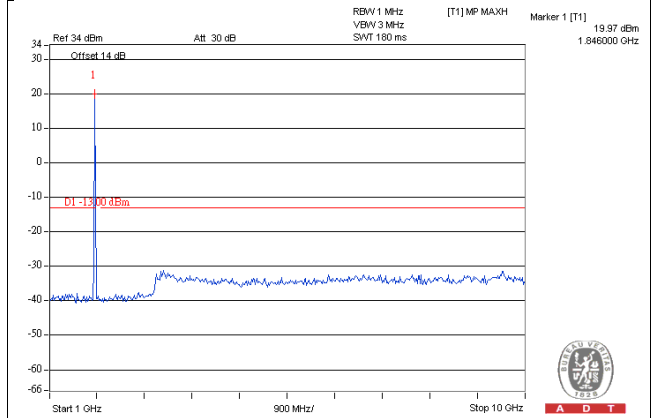

Frequency Range : 10GHz~26.5GHz

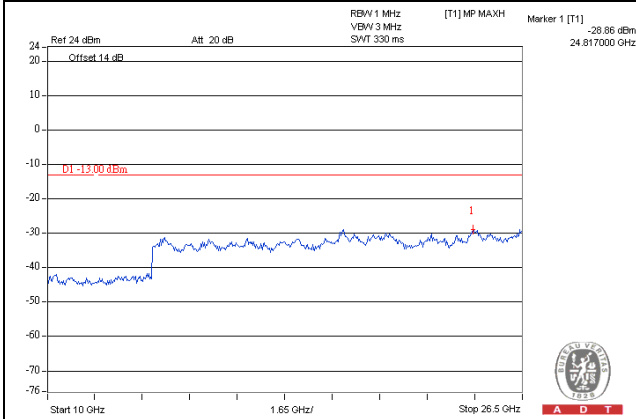

LTE Band 2, Channel Bandwidth 3MHz

Channel 18900 (1880.00MHz)

Frequency Range : 9kHz~1GHz

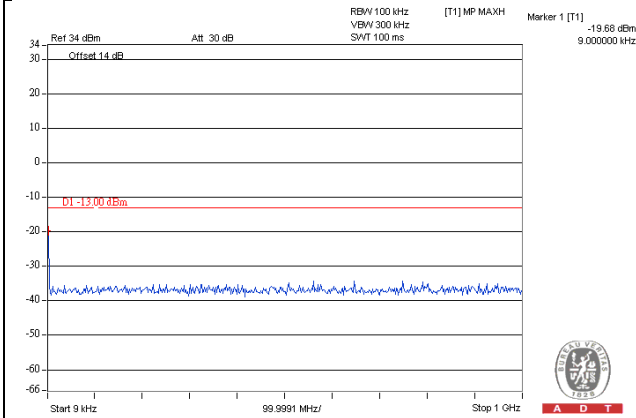

Frequency Range : 1GHz~10GHz

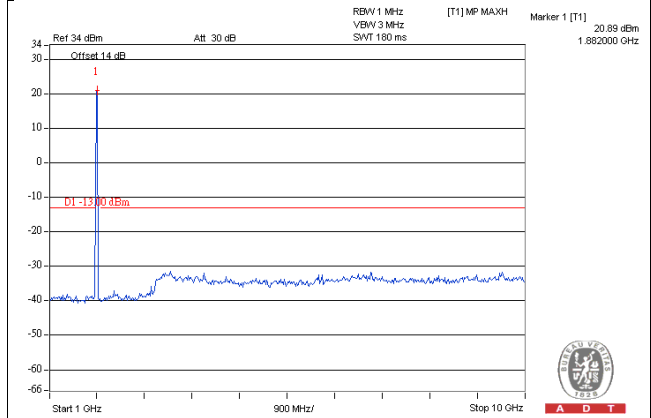

Frequency Range : 10GHz~26.5GHz

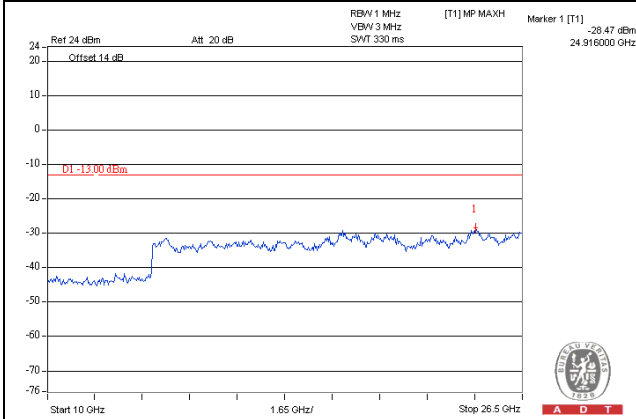

LTE Band 2, Channel Bandwidth 3MHz

Channel 19185 (1908.50MHz)

Frequency Range : 9kHz~1GHz

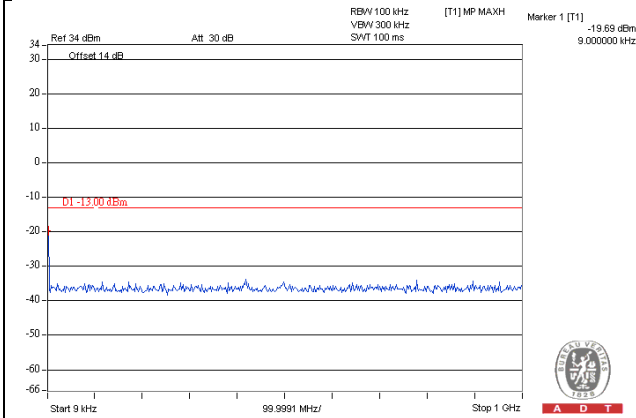

Frequency Range : 1GHz~10GHz

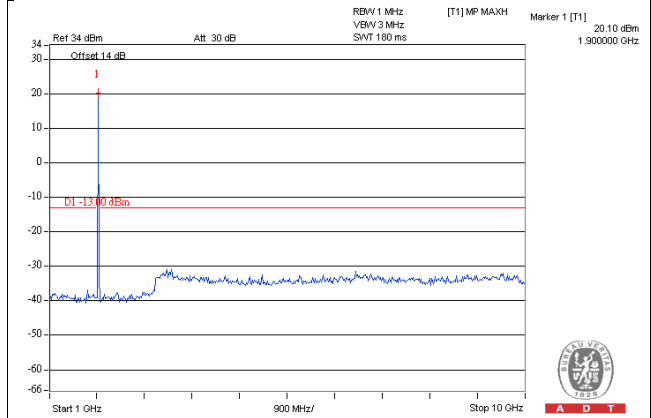

Frequency Range : 10GHz~26.5GHz

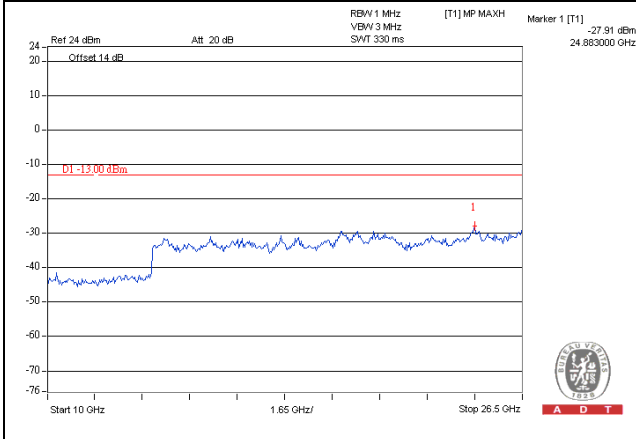

LTE Band 2, Channel Bandwidth 5MHz

Channel 18625 (1852.50MHz)

Frequency Range : 9kHz~1GHz

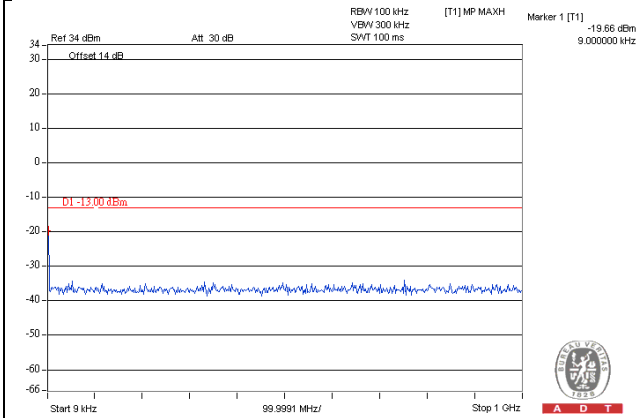

Frequency Range : 1GHz~10GHz

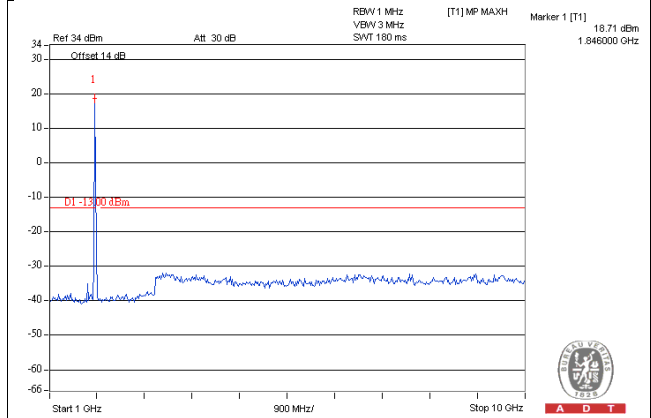

Frequency Range : 10GHz~26.5GHz

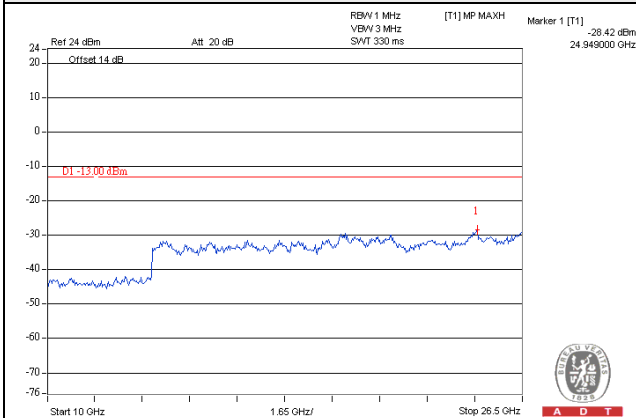

LTE Band 2, Channel Bandwidth 5MHz

Channel 18900 (1880.00MHz)

Frequency Range : 9kHz~1GHz

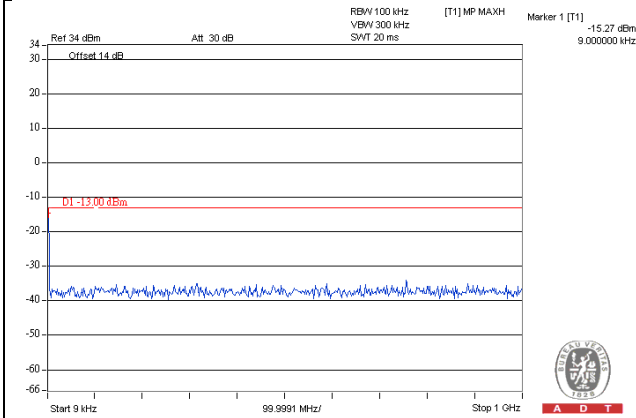

Frequency Range : 1GHz~10GHz

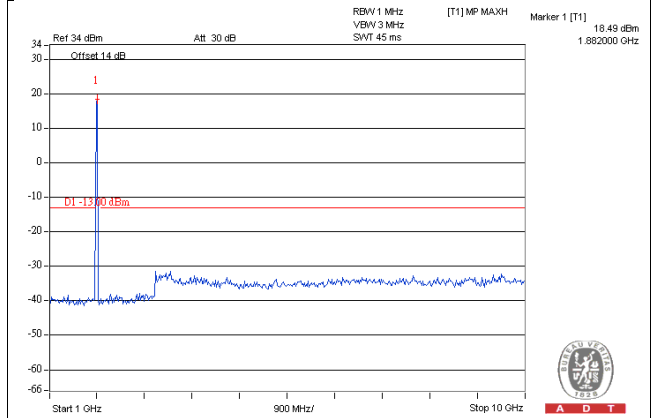

Frequency Range : 10GHz~26.5GHz

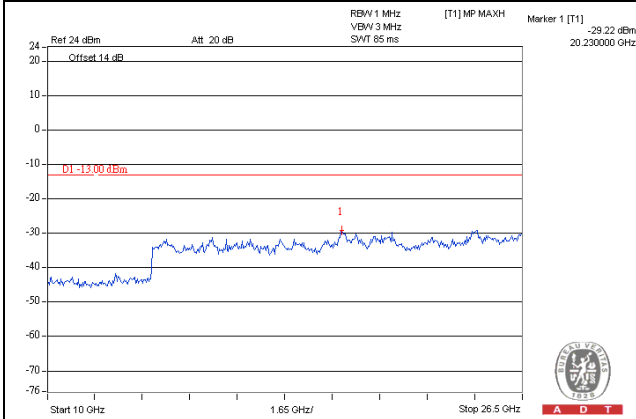

LTE Band 2, Channel Bandwidth 5MHz

Channel 19175 (1907.50MHz)

Frequency Range : 9kHz~1GHz

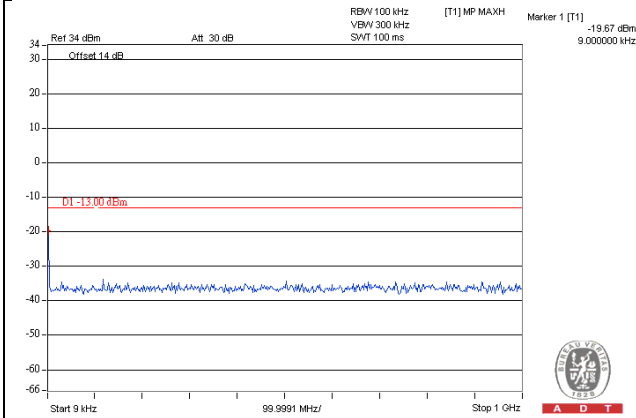

Frequency Range : 1GHz~10GHz

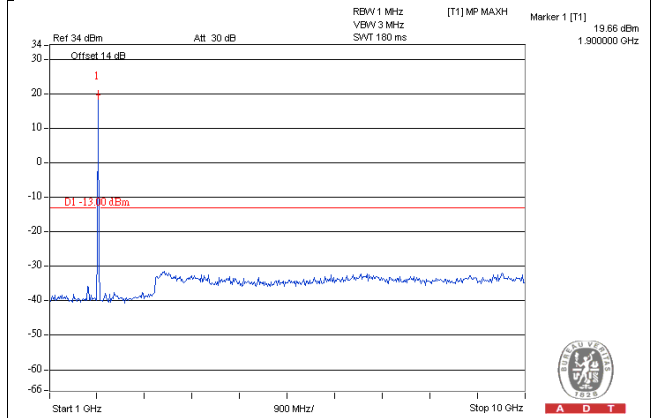

Frequency Range : 10GHz~26.5GHz

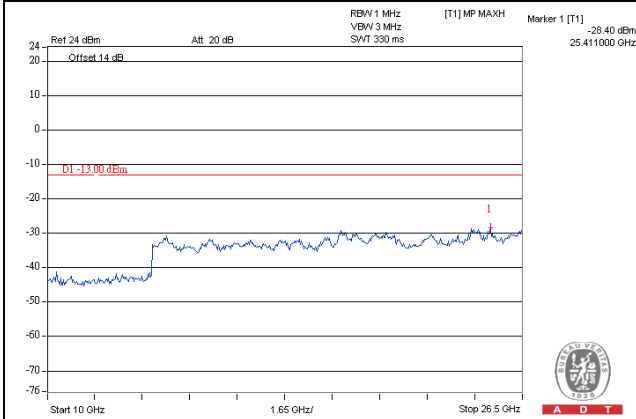

LTE Band 2, Channel Bandwidth 10MHz

Channel 18650 (1855.00MHz)

Frequency Range : 9kHz~1GHz

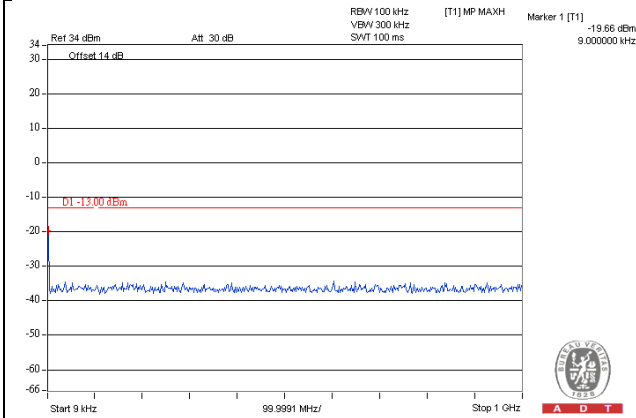

Frequency Range : 1GHz~10GHz

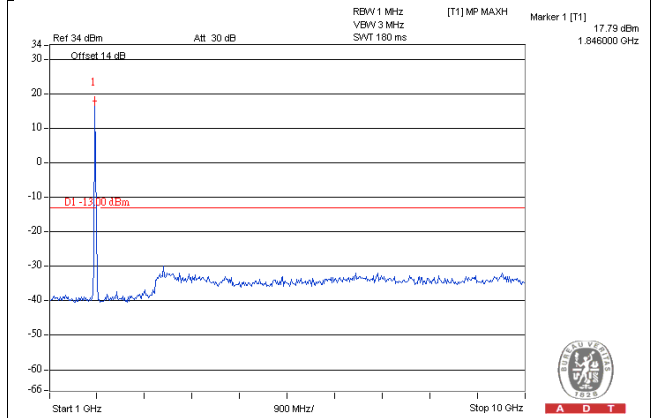

Frequency Range : 10GHz~26.5GHz

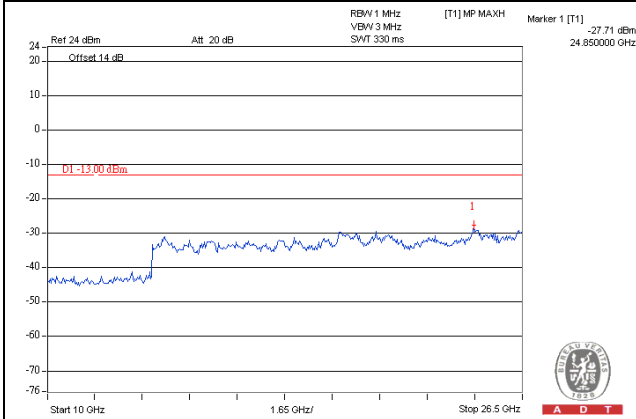

LTE Band 2, Channel Bandwidth 10MHz

Channel 18900 (1880.00MHz)

Frequency Range : 9kHz~1GHz

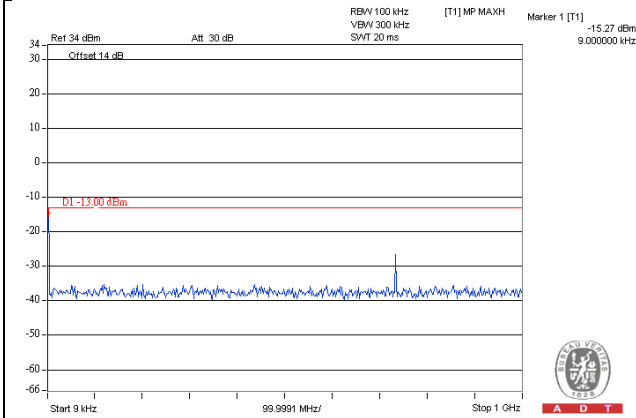

Frequency Range : 1GHz~10GHz

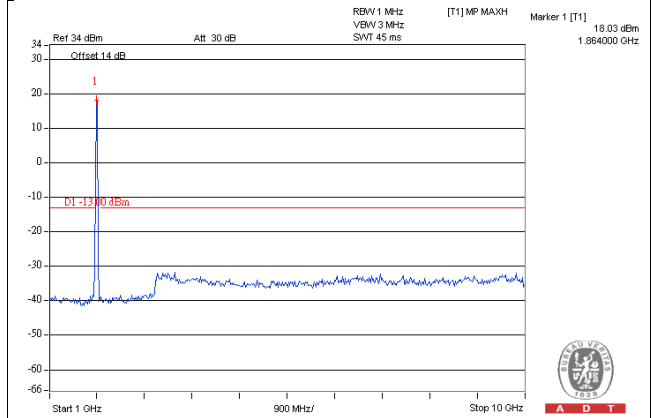

Frequency Range : 10GHz~26.5GHz

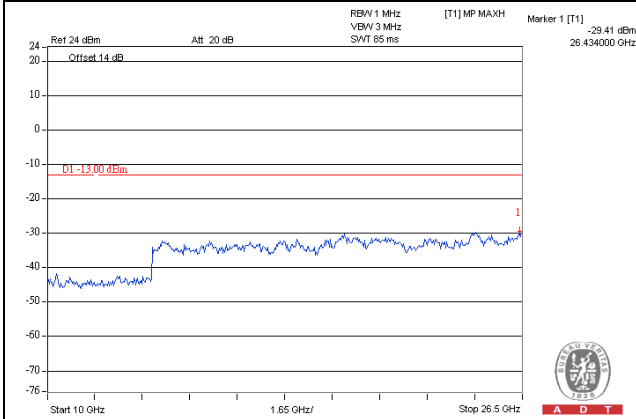

LTE Band 2, Channel Bandwidth 10MHz

Channel 19150 (1905.00MHz)

Frequency Range : 9kHz~1GHz

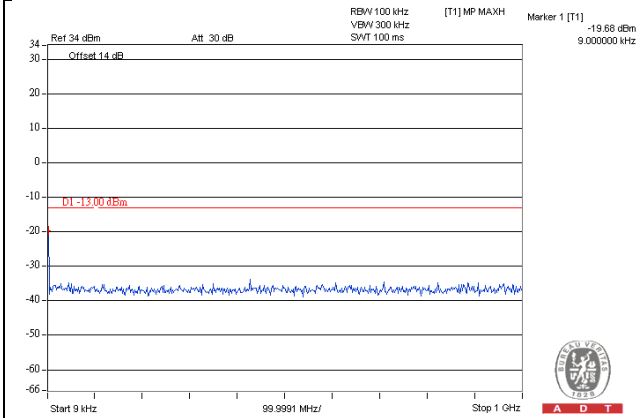

Frequency Range : 1GHz~10GHz

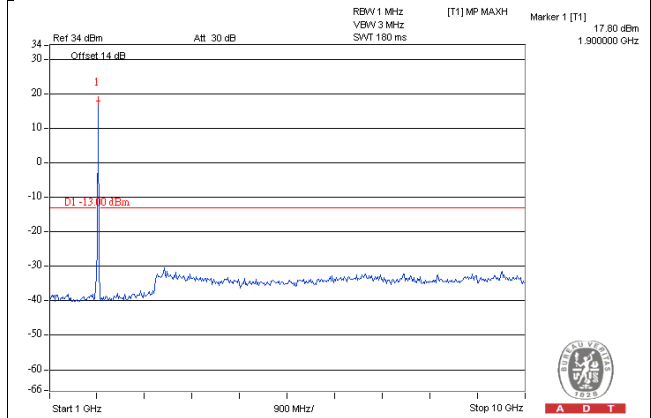

Frequency Range : 10GHz~26.5GHz

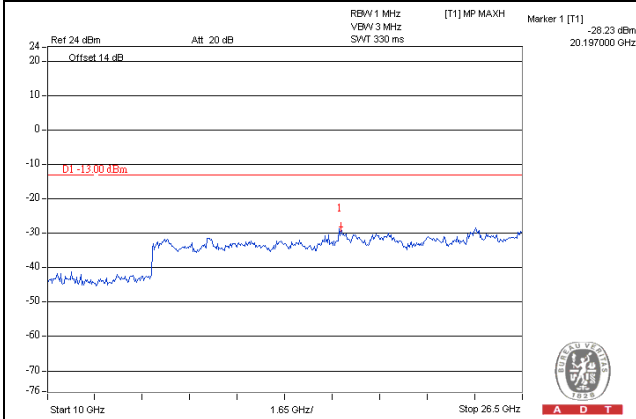

LTE Band 2, Channel Bandwidth 15MHz

Channel 18675 (1857.50MHz)

Frequency Range : 9kHz~1GHz

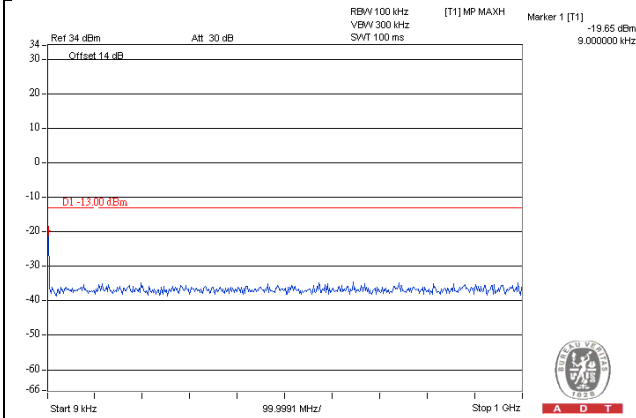

Frequency Range : 1GHz~10GHz

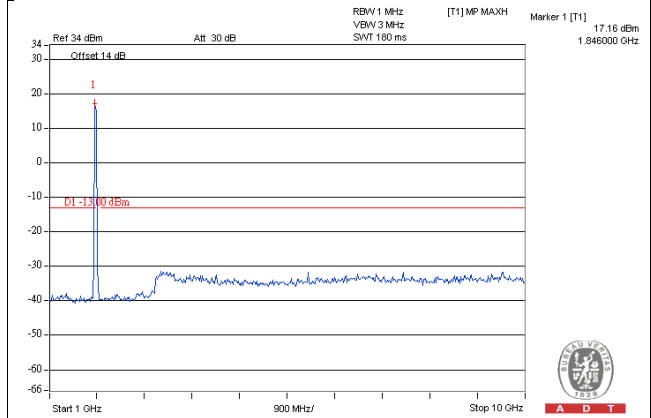

Frequency Range : 10GHz~26.5GHz

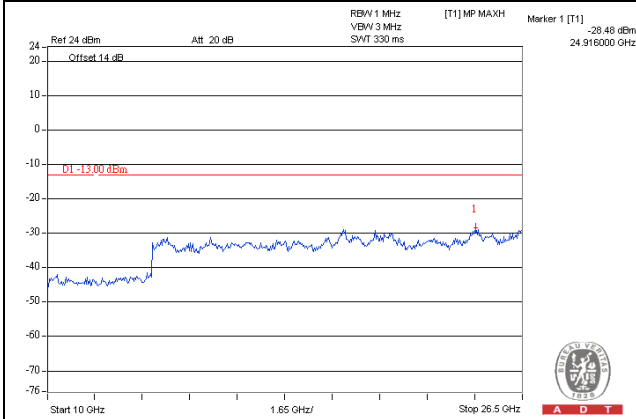

LTE Band 2, Channel Bandwidth 15MHz

Channel 18900 (1880.00MHz)

Frequency Range : 9kHz~1GHz

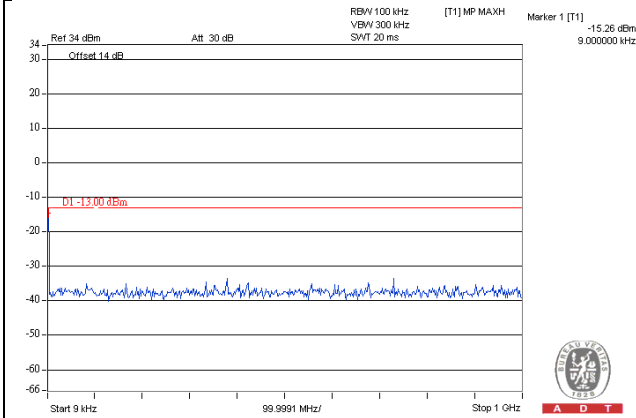

Frequency Range : 1GHz~10GHz

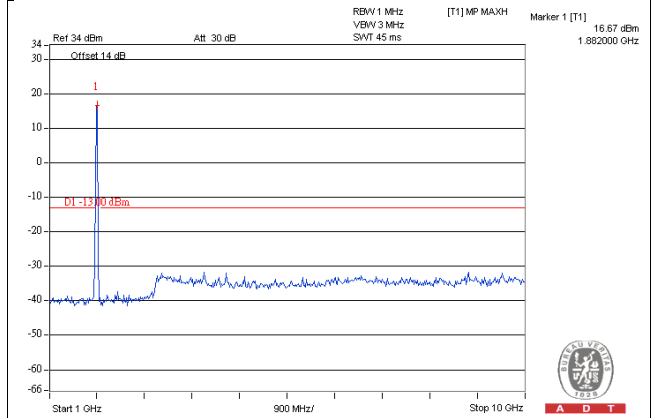

Frequency Range : 10GHz~26.5GHz

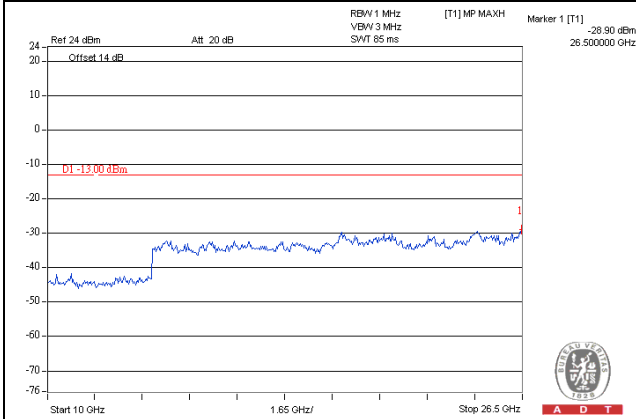

LTE Band 2, Channel Bandwidth 15MHz

Channel 19125 (1902.50MHz)

Frequency Range : 9kHz~1GHz

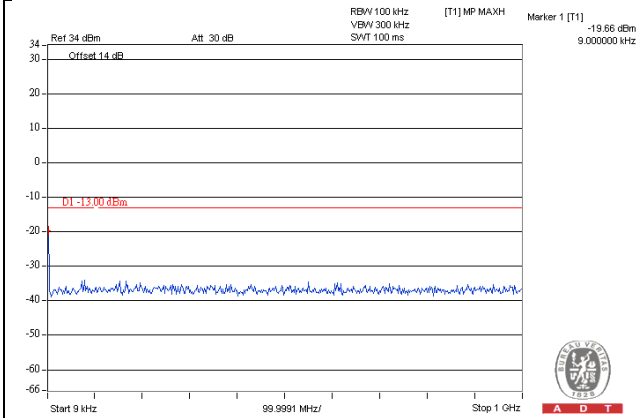

Frequency Range : 1GHz~10GHz

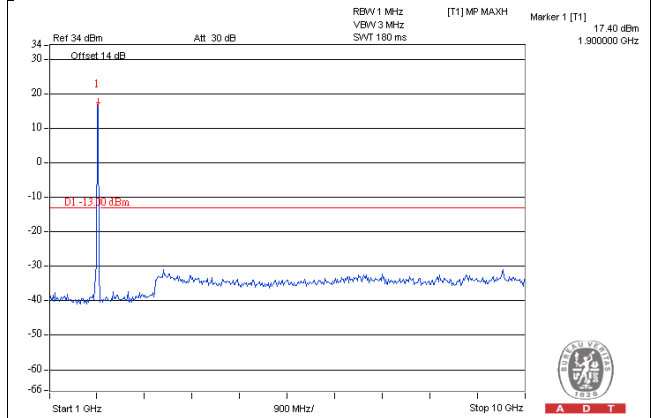

Frequency Range : 10GHz~26.5GHz

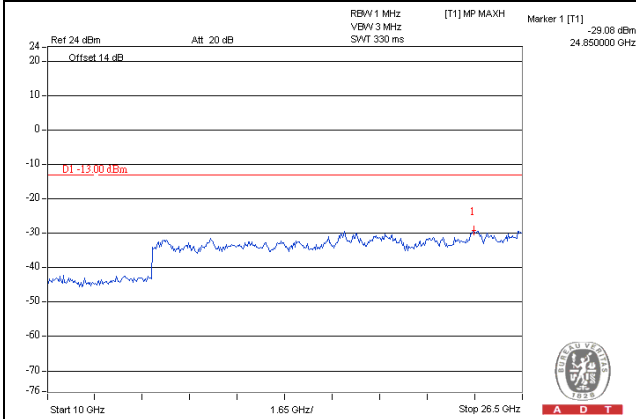

LTE Band 2, Channel Bandwidth 20MHz

Channel 18700 (1860.00MHz)

Frequency Range : 9kHz~1GHz

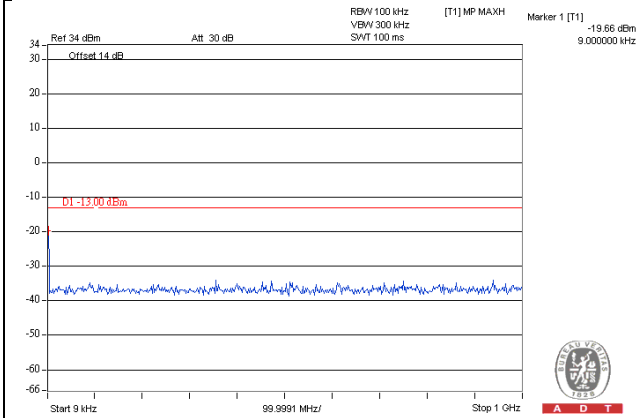

Frequency Range : 1GHz~10GHz

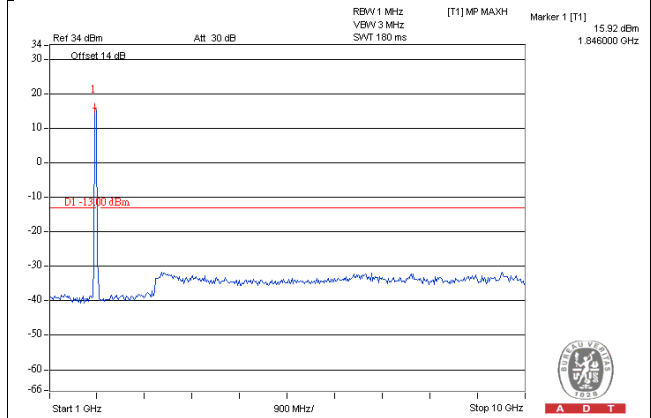

Frequency Range : 10GHz~26.5GHz

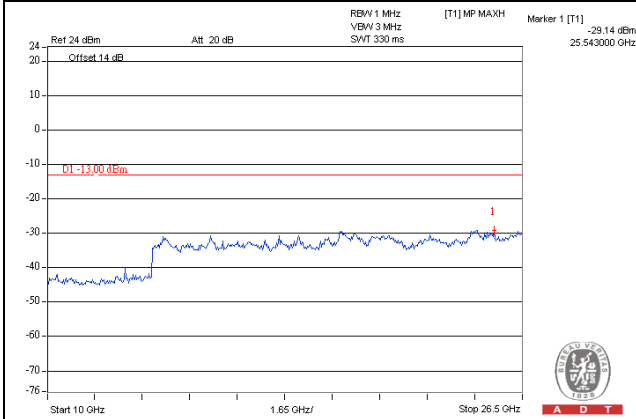

LTE Band 2, Channel Bandwidth 20MHz

Channel 18900 (1880.00MHz)

Frequency Range : 9kHz~1GHz

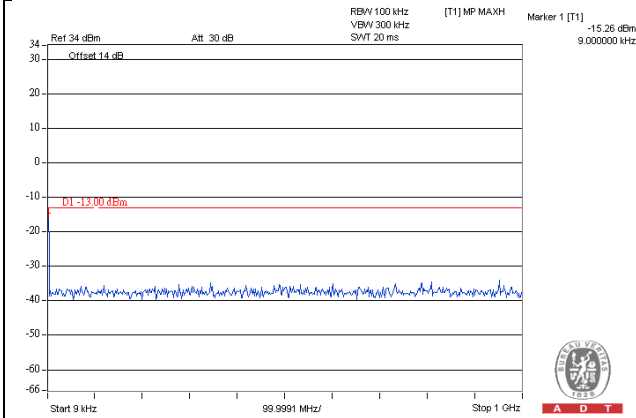

Frequency Range : 1GHz~10GHz

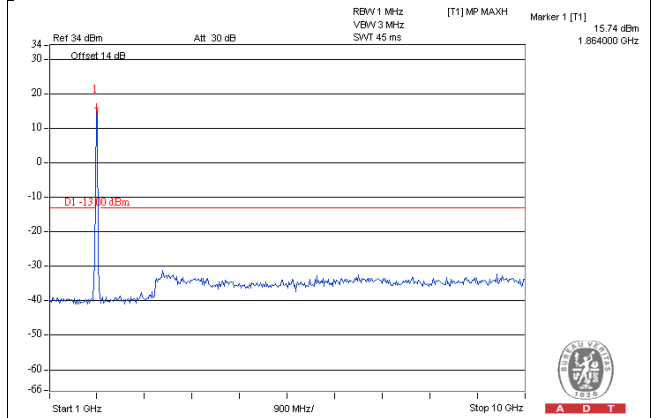

Frequency Range : 10GHz~26.5GHz

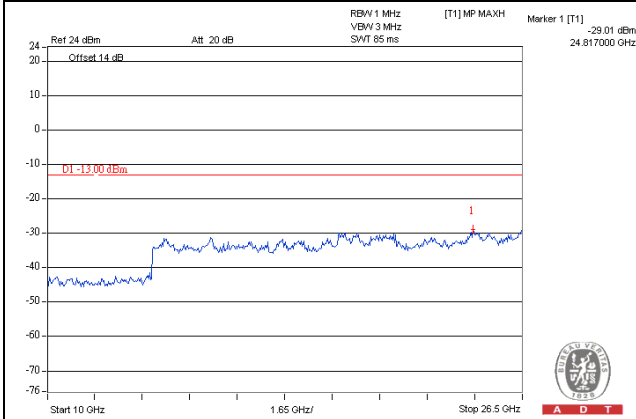

LTE Band 2, Channel Bandwidth 20MHz

Channel 19100 (1900.00MHz)

Frequency Range : 9kHz~1GHz

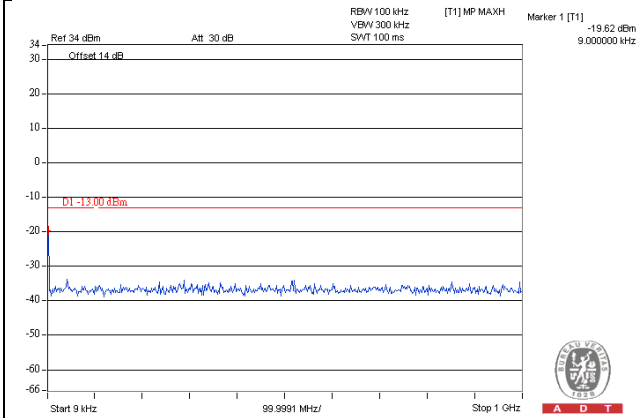

Frequency Range : 1GHz~10GHz

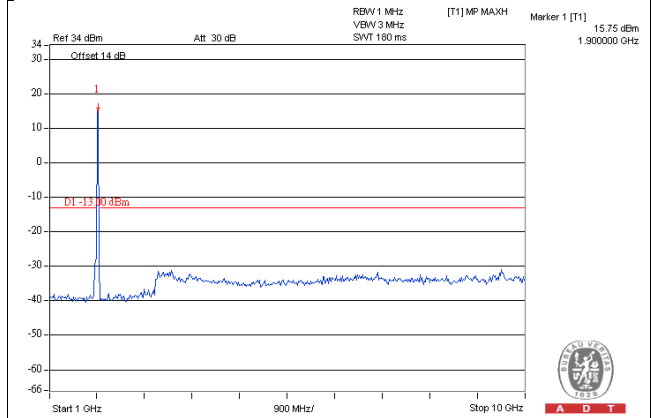

Frequency Range : 10GHz~26.5GHz

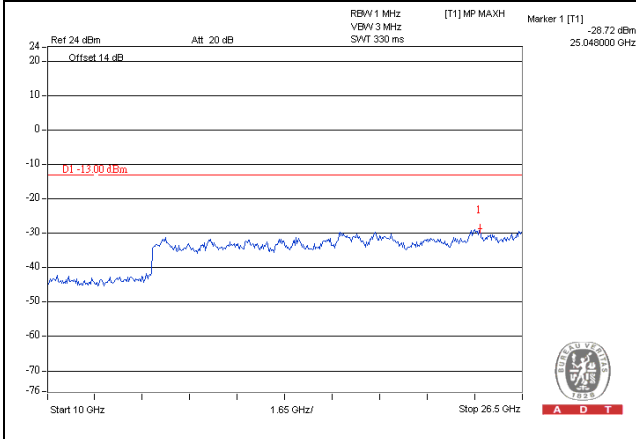

4.8 Radiated Emission Measurement

4.8.1 Limits of Radiated Emission Measurement

The power of any emission outside of the authorized operating frequency ranges must be attenuated below the transmitting power (P) by a factor of at least $43 + 10 \log(P)$ dB. The emission limit equal to -13dBm .

4.8.2 Test Procedure

- a. Substitution method is used for E.I.R.P measurement. In the semi-anechoic chamber, EUT placed on the 0.8m height of Turn Table, rotated the table around 360 degrees to search the maximum radiation power and receiver antenna shall be rotated vertical and horizontal polarization and moved height from 1m to 4m to find the maximum polar radiated power. The "Read Value" is the spectrum reading the maximum power value.
- b. The substitution horn antenna is substituted for EUT at the same position and signals generator export the CW signal to the substitution antenna via a TX cable. Rotated the Turn Table and moved receiving antenna to find the maximum radiation power. Adjust output power level of S.G to get a Value of spectrum reading equal to "Read Value" of step a. Record the power level of S.G
- c. $\text{EIRP} = \text{Output power level of S.G} - \text{TX cable loss} + \text{Antenna gain of substitution horn}$.
- d. E.R.P power can be calculated form E.I.R.P power by subtracting the gain of dipole, $\text{E.R.P power} = \text{E.I.R.P power} - 2.15\text{dBi}$.

NOTE: The resolution bandwidth and video bandwidth of test receiver/spectrum analyzer is 1MHz/3MHz.

4.8.3 Deviation from Test Standard

No deviation.

4.8.4 Test Setup

For radiated emission 30MHz to 1GHz

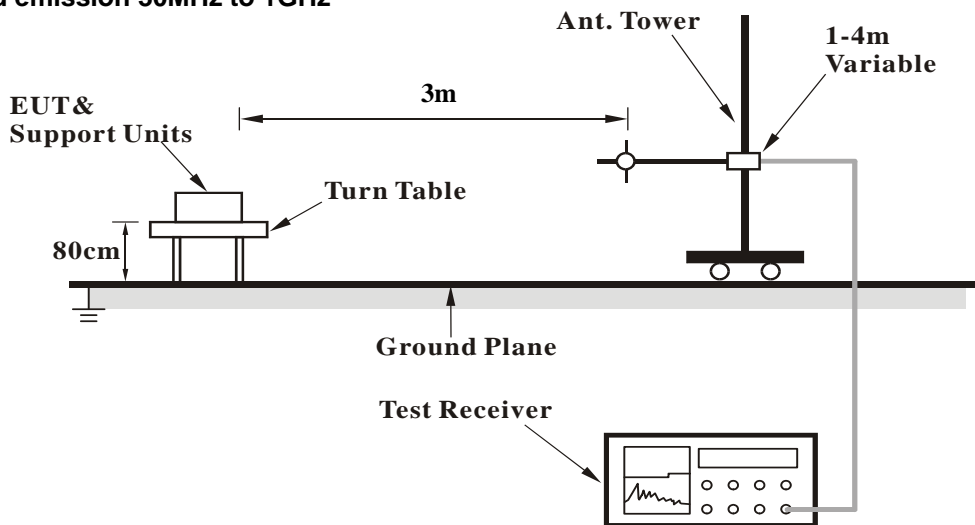

For radiated emission above 1GHz

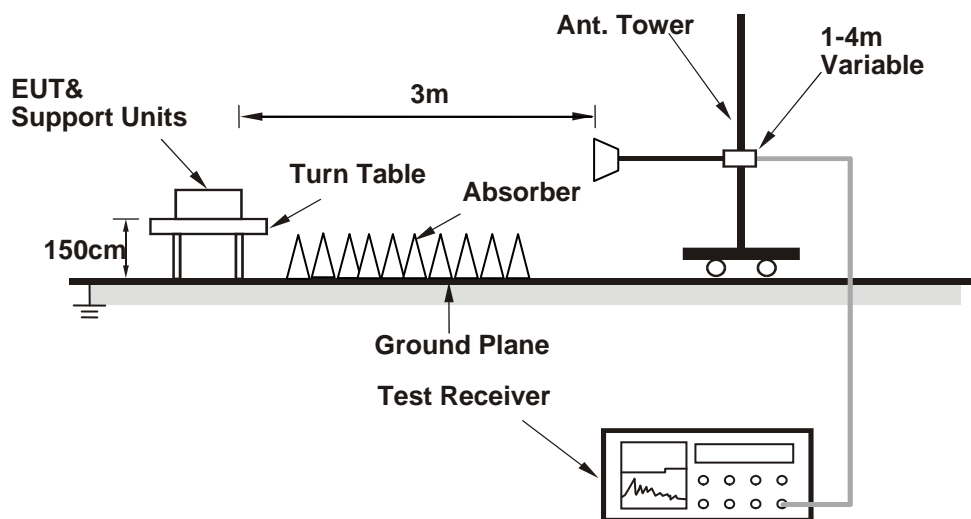

For the actual test configuration, please refer to the attached file (Test Setup Photo).

4.8.5 Test Results

Below 1GHz
WCDMA Band 2

Mode	TX channel 9262 (1852.4MHz)	Frequency Range	Below 1000 MHz
Environmental Conditions	25deg. C, 65%RH	Input Power	120Vac, 60Hz
Tested By	Greg Lin		

Antenna Polarity & Test Distance: Horizontal at 3 M							
No.	Freq. (MHz)	Reading (dBm)	S.G Power Value (dBm)	Correction Factor (dB)	EIRP (dBm)	Limit (dBm)	Margin (dB)
1	30.00	-74.5	-71.7	1.2	-70.5	-13.0	-57.5
2	154.16	-73.8	-78.3	0.2	-78.1	-13.0	-65.1
3	419.94	-73.5	-73.2	-0.6	-73.8	-13.0	-60.8
4	619.76	-73.2	-70.1	-1.1	-71.2	-13.0	-58.2
5	784.66	-71.3	-64.7	-1.4	-66.1	-13.0	-53.1
6	926.28	-73.1	-63.2	-1.7	-64.9	-13.0	-51.9
Antenna Polarity & Test Distance: Vertical at 3 M							
No.	Freq. (MHz)	Reading (dBm)	S.G Power Value (dBm)	Correction Factor (dB)	EIRP (dBm)	Limit (dBm)	Margin (dB)
1	82.38	-74.5	-79.5	0.5	-79.0	-13.0	-66.0
2	280.26	-74.6	-71.3	-0.1	-71.4	-13.0	-58.4
3	565.44	-72.5	-70.0	-0.8	-70.8	-13.0	-57.8
4	677.96	-73.5	-66.7	-1.2	-67.9	-13.0	-54.9
5	825.40	-72.7	-63.8	-1.4	-65.2	-13.0	-52.2
6	994.18	-72.8	-60.7	-2.0	-62.7	-13.0	-49.7

Remarks:

1. Output Power (dBm) = S.G Value (dBm) + Correction Factor (dB).
2. Correction Factor (dB) = Substitution Antenna Gain (dB) + Cable Loss (dB).

LTE Band 2, Channel Bandwidth 1.4MHz

Mode	TX channel 18607 (1850.70MHz)	Frequency Range	Below 1000 MHz
Environmental Conditions	25deg. C, 66%RH	Input Power	120Vac, 60Hz
Tested By	James Yang		

Antenna Polarity & Test Distance: Horizontal at 3 M

No.	Freq. (MHz)	Reading (dBm)	S.G Power Value (dBm)	Correction Factor (dB)	EIRP (dBm)	Limit (dBm)	Margin (dB)
1	30.97	-48.4	-25.9	-18.8	-44.7	-13.0	-31.7
2	109.54	-43.2	-48.6	-2.5	-51.1	-13.0	-38.1
3	167.74	-48.1	-51.9	-2.9	-54.8	-13.0	-41.8
4	362.71	-57.4	-63.9	3.9	-60.0	-13.0	-47.0
5	428.67	-60.1	-64.0	3.5	-60.5	-13.0	-47.5
6	893.30	-67.3	-63.5	3.5	-60.0	-13.0	-47.0

Antenna Polarity & Test Distance: Vertical at 3 M

No.	Freq. (MHz)	Reading (dBm)	S.G Power Value (dBm)	Correction Factor (dB)	EIRP (dBm)	Limit (dBm)	Margin (dB)
1	31.94	-40.7	-32.9	-18.3	-51.2	-13.0	-38.2
2	131.85	-48.9	-50.2	-3.3	-53.5	-13.0	-40.5
3	288.99	-60.3	-57.3	-1.7	-59.0	-13.0	-46.0
4	362.71	-55.0	-59.3	3.9	-55.4	-13.0	-42.4
5	659.53	-63.1	-61.2	3.7	-57.5	-13.0	-44.5
6	956.35	-68.0	-62.5	3.9	-58.6	-13.0	-45.6

Remarks:

1. Output Power (dBm) = S.G Value (dBm) + Correction Factor (dB).
2. Correction Factor (dB) = Substitution Antenna Gain (dB) + Cable Loss (dB).

LTE Band 2, Channel Bandwidth 3MHz

Mode	TX channel 18615 (1851.50MHz)	Frequency Range	Below 1000 MHz
Environmental Conditions	25deg. C, 66%RH	Input Power	120Vac, 60Hz
Tested By	James Yang		

Antenna Polarity & Test Distance: Horizontal at 3 M							
No.	Freq. (MHz)	Reading (dBm)	S.G Power Value (dBm)	Correction Factor (dB)	ERP (dBm)	Limit (dBm)	Margin (dB)
1	30.00	-51.5	-28.1	-19.4	-47.5	-13.0	-34.5
2	109.54	-43.6	-49.0	-2.5	-51.5	-13.0	-38.5
3	167.74	-49.2	-53.0	-2.9	-55.9	-13.0	-42.9
4	363.68	-58.4	-64.8	3.9	-60.9	-13.0	-47.9
5	660.50	-66.2	-67.5	3.7	-63.8	-13.0	-50.8
6	957.32	-67.2	-62.5	3.8	-58.7	-13.0	-45.7

Antenna Polarity & Test Distance: Vertical at 3 M							
No.	Freq. (MHz)	Reading (dBm)	S.G Power Value (dBm)	Correction Factor (dB)	ERP (dBm)	Limit (dBm)	Margin (dB)
1	30.00	-37.9	-28.4	-19.4	-47.8	-13.0	-34.8
2	131.85	-48.6	-49.9	-3.3	-53.2	-13.0	-40.2
3	296.75	-58.6	-57.0	-1.8	-58.8	-13.0	-45.8
4	362.71	-55.1	-59.4	3.9	-55.5	-13.0	-42.5
5	659.53	-63.6	-61.7	3.7	-58.0	-13.0	-45.0
6	951.50	-68.8	-63.3	3.8	-59.5	-13.0	-46.5

Remarks:

1. Output Power (dBm) = S.G Value (dBm) + Correction Factor (dB).
2. Correction Factor (dB) = Substitution Antenna Gain (dB) + Cable Loss (dB).

LTE Band 2, Channel Bandwidth 5MHz

Mode	TX channel 18625 (1852.50MHz)	Frequency Range	Below 1000 MHz
Environmental Conditions	25deg. C, 66%RH	Input Power	120Vac, 60Hz
Tested By	James Yang		

Antenna Polarity & Test Distance: Horizontal at 3 M

No.	Freq. (MHz)	Reading (dBm)	S.G Power Value (dBm)	Correction Factor (dB)	ERP (dBm)	Limit (dBm)	Margin (dB)
1	30.97	-42.9	-20.4	-18.8	-39.2	-13.0	-26.2
2	111.48	-42.9	-48.1	-2.5	-50.6	-13.0	-37.6
3	169.68	-49.4	-53.4	-2.8	-56.2	-13.0	-43.2
4	363.68	-58.1	-64.5	3.9	-60.6	-13.0	-47.6
5	429.64	-60.5	-64.5	3.5	-61.0	-13.0	-48.0
6	957.32	-68.2	-63.5	3.8	-59.7	-13.0	-46.7

Antenna Polarity & Test Distance: Vertical at 3 M

No.	Freq. (MHz)	Reading (dBm)	S.G Power Value (dBm)	Correction Factor (dB)	ERP (dBm)	Limit (dBm)	Margin (dB)
1	31.94	-32.6	-24.8	-18.3	-43.1	-13.0	-30.1
2	50.37	-42.6	-42.1	-7.9	-50.0	-13.0	-37.0
3	131.85	-48.3	-49.6	-3.3	-52.9	-13.0	-39.9
4	288.99	-60.3	-57.3	-1.7	-59.0	-13.0	-46.0
5	363.68	-56.0	-60.2	3.9	-56.3	-13.0	-43.3
6	660.50	-63.8	-61.9	3.7	-58.2	-13.0	-45.2

Remarks:

1. Output Power (dBm) = S.G Value (dBm) + Correction Factor (dB).
2. Correction Factor (dB) = Substitution Antenna Gain (dB) + Cable Loss (dB).

LTE Band 2, Channel Bandwidth 10MHz

Mode	TX channel 18650 (1855.00MHz)	Frequency Range	Below 1000 MHz
Environmental Conditions	25deg. C, 66%RH	Input Power	120Vac, 60Hz
Tested By	James Yang		

Antenna Polarity & Test Distance: Horizontal at 3 M

No.	Freq. (MHz)	Reading (dBm)	S.G Power Value (dBm)	Correction Factor (dB)	ERP (dBm)	Limit (dBm)	Margin (dB)
1	30.97	-49.1	-26.6	-18.8	-45.4	-13.0	-32.4
2	111.48	-43.7	-48.9	-2.5	-51.4	-13.0	-38.4
3	168.71	-46.7	-50.7	-2.8	-53.5	-13.0	-40.5
4	363.68	-58.0	-64.4	3.9	-60.5	-13.0	-47.5
5	660.50	-66.5	-67.8	3.7	-64.1	-13.0	-51.1
6	957.32	-67.9	-63.2	3.8	-59.4	-13.0	-46.4

Antenna Polarity & Test Distance: Vertical at 3 M

No.	Freq. (MHz)	Reading (dBm)	S.G Power Value (dBm)	Correction Factor (dB)	ERP (dBm)	Limit (dBm)	Margin (dB)
1	30.00	-37.2	-27.7	-19.4	-47.1	-13.0	-34.1
2	138.64	-50.2	-50.0	-3.2	-53.2	-13.0	-40.2
3	285.11	-61.3	-57.5	-1.6	-59.1	-13.0	-46.1
4	495.60	-64.8	-68.7	3.8	-64.9	-13.0	-51.9
5	660.50	-63.7	-61.8	3.7	-58.1	-13.0	-45.1
6	926.28	-67.9	-63.0	3.7	-59.3	-13.0	-46.3

Remarks:

1. Output Power (dBm) = S.G Value (dBm) + Correction Factor (dB).
2. Correction Factor (dB) = Substitution Antenna Gain (dB) + Cable Loss (dB).

LTE Band 2, Channel Bandwidth 15MHz

Mode	TX channel 18675 (1857.50MHz)	Frequency Range	Below 1000 MHz
Environmental Conditions	25deg. C, 66%RH	Input Power	120Vac, 60Hz
Tested By	James Yang		

Antenna Polarity & Test Distance: Horizontal at 3 M							
No.	Freq. (MHz)	Reading (dBm)	S.G Power Value (dBm)	Correction Factor (dB)	ERP (dBm)	Limit (dBm)	Margin (dB)
1	30.00	-48.7	-25.3	-19.4	-44.7	-13.0	-31.7
2	110.51	-42.6	-47.9	-2.6	-50.5	-13.0	-37.5
3	287.05	-61.0	-63.0	-1.7	-64.7	-13.0	-51.7
4	429.64	-60.3	-64.3	3.5	-60.8	-13.0	-47.8
5	660.50	-66.1	-67.4	3.7	-63.7	-13.0	-50.7
6	957.32	-68.2	-63.5	3.8	-59.7	-13.0	-46.7

Antenna Polarity & Test Distance: Vertical at 3 M							
No.	Freq. (MHz)	Reading (dBm)	S.G Power Value (dBm)	Correction Factor (dB)	ERP (dBm)	Limit (dBm)	Margin (dB)
1	30.00	-33.9	-24.4	-19.4	-43.8	-13.0	-30.8
2	131.85	-48.6	-49.9	-3.3	-53.2	-13.0	-40.2
3	285.11	-62.2	-58.4	-1.6	-60.0	-13.0	-47.0
4	429.64	-58.2	-62.1	3.5	-58.6	-13.0	-45.6
5	660.50	-63.6	-61.7	3.7	-58.0	-13.0	-45.0
6	957.32	-67.8	-62.3	3.8	-58.5	-13.0	-45.5

Remarks:

1. Output Power (dBm) = S.G Value (dBm) + Correction Factor (dB).
2. Correction Factor (dB) = Substitution Antenna Gain (dB) + Cable Loss (dB).

LTE Band 2, Channel Bandwidth 20MHz

Mode	TX channel 18700 (1860.00MHz)	Frequency Range	Below 1000 MHz
Environmental Conditions	25deg. C, 66%RH	Input Power	120Vac, 60Hz
Tested By	James Yang		

Antenna Polarity & Test Distance: Horizontal at 3 M

No.	Freq. (MHz)	Reading (dBm)	S.G Power Value (dBm)	Correction Factor (dB)	ERP (dBm)	Limit (dBm)	Margin (dB)
1	30.00	-49.9	-26.5	-19.4	-45.9	-13.0	-32.9
2	110.51	-43.2	-48.5	-2.6	-51.1	-13.0	-38.1
3	169.68	-48.3	-52.3	-2.8	-55.1	-13.0	-42.1
4	363.68	-58.2	-64.6	3.9	-60.7	-13.0	-47.7
5	660.50	-66.1	-67.4	3.7	-63.7	-13.0	-50.7
6	957.32	-67.2	-62.5	3.8	-58.7	-13.0	-45.7

Antenna Polarity & Test Distance: Vertical at 3 M

No.	Freq. (MHz)	Reading (dBm)	S.G Power Value (dBm)	Correction Factor (dB)	ERP (dBm)	Limit (dBm)	Margin (dB)
1	30.00	-36.3	-26.8	-19.4	-46.2	-13.0	-33.2
2	131.85	-48.7	-50.0	-3.3	-53.3	-13.0	-40.3
3	287.05	-61.7	-58.2	-1.7	-59.9	-13.0	-46.9
4	363.68	-56.6	-60.8	3.9	-56.9	-13.0	-43.9
5	660.50	-64.0	-62.1	3.7	-58.4	-13.0	-45.4
6	957.32	-68.5	-63.0	3.8	-59.2	-13.0	-46.2

Remarks:

1. Output Power (dBm) = S.G Value (dBm) + Correction Factor (dB).
2. Correction Factor (dB) = Substitution Antenna Gain (dB) + Cable Loss (dB).

Above 1GHz
WCDMA Band 2

Mode	TX channel 9262 (1852.4MHz)	Frequency Range	Above 1000MHz
Environmental Conditions	25deg. C, 65%RH	Input Power	120Vac, 60Hz
Tested By	Greg Lin		

Antenna Polarity & Test Distance: Horizontal at 3 M							
No.	Freq. (MHz)	Reading (dBm)	S.G Power Value (dBm)	Correction Factor (dB)	EIRP (dBm)	Limit (dBm)	Margin (dB)
1	3704.80	-66.3	-57.8	1.4	-56.4	-13.0	-43.4
2	5557.20	-69.8	-56.9	1.3	-55.6	-13.0	-42.6
Antenna Polarity & Test Distance: Vertical at 3 M							
No.	Freq. (MHz)	Reading (dBm)	S.G Power Value (dBm)	Correction Factor (dB)	EIRP (dBm)	Limit (dBm)	Margin (dB)
1	3704.80	-68.8	-60.6	1.4	-59.2	-13.0	-46.2
2	5557.20	-70.3	-58.2	1.3	-56.9	-13.0	-43.9

Remarks:

- Output Power (dBm) = S.G Value (dBm) + Correction Factor (dB).
- Correction Factor (dB) = Substitution Antenna Gain (dB) + Cable Loss (dB).

Mode	TX channel 9400 (1880.0MHz)	Frequency Range	Above 1000MHz
Environmental Conditions	25deg. C, 65%RH	Input Power	120Vac, 60Hz
Tested By	Greg Lin		

Antenna Polarity & Test Distance: Horizontal at 3 M							
No.	Freq. (MHz)	Reading (dBm)	S.G Power Value (dBm)	Correction Factor (dB)	EIRP (dBm)	Limit (dBm)	Margin (dB)
1	3760.00	-67.8	-59.3	1.3	-58.0	-13.0	-45.0
2	5640.00	-69.5	-56.5	1.3	-55.2	-13.0	-42.2
Antenna Polarity & Test Distance: Vertical at 3 M							
No.	Freq. (MHz)	Reading (dBm)	S.G Power Value (dBm)	Correction Factor (dB)	EIRP (dBm)	Limit (dBm)	Margin (dB)
1	3760.00	-68.6	-60.3	1.3	-59.0	-13.0	-46.0
2	5640.00	-70.2	-58.3	1.3	-57.0	-13.0	-44.0

Remarks:

- Output Power (dBm) = S.G Value (dBm) + Correction Factor (dB).
- Correction Factor (dB) = Substitution Antenna Gain (dB) + Cable Loss (dB).

Mode	TX channel 9538 (1907.6MHz)	Frequency Range	Above 1000MHz
Environmental Conditions	25deg. C, 65%RH	Input Power	120Vac, 60Hz
Tested By	Greg Lin		

Antenna Polarity & Test Distance: Horizontal at 3 M							
No.	Freq. (MHz)	Reading (dBm)	S.G Power Value (dBm)	Correction Factor (dB)	EIRP (dBm)	Limit (dBm)	Margin (dB)
1	3815.20	-66.4	-58.1	1.4	-56.7	-13.0	-43.7
2	5722.80	-69.7	-56.6	1.2	-55.4	-13.0	-42.4
Antenna Polarity & Test Distance: Vertical at 3 M							
No.	Freq. (MHz)	Reading (dBm)	S.G Power Value (dBm)	Correction Factor (dB)	EIRP (dBm)	Limit (dBm)	Margin (dB)
1	3815.20	-68.6	-60.4	1.4	-59.0	-13.0	-46.0
2	5722.80	-70.2	-58.1	1.2	-56.9	-13.0	-43.9

Remarks:

1. Output Power (dBm) = S.G Value (dBm) + Correction Factor (dB).
2. Correction Factor (dB) = Substitution Antenna Gain (dB) + Cable Loss (dB).

LTE Band 2, Channel Bandwidth 1.4MHz

Mode	TX channel 18607 (1850.70MHz)	Frequency Range	Above 1000MHz
Environmental Conditions	25deg. C, 66%RH	Input Power	120Vac, 60Hz
Tested By	James Yang		

Antenna Polarity & Test Distance: Horizontal at 3 M							
No.	Freq. (MHz)	Reading (dBm)	S.G Power Value (dBm)	Correction Factor (dB)	EIRP (dBm)	Limit (dBm)	Margin (dB)
1	3701.40	-60.7	-52.2	1.4	-50.8	-13.0	-37.8
Antenna Polarity & Test Distance: Vertical at 3 M							
No.	Freq. (MHz)	Reading (dBm)	S.G Power Value (dBm)	Correction Factor (dB)	EIRP (dBm)	Limit (dBm)	Margin (dB)
1	3701.40	-59.7	-51.5	1.4	-50.1	-13.0	-37.1

Remarks:

1. Output Power (dBm) = S.G Value (dBm) + Correction Factor (dB).
2. Correction Factor (dB) = Substitution Antenna Gain (dB) + Cable Loss (dB).

Mode	TX channel 18900 (1880.00MHz)	Frequency Range	Above 1000MHz
Environmental Conditions	25deg. C, 66%RH	Input Power	120Vac, 60Hz
Tested By	James Yang		

Antenna Polarity & Test Distance: Horizontal at 3 M							
No.	Freq. (MHz)	Reading (dBm)	S.G Power Value (dBm)	Correction Factor (dB)	EIRP (dBm)	Limit (dBm)	Margin (dB)
1	3760.00	-52.0	-43.5	1.3	-42.2	-13.0	-29.2
Antenna Polarity & Test Distance: Vertical at 3 M							
No.	Freq. (MHz)	Reading (dBm)	S.G Power Value (dBm)	Correction Factor (dB)	EIRP (dBm)	Limit (dBm)	Margin (dB)
1	3760.00	-51.3	-43.0	1.3	-41.7	-13.0	-28.7

Remarks:

1. Output Power (dBm) = S.G Value (dBm) + Correction Factor (dB).
2. Correction Factor (dB) = Substitution Antenna Gain (dB) + Cable Loss (dB).

Mode	TX channel 19193 (1909.30MHz)	Frequency Range	Above 1000MHz
Environmental Conditions	25deg. C, 66%RH	Input Power	120Vac, 60Hz
Tested By	James Yang		

Antenna Polarity & Test Distance: Horizontal at 3 M							
No.	Freq. (MHz)	Reading (dBm)	S.G Power Value (dBm)	Correction Factor (dB)	EIRP (dBm)	Limit (dBm)	Margin (dB)
1	3818.60	-52.3	-44.0	1.4	-42.6	-13.0	-29.6
Antenna Polarity & Test Distance: Vertical at 3 M							
No.	Freq. (MHz)	Reading (dBm)	S.G Power Value (dBm)	Correction Factor (dB)	EIRP (dBm)	Limit (dBm)	Margin (dB)
1	3818.60	-51.2	-43.0	1.4	-41.6	-13.0	-28.6

Remarks:

1. Output Power (dBm) = S.G Value (dBm) + Correction Factor (dB).
2. Correction Factor (dB) = Substitution Antenna Gain (dB) + Cable Loss (dB).

LTE Band 2, Channel Bandwidth 3MHz

Mode	TX channel 18615 (1851.50MHz)	Frequency Range	Above 1000MHz
Environmental Conditions	25deg. C, 66%RH	Input Power	120Vac, 60Hz
Tested By	James Yang		

Antenna Polarity & Test Distance: Horizontal at 3 M							
No.	Freq. (MHz)	Reading (dBm)	S.G Power Value (dBm)	Correction Factor (dB)	EIRP (dBm)	Limit (dBm)	Margin (dB)
1	3703.00	-52.6	-44.1	1.4	-42.7	-13.0	-29.7
Antenna Polarity & Test Distance: Vertical at 3 M							
No.	Freq. (MHz)	Reading (dBm)	S.G Power Value (dBm)	Correction Factor (dB)	EIRP (dBm)	Limit (dBm)	Margin (dB)
1	3703.00	-51.4	-43.2	1.4	-41.8	-13.0	-28.8

Remarks:

1. Output Power (dBm) = S.G Value (dBm) + Correction Factor (dB).
2. Correction Factor (dB) = Substitution Antenna Gain (dB) + Cable Loss (dB).

Mode	TX channel 18900 (1880.00MHz)	Frequency Range	Above 1000MHz
Environmental Conditions	25deg. C, 66%RH	Input Power	120Vac, 60Hz
Tested By	James Yang		

Antenna Polarity & Test Distance: Horizontal at 3 M							
No.	Freq. (MHz)	Reading (dBm)	S.G Power Value (dBm)	Correction Factor (dB)	EIRP (dBm)	Limit (dBm)	Margin (dB)
1	3760.00	-52.5	-44.0	1.3	-42.7	-13.0	-29.7
Antenna Polarity & Test Distance: Vertical at 3 M							
No.	Freq. (MHz)	Reading (dBm)	S.G Power Value (dBm)	Correction Factor (dB)	EIRP (dBm)	Limit (dBm)	Margin (dB)
1	3760.00	-51.2	-42.9	1.3	-41.6	-13.0	-28.6

Remarks:

1. Output Power (dBm) = S.G Value (dBm) + Correction Factor (dB).
2. Correction Factor (dB) = Substitution Antenna Gain (dB) + Cable Loss (dB).

Mode	TX channel 19185 (1908.50MHz)	Frequency Range	Above 1000MHz
Environmental Conditions	25deg. C, 66%RH	Input Power	120Vac, 60Hz
Tested By	James Yang		

Antenna Polarity & Test Distance: Horizontal at 3 M							
No.	Freq. (MHz)	Reading (dBm)	S.G Power Value (dBm)	Correction Factor (dB)	EIRP (dBm)	Limit (dBm)	Margin (dB)
1	3817.00	-52.3	-44.0	1.4	-42.6	-13.0	-29.6
Antenna Polarity & Test Distance: Vertical at 3 M							
No.	Freq. (MHz)	Reading (dBm)	S.G Power Value (dBm)	Correction Factor (dB)	EIRP (dBm)	Limit (dBm)	Margin (dB)
1	3817.00	-51.7	-43.5	1.4	-42.1	-13.0	-29.1

Remarks:

1. Output Power (dBm) = S.G Value (dBm) + Correction Factor (dB).
2. Correction Factor (dB) = Substitution Antenna Gain (dB) + Cable Loss (dB).

LTE Band 2, Channel Bandwidth 5MHz

Mode	TX channel 18625 (1852.50MHz)	Frequency Range	Above 1000MHz
Environmental Conditions	25deg. C, 66%RH	Input Power	120Vac, 60Hz
Tested By	James Yang		

Antenna Polarity & Test Distance: Horizontal at 3 M							
No.	Freq. (MHz)	Reading (dBm)	S.G Power Value (dBm)	Correction Factor (dB)	EIRP (dBm)	Limit (dBm)	Margin (dB)
1	3705.00	-52.1	-43.6	1.4	-42.2	-13.0	-29.2
Antenna Polarity & Test Distance: Vertical at 3 M							
No.	Freq. (MHz)	Reading (dBm)	S.G Power Value (dBm)	Correction Factor (dB)	EIRP (dBm)	Limit (dBm)	Margin (dB)
1	3705.00	-51.1	-42.9	1.4	-41.5	-13.0	-28.5

Remarks:

1. Output Power (dBm) = S.G Value (dBm) + Correction Factor (dB).
2. Correction Factor (dB) = Substitution Antenna Gain (dB) + Cable Loss (dB).

Mode	TX channel 18900 (1880.00MHz)	Frequency Range	Above 1000MHz
Environmental Conditions	25deg. C, 66%RH	Input Power	120Vac, 60Hz
Tested By	James Yang		

Antenna Polarity & Test Distance: Horizontal at 3 M							
No.	Freq. (MHz)	Reading (dBm)	S.G Power Value (dBm)	Correction Factor (dB)	EIRP (dBm)	Limit (dBm)	Margin (dB)
1	3760.00	-52.5	-44.0	1.3	-42.7	-13.0	-29.7
Antenna Polarity & Test Distance: Vertical at 3 M							
No.	Freq. (MHz)	Reading (dBm)	S.G Power Value (dBm)	Correction Factor (dB)	EIRP (dBm)	Limit (dBm)	Margin (dB)
1	3760.00	-51.7	-43.4	1.3	-42.1	-13.0	-29.1

Remarks:

1. Output Power (dBm) = S.G Value (dBm) + Correction Factor (dB).
2. Correction Factor (dB) = Substitution Antenna Gain (dB) + Cable Loss (dB).

Mode	TX channel 19175 (1907.50MHz)	Frequency Range	Above 1000MHz
Environmental Conditions	25deg. C, 66%RH	Input Power	120Vac, 60Hz
Tested By	James Yang		

Antenna Polarity & Test Distance: Horizontal at 3 M							
No.	Freq. (MHz)	Reading (dBm)	S.G Power Value (dBm)	Correction Factor (dB)	EIRP (dBm)	Limit (dBm)	Margin (dB)
1	3815.00	-52.2	-43.9	1.4	-42.5	-13.0	-29.5
Antenna Polarity & Test Distance: Vertical at 3 M							
No.	Freq. (MHz)	Reading (dBm)	S.G Power Value (dBm)	Correction Factor (dB)	EIRP (dBm)	Limit (dBm)	Margin (dB)
1	3815.00	-51.3	-43.1	1.4	-41.7	-13.0	-28.7

Remarks:

1. Output Power (dBm) = S.G Value (dBm) + Correction Factor (dB).
2. Correction Factor (dB) = Substitution Antenna Gain (dB) + Cable Loss (dB).

LTE Band 2, Channel Bandwidth 10MHz

Mode	TX channel 18650 (1855.00MHz)	Frequency Range	Above 1000MHz
Environmental Conditions	25deg. C, 66%RH	Input Power	120Vac, 60Hz
Tested By	James Yang		

Antenna Polarity & Test Distance: Horizontal at 3 M

No.	Freq. (MHz)	Reading (dBm)	S.G Power Value (dBm)	Correction Factor (dB)	EIRP (dBm)	Limit (dBm)	Margin (dB)
1	3710.00	-52.1	-43.6	1.4	-42.2	-13.0	-29.2

Antenna Polarity & Test Distance: Vertical at 3 M

No.	Freq. (MHz)	Reading (dBm)	S.G Power Value (dBm)	Correction Factor (dB)	EIRP (dBm)	Limit (dBm)	Margin (dB)
1	3710.00	-51.0	-42.8	1.4	-41.4	-13.0	-28.4

Remarks:

1. Output Power (dBm) = S.G Value (dBm) + Correction Factor (dB).
2. Correction Factor (dB) = Substitution Antenna Gain (dB) + Cable Loss (dB).

Mode	TX channel 18900 (1880.00MHz)	Frequency Range	Above 1000MHz
Environmental Conditions	25deg. C, 66%RH	Input Power	120Vac, 60Hz
Tested By	James Yang		

Antenna Polarity & Test Distance: Horizontal at 3 M

No.	Freq. (MHz)	Reading (dBm)	S.G Power Value (dBm)	Correction Factor (dB)	EIRP (dBm)	Limit (dBm)	Margin (dB)
1	3760.00	-52.3	-43.8	1.3	-42.5	-13.0	-29.5

Antenna Polarity & Test Distance: Vertical at 3 M

No.	Freq. (MHz)	Reading (dBm)	S.G Power Value (dBm)	Correction Factor (dB)	EIRP (dBm)	Limit (dBm)	Margin (dB)
1	3760.00	-51.3	-43.0	1.3	-41.7	-13.0	-28.7

Remarks:

1. Output Power (dBm) = S.G Value (dBm) + Correction Factor (dB).
2. Correction Factor (dB) = Substitution Antenna Gain (dB) + Cable Loss (dB).

Mode	TX channel 19150 (1905.00MHz)	Frequency Range	Above 1000MHz
Environmental Conditions	25deg. C, 66%RH	Input Power	120Vac, 60Hz
Tested By	James Yang		

Antenna Polarity & Test Distance: Horizontal at 3 M							
No.	Freq. (MHz)	Reading (dBm)	S.G Power Value (dBm)	Correction Factor (dB)	EIRP (dBm)	Limit (dBm)	Margin (dB)
1	3810.00	-52.3	-43.9	1.3	-42.6	-13.0	-29.6
Antenna Polarity & Test Distance: Vertical at 3 M							
No.	Freq. (MHz)	Reading (dBm)	S.G Power Value (dBm)	Correction Factor (dB)	EIRP (dBm)	Limit (dBm)	Margin (dB)
1	3810.00	-51.4	-43.1	1.3	-41.8	-13.0	-28.8

Remarks:

1. Output Power (dBm) = S.G Value (dBm) + Correction Factor (dB).
2. Correction Factor (dB) = Substitution Antenna Gain (dB) + Cable Loss (dB).

LTE Band 2, Channel Bandwidth 15MHz

Mode	TX channel 18675 (1857.50MHz)	Frequency Range	Above 1000MHz
Environmental Conditions	25deg. C, 66%RH	Input Power	120Vac, 60Hz
Tested By	James Yang		

Antenna Polarity & Test Distance: Horizontal at 3 M

No.	Freq. (MHz)	Reading (dBm)	S.G Power Value (dBm)	Correction Factor (dB)	EIRP (dBm)	Limit (dBm)	Margin (dB)
1	3715.00	-52.3	-43.8	1.4	-42.4	-13.0	-29.4

Antenna Polarity & Test Distance: Vertical at 3 M

No.	Freq. (MHz)	Reading (dBm)	S.G Power Value (dBm)	Correction Factor (dB)	EIRP (dBm)	Limit (dBm)	Margin (dB)
1	3715.00	-51.6	-43.4	1.4	-42.0	-13.0	-29.0

Remarks:

1. Output Power (dBm) = S.G Value (dBm) + Correction Factor (dB).
2. Correction Factor (dB) = Substitution Antenna Gain (dB) + Cable Loss (dB).

Mode	TX channel 18900 (1880.00MHz)	Frequency Range	Above 1000MHz
Environmental Conditions	25deg. C, 66%RH	Input Power	120Vac, 60Hz
Tested By	James Yang		

Antenna Polarity & Test Distance: Horizontal at 3 M

No.	Freq. (MHz)	Reading (dBm)	S.G Power Value (dBm)	Correction Factor (dB)	EIRP (dBm)	Limit (dBm)	Margin (dB)
1	3760.00	-52.4	-43.9	1.3	-42.6	-13.0	-29.6

Antenna Polarity & Test Distance: Vertical at 3 M

No.	Freq. (MHz)	Reading (dBm)	S.G Power Value (dBm)	Correction Factor (dB)	EIRP (dBm)	Limit (dBm)	Margin (dB)
1	3760.00	-51.7	-43.4	1.3	-42.1	-13.0	-29.1

Remarks:

1. Output Power (dBm) = S.G Value (dBm) + Correction Factor (dB).
2. Correction Factor (dB) = Substitution Antenna Gain (dB) + Cable Loss (dB).

Mode	TX channel 19125 (1902.50MHz)	Frequency Range	Above 1000MHz
Environmental Conditions	25deg. C, 66%RH	Input Power	120Vac, 60Hz
Tested By	James Yang		

Antenna Polarity & Test Distance: Horizontal at 3 M							
No.	Freq. (MHz)	Reading (dBm)	S.G Power Value (dBm)	Correction Factor (dB)	EIRP (dBm)	Limit (dBm)	Margin (dB)
1	3805.00	-52.3	-43.9	1.3	-42.6	-13.0	-29.6
Antenna Polarity & Test Distance: Vertical at 3 M							
No.	Freq. (MHz)	Reading (dBm)	S.G Power Value (dBm)	Correction Factor (dB)	EIRP (dBm)	Limit (dBm)	Margin (dB)
1	3805.00	-51.2	-43.0	1.3	-41.7	-13.0	-28.7

Remarks:

1. Output Power (dBm) = S.G Value (dBm) + Correction Factor (dB).
2. Correction Factor (dB) = Substitution Antenna Gain (dB) + Cable Loss (dB).

LTE Band 2, Channel Bandwidth 20MHz

Mode	TX channel 18700 (1860.00MHz)	Frequency Range	Above 1000MHz
Environmental Conditions	25deg. C, 66%RH	Input Power	120Vac, 60Hz
Tested By	James Yang		

Antenna Polarity & Test Distance: Horizontal at 3 M							
No.	Freq. (MHz)	Reading (dBm)	S.G Power Value (dBm)	Correction Factor (dB)	EIRP (dBm)	Limit (dBm)	Margin (dB)
1	3720.00	-52.1	-43.6	1.4	-42.2	-13.0	-29.2
Antenna Polarity & Test Distance: Vertical at 3 M							
No.	Freq. (MHz)	Reading (dBm)	S.G Power Value (dBm)	Correction Factor (dB)	EIRP (dBm)	Limit (dBm)	Margin (dB)
1	3720.00	-51.2	-43.0	1.4	-41.6	-13.0	-28.6

Remarks:

1. Output Power (dBm) = S.G Value (dBm) + Correction Factor (dB).
2. Correction Factor (dB) = Substitution Antenna Gain (dB) + Cable Loss (dB).

Mode	TX channel 18900 (1880.00MHz)	Frequency Range	Above 1000MHz
Environmental Conditions	25deg. C, 66%RH	Input Power	120Vac, 60Hz
Tested By	James Yang		

Antenna Polarity & Test Distance: Horizontal at 3 M							
No.	Freq. (MHz)	Reading (dBm)	S.G Power Value (dBm)	Correction Factor (dB)	EIRP (dBm)	Limit (dBm)	Margin (dB)
1	3760.00	-52.3	-43.8	1.3	-42.5	-13.0	-29.5
Antenna Polarity & Test Distance: Vertical at 3 M							
No.	Freq. (MHz)	Reading (dBm)	S.G Power Value (dBm)	Correction Factor (dB)	EIRP (dBm)	Limit (dBm)	Margin (dB)
1	3760.00	-51.1	-42.8	1.3	-41.5	-13.0	-28.5

Remarks:

1. Output Power (dBm) = S.G Value (dBm) + Correction Factor (dB).
2. Correction Factor (dB) = Substitution Antenna Gain (dB) + Cable Loss (dB).

Mode	TX channel 19100 (1900.00MHz)	Frequency Range	Above 1000MHz
Environmental Conditions	25deg. C, 66%RH	Input Power	120Vac, 60Hz
Tested By	James Yang		

Antenna Polarity & Test Distance: Horizontal at 3 M							
No.	Freq. (MHz)	Reading (dBm)	S.G Power Value (dBm)	Correction Factor (dB)	EIRP (dBm)	Limit (dBm)	Margin (dB)
1	3800.00	-52.5	-44.1	1.3	-42.8	-13.0	-29.8
Antenna Polarity & Test Distance: Vertical at 3 M							
No.	Freq. (MHz)	Reading (dBm)	S.G Power Value (dBm)	Correction Factor (dB)	EIRP (dBm)	Limit (dBm)	Margin (dB)
1	3800.00	-51.2	-43.0	1.3	-41.7	-13.0	-28.7

Remarks:

1. Output Power (dBm) = S.G Value (dBm) + Correction Factor (dB).
2. Correction Factor (dB) = Substitution Antenna Gain (dB) + Cable Loss (dB).

5 Pictures of Test Arrangements

Please refer to the attached file (Test Setup Photo).

Appendix – Information on the Testing Laboratories

We, Bureau Veritas Consumer Products Services (H.K.) Ltd., Taoyuan Branch, were founded in 1988 to provide our best service in EMC, Radio, Telecom and Safety consultation. Our laboratories are FCC recognized accredited test firms and accredited and approved according to ISO/IEC 17025.

If you have any comments, please feel free to contact us at the following:

Linko EMC/RF Lab

Tel: 886-2-26052180
Fax: 886-2-26051924

Hsin Chu EMC/RF/Telecom Lab

Tel: 886-3-6668565
Fax: 886-3-6668323

Hwa Ya EMC/RF/Safety Lab

Tel: 886-3-3183232
Fax: 886-3-3270892

Email: service.adt@tw.bureauveritas.com

Web Site: www.bureauveritas-adt.com

The address and road map of all our labs can be found in our web site also.

--- END ---