



Zacta

# TEST REPORT

Report number : JPD-TR-16232-0

Issue date : January 13, 2017

The device, as described herewith, was tested pursuant to applicable test procedure and complies with the requirements of;

## FCC Part 24 Subpart E

The test results are traceable to the international or national standards.

Applicant	: KYOCERA Corporation
Equipment under test (EUT)	: Mobile Phone
Model number	: DA27
FCC ID	: JOYDA27

Date of test : October 19, 27, 2016  
November 16, 2016  
December 9, 12, 26, 2016

Test place : TÜV SÜD Zacta Ltd. Yonezawa Testing Center  
5-4149-7, Hachimanpara, Yonezawa-shi,  
Yamagata, 992-1128 Japan  
Phone: +81-238-28-2881 Fax: +81-238-28-2888

Test results : Complied

The results in this report are applicable only to the equipment tested.  
This report shall not be re-produced except in full without the written approval of TÜV SÜD Zacta Ltd.  
This test report must not be used by the client to claim product certification, approval, or endorsement by NVLAP, NIST, or any agency of the federal government.

Tested by : Tadahiro Seino      Kazunori Saito  
Tadahiro Seino      Kazunori Saito

Approved by : Hiroaki Suzuki  
Hiroaki Suzuki  
Lab Manager of RF Lab



## ***Table of contents***

---

	<b>Page</b>
<b>1. Summary of Test .....</b>	<b>4</b>
1.1 Purpose of test .....	4
1.2 Standards .....	4
1.3 List of applied test to the EUT .....	4
1.4 Modification to the EUT by laboratory .....	4
<b>2. Equipment Under Test .....</b>	<b>5</b>
2.1 General Description of equipment .....	5
2.2 EUT information .....	5
2.3 Variation of the family model(s) .....	6
2.4 Description of Test mode .....	6
<b>3. Configuration of equipment .....</b>	<b>7</b>
3.1 Equipment(s) used .....	7
3.2 System configuration .....	7
<b>4. Conducted Output Power .....</b>	<b>8</b>
4.1 Measurement procedure .....	8
4.2 Measurement result .....	8
<b>5. Equivalent Isotropic Radiated Power .....</b>	<b>9</b>
5.1 Measurement procedure .....	9
5.2 Calculation method .....	10
5.3 Limit .....	10
5.4 Test data .....	11
<b>6. Peak to Average Ratio .....</b>	<b>12</b>
6.1 Measurement procedure .....	12
6.2 Limit .....	12
6.3 Measurement result .....	12
6.4 Trace data .....	13
<b>7. Occupied Bandwidth .....</b>	<b>14</b>
7.1 Measurement procedure .....	14
7.2 Limit .....	14
7.3 Measurement result .....	14
7.4 Trace data .....	15
<b>8. Band Edge Spurious and Harmonic at Antenna Terminals .....</b>	<b>16</b>
8.1 Measurement procedure .....	16
8.2 Limit .....	16
8.3 Measurement result .....	16
8.4 Trace data .....	17
<b>9. Radiated Emissions and Harmonic Emissions .....</b>	<b>21</b>
9.1 Measurement procedure .....	21
9.2 Calculation method .....	22
9.3 Limit .....	22
9.4 Test data .....	23
<b>10. Frequency Stability .....</b>	<b>24</b>
10.1 Measurement procedure .....	24



Zacta

<b>10.2 Limit.....</b>	<b>24</b>
<b>10.3 Measurement result.....</b>	<b>25</b>
<b>11. Uncertainty of measurement.....</b>	<b>26</b>
<b>12. Laboratory Information.....</b>	<b>27</b>
<b>Appendix A. Test equipment.....</b>	<b>28</b>

## 1. Summary of Test

---

### 1.1 Purpose of test

It is the original test in order to verify conformance to FCC Part 24 Subpart E.

### 1.2 Standards

CFR47 FCC Part 24 Subpart E

#### 1.2.1 Test Methods

KDB 971168 D01 Power Meas License Digital Systems v02r02  
ANSI/TIA/EIA-603-D-2010

#### 1.2.2 Deviation from standards

None

### 1.3 List of applied test to the EUT

Test items Section	Test items	Condition	Result
2.1046	Conducted Output Power	Conducted	PASS
24.232(c)	Effective Radiated Power Equivalent Isotropic Radiated Power	Radiated	PASS
24.232(d)	Peak to Average Ratio	Conducted	PASS
24.238(a) 2.1049	Occupied Bandwidth	Conducted	PASS
24.238(a) 2.1051	Band Edge Spurious and Harmonic at Antenna Terminal	Conducted	PASS
24.238(a) 2.1053	Radiated emissions and Harmonic Emissions	Radiated	PASS
24.235 2.1055	Frequency Stability	Conducted	PASS

#### 1.3.1 Test set up

Table-Top

### 1.4 Modification to the EUT by laboratory

None



Zacta

## **2. Equipment Under Test**

---

### **2.1 General Description of equipment**

EUT is the Mobile Phone.

### **2.2 EUT information**

Applicant	:	KYOCERA Corporation Yokohama Office 2-1-1 Kagahara, Tsuzuki-ku Yokohama-shi, Kanagawa, Japan Phone: +81-45-943-6253 Fax: +81-45-943-6314
Equipment under test	:	Mobile Phone
Trade name	:	Kyocera
Model number	:	DA27
Serial number	:	N/A
EUT condition	:	Pre-Production
Power ratings	:	Battery: DC 3.7V
Size	:	(W) 54.0 × (D) 24.6 × (H) 118.0 mm
Environment	:	Indoor and Outdoor use
Terminal limitation	:	-20°C to 60°C
RF Specification Frequency of Operation	:	Up Link GSM1900: 1850.2-1909.8MHz  Down Link GSM1900: 1930.2-1989.8MHz
Modulation type	:	GSM1900: GMSK
Emission designator	:	GSM1900: 247KGXW
Output power	:	GSM1900: 0.940W (29.73dBm)
Antenna type	:	Internal antenna
Antenna gain	:	GSM1900: -0.7dBi

### 2.3 Variation of the family model(s)

Not applicable

### 2.4 Description of Test mode

The EUT had been tested under operating condition.  
There are three channels have been tested as following:

Band	Channel	Frequency
GSM1900	512	1850.2MHz
	661	1880.0MHz
	810	1909.8MHz

The field strength of spurious emissions was measured at each position of all three axis X, Y and Z to compare the level, and the maximum noise.

The worst emission was found in X axis and the worst case recorded.



Zacta

### ***3. Configuration of equipment***

---

#### **3.1 Equipment(s) used**

<b>No.</b>	<b>Equipment</b>	<b>Company</b>	<b>Model No.</b>	<b>Serial No.</b>	<b>FCC ID / DoC</b>	<b>Comment</b>
1	Mobile Phone	KYOCERA	DA27	N/A	JOYDA27	EUT

#### **3.2 System configuration**

1. Mobile Phone  
(EUT)

Note1: Numbers assigned to equipment or cables on this diagram correspond to the list in "3.1 Equipment(s) used".

## 4. Conducted Output Power

### 4.1 Measurement procedure [FCC 2.1046]

The conducted output power was measured with a wireless communication tester connected to the antenna terminal. The wireless communication tester parameters were set to produce the maximum power from the EUT.

- Test configuration

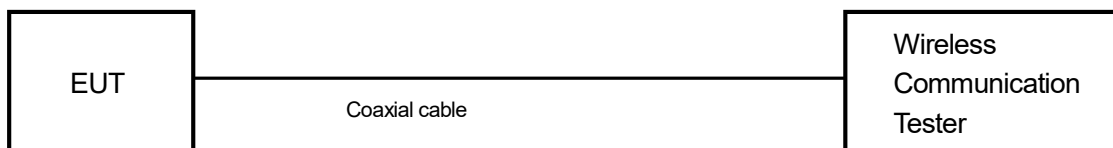

### 4.2 Measurement result

Date : October 19, 2016

Temperature : 24.2 [°C]

Humidity : 46.3 [%]

Test place : Shielded room No.4

Test engineer :

Kazunori Saito

Band	Channel	Frequency [MHz]	Maximum Burst-Averaged Output Power [dBm]				
			Voice GSM CS 1slot	GPRS/EDGE(GMSK)Data			
				GPRS 1 TX Slot	GPRS 2 TX Slot	GPRS 3 TX Slot	GPRS 4 TX Slot
PCS 1900	512	1850.2	29.73	29.71	28.24	26.13	24.14
	661	1880.0	29.67	29.68	28.13	25.99	24.06
	810	1909.8	29.60	29.58	28.02	25.85	24.19



## 5. Equivalent Isotropic Radiated Power

### 5.1 Measurement procedure [FCC 24.232(c)]

#### <Step 1>

The EUT and support equipment are placed on a 1 meter x 1 meter surface, 0.8 meter height styrene foam table. Radiated emission measurements are performed at 3 meter distance with the broadband antenna (double ridged guide antenna). The antenna is positioned both the horizontal and vertical planes of polarization and height is varied 1 to 4 meters and stopped at height producing the maximum emission. The bandwidth of the spectrum analyzer is set to 1MHz. The turntable is rotated by 360 degrees and stopped at azimuth of producing the maximum emission.

#### <Step 2>

The substitution antenna is replaced by the transmitter antenna (EUT). The frequency of the signal generator is adjusted to the measurement frequency. Level of the signal generator is adjusted to the level that is obtained from step 1, and record the emission level of signal generator.

The spectrum analyzer is set to;

- a) Span = 1.5 times the OBW
- b) RBW = 1-5% of the expected OBW, not to exceed 1MHz
- c) VBW  $\geq 3 \times$  RBW
- d) Number of sweep points  $\geq 2 \times$  span / RBW
- e) Sweep time = auto-couple
- f) Detector = RMS (power averaging)
- g) If the EUT can be configured to transmit continuously (i.e., burst duty cycle  $\geq 98\%$ ), then set the trigger to free run.
- h) If the EUT cannot be configured to transmit continuously (i.e., burst duty cycle  $< 98\%$ ), then use a sweep trigger with the level set to enable triggering only on full power bursts and configure the EUT to transmit at full power for the entire duration of each sweep. Ensure that the sweep time is less than or equal to the transmission burst duration.
- i) Trace average at least 100 traces in power averaging (i.e., RMS) mode.
- j) Compute the power by integrating the spectrum across the OBW of the signal using the instrument's band power measurement function, with the band limits set equal to the OBW band edges. If the instrument does not have a band power function, then sum the spectrum levels (in linear power units) at intervals equal to the RBW extending across the entire OBW of the spectrum.

#### - Test configuration

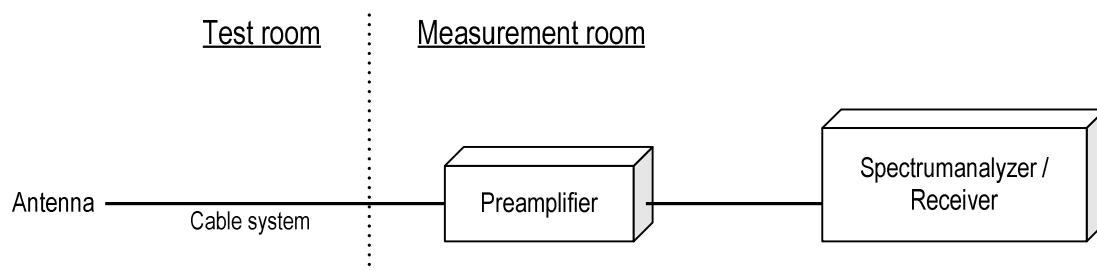

## 5.2 Calculation method

Result (EIRP) = S.G Reading – Cable loss + Antenna Gain  
Margin = Limit – Result (EIRP)

Example:

Limit @ 1880MHz : 33.0dBm

S.G Reading = 19.3dBm Cable loss = 1.1dB Ant. Gain = 8.3dBi

Result =  $19.3 - 1.1 + 8.3 = 26.5$ dBm

Margin =  $33.0 - 26.5 = 6.5$ dB

## 5.3 Limit

2 W (33dBm)

#### 5.4 Test data

Date : December 9, 2016  
 Temperature : 21.9 [°C]  
 Humidity : 21.6 [%]  
 Test place : 3m Semi-anechoic chamber

Test engineer :

Kazunori Saito

Date : December 26, 2016  
 Temperature : 21.9 [°C]  
 Humidity : 22.8 [%]  
 Test place : 3m Semi-anechoic chamber

Test engineer :

Kazunori Saito

#### [GSM1900]

H/V	Frequency [MHz]	S.A Reading [dBm]	S.G Reading [dBm]	Cable loss [dB]	Ant.Gain [dBi]	Result [dBm]	Limit [dBm]	Margin [dB]
H	1850.2	-24.0	23.9	1.1	8.3	31.1	33.0	1.9
H	1880.0	-25.0	23.3	1.1	8.3	30.4	33.0	2.6
H	1909.8	-26.2	22.1	1.1	8.3	29.2	33.0	3.8

## 6. Peak to Average Ratio

### 6.1 Measurement procedure [FCC 24.232(d)]

The peak to average ratio was measured with a spectrum analyzer connected to the antenna terminal.

The spectrum analyzer is set to;

- a) Span = 5MHz
- b) RBW = 1MHz
- c) VBW  $\geq 3 \times$  RBW
- d) Detector = Peak / Average
- e) Sweep time = auto-couple
- f) Trace mode=Max hold

- Test configuration

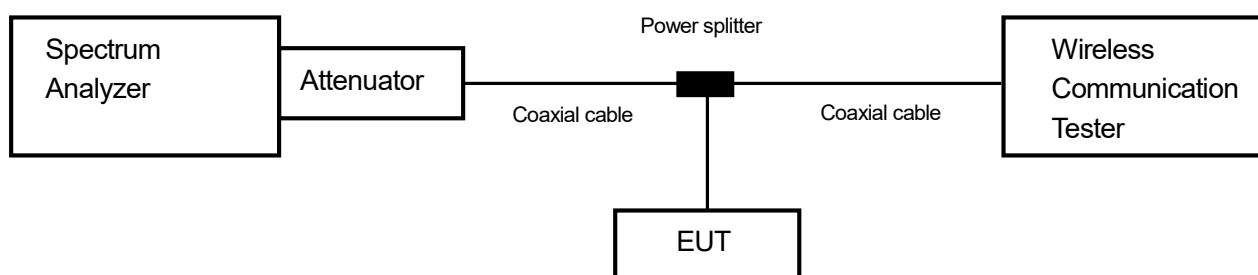

### 6.2 Limit

13dB or less

### 6.3 Measurement result

Date : October 27, 2016  
 Temperature : 23.6 [°C]  
 Humidity : 47.7 [%]  
 Test place : Shielded room No.4

Test engineer : Kazunori Saito

Mode	Channel	Frequency [MHz]	Peak to Average Power Ratio [dB]	Limit [dB]
GSM1900	512	1850.2	0.16	13.0
	661	1880.0	0.02	
	810	1909.8	0.08	



Zacta

### 6.4 Trace data [GSM1900]

#### Channel: 512

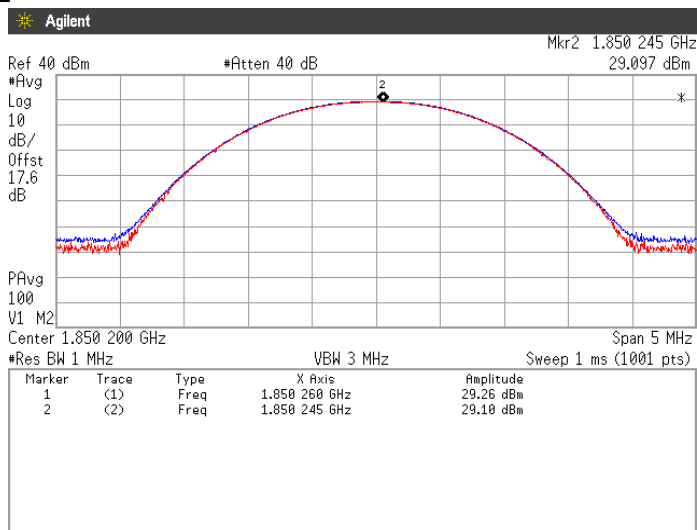

#### Channel: 661

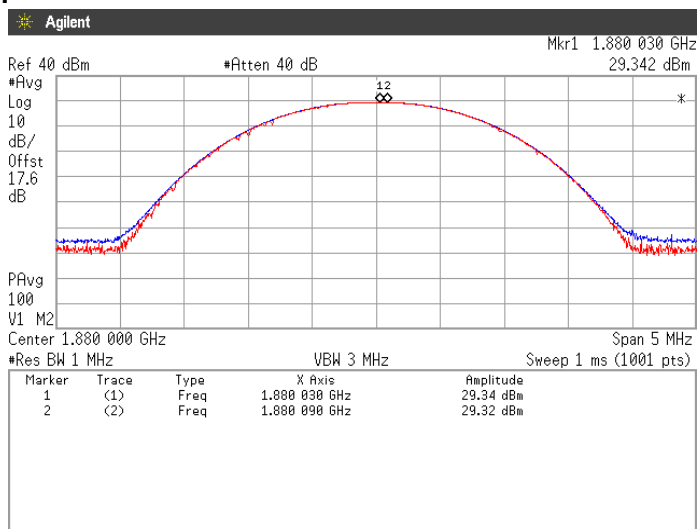

#### Channel: 810

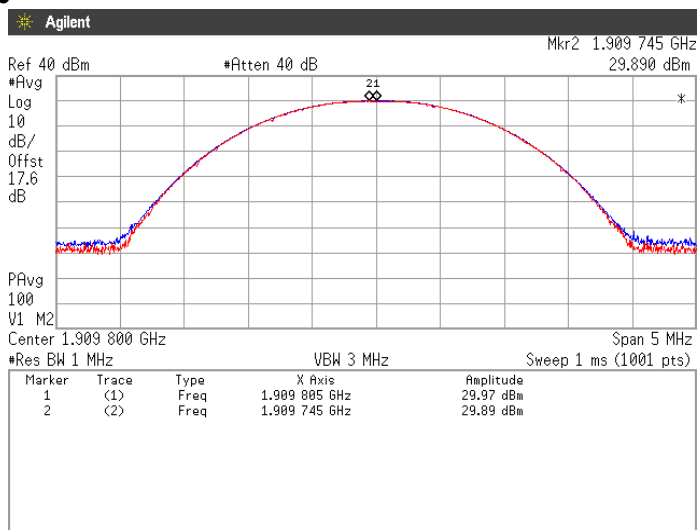

## 7. Occupied Bandwidth

### 7.1 Measurement procedure [FCC 24.238(a), 2.1049]

The Occupied bandwidth was measured with a spectrum analyzer connected to the antenna terminal.

The spectrum analyzer is set to;

- a) RBW = 1-5% of the expected OBW & VBW  $\geq 3 \times$  RBW
- b) Detector = Peak
- c) Trace mode = Max hold
- d) Sweep time = auto-couple

- Test configuration

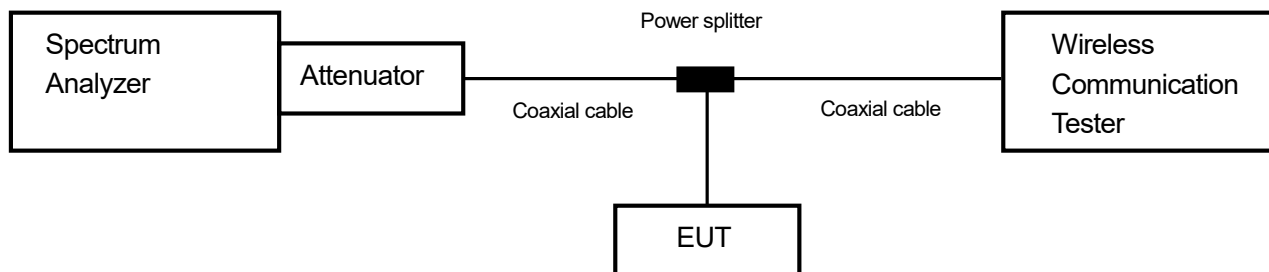

### 7.2 Limit

None

### 7.3 Measurement result

Date : October 27, 2016

Temperature : 23.6 [°C]

Humidity : 47.7 [%]

Test place : Shielded room No.4

Test engineer :

Kazunori Saito

Band	Channel	Frequency (MHz)	Test Result (kHz)
GSM1900	512	1850.2	242.6954
	661	1880.0	246.6023
	810	1909.8	244.4876



Zacta

### 7.4 Trace data [GSM1900]

#### Channel: 512

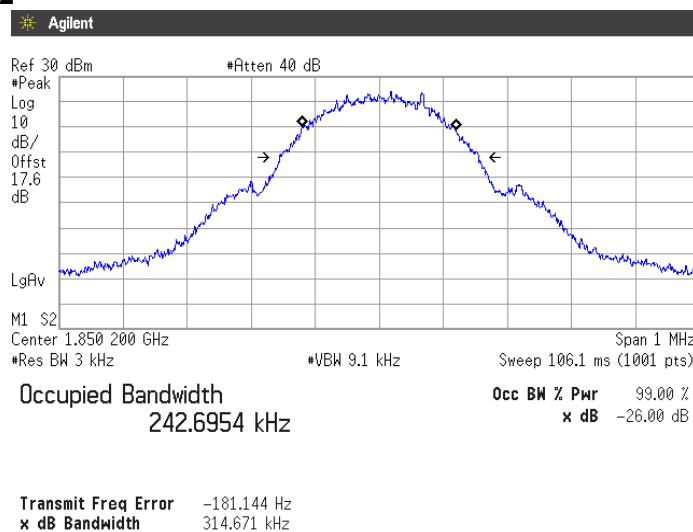

#### Channel: 661

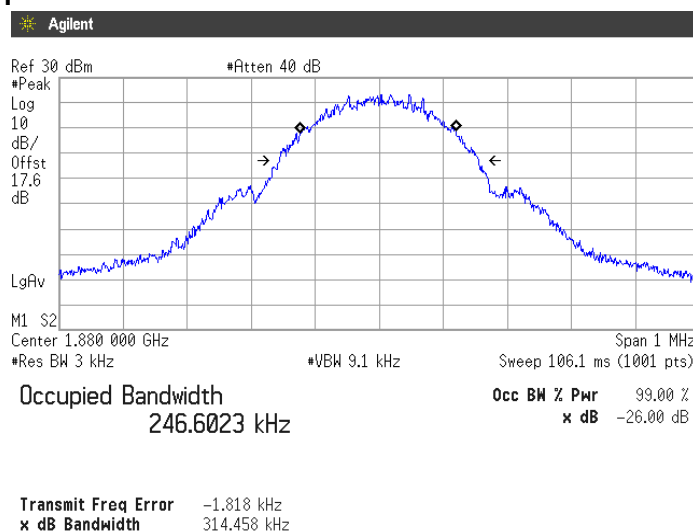

#### Channel: 810

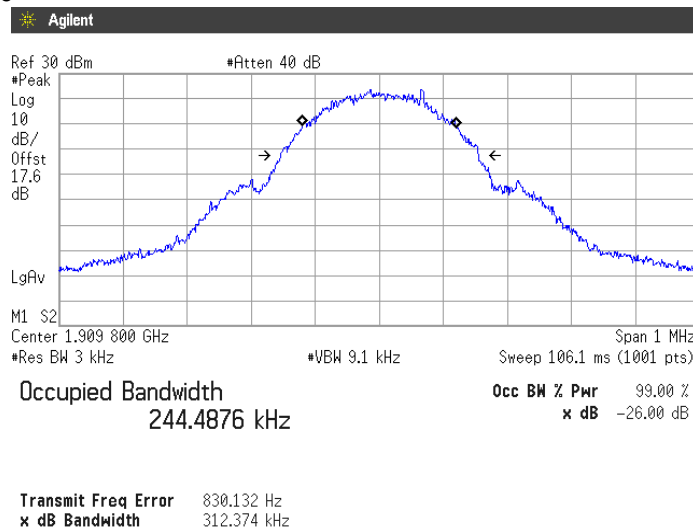

## 8. Band Edge Spurious and Harmonic at Antenna Terminals

### 8.1 Measurement procedure

[FCC 24.238(a), 2.1051]

The band edge spurious and harmonic was measured with a spectrum analyzer connected to the antenna terminal.

The spectrum analyzer is set to;

<Band Edge>

- a) Span was set large enough so as to capture all out of band emissions near the band edge
- b) RBW  $\geq$  1% of the emission bandwidth or 2% of the emission bandwidth
- c) VBW  $\geq$  3 x RBW
- d) Detector = RMS
- e) Trace mode = Max hold
- f) Sweep time = auto-couple
- g) Number of sweep point  $\geq$  2 x span / RBW

<Spurious Emissions>

- a) RBW = 1MHz & VBW  $\geq$  3 x RBW
- b) Detector = Peak
- c) Trace mode = Max hold
- d) Sweep time = auto-couple
- e) Number of sweep point  $\geq$  2 x span / RBW

- Test configuration

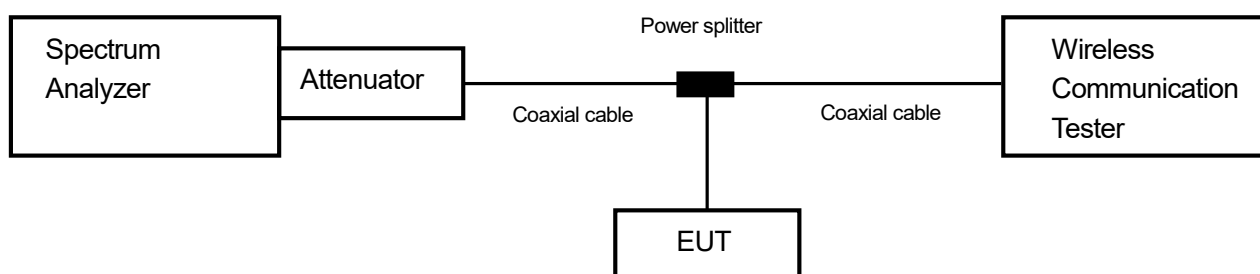

### 8.2 Limit

-13dBm or less

### 8.3 Measurement result

Date : October 27, 2016  
 Temperature : 23.6 [°C]  
 Humidity : 47.7 [%]  
 Test place : Shielded room No.4

Test engineer :

Kazunori Saito

Band	Channel	Frequency [MHz]	Limit [dB]	Results	Results
GSM1900	512	1850.2	-13.0	See the trace data	PASS
	810	1909.8	-13.0	See the trace data	PASS



**8.4 Trace data  
[GSM1900]  
(Band Edge)**

**Channel: 512**

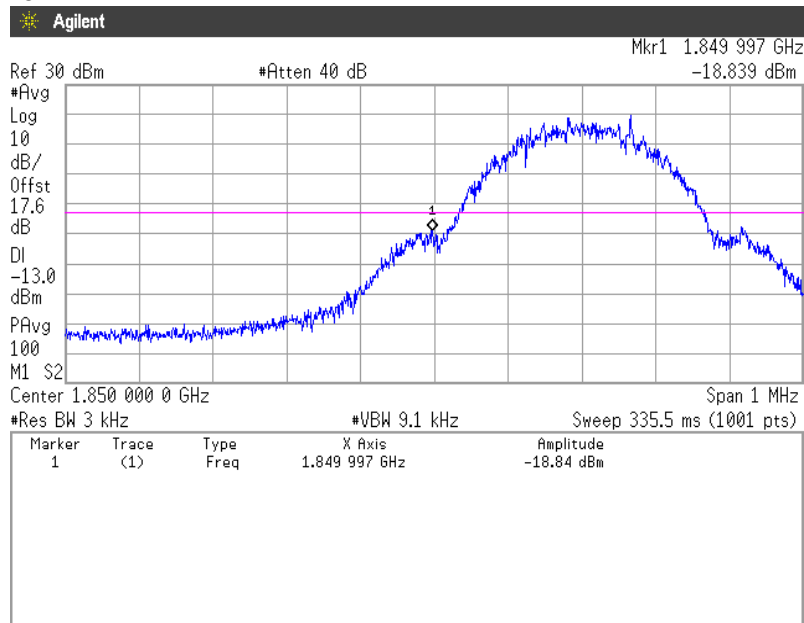

**Channel: 810**

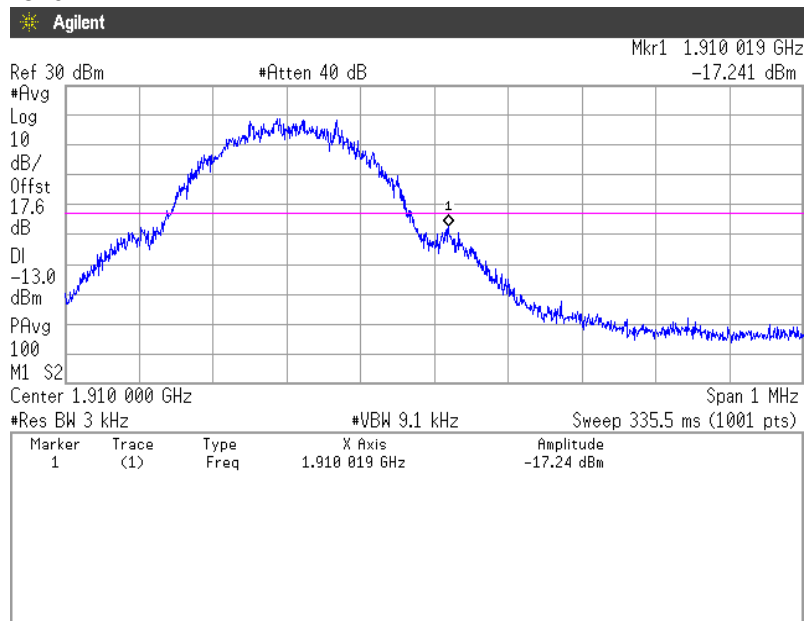



Zacta

**(Spurious Emissions)**

**Note: Conducted spurious test was measured in the worst case of conducted output power.**

**Channel: 512  
30MHz-5GHz**

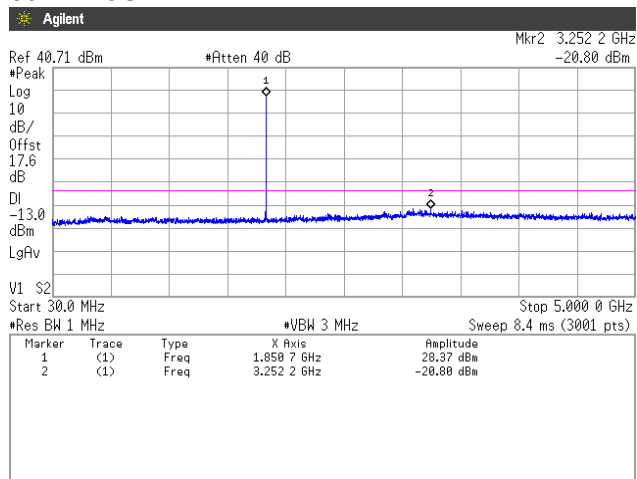

**5GHz-10GHz**

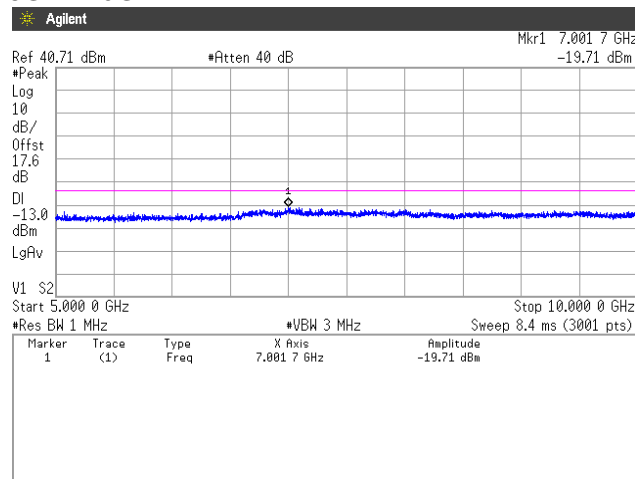

**10GHz-15GHz**

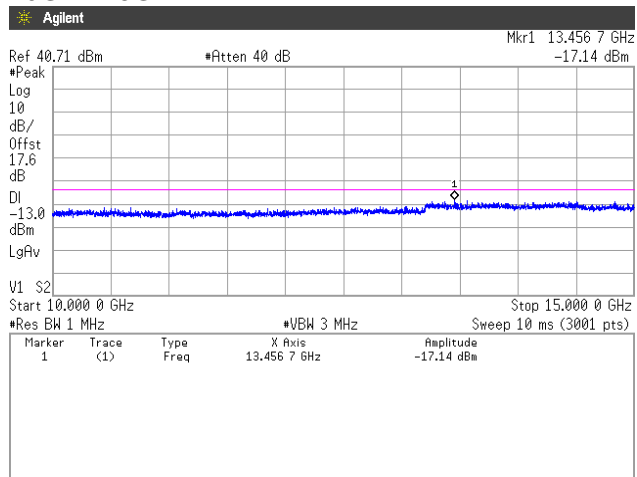

**15GHz-20GHz**

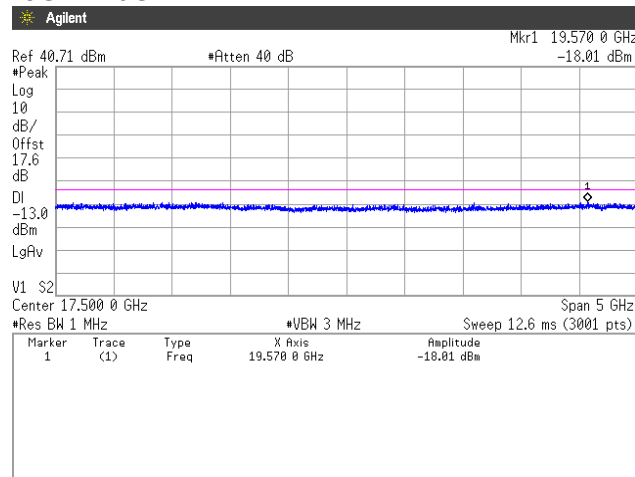



Zacta

### Channel: 661 30MHz-5GHz

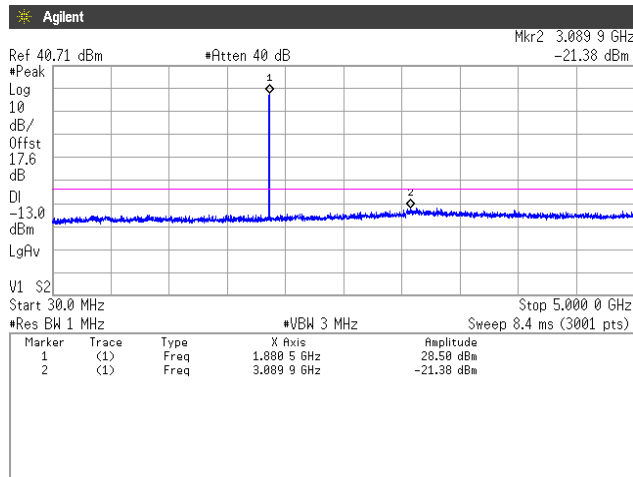

### 5GHz-10GHz

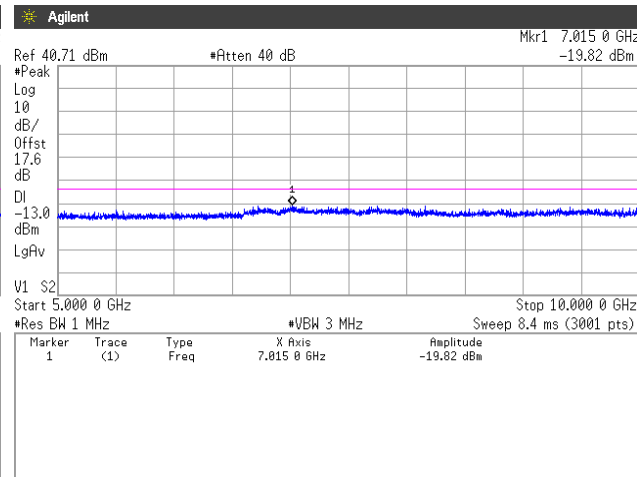

### 10GHz-15GHz

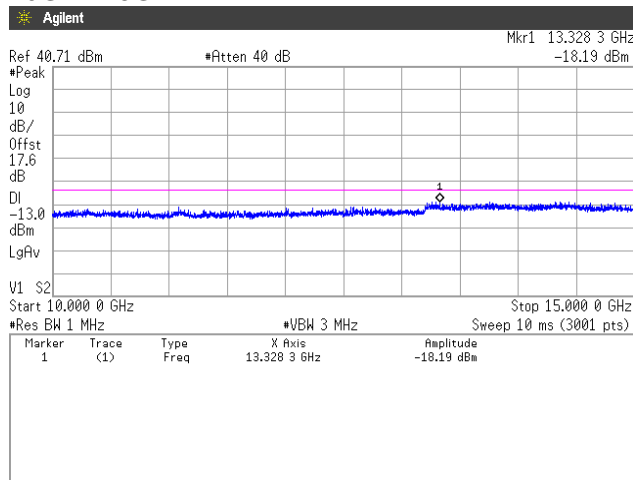

### 15GHz-20GHz

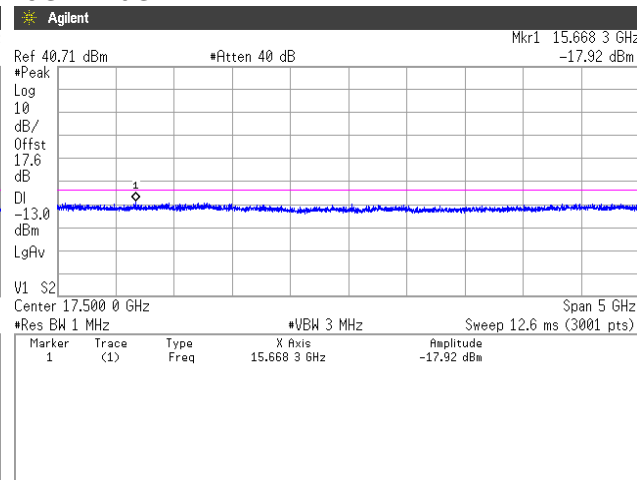



Zacta

**Channel: 810**  
**30MHz-5GHz**

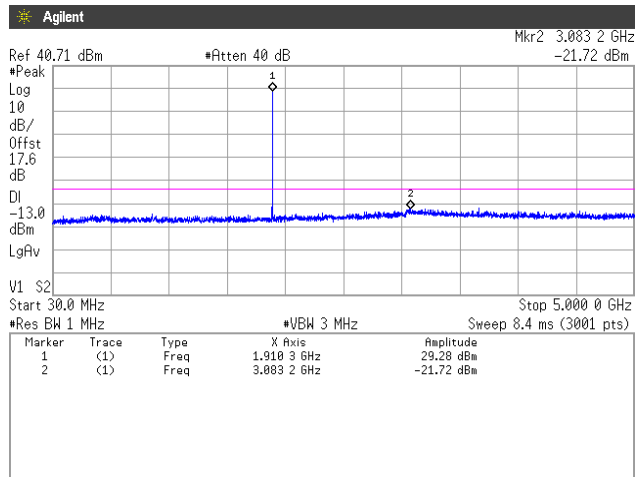

**5GHz-10GHz**

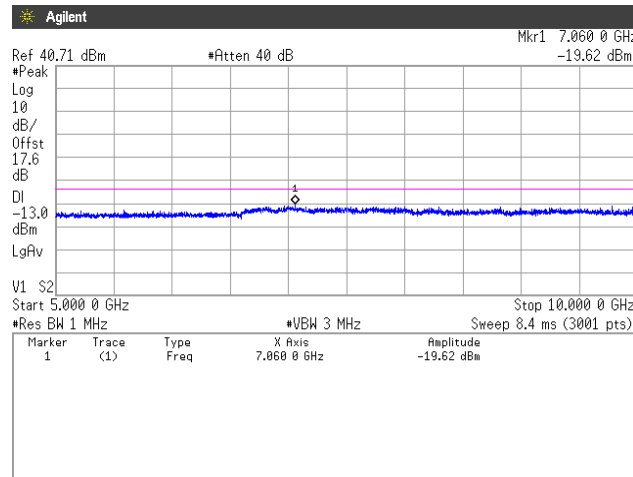

**10GHz-15GHz**

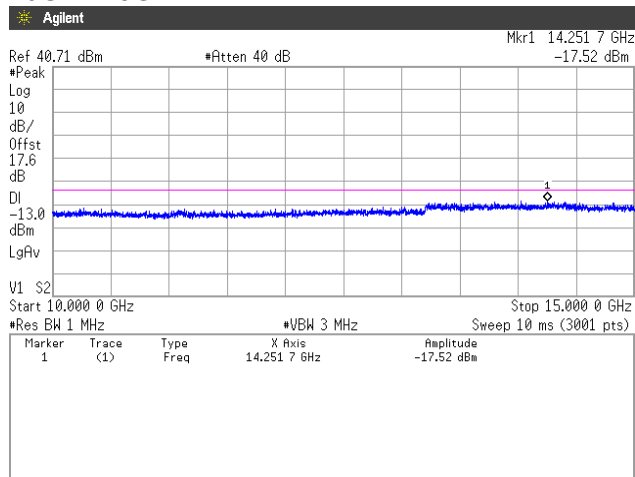

**15GHz-20GHz**

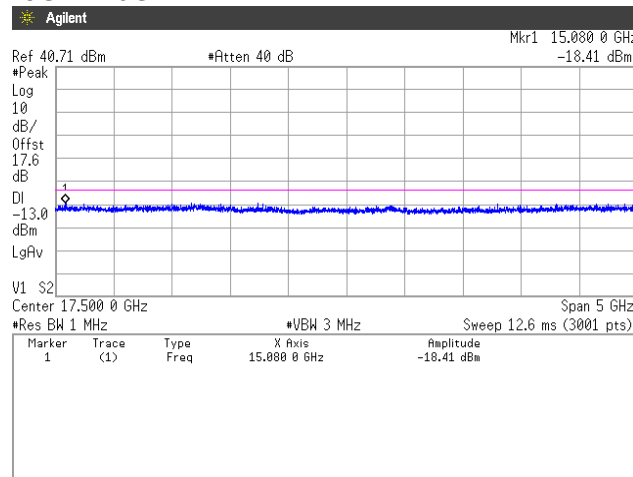

## 9. Radiated Emissions and Harmonic Emissions

### 9.1 Measurement procedure [FCC 24.238(a), 2.1053]

#### <Step 1>

The EUT and support equipment are placed on a 1 meter x 1 meter surface, 0.8 meter height styrene foam table. Radiated emission measurements are performed at 3 meter distance with the broadband antenna (Biconical antenna, Log periodic antenna and double ridged guide antenna). The antenna is positioned both the horizontal and vertical planes of polarization and height is varied 1 to 4 meters and stopped at height producing the maximum emission.

The bandwidth of the spectrum analyzer is set to 1MHz. The turntable is rotated by 360 degrees and stopped at azimuth of producing the maximum emission. The frequency is investigated up to 20GHz.

#### <Step 2>

The substitution antenna is replaced by the transmitter antenna (EUT).

The frequency of the signal generator is adjusted to the measurement frequency.

Level of the signal generator is adjusted to the level that is obtained from step 1, and record the emission level of signal generator.

The spectrum analyzer is set to;

- a) RBW = 100kHz for below 1GHz and 1MHz for above 1GHz / VBW  $\geq$  3 x RBW
- b) Detector = Peak
- c) Trace mode = Max hold
- d) Sweep time = auto-couple

#### - Test configuration

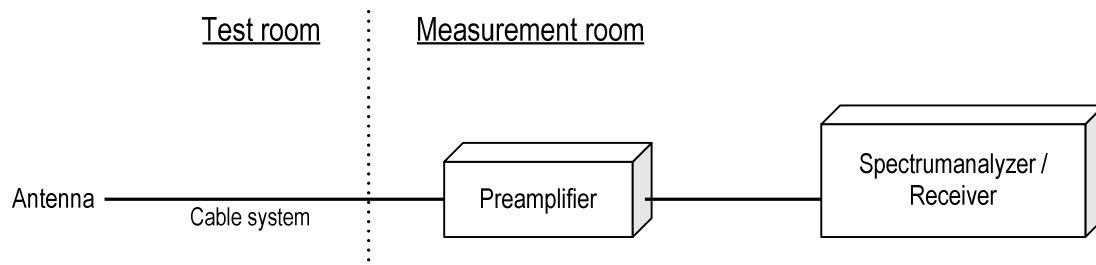

## 9.2 Calculation method

Result = S.G Reading – Cable loss + Antenna Gain  
Margin = Limit – Result (EIRP)

Example:

Limit @ 3700.4MHz : -13.0dBm  
S.G Reading = -55.6dBm Cable loss = 1.6dB Ant. Gain = 9.2dBi  
Result = -55.6 - 1.6 + 9.2 = -49.3dBm  
Margin = -13.0 - (-49.3) = 36.3dB

## 9.3 Limit

-13dBm or less



Zacta

#### 9.4 Test data

Date : December 9, 2016  
 Temperature : 21.9 [°C]  
 Humidity : 21.6 [%]  
 Test place : 3m Semi-anechoic chamber  
 Test engineer : Kazunori Saito

Date : December 12, 2016  
 Temperature : 21.5 [°C]  
 Humidity : 21.4 [%]  
 Test place : 3m Semi-anechoic chamber  
 Test engineer : Kazunori Saito

Date : December 26, 2016  
 Temperature : 21.9 [°C]  
 Humidity : 22.8 [%]  
 Test place : 3m Semi-anechoic chamber  
 Test engineer : Kazunori Saito

#### [GSM1900] (Channel: 512)

H/V	Frequency [MHz]	S.A Reading [dBm]	S.G Reading [dBm]	Cable loss [dB]	Ant.Gain [dBi]	Result [dBm]	Limit [dBm]	Margin [dB]
H	3700.4	-52.1	-49.5	1.6	9.2	-41.9	-13.0	28.9
V	3700.4	-51.5	-48.6	1.6	9.2	-41.0	-13.0	28.0

#### (Channel: 661)

H/V	Frequency [MHz]	S.A Reading [dBm]	S.G Reading [dBm]	Cable loss [dB]	Ant.Gain [dBi]	Result [dBm]	Limit [dBm]	Margin [dB]
H	3760.0	-51.5	-47.4	1.6	9.3	-39.7	-13.0	26.7
V	3760.0	-52.7	-49.6	1.6	9.3	-41.9	-13.0	28.9

#### (Channel: 810)

H/V	Frequency [MHz]	S.A Reading [dBm]	S.G Reading [dBm]	Cable loss [dB]	Ant.Gain [dBi]	Result [dBm]	Limit [dBm]	Margin [dB]
H	3819.6	-54.5	-54.3	1.6	9.3	-46.6	-13.0	33.6
V	3819.6	-55.7	-55.9	1.6	9.3	-48.2	-13.0	35.2

## 10. Frequency Stability

### 10.1 Measurement procedure [FCC 24.235, 2.1055]

The EUT was placed inside of a constant temperature chamber as the temperature in the chamber was varied between  $-30^{\circ}\text{C}$  and  $+50^{\circ}\text{C}$ . The temperature was incremented by  $10^{\circ}\text{C}$  intervals and the unit was allowed to stabilize at each measurement. The frequency drift was measured with the normal Temperature and voltage tolerance and it is presented as the ppm unit.

- Test configuration

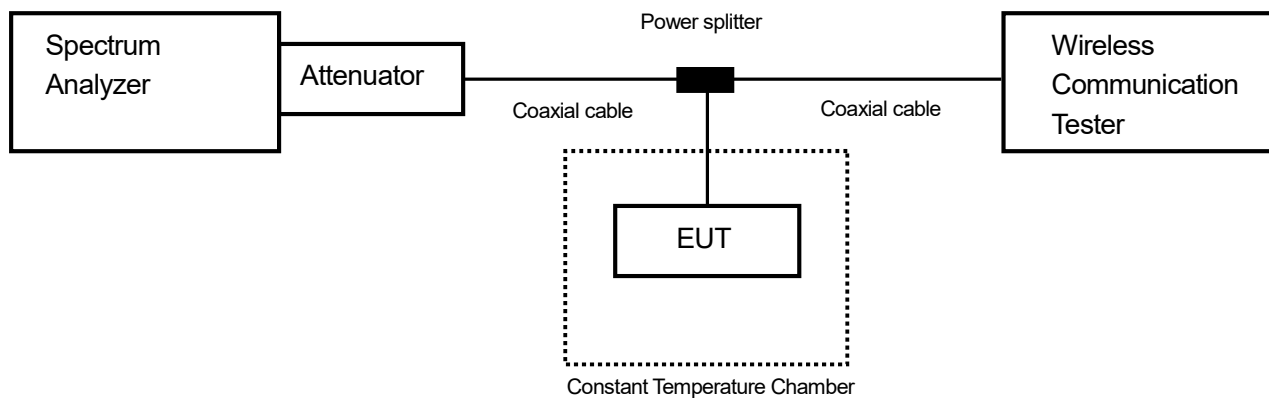

### 10.2 Limit

$\pm 2.5\text{ppm}$





Zacta

### 10.3 Measurement result

Date : November 16, 2016  
 Temperature : 22.8 [°C]  
 Humidity : 40.3 [%]  
 Test place : Shielded room No.4

Test engineer :

Tadahiro Seino

#### [GSM1900]

(Channel: 661)

Limit: $\pm 0.00025\% = \pm 2.5\text{ppm}$					
Power Supply [V]	Temperature [°C]	Measurements Frequency [Hz]	Frequency Tolerance [ppm]	Limit [ppm]	Result
3.70	25(Ref.)	1,880,000,029	0.00000	$\pm 2.5$	Pass
	50	1,879,999,974	-0.02912	$\pm 2.5$	Pass
	40	1,879,999,976	-0.02811	$\pm 2.5$	Pass
	30	1,879,999,967	-0.03257	$\pm 2.5$	Pass
	20	1,880,000,026	-0.00170	$\pm 2.5$	Pass
	10	1,879,999,969	-0.03166	$\pm 2.5$	Pass
	0	1,879,999,977	-0.02768	$\pm 2.5$	Pass
	-10	1,880,000,025	-0.00189	$\pm 2.5$	Pass
	-20	1,880,000,031	0.00095	$\pm 2.5$	Pass
-30	1,880,000,037	0.00418	$\pm 2.5$	Pass	
3.33	25	1,880,000,020	-0.00445	$\pm 2.5$	Pass
4.07	25	1,879,999,973	-0.02955	$\pm 2.5$	Pass

Calculation;

Frequency Tolerance (ppm) = Measurements Frequency (Hz) – Reference Frequency (Hz) / Reference Frequency (Hz) x 1000000



## 11. Uncertainty of measurement

---

Expanded uncertainties stated are calculated with a coverage Factor  $k=2$ .

Please note that these results are not taken into account when measurement uncertainty considerations contained in ETSI TR 100 028-0011 determining compliance or non-compliance with test result.

Test item	Measurement uncertainty
Conducted emission at mains port	$\pm 3.0\text{dB}$
Radiated emission (9kHz – 30MHz)	$\pm 4.4\text{dB}$
Radiated emission (30MHz – 1000MHz)	$\pm 4.5\text{dB}$
Radiated emission (1000MHz – 26GHz)	$\pm 3.9\text{dB}$



Zacta

## 12. Laboratory Information

### 1. Location

Name: Yonezawa Testing Center  
 Address: 5-4149-7, Hachimanpara, Yonezawa-shi, Yamagata, 992-1128 Japan  
 Phone: +81-238-28-2881  
 Fax: +81-238-28-2888

### 2. Accreditation and Registration

- 1) NVLAP  
LAB CODE: 200306-0
- 2) VLAC  
Accreditation No.: VLAC-013
- 3) BSMI  
Laboratory Code: SL2-IN-E-6018, SL2-A1-E-6018

#### 4) FCC

Registration number	Expiration date
540072	2017-2-20

#### 5) Industry Canada

Site number	Facility	Expiration date
4224A-4	3m Semi-anechoic chamber	2017-12-03
4224A-5	10m Semi-anechoic chamber No.1	2017-12-03
4224A-6	10m Semi-anechoic chamber No.2	2019-12-14

#### 6) VCCI Council

Registration number	Expiration date
A-0166	2017-07-03

## Appendix A. Test equipment

### Antenna port conducted test

Equipment	Company	Model No.	Serial No.	Cal. Due	Cal. Date
Spectrum analyzer	Agilent Technologies	E4440A	US40420937	Jul. 31, 2017	Jul. 15, 2016
Microwave cable	RS	YH-13S5	N/A(S403)	May 31, 2017	May 24, 2016
Attenuator	Weinschel	56-10	J4993	Nov. 30, 2016	Nov. 12, 2015
Attenuator	Weinschel	56-10	J4993	Nov. 30, 2017	Nov. 1, 2016
Microwave cable	SUHNER	SUCOFLEX104/1.5m	322087/4	Jul. 31, 2017	Jul. 20, 2016
Power divider	ANRITSU	K240B	020205	Jul. 31, 2017	Jul. 20, 2016
Power meter	ROHDE&SCHWARZ	NRP2	103269	Jun. 30, 2017	Jun. 27, 2016
Power sensor	ROHDE&SCHWARZ	NRP-Z81	102459	Jun. 30, 2017	Jun. 27, 2016
Wideband Radio Frequency Tester	ROHDE&SCHWARZ	CMW500	116338	May 31, 2017	May 18, 2016
Operation type temperature controlled bath	Espec	PL1KP	14007261	Jan. 31, 2017	Jan. 22, 2016

### Radiated emission

Equipment	Company	Model No.	Serial No.	Cal. Due	Cal. Date
EMI Receiver	ROHDE&SCHWARZ	ESCI	100764	Aug. 31, 2017	Aug. 19, 2016
Preamplifier	ANRITSU	MH648A	M96057	May 31, 2017	May 10, 2016
Biconical antenna	Schwarzbeck	VHA9103/BBA9106	2155	Jun. 30, 2017	Jun. 2, 2016
Log periodic antenna	Schwarzbeck	UHALP9108A	0560	Jun. 30, 2017	Jun. 2, 2016
Attenuator	TME	CFA-01NPJ-6	N/A(S273)	May 31, 2017	May 25, 2016
Attenuator	TME	CFA-01NPJ-3	N/A(S270)	May 31, 2017	May 25, 2016
Spectrum analyzer	Agilent Technologies	E4440A	US40420937	Jul. 31, 2017	Jul. 15, 2016
Preamplifier	TSJ	MLA-1840-B03-35	1240332	Jun. 30, 2017	Jun. 16, 2016
Dipole antenna	Schwarzbeck	VHAP	1021	Oct. 31, 2017	Oct. 2, 2015
Dipole antenna	Schwarzbeck	UHAP	993	Oct. 31, 2017	Oct. 2, 2015
Double ridged guide antenna	EMCO	3115	5205	Mar. 31, 2017	Mar. 3, 2016
Double ridged guide antenna	ETS LINDGREN	3117	00052315	Feb. 28, 2017	Feb. 23, 2016
Attenuator	Agilent Technologies	8491B	MY39268633	Feb. 28, 2017	Feb. 23, 2016
Double ridged guide antenna	EMCO	3115	4328	Apr. 30, 2017	Apr. 11, 2016
Double ridged guide antenna	EMCO	3115	00058532	Dec. 31, 2017	Dec. 6, 2016
Signal generator	ROHDE&SCHWARZ	SMB100A	177525	Jun. 30, 2017	Jun. 21, 2016
Broad-Band Horn Antenna	Schwarzbeck	BBHA9170	BBHA9170189	Jun. 30, 2017	Jun. 16, 2016
Preamplifier	TSJ	MLA-1840-B03-35	1240332	Jun. 30, 2017	Jun. 16, 2016
Microwave cable	SUHNER	SUCOFLEX102/2m	31648	Mar. 31, 2017	Mar. 29, 2016
High pass filter	Micro-Tronics	HPM50115	004	Jul. 31, 2017	Jul. 20, 2016
High pass filter	Wainwright	WHKX2.8/18G-6SS	1	Jul. 31, 2017	Jul. 19, 2016
Wideband Radio Frequency Tester	ROHDE&SCHWARZ	CMW500	116338	May 31, 2017	May 18, 2016
Microwave cable	SUHNER	SUCOFLEX104/9m	346316/4	May 31, 2017	May 25, 2016
		SUCOFLEX104/1m	322084/4	May 31, 2017	May 25, 2016
		SUCOFLEX104/1.5m	317226/4	May 31, 2017	May 25, 2016
		SUCOFLEX104/7m	41625/6	May 31, 2017	May 25, 2016
PC	DELL	DIMENSION E521	75465BX	N/A	N/A
Software	TOYO Corporation	EP5/RE-AJ	0611193/V5.3.61	N/A	N/A
Absorber	RIKEN	PFP30	N/A	N/A	N/A
3m Semi an-echoic Chamber	TOKIN	N/A	N/A(9002-NSA)	May 31, 2017	May 11, 2016
3m Semi an-echoic Chamber	TOKIN	N/A	N/A(9002-SVSWR)	May 31, 2017	May 12, 2016

\*: The calibrations of the above equipment are traceable to NIST or equivalent standards of the reference organizations.