



Zacta

TEST REPORT

Report number : JPD-TR-16220-0

Issue date : January 26, 2017

The device, as described herewith, was tested pursuant to applicable test procedure and complies with the requirements of;

FCC Part 22 Subpart H

The test results are traceable to the international or national standards.

Applicant	: KYOCERA Corporation
Equipment under test (EUT)	: Mobile Phone
Model number	: DA03
FCC ID	: JOYDA03

Date of test : October 3, 5, 26, 2016, November 14, 22, 25, 2016
December 1,2,14,26, 2016, January 23, 2017
Test place : TÜV SÜD Zacta Ltd. Yonezawa Testing Center
5-4149-7, Hachimanpara, Yonezawa-shi,
Yamagata, 992-1128 Japan
Phone: +81-238-28-2881 Fax: +81-238-28-2888
Test results : Complied

The results in this report are applicable only to the equipment tested.
This report shall not be re-produced except in full without the written approval of TÜV SÜD Zacta Ltd.
This test report must not be used by the client to claim product certification, approval, or endorsement by NVLAP, NIST, or any agency of the federal government.

Tested by : Tadahiro Seino Kazunori Saito
Tadahiro Seino Kazunori Saito

Approved by : Hiroaki Suzuki
Hiroaki Suzuki
Lab Manager of RF Lab



Table of contents

	Page
1. Summary of Test	3
1.1 Purpose of test	3
1.2 Standards	3
1.3 List of applied test to the EUT	3
1.4 Modification to the EUT by laboratory	3
2. Equipment Under Test	4
2.1 General Description of equipment	4
2.2 EUT information	4
2.3 Variation of the family model(s)	5
2.4 Description of Test mode	5
3. Configuration of equipment	6
3.1 Equipment(s) used	6
3.2 System configuration	6
4. Conducted Output Power	7
4.1 Measurement procedure	7
4.2 Measurement result	7
5. Effective Radiated Power	9
5.1 Measurement procedure	9
5.2 Calculation method	10
5.3 Limit	10
5.4 Test data	11
6. Occupied Bandwidth	12
6.1 Measurement procedure	12
6.2 Limit	12
6.3 Measurement result	12
6.4 Trace data	13
7. Band Edge Spurious and Harmonic at Antenna Terminals	15
7.1 Measurement procedure	15
7.2 Limit	15
7.3 Measurement result	16
7.4 Trace data	17
8. Radiated Emissions and Harmonic Emissions	26
8.1 Measurement procedure	26
8.2 Calculation method	27
8.3 Limit	27
8.4 Test data	28
9. Frequency Stability	30
9.1 Measurement procedure	30
9.2 Limit	30
9.3 Measurement result	31
10. Uncertainty of measurement	32
11. Laboratory Information	33
Appendix A. Test equipment	34

1. Summary of Test

1.1 Purpose of test

It is the original test in order to verify conformance to FCC Part 22 Subpart H.

1.2 Standards

CFR47 FCC Part 22 Subpart H

1.2.1 Test Methods

KDB 971168 D01 Power Meas License Digital Systems v02r02
ANSI/TIA/EIA-603-D-2010

1.2.2 Deviation from standards

None

1.3 List of applied test to the EUT

Test items Section	Test items	Condition	Result
2.1046	Conducted Output Power	Conducted	PASS
22.913(a)	Effective Radiated Power	Radiated	PASS
22.917(a) 2.1049	Occupied Bandwidth	Conducted	PASS
22.917(a) 2.1051	Band Edge Spurious and Harmonic at Antenna Terminal	Conducted	PASS
22.917(a) 2.1053	Radiated emissions and Harmonic Emissions	Radiated	PASS
22.355 2.1055	Frequency Stability	Conducted	PASS

1.3.1 Test set up

Table-Top

1.4 Modification to the EUT by laboratory

None



Zacta

2. Equipment Under Test

2.1 General Description of equipment

EUT is the Mobile Phone.

2.2 EUT information

Applicant	:	KYOCERA Corporation Yokohama Office 2-1-1 Kagahara, Tsuzuki-ku Yokohama-shi, Kanagawa, Japan Phone: +81-45-943-6253 Fax: +81-45-943-6314
Equipment under test	:	Mobile Phone
Trade name	:	Kyocera
Model number	:	DA03
Serial number	:	N/A
EUT condition	:	Pre-Production
Power ratings	:	Battery: DC 3.8V
Size	:	(W) 71.0 × (D) 10.4 × (H) 142.0 mm
Environment	:	Indoor and Outdoor use
Terminal limitation	:	-20°C to 60°C
RF Specification	:	
Frequency of Operation	:	Up Link GSM850: 824.2-848.8MHz WCDMA Band V: 826.4-846.6MHz Down Link GSM850: 869.2-893.8MHz WCDMA Band V: 871.4-891.6MHz
Modulation type	:	GSM850: GMSK WCDMA Band V: QPSK, 16QAM
Emission designator	:	GSM850: 245KGXW WCDMA Band V: 4M13F9W
Output power	:	GSM850: 1.841W (32.65dBm) WCDMA Band V: 0.220W (23.42dBm)
Antenna type	:	Internal antenna
Antenna gain	:	GSM850: -0.7dBi WCDMA Band V: -0.7dBi

2.3 Variation of the family model(s)

Not applicable

2.4 Description of Test mode

The EUT had been tested under operating condition.
There are three channels have been tested as following:

Band	Channel	Frequency
GSM850	128	824.2MHz
	190	836.6MHz
	251	848.8MHz
WCDMA Band V	4132	826.4MHz
	4183	836.6MHz
	4233	846.6MHz

The field strength of spurious emissions was measured at each position of all three axis X, Y and Z to compare the level, and the maximum noise.
The worst emission was found in Z axis and the worst case recorded.



Zacta

3. Configuration of equipment

3.1 Equipment(s) used

No.	Equipment	Company	Model No.	Serial No.	FCC ID / DoC	Comment
1	Mobile Phone	KYOCERA	DA03	N/A	JOYDA03	EUT

3.2 System configuration

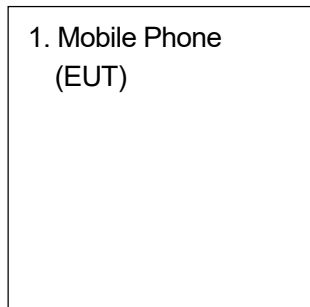

Note1: Numbers assigned to equipment on this diagram correspond to the list in "3.1 Equipment(s) used".

4. Conducted Output Power

4.1 Measurement procedure [FCC 2.1046]

The conducted output power was measured with a wireless communication tester connected to the antenna terminal. The wireless communication tester parameters were set to produce the maximum power from the EUT.

- Test configuration

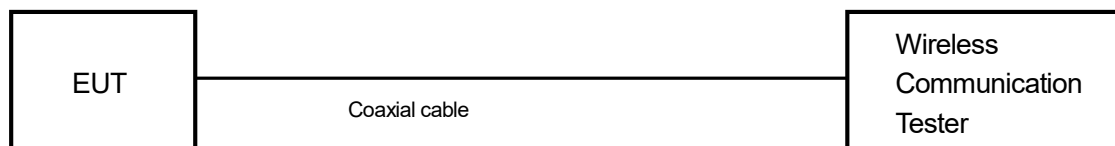

4.2 Measurement result

Date : October 3, 2016
 Temperature : 24.2 [°C]
 Humidity : 65.3 [%]
 Test place : Shielded room No.4

Test engineer : Tadahiro Seino

Date : October 5, 2016
 Temperature : 24.3 [°C]
 Humidity : 48.9 [%]
 Test place : Shielded room No.4

Test engineer : Tadahiro Seino

Date : January 23, 2017
 Temperature : 23.2 [°C]
 Humidity : 25.4 [%]
 Test place : Shielded room No.4

Test engineer : Kazunori Saito

Band	Channel	Frequency [MHz]	Maximum Burst-Averaged Output Power [dBm]				
			Voice GSM CS 1slot	GPRS/EDGE(GMSK)Data			
				GPRS 1 TX Slot	GPRS 2 TX Slot	GPRS 3 TX Slot	GPRS 4 TX Slot
GSM 850	128	824.2	32.33	32.33	30.71	28.69	27.35
	190	836.6	32.54	32.52	30.88	28.69	27.43
	251	848.8	32.63	32.65	30.85	28.62	27.29

3GPP Release Version	Mode		Sub- Test	Power [dBm]			MPR	Bc	βd	Bc/βd
	Channel			4132	4183	4233				
	Frequency [MHz]			826.4	836.6	846.6				
99	W-CDMA	RMC	-	23.42	23.35	23.25	-	-	-	-
		AMR	-	23.40	23.28	23.25				
5	HSDPA (Cellular)	1	1	22.18	22.05	21.96	0	2/15	15/15	2/15
5		2	2	22.16	22.07	21.97	0	12/15	15/15	12/15
5		3	3	21.66	21.59	21.49	0.5	15/15	8/15	15/8
5		4	4	21.68	21.66	21.47	0.5	15/15	4/15	15/4
6	HSUPA	1	1	21.39	21.76	21.54	0	11/15	15/15	11/15
6		2	2	21.04	20.99	20.76	2	6/15	15/15	6/15
6		3	3	20.94	21.03	20.97	1	15/15	9/15	15/9
6		4	4	20.62	20.92	20.68	2	2/15	15/15	2/15
6		5	5	22.41	22.25	22.21	0	15/15	15/15	15/15

5. Effective Radiated Power

5.1 Measurement procedure [FCC 22.913(a)]

<Step 1>

The EUT and support equipment are placed on a 1 meter x 1 meter surface, 0.8 meter height styrene foam table. Radiated emission measurements are performed at 3 meter distance with the broadband antenna (double ridged guide antenna). The antenna is positioned both the horizontal and vertical planes of polarization and height is varied 1 to 4 meters and stopped at height producing the maximum emission. The turntable is rotated by 360 degrees and stopped at azimuth of producing the maximum emission.

<Step 2>

The substitution antenna is replaced by the transmitter antenna (EUT). The frequency of the signal generator is adjusted to the measurement frequency. Level of the signal generator is adjusted to the level that is obtained from step 1, and record the emission level of signal generator.

The spectrum analyzer is set to;

- a) Span = 1.5 times the OBW
- b) RBW = 1-5% of the expected OBW, not to exceed 1MHz
- c) VBW $\geq 3 \times$ RBW
- d) Number of sweep points $\geq 2 \times$ span / RBW
- e) Sweep time = auto-couple
- f) Detector = RMS (power averaging)
- g) If the EUT can be configured to transmit continuously (i.e., burst duty cycle $\geq 98\%$), then set the trigger to free run.
- h) If the EUT cannot be configured to transmit continuously (i.e., burst duty cycle $< 98\%$), then use a sweep trigger with the level set to enable triggering only on full power bursts and configure the EUT to transmit at full power for the entire duration of each sweep. Ensure that the sweep time is less than or equal to the transmission burst duration.
- i) Trace average at least 100 traces in power averaging (i.e., RMS) mode.
- j) Compute the power by integrating the spectrum across the OBW of the signal using the instrument's band power measurement function, with the band limits set equal to the OBW band edges. If the instrument does not have a band power function, then sum the spectrum levels (in linear power units) at intervals equal to the RBW extending across the entire OBW of the spectrum.

- Test configuration

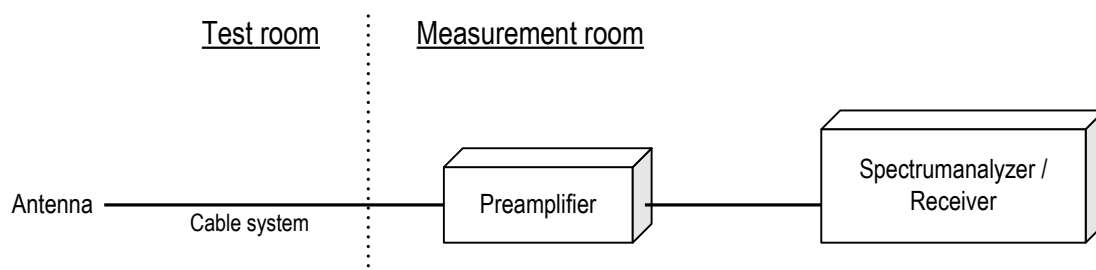

5.2 Calculation method

Result (ERP) = S.G Reading – Cable loss + Antenna Gain
Margin = Limit - Result (ERP)

Example:

Limit @ 836.6MHz : 38.4dBm
S.G Reading = 33.3dBm Cable loss = 0.7dB Ant. Gain = -10.7dBd
Result = $33.3 - 0.7 + (-10.7) = 21.9\text{dBm}$
Margin = $38.4 - 21.9 = 16.5\text{dB}$

5.3 Limit

7 W (38.45dBm)



Zacta

5.4 Test data

Date : November 22, 2016
 Temperature : 22.7 [°C]
 Humidity : 27.8 [%]
 Test place : 3m Semi-anechoic chamber
 Test engineer : Kazunori Saito

Date : November 25, 2016
 Temperature : 21.2 [°C]
 Humidity : 28.6 [%]
 Test place : 3m Semi-anechoic chamber
 Test engineer : Kazunori Saito

Date : December 14, 2016
 Temperature : 23.5 [°C]
 Humidity : 26.0 [%]
 Test place : 3m Semi-anechoic chamber
 Test engineer : Kazunori Saito

[GSM850]

H/V	Frequency [MHz]	S.A Reading [dBm]	S.G Reading [dBm]	Cable loss [dB]	Ant.Gain [dBd]	Result [dBm]	Limit [dBm]	Margin [dB]
H	824.2	-10.7	38.2	0.7	-10.7	26.8	38.4	11.6
H	836.6	-12.5	37.4	0.7	-10.7	26.0	38.4	12.4
H	848.8	-13.9	36.5	0.8	-10.7	25.1	38.4	13.3

[WCDMA Band V]

H/V	Frequency [MHz]	S.A Reading [dBm]	S.G Reading [dBm]	Cable loss [dB]	Ant.Gain [dBd]	Result [dBm]	Limit [dBm]	Margin [dB]
H	826.4	-12.8	27.0	0.7	-10.7	15.6	38.4	22.8
H	836.6	-14.0	26.9	0.7	-10.7	15.5	38.4	22.9
H	846.6	-12.9	28.4	0.8	-10.7	17.0	38.4	21.4

6. Occupied Bandwidth

6.1 Measurement procedure

[FCC 22.917(a), 2.1049]

The Occupied bandwidth was measured with a spectrum analyzer connected to the antenna terminal. The spectrum analyzer's automatic bandwidth measurement capability was used to perform the 99% occupied bandwidth and the 26dB bandwidth.

The spectrum analyzer is set to;

- a) RBW = 1-5% of the expected OBW & VBW $\geq 3 \times$ RBW
- b) Detector = Peak
- c) Trace mode = Max hold
- d) Sweep time = auto-couple

- Test configuration

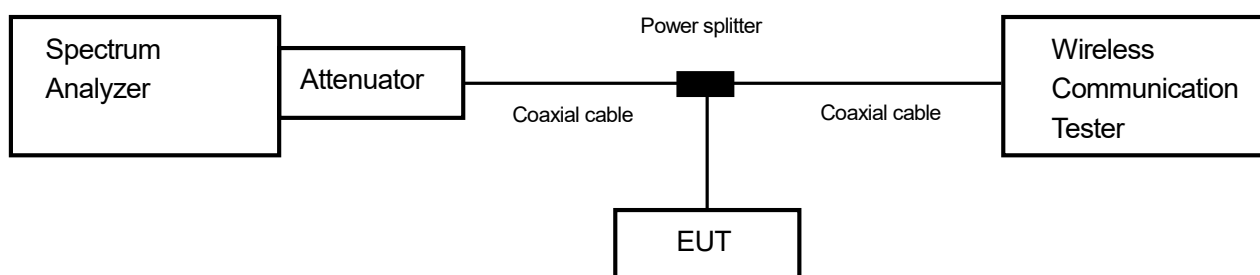

6.2 Limit

None

6.3 Measurement result

Date : October 26, 2016

Temperature : 24.1 [°C]

Humidity : 46.9 [%]

Test place : Shielded room No.4

Test engineer :

Kazunori Saito

Band	Channel	Frequency (MHz)	Test Result (kHz)
GSM850	128	824.2	244.5896
	190	836.6	244.2986
	251	848.8	243.2098
WCDMA Band V	4132	826.4	4125.6
	4183	836.6	4119.5
	4233	846.6	4119.4



Zacta

6.4 Trace data
[GSM850]

Channel: 128

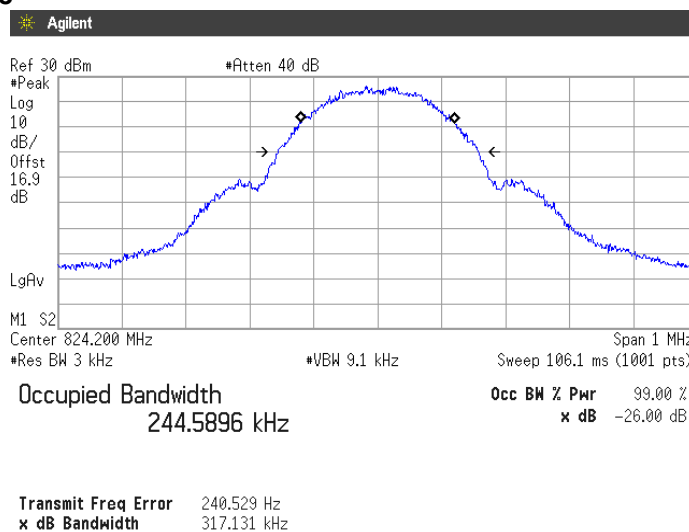

Channel: 190

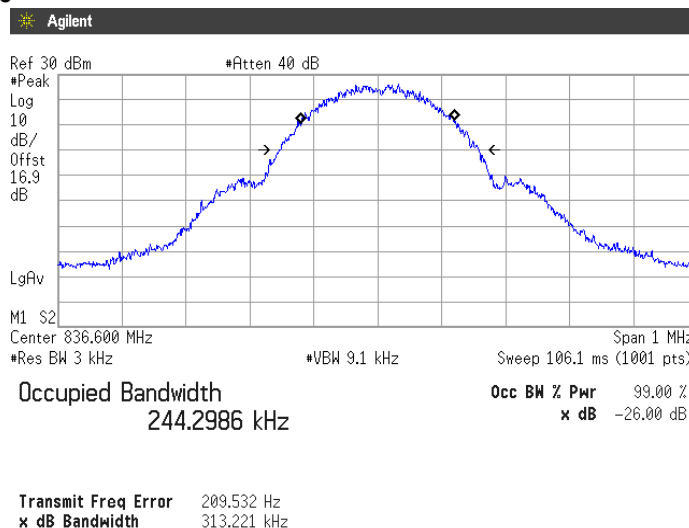

Channel: 251

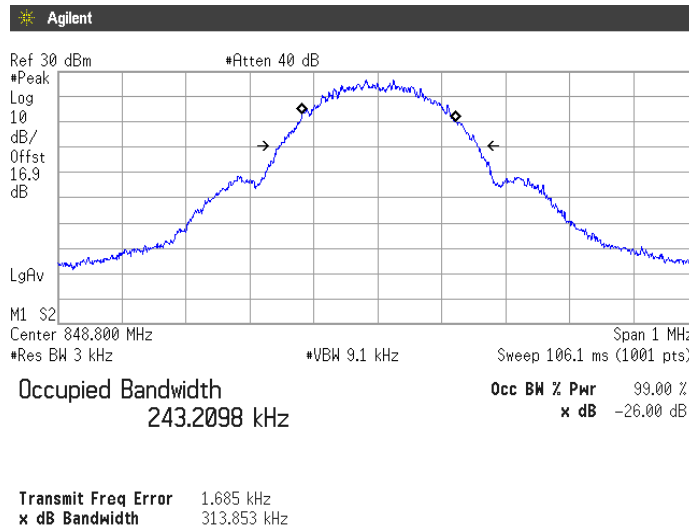



Zacta

**[WCDMA Band V]
Channel: 4132**

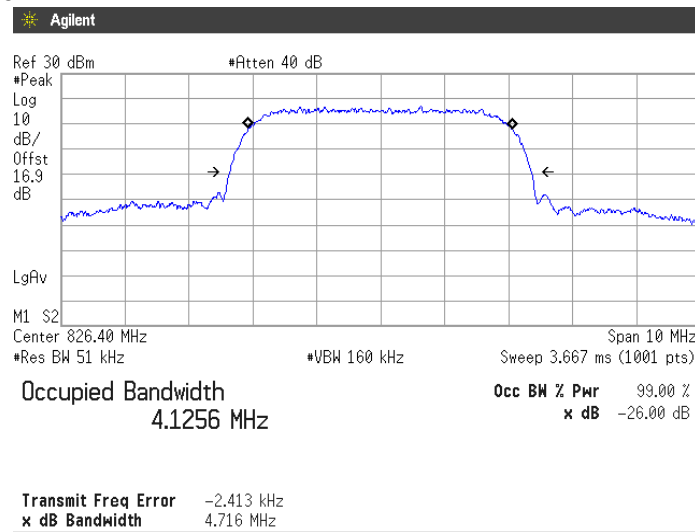

Channel: 4183

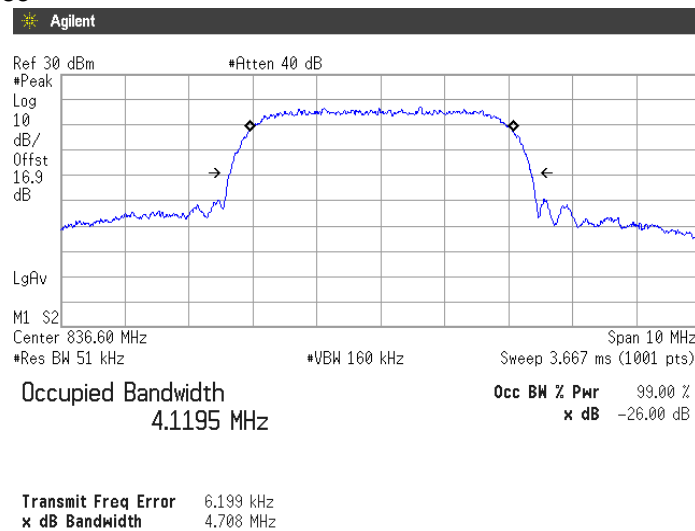

Channel: 4233

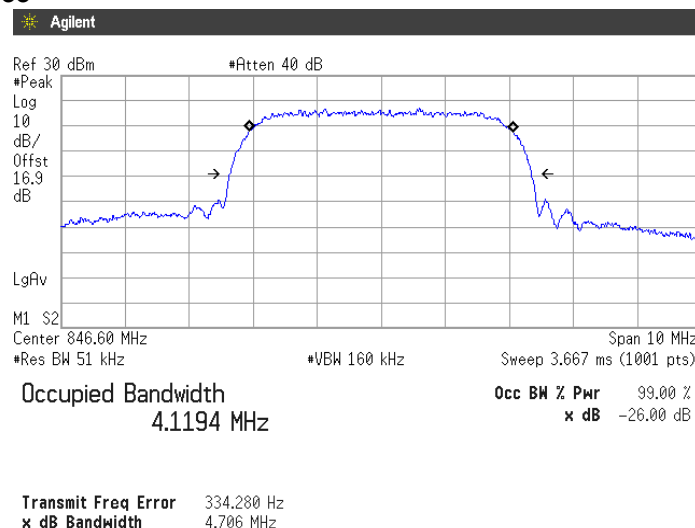

7. Band Edge Spurious and Harmonic at Antenna Terminals

7.1 Measurement procedure [FCC 22.917(a), 2.1051]

The band edge spurious and harmonic was measured with a spectrum analyzer connected to the antenna terminal.

The spectrum analyzer is set to;
<Band Edge>

- a) Span was set large enough so as to capture all out of band emissions near the band edge
- b) RBW \geq 1% of the emission bandwidth or 2% of the emission bandwidth
- c) VBW \geq 3 x RBW
- d) Detector = RMS
- e) Trace mode = Max hold
- f) Sweep time = auto-couple
- g) Number of sweep point \geq 2 x span / RBW

<Spurious Emissions>

- a) RBW = 1MHz & VBW \geq 3 x RBW
- b) Detector = Peak
- c) Trace mode = Max hold
- d) Sweep time = auto-couple
- e) Number of sweep point \geq 2 x span / RBW

- Test configuration

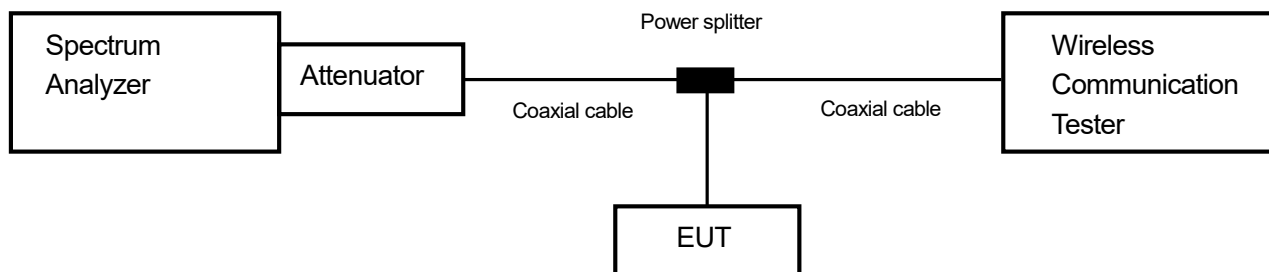

7.2 Limit

-13dBm or less



Zacta

7.3 Measurement result

Date : October 26, 2016
 Temperature : 24.1 [°C]
 Humidity : 46.9 [%]
 Test place : Shielded room No.4

Test engineer :

Kazunori Saito

Band	Channel	Frequency [MHz]	Limit [dB]	Results	
GSM850	128	824.2	-13.0	See the trace data	PASS
	190	836.6	-13.0	See the trace data	PASS
	251	848.8	-13.0	See the trace data	PASS
WCDMA Band V	4132	826.4	-13.0	See the trace data	PASS
	4183	836.6	-13.0	See the trace data	PASS
	4233	846.6	-13.0	See the trace data	PASS



Zacta

**7.4 Trace data
[GSM850]
(Band Edge)**

Channel: 128

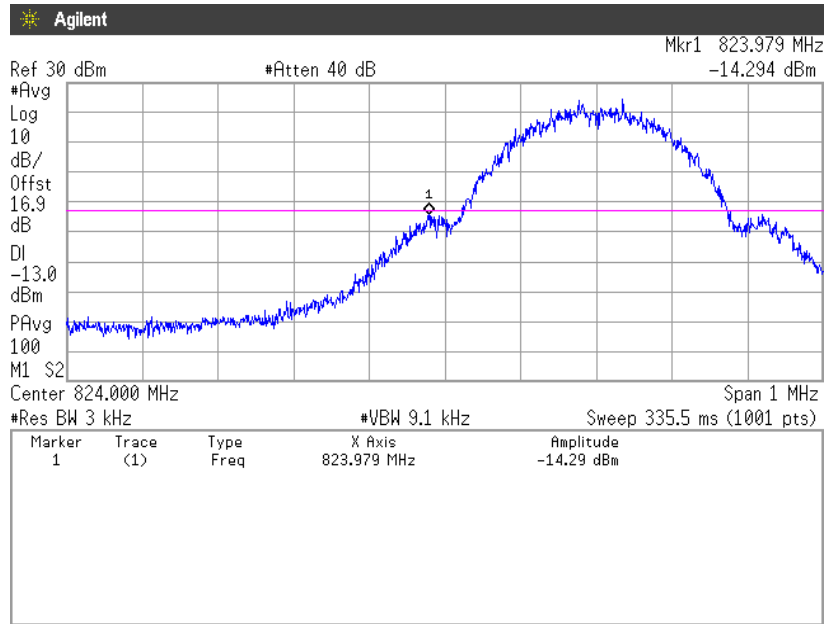

Channel: 251

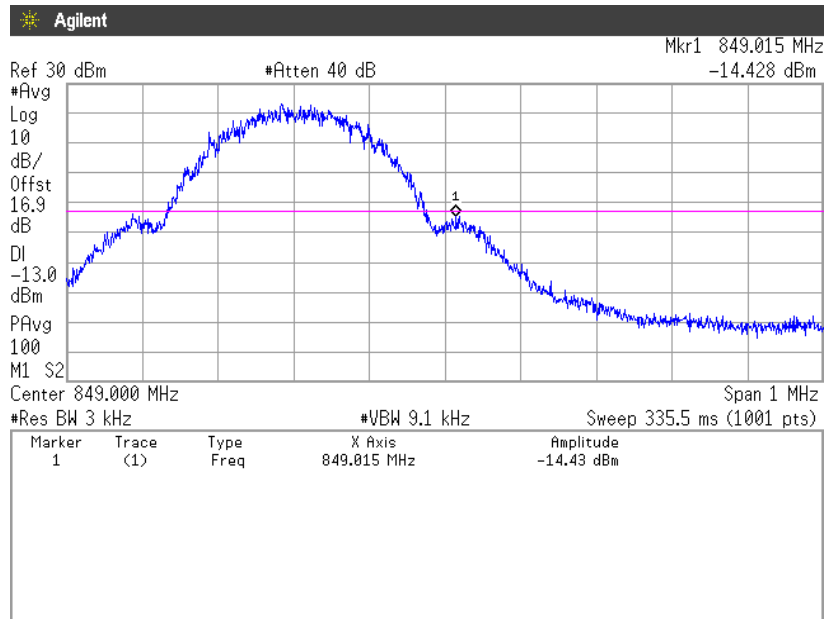



Zacta

(Spurious Emissions)

Note: Conducted spurious test was measured in the worst case of conducted output power.

**Channel: 128
30MHz-5GHz**

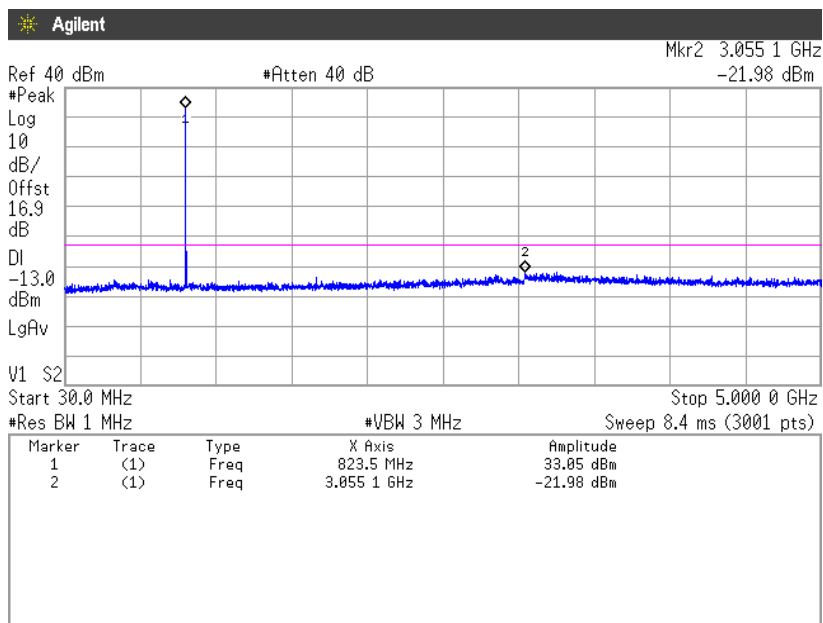

5GHz-10GHz

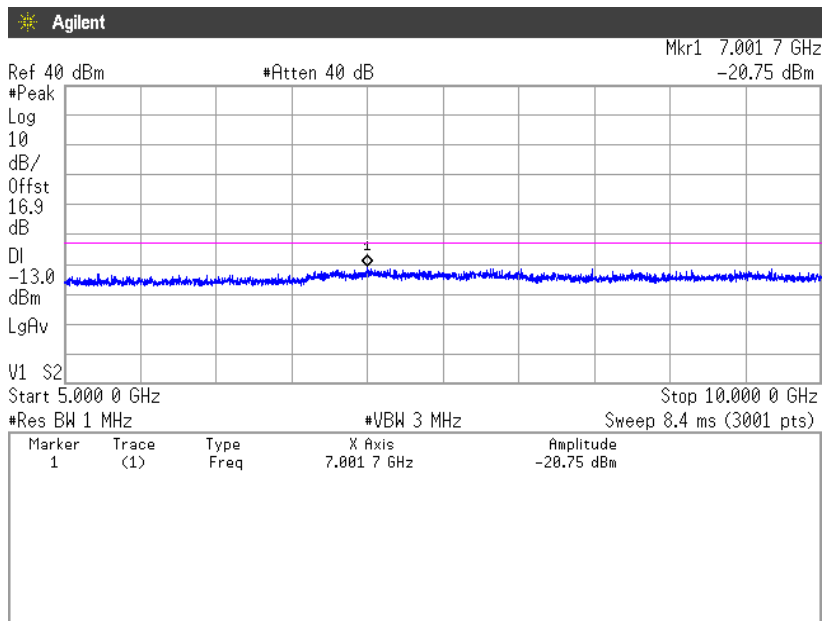



Zacta

**Channel: 190
30MHz-5GHz**

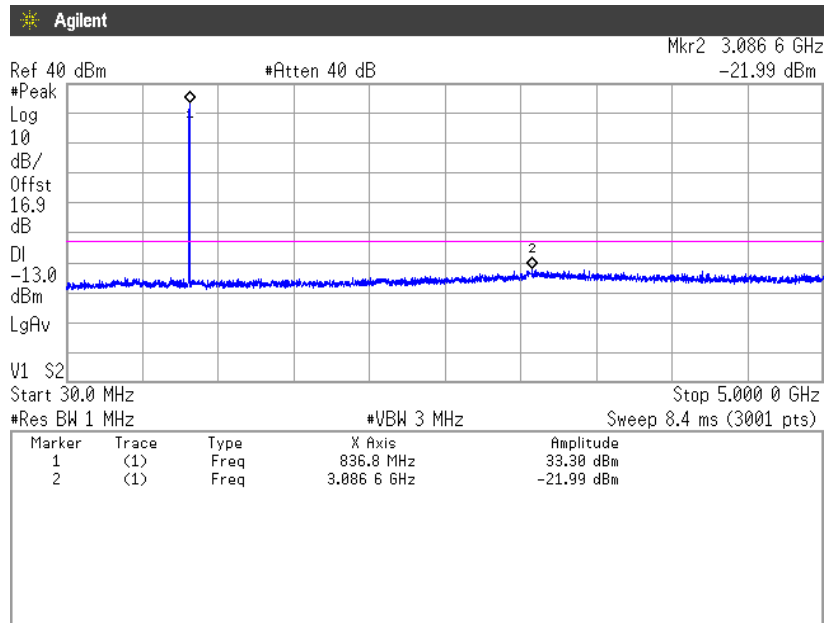

5GHz-10GHz

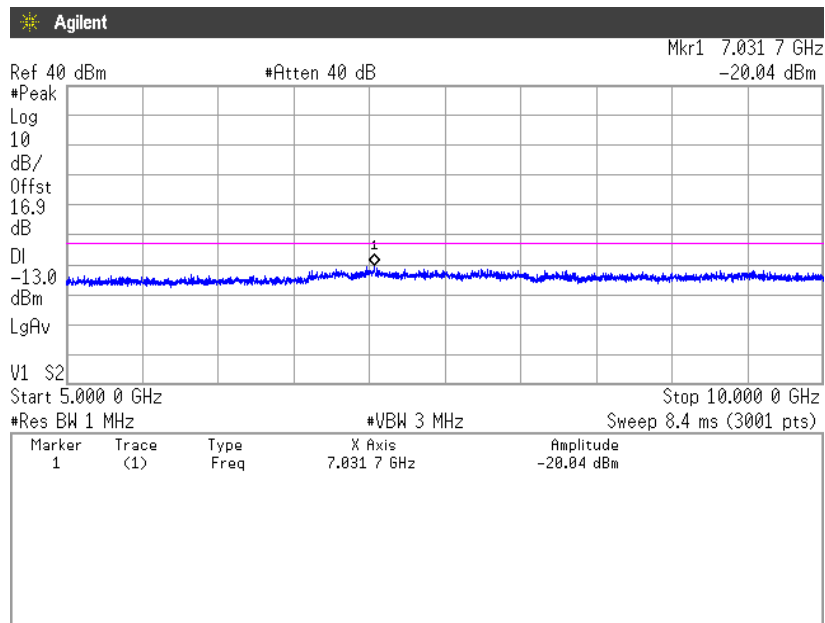

**Channel: 251
30MHz-5GHz**

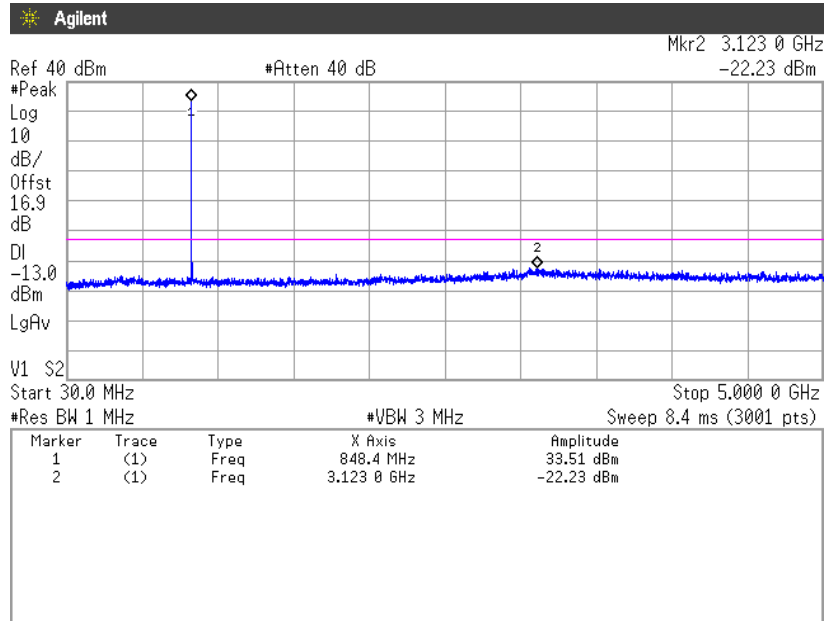

5GHz-10GHz

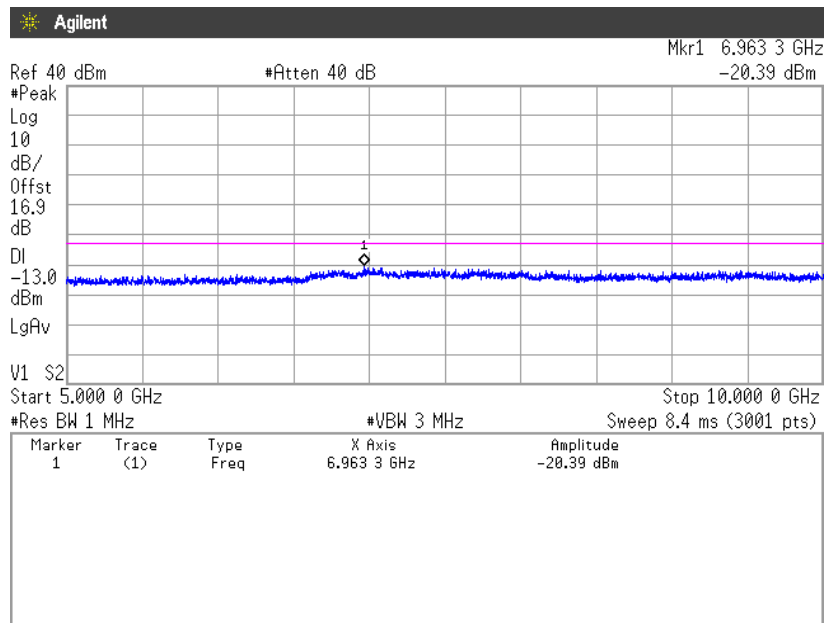



Zacta

**[WCDMA Band V
(Band Edge)
Channel: 4132**

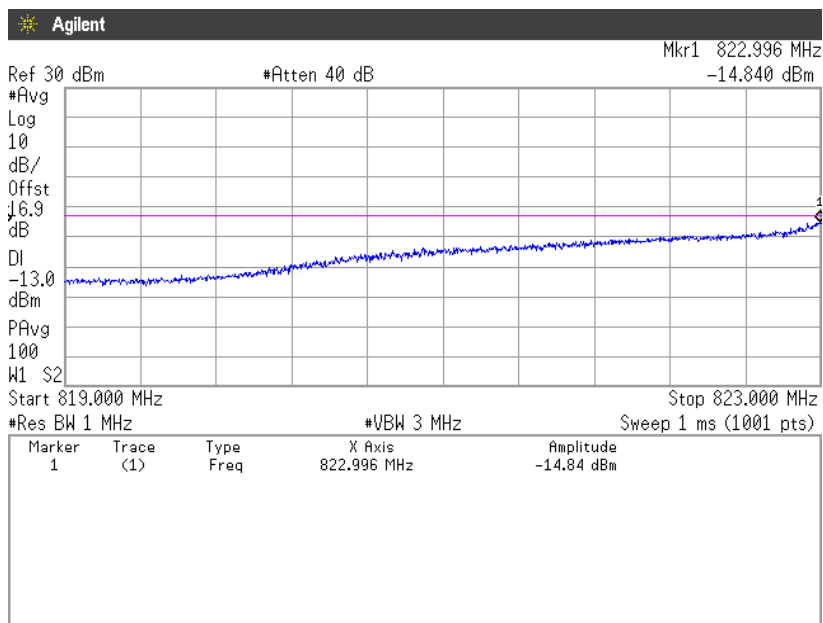
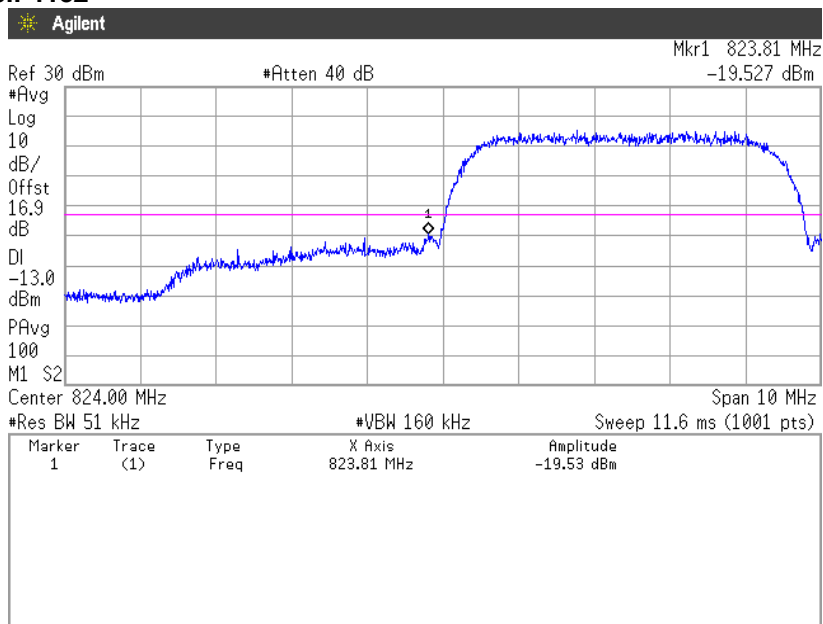



Zacta

Channel: 4233

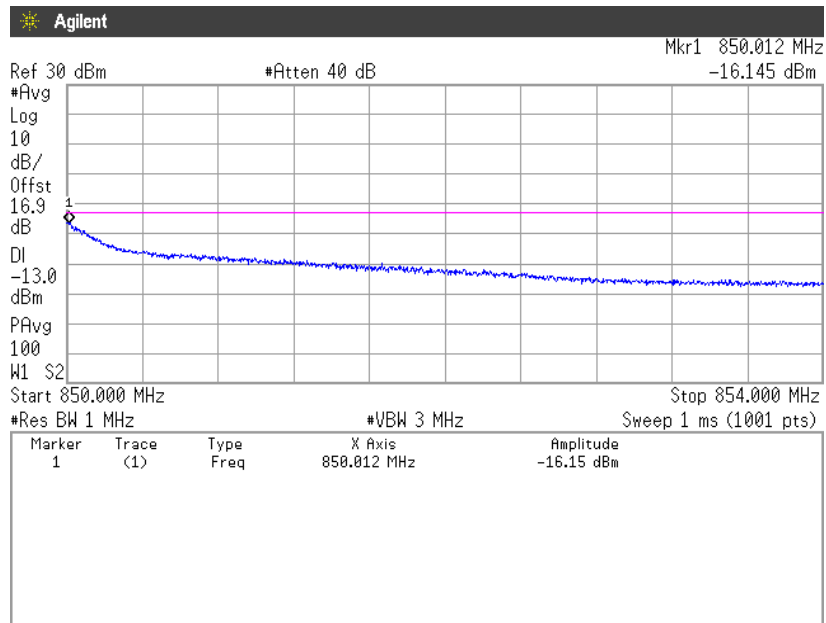
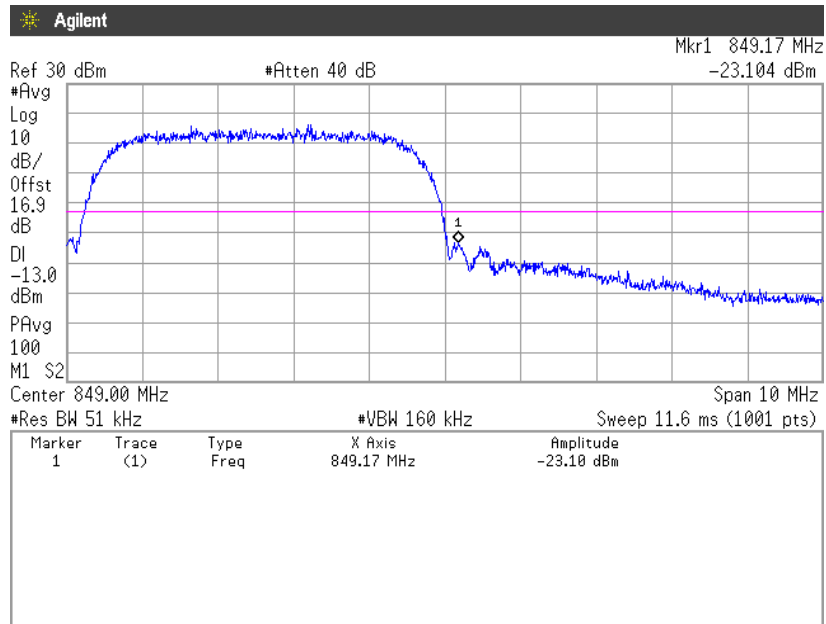



Zacta

(Spurious Emissions)

Note: Conducted spurious test was measured in the worst case of conducted output power.

**Channel: 4132
30MHz-5GHz**

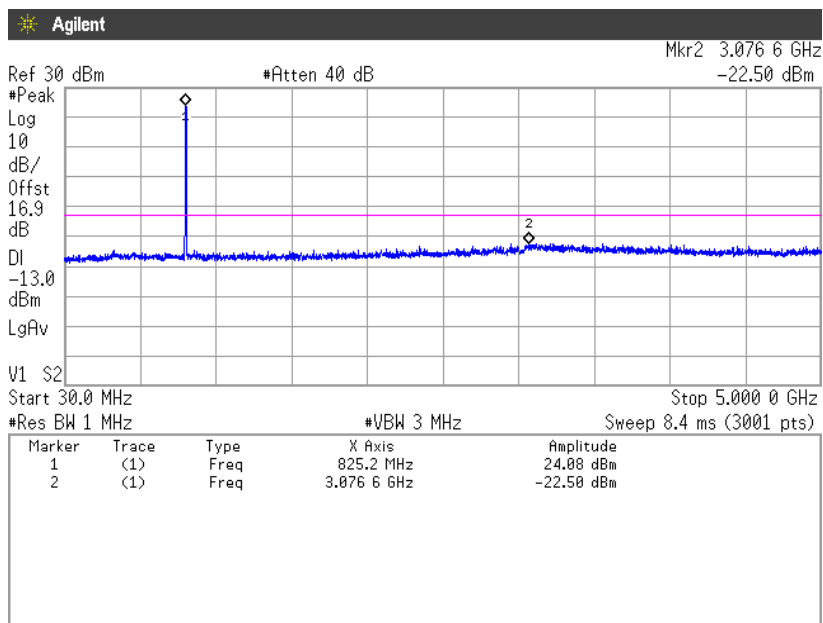

5GHz-10GHz

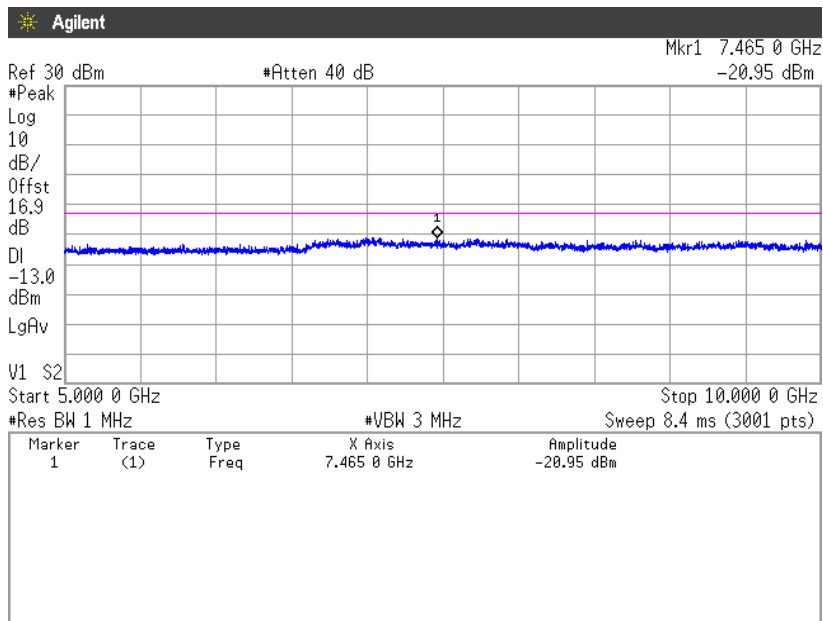



Zacta

**Channel: 4183
30MHz-5GHz**

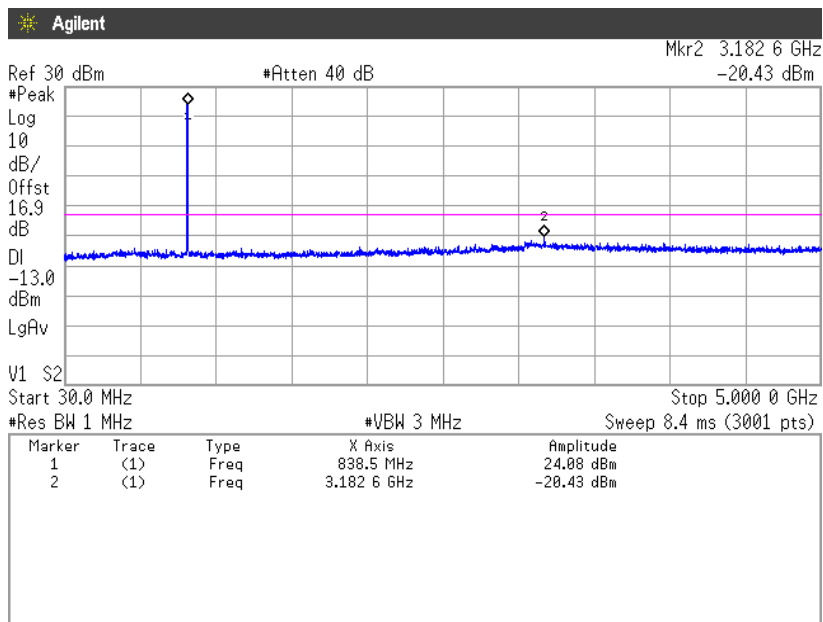

5GHz-10GHz

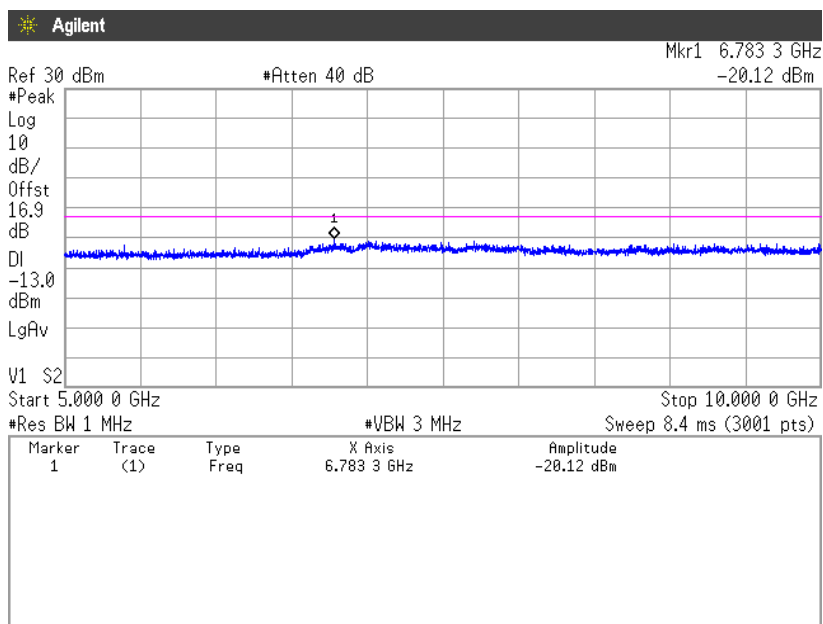



Zacta

**Channel: 4233
30MHz-5GHz**

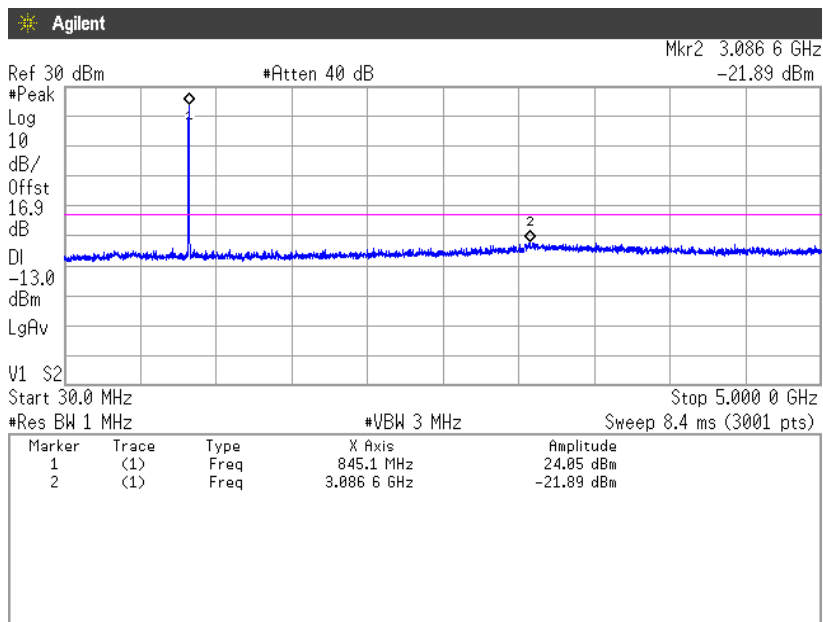

5GHz-10GHz

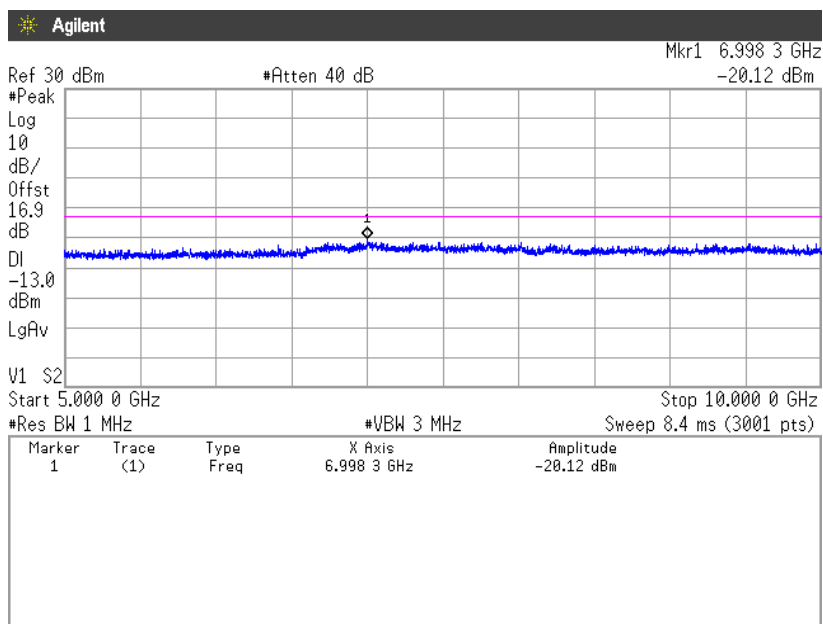

8. Radiated Emissions and Harmonic Emissions

8.1 Measurement procedure [FCC 22.917(a), 2.1053]

<Step 1>

The EUT and support equipment are placed on a 1 meter x 1 meter surface, 0.8 meter height styrene foam table. Radiated emission measurements are performed at 3 meter distance with the broadband antenna (Biconical antenna, Log periodic antenna and double ridged guide antenna). The antenna is positioned both the horizontal and vertical planes of polarization and height is varied 1 to 4 meters and stopped at height producing the maximum emission.

The bandwidth of the spectrum analyzer is set to 1MHz. The turntable is rotated by 360 degrees and stopped at azimuth of producing the maximum emission. The frequency is investigated up to 20GHz.

<Step 2>

The substitution antenna is replaced by the transmitter antenna (EUT).

The frequency of the signal generator is adjusted to the measurement frequency.

Level of the signal generator is adjusted to the level that is obtained from step 1, and record the emission level of signal generator.

The spectrum analyzer is set to;

- RBW = 100kHz for below 1GHz and 1MHz for above 1GHz / VBW $\geq 3 \times$ RBW
- Detector = Peak
- Trace mode = Max hold
- Sweep time = auto-couple

- Test configuration

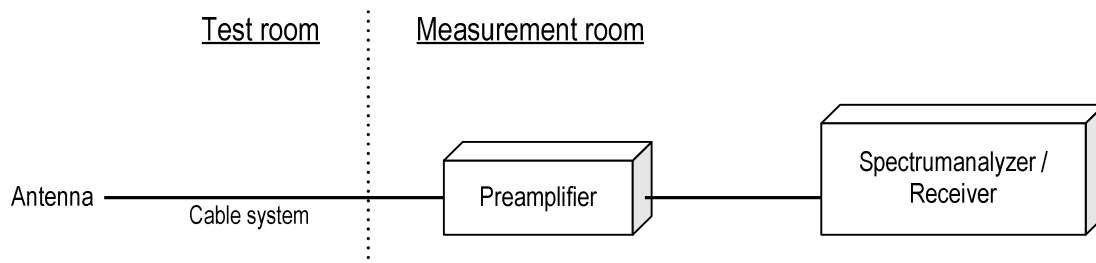

8.2 Calculation method

Result = S.G Reading - Cable loss + Antenna Gain
Margin = Limit - Result (ERP)

Example:

Limit @ 1648.4MHz : -13.0dBm
S.G Reading = -56.4dBm Cable loss = 1.0dB Ant. Gain = 6.9dBd
Result = -56.4 - 1.0 + 6.9 = -50.6dBm
Margin = -13.0 - (-50.6) = 37.6dB

8.3 Limit

-13dBm or less

8.4 Test data

Date : November 22, 2016
 Temperature : 22.7 [°C]
 Humidity : 27.8 [%]
 Test place : 3m Semi-anechoic chamber
 Test engineer : Kazunori Saito

Date : December 1, 2016
 Temperature : 22.9 [°C]
 Humidity : 23.4 [%]
 Test place : 3m Semi-anechoic chamber
 Test engineer : Kazunori Saito

Date : December 26, 2016
 Temperature : 21.9 [°C]
 Humidity : 22.8 [%]
 Test place : 3m Semi-anechoic chamber
 Test engineer : Kazunori Saito

[GSM850] (Channel: 128)

H/V	Frequency [MHz]	S.A Reading [dBm]	S.G Reading [dBm]	Cable loss [dB]	Ant.Gain [dBi]	Result [dBm]	Limit [dBm]	Margin [dB]
V	1648.4	-53.7	-61.0	1.0	6.9	-55.2	-13.0	42.2
H	2472.6	-55.3	-63.0	1.3	7.4	-56.9	-13.0	43.9
V	2472.6	-56.0	-63.6	1.3	7.4	-57.5	-13.0	44.5

(Channel: 190)

H/V	Frequency [MHz]	S.A Reading [dBm]	S.G Reading [dBm]	Cable loss [dB]	Ant.Gain [dBi]	Result [dBm]	Limit [dBm]	Margin [dB]
H	1673.2	-55.3	-63.7	1.1	6.6	-58.1	-13.0	45.1
V	1673.2	-56.0	-64.0	1.1	6.6	-58.4	-13.0	45.4
H	2509.8	-55.5	-67.7	1.3	7.5	-61.6	-13.0	48.6
V	2509.8	-56.6	-64.7	1.3	7.5	-58.6	-13.0	45.6

(Channel: 251)

H/V	Frequency [MHz]	S.A Reading [dBm]	S.G Reading [dBm]	Cable loss [dB]	Ant.Gain [dBi]	Result [dBm]	Limit [dBm]	Margin [dB]
H	1697.6	-55.6	-67.9	1.1	6.3	-62.6	-13.0	49.6
V	1697.6	-54.6	-63.1	1.1	6.3	-57.8	-13.0	44.8
H	2546.4	-56.4	-70.6	1.3	7.6	-64.3	-13.0	51.3
V	2546.4	-55.5	-63.2	1.3	7.6	-56.9	-13.0	43.9



Zacta

Date : November 25, 2016
 Temperature : 21.2 [°C]
 Humidity : 28.6 [%]
 Test place : 3m Semi-anechoic chamber
 Test engineer : Kazunori Saito

Date : December 2, 2016
 Temperature : 22.7 [°C]
 Humidity : 27.6 [%]
 Test place : 3m Semi-anechoic chamber
 Test engineer : Kazunori Saito

Date : December 26, 2016
 Temperature : 21.9 [°C]
 Humidity : 22.8 [%]
 Test place : 3m Semi-anechoic chamber
 Test engineer : Kazunori Saito

**[WCDMA Band V]
 (Channel: 4132)**

H/V	Frequency [MHz]	S.A Reading [dBm]	S.G Reading [dBm]	Cable loss [dB]	Ant.Gain [dBi]	Result [dBm]	Limit [dBm]	Margin [dB]
H	1652.8	-56.3	-77.4	1.1	6.8	-71.6	-13.0	58.6

(Channel: 4183)

H/V	Frequency [MHz]	S.A Reading [dBm]	S.G Reading [dBm]	Cable loss [dB]	Ant.Gain [dBi]	Result [dBm]	Limit [dBm]	Margin [dB]
H	1673.2	-56.4	-78.8	1.1	6.6	-73.2	-13.0	60.2

(Channel: 4233)

H/V	Frequency [MHz]	S.A Reading [dBm]	S.G Reading [dBm]	Cable loss [dB]	Ant.Gain [dBi]	Result [dBm]	Limit [dBm]	Margin [dB]
H	1693.2	-56.2	-77.9	1.1	6.4	-72.6	-13.0	59.6

9. Frequency Stability

9.1 Measurement procedure [FCC 22.355, 2.1055]

The EUT was placed of an inside of an constant temperature chamber as the temperature in the chamber was varied between -30°C and $+50^{\circ}\text{C}$. The temperature was incremented by 10°C intervals and the unit was allowed to stabilize at each measurement. The frequency drift was measured with the normal Temperature and voltage tolerance and it is presented as the ppm unit.

- Test configuration

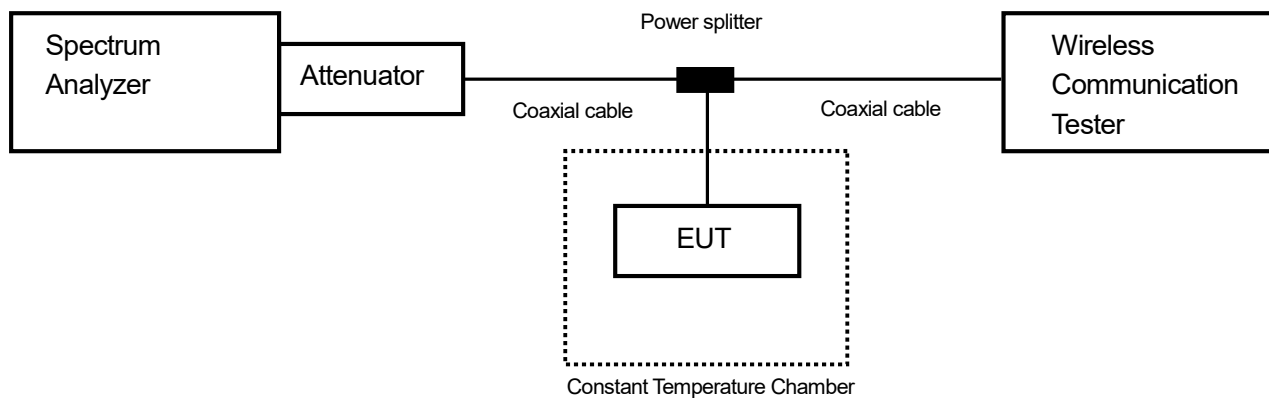

9.2 Limit

$\pm 2.5\text{ppm}$

9.3 Measurement result

Date : November 14, 2016
 Temperature : 23.8 [°C]
 Humidity : 36.2 [%]
 Test place : Shielded room No.4

Test engineer : Tadahiro Seino

[GSM850]

(Channel: 190)

Limit: $\pm 0.00025\% = \pm 2.5\text{ppm}$					
Power Supply [V]	Temperature [°C]	Measurements Frequency [Hz]	Frequency Tolerance [ppm]	Limit [ppm]	Result
3.80	25(Ref.)	836,599,987	0.00000	± 2.5	Pass
	50	836,600,015	0.03427	± 2.5	Pass
	40	836,600,014	0.03230	± 2.5	Pass
	30	836,600,011	0.02967	± 2.5	Pass
	20	836,600,012	0.02998	± 2.5	Pass
	10	836,600,012	0.03029	± 2.5	Pass
	0	836,599,986	-0.00039	± 2.5	Pass
	-10	836,599,987	0.00096	± 2.5	Pass
	-20	836,599,986	-0.00074	± 2.5	Pass
3.42	25	836,600,012	0.02975	± 2.5	Pass
4.18	25	836,599,989	0.00274	± 2.5	Pass

[WCDMA Band V]

(Channel: 4183)

Limit: $\pm 0.00025\% = \pm 2.5\text{ppm}$					
Power Supply [V]	Temperature [°C]	Measurements Frequency [Hz]	Frequency Tolerance [ppm]	Limit [ppm]	Result
3.80	25(Ref.)	836,599,997	0.00000	± 2.5	Pass
	50	836,599,997	0.00017	± 2.5	Pass
	40	836,599,997	0.00072	± 2.5	Pass
	30	836,599,997	-0.00031	± 2.5	Pass
	20	836,600,002	0.00665	± 2.5	Pass
	10	836,600,003	0.00770	± 2.5	Pass
	0	836,599,996	-0.00042	± 2.5	Pass
	-10	836,599,998	0.00135	± 2.5	Pass
	-20	836,600,003	0.00766	± 2.5	Pass
3.42	25	836,599,997	0.00044	± 2.5	Pass
4.18	25	836,599,997	0.00053	± 2.5	Pass

Calculation;

$$\text{Frequency Tolerance (ppm)} = \frac{\text{Measurements Frequency (Hz)} - \text{Reference Frequency (Hz)}}{\text{Reference Frequency (Hz)}} \times 1000000$$

10. Uncertainty of measurement

Expanded uncertainties stated are calculated with a coverage Factor $k=2$.

Please note that these results are not taken into account when determining compliance or non-compliance with test result.

Test item	Measurement uncertainty
Conducted emission at mains port	$\pm 3.0\text{dB}$
Radiated emission (9kHz – 30MHz)	$\pm 4.4\text{dB}$
Radiated emission (30MHz – 1000MHz)	$\pm 4.5\text{dB}$
Radiated emission (1000MHz – 26GHz)	$\pm 3.9\text{dB}$



Zacta

11. Laboratory Information

1. Location

Name: Yonezawa Testing Center
 Address: 5-4149-7, Hachimanpara, Yonezawa-shi, Yamagata, 992-1128 Japan
 Phone: +81-238-28-2881
 Fax: +81-238-28-2888

2. Accreditation and Registration

- 1) NVLAP
LAB CODE: 200306-0
- 2) VLAC
Accreditation No.: VLAC-013
- 3) BSMI
Laboratory Code: SL2-IN-E-6018, SL2-A1-E-6018

4) FCC

Registration number	Expiration date
540072	2017-2-20

5) Industry Canada

Site number	Facility	Expiration date
4224A-4	3m Semi-anechoic chamber	2017-12-03
4224A-5	10m Semi-anechoic chamber No.1	2017-12-03
4224A-6	10m Semi-anechoic chamber No.2	2019-12-14

6) VCCI Council

Registration number	Expiration date
A-0166	2017-07-03

Appendix A. Test equipment

Antenna port conducted test

Equipment	Company	Model No.	Serial No.	Cal. Due	Cal. Date
Spectrum analyzer	Agilent Technologies	E4440A	US40420937	Jul. 31, 2017	Jul. 15, 2016
Microwave cable	RS	YH-13S5	N/A(S403)	May 31, 2017	May 24, 2016
Attenuator	Weinschel	56-10	J4993	Nov. 30, 2016	Nov. 12, 2015
Attenuator	Weinschel	56-10	J4993	Nov. 30, 2017	Nov. 1, 2016
Microwave cable	SUHNER	SUCOFLEX104/1.5m	322087/4	Jul. 31, 2017	Jul. 20, 2016
Power divider	ANRITSU	K240B	020205	Jul. 31, 2017	Jul. 20, 2016
Power meter	ROHDE&SCHWARZ	NRP2	103269	Jun. 30, 2017	Jun. 27, 2016
Power sensor	ROHDE&SCHWARZ	NRP-Z81	102459	Jun. 30, 2017	Jun. 27, 2016
Wideband Radio Frequency Tester	ROHDE&SCHWARZ	CMW500	116338	May 31, 2017	May 18, 2016
Operation type temperature controlled bath	Espec	PL1KP	14007261	Jan. 31, 2017	Jan. 22, 2016

Radiated emission

Equipment	Company	Model No.	Serial No.	Cal. Due	Cal. Date
EMI Receiver	ROHDE&SCHWARZ	ESCI	100764	Aug. 31, 2017	Aug. 19, 2016
Preamplifier	ANRITSU	MH648A	M96057	May 31, 2017	May 10, 2016
Biconical antenna	Schwarzbeck	VHA9103/BBA9106	2155	Jun. 30, 2017	Jun. 2, 2016
Log periodic antenna	Schwarzbeck	UHALP9108A	0560	Jun. 30, 2017	Jun. 2, 2016
Attenuator	TME	CFA-01NPJ-6	N/A(S273)	May 31, 2017	May 25, 2016
Attenuator	TME	CFA-01NPJ-3	N/A(S270)	May 31, 2017	May 25, 2016
Spectrum analyzer	Agilent Technologies	E4440A	US40420937	Jul. 31, 2017	Jul. 15, 2016
Preamplifier	TSJ	MLA-1840-B03-35	1240332	Jun. 30, 2017	Jun. 16, 2016
Dipole antenna	Schwarzbeck	VHAP	1021	Oct. 31, 2017	Oct. 2, 2015
Dipole antenna	Schwarzbeck	UHAP	993	Oct. 31, 2017	Oct. 2, 2015
Double ridged guide antenna	EMCO	3115	5205	Mar. 31, 2017	Mar. 3, 2016
Double ridged guide antenna	ETS LINDGREN	3117	00052315	Feb. 28, 2017	Feb. 23, 2016
Attenuator	Agilent Technologies	8491B	MY39268633	Feb. 28, 2017	Feb. 23, 2016
Double ridged guide antenna	EMCO	3115	4328	Apr. 30, 2017	Apr. 11, 2016
Double ridged guide antenna	EMCO	3115	00058532	Dec. 31, 2017	Dec. 6, 2016
Signal generator	ROHDE&SCHWARZ	SMB100A	177525	Jun. 30, 2017	Jun. 21, 2016
Broad-Band Horn Antenna	Schwarzbeck	BBHA9170	BBHA9170189	Jun. 30, 2017	Jun. 16, 2016
Preamplifier	TSJ	MLA-1840-B03-35	1240332	Jun. 30, 2017	Jun. 16, 2016
Microwave cable	SUHNER	SUCOFLEX102/2m	31648	Mar. 31, 2017	Mar. 29, 2016
High pass filter	Micro-Tronics	HPM50115	004	Jul. 31, 2017	Jul. 20, 2016
High pass filter	Wainwright	WHKX2.8/18G-6SS	1	Jul. 31, 2017	Jul. 19, 2016
Wideband Radio Frequency Tester	ROHDE&SCHWARZ	CMW500	116338	May 31, 2017	May 18, 2016
Microwave cable	SUHNER	SUCOFLEX104/9m	346316/4	May 31, 2017	May 25, 2016
		SUCOFLEX104/1m	322084/4	May 31, 2017	May 25, 2016
		SUCOFLEX104/1.5m	317226/4	May 31, 2017	May 25, 2016
		SUCOFLEX104/7m	41625/6	May 31, 2017	May 25, 2016
PC	DELL	DIMENSION E521	75465BX	N/A	N/A
Software	TOYO Corporation	EP5/RE-AJ	0611193/V5.3.61	N/A	N/A
Absorber	RIKEN	PPF30	N/A	N/A	N/A
3m Semi an-echoic Chamber	TOKIN	N/A	N/A(9002-NSA)	May 31, 2017	May 11, 2016
3m Semi an-echoic Chamber	TOKIN	N/A	N/A(9002-SVSWR)	May 31, 2017	May 12, 2016

*: The calibrations of the above equipment are traceable to NIST or equivalent standards of the reference organizations.