



TEST REPORT



DT&C Co., Ltd.

42, Yurim-ro, 154Beon-gil, Cheoin-gu, Yongin-si, Gyeonggi-do, Korea, 17042
Tel : 031-321-2664, Fax : 031-321-1664

1. Report No : DRRFCC1612-0117(3)
2. Customer
 - Name : KYOCERA Corporation
 - Address : Yokohama Office 2-1-1 Kagahara, Tsuzuki-ku Yokohama-shi, Kanagawa, Japan
3. Use of Report : FCC Original Grant
4. Product Name / Model Name : Mobile Phone / DA03
FCC ID : JOYDA03
5. Test Method Used : RF exposure KDB procedures
Test Specification : CFR §2.1093
6. Date of Test : 2016-12-12 ~ 2016-12-27, 2017-01-31
7. Testing Environment : See appended test report
8. Test Result : Refer to the attached Test Result

Affirmation	Tested by	Technical Manager
	Name : HoSik Sim  (Signature)	Name : HakMin Kim  (Signature)

The test results presented in this test report are limited only to the sample supplied by applicant and the use of this test report is inhibited other than its purpose. This test report shall not be reproduced except in full, without the written approval of DT&C Co., Ltd.

2017 . 01 . 31 .

DT&C Co., Ltd.

If this report is required to confirmation of authenticity, please contact to report@dtnc.net

Test Report Version

Test Report No.	Date	Description
DRRFCC1612-0117	Dec. 28, 2016	Initial issue
DRRFCC1612-0117(1)	Jan. 12, 2017	Modify Maximum Output Power
DRRFCC1612-0117(2)	Jan. 25, 2017	Modify Tune up procedure
DRRFCC1612-0117(3)	Jan. 31, 2017	Add WIFI 5GHz SAR Test

Table of Contents

1. DESCRIPTION OF DEVICE.....	5
1.1 Guidance Applied	7
1.2 Device Overview	7
1.3 Nominal and Maximum Output Power Specifications	7
1.4 DUT Antenna Locations	11
1.5 SAR Test Exclusions Applied	12
1.6 Power Reduction for SAR	12
1.7 Device Serial Numbers	12
1.8 LTE Information	13
2. INTROCUCTION	14
3. DESCRIPTION OF TEST EQUIPMENT	15
3.1 SAR MEASUREMENT SETUP	15
3.2 EX3DV4Probe Specification	16
3.3 Probe Calibration Process	17
3.3.1 E-Probe Calibration	17
3.4 Data Extrapolation.....	18
3.5 SAM Twin PHANTOM	19
3.6 Device Holder for Transmitters.....	19
3.7 Brain & Muscle Simulation Mixture Characterization	20
3.8 SAR TEST EQUIPMENT	22
4. TEST SYSTEM SPECIFICATIONS.....	23
5. SAR MEASUREMENT PROCEDURE.....	24
5.1 Measurement Procedure.....	24
6. DEFINITION OF REFERENCE POINTS.....	25
6.1 Ear Reference Point	25
6.2 Handset Reference Points	25
7. TEST CONFIGURATION POSITIONS FOR HANDSETS	26
7.1 Device Holder.....	26
7.2 Positioning for Cheek/Touch	26
7.3 Positioning for Ear / 15 ° Tilt.....	26
7.4 Body-Worn Accessory Configurations.....	27
7.5 Extremity Exposure Configurations.....	27
7.6 Wireless Router Configurations	28
8. RF EXPOSURE LIMITS	29
9. FCC MEASUREMENT PROCEDURES	30
9.1 Measured and Reported SAR	30
9.2 Procedures Used to Establish RF Signal for SAR	30
9.3 SAR Measurement Conditions for WCDMA (UMTS)	30
9.3.1 Output Power Verification.....	30
9.3.2 Head SAR Measurements for Handsets	30
9.3.3 Body SAR Measurements	31
9.3.4 Release 5 HSDPA Data Devices.....	31
9.3.5 Release 6 HSUPA Data Devices.....	31
9.4 SAR Measurement Conditions for LTE	32
9.4.1 Spectrum Plots for RB Configurations	32
9.4.2 MPR.....	32
9.4.3 Required RB Size and RB Offsets for SAR Testing	32

9.5 SAR Testing with 802.11 Transmitters	33
9.5.1 General Device Setup	33
9.5.2 U-NII and U-NII-2A	33
9.5.3 U-NII-2C and U-NII-3.....	33
9.5.4 Initial Test Position Procedure	33
9.5.5 2.4 GHz SAR Test Requirements.....	34
9.5.6 OFDM Transmission Mode and SAR Test Channel Selection	34
9.5.7 Initial Test Configuration Procedure	34
9.5.8 Subsequent Test Configuration Procedures.....	34
10. RF CONDUCTED POWERS.....	35
10.1 GSM Conducted Powers.....	35
10.2 WCDMA Conducted Powers	36
10.3 LTE Conducted Powers	37
10.4 WLAN Conducted Powers	38
10.5 Bluetooth Conducted Powers.....	42
11. SYSTEM VERIFICATION	43
11.1 Tissue Verification.....	43
11.2 Test System Verification	45
12. SAR TEST RESULTS	46
12.1 Head SAR Results	46
12.2 Standalone Body-Worn SAR Worn SAR Results	49
12.3 Standalone Wireless router SAR Results	51
12.4 SAR Test Notes	53
13. FCC MULTI-TX AND ANTENNA SAR CONSIDERATIONS	55
13.1 Introduction.....	55
13.2 Simultaneous Transmission Procedures.....	55
13.3 Simultaneous Transmission Capabilities	55
13.4 Head SAR Simultaneous Transmission Analysis.....	57
13.5 Body-Worn Simultaneous Transmission Analysis.....	59
13.6 Hotspot SAR Simultaneous Transmission Analysis.....	60
13.7 Simultaneous Transmission Conclusion	60
14. SAR MEASUREMENT VARIABILITY	61
14.1 Measurement Variability.....	61
14.2 Measurement Uncertainty	61
15. IEEE Std 1528 –MEASUREMENT UNCERTAINTIES	62
16. CONCLUSION.....	74
17. REFERENCES	75
Attachment 1. – Probe Calibration Data	77
Attachment 2. – Dipole Calibration Data	89
Attachment 3. – SAR SYSTEM VALIDATION.....	138

1. DESCRIPTION OF DEVICE

Environmental evaluation measurements of specific absorption rate (SAR) distributions in emulated human head and body tissues exposed to radio frequency (RF) radiation from wireless portable devices for compliance with the rules and regulations of the U.S. Federal Communications Commission (FCC).

General Information

EUT type	Mobile Phone			
FCC ID	JOYDA03			
Equipment model name	DA03			
Equipment add model name	N/A			
Equipment serial no.	Identical prototype			
Mode(s) of Operation	GSM 850, PCS 1900, WCDMA 850, LTE Band 17, 2.4 G W-LAN (802.11b/g/n HT20), 5 G W-LAN (802.11a/n HT20/n HT40/ ac VHT20/ ac VHT40/ ac VHT80)			
TX Frequency Range	Band	Mode	Bandwidth	Frequency
	GSM 850	GSM/GPRS	-	824.2 ~ 848.8 MHz
	PCS 1900	GSM/GPRS	-	1850.2 ~ 1909.8 MHz
	WCDMA850	WCDMA	-	826.4 ~ 846.6 MHz
	LTE Band 17	LTE	-	706.5 ~ 713.5 MHz
	2.4 GHz W-LAN	802.11b/g/n	HT20	2412 ~ 2462 MHz
	5.2 GHz W-LAN	802.11a/n/ac	HT20/VHT20	5180 ~ 5240 MHz
			HT40/VHT40	5190 ~ 5230 MHz
			VHT80	5210 MHz
	5.3 GHz W-LAN	802.11a/n/ac	HT20/VHT20	5260 ~ 5320 MHz
			HT40/VHT40	5270 ~ 5310 MHz
			VHT80	5290 MHz
	5.6 GHz W-LAN	802.11a/n/ac	HT20/VHT20	5500 ~ 5700 MHz
			HT40/VHT40	5510 ~ 5670 MHz
			VHT80	5530 MHz
	RX Frequency Range	GSM 850	GSM/GPRS	-
PCS 1900		GSM/GPRS	-	1930.2 ~ 1989.8 MHz
WCDMA850		WCDMA	-	871.4 ~ 891.6 MHz
LTE Band 17		LTE	-	736.5 ~ 743.5 MHz
2.4 GHz W-LAN		802.11b/g/n	HT20	2412 ~ 2462 MHz
5.2 GHz W-LAN		802.11a/n/ac	HT20/VHT20	5180 ~ 5240 MHz
			HT40/VHT40	5190 ~ 5230 MHz
			VHT80	5210 MHz
5.3 GHz W-LAN		802.11a/n/ac	HT20/VHT20	5260 ~ 5320 MHz
			HT40/VHT40	5270 ~ 5310 MHz
			VHT80	5290 MHz
5.6 GHz W-LAN		802.11a/n/ac	HT20/VHT20	5500 ~ 5700 MHz
			HT40/VHT40	5510 ~ 5670 MHz
			VHT80	5530 MHz

Equipment Class	Band	Reported SAR		
		1g SAR (W/kg)		
		Head	Body-Worn	Hotspot
PCE	GSM 850	0.563	0.734	-
PCE	GPRS 850	0.732	1.004	1.004
PCE	PCS 1900	0.166	0.508	-
PCE	GPRS 1900	0.205	0.731	0.731
PCE	WCDMA850	0.437	0.537	0.537
PCE	LTE Band 17	0.377	0.576	0.576
DTS	2.4 GHz W-LAN	0.322	0.210	0.210
U-NII-2A	5.3 GHz W-LAN	0.535	0.358	-
U-NII-2C	5.6 GHz W-LAN	0.440	0.282	-
DSS/DTS	Bluetooth	N/A	0.118 ^{Note}	N/A
Simultaneous SAR per KDB 690783 D01v01r03		1.200	1.362	1.214
FCC Equipment Class	Licensed Portable Transmitter Held to Ear (PCE) Part 15 Spread Spectrum Transmitter(DSS) Digital Transmission System(DTS) Unlicensed National Information Infrastructure (UNII)			
Date(s) of Tests	2016-12-12 ~ 2016-12-27			
Antenna Type	Internal Type Antenna			
Note	Bluetooth SAR was estimated.			
Functions	<ul style="list-style-type: none"> ● GSM/GPRS(GPRS Class: 33) supported. * DTM not supported. ● BT(2.4GHz) / W-LAN(2.4GHz 802.11b/g/n(HT20)) supported. W-LAN(5GHz 802.11a/n(HT20)/n(HT40)/ac(VHT20)/ac(VHT40)/ac(VHT80)) supported * No simultaneous transmission between BT & WLAN ● Simultaneous transmission between GSM, WCDMA voice & WLAN / GPRS, WCDMA & WLAN / LTE & WLAN. ● VoIP is supported. ● WiFi 2.4GHz Mobile Hotspot supported. 			

1.1 Guidance Applied

- IEEE 1528-2013
- FCC KDB Publication 941225 D01 3G SAR Procedures v03r01
- FCC KDB Publication 941225 D05 SAR for LTE Devices v02r05
- FCC KDB Publication 941225 D06 Hot Spot SAR v02r01
- FCC KDB Publication 248227 D01v02r02 (802.11 Wi-Fi SAR)
- FCC KDB Publication 447498 D01v06 (General RF Exposure Guidance)
- FCC KDB Publication 648474 D04 Handset SAR v01r03
- FCC KDB Publication 690783 D01 SAR Listings on Grants v01r03
- FCC KDB Publication 865664 D01 SAR Measurement 100 MHz to 6 GHz v01r04
- FCC KDB Publication 865664 D02 RF Exposure Reporting v01r02
- October 2013 TCB Workshop Notes (GPRS testing criteria)

1.2 Device Overview

Equipment Class	Mode	Operating Modes	Tx Frequency
PCE	GSM/GPRS 850	Voice/Data	824.2 ~ 848.8 MHz
PCE	GSM/GPRS 1900	Voice/Data	1850.2 ~ 1909.8 MHz
PCE	WCDMA 850	Voice/Data	826.4 ~ 846.6 MHz
PCE	LTE Band 17	Data	706.5 ~ 713.5 MHz
DTS	2.4 GHz WLAN	Data	2412 ~ 2462 MHz
U-NII-1	5.2 GHz WLAN	Data	5180 ~ 5240 MHz
U-NII-2A	5.3 GHz WLAN	Data	5260 ~ 5320 MHz
U-NII-2C	5.6 GHz WLAN	Data	5500 ~ 5700 MHz
DSS/DTS	Bluetooth	Data	2402 ~ 2480 MHz

1.3 Nominal and Maximum Output Power Specifications

This device operates using the following maximum and nominal output power specifications. SAR values were scaled to the maximum allowed power to determine compliance per KDB Publication 447498 D01v06

Band & Mode			Voice [dBm] 1 TX Slot	Burst Average GMSK [dBm]			
				1 TX Slot	2 TX Slot	3 TX Slot	4 TX Slot
PCE	GSM/GPRS850	Maximum	33.0	33.0	31.0	29.0	27.5
		Nominal	32.0	32.0	30.0	28.0	26.5
		Minimum	30.7	30.7	28.7	26.7	25.2
	GSM/GPRS1900	Maximum	29.5	29.5	28.0	26.0	24.0
		Nominal	28.5	28.5	27.0	25.0	23.0
		Minimum	27.1	27.1	25.6	23.6	21.6

Band & Mode			Modulated Average [dBm]					
			3GPP WCDMA	3GPP HSDPA				
				Rel. 99	Rel. 5			
					Subtest 1	Subtest 2	Subtest 3	Subtest 4
PCE	WCDMA 850	Maximum	24.3	23.3	23.3	21.8	21.8	
		Nominal	23.3	22.3	22.3	20.8	20.8	
		Minimum	20.6	19.6	19.6	18.1	18.1	

Note : This device supports HSUPA but the manufacturer only declares on the tune-up procedure that the HSUPA transmitter's power will not exceed the R99 maximum transmit power in devices based on Qualcomm's HSPA chipset solution.

Band & Mode			Modulated Average [dBm]
PCE	LTE Band 17	Maximum	24.8
		Nominal	23.8
		Minimum	21.0

Band & Mode			Modulated Average [dBm]
DTS	IEEE 802.11b (2.4GHz)	Maximum	16.5
		Nominal	15.0
		Minimum	10.0
	IEEE 802.11g (2.4GHz)	Maximum	12.5
		Nominal	11.0
		Minimum	6.0
	IEEE 802.11n HT20 (2.4GHz)	Maximum	12.5
		Nominal	11.0
		Minimum	6.0

Band & Mode		Modulated Average [dBm]	
U-NII-1 U-NII-2A U-NII-2C	IEEE 802.11a (5.2 GHz)	Maximum	13.5
		Nominal	12.0
		Minimum	7.0
	IEEE 802.11a (5.3 GHz)	Maximum	15.5
		Nominal	14.0
		Minimum	9.0
	IEEE 802.11a (5.6 GHz, 100ch, 140ch)	Maximum	13.5
		Nominal	12.0
		Minimum	7.0
	IEEE 802.11a (5.6 GHz, except 100ch, 140ch)	Maximum	15.5
		Nominal	14.0
		Minimum	9.0
	IEEE 802.11n HT20 (5.2 GHz)	Maximum	13.5
		Nominal	12.0
		Minimum	7.0
	IEEE 802.11n HT20 (5.3 GHz)	Maximum	15.5
		Nominal	14.0
		Minimum	9.0
	IEEE 802.11n HT20 (5.6 GHz, 100ch, 140ch)	Maximum	13.5
		Nominal	12.0
		Minimum	7.0
	IEEE 802.11n HT20 (5.6 GHz, except 100ch, 140ch)	Maximum	15.5
		Nominal	14.0
		Minimum	9.0
	IEEE 802.11n HT40 (5.2 GHz, 5.3 GHz, 5.6 GHz)	Maximum	13.5
		Nominal	12.0
		Minimum	7.0
	IEEE 802.11ac VHT20 (5.2 GHz)	Maximum	13.5
		Nominal	12.0
		Minimum	7.0
IEEE 802.11ac VHT20 (5.3 GHz)	Maximum	15.5	
	Nominal	14.0	
	Minimum	9.0	
IEEE 802.11ac VHT20 (5.6 GHz, 100ch, 140ch)	Maximum	13.5	
	Nominal	12.0	
	Minimum	7.0	
IEEE 802.11ac VHT20 (5.6 GHz, except 100ch, 140ch)	Maximum	15.5	
	Nominal	14.0	
	Minimum	9.0	
IEEE 802.11ac VHT40 (5.2 GHz, 5.3 GHz, 5.6 GHz)	Maximum	13.5	
	Nominal	12.0	
	Minimum	7.0	
IEEE 802.11ac VHT80 (5.2 GHz, 5.3 GHz, 5.6 GHz)	Maximum	13.0	
	Nominal	11.5	
	Minimum	6.5	

Band & Mode			Modulated Average [dBm]
DSS	Bluetooth 1 Mbps	Maximum	7.5
		Nominal	6.0
		Minimum	3.0
	Bluetooth 2 Mbps (Low Ch)	Maximum	6.0
		Nominal	4.0
		Minimum	1.0
	Bluetooth 3 Mbps (Mid Ch, High Ch)	Maximum	6.0
		Nominal	4.0
		Minimum	1.0
DTS	Bluetooth LE	Maximum	3.5
		Nominal	2.0
		Minimum	-1.0

1.4 DUT Antenna Locations

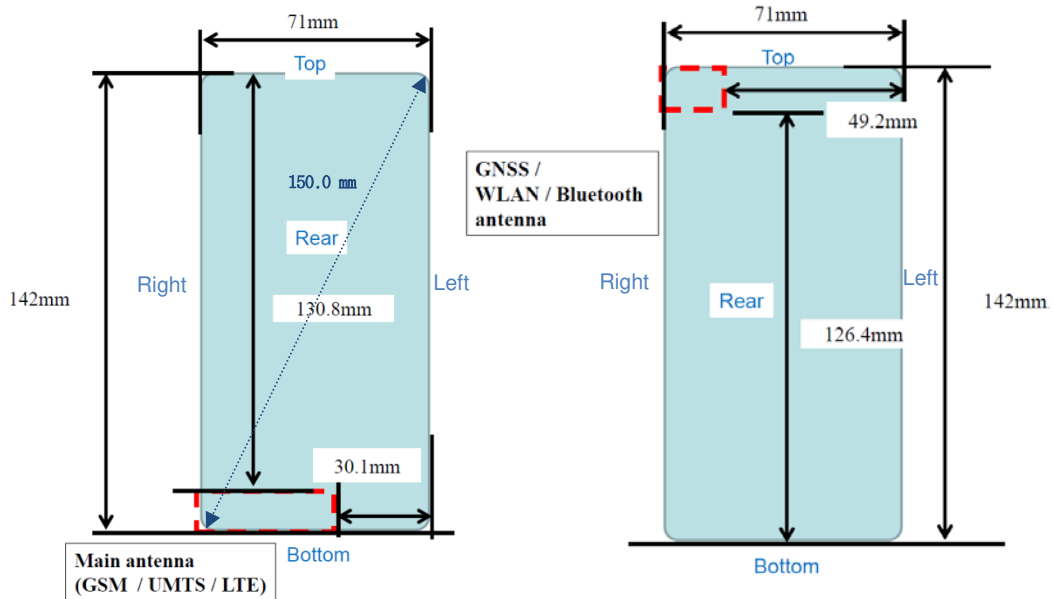

Note 1: Exact antenna dimensions and separation distances are shown in the “Antenna information.pdf” in the FCC Filing.
 Note 2: Since the diagonal dimension of this device is < 160 mm, it is not considered a “phablet”.

Mode	Mobile Hotspot Sides for SAR Testing					
	Top	Bottom	Front	Rear	Right	Left
GPRS 850	X	O	O	O	O	X
GPRS 1900	X	O	O	O	O	X
WCDMA 850	X	O	O	O	O	X
LTE Band 17	X	O	O	O	O	X
2.4G W-LAN(802.11b)	O	X	O	O	O	X
5G W-LAN(802.11a)	X	X	O	O	X	X

Note 1: Particular DUT edges were not required to be evaluated for Wireless Router SAR if the edges were greater than 2.5 cm from the transmitting antenna according to FCC KDB Publication 941225 D06v02r01 guidance, page 2. The antenna document shows the distances between the transmit antennas and the edges of the device.

Note 2: 5GHz WLAN Hotspot is not supported.

1.5 SAR Test Exclusions Applied

(A) WIFI & BT

Per FCC KDB 447498 D01v06, the SAR exclusion threshold for distances < 50 mm is defined by the following equation:

$$\frac{\text{Max Power of Channel (mW)}}{\text{Test Separation Dist (mm)}} * \sqrt{\text{Frequency(GHz)}} \leq 3.0$$

Table 1.1 SAR exclusion threshold for distances < 50 mm

Band	Mode	Equation	Result	SAR exclusion threshold	Required SAR
DSS	Bluetooth	[(6/10)* √2.480]	0.9	3.0	X
DTS	Bluetooth LE	[(2/10)* √2.480]	0.4	3.0	X
DTS	2.4 GHz W-LAN	[(45/5)* √2.462]	14.0	3.0	O
U-NII	5 GHz W-LAN	[(35/5)* √5.660]	16.9	3.0	O

Per KDB Publication 447498 D01v06, the maximum power of the channel was rounded to the nearest mW before calculation.

(B) Licensed Transmitter(s)

GSM/GPRS DTM is not supported for US bands. Therefore, the GSM Voice modes in this report do not transmit simultaneously with GPRS Data.

1.6 Power Reduction for SAR

There is no power reduction used for any band/mode implemented in this device for SAR purposes.

1.7 Device Serial Numbers

Band & Mode	Head Serial Number	Body-Worn Serial Number	Hotspot Serial Number
GSM/GPRS 850	FCC #1	FCC #1	FCC #1
GSM/GPRS 1900	FCC #1	FCC #1	FCC #1
WCDMA 850	FCC #1	FCC #1	FCC #1
LTE Band 17	FCC #1	FCC #1	FCC #1
2.4 GHz WLAN	FCC #1	FCC #1	FCC #1
5 GHz WLAN	FCC #1	FCC #1	FCC #1

1.8 LTE Information

LTE Information			
FCC ID	JOYDA03		
Form Factor	Mobile Phone		
Frequency Range of each LTE transmission Band	LTE Band 17 (706.5 ~ 713.5 MHz)		
Channel Bandwidths	LTE Band 17: 10 MHz, 5 MHz		
Channel Number and Frequencies (MHz)	Low	Mid	High
LTE Band 17: 10 MHz	709.0(23780)	710.0(23790) ^{Note1}	711.0(23800)
LTE Band 17: 5 MHz	706.5(23755)	710.0(23790) ^{Note1}	713.5(23825)
UE Category / Modulations Supported	UE Category 4 / QPSK, 16QAM		
LTE MPR Permanently implemented per 3GPP TS 36.101 section 6.2.3~6.2.5? (manufacturer attestation to be provided)	Yes		
A-MPR (Additional MPR) disabled for SAR Testing?	LTE A-MPR is not supported.		
LTE Carrier Aggregation	This device does not support both UL and DL carrier aggregation.		

Note 1: LTE Band 17 at 10 MHz/5 MHz bandwidth does not support three non-overlapping channels. Per KDB 941225 D05v02r05, when a device supports overlapping channel assignment in a channel bandwidth configuration, the middle channel of the group of overlapping channels should be selected for testing.

2. INTROCUCTION

The FCC and Industry Canada have adopted the guidelines for evaluating the environmental effects of radio frequency (RF) radiation in ET Docket 93-62 on Aug. 6, 1996 and Health Canada Safety Code 6 to protect the public and workers from the potential hazards of RF emissions due to FCC-regulated portable devices.

The FCC has adopted the guidelines for evaluating the environmental effects of radio frequency radiation in ET Docket 93-62 on Aug. 6, 1996 to protect the public and workers from the potential hazards of RF emissions due to FCC-regulated portable devices. The safety limits used for the environmental evaluation measurements are based on the criteria published by the American National Standards Institute (ANSI) for localized specific absorption rate (SAR) in IEEE/ANSI C95*.1-2005 Standard for Safety Levels with Respect to Human Exposure to Radio Frequency Electromagnetic Fields, 3 kHz to 300 GHz. 1992 by the Institute of Electrical and Electronics Engineers, Inc., New York, New York 10017. The measurement procedure described in IEEE/ANSI C95.3-1992 Recommended Practice for the Measurement of Potentially Hazardous Electromagnetic Fields - RF and Microwave is used for guidance in measuring SAR due to the RF radiation exposure from the Equipment Under Test (EUT). These criteria for SAR evaluation are similar to those recommended by the National Council on Radiation Protection and Measurements (NCRP) in Biological Effects and Exposure Criteria for Radio frequency Electromagnetic Fields," NCRP Report No. 86 NCRP, 1986, Bethesda, MD 20814. SAR is a measure of the rate of energy absorption due to exposure to an RF transmitting source. SAR values have been related to threshold levels for potential biological hazards.

SAR Definition

Specific Absorption Rate (SAR) is defined as the time derivative (rate) of the incremental energy (dU) absorbed by (dissipated in) an incremental mass (dm) contained in a volume element (dV) of a given density (ρ) It is also defined as the rate of RF energy absorption per unit mass at a point in an absorbing body (see Fig. 2.1)

$$SAR = \frac{d}{dt} \left(\frac{dU}{dm} \right) = \frac{d}{dt} \left(\frac{dU}{\rho dV} \right)$$

Fig. 2.1 SAR Mathematical Equation

SAR is expressed in units of Watts per Kilogram (W/kg).

$$SAR = \frac{\sigma \cdot E^2}{\rho}$$

where:

- σ = conductivity of the tissue-simulating material (S/m)
- ρ = mass density of the tissue-simulating material (kg/m³)
- E = Total RMS electric field strength (V/m)

NOTE: The primary factors that control rate of energy absorption were found to be the wavelength of the incident field in relations to the dimensions and geometry of the irradiated organism, the orientation of the organism in relation to the polarity of field vectors, the presence of reflecting surfaces, and whether conductive contact is made by the organism with a ground plane.

3. DESCRIPTION OF TEST EQUIPMENT

3.1 SAR MEASUREMENT SETUP

Measurements are performed using the DASY5 automated dosimetric assessment system. The DASY5 is made by Schmid & Partner Engineering AG (SPEAG) in Zurich, Switzerland and consists of high precision robotics system (Staubli), robot controller, desktop computer, near-field probe, probe alignment sensor, and the generic twin phantom containing the brain equivalent material. The robot is a six-axis industrial robot performing precise movements to position the probe to the location (points) of maximum electromagnetic field (EMF) (see Fig. 3.1).

A cell controller system contains the power supply, robot controller each pendant (Joystick), and a remote control used to drive the robot motors. The PC consists of the Intel Core i7-3770 3.40 GHz desktop computer with Windows 7 system and SAR Measurement Software DASY5, A/D interface card, monitor, mouse, and keyboard. The Staubli Robot is connected to the cell controller to allow software manipulation of the robot. A data acquisition electronic (DAE) circuit that performs the signal amplification, signal multiplexing, AD-conversion, offset measurements, mechanical surface detection, collision detection, etc. is connected to the Electro-optical coupler (EOC). The EOC performs the conversion from the optical into digital electric signal of the DAE and transfers data to the PC plug-in card.

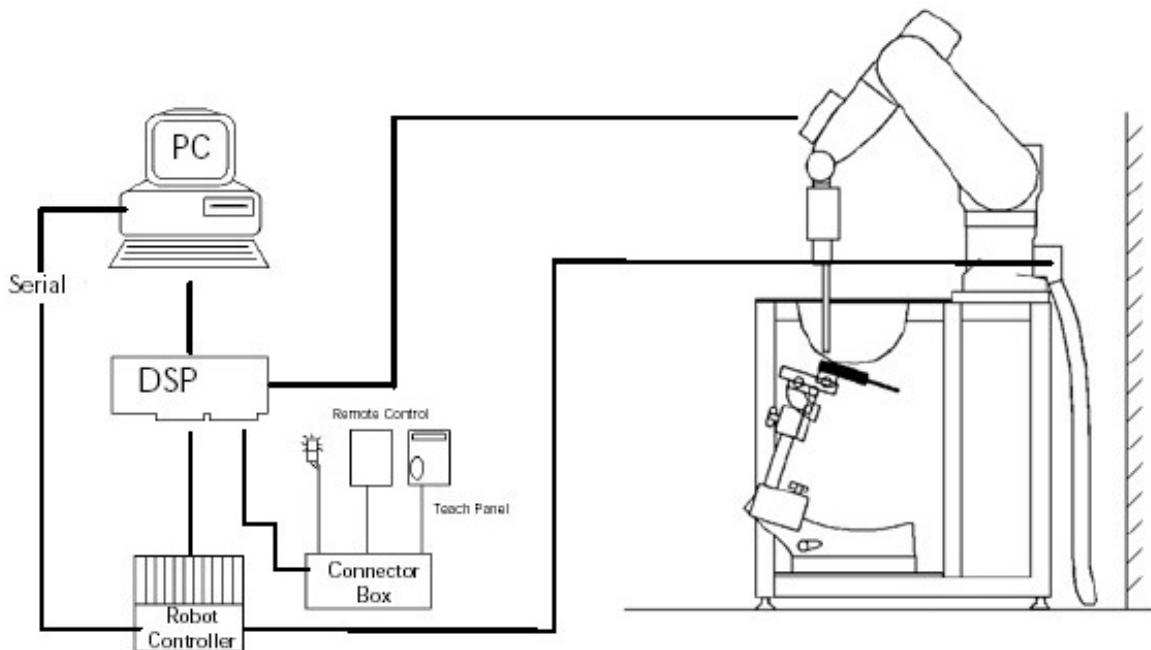

Figure 3.1 SAR Measurement System Setup

The DAE4 consists of a highly sensitive electrometer-grade preamplifier with auto-zeroing, a channel and gain-switching multiplexer, a fast 16 bit AD-converter and a command decoder and control logic unit. Transmission to the PC-card is accomplished through an optical downlink for data and status information and an optical uplink for commands and clock lines. The mechanical probe mounting device includes two different sensor systems for frontal and sidewise probe contacts. They are also used for mechanical surface detection and probe collision detection. The robot uses its own controller with a built in VME-bus computer. The system is described in detail.

3.2 EX3DV4Probe Specification

Calibration	In air from 10 MHz to 6 GHz In brain and muscle simulating tissue at Frequencies of 750 MHz, 835 MHz, 900 MHz, 1750 MHz, 1900 MHz, 2300 MHz, 2450 MHz, 2600 MHz, 3500 MHz, 5200 MHz, 5300 MHz, 5500 MHz, 5600 MHz, 5800 MHz
Frequency	10 MHz to 6 GHz
Linearity	± 0.2 dB(30 MHz to 6 GHz)
Dynamic	10 μW/g to > 100 mW/g
Range	Linearity : ±0.2dB
Dimensions	Overall length : 337 mm
Tip length	20 mm
Body diameter	12 mm
Tip diameter	2.5 mm
Distance from probe tip to sensor center	1.0 mm
Application	SAR Dosimetry Testing Compliance tests of mobile phones

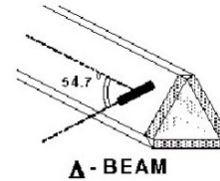
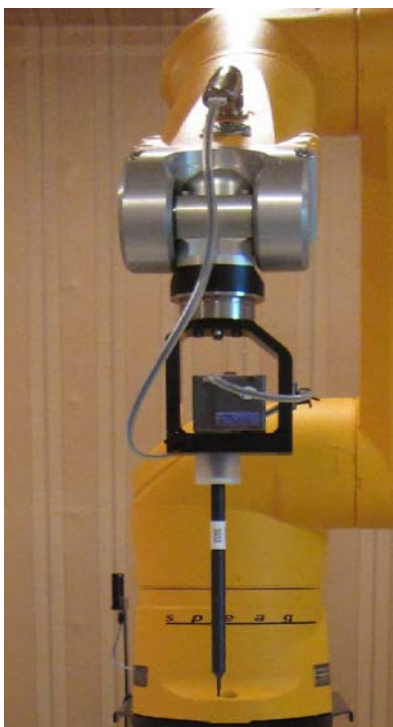

Figure 3.2 Triangular Probe Configurations



Figure 3.3 Probe Thick-Film Technique



DAE System

The SAR measurements were conducted with the dosimetric probe EX3DV4, designed in the classical triangular configuration(see Fig. 3.2) and optimized for dosimetric evaluation. The probe is constructed using the thick film technique; with printed resistive lines on ceramic substrates. The probe is equipped with an optical multitier line ending at the front of the probe tip. It is connected to the EOC box on the robot arm and provides an automatic detection of the phantom surface. Half of the fibers are connected to a pulsed infrared transmitter, the other half to a synchronized receiver. As the probe approaches the surface, the reflection from the surface produces a coupling from the transmitting to the receiving fibers. This reflection increases first during the approach, reaches maximum and then decreases. If the probe is flatly touching the surface, the coupling is zero. The distance of the coupling maximum to the surface is independent of the surface reflectivity and largely independent of the surface to probe angle. The DASY5 software reads the reflection during a software approach and looks for the maximum using a 2nd order fitting. The approach is stopped at reaching the maximum.

3.3 Probe Calibration Process

3.3.1 E-Probe Calibration

Dosimetric Assessment Procedure

Each probe is calibrated according to a dosimetric assessment procedure with accuracy better than +/- 10%. The spherical isotropy was evaluated with the procedure and found to be better than +/-0.25dB. The sensitivity parameters (Norm X, Norm Y, Norm Z), the diode compression parameter (DCP) and the conversion factor (Conv F) of the probe is tested.

Free Space Assessment

The free space E-field from amplified probe outputs is determined in a test chamber. This is performed in a TEM cell for frequencies below 1 GHz, and in a waveguide above 1GHz for free space. For the free space calibration, the probe is placed in the volumetric center of the cavity at the proper orientation with the field. The probe is then rotated 360 degrees.

Temperature Assessment *

E-field temperature correlation calibration is performed in a flat phantom filled with the appropriate simulated brain tissue. The measured free space E-field in the medium, correlates to temperature rise in a dielectric medium. For temperature correlation calibration a RF transparent the remits or based temperature probe is used in conjunction with the E-field probe.

$$SAR = C \frac{\Delta T}{\Delta t}$$

where:

Δt = exposure time (30 seconds),

C = heat capacity of tissue (brain or muscle),

ΔT = temperature increase due to RF exposure.

$$SAR = \frac{|E|^2 \cdot \sigma}{\rho}$$

where:

σ = simulated tissue conductivity,

ρ = Tissue density (1.25 g/cm³ for brain tissue)

SAR is proportional to $\Delta T / \Delta t$, the initial rate of tissue heating, before thermal diffusion takes place. Now it's possible to quantify the electric field in the simulated tissue by equating the thermally derived SAR to the E- field;

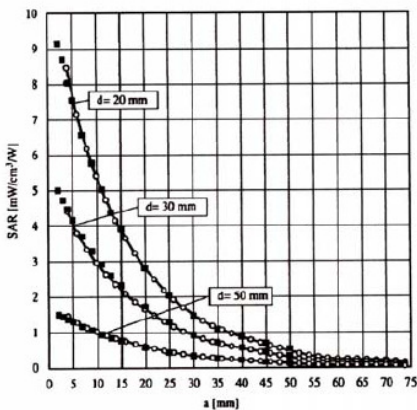

Figure 3.4 E-Field and Temperature Measurements at 900MHz

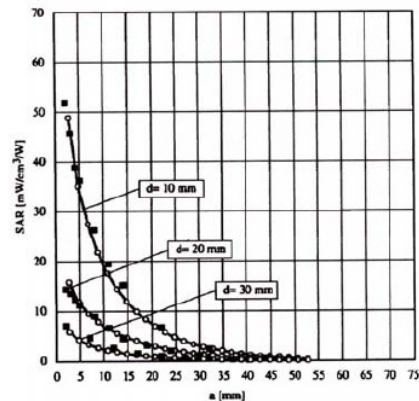

Figure 3.5 E-Field and Temperature Measurements at 1800MHz

3.4 Data Extrapolation

The DASY5 software automatically executes the following procedures to calculate the field units from the microvolt readings at the probe connector. The first step of the evaluation is a linearization of the filtered input signal to account for the compression characteristics of the detector diode. The compensation depends on the input signal, the diode type and the DC-transmission factor from the diode to the evaluation electronics. If the exciting field is pulsed, the crest factor of the signal must be known to correctly compensate for peak power. The formula for each channel can be given like below;

$$V_i = U_i + U_i^2 \cdot \frac{cf}{dcp_i}$$

with V_i = compensated signal of channel i (i=x,y,z)
 U_i = input signal of channel i (i=x,y,z)
 cf = crest factor of exciting field (DASY parameter)
 dcp_i = diode compression point (DASY parameter)

From the compensated input signals the primary field data for each channel can be evaluated:

E-field probes:

$$E_i = \sqrt{\frac{V_i}{Norm_i \cdot ConvF}}$$

with V_i = compensated signal of channel i (i = x,y,z)
 $Norm_i$ = sensor sensitivity of channel i (i = x,y,z)
 $\mu V/(V/m)^2$ for E-field probes
 ConvF = sensitivity of enhancement in solution
 E_i = electric field strength of channel i in V/m

The RSS value of the field components gives the total field strength (Hermetian magnitude):

$$E_{tot} = \sqrt{E_x^2 + E_y^2 + E_z^2}$$

The primary field data are used to calculate the derived field units.

$$SAR = E_{tot}^2 \cdot \frac{\sigma}{\rho \cdot 1000}$$

with SAR = local specific absorption rate in W/g
 E_{tot} = total field strength in V/m
 σ = conductivity in [mho/m] or [Siemens/m]
 ρ = equivalent tissue density in g/cm³

The power flow density is calculated assuming the excitation field to be a free space field.

$$P_{true} = \frac{E_{tot}^2}{3770}$$

with P_{pwe} = equivalent power density of a plane wave in W/cm²
 E_{tot} = total electric field strength in V/m

3.5 SAM Twin PHANTOM

The SAM Twin Phantom V5.0 is constructed of a fiberglass shell integrated in a wooden table. The shape of the shell is based on data from an anatomical study designed to determine the maximum exposure in at least 90% of all users. It enables the dosimetric evaluation of left and right hand phone usage as well as body mounted usage at the flat phantom region. A cover prevents the evaporation of the liquid.

Reference markings on the Phantom allow the complete setup of all predefined phantom positions and measurement grids by manually teaching three points in the robot. (see Fig. 3.6)



Figure 3.6 SAM Twin Phantom

SAM Twin Phantom Specification:

Construction

The shell corresponds to the specifications of the Specific Anthropomorphic Mannequin (SAM) phantom defined in IEEE 1528 and IEC 62209-1. It enables the dosimetric evaluation of left and right hand phone usage as well as body mounted usage at the flat phantom region. A cover prevents evaporation of the liquid. Reference markings on the phantom allow the complete setup of all predefined phantom positions and measurement grids by teaching three points with the robot.

Twin SAM V5.0 has the same shell geometry and is manufactured from the same material as Twin SAM V4.0, but has reinforced top structure.

Shell Thickness

2 ± 0.2 mm

Filling Volume

Approx. 25 liters

Dimensions

Length: 1000 mm

Width: 500 mm

Height: adjustable feet

Specific Anthropomorphic Mannequin (SAM) Specifications:

The phantom for handset SAR assessment testing is a low-loss dielectric shell, with shape and dimensions derived from the anthropometric data of the 90th percentile adult male head dimensions as tabulated by the US Army. The SAM Twin Phantom shell is bisected along the mid-sagittal plane into right and left halves (see Fig. 3.7). The perimeter sidewalls of each phantom halves are extended to allow filling with liquid to a depth that is sufficient to minimized reflections from the upper surface. The liquid depth is maintained at a minimum depth of 15cm to minimize reflections from the upper surface.



Figure 3.7 Sam Twin Phantom shell

3.6 Device Holder for Transmitters

In combination with the Twin SAM Phantom V4.0/V4.0c, V5.0 or ELI4, the Mounting Device enables the rotation of the mounted transmitter device in spherical coordinates. Rotation point is the ear opening point. Transmitter devices can be easily and accurately positioned according to IEC, IEEE, FCC or other specifications. The device holder can be locked for positioning at different phantom sections (left head, right head, flat).

Note: A simulating human hand is not used due to the complex anatomical and geometrical structure of the hand that may produce infinite number of configurations. To produce the worst-case condition (the hand absorbs antenna output power), the hand is omitted during the tests.



Figure 3.8 Mounting Device

3.7 Brain & Muscle Simulation Mixture Characterization

The brain and muscle mixtures consist of a viscous gel using hydrox-ethylcellulose (HEC) gelling agent and saline solution (see Table 3.1). Preservation with a bactericide is added and visual inspection is made to make sure air bubbles are not trapped during the mixing process. The mixture is calibrated to obtain proper dielectric constant (permittivity) and conductivity of the desired tissue. The mixture characterizations used for the brain and muscle tissue simulating liquids are according to the data by C. Gabriel and G. Harts grove.



Figure 3.9 Simulated Tissue

Table3.1 Composition of the Tissue Equivalent Matter

Ingredients (% by weight)	Frequency (MHz)							
	835		1900		2450		5200 ~ 5800	
Tissue Type	Head	Body	Head	Body	Head	Body	Head	Body
Water	40.19	50.75	55.24	70.23	71.88	73.40	65.52	80.00
Salt (NaCl)	1.480	0.940	0.310	0.290	0.160	0.060	-	-
Sugar	57.90	48.21	-	-	-	-	-	-
HEC	0.250	-	-	-	-	-	-	-
Bactericide	0.180	0.100	-	-	-	-	-	-
Triton X-100	-	-	-	-	19.97	-	17.24	-
DGBE	-	-	44.45	29.48	7.990	26.54	-	-
Diethylene glycol hexyl ether	-	-	-	-	-	-	17.24	-
Polysorbate (Tween) 80	-	-	-	-	-	-	-	20.00
Target for Dielectric Constant	41.5	55.2	40.0	53.3	39.2	52.7	-	-
Target for Conductivity (S/m)	0.90	0.97	1.40	1.52	1.80	1.95	-	-

- Salt: 99 % Pure Sodium Chloride Sugar: 98 % Pure Sucrose
- Water: De-ionized, 16M resistivity HEC: Hydroxyethyl Cellulose
- DGBE: 99 % Di(ethylene glycol) butyl ether,[2-(2-butoxyethoxy) ethanol]
- Triton X-100(ultra pure): Polyethylene glycol mono[4-(1,1,3,3-tetramethylbutyl)phenyl] ether

HSL/MSL750 (Head and Body liquids for 700 – 800 MHz)

Item	Head Tissue Simulation Liquids HSL750
	Muscle (body) Tissue Simulation Liquids MSL750
Type No	SL AAH 075, SL AAM 075
Manufacturer	SPEAG
The item is composed of the following ingredients:	
H2O	Water, 35 – 58%
Sucrose	Sucrose, 40 – 60%
NaCl	Sodium Chloride, 0 – 6%
Hydroxyethyl-cellulose	Medium Viscosity (CAS# 9004-62-0), < 0.3%
Preventol-D7	Preservative: aqueous preparation, (CAS# 55965-84-9), containing 5-chloro-2-methyl-3(2H)-isothiazolone and 2-methyl-3(2H)-isothiazolone, 0.1 – 0.6%

3.8 SAR TEST EQUIPMENT

Table 3.2 Test Equipment Calibration

	Type	Manufacturer	Model	Cal.Date	Next.Cal.Date	S/N
<input checked="" type="checkbox"/>	SEMITEC Engineering	SEMITEC	N/A	N/A	N/A	Shield Room
<input checked="" type="checkbox"/>	Robot	SCHMID	TX90XL	N/A	N/A	F13/5P9GA1/A/01
<input checked="" type="checkbox"/>	Robot Controller	SCHMID	CS8C	N/A	N/A	F13/5P9GA1/C/01
<input checked="" type="checkbox"/>	Joystick	SCHMID	N/A	N/A	N/A	S-12450905
<input checked="" type="checkbox"/>	IntelCorei7-3770 3.40 GHz Windows 7 Professional	N/A	N/A	N/A	N/A	N/A
<input checked="" type="checkbox"/>	Probe Alignment Unit LB	N/A	N/A	N/A	N/A	SE UKS 030 AA
<input checked="" type="checkbox"/>	Device Holder	SCHMID	Holder	N/A	N/A	SD000H01HA
<input checked="" type="checkbox"/>	Twin SAM Phantom	SCHMID	QD000P40CD	N/A	N/A	1782
<input checked="" type="checkbox"/>	Data Acquisition Electronics	SCHMID	DAE4V1	2016-09-19	2017-09-19	1453
<input checked="" type="checkbox"/>	Dosimetric E-Field Probe	SCHMID	EX3DV4	2016-09-27	2017-09-27	3933
<input checked="" type="checkbox"/>	750MHz SAR Dipole	SCHMID	D750V3	2016-01-27	2018-01-27	1049
<input checked="" type="checkbox"/>	835MHz SAR Dipole	SCHMID	D835V2	2016-09-28	2018-09-28	4d159
<input checked="" type="checkbox"/>	1900MHz SAR Dipole	SCHMID	D1900V2	2016-09-28	2018-09-28	5d176
<input checked="" type="checkbox"/>	2450MHz SAR Dipole	SCHMID	D2450V2	2016-09-23	2018-09-23	920
<input checked="" type="checkbox"/>	5GHz SAR Dipole	SCHMID	D5GHzV2	2016-03-15	2018-03-15	1212
<input checked="" type="checkbox"/>	Network Analyzer	Agilent	E5071C	2015-12-14 2016-12-14	2016-12-14 2017-12-14	MY46111534
<input checked="" type="checkbox"/>	Signal Generator	Agilent	E4438C	2016-09-09	2017-09-09	US41461520
<input checked="" type="checkbox"/>	Amplifier	EMPOWER	BBS3Q7ELU	2016-09-08	2017-09-08	1020
<input checked="" type="checkbox"/>	High Power RF Amplifier	EMPOWER	BBS3Q8CCJ	2016-10-18	2017-10-18	1005
<input checked="" type="checkbox"/>	Power Meter	HP	EPM-442A	2016-02-25	2017-02-25	GB37170267
<input checked="" type="checkbox"/>	Power Meter	HP	EPM-442A	2016-06-23	2017-06-23	GB37170413
<input checked="" type="checkbox"/>	Power Sensor	HP	8481A	2016-02-25	2017-02-25	3318A96566
<input checked="" type="checkbox"/>	Power Sensor	HP	8481A	2016-02-04	2017-02-04	2702A65976
<input checked="" type="checkbox"/>	Power Sensor	HP	8481A	2016-06-23	2017-06-23	3318A96332
<input checked="" type="checkbox"/>	Dual Directional Coupler	Agilent	778D-012	2016-01-05	2017-01-05	50228
<input checked="" type="checkbox"/>	Directional Coupler	HP	772D	2016-07-26	2017-07-26	2889A01064
<input checked="" type="checkbox"/>	Low Pass Filter 1.5GHz	Micro LAB	LA-15N	2016-01-05	2017-01-05	N/A
<input checked="" type="checkbox"/>	Low Pass Filter 3.0GHz	Micro LAB	LA-30N	2016-09-08	2017-09-08	N/A
<input checked="" type="checkbox"/>	Low Pass Filter 6.0GHz	Micro LAB	LA-60N	2016-02-24	2017-02-24	03942
<input checked="" type="checkbox"/>	Attenuators(3 dB)	Agilent	8491B	2016-06-22	2017-06-22	MY39260700
<input checked="" type="checkbox"/>	Attenuators(10 dB)	WEINSCHHEL	23-10-34	2016-01-05 2017-01-04	2017-01-05 2018-01-04	BP4387
<input checked="" type="checkbox"/>	Dielectric Probe kit	SCHMID	DAK-3.5	2016-11-17	2017-11-17	1092
<input checked="" type="checkbox"/>	Dielectric Probe kit	SCHMID	DAK-3.5	2016-07-26	2017-07-26	1046
<input checked="" type="checkbox"/>	8960 Series 10 Wireless Comms. Test Set	Agilent	E5515C	2016-09-09	2017-09-09	GB43461134
<input checked="" type="checkbox"/>	Wideband Radio Communication Tester	Rohde Schwarz	CMW500	2016-09-09	2017-09-09	101414
<input checked="" type="checkbox"/>	Power Splitter	Anritsu	K241B	2016-02-24	2017-02-24	1301184
<input checked="" type="checkbox"/>	Bluetooth Tester	TESCOM	TC-3000B	2016-01-06	2017-01-06	3000B770243

NOTE: The E-field probe was calibrated by SPEAG, by temperature measurement procedure. Dipole Verification measurement is performed by DT&C before each test. The brain and muscle simulating material are calibrated by DT&C using the dielectric probe system and network analyzer to determine the conductivity and permittivity (dielectric constant) of the brain-equivalent material. Each equipment item was used solely within its respective calibration period.

4. TEST SYSTEM SPECIFICATIONS

Automated TEST SYSTEM SPECIFICATIONS:

Positioner

Robot	Stäubli Unimation Corp. Robot Model: TX90XL
Repeatability	0.02 mm
No. of axis	6

Data Acquisition Electronic (DAE) System

Cell Controller

Processor	Intel Core i7-3770
Clock Speed	3.40 GHz
Operating System	Windows 7 Professional
Data Card	DASY5 PC-Board

Data Converter

Features	Signal, multiplexer, A/D converter. & control logic
Software	DASY5
Connecting Lines	Optical downlink for data and status info Optical uplink for commands and clock

PC Interface Card

Function	24 bit (64 MHz) DSP for real time processing Link to DAE 4 16 bit A/D converter for surface detection system serial link to robot direct emergency stop output for robot
-----------------	--

E-Field Probes

Model	EX3DV4 S/N: 3933
Construction	Triangular core fiber optic detection system
Frequency	10 MHz to 6 GHz
Linearity	± 0.2 dB (30 MHz to 6 GHz)

Phantom

Phantom	SAM Twin Phantom (V5.0)
Shell Material	Composite
Thickness	2.0 ± 0.2 mm



Figure 4.1 DASY5 Test System

5. SAR MEASUREMENT PROCEDURE

5.1 Measurement Procedure

The evaluation was performed using the following procedure compliant to FCC KDB Publication 865664 D01v01r04 and IEEE 1528-2013:

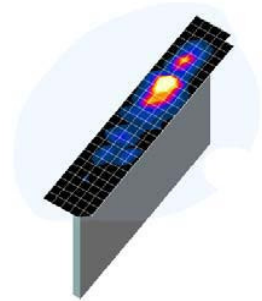

Figure 5.1
Sample SAR Area Scan

1. The SAR distribution at the exposed side of the head or body was measured at a distance no greater than 5.0 mm from the inner surface of the shell. The area covered the entire dimension of the device-head and body interface and the horizontal grid resolution was determined per FCC KDB Publication 865664 D01v01r04 (See Table 5-1) and IEEE1528-2013.
2. The point SAR measurement was taken at the maximum SAR region determined from Step 1 to enable the monitoring of SAR fluctuations/drifts during the 1g/10g cube evaluation. SAR at this fixed point was measured and used as a reference value.
3. Based on the area scan data, the peak of the region with maximum SAR was determined by spline interpolation. Around this point, a volume was assessed according to the measurement resolution and volume size requirements of FCC KDB Publication 865664 D01v01r04 (See Table 5-1) and IEEE 1528-2013. On the basis of this data set, the spatial peak SAR value was evaluated with the following procedure (see references or the DASY manual online for more details):
 - a. SAR values at the inner surface of the phantom are extrapolated from the measured values along the line away from the surface with spacing no greater than that in Table 3-1. The extrapolation was based on a least-squares algorithm. A polynomial of the fourth order was calculated through the points in the z-axis (normal to the phantom shell).
 - b. After the maximum interpolated values were calculated between the points in the cube, the SAR was averaged over the spatial volume (1g or 10g) using a 3D-Spline interpolation algorithm. The 3D-spline is composed of three one-dimensional splines with the “Not a knot” condition (in x, y, and z directions). The volume was then integrated with the trapezoidal algorithm. One thousand points (10 x 10 x 10) were obtained through interpolation, in order to calculate the averaged SAR.
 - c. All neighboring volumes were evaluated until no neighboring volume with a higher average value was found.
4. The SAR reference value, at the same location as step 2, was re-measured after the zoom scan was complete to calculate the SAR drift. If the drift deviated by more than 5%, the SAR test and drift measurements were repeated.

Frequency	Maximum Area Scan Resolution (mm) ($\Delta x_{area}, \Delta y_{area}$)	Maximum Zoom Scan Resolution (mm) ($\Delta x_{zoom}, \Delta y_{zoom}$)	Maximum Zoom Scan Spatial Resolution (mm)			Minimum Zoom Scan Volume (mm) (x,y,z)
			Uniform Grid	Graded Grid		
			$\Delta z_{zoom}(n)$	$\Delta z_{zoom}(1)^*$	$\Delta z_{zoom}(n>1)^*$	
≤ 2 GHz	≤ 15	≤ 8	≤ 5	≤ 4	$\leq 1.5 * \Delta z_{zoom}(n-1)$	≥ 30
2-3 GHz	≤ 12	≤ 5	≤ 5	≤ 4	$\leq 1.5 * \Delta z_{zoom}(n-1)$	≥ 30
3-4 GHz	≤ 12	≤ 5	≤ 4	≤ 3	$\leq 1.5 * \Delta z_{zoom}(n-1)$	≥ 28
4-5 GHz	≤ 10	≤ 4	≤ 3	≤ 2.5	$\leq 1.5 * \Delta z_{zoom}(n-1)$	≥ 25
5-6 GHz	≤ 10	≤ 4	≤ 2	≤ 2	$\leq 1.5 * \Delta z_{zoom}(n-1)$	≥ 22

Table 5.1 Area and Zoom Scan Resolutions per FCC KDB Publication 865664 D01v01r04

*Also compliant to IEEE 1528-2013 Table 6

6. DEFINITION OF REFERENCE POINTS

6.1 Ear Reference Point

Figure 6.1 shows the front, back and side views of the SAM Twin Phantom. The point “M” is the reference point for the center of the mouth, “LE” is the left ear reference point(ERP), and “RE” is the right ERP. The ERPs are 15mm posterior to the entrance to the Ear canal (EEC) along the B-M line (Back-Mouth), as shown in Figure 6.5. The plane Passing, through the two ear canals and M is defined as the Reference Plane. The line N-F (Neck- Front) is perpendicular to the reference plane and passing through the RE (or LE) is called the Reference Pivoting Line (see Figure 6.1). Line B-M is perpendicular to the N-F line. Both N-F and B-M lines are marked on the external phantom shell to facilitate handset positioning.

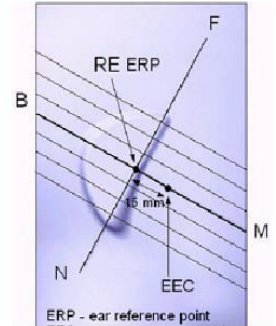

Figure 6.1
Close-up side view of ERP

6.2 Handset Reference Points

Two imaginary lines on the handset were established: the vertical centerline and the horizontal line. The test device was placed in a normal operating position with the “test device reference point” located along the “vertical centerline” on the front of the device aligned to the “ear reference point” (See Fig. 6.3). The “test device reference point” was then located at the same level as the center of the ear reference point. The test device was positioned so that the “vertical centerline” was bisecting the front surface of the handset at it’s top and bottom edges, positioning the “ear reference point” on the outer surface of the both the left and right head phantoms on the ear reference point.



Figure 6.2 Front, back and side view SAM Twin Phantom

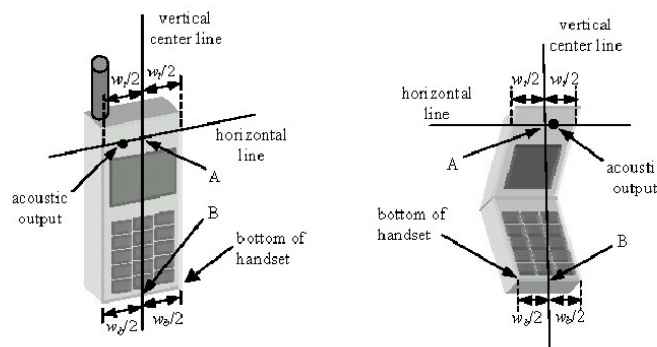

Figure 6.3 Handset Vertical Center & Horizontal Line Reference Points

7. TEST CONFIGURATION POSITIONS FOR HANDSETS

7.1 Device Holder

The device holder is made out of low-loss POM material having the following dielectric parameters: relative permittivity $\epsilon = 3$ and loss tangent $\delta = 0.02$.

7.2 Positioning for Cheek/Touch

1. The test device was positioned with the handset close to the surface of the phantom such that point A is on the (virtual) extension of the line passing through points RE and LE on the phantom (see Figure 7.1), such that the plane defined by the vertical center line and the horizontal line of the phone is approximately parallel to the sagittal plane of the phantom.

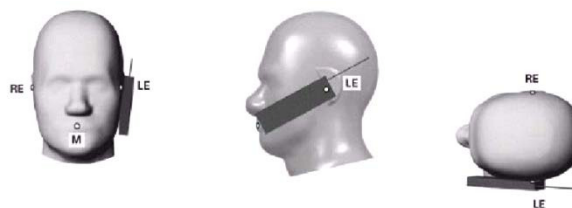

Figure 7.1 Front, Side and Top View of Cheek/Touch Position

2. The handset was translated towards the phantom along the line passing through RE & LE until the handset touches the ear.
3. While maintaining the handset in this plane, the handset was rotated around the LE-RE line until the vertical centerline was in the plane normal to MB-NF including the line MB (reference plane).
4. The phone was then rotated around the vertical centerline until the phone (horizontal line) was symmetrical with respect to the line NF.
5. While maintaining the vertical centerline in the reference plane, keeping point A on the line passing through RE and LE, and maintaining the phone contact with the ear, the handset was rotated about the line NF until any point on the handset made contact with a phantom point below the ear (cheek). (See Figure 7.2)

7.3 Positioning for Ear / 15 ° Tilt

With the test device aligned in the “Cheek/Touch Position”:

1. While maintaining the orientation of the phone, the phone was retracted parallel to the reference plane far enough to enable a rotation of the phone by 15degree.
2. The phone was then rotated around the horizontal line by 15 degree.
3. While maintaining the orientation of the phone, the phone was moved parallel to the reference plane until any part of the phone touches the head. (In this position, point A was located on the line RE-LE). The tilted position is obtained when the contact is on the pinna. If the contact was at any location other than the pinna, the angle of the phone would then be reduced. The tilted position was obtained when any part of the phone was in contact of the ear as well as a second part of the phone was in contact with the head (see Figure 7.3).

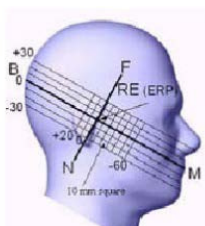

Figure 7.2 Side view w/relevant markings

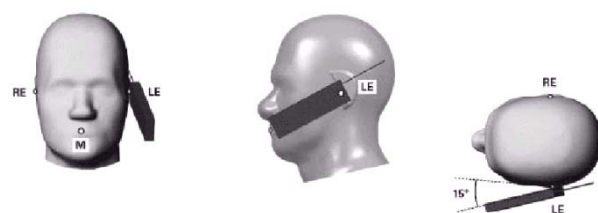

Figure 7.3 Front, Side and Top View of Ear/15°Position

7.4 Body-Worn Accessory Configurations

Body-worn operating configurations are tested with the belt-clips and holsters attached to the device and positioned against a flat phantom in a normal use configuration (see Figure 6.7). Per FCC KDB Publication 648474 D04v01r03, Body-worn accessory exposure is typically related to voice mode operations when handsets are carried in body-worn accessories. The body-worn accessory procedures in FCC KDB Publication 447498 D01v06 should be used to test for body-worn accessory SAR compliance, without a headset connected to it. This enables the test results for such configuration to be compatible with that required for hotspot mode when the body-worn accessory test separation distance is greater than or equal to that required for hotspot mode, when applicable. When the reported SAR for a body-worn accessory, measured without a headset connected to the handset, is > 1.2 W/kg, the highest reported SAR configuration for that wireless mode and frequency band should be repeated for that body-worn accessory with a headset attached to the handset.

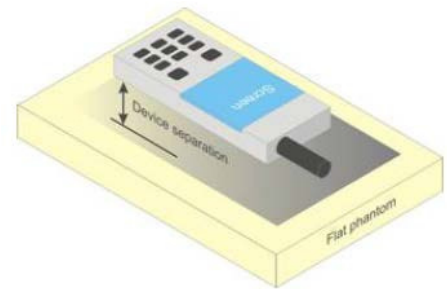

Figure 7.4 Sample Body-Worn Diagram

Accessories for Body-worn operation configurations are divided into two categories: those that do not contain metallic components and those that do contain metallic components. When multiple accessories that do not contain metallic components are supplied with the device, the device is tested with only the accessory that dictates the closest spacing to the body. Then multiple accessories that contain metallic components are tested with the device with each accessory. If multiple accessories share an identical metallic component (i.e. the same metallic belt-clip used with different holsters with no other metallic components) only the accessory that dictates the closest spacing to the body is tested.

Body-worn accessories may not always be supplied or available as options for some devices intended to be authorized for body-worn use. In this case, a test configuration with a separation distance between the back of the device and the flat phantom is used. Test position spacing was documented.

Transmitters that are designed to operate in front of a person's face, as in push-to-talk configurations, are tested for SAR compliance with the front of the device positioned to face the flat phantom in head fluid. For devices that are carried next to the body such as a shoulder, waist or chest-worn transmitters, SAR compliance is tested with the accessories, including headsets and microphones, attached to the device and positioned against a flat phantom in a normal use configuration.

7.5 Extremity Exposure Configurations

Devices that are designed or intended for use on extremities or mainly operated in extremity only exposure conditions; i.e., hands, wrists, feet and ankles, may require extremity SAR evaluation. When the device also operates in close proximity to the user's body, SAR compliance for the body is also required. The 1-g body and 10-g extremity SAR Exclusion Thresholds found in KDB Publication 447498D01v06 should be applied to determine SAR test requirements.

Per KDB Publication 447498 D01v06, Cell phones (handsets) are not normally designed to be used on extremities or operated in extremity only exposure conditions. The maximum output power levels of handsets generally do not require extremity SAR testing to show compliance. Therefore, extremity SAR was not evaluated for this device.

7.6 Wireless Router Configurations

Some battery-operated handsets have the capability to transmit and receive user data through simultaneous transmission of WIFI simultaneously with a separate licensed transmitter. The FCC has provided guidance in FCC KDB Publication 941225 D06v02r01 where SAR test considerations for handsets ($L \times W \geq 9 \text{ cm} \times 5 \text{ cm}$) are based on a composite test separation distance of 10 mm from the front, back and edges of the device containing transmitting antennas within 2.5 cm of their edges, determined from general mixed use conditions for this type of devices. Since the hotspot SAR results may overlap with the body-worn accessory SAR requirements, the more conservative configurations can be considered, thus excluding some body-worn accessory SAR tests.

When the user enables the personal wireless router functions for the handset, actual operations include simultaneous transmission of both the WIFI transmitter and another licensed transmitter. Both transmitters often do not transmit at the same transmitting frequency and thus cannot be evaluated for SAR under actual use conditions due to the limitations of the SAR assessment probes.

Therefore, SAR must be evaluated for each frequency transmission and mode separately and spatially summed with the WIFI transmitter according to FCC KDB Publication 447498 D01v06 publication procedures. The "Portable Hotspot" feature on the handset was NOT activated during SAR assessments, to ensure the SAR measurements were evaluated for a single transmission frequency RF signal at a time.

8. RF EXPOSURE LIMITS

Uncontrolled Environment:

UNCONTROLLED ENVIRONMENTS are defined as locations where there is the exposure of individuals who have no knowledge or control of their exposure. The general population/uncontrolled exposure limits are applicable to situations in which the general public may be exposed or in which persons who are exposed as a consequence of their employment may not be made fully aware of the potential for exposure or cannot exercise control over their exposure. Members of the general public would come under this category when exposure is not employment-related; for example, in the case of a wireless transmitter that exposes persons in its vicinity.

Controlled Environment:

CONTROLLED ENVIRONMENTS are defined as locations where there is exposure that may be incurred by persons who are aware of the potential for exposure, (i.e. as a result of employment or occupation). In general, occupational/controlled exposure limits are employment, who have been made fully aware of the potential for exposure and can exercise control over their exposure. This exposure category is also applicable when the exposure is of a transient nature due to incidental passage through a location where the exposure levels may be higher than the general population/uncontrolled limits, but the exposed person is fully aware of the potential for exposure and can exercise control over his or her exposure by leaving the area or by some other appropriate means.

Table 8.1.SAR Human Exposure Specified in ANSI/IEEE C95.1-2005

	HUMAN EXPOSURE LIMITS	
	General Public Exposure (W/kg) or (mW/g)	Occupational Exposure (W/kg) or (mW/g)
SPATIAL PEAK SAR * (Brain)	1.60	8.00
SPATIAL AVERAGE SAR ** (Whole Body)	0.08	0.40
SPATIAL PEAK SAR *** (Hands / Feet / Ankle / Wrist)	4.00	20.0

1. The Spatial Peak value of the SAR averaged over any 1 gram of tissue (defined as a tissue volume in the shape of a cube) and over the appropriate averaging time.
2. The Spatial Average value of the SAR averaged over the whole body.
3. The Spatial Peak value of the SAR averaged over any 10 grams of tissue (defined as a tissue volume in the shape of a cube) and over the appropriate averaging time.

Uncontrolled Environments are defined as locations where there is the exposure of individuals who have no knowledge or control of their exposure.

Controlled Environments are defined as locations where there is exposure that may be incurred by persons who are aware of the potential for exposure, (i.e.as a result of employment or occupation).

9. FCC MEASUREMENT PROCEDURES

Power measurements were performed using a base station simulator under digital average power.

9.1 Measured and Reported SAR

Per FCC KDB Publication 447498 D01v06, When SAR is not measured at the maximum power level allowed for production units, the results must be scaled to the maximum tune-up tolerance limit according to the power applied to the individual channels tested to determine compliance. For simultaneous transmission, the measured aggregate SAR must be scaled according to the sum of the differences between the maximum tune-up tolerance and actual power used to test each transmitter. When SAR is measured at or scaled to the maximum tune-up tolerance limit, the results are referred to as reported SAR. The highest reported SAR results are identified on the grant of equipment authorization according to procedures in KDB 690783 D01v01r03.

9.2 Procedures Used to Establish RF Signal for SAR

The following procedures are according to FCC KDB Publication 941225 D01v03r01.

The device was placed into a simulated call using a base station simulator in a RF shielded chamber. Establishing connections in this manner ensure a consistent means for testing SAR and are recommended for evaluating SAR [4]. Devices under test were evaluated prior to testing, with a fully charged battery and were configured to operate at maximum output power. In order to verify that the device was tested throughout the SAR test at maximum output power, the SAR measurement system measures a “point SAR” at an arbitrary reference point at the start and end of the 1 gram SAR evaluation, to assess for any power drifts during the evaluation. If the power drift deviated by more than 5%, the SAR test and drift measurements were repeated.

9.3 SAR Measurement Conditions for WCDMA (UMTS)

9.3.1 Output Power Verification

Maximum output power is measured on the High, Middle and Low channels for each applicable transmission band according to the general descriptions in section 5.2 of 3GPP TS 34.121, using the appropriate RMC or AMR with TPC (transmit power control) set to all “1s”.

Maximum output power is verified on the High, Middle and Low channels according to the general, descriptions in section 5.2 of 3GPP TS 34.121 (release 5), using the appropriate RMC with TPC,(transmit power control) set to all “1s” or applying the required inner loop power control procedures to maintain maximum output power while HSUPA is active. Results for all applicable physical channel configurations (DPCCH, DPDCHn and spreading codes, HS-DPCCH etc) are tabulated in this test report. All configurations that are not supported by the DUT or cannot be measured due to technical or equipment limitations are identified.

9.3.2 Head SAR Measurements for Handsets

SAR for head exposure configurations is measured using the 12.2 kbps RMC with TPC bits configured to all “1s”. SAR in AMR configurations is not required when the maximum average output of each RF channel for 12.2 kbps AMR is less than 0.25 dB higher than that measured in 12.2 kbps RMC. Otherwise, SAR is measured on the maximum output channel in 12.2 AMR with a 3.4 kbps SRB (signaling radio bearer) using the exposure configuration that resulted in the highest SAR for that RF channel in the 12.2 kbps RMC mode.

9.3.3 Body SAR Measurements

SAR for body exposure configurations is measured using the 12.2 kbps RMC with the TPC bits all "1s".

9.3.4 Release 5 HSDPA Data Devices

The following procedures are applicable to HSDPA data devices operating under 3GPP Release 5. SAR is required for devices in body-worn accessory and other body exposure conditions, including handsets and data modems operating in various electronic devices. HSDPA operates in conjunction with WCDMA and requires an active DPCCH. The default test configuration is to measure SAR in WCDMA with HSDPA remain inactive, to establish a radio link between the test device and a communication test set using a 12.2 kbps RMC configured in Test Loop Mode 1. SAR for HSDPA is selectively measured using the highest reported SAR configuration in WCDMA, with an FRC in H-set 1 and a 12.2 kbps RMC. SAR is selectively confirmed for other physical channel configurations (DPCCH & DPDCHn) according to exposure conditions, device operating capabilities and maximum output power specified for production units, including tune-up tolerance by applying the 3G SAR test reduction procedures. Maximum output power is verified according to the applicable versions of 3GPP TS 34.121. SAR must be measured based on these maximum output conditions and requirements in KDB Publication 447498, with respect to the UE Categories, and explained in the SAR report. When Maximum Power Reduction (MPR) applies, the implementations must be clearly identified in the SAR report to support test results according to Cubic Metric (CM) and, as appropriate, Enhanced MPR (E-MPR) requirements.

Sub-test	β_c	β_a	β_a (SF)	β_c/β_a	$\beta_{hs}^{(1)}$	CM (dB) ⁽²⁾
1	2/15	15/15	64	2/15	4/15	0.0
2	12/15 ⁽³⁾	15/15 ⁽³⁾	64	12/15 ⁽³⁾	24/15	1.0
3	15/15	8/15	64	15/8	30/15	1.5
4	15/15	4/15	64	15/4	30/15	1.5

Note 1: Δ_{ACK} , Δ_{NACK} and $\Delta_{CQI} = 8 \Leftrightarrow A_{hs} = \beta_{hs}/\beta_c = 30/15 \Leftrightarrow \beta_{hs} = 30/15 * \beta_c$
 Note 2: CM = 1 for $\beta_c/\beta_a = 12/15$, $\beta_{hs}/\beta_c = 24/15$.
 Note 3: For subtest 2 the β_c/β_a ratio of 12/15 for the TFC during the measurement period (TF1, TF0) is achieved by setting the signaled gain factors for the reference TFC (TF1, TF1) to $\beta_c = 11/15$ and $\beta_a = 15/15$.

Figure 9.1 Table 1

9.3.5 Release 6 HSUPA Data Devices

The following procedures are applicable to HSPA (HSUPA/HSDPA) data devices operating under 3GPP Release 6. SAR is required for devices in body-worn accessory and other body exposure conditions, including handsets and data modems operating in various electronic devices. HSUPA operates in conjunction with WCDMA and HSDPA. SAR is initially measured in WCDMA test configurations with HSPA remain inactive. The default test configuration is to establish a radio link between the test device and a communication test set to configure a 12.2 kbps RMC in Test Loop Mode 1. SAR for HSPA is selectively measured with HS-DPCCH, E-DPCCH and E-DPDCH, all enabled, along with a 12.2 kbps RMC using the highest reported SAR configuration in WCDMA with 12.2 kbps RMC only.

An FRC is configured according to HS-DPCCH Sub-test 1 using H-set 1 and QPSK. HSPA is configured according to E-DCH Sub-test 5 requirements. SAR for other HSPA sub-test configurations is confirmed selectively according to exposure conditions, E-DCH UE Category and maximum output power of production units, including tune-up tolerance by applying the 3G SAR test reduction procedure. Maximum output power is verified according to procedures in applicable versions of 3GPP TS 34.121. SAR must be measured based on these maximum output conditions and requirements in KDB Publication 447498, with respect to the UE Categories for HS-DPCCH and HSPA, and explained in the SAR report. When Maximum Power Reduction (MPR) applies, the implementations must be clearly identified in the SAR report to support test results according to Cubic Metric (CM) and, as appropriate, Enhanced MPR (E-MPR) requirements.

Sub-test	β_c	β_d	β_d (SF)	β_e/β_d	$\beta_{hs}^{(1)}$	β_{ec}	β_{ed}	β_{ed} (SF)	β_{ed} (codes)	CM ⁽²⁾ (dB)	MPR (dB)	AG ⁽⁴⁾ Index	E-TFCI
1	11/15 ⁽³⁾	15/15 ⁽³⁾	64	11/15 ⁽³⁾	22/15	209/225	1039/225	4	1	1.0	0.0	20	75
2	6/15	15/15	64	6/15	12/15	12/15	94/75	4	1	3.0	2.0	12	67
3	15/15	9/15	64	15/9	30/15	30/15	$\beta_{ed}: 47/15$ $\beta_{ed}: 47/15$	4	2	2.0	1.0	15	92
4	2/15	15/15	64	2/15	4/15	2/15	56/75	4	1	3.0	2.0	17	71
5	15/15 ⁽⁴⁾	15/15 ⁽⁴⁾	64	15/15 ⁽⁴⁾	30/15	24/15	134/15	4	1	1.0	0.0	21	81

Note 1: Δ_{ACK} , Δ_{NACK} and $\Delta_{CQI} = 8 \Leftrightarrow A_{hs} = \beta_{hs}/\beta_c = 30/15 \Leftrightarrow \beta_{hs} = 30/15 * \beta_c$.
 Note 2: CM = 1 for $\beta_e/\beta_d = 12/15$, $\beta_{hs}/\beta_c = 24/15$. For all other combinations of DPDCH, DPCCCH, HS-DPCCH, E-DPDCH and E-DPCCH the MPR is based on the relative CM difference.
 Note 3: For subtest 1 the β_e/β_d ratio of 11/15 for the TFC during the measurement period (TF1, TF0) is achieved by setting the signaled gain factors for the reference TFC (TF1, TF1) to $\beta_c = 10/15$ and $\beta_d = 15/15$.
 Note 4: For subtest 5 the β_e/β_d ratio of 15/15 for the TFC during the measurement period (TF1, TF0) is achieved by setting the signaled gain factors for the reference TFC (TF1, TF1) to $\beta_c = 14/15$ and $\beta_d = 15/15$.
 Note 5: Testing UE using E-DPDCH Physical Layer category 1 Sub-test 3 is not required according to TS 25.306 Table 5.1g.
 Note 6: β_{ed} cannot be set directly; it is set by Absolute Grant Value.

Figure 9.2 Table 2

9.4 SAR Measurement Conditions for LTE

LTE modes were tested according to FCC KDB 941225 D05v02r05 publication. Please see notes after the tabulated SAR data for required test configurations. Establishing connections with base station simulators ensure a consistent means for testing SAR and are recommended for evaluating SAR. The R&S CMW500 was used for LTE output power measurement and SAR testing. Closed loop power control was used so the UE transmits with maximum output power during SAR testing. SAR tests were performed with the same number of RB and RB offsets transmitting on all TTI frames (maximum TTI).

9.4.1 Spectrum Plots for RB Configurations

A properly configured base station simulator was used for SAR tests and power measurements. Therefore, spectrum plots for RB configurations were not required to be included in this report.

9.4.2 MPR

MPR is permanently implemented for this device by the manufacturer. The specific manufacturer target MPR is indicated alongside the SAR results. MPR is enabled for this device, according to 3GPP TS36. 101 Section 6.2.3 – 6.2.5 under Table 6.2.3-1.

9.4.3 Required RB Size and RB Offsets for SAR Testing

According to FCC KDB 941225 D05v02r05:

- a. Per Section 4.2.1, SAR is required for QPSK 1 RB Allocation for the largest bandwidth
 - i. The required channel and offset combination with the highest maximum output power is required for SAR.
 - ii. When the reported SAR is ≤ 0.8 W/kg, testing of the remaining RB offset configurations and required test channel is not required. Otherwise, SAR is required for the remaining required test channels using the RB offset configuration with highest output power for that channel.
 - iii. When the reported SAR for a required test channel is > 1.45 W/kg, SAR is required for all RB offset configurations for that channel.
- b. Per Section 4.2.2, SAR is required for 50% RB allocation using the largest bandwidth following the same procedures outlined in Section 4.2.1.
- c. Per Section 4.2.3, QPSK SAR is not required for the 100% allocation when the highest maximum output power for the 100% allocation is less than the highest maximum output power of the 1 RB and 50% RB allocations and the reported SAR for the 1 RB and 50% RB allocations is < 0.8 W/kg.
- d. Per Section 4.2.4 and 4.3, SAR tests for higher order modulations and lower bandwidths configurations are not required when the conducted power of the required test configurations determined by Sections 4.2.1 through 4.2.3 is less than or equal to 0.5 dB higher than the equivalent configuration using QPSK modulation and when the QPSK SAR for those configurations is < 1.45 W/kg.

9.5 SAR Testing with 802.11 Transmitters

Normal network operating configurations are not suitable for measuring the SAR of 802.11 b/g/n transmitters. Unpredictable fluctuations in network traffic and antenna diversity conditions can introduce undesirable variations in SAR results. The SAR for these devices should be measured using chipset based test mode software to ensure the results are consistent and reliable. See KDB Publication 248227D01v02r02 for more details.

9.5.1 General Device Setup

Chipset based test mode software is hardware dependent and generally varies among manufacturers. The device operating parameters established in test mode for SAR measurements must be identical to those programmed in production units, including output power levels, amplifier gain settings and other RF performance tuning parameters. The test frequencies should correspond to actual channel frequencies defined for domestic use. SAR for devices with switched diversity should be measured with only one antenna transmitting at a time during each SAR measurement, according to a fixed modulation and data rate. The same data pattern should be used for all measurements.

9.5.2 U-NII and U-NII-2A

For devices that operate in only one of the U-NII-1 and U-NII-2A bands, the normally required SAR procedures for OFDM configurations are applied. For devices that operate in both U-NII bands using the same transmitter and antenna(s), SAR test reduction is determined according to the following, with respect to the highest reported SAR and maximum output power specified for production units. The procedures are applied independently to each exposure configuration; for example, head, body, hotspot mode etc.

- 1) When the same maximum output power is specified for both bands, begin SAR measurement in U-NII-2A band by applying the OFDM SAR requirements. If the highest reported SAR for a test configuration is ≤ 1.2 W/kg, SAR is not required for U-NII-1 band for that configuration (802.11 mode and exposure condition); otherwise, each band is tested independently for SAR.
- 2) When different maximum output power is specified for the bands, begin SAR measurement in the band with higher specified maximum output power. The highest reported SAR for the tested configuration is adjusted by the ratio of lower to higher specified maximum output power for the two bands. When the adjusted SAR is ≤ 1.2 W/kg, SAR is not required for the band with lower maximum output power in that test configuration; otherwise, each band is tested independently for SAR.

9.5.3 U-NII-2C and U-NII-3

The frequency range covered by U-NII-2C and U-NII-3 is 380 MHz (5.47 – 5.85 GHz), which requires a minimum of at least two SAR probe calibration frequency points to support SAR measurements.

When Terminal Doppler Weather Rader (TDWR) restriction applies, the channels at 5.60 – 5.65 GHz in U-NII-2C band must be disabled with acceptable mechanisms and documented in the equipment certification.

Unless band gap channels are permanently disabled, SAR must be considered for these channels. When band gap channels are disabled, each band is tested independently according to the normally required OFDM SAR measurements and probe calibration frequency points requirements.

9.5.4 Initial Test Position Procedure

For exposure conditions with multiple test positions, such as handset operating next to the ear, devices with hotspot mode or UMPC mini-tablet, procedures for initial test position can be applied. Using the transmission mode determined by the DSSS procedure or initial test configuration, area scans are measured for all position in an exposure condition. The test position with the highest extrapolated (peak) SAR is used as the initial test position. When reported SAR for the initial test position is ≤ 0.4 W/kg, no additional testing for the remaining test positions is required. Otherwise, SAR is evaluated at the subsequent highest peak SAR position until the reported SAR result is ≤ 0.8 W/kg or all test position are measured.

9.5.5.2.4 GHz SAR Test Requirements

SAR is measured for 2.4 GHz 802.11b DSSS using either a fixed test position or, when applicable, the initial test position procedure. SAR test reduction is determined according to the following:

- 1) When the reported SAR of the highest measured maximum output power channel for the exposure configuration is ≤ 0.8 W/kg, no further SAR testing is required for 802.11b DSSS in that exposure configuration.
- 2) When the reported SAR is > 0.8 W/kg, SAR is required for that exposure configuration using the next highest measured output power channel. When any reported SAR is > 1.2 W/kg, SAR is required for the third channel; i.e., all channels require testing.

2.4 GHz 802.11 g/n OFDM are additionally evaluated for SAR if the highest reported SAR for 802.11b, adjusted by the ratio of the OFDM to DSSS specified maximum output power is > 1.2 W/kg. When SAR is required for OFDM modes in 2.4 GHz band, the Initial Test Configuration Procedures should be followed.

9.5.6 OFDM Transmission Mode and SAR Test Channel Selection

For the 2.4 GHz and 5 GHz bands, when the same maximum output power was specified for multiple OFDM transmission mode configurations in a frequency band or aggregated band, SAR is measured using the configuration with the largest channel bandwidth, lowest order modulation and lowest data rate. When the maximum output power of a channel is the same for equivalent OFDM configurations; for example, 802.11a and 802.11n or 802.11g and 802.11n with the same channel bandwidth, modulation and data rate etc., the lower order 802.11 mode i.e., 802.11a, then 802.11g then 802.11n is used for SAR measurement. When the maximum output power were the same for multiple test channels, either according to the default or additional power measurement requirements, SAR is measured using the channel closest to the middle of the frequency band or aggregated band. When there are multiple channels with the same maximum output power, SAR is measured using the higher number channel.

9.5.7 Initial Test Configuration Procedure

For OFDM, in both 2.4 and 5 GHz bands, an initial test configuration is determined for each frequency band and aggregated band, according to the transmission mode with the highest maximum output power specified for SAR measurements. When the same maximum output is specified for multiple OFDM transmission mode configurations in a frequency band or aggregated band, SAR is measured using the configuration(s) with the largest channel bandwidth, lowest order modulation, and lowest data rate. The channel of the transmission mode with the highest average RF output conducted power will be the initial test configuration.

When the reported SAR ≤ 0.8 W/kg, no additional measurements on other test channels are required.

Otherwise, SAR is evaluated using the subsequent highest average RF output channel until the reported SAR result is ≤ 1.2 W/kg or all channels are measured.

9.5.8 Subsequent Test Configuration Procedures

For OFDM configurations, in each frequency band and aggregated band, SAR is evaluated for initial test configuration using the fixed test position or the initial test position procedure, when applicable. When the highest reported SAR for the initial test configuration, adjusted by the ratio of the subsequent test configuration to initial test configuration specified maximum output power is ≤ 1.2 W/kg, no additional SAR testing for the subsequent test configurations is required.

10. RF CONDUCTED POWERS

10.1 GSM Conducted Powers

Band	Channel	Maximum Burst-Averaged Output Power(dBm)				
		Voice	GPRS Data (GMSK)			
		GSM CS 1 Slot	GPRS 1 TX Slot	GPRS 2 TX Slot	GPRS 3 TX Slot	GPRS 4 TX Slot
GSM850	128	32.33	32.33	30.71	28.69	27.35
	190	32.54	32.52	30.88	28.69	27.43
	251	32.63	32.65	30.85	28.62	27.29
PCS 1900	512	28.87	28.87	27.84	25.79	23.89
	661	29.18	29.21	27.74	25.97	23.80
	810	29.03	29.04	27.81	25.84	23.57
Band	Channel	Calculated Maximum Frame-Averaged Output Power(dBm)				
		Voice	GPRS Data (GMSK)			
		GSM CS 1 Slot	GPRS 1 TX Slot	GPRS 2 TX Slot	GPRS 3 TX Slot	GPRS 4 TX Slot
GSM850	128	23.30	23.30	24.69	24.43	24.34
	190	23.51	23.49	24.86	24.43	24.42
	251	23.60	23.62	24.83	24.36	24.28
PCS 1900	512	19.84	19.84	21.82	21.53	20.88
	661	20.15	20.18	21.72	21.71	20.79
	810	20.00	20.01	21.79	21.58	20.56
GSM850	Frame Avg. Targets:	22.97	22.97	23.98	23.74	23.49
PCS 1900		19.47	19.47	20.98	20.74	19.99

Table 10.1 The power was measured by E5515C

Note:

- Both burst-averaged and calculated frame-averaged powers are included. Frame-averaged power was calculated from the measured burst-averaged power by converting the slot powers into linear units and calculating the energy over 8 timeslots.
- GPRS (GMSK) output powers were measured with coding scheme setting of 1 (CS1) on the base station simulator. CS1 was configured to measure GPRS output power measurements and SAR to ensure GMSK modulation in the signal. Our Investigation has shown that CS1 - CS4 settings do not have any impact on the output levels or modulation in the GPRS modes.

GPRS Multislot class: 33 (max 4 TX Uplink slots)
 EDGE Multislot class: N/A
 DTM Multislot Class: N/A



Figure 10.1 Power Measurement Setup

10.2 WCDMA Conducted Powers

3GPP Release Version	Mode	3GPP 34.121 Subtest	Cellular Band (dBm)			3GPP MPR (dB)
			4132	4183	4233	
99	WCDMA	12.2 kbps RMC	23.42	23.35	23.25	-
99		12.2 kbps AMR	23.40	23.28	23.25	-
5	HSDPA	Subtest 1	22.18	22.05	21.96	0
5		Subtest 2	22.16	22.07	21.97	0
5		Subtest 3	21.66	21.59	21.49	0.5
5		Subtest 4	21.68	21.66	21.47	0.5
6	HSUPA	Subtest 1	21.39	21.76	21.54	0
6		Subtest 2	21.04	20.99	20.76	2
6		Subtest 3	20.94	21.03	20.97	1
6		Subtest 4	20.62	20.92	20.68	2
6		Subtest 5	22.41	22.25	22.21	0

Table 10.2 The power was measured by E5515C

WCDMA SAR was tested under RMC 12.2 kbps with HSPA Inactive per KDB Publication 941225 D01v03r01. HSPA SAR was not required since the average output power of the HSPA subtests was not more than 0.25 dB higher than the RMC level and SAR was less than 1.2 W/kg.

The manufacturer declares that the HSUPA transmitter's power will not exceed the R99 maximum transmit power in devices based on Qualcomm's HSPA chipset solutions.



Figure 10.2 Power Measurement Setup

10.3 LTE Conducted Powers

1) LTE Band 17

Mode	Freq. (MHz)	Channel	LTE Band 17 Conducted Power– 10 MHz Bandwidth						
			Bandwidth (MHz)	Modulation	RB Size	RB Offset	Conducted Power(dBm)	MPR Allowed Per 3GPP(dB)	MPR (dB)
Mid	710	23790	10	QPSK	1	0	23.84	0	0
	710	23790	10	QPSK	1	25	23.68	0	0
	710	23790	10	QPSK	1	49	23.50	0	0
	710	23790	10	QPSK	25	0	22.68	0-1	1
	710	23790	10	QPSK	25	12	22.64	0-1	1
	710	23790	10	QPSK	25	25	22.67	0-1	1
	710	23790	10	QPSK	50	0	22.57	0-1	1
	710	23790	10	16QAM	1	0	22.83	0-1	1
	710	23790	10	16QAM	1	25	22.93	0-1	1
	710	23790	10	16QAM	1	49	22.96	0-1	1
	710	23790	10	16QAM	25	0	21.65	0-2	2
	710	23790	10	16QAM	25	12	21.63	0-2	2
	710	23790	10	16QAM	25	25	21.52	0-2	2
	710	23790	10	16QAM	50	0	21.61	0-2	2

Table 10.3.1 The power was measured by CMW500

Mode	Freq. (MHz)	Channel	LTE Band 17 Conducted Power– 5 MHz Bandwidth						
			Bandwidth (MHz)	Modulation	RB Size	RB Offset	Conducted Power(dBm)	MPRAllowed Per 3GPP(dB)	MPR (dB)
Mid	710	23790	5	QPSK	1	0	23.57	0	0
	710	23790	5	QPSK	1	12	23.62	0	0
	710	23790	5	QPSK	1	24	23.46	0	0
	710	23790	5	QPSK	12	0	22.60	0-1	1
	710	23790	5	QPSK	12	6	22.59	0-1	1
	710	23790	5	QPSK	12	13	22.63	0-1	1
	710	23790	5	QPSK	25	0	22.58	0-1	1
	710	23790	5	16QAM	1	0	22.74	0-1	1
	710	23790	5	16QAM	1	12	22.57	0-1	1
	710	23790	5	16QAM	1	24	22.51	0-1	1
	710	23790	5	16QAM	12	0	21.60	0-2	2
	710	23790	5	16QAM	12	6	21.52	0-2	2
	710	23790	5	16QAM	12	13	21.63	0-2	2
	710	23790	5	16QAM	25	0	21.62	0-2	2

Table 10.3.2 The power was measured by CMW500

10.4 WLAN Conducted Powers

Mode	Freq. (MHz)	Channel	802.11b (2.4 GHz) Conducted Power (dBm)			
			Data Rate (Mbps)			
			1	2	5.5	11
802.11b	2412	1	15.39	15.33	15.25	15.31
	2437	6	<u>16.25</u>	16.15	16.11	16.18
	2462	11	15.81	15.77	15.71	15.75

Table 10.4.1 IEEE 802.11b Average RF Power

Mode	Freq. (MHz)	Channel	802.11g (2.4 GHz) Conducted Power (dBm)							
			Data Rate (Mbps)							
			6	9	12	18	24	36	48	54
802.11g	2412	1	11.91	11.88	11.82	11.79	11.83	11.85	11.79	11.81
	2437	6	12.18	12.11	12.15	12.10	12.08	12.13	12.11	12.11
	2462	11	11.81	11.77	11.78	11.71	11.75	11.69	11.65	11.68

Table 10.4.2 IEEE 802.11g Average RF Power

Mode	Freq. (MHz)	Channel	802.11n HT20 (2.4 GHz) Conducted Power (dBm)							
			Data Rate (Mbps)							
			MCS0	MCS1	MCS2	MCS3	MCS4	MCS5	MCS6	MCS7
802.11n (HT-20)	2412	1	11.72	11.66	11.58	11.61	11.55	11.53	11.55	11.61
	2437	6	11.97	11.94	11.91	11.85	11.94	11.82	11.77	11.82
	2462	11	11.88	11.81	11.78	11.85	11.74	11.82	11.77	11.83

Table 10.4.3 IEEE 802.11n HT20 Average RF Power

Mode	Freq.	Channel	802.11a (5 GHz) Conducted Power (dBm)							
			Data Rate (Mbps)							
	(MHz)	6	9	12	18	24	36	48	54	
802.11a	5180	36	12.55	12.51	12.49	12.42	12.54	12.50	12.52	12.36
	5200	40	12.44	12.32	12.35	12.32	12.40	12.32	12.35	12.20
	5220	44	12.45	12.22	12.43	12.29	12.38	12.33	12.24	12.26
	5240	48	12.48	12.46	12.42	12.35	12.28	12.29	12.25	12.28
	5260	52	14.36	14.29	14.22	14.16	14.23	14.28	14.27	14.19
	5280	56	<u>14.93</u>	14.80	14.68	14.76	14.88	14.81	14.85	14.86
	5300	60	14.32	14.31	14.09	14.21	14.16	14.25	14.22	14.25
	5320	64	14.35	14.21	14.17	14.15	14.16	14.24	14.27	14.27
	5500	100	12.82	12.80	12.69	12.66	12.64	12.63	12.81	12.71
	5580	116	<u>14.67</u>	14.43	14.62	14.53	14.51	14.58	14.59	14.56
	5660	132	14.53	14.38	14.30	14.46	14.32	14.47	14.47	14.44
	5700	140	12.85	12.81	12.77	12.82	12.79	12.72	12.77	12.79

Table 10.4.4 IEEE 802.11a Average RF Power

Mode	Freq.	Channel	802.11n HT20 (5 GHz) Conducted Power (dBm)							
			Data Rate (Mbps)							
	(MHz)	MCS0	MCS1	MCS2	MCS3	MCS4	MCS5	MCS6	MCS7	
802.11n (HT-20)	5180	36	12.51	12.37	12.48	12.37	12.50	12.31	12.47	12.44
	5200	40	12.43	12.34	12.33	12.21	12.22	12.34	12.29	12.36
	5220	44	12.44	12.38	12.26	12.24	12.32	12.21	12.41	12.31
	5240	48	12.46	12.30	12.45	12.22	12.33	12.34	12.35	12.30
	5260	52	14.33	14.25	14.27	14.24	14.23	14.27	14.26	14.31
	5280	56	14.68	14.49	14.48	14.54	14.61	14.56	14.60	14.51
	5300	60	14.28	14.08	14.20	14.25	14.18	14.14	14.15	14.12
	5320	64	14.41	14.22	14.33	14.38	14.28	14.28	14.31	14.31
	5500	100	12.81	12.69	12.67	12.65	12.76	12.57	12.70	12.74
	5580	116	14.65	14.59	14.42	14.46	14.53	14.42	14.61	14.58
	5660	132	14.58	14.54	14.54	14.36	14.57	14.51	14.44	14.38
	5700	140	12.85	12.81	12.77	12.71	12.74	12.79	12.81	12.76

Table 10.4.5 IEEE 802.11n HT20 Average RF Power

Mode	Freq.	Channel	802.11n HT40 (5 GHz) Conducted Power (dBm)							
			Data Rate (Mbps)							
	(MHz)		MCS0	MCS1	MCS2	MCS3	MCS4	MCS5	MCS6	MCS7
802.11n (HT-40)	5190	38	12.63	12.61	12.54	12.61	12.48	12.41	12.58	12.43
	5230	46	12.55	12.41	12.45	12.48	12.54	12.39	12.47	12.38
	5270	54	12.93	12.88	12.71	12.71	12.85	12.88	12.75	12.78
	5310	62	12.81	12.59	12.79	12.60	12.65	12.65	12.79	12.61
	5510	102	12.45	12.35	12.39	12.26	12.42	12.38	12.32	12.37
	5550	110	12.55	12.35	12.53	12.48	12.50	12.39	12.34	12.43
	5670	134	12.61	12.49	12.59	12.41	12.39	12.48	12.54	12.45

Table 10.4.6 IEEE 802.11n HT40 Average RF Power

Mode	Freq.	Channel	802.11ac VHT20 (5 GHz) Conducted Power (dBm)									
			Data Rate (Mbps)									
	(MHz)		MCS0	MCS1	MCS2	MCS3	MCS4	MCS5	MCS6	MCS7	MCS8	MCS9
802.11ac (VHT-20)	5180	36	12.88	12.78	12.64	12.78	12.72	12.78	12.70	12.81	12.69	12.67
	5200	40	12.82	12.68	12.76	12.77	12.80	12.71	12.80	12.80	12.71	12.66
	5220	44	12.69	12.60	12.60	12.61	12.48	12.45	12.52	12.68	12.61	12.58
	5240	48	12.54	12.44	12.31	12.52	12.35	12.52	12.49	12.34	12.34	12.44
	5260	52	14.66	14.48	14.48	14.54	14.43	14.47	14.47	14.56	14.43	14.41
	5280	56	14.61	14.47	14.44	14.53	14.48	14.56	14.46	14.55	14.51	14.42
	5300	60	14.58	14.41	14.49	14.51	14.51	14.39	14.52	14.51	14.46	14.48
	5320	64	14.64	14.55	14.56	14.46	14.44	14.52	14.55	14.57	14.52	14.46
	5500	100	12.31	12.16	12.24	12.26	12.18	12.12	12.20	12.15	12.13	12.28
	5580	116	14.55	14.31	14.41	14.42	14.33	14.51	14.36	14.38	14.46	14.44
	5660	132	14.45	14.25	14.21	14.33	14.25	14.37	14.39	14.33	14.23	14.21
	5700	140	12.61	12.55	12.51	12.48	12.53	12.55	12.49	12.53	12.55	12.53

Table 10.4.7 IEEE 802.11ac VHT20 Average RF Power

Mode	Freq.	Channel	802.11ac VHT40 (5 GHz) Conducted Power (dBm)									
			Data Rate (Mbps)									
	(MHz)	MCS0	MCS1	MCS2	MCS3	MCS4	MCS5	MCS6	MCS7	MCS8	MCS9	
802.11ac (VHT-40)	5190	38	12.49	12.40	12.29	12.39	12.47	12.34	12.36	12.26	12.31	12.41
	5230	46	12.55	12.54	12.34	12.46	12.33	12.31	12.32	12.32	12.35	12.38
	5270	54	12.61	12.58	12.50	12.40	12.44	12.41	12.59	12.38	12.52	12.59
	5310	62	12.54	12.31	12.47	12.30	12.51	12.37	12.51	12.42	12.45	12.49
	5510	102	12.41	12.25	12.28	12.21	12.22	12.35	12.24	12.34	12.29	12.34
	5550	110	12.44	12.27	12.32	12.40	12.38	12.23	12.27	12.38	12.42	12.22
	5670	134	12.56	12.39	12.41	12.43	12.33	12.45	12.37	12.36	12.47	12.41

Table 10.4.8 IEEE 802.11ac VHT40 Average RF Power

Mode	Freq.	Channel	802.11ac VHT80 (5 GHz) Conducted Power (dBm)									
			Data Rate (Mbps)									
	(MHz)	MCS0	MCS1	MCS2	MCS3	MCS4	MCS5	MCS6	MCS7	MCS8	MCS9	
802.11ac (VHT-80)	5210	42	12.07	11.93	12.06	11.99	11.86	11.88	11.85	11.88	11.93	11.91
	5290	58	12.05	11.85	12.02	11.92	11.81	11.85	11.97	11.98	11.87	11.86
	5530	106	11.69	11.68	11.51	11.62	11.67	11.54	11.61	11.60	11.58	11.63
	5690	138	11.71	11.48	11.50	11.52	11.47	11.62	11.66	11.62	11.64	11.57

Table 10.4.9 IEEE 802.11ac VHT80 Average RF Power

Justification for reduced test configurations for WIFI channels per KDB Publication 248227 D01v02r02 and October 2012 / April 2013 FCC/TCB Meeting Notes:

- Power measurements were performed for the transmission mode configuration with the highest maximum output power specified for production units.
- For transmission modes with the same maximum output power specification, powers were measured for the largest channel bandwidth, lowest order modulation and lowest data rate.
- For transmission modes with identical maximum specified output power, channel bandwidth, modulation and data rates, power measurements were required for all identical configurations.
- For each transmission mode configuration, powers were measured for the highest and lowest channels; and at the mid-band channel(s) when there were at least 3 channels supported. For configurations with multiple mid-band channels, duo to an even number of channels, both channels were measured.
- Output Power and SAR is not required for 802.11 g/n HT20 channels when the highest reported SAR for DSSS is adjusted by the ratio of OFDM to DSSS specified maximum output power and the adjust SAR is ≤ 1.2 W/kg.
- The underlined data rate and channel above were tested for SAR.

The average output powers of this device were tested by below configuration.

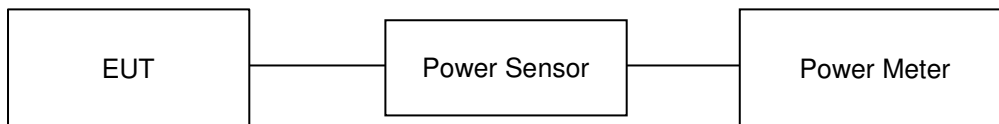

Figure 10.3 Power Measurement Setup

10.5 Bluetooth Conducted Powers

Channel	Frequency	Frame AVG Output Power (1Mbps)		Frame AVG Output Power (2Mbps)		Frame AVG Output Power (3Mbps)	
	(MHz)	(dBm)	(mW)	(dBm)	(mW)	(dBm)	(mW)
Low	2402	6.84	4.83	4.89	3.08	4.91	3.10
Mid	2441	6.15	4.12	4.17	2.61	4.22	2.64
High	2480	6.33	4.30	4.35	2.72	4.37	2.74

Table 10.5.1 Bluetooth Frame Average RF Power

Channel	Frequency	Frame AVG Output Power (LE)	
	(MHz)	(dBm)	(mW)
Low	2402	2.25	1.68
Mid	2440	2.12	1.63
High	2480	2.18	1.65

Table 10.5.2 Bluetooth LE Frame Average RF Power

● **Bluetooth Conducted Powers procedures**

1. Bluetooth (BDR, EDR)

1) Enter DUT mode in EUT and operate it.

When it operating, The EUT is transmitting at maximum power level and duty cycle fixed.

2) Instruments and EUT were connected like Figure 10.4(A).

3) The maximum output powers of BDR(1 Mbps), EDR(2, 3 Mbps) and each frequency were set by a Bluetooth Tester.

4) Power levels were measured by a Power Meter.

2. Bluetooth (LE)

1) Enter LE mode in EUT and operate it.

When it operating, The EUT is transmitting at maximum power level and duty cycle fixed.

2) Instruments and EUT were connected like Figure 10.4(B).

3) The average conducted output powers of LE and each frequency can measurement according to setting program in EUT.

4) Power levels were measured by a Power Meter.

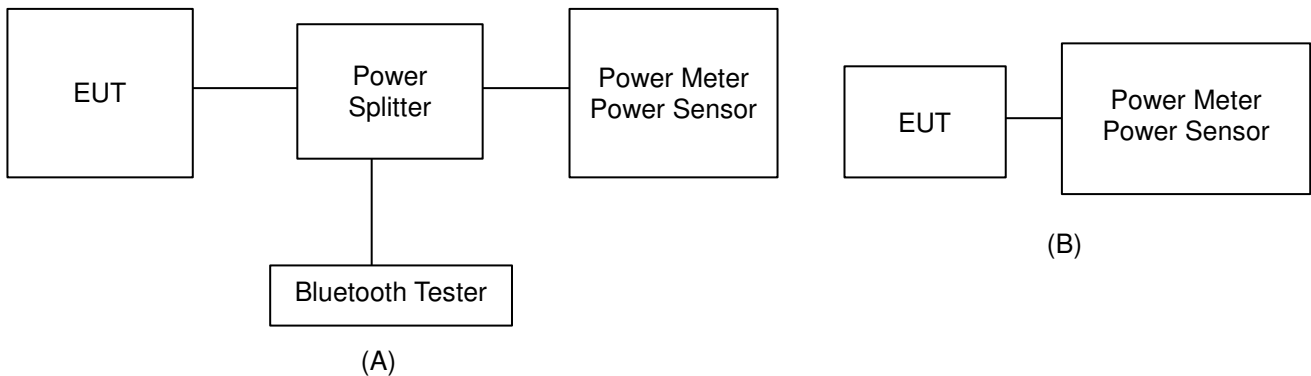

Figure 10.4 Average Power Measurement Setup

The average conducted output powers of Bluetooth were measured using above test setup and a wideband gated RF power meter when the EUT is transmitting at its maximum power level.

11. SYSTEM VERIFICATION

11.1 Tissue Verification

MEASURED TISSUE PARAMETERS										
Date(s)	Tissue Type	Ambient Temp.[°C]	Liquid Temp.[°C]	Measured Frequency [MHz]	Target Dielectric Constant, ϵ_r	Target Conductivity, σ (S/m)	Measured Dielectric Constant, ϵ_r	Measured Conductivity, σ (S/m)	Er Deviation [%]	σ Deviation [%]
Dec. 13. 2016	835 Head	20.8	20.6	824.2	41.550	0.899	40.921	0.872	-1.51	-3.00
				835.0	41.500	0.900	40.785	0.884	-1.72	-1.78
				836.6	41.500	0.901	40.765	0.885	-1.77	-1.78
				848.8	41.500	0.914	40.627	0.898	-2.10	-1.75
Dec. 13. 2016	835 Body	20.8	20.7	824.2	55.240	0.969	53.944	0.992	-2.35	2.37
				835.0	55.200	0.970	53.849	1.002	-2.45	3.30
				836.6	55.200	0.971	53.837	1.004	-2.47	3.40
				848.8	55.160	0.986	53.726	1.014	-2.60	2.84
Dec. 21. 2016	1900 Head	20.8	20.9	1850.2	40.000	1.400	40.678	1.384	1.69	-1.14
				1880.0	40.000	1.400	40.589	1.416	1.47	1.14
				1900.0	40.000	1.400	40.511	1.435	1.28	2.50
				1909.8	40.000	1.400	40.475	1.444	1.19	3.14
Dec. 21. 2016	1900 Body	20.8	20.5	1850.2	53.300	1.520	51.612	1.529	-3.17	0.59
				1880.0	53.300	1.520	51.607	1.552	-3.18	2.11
				1900.0	53.300	1.520	51.568	1.569	-3.25	3.22
				1909.8	53.300	1.520	51.560	1.579	-3.26	3.88
Dec. 12. 2016	835 Head	20.9	20.8	826.4	41.540	0.899	40.486	0.868	-2.54	-3.45
				835.0	41.500	0.900	40.376	0.877	-2.71	-2.56
				836.6	41.500	0.901	40.362	0.878	-2.74	-2.55
				846.6	41.500	0.912	40.245	0.888	-3.02	-2.63
Dec. 12. 2016	835 Body	20.9	20.7	826.4	55.240	0.969	53.830	0.991	-2.55	2.27
				835.0	55.200	0.970	53.759	0.999	-2.61	2.99
				836.6	55.200	0.971	53.744	1.000	-2.64	2.99
				846.6	55.170	0.984	53.647	1.009	-2.76	2.54
Dec. 22. 2016	750 Head	20.5	20.7	710.0	42.110	0.887	41.083	0.861	-2.44	-2.93
				750.0	41.900	0.890	40.569	0.897	-3.18	0.79
Dec. 22. 2016	750 Body	20.5	20.4	710.0	55.690	0.960	56.820	0.934	2.03	-2.71
				750.0	55.530	0.963	56.450	0.969	1.66	0.62
Dec. 23. 2016	2450 Head	21.2	21.0	2412.0	39.270	1.766	39.205	1.782	-0.17	0.91
				2437.0	39.220	1.788	39.136	1.810	-0.21	1.23
				2450.0	39.200	1.800	39.091	1.825	-0.28	1.39
				2462.0	39.180	1.813	39.057	1.839	-0.31	1.43
Dec. 23. 2016	2450 Body	21.2	21.1	2412.0	52.750	1.914	51.613	1.886	-2.16	-1.46
				2437.0	52.720	1.938	51.539	1.914	-2.24	-1.24
				2450.0	52.700	1.950	51.500	1.931	-2.28	-0.97
				2462.0	52.680	1.967	51.474	1.945	-2.29	-1.12

MEASURED TISSUE PARAMETERS										
Date(s)	Tissue Type	Ambient Temp.[°C]	Liquid Temp.[°C]	Measured Frequency [MHz]	Target Dielectric Constant, ϵ_r	Target Conductivity, σ (S/m)	Measured Dielectric Constant, ϵ_r	Measured Conductivity, σ (S/m)	Er Deviation [%]	σ Deviation [%]
Dec. 26. 2016	5300 Head	20.8	20.6	5260	35.940	4.720	36.523	4.812	1.62	1.95
				5280	35.920	4.740	36.495	4.840	1.60	2.11
				5300	35.900	4.760	36.469	4.859	1.58	2.08
				5320	35.880	4.780	36.423	4.886	1.51	2.22
Dec. 26. 2016	5300 Body	20.8	21.0	5260	48.930	5.369	48.424	5.486	-1.03	2.18
				5280	48.910	5.393	48.389	5.517	-1.07	2.30
				5300	48.880	5.416	48.358	5.540	-1.07	2.29
				5320	48.850	5.439	48.309	5.570	-1.11	2.41
Dec. 27. 2016	5600 Head	20.4	20.5	5580	35.530	5.049	36.311	5.147	2.20	1.94
				5600	35.500	5.070	36.276	5.174	2.19	2.05
				5660	35.440	5.130	36.183	5.241	2.10	2.16
				5700	35.400	5.170	36.107	5.290	2.00	2.32
Dec. 27. 2016	5600 Body	20.4	20.3	5580	48.500	5.743	47.816	5.931	-1.41	3.27
				5600	48.470	5.766	47.782	5.960	-1.42	3.36
				5660	48.390	5.836	47.660	6.042	-1.51	3.53
				5700	48.340	5.883	47.588	6.100	-1.56	3.69
Jan. 31. 2017	5300 Body	21.0	20.9	5280	48.910	5.393	47.230	5.447	-3.43	1.00
				5300	48.880	5.416	47.198	5.468	-3.44	0.96
Jan. 31. 2017	5600 Body	21.0	20.9	5580	48.500	5.743	46.635	5.849	-3.85	1.85
				5600	48.470	5.766	46.591	5.880	-3.88	1.98

The above measured tissue parameters were used in the DASY software. The DASY software was used to perform interpolation to determine the dielectric parameters at the SAR test device frequencies (per KDB 865664 and IEEE 1528-2013 6.6.1.2). The tissue parameters listed in the SAR test plots may slightly differ from the table above due to significant digit rounding in the software.

Measurement Procedure for Tissue verification:

- 1) The network analyzer and probe system was configured and calibrated.
- 2) The probe was immersed in the sample which was placed in a nonmetallic container. Trapped air bubbles beneath the flange were minimized by placing the probe at a slight angle.
- 3) The complex admittance with respect to the probe aperture was measured
- 4) The complex relative permittivity, for example from the below equation (Pourmaropoulos and Misra):

$$Y = \frac{j2\omega\epsilon_r\epsilon_0}{[\ln(b/a)]^2} \int_a^b \int_a^b \int_0^\pi \cos\phi' \frac{\exp[-j\omega r(\mu_0\epsilon_r\epsilon_0)^{1/2}]}{r} d\phi' d\rho' d\rho$$

where Y is the admittance of the probe in contact with the sample, the primed and unprimed coordinates refer to source and observation points, respectively, $r^2 = \rho^2 + \rho'^2 - 2\rho\rho'\cos\phi'$, ω is the angular frequency, and $j = \sqrt{-1}$.

11.2 Test System Verification

Prior to assessment, the system is verified to the $\pm 10\%$ of the specifications at 750 MHz, 835 MHz, 1900 MHz, 2450 MHz and 5GHz by using the SAR Dipole kit(s). (Graphic Plots Attached)

SYSTEM DIPOLE VERIFICATION TARGET & MEASURED

SAR System #	Freq. [MHz]	SAR Dipole kits	Date(s)	Tissue Type	Ambient Temp. [°C]	Liquid Temp. [°C]	Probe S/N	Input Power (mW)	1 W Target SAR _{1g} (W/kg)	Measured SAR _{1g} (W/kg)	1 W Normalized SAR _{1g} (W/kg)	Deviation [%]
C	835	D835V2, SN:4d159	Dec. 13. 2016	Head	20.8	20.6	3933	250	9.33	2.33	9.32	-0.11
C	835	D835V2, SN: 4d159	Dec. 13. 2016	Body	20.8	20.7	3933	250	9.57	2.48	9.92	3.66
C	1900	D1900V2, SN:5d176	Dec. 21. 2016	Head	20.8	20.9	3933	250	40.9	10.20	40.80	-0.24
C	1900	D1900V2, SN: 5d176	Dec. 21. 2016	Body	20.8	20.5	3933	250	39.3	9.99	39.96	1.68
C	835	D835V2, SN:4d159	Dec. 12. 2016	Head	20.9	20.8	3933	250	9.33	2.31	9.24	-0.96
C	835	D835V2, SN: 4d159	Dec. 12. 2016	Body	20.9	20.7	3933	250	9.57	2.26	9.04	-5.54
C	750	D750V2, SN: 1049	Dec. 22. 2016	Head	20.5	20.7	3933	250	8.31	1.93	7.72	-7.10
C	750	D750V2, SN: 1049	Dec. 22. 2016	Body	20.5	20.4	3933	250	8.86	2.12	8.48	-4.29
C	2450	D2450V2, SN: 920	Dec. 23. 2016	Head	21.2	21.0	3933	250	52.5	12.70	50.80	-3.24
C	2450	D2450V2, SN: 920	Dec. 23. 2016	Body	21.2	21.1	3933	250	51.0	13.10	52.40	2.75
C	5300	D5GV2, SN:1212	Dec. 26. 2016	Head	20.8	20.6	3933	100	81.2	8.41	84.10	3.57
C	5300	D5GV2, SN:1212	Dec. 26. 2016	Body	20.8	21.0	3933	100	76.2	7.81	78.10	2.49
C	5600	D5GV2, SN:1212	Dec. 27. 2016	Head	20.4	20.5	3933	100	79.1	8.19	81.90	3.54
C	5600	D5GV2, SN:1212	Dec. 27. 2016	Body	20.4	20.3	3933	100	78.4	8.31	83.10	5.99
C	5300	D5GV2, SN:1212	Jan. 31. 2017	Body	21.0	20.9	3933	100	76.2	7.25	72.50	-4.86
C	5600	D5GV2, SN:1212	Jan. 31. 2017	Body	21.0	20.9	3933	100	78.4	7.96	79.60	1.53

Note1 : System Verification was measured with input 250 mW, 100 mW (5200-5800 MHz) and normalized to 1W.

Note2 : To confirm the proper SAR liquid depth, the z-axis plots from the system verifications were included since the system verifications were performed using the same liquid, probe and DAE as the SAR tests in the same time period.

Note3: Full system validation status and results can be found in Attachment 3.

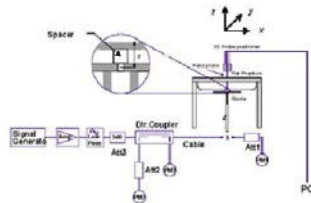

Figure 11.1 Dipole Verification Test Setup Diagram & Photo

12. SAR TEST RESULTS

12.1 Head SAR Results

Table 12.1.1 GSM/GPRS 850 Head SAR

MEASUREMENT RESULTS														
FREQUENCY		Mode/ Band	Service	Maximum Allowed Power [dBm]	Conducted Power [dBm]	Drift Power [dB]	Phantom Position	Device Serial Number	# of Time Slots	Duty Cycle	1g SAR (W/kg)	Scaling Factor	1g Scaled SAR (W/kg)	Plots #
MHz	Ch													
836.6	190	GSM850	GSM	33.0	32.54	-0.120	Left Touch	FCC #1	1	1:8.3	0.469	1.112	0.522	
836.6	190	GSM850	GSM	33.0	32.54	0.180	Right Touch	FCC #1	1	1:8.3	0.506	1.112	0.563	A1
836.6	190	GSM850	GSM	33.0	32.54	-0.140	Left Tilt	FCC #1	1	1:8.3	0.458	1.112	0.509	
836.6	190	GSM850	GSM	33.0	32.54	-0.150	Right Tilt	FCC #1	1	1:8.3	0.454	1.112	0.505	
836.6	190	GSM850	GPRS	31.0	30.88	0.140	Left Touch	FCC #1	2	1:4.15	0.667	1.028	0.686	
836.6	190	GSM850	GPRS	31.0	30.88	-0.010	Right Touch	FCC #1	2	1:4.15	0.712	1.028	0.732	A2
836.6	190	GSM850	GPRS	31.0	30.88	0.010	Left Tilt	FCC #1	2	1:4.15	0.617	1.028	0.634	
836.6	190	GSM850	GPRS	31.0	30.88	0.030	Right Tilt	FCC #1	2	1:4.15	0.610	1.028	0.627	
ANSI / IEEE C95.1-2005– SAFETY LIMIT Spatial Peak Uncontrolled Exposure/General Population Exposure								Head 1.6 W/kg (mW/g) averaged over 1 gram						

Table 12.1.2 PCS/GPRS 1900 Head SAR

MEASUREMENT RESULTS														
FREQUENCY		Mode/ Band	Service	Maximum Allowed Power [dBm]	Conducted Power [dBm]	Drift Power [dB]	Phantom Position	Device Serial Number	# of Time Slots	Duty Cycle	1g SAR (W/kg)	Scaling Factor	1g Scaled SAR (W/kg)	Plots #
MHz	Ch													
1880.0	661	PCS1900	PCS	29.5	29.18	-0.140	Left Touch	FCC #1	1	1:8.3	0.093	1.076	0.100	
1880.0	661	PCS1900	PCS	29.5	29.18	0.010	Right Touch	FCC #1	1	1:8.3	0.154	1.076	0.166	A3
1880.0	661	PCS1900	PCS	29.5	29.18	-0.180	Left Tilt	FCC #1	1	1:8.3	0.051	1.076	0.055	
1880.0	661	PCS1900	PCS	29.5	29.18	0.170	Right Tilt	FCC #1	1	1:8.3	0.029	1.076	0.031	
1880.0	661	PCS1900	GPRS	28.0	27.74	-0.160	Left Touch	FCC #1	2	1:4.15	0.123	1.062	0.131	
1880.0	661	PCS1900	GPRS	28.0	27.74	0.150	Right Touch	FCC #1	2	1:4.15	0.193	1.062	0.205	A4
1880.0	661	PCS1900	GPRS	28.0	27.74	0.060	Left Tilt	FCC #1	2	1:4.15	0.066	1.062	0.070	
1880.0	661	PCS1900	GPRS	28.0	27.74	-0.100	Right Tilt	FCC #1	2	1:4.15	0.042	1.062	0.045	
ANSI / IEEE C95.1-2005– SAFETY LIMIT Spatial Peak Uncontrolled Exposure/General Population Exposure								Head 1.6 W/kg (mW/g) averaged over 1 gram						

Table 12.1.3 WCDMA 850 Head SAR

MEASUREMENT RESULTS													
FREQUENCY		Mode/ Band	Service	Maximum Allowed Power [dBm]	Conducted Power [dBm]	Drift Power [dB]	Phantom Position	Device Serial Number	Duty Cycle	1g SAR (W/kg)	Scaling Factor	1g Scaled SAR (W/kg)	Plots #
MHz	Ch												
836.6	4183	WCDMA 850	RMC	24.3	23.35	0.040	Left Touch	FCC #1	1:1	0.294	1.245	0.366	
836.6	4183	WCDMA 850	RMC	24.3	23.35	0.070	Right Touch	FCC #1	1:1	0.351	1.245	0.437	A5
836.6	4183	WCDMA 850	RMC	24.3	23.35	-0.140	Left Tilt	FCC #1	1:1	0.299	1.245	0.372	
836.6	4183	WCDMA 850	RMC	24.3	23.35	-0.020	Right Tilt	FCC #1	1:1	0.294	1.245	0.366	
ANSI / IEEE C95.1-2005– SAFETY LIMIT Spatial Peak Uncontrolled Exposure/General Population Exposure								Head 1.6 W/kg (mW/g) averaged over 1 gram					

Table 12.1.4 LTE Band 17 Head SAR

MEASUREMENT RESULTS																	
FREQUENCY		Mode/ Band	BW [MHz]	Max Allowed Power [dBm]	Cond. PWR [dBm]	Drift Power [dB]	MPR	Position	Device Serial Number	Mod.	RB Size	RB Offs.	Duty Cycle	1g SAR (W/kg)	Scaling Factor	1g Scaled SAR (W/kg)	Plots #
MHz	Ch																
710.0	23790	LTE B17	10	24.8	23.84	0.180	0	Left Touch	FCC #1	QPSK	1	0	1:1	0.241	1.247	0.301	
710.0	23790	LTE B17	10	23.8	22.68	-0.030	1	Left Touch	FCC #1	QPSK	25	0	1:1	0.191	1.294	0.247	
710.0	23790	LTE B17	10	24.8	23.84	0.070	0	Right Touch	FCC #1	QPSK	1	0	1:1	0.302	1.247	0.377	A6
710.0	23790	LTE B17	10	23.8	22.68	0.110	1	Right Touch	FCC #1	QPSK	25	0	1:1	0.245	1.294	0.317	
710.0	23790	LTE B17	10	24.8	23.84	0.160	0	Left Tilt	FCC #1	QPSK	1	0	1:1	0.202	1.247	0.252	
710.0	23790	LTE B17	10	23.8	22.68	0.030	1	Left Tilt	FCC #1	QPSK	25	0	1:1	0.156	1.294	0.202	
710.0	23790	LTE B17	10	24.8	23.84	0.170	0	Right Tilt	FCC #1	QPSK	1	0	1:1	0.248	1.247	0.309	
710.0	23790	LTE B17	10	23.8	22.68	-0.040	1	Right Tilt	FCC #1	QPSK	25	0	1:1	0.182	1.294	0.236	
ANSI / IEEE C95.1-2005– SAFETY LIMIT Spatial Peak Uncontrolled Exposure/General Population Exposure										Head 1.6 W/kg (mW/g) averaged over 1 gram							

Table 12.1.5 DTS Head SAR

MEASUREMENT RESULTS																
FREQUENCY		Mode	Maximum Allowed Power [dBm]	Conducted Power [dBm]	Drift Power [dB]	Phantom Position	Device Serial Number	Peak SAR of Area Scan	Data Rate [Mbps]	Duty Cycle	1g SAR (W/kg)	Scaling Factor	Scaling Factor (Duty Cycle)	1g Scaled SAR (W/kg)	Plots #	
MHz	Ch															
2437	6	802.11b	16.5	16.25	0.050	Left Touch	FCC #1	0.317	1	100	0.304	1.059	1.000	0.322	A7	
2437	6	802.11b	16.5	16.25	-	Right Touch	FCC #1	0.136	1	100	-	1.059	1.000	-		
2437	6	802.11b	16.5	16.25	-	Left Tilt	FCC #1	0.222	1	100	-	1.059	1.000	-		
2437	6	802.11b	16.5	16.25	-	Right Tilt	FCC #1	0.128	1	100	-	1.059	1.000	-		
ANSI / IEEE C95.1-2005– SAFETY LIMIT Spatial Peak Uncontrolled Exposure/General Population Exposure										Head 1.6 W/kg (mW/g) averaged over 1 gram						

Note(s):

- Highest reported SAR is ≤ 0.4 W/kg. Therefore, further SAR measurements within this exposure condition are not required.

Adjusted SAR results for OFDM SAR												
FREQUENCY		Mode/ Antenna	Service	Maximum Allowed Power [dBm]	1g Scaled SAR (W/kg)	FREQUENCY [MHz]	Mode	Service	Maximum Allowed Power [dBm]	Ratio of OFDM to DSSS	1g Adjusted SAR (W/kg)	Determine OFDM SAR
MHz	Ch											
2437	6	802.11b	DSSS	16.50	0.322	2437	802.11g	OFDM	12.50	0.398	0.128	X
2437	6	802.11b	DSSS	16.50	0.322	2437	802.11n HT20	OFDM	12.50	0.398	0.128	X
ANSI / IEEE C95.1-2005– SAFETY LIMIT Spatial Peak Uncontrolled Exposure/General Population Exposure										Head 1.6 W/kg (mW/g) averaged over 1 gram		

Note: SAR is not required for the following 2.4 GHz OFDM conditions. When the highest reported SAR for DSSS is adjusted by the ratio of OFDM to DSSS specified maximum output power and the adjusted SAR is ≤ 1.2 W/kg.

Table 10.1.6 UNII Head SAR

MEASUREMENT RESULTS															
FREQUENCY		Mode	Maximum Allowed Power [dBm]	Conducted Power [dBm]	Drift Power [dB]	Phantom Position	Device Serial Number	Peak SAR of Area Scan	Data Rate [Mbps]	Duty Cycle	1g SAR (W/kg)	Scaling Factor	Scaling Factor (Duty Cycle)	1g Scaled SAR (W/kg)	Plots #
MHz	Ch														
5280	56	802.11a	15.5	14.93	-0.110	Left Touch	FCC #1	0.411	6	100	0.451	1.140	1.000	0.514	
5280	56	802.11a	15.5	14.93	0.160	Right Touch	FCC #1	0.378	6	100	0.347	1.140	1.000	0.396	
5280	56	802.11a	15.5	14.93	-0.120	Left Tilt	FCC #1	0.453	6	100	0.469	1.140	1.000	0.535	A8
5280	56	802.11a	15.5	14.93	0.040	Right Tilt	FCC #1	0.422	6	100	0.395	1.140	1.000	0.450	
5580	116	802.11a	15.5	14.67	0.010	Left Touch	FCC #1	0.355	6	100	0.357	1.211	1.000	0.432	
5580	116	802.11a	15.5	14.67	0.030	Right Touch	FCC #1	0.271	6	100	0.196	1.211	1.000	0.237	
5580	116	802.11a	15.5	14.67	-0.020	Left Tilt	FCC #1	0.362	6	100	0.363	1.211	1.000	0.440	A9
5580	116	802.11a	15.5	14.67	0.150	Right Tilt	FCC #1	0.265	6	100	0.210	1.211	1.000	0.254	
ANSI / IEEE C95.1-2005– SAFETY LIMIT Spatial Peak Uncontrolled Exposure/General Population Exposure								Head 1.6 W/kg (mW/g) averaged over 1 gram							

Note(s):

- Highest reported SAR is ≤ 0.4 W/kg. Therefore, further SAR measurements within this exposure condition are not required.
- Highest reported SAR is > 0.4 W/kg. Due to the highest reported SAR for this test position, other test position is Head exposure condition were evaluated until a SAR ≤ 0.8 W/kg was reported.

Adjusted SAR results for UNII-1 and UNII-2A SAR												
FREQUENCY		Mode/ Antenna	Service	Maximum Allowed Power [dBm]	1g Scaled SAR (W/kg)	FREQUENCY [MHz]	Mode	Service	Maximum Allowed Power [dBm]	Adjusted Factor	1g Adjusted SAR (W/kg)	SAR for the band with lower maximum output power
MHz	Ch											
5280	56	802.11a	OFDM	15.5	0.535	5180	802.11a	OFDM	13.5	0.631	0.338	X
ANSI / IEEE C95.1-2005– SAFETY LIMIT Spatial Peak Uncontrolled Exposure/General Population Exposure								Head 1.6 W/kg (mW/g) averaged over 1 gram				

Note(s):

- U-NII-1 and U-NII-2A Bands: When different maximum output power is specified for the bands, begin SAR measurement in the band with higher specified maximum output power. The highest reported SAR for the tested configuration is adjusted by the ratio of lower to higher specified maximum output power for the two bands. When the adjusted SAR is ≤ 1.2 W/kg, SAR is not required for the band with lower maximum output power in that test configuration.

12.2 Standalone Body-Worn SAR Worn SAR Results

Table 12.2.1 GSM/PCS/GPRS/WCDMA Body-Worn SAR

MEASUREMENT RESULTS														
FREQUENCY		Mode/ Band	Service	Maximum Allowed Power [dBm]	Conducted Power [dBm]	Drift Power [dB]	Spacing [Side]	Device Serial Number	# of Time Slots	Duty Cycle	1g SAR (W/kg)	Scaling Factor	1g Scaled SAR (W/kg)	Plots #
MHz	Ch													
836.6	190	GSM850	GSM	33.0	32.54	0.000	10 mm [Rear]	FCC #1	1	1:8.3	0.660	1.112	0.734	A10
824.2	128	GSM850	GPRS	31.0	30.71	0.010	10 mm [Rear]	FCC #1	2	1:4.15	0.939	1.069	1.004	A11
836.6	190	GSM850	GPRS	31.0	30.88	-0.000	10 mm [Rear]	FCC #1	2	1:4.15	0.903	1.028	0.928	
848.8	251	GSM850	GPRS	31.0	30.85	-0.020	10 mm [Rear]	FCC #1	2	1:4.15	0.795	1.035	0.823	
824.2	128	GSM850	GPRS	31.0	30.71	-0.040	10 mm [Rear]	FCC #1	2	1:4.15	0.933	1.069	0.997	
1880.0	661	PCS1900	PCS	29.5	29.18	0.050	10 mm [Rear]	FCC #1	1	1:8.3	0.472	1.076	0.508	A12
1880.0	661	PCS1900	GPRS	28.0	27.74	0.020	10 mm [Rear]	FCC #1	2	1:4.15	0.688	1.062	0.731	A13
836.6	4183	WCDMA 850	RMC	24.3	23.35	0.000	10 mm [Rear]	FCC #1	N/A	1:1	0.431	1.245	0.537	A14
ANSI / IEEE C95.1-2005– SAFETY LIMIT Spatial Peak Uncontrolled Exposure/General Population Exposure									Body 1.6 W/kg (mW/g) averaged over 1 gram					

Note: Blue entries represent variability measurements.

Table 12.2.2 LTE Body-Worn SAR

MEASUREMENT RESULTS																	
FREQUENCY		Mode/ Band	BW [MHz]	Max Allowed Power [dBm]	Cond. PWR [dBm]	Drift Power [dB]	MPR	Position	Device Serial Number	Mod.	RB Size	RB Offs.	Duty Cycle	1g SAR (W/kg)	Scaling Factor	1g Scaled SAR (W/kg)	Plots #
MHz	Ch																
710.0	23790	LTE B17	10	24.8	23.84	-0.060	0	10 mm [Rear]	FCC #1	QPSK	1	0	1:1	0.462	1.247	0.576	A15
710.0	23790	LTE B17	10	23.8	22.68	0.000	1	10 mm [Rear]	FCC #1	QPSK	25	0	1:1	0.369	1.294	0.477	
ANSI / IEEE C95.1-2005– SAFETY LIMIT Spatial Peak Uncontrolled Exposure/General Population Exposure									Body 1.6 W/kg (mW/g) averaged over 1 gram								

Table 12.2.3 DTS Body-Worn SAR

MEASUREMENT RESULTS															
FREQUENCY		Mode	Maximum Allowed Power [dBm]	Conducted Power [dBm]	Drift Power [dB]	Phantom Position	Device Serial Number	Peak SAR of Area Scan	Data Rate [Mbps]	Duty Cycle	1g SAR (W/kg)	Scaling Factor	Scaling Factor (Duty Cycle)	SAR (W/kg)	Plots #
MHz	Ch														
2437	6	802.11b	16.5	16.25	0.000	10 mm [Rear]	FCC #1	0.180	1	100	0.198	1.059	1.000	0.210	A16
ANSI / IEEE C95.1-2005– SAFETY LIMIT Spatial Peak Uncontrolled Exposure/General Population Exposure									Body 1.6 W/kg (mW/g) averaged over 1 gram						

Note(s):

- Highest reported SAR is ≤ 0.4 W/kg. Therefore, further SAR measurements within this exposure condition are not required.

Adjusted SAR results for OFDM SAR												
FREQUENCY		Mode/ Antenna	Service	Maximum Allowed Power [dBm]	1g Scaled SAR (W/kg)	FREQUENCY [MHz]	Mode	Service	Maximum Allowed Power [dBm]	Ratio of OFDM to DSSS	1g Adjusted SAR (W/kg)	Determine OFDM SAR
MHz	Ch											
2437	6	802.11b	DSSS	16.50	0.210	2437	802.11g	OFDM	12.50	0.398	0.084	X
2437	6	802.11b	DSSS	16.50	0.210	2437	802.11n HT20	OFDM	12.50	0.398	0.084	X
ANSI / IEEE C95.1-2005– SAFETY LIMIT Spatial Peak Uncontrolled Exposure/General Population Exposure									Body 1.6 W/kg (mW/g) averaged over 1 gram			

 Note: SAR is not required for the following 2.4 GHz OFDM conditions. When the highest reported SAR for DSSS is adjusted by the ratio of OFDM to DSSS specified maximum output power and the adjusted SAR is ≤ 1.2 W/kg.

Table 12.2.4 UNII Body-Worn SAR

MEASUREMENT RESULTS

FREQUENCY		Mode	Maximum Allowed Power [dBm]	Conducted Power [dBm]	Drift Power [dB]	Phantom Position	Device Serial Number	Peak SAR of Area Scan	Data Rate [Mbps]	Duty Cycle	1g SAR (W/kg)	Scaling Factor	Scaling Factor (Duty Cycle)	1g Scaled SAR (W/kg)	Plots #
MHz	Ch														
5280	56	802.11a	15.5	14.93	-0.020	10 mm [Front]	FCC #1	0.067	6	100	0.052	1.140	1.000	0.059	
5280	56	802.11a	15.5	14.93	-0.040	10 mm [Rear]	FCC #1	0.327	6	100	0.314	1.140	1.000	0.358	A17
5580	116	802.11a	15.5	14.67	0.110	10 mm [Front]	FCC #1	0.054	6	100	0.027	1.211	1.000	0.033	
5580	116	802.11a	15.5	14.67	0.130	10 mm [Rear]	FCC #1	0.261	6	100	0.233	1.211	1.000	0.282	A18
ANSI / IEEE C95.1-2005– SAFETY LIMIT Spatial Peak Uncontrolled Exposure/General Population Exposure								Body 1.6 W/kg (mW/g) averaged over 1 gram							

Note(s):

- Highest reported SAR is ≤ 0.4 W/kg. Therefore, further SAR measurements within this exposure condition are not required.

Adjusted SAR results for UNII-1 and UNII-2A SAR

FREQUENCY		Mode/ Antenna	Service	Maximum Allowed Power [dBm]	1g Scaled SAR (W/kg)	FREQUENCY [MHz]	Mode	Service	Maximum Allowed Power [dBm]	Adjusted Factor	1g Adjusted SAR (W/kg)	SAR for the band with lower maximum output power
MHz	Ch											
5280	56	802.11a	OFDM	15.5	0.358	5180	802.11a	OFDM	13.0	0.631	0.226	X
ANSI / IEEE C95.1-2005– SAFETY LIMIT Spatial Peak Uncontrolled Exposure/General Population Exposure						Body 1.6 W/kg (mW/g) averaged over 1 gram						

Note(s):

- U-NII-1 and U-NII-2A Bands: When different maximum output power is specified for the bands, begin SAR measurement in the band with higher specified maximum output power. The highest reported SAR for the tested configuration is adjusted by the ratio of lower to higher specified maximum output power for the two bands. When the adjusted SAR is ≤ 1.2 W/kg, SAR is not required for the band with lower maximum output power in that test configuration.

12.3 Standalone Wireless router SAR Results

Table 12.3.1 GPRS Hotspot SAR

MEASUREMENT RESULTS														
FREQUENCY		Mode/ Band	Service	Maximum Allowed Power [dBm]	Conducted Power [dBm]	Drift Power [dB]	Spacing [Side]	Device Serial Number	# of Time Slots	Duty Cycle	1g SAR (W/kg)	Scaling Factor	1g Scaled SAR (W/kg)	Plots #
MHz	Ch													
836.6	190	GSM850	GPRS	31.0	30.88	-0.010	10 mm [Bottom]	FCC #1	2	1:4.15	0.170	1.028	0.175	
836.6	190	GSM850	GPRS	31.0	30.88	-0.020	10 mm [Front]	FCC #1	2	1:4.15	0.774	1.028	0.796	
824.2	128	GSM850	GPRS	31.0	30.71	0.010	10 mm [Rear]	FCC #1	2	1:4.15	0.939	1.069	1.004	A11
836.6	190	GSM850	GPRS	31.0	30.88	-0.000	10 mm [Rear]	FCC #1	2	1:4.15	0.903	1.028	0.928	
848.8	251	GSM850	GPRS	31.0	30.85	-0.020	10 mm [Rear]	FCC #1	2	1:4.15	0.795	1.035	0.823	
836.6	190	GSM850	GPRS	31.0	30.88	0.040	10 mm [Right]	FCC #1	2	1:4.15	0.767	1.028	0.788	
824.2	128	GSM850	GPRS	31.0	30.71	-0.040	10 mm [Rear]	FCC #1	2	1:4.15	0.933	1.069	0.997	
1880.0	661	PCS1900	GPRS	28.0	27.74	0.180	10 mm [Bottom]	FCC #1	2	1:4.15	0.473	1.062	0.502	
1880.0	661	PCS1900	GPRS	28.0	27.74	0.030	10 mm [Front]	FCC #1	2	1:4.15	0.407	1.062	0.432	
1880.0	661	PCS1900	GPRS	28.0	27.74	0.020	10 mm [Rear]	FCC #1	2	1:4.15	0.688	1.062	0.731	A13
1880.0	661	PCS1900	GPRS	28.0	27.74	-0.040	10 mm [Right]	FCC #1	2	1:4.15	0.099	1.062	0.105	
ANSI / IEEE C95.1-2005– SAFETY LIMIT Spatial Peak Uncontrolled Exposure/General Population Exposure								Body 1.6 W/kg (mW/g) averaged over 1 gram						

Note: Blue entries represent variability measurements.

Table 12.3.2 WCDMA Hotspot SAR

MEASUREMENT RESULTS														
FREQUENCY		Mode/ Band	Service	Maximum Allowed Power [dBm]	Conducted Power [dBm]	Drift Power [dB]	Spacing [Side]	Device Serial Number	# of Time Slots	Duty Cycl e	1g SAR (W/kg)	Scaling Factor	1g Scaled SAR (W/kg)	Plots #
MHz	Ch													
836.6	4183	WCDMA 850	RMC	24.3	23.35	0.170	10 mm [Bottom]	FCC #1	N/A	1:1	0.083	1.245	0.103	
836.6	4183	WCDMA 850	RMC	24.3	23.35	0.110	10 mm [Front]	FCC #1	N/A	1:1	0.383	1.245	0.477	
836.6	4183	WCDMA 850	RMC	24.3	23.35	0.000	10 mm [Rear]	FCC #1	N/A	1:1	0.431	1.245	0.537	A14
836.6	4183	WCDMA 850	RMC	24.3	23.35	-0.000	10 mm [Right]	FCC #1	N/A	1:1	0.423	1.245	0.527	
ANSI / IEEE C95.1-2005– SAFETY LIMIT Spatial Peak Uncontrolled Exposure/General Population Exposure								Body 1.6 W/kg (mW/g) averaged over 1 gram						

Table 12.3.3 LTE Band 17 Hotspot SAR

MEASUREMENT RESULTS																	
FREQUENCY		Mode/ Band	BW [MHz]	Max Allowed Power [dBm]	Cond. PWR [dBm]	Drift Power [dB]	MPR	Position	Device Serial Number	Mod.	RB Size	RB Offs.	Duty Cycle	1g SAR (W/kg)	Scaling Factor	1g Scaled SAR (W/kg)	Plots #
MHz	Ch																
710.0	23790	LTE B17	10	24.8	23.84	0.040	0	10 mm [Bot.]	FCC #1	QPSK	1	0	1:1	0.065	1.247	0.081	
710.0	23790	LTE B17	10	23.8	22.68	-0.000	1	10 mm [Bot.]	FCC #1	QPSK	25	0	1:1	0.049	1.294	0.063	
710.0	23790	LTE B17	10	24.8	23.84	0.150	0	10 mm [Front]	FCC #1	QPSK	1	0	1:1	0.305	1.164	0.355	
710.0	23790	LTE B17	10	23.8	22.68	0.000	1	10 mm [Front]	FCC #1	QPSK	25	0	1:1	0.248	1.294	0.321	
710.0	23790	LTE B17	10	24.8	23.84	-0.060	0	10 mm [Rear]	FCC #1	QPSK	1	0	1:1	0.462	1.247	0.576	A15
710.0	23790	LTE B17	10	23.8	22.68	0.000	1	10 mm [Rear]	FCC #1	QPSK	25	0	1:1	0.369	1.294	0.477	
710.0	23790	LTE B17	10	24.8	23.84	0.160	0	10 mm [Right]	FCC #1	QPSK	1	0	1:1	0.231	1.247	0.288	
710.0	23790	LTE B17	10	23.8	22.68	0.020	1	10 mm [Right]	FCC #1	QPSK	25	0	1:1	0.185	1.294	0.239	
ANSI / IEEE C95.1-2005– SAFETY LIMIT Spatial Peak Uncontrolled Exposure/General Population Exposure									Body 1.6 W/kg (mW/g) averaged over 1 gram								

Table 12.3.4 W-LAN Hotspot SAR

MEASUREMENT RESULTS																
FREQUENCY		Mode	Maximum Allowed Power [dBm]	Conducted Power [dBm]	Drift Power [dB]	Phantom Position	Device Serial Number	Peak SAR of Area Scan	Data Rate [Mbps]	Duty Cycle	1g SAR (W/kg)	Scaling Factor	Scaling Factor (Duty Cycle)	SAR (W/kg)	Plots #	
MHz	Ch															
2437	6	802.11b	16.5	16.25	-0.070	10 mm [Top]	FCC #1	0.084	1	100	-	1.059	1.000	-		
2437	6	802.11b	16.5	16.25	0.170	10 mm [Front]	FCC #1	0.052	1	100	-	1.059	1.000	-		
2437	6	802.11b	16.5	16.25	0.000	10 mm [Rear]	FCC #1	0.180	1	100	0.198	1.059	1.000	0.210	A16	
2437	6	802.11b	16.5	16.25	0.160	10 mm [Right]	FCC #1	0.039	1	100	-	1.059	1.000	-		
ANSI / IEEE C95.1-2005– SAFETY LIMIT Spatial Peak Uncontrolled Exposure/General Population Exposure									Body 1.6 W/kg (mW/g) averaged over 1 gram							

Note(s):

- Highest reported SAR is ≤ 0.4 W/kg. Therefore, further SAR measurements within this exposure condition are not required.

Adjusted SAR results for OFDM SAR

FREQUENCY		Mode/ Antenna	Service	Maximum Allowed Power [dBm]	1g Scaled SAR (W/kg)	FREQUENCY [MHz]	Mode	Service	Maximum Allowed Power [dBm]	Ratio of OFDM to DSSS	1g Adjusted SAR (W/kg)	Determine OFDM SAR
MHz	Ch											
2437	6	802.11b	DSSS	16.50	0.210	2437	802.11g	OFDM	12.50	0.398	0.084	X
2437	6	802.11b	DSSS	16.50	0.210	2437	802.11n HT20	OFDM	12.50	0.398	0.084	X
ANSI / IEEE C95.1-2005– SAFETY LIMIT Spatial Peak Uncontrolled Exposure/General Population Exposure									Body 1.6 W/kg (mW/g) averaged over 1 gram			

Note: SAR is not required for the following 2.4 GHz OFDM conditions. When the highest reported SAR for DSSS is adjusted by the ratio of OFDM to DSSS specified maximum output power and the adjusted SAR is ≤ 1.2 W/kg.

12.4 SAR Test Notes

General Notes:

1. The test data reported are the worst-case SAR values according to test procedures specified in IEEE 1528-2013, and FCC KDB Publication 447498 D01v06.
2. Batteries are fully charged at the beginning of the SAR measurements. A standard battery was used for all SAR measurements.
3. Liquid tissue depth was at least 15.0 cm for all frequencies.
4. The manufacturer has confirmed that the device(s) tested have the same physical, mechanical and thermal characteristics and are within operational tolerances expected for production units
5. SAR results were scaled to the maximum allowed power to demonstrate compliance per FCC KDB Publication 447498 D01v06.
6. Device was tested using a fixed spacing for body-worn accessory testing. A separation distance of 10 mm was considered because the manufacturer has determined that there will be body-worn accessories available in the marketplace for users to support this separation distance.
7. Per FCC KDB Publication 648474 D04v01r03, SAR was evaluated without a headset connected to the device. Since the standalone reported SAR was not > 1.2 W/kg, no additional SAR evaluations using a headset cable were performed.
8. During SAR Testing for the Wireless Router conditions per FCC KDB Publication 941225 D06v02r01, the actual Portable Hotspot operation (with actual simultaneous transmission of a transmitter with WIFI) was not activated.
9. Per FCC KDB 865664 D01v01r04, variability SAR tests were performed when the measured SAR results for a frequency band were greater than 0.8 W/kg. Repeated SAR measurements are highlighted in the tables above for clarity. Please see Section 14 for variability analysis.

GSM Notes:

1. Body-Worn accessory testing is typically associated with voice operations. Therefore, GSM voice was evaluated for body-worn SAR.
2. This device supports GSM VOIP in the head and body-worn configurations; therefore GPRS was additionally evaluated for head and body-worn compliance.
3. Justification for reduced test configurations per KDB Publication 941225 D01v03r01 and October 2013 TCB Workshop Notes: The source-based frame-averaged output power was evaluated for all GPRS slot configurations. The configuration with the highest target frame averaged output power was evaluated for hotspot SAR.
4. Per FCC KDB Publication 447498 D01v06, if the reported (scaled) SAR measured at the middle channel or highest output power channel for each test configuration is ≤ 0.8 W/kg then testing at the other channels is not required for such test configuration(s). Since the maximum output power variation across the required test channels is not > 1/2 dB, the middle channel was used for testing.

WCDMA(UMTS) Notes:

1. WCDMA (UMTS) mode in was tested under RMC 12.2 kbps with HSPA Inactive per KDB Publication 941225 D01v03r01. HSPA SAR was not required since the average output power of the HSPA subtests was not more than 0.25 dB higher than the RMC level and SAR was less than 1.2 W/kg.
2. Per FCC KDB Publication 447498 D01v06, if the reported (scaled) SAR measured at the middle channel or highest output power channel for each test configuration is ≤ 0.8 W/kg then testing at the other channels is not required for such test configuration(s). When the maximum output power variation across the required test channels is > 1/2 dB, instead of the middle channel, the highest output power channel was used.

LTE Notes:

1. LTE Considerations: LTE test configurations are determined according to SAR Evaluation Considerations for LTE Devices in FCC KDB Publication 941225 D05v02r05. The general test procedures used for testing can be found in Section 4.1.
2. MPR is permanently implemented for this device by the manufacturer. The specific manufacturer target MPR is indicated alongside the SAR results. MPR is enabled for this device, according to 3GPP TS36. 101 Section 6.2.3 – 6.2.5 under Table 6.2.3-1.

WLAN Notes:

1. The initial test position procedures were applied. The test position with the highest extrapolated peak SAR will be used as the initial test position. When reported SAR for the initial test position is ≤ 0.4 W/kg, no additional testing for the remaining test positions was required. Otherwise, SAR is evaluated at the subsequent highest peak SAR positions until the reported SAR result is ≤ 0.8 W/kg or all test positions are measured.
2. Justification for test configurations for WLAN per KDB Publication 248227 D01v02r02 for 2.4 GHz WIFI single transmission chain operations, the highest measured maximum output power channel for DSSS was selected for SAR measurement. SAR for OFDM modes (2.4 GHz 802.11g/n) was not required due to the maximum allowed powers and the highest reported DSSS SAR when the highest reported SAR for DSSS is adjusted by the ratio of OFDM to DSSS specified maximum output and the adjusted SAR is ≤ 1.2 W/kg.
3. Justification for test configurations for WLAN per KDB Publication 248227 D01v02r02 for 5 GHz WIFI single transmission chain operations, the initial test configuration was selected according to the transmission mode with the highest maximum allowed powers. Other transmission modes were not investigated since the highest reported SAR for initial test configuration adjusted by the ratio of maximum output powers is less than 1.2 W/kg.
4. When the maximum reported 1g averaged SAR ≤ 0.8 W/kg, SAR testing on additional channels was not required. Otherwise, SAR for the next highest output power channel was required until the reported SAR result was ≤ 1.20 W/kg or all test channels were measured.
5. The device was configured to transmit continuously at the required data rate, channel bandwidth and signal modulation, using the highest transmission duty factor to determine compliance.

13. FCC MULTI-TX AND ANTENNA SAR CONSIDERATIONS

13.1 Introduction

The following procedures adopted from FCC KDB Publication 447498 D01v06 are applicable to handsets with built-in unlicensed transmitters such as 802.11b/g/n and Bluetooth devices which may simultaneously transmit with the licensed transmitter.

13.2 Simultaneous Transmission Procedures

This device contains transmitters that may operate simultaneously. Therefore simultaneous transmission analysis is required. Per FCC KDB 447498 D01v06 IV.C.1.iii and IEEE 1528-2013 Section 6.3.4.1.2, simultaneous transmission SAR test exclusion may be applied when the sum of the 1-g SAR for all the simultaneous transmitting antennas in a specific a physical test configuration is ≤ 1.6 W/kg. When standalone SAR is not required to be measured, per FCC KDB 447498 D01v06 4.3.2 2), the following equation must be used to estimate the standalone 1g SAR for simultaneous transmission assessment involving that transmitter.

$$\text{Estimated SAR} = \frac{\sqrt{f(\text{GHz})}}{7.5} * \frac{(\text{Max Power of channel, mW})}{\text{Min. Separation Distance, mm}}$$

Table 13.2.1 Estimated SAR

Mode	Frequency	Maximum Allowed Power		Separation Distance (Body)	Estimated SAR (Body)
	[MHz]	[dBm]	[mW]	[mm]	[W/kg]
Bluetooth	2480	7.5	6	10	0.118

Note: Held-to ear configurations are not applicable to Bluetooth operations and therefore were not considered for simultaneous transmission. Per KDB Publication 447498 D01v06, the maximum power of the channel was rounded to the nearest mW before calculation.

13.3 Simultaneous Transmission Capabilities

According to FCC KDB Publication 447498 D01v06, transmitters are considered to be transmitting simultaneously when there is overlapping transmission, with the exception of transmissions during network hand-offs with maximum hand-off duration less than 30 seconds. Possible transmission paths for the DUT are shown in Figure 13.1 and are color-coded to indicate communication modes which share the same path. Modes which share the same transmission path cannot transmit simultaneously with one another.



Figure 13.1 Simultaneous Transmission Paths

This device contains multiple transmitters that may operate simultaneously, and therefore requires a simultaneous transmission analysis according to FCC KDB Publication 447498 D01v06.

Table 13.3.1 Simultaneous Transmission Scenarios

No.	Capable TX Configuration	GSM 850/1900	GSM 850/1900	WCDMA 850 Voice	WCDMA 850 Data	LTE	WIFI 2.4/5GHz	Bluetooth 2.4GHz
1	GSM 850/1900		No	No	No	No	Yes	Yes
2	GSM 850/1900	No		No	No	No	Yes	Yes
3	WCDMA 850 Voice	No	No		No	No	Yes	Yes
4	WCDMA 850 Data	No	No	No		No	Yes	Yes
5	LTE	No	No	No	No		Yes	Yes
6	WIFI 2.4/5GHz	Yes	Yes	Yes	Yes	Yes		No
7	Bluetooth 2.4GHz	Yes	Yes	Yes	Yes	Yes	No	

Table 13.3.2 Simultaneous SAR Cases

No.	Capable Transmit Configuration	Head	Body-Worn Accessory	Wireless Router	Note
1	GSM850 Voice + 2.4/5 GHz WIFI	Yes	Yes	N/A	
2	PCS1900 Voice + 2.4/5 GHz WIFI	Yes	Yes	N/A	
3	WCDMA 850 + 2.4/5 GHz WIFI	Yes	Yes	Yes	
4	GSM850 GPRS + 2.4 GHz WIFI	Yes *	Yes *	Yes	* Pre-installed VOIP applications are considered
5	GSM1900 GPRS + 2.4 GHz WIFI	Yes *	Yes *	Yes	* Pre-installed VOIP applications are considered
6	LTE Band 17 + 2.4 GHz WIFI	Yes *	Yes *	Yes	* Pre-installed VOIP applications are considered
7	GSM850 GPRS + 5 GHz WIFI	Yes *	Yes *	N/A	* Pre-installed VOIP applications are considered
8	GSM1900 GPRS + 5 GHz WIFI	Yes *	Yes *	N/A	* Pre-installed VOIP applications are considered
9	LTE Band 17 + 5 GHz WIFI	Yes *	Yes *	N/A	* Pre-installed VOIP applications are considered
10	GSM850 Voice + Bluetooth	N/A	Yes	N/A	
11	PCS1900 Voice + Bluetooth	N/A	Yes	N/A	
12	WCDMA 850 + Bluetooth	N/A	Yes	N/A	
13	GSM850 GPRS + Bluetooth	N/A	Yes *	N/A	* Pre-installed VOIP applications are considered
14	GSM1900 GPRS + Bluetooth	N/A	Yes *	N/A	* Pre-installed VOIP applications are considered
15	LTE Band 17 + Bluetooth	N/A	Yes *	N/A	* Pre-installed VOIP applications are considered

Notes:

1. WIFI 2.4GHz is supported Hotspot.
2. GPRS, WCDMA, LTE is supported Hotspot
3. VoIP is supported(e.g. 3rd part VoIP)
4. BT&WIFI are not operated at same time

Note:

- When the user utilizes multiple services in UMTS 3G mode it uses multi-Radio Access Bearer or multi-RAB. The power control is based on a physical control channel (Dedicated Physical Control Channel [DPCCH]) and power control will be adjusted to meet the needs of both services. Therefore, the UMTS+WLAN scenario also represents the UMTS Voice/DATA + WLAN Hotspot scenario.
- Per the manufacturer, WIFI Direct is not expected to be used in conjunction with a held-to-ear or body-worn accessory voice call. Therefore, there are no simultaneous transmission scenarios involving WIFI direct beyond that listed in the above table.

13.4 Head SAR Simultaneous Transmission Analysis

Table 13.4.1 Simultaneous Transmission Scenario for GSM with 2.4 GHz W-LAN (Held to Ear)

Simult TX	Configuration	GSM850 SAR (W/kg)	2.4G W-LAN (802.11b) SAR (W/kg)	ΣSAR (W/kg)	Simult TX	Configuration	PCS1900 SAR (W/kg)	2.4G W-LAN (802.11b) SAR (W/kg)	ΣSAR (W/kg)
Head SAR	Left Touch	0.522	0.322	0.844	Head SAR	Left Touch	0.100	0.322	0.422
	Right Touch	0.563	-	0.563		Right Touch	0.166	-	0.166
	Left Tilt	0.509	-	0.509		Left Tilt	0.055	-	0.055
	Right Tilt	0.505	-	0.505		Right Tilt	0.031	-	0.031

Table 13.4.2 Simultaneous Transmission Scenario for GPRS with 2.4 GHz W-LAN (Held to Ear)

Simult TX	Configuration	GPRS 850 SAR (W/kg)	2.4G W-LAN (802.11b) SAR (W/kg)	ΣSAR (W/kg)	Simult TX	Configuration	GPRS 1900 SAR (W/kg)	2.4G W-LAN (802.11b) SAR (W/kg)	ΣSAR (W/kg)
Head SAR	Left Touch	0.686	0.322	1.008	Head SAR	Left Touch	0.131	0.322	0.453
	Right Touch	0.732	-	0.732		Right Touch	0.205	-	0.205
	Left Tilt	0.634	-	0.634		Left Tilt	0.070	-	0.070
	Right Tilt	0.627	-	0.627		Right Tilt	0.045	-	0.045

Table 13.4.3 Simultaneous Transmission Scenario for WCDMA & LTE with 2.4 GHz W-LAN (Held to Ear)

Simult TX	Configuration	WCDMA 850 SAR (W/kg)	2.4G W-LAN (802.11b) SAR (W/kg)	ΣSAR (W/kg)	Simult TX	Configuration	LTE Band 17 SAR (W/kg)	2.4G W-LAN (802.11b) SAR (W/kg)	ΣSAR (W/kg)
Head SAR	Left Touch	0.366	0.322	0.688	Head SAR	Left Touch	0.301	0.322	0.623
	Right Touch	0.437	-	0.437		Right Touch	0.377	-	0.377
	Left Tilt	0.372	-	0.372		Left Tilt	0.252	-	0.252
	Right Tilt	0.366	-	0.366		Right Tilt	0.309	-	0.309

Table 13.4.4 Simultaneous Transmission Scenario for GSM with 5 GHz W-LAN (Held to Ear)

Simult TX	Configuration	GSM850 SAR (W/kg)	5G W-LAN (802.11a) SAR (W/kg)	ΣSAR (W/kg)	Simult TX	Configuration	PCS1900 SAR (W/kg)	5G W-LAN (802.11a) SAR (W/kg)	ΣSAR (W/kg)
Head SAR	Left Touch	0.522	0.514	1.036	Head SAR	Left Touch	0.100	0.514	0.614
	Right Touch	0.563	0.396	0.959		Right Touch	0.166	0.396	0.562
	Left Tilt	0.509	0.535	1.044		Left Tilt	0.055	0.535	0.590
	Right Tilt	0.505	0.450	0.955		Right Tilt	0.031	0.450	0.481

Table 13.4.5 Simultaneous Transmission Scenario for GPRS with 5 GHz W-LAN (Held to Ear)

Simult TX	Configuration	GPRS 850 SAR (W/kg)	5G W-LAN (802.11a) SAR (W/kg)	ΣSAR (W/kg)	Simult TX	Configuration	GPRS 1900 SAR (W/kg)	5G W-LAN (802.11a) SAR (W/kg)	ΣSAR (W/kg)
Head SAR	Left Touch	0.686	0.514	1.200	Head SAR	Left Touch	0.131	0.514	0.645
	Right Touch	0.732	0.396	1.128		Right Touch	0.205	0.396	0.601
	Left Tilt	0.634	0.535	1.169		Left Tilt	0.070	0.535	0.605
	Right Tilt	0.627	0.450	1.077		Right Tilt	0.045	0.450	0.495

Table 13.4.6 Simultaneous Transmission Scenario for WCDMA & LTE with 5 GHz W-LAN (Held to Ear)

Simult TX	Configuration	WCDMA 850 SAR (W/kg)	5G W-LAN (802.11a) SAR (W/kg)	ΣSAR (W/kg)	Simult TX	Configuration	LTE Band 17 SAR (W/kg)	5G W-LAN (802.11a) SAR (W/kg)	ΣSAR (W/kg)
Head SAR	Left Touch	0.366	0.514	0.880	Head SAR	Left Touch	0.301	0.514	0.815
	Right Touch	0.437	0.396	0.833		Right Touch	0.377	0.396	0.773
	Left Tilt	0.372	0.535	0.907		Left Tilt	0.252	0.535	0.787
	Right Tilt	0.366	0.450	0.816		Right Tilt	0.309	0.450	0.759

13.5 Body-Worn Simultaneous Transmission Analysis

Table 13.5.1 Simultaneous Transmission Scenario with 2.4 GHz W-LAN (Body-Worn at 10 mm)

Configuration	Mode	2G/3G SAR (W/kg)	2.4G W-LAN (802.11b) SAR (W/kg)	ΣSAR (W/kg)
Rear Side	GSM 850	0.734	0.210	0.944
Rear Side	GPRS 850	1.004	0.210	1.214
Rear Side	PCS 1900	0.508	0.210	0.718
Rear Side	GPRS 1900	0.731	0.210	0.941
Rear Side	WCDMA 850	0.537	0.210	0.747
Rear Side	LTE Band 17	0.576	0.210	0.786

Table 13.5.2 Simultaneous Transmission Scenario with 5 GHz W-LAN (Body-Worn at 10 mm)

Configuration	Mode	2G/3G SAR (W/kg)	5G W-LAN (802.11a) SAR (W/kg)	ΣSAR (W/kg)
Rear Side	GSM 850	0.734	0.358	1.092
Rear Side	GPRS 850	1.004	0.358	1.362
Rear Side	PCS 1900	0.508	0.358	0.866
Rear Side	GPRS 1900	0.731	0.358	1.089
Rear Side	WCDMA 850	0.537	0.358	0.895
Rear Side	LTE Band 17	0.576	0.358	0.934

Table 13.5.3 Simultaneous Transmission Scenario with Bluetooth (Body-Worn at 10 mm)

Configuration	Mode	2G/3G SAR (W/kg)	Bluetooth SAR (W/kg)	ΣSAR (W/kg)
Rear Side	GSM 850	0.734	0.118	0.852
Rear Side	GPRS 850	1.004	0.118	1.122
Rear Side	PCS 1900	0.508	0.118	0.626
Rear Side	GPRS 1900	0.731	0.118	0.849
Rear Side	WCDMA 850	0.537	0.118	0.655
Rear Side	LTE Band 17	0.576	0.118	0.694

Note: Bluetooth SAR was not required to be measured per FCC KDB 447498 D01v06. Estimated SAR results were used in the above table to determine simultaneous transmission SAR test exclusion.

13.6 Hotspot SAR Simultaneous Transmission Analysis

Per FCC KDB Publication 941225 D06v02r01, the device edges with antennas more than 2.5 cm from edge are not required to be evaluated for SAR ("-").

Table 13.6.1 Simultaneous Transmission Scenario for GPRS with 2.4GHz W-LAN (Hotspot at 10 mm)

Simult TX	Configuration	GPRS 850 SAR (W/kg)	2.4G W-LAN (802.11b) SAR (W/kg)	ΣSAR (W/kg)	Simult TX	Configuration	GPRS 1900 SAR (W/kg)	2.4G W-LAN (802.11b) SAR (W/kg)	ΣSAR (W/kg)
Body SAR	Top	-	-	-	Body SAR	Top	-	-	-
	Bottom	0.175	-	0.175		Bottom	0.502	-	0.502
	Front	0.796	-	0.796		Front	0.432	-	0.432
	Rear	1.004	0.210	1.214		Rear	0.731	0.210	0.941
	Right	0.788	-	0.788		Right	0.105	-	0.105
	Left	-	-	-		Left	-	-	-

Table 13.6.2 Simultaneous Transmission Scenario for WCDMA & LTE with 2.4GHz W-LAN (Hotspot at 10 mm)

Simult TX	Configuration	WCDMA 850 SAR (W/kg)	2.4G W-LAN (802.11b) SAR (W/kg)	ΣSAR (W/kg)	Simult TX	Configuration	LTE Band 17 SAR (W/kg)	2.4G W-LAN (802.11b) SAR (W/kg)	ΣSAR (W/kg)
Body SAR	Top	-	-	-	Body SAR	Top	-	-	-
	Bottom	0.103	-	0.103		Bottom	0.081	-	0.081
	Front	0.477	-	0.477		Front	0.355	-	0.355
	Rear	0.537	0.210	0.747		Rear	0.576	0.210	0.786
	Right	0.527	-	0.527		Right	0.288	-	0.288
	Left	-	-	-		Left	-	-	-

13.7 Simultaneous Transmission Conclusion

The above numerical summed SAR results for all the worst-case simultaneous transmission conditions were below the SAR limit. Therefore, the above analysis is sufficient to determine that simultaneous transmission cases will not exceed the SAR limit and therefore no measured volumetric simultaneous SAR summation is required per FCC KDB Publication 447498 D01v06 and IEEE 1528-2013 Section 6.3.4.1.2.

14. SAR MEASUREMENT VARIABILITY

14.1 Measurement Variability

Per FCC KDB Publication 865664 D01v01r04, SAR measurement variability was assessed for each frequency band, which was determined by the SAR probe calibration point and tissue-equivalent medium used for the device measurements. When both head and body tissue-equivalent media were required for SAR measurements in a frequency band, the variability measurement procedures were applied to the tissue medium with the highest measured SAR, using the highest measured SAR configuration for that tissue-equivalent medium. These additional measurements were repeated after the completion of all measurements requiring the same head or body tissue-equivalent medium in a frequency band. The test device was returned to ambient conditions (normal room temperature) with the battery fully charged before it was re-mounted on the device holder for the repeated measurement(s) to minimize any unexpected variations in the repeated results.

SAR Measurement Variability was assessed using the following procedures for each frequency band:

1. When the original highest measured SAR is ≥ 0.80 W/kg, the measurement was repeated once.
2. A second repeated measurement was performed only if the ratio of largest to smallest SAR for the original and first repeated measurements was > 1.20 or when the original or repeated measurement was ≥ 1.45 W/kg (~ 10% from the 1-g SAR limit).
3. A third repeated measurement was performed only if the original, first or second repeated measurement was ≥ 1.5 W/kg and the ratio of largest to smallest SAR for the original, first and second repeated measurements is > 1.20 .
4. Repeated measurements are not required when the original highest measured SAR is < 0.80 W/kg

Table 14.1 Body SAR Measurement Variability Results

Frequency		Mode	Service	# of Time Slots	Spacing [Side]	Measured SAR (1g)	1st Repeated SAR(1g)	Ratio	2nd Repeated SAR(1g)	Ratio	3rd Repeated SAR(1g)	Ratio
MHz	Ch.					(W/kg)	(W/kg)		(W/kg)		(W/kg)	
824.2	128	GSM850	GPRS	2	10 mm [Rear]	0.939	0.933	1.01	-	-	-	-
ANSI / IEEE C95.1-2005– SAFETY LIMIT Spatial Peak Uncontrolled Exposure/General Population Exposure							Body 1.6 W/kg (mW/g) averaged over 1 gram					

14.2 Measurement Uncertainty

The measured SAR was < 1.5 W/kg for all frequency bands. Therefore, per KDB Publication 865664D01v01r04, the standard measurement uncertainty analysis per IEEE 1528-2013 was not required.

15. IEEE Std 1528 –MEASUREMENT UNCERTAINTIES

750 MHz Head

Error Description	Uncertainty value $\pm\%$	Probability Distribution	Divisor	(Ci) 1g	Standard (1g)	vi 2 or Veff
Measurement System						
Probe calibration	± 6.0	Normal	1	1	$\pm 6.0 \%$	∞
Axial isotropy	± 4.7	Rectangular	$\sqrt{3}$	1	$\pm 2.714 \%$	∞
Hemispherical isotropy	± 9.6	Rectangular	$\sqrt{3}$	1	$\pm 5.543 \%$	∞
Boundary Effects	± 0.8	Rectangular	$\sqrt{3}$	1	$\pm 0.462 \%$	∞
Probe Linearity	± 4.7	Rectangular	$\sqrt{3}$	1	$\pm 2.714 \%$	∞
Detection limits	± 0.25	Rectangular	$\sqrt{3}$	1	$\pm 0.145 \%$	∞
Readout Electronics	± 1.0	Normal	1	1	$\pm 1.0 \%$	∞
Response time	± 0.8	Rectangular	$\sqrt{3}$	1	$\pm 0.462 \%$	∞
Integration time	± 2.6	Rectangular	$\sqrt{3}$	1	$\pm 1.501 \%$	∞
RF Ambient Conditions	± 3.0	Rectangular	$\sqrt{3}$	1	$\pm 1.732 \%$	∞
Probe Positioner	± 0.4	Rectangular	$\sqrt{3}$	1	$\pm 0.231 \%$	∞
Probe Positioning	± 2.9	Rectangular	$\sqrt{3}$	1	$\pm 1.674 \%$	∞
Algorithms for Max. SAR Eval.	± 1.0	Rectangular	$\sqrt{3}$	1	$\pm 0.577 \%$	∞
Test Sample Related						
Device Positioning	± 2.9	Normal	1	1	$\pm 2.9 \%$	145
Device Holder	± 3.6	Normal	1	1	$\pm 3.6 \%$	5
Power Drift	± 5.0	Rectangular	$\sqrt{3}$	1	$\pm 2.887 \%$	∞
Physical Parameters						
Phantom Shell	± 4.0	Rectangular	$\sqrt{3}$	1	$\pm 2.31 \%$	∞
Liquid conductivity (Target)	± 5.0	Rectangular	$\sqrt{3}$	0.64	$\pm 2.887 \%$	∞
Liquid conductivity (Meas.)	± 3.8	Normal	1	0.64	$\pm 3.8 \%$	∞
Liquid permittivity (Target)	± 5.0	Rectangular	$\sqrt{3}$	0.6	$\pm 2.887 \%$	∞
Liquid permittivity (Meas.)	± 4.2	Normal	1	0.6	$\pm 4.2 \%$	∞
Temp. unc. - Conductivity	± 1.8	Rectangular	$\sqrt{3}$	0.78	$\pm 1.039 \%$	∞
Temp. unc. - Permittivity	± 1.5	Rectangular	$\sqrt{3}$	0.23	$\pm 0.866 \%$	∞
Combined Standard Uncertainty					$\pm 12.1 \%$	330
Expanded Uncertainty (k=2)					$\pm 24.2 \%$	

The above measurement uncertainties are according to IEEE Std 1528 (2013)

750 MHz Body

Error Description	Uncertainty value $\pm\%$	Probability Distribution	Divisor	(Ci) 1g	Standard (1g)	vi 2 or Veff
Measurement System						
Probe calibration	± 6.0	Normal	1	1	$\pm 6.0 \%$	∞
Axial isotropy	± 4.7	Rectangular	$\sqrt{3}$	1	$\pm 2.714 \%$	∞
Hemispherical isotropy	± 9.6	Rectangular	$\sqrt{3}$	1	$\pm 5.543 \%$	∞
Boundary Effects	± 0.8	Rectangular	$\sqrt{3}$	1	$\pm 0.462 \%$	∞
Probe Linearity	± 4.7	Rectangular	$\sqrt{3}$	1	$\pm 2.714 \%$	∞
Detection limits	± 0.25	Rectangular	$\sqrt{3}$	1	$\pm 0.145 \%$	∞
Readout Electronics	± 1.0	Normal	1	1	$\pm 1.0 \%$	∞
Response time	± 0.8	Rectangular	$\sqrt{3}$	1	$\pm 0.462 \%$	∞
Integration time	± 2.6	Rectangular	$\sqrt{3}$	1	$\pm 1.501 \%$	∞
RF Ambient Conditions	± 3.0	Rectangular	$\sqrt{3}$	1	$\pm 1.732 \%$	∞
Probe Positioner	± 0.4	Rectangular	$\sqrt{3}$	1	$\pm 0.231 \%$	∞
Probe Positioning	± 2.9	Rectangular	$\sqrt{3}$	1	$\pm 1.674 \%$	∞
Algorithms for Max. SAR Eval.	± 1.0	Rectangular	$\sqrt{3}$	1	$\pm 0.577 \%$	∞
Test Sample Related						
Device Positioning	± 2.9	Normal	1	1	$\pm 2.9 \%$	145
Device Holder	± 3.6	Normal	1	1	$\pm 3.6 \%$	5
Power Drift	± 5.0	Rectangular	$\sqrt{3}$	1	$\pm 2.887 \%$	∞
Physical Parameters						
Phantom Shell	± 4.0	Rectangular	$\sqrt{3}$	1	$\pm 2.31 \%$	∞
Liquid conductivity (Target)	± 5.0	Rectangular	$\sqrt{3}$	0.64	$\pm 2.887 \%$	∞
Liquid conductivity (Meas.)	± 4.1	Normal	1	0.64	$\pm 4.1 \%$	∞
Liquid permittivity (Target)	± 5.0	Rectangular	$\sqrt{3}$	0.6	$\pm 2.887 \%$	∞
Liquid permittivity (Meas.)	± 4.3	Normal	1	0.6	$\pm 4.3 \%$	∞
Temp. unc. - Conductivity	± 1.9	Rectangular	$\sqrt{3}$	0.78	$\pm 1.097 \%$	∞
Temp. unc. - Permittivity	± 1.7	Rectangular	$\sqrt{3}$	0.23	$\pm 0.981 \%$	∞
Combined Standard Uncertainty					$\pm 12.0 \%$	330
Expanded Uncertainty (k=2)					$\pm 24.0 \%$	

The above measurement uncertainties are according to IEEE Std 1528 (2013)

835 MHz Head

Error Description	Uncertainty value $\pm\%$	Probability Distribution	Divisor	(Ci) 1g	Standard (1g)	vi 2 or Veff
Measurement System						
Probe calibration	± 6.0	Normal	1	1	$\pm 6.0 \%$	∞
Axial isotropy	± 4.7	Rectangular	$\sqrt{3}$	1	$\pm 2.714 \%$	∞
Hemispherical isotropy	± 9.6	Rectangular	$\sqrt{3}$	1	$\pm 5.543 \%$	∞
Boundary Effects	± 0.8	Rectangular	$\sqrt{3}$	1	$\pm 0.462 \%$	∞
Probe Linearity	± 4.7	Rectangular	$\sqrt{3}$	1	$\pm 2.714 \%$	∞
Detection limits	± 0.25	Rectangular	$\sqrt{3}$	1	$\pm 0.145 \%$	∞
Readout Electronics	± 1.0	Normal	1	1	$\pm 1.0 \%$	∞
Response time	± 0.8	Rectangular	$\sqrt{3}$	1	$\pm 0.462 \%$	∞
Integration time	± 2.6	Rectangular	$\sqrt{3}$	1	$\pm 1.501 \%$	∞
RF Ambient Conditions	± 3.0	Rectangular	$\sqrt{3}$	1	$\pm 1.732 \%$	∞
Probe Positioner	± 0.4	Rectangular	$\sqrt{3}$	1	$\pm 0.231 \%$	∞
Probe Positioning	± 2.9	Rectangular	$\sqrt{3}$	1	$\pm 1.674 \%$	∞
Algorithms for Max. SAR Eval.	± 1.0	Rectangular	$\sqrt{3}$	1	$\pm 0.577 \%$	∞
Test Sample Related						
Device Positioning	± 2.9	Normal	1	1	$\pm 2.9 \%$	145
Device Holder	± 3.6	Normal	1	1	$\pm 3.6 \%$	5
Power Drift	± 5.0	Rectangular	$\sqrt{3}$	1	$\pm 2.887 \%$	∞
Physical Parameters						
Phantom Shell	± 4.0	Rectangular	$\sqrt{3}$	1	$\pm 2.31 \%$	∞
Liquid conductivity (Target)	± 5.0	Rectangular	$\sqrt{3}$	0.64	$\pm 2.887 \%$	∞
Liquid conductivity (Meas.)	± 4.0	Normal	1	0.64	$\pm 4.0 \%$	∞
Liquid permittivity (Target)	± 5.0	Rectangular	$\sqrt{3}$	0.6	$\pm 2.887 \%$	∞
Liquid permittivity (Meas.)	± 3.7	Normal	1	0.6	$\pm 3.7 \%$	∞
Temp. unc. - Conductivity	± 2.0	Rectangular	$\sqrt{3}$	0.78	$\pm 1.155 \%$	∞
Temp. unc. - Permittivity	± 1.7	Rectangular	$\sqrt{3}$	0.23	$\pm 0.981 \%$	∞
Combined Standard Uncertainty					$\pm 12.0 \%$	330
Expanded Uncertainty (k=2)					$\pm 24.0 \%$	

The above measurement uncertainties are according to IEEE Std 1528 (2013)

835 MHz Body

Error Description	Uncertainty value $\pm\%$	Probability Distribution	Divisor	(Ci) 1g	Standard (1g)	vi 2 or Veff
Measurement System						
Probe calibration	± 6.0	Normal	1	1	$\pm 6.0 \%$	∞
Axial isotropy	± 4.7	Rectangular	$\sqrt{3}$	1	$\pm 2.714 \%$	∞
Hemispherical isotropy	± 9.6	Rectangular	$\sqrt{3}$	1	$\pm 5.543 \%$	∞
Boundary Effects	± 0.8	Rectangular	$\sqrt{3}$	1	$\pm 0.462 \%$	∞
Probe Linearity	± 4.7	Rectangular	$\sqrt{3}$	1	$\pm 2.714 \%$	∞
Detection limits	± 0.25	Rectangular	$\sqrt{3}$	1	$\pm 0.145 \%$	∞
Readout Electronics	± 1.0	Normal	1	1	$\pm 1.0 \%$	∞
Response time	± 0.8	Rectangular	$\sqrt{3}$	1	$\pm 0.462 \%$	∞
Integration time	± 2.6	Rectangular	$\sqrt{3}$	1	$\pm 1.501 \%$	∞
RF Ambient Conditions	± 3.0	Rectangular	$\sqrt{3}$	1	$\pm 1.732 \%$	∞
Probe Positioner	± 0.4	Rectangular	$\sqrt{3}$	1	$\pm 0.231 \%$	∞
Probe Positioning	± 2.9	Rectangular	$\sqrt{3}$	1	$\pm 1.674 \%$	∞
Algorithms for Max. SAR Eval.	± 1.0	Rectangular	$\sqrt{3}$	1	$\pm 0.577 \%$	∞
Test Sample Related						
Device Positioning	± 2.9	Normal	1	1	$\pm 2.9 \%$	145
Device Holder	± 3.6	Normal	1	1	$\pm 3.6 \%$	5
Power Drift	± 5.0	Rectangular	$\sqrt{3}$	1	$\pm 2.887 \%$	∞
Physical Parameters						
Phantom Shell	± 4.0	Rectangular	$\sqrt{3}$	1	$\pm 2.31 \%$	∞
Liquid conductivity (Target)	± 5.0	Rectangular	$\sqrt{3}$	0.64	$\pm 2.887 \%$	∞
Liquid conductivity (Meas.)	± 4.1	Normal	1	0.64	$\pm 4.1 \%$	∞
Liquid permittivity (Target)	± 5.0	Rectangular	$\sqrt{3}$	0.6	$\pm 2.887 \%$	∞
Liquid permittivity (Meas.)	± 4.3	Normal	1	0.6	$\pm 4.3 \%$	∞
Temp. unc. - Conductivity	± 1.9	Rectangular	$\sqrt{3}$	0.78	$\pm 1.097 \%$	∞
Temp. unc. - Permittivity	± 1.6	Rectangular	$\sqrt{3}$	0.23	$\pm 0.924 \%$	∞
Combined Standard Uncertainty					$\pm 12.1 \%$	330
Expanded Uncertainty (k=2)					$\pm 24.2 \%$	

The above measurement uncertainties are according to IEEE Std 1528 (2013)

1900 MHz Head

Error Description	Uncertainty value $\pm\%$	Probability Distribution	Divisor	(Ci) 1g	Standard (1g)	vi 2 or Veff
Measurement System						
Probe calibration	± 6.0	Normal	1	1	$\pm 6.0 \%$	∞
Axial isotropy	± 4.7	Rectangular	$\sqrt{3}$	1	$\pm 2.714 \%$	∞
Hemispherical isotropy	± 9.6	Rectangular	$\sqrt{3}$	1	$\pm 5.543 \%$	∞
Boundary Effects	± 0.8	Rectangular	$\sqrt{3}$	1	$\pm 0.462 \%$	∞
Probe Linearity	± 4.7	Rectangular	$\sqrt{3}$	1	$\pm 2.714 \%$	∞
Detection limits	± 0.25	Rectangular	$\sqrt{3}$	1	$\pm 0.145 \%$	∞
Readout Electronics	± 1.0	Normal	1	1	$\pm 1.0 \%$	∞
Response time	± 0.8	Rectangular	$\sqrt{3}$	1	$\pm 0.462 \%$	∞
Integration time	± 2.6	Rectangular	$\sqrt{3}$	1	$\pm 1.501 \%$	∞
RF Ambient Conditions	± 3.0	Rectangular	$\sqrt{3}$	1	$\pm 1.732 \%$	∞
Probe Positioner	± 0.4	Rectangular	$\sqrt{3}$	1	$\pm 0.231 \%$	∞
Probe Positioning	± 2.9	Rectangular	$\sqrt{3}$	1	$\pm 1.674 \%$	∞
Algorithms for Max. SAR Eval.	± 1.0	Rectangular	$\sqrt{3}$	1	$\pm 0.577 \%$	∞
Test Sample Related						
Device Positioning	± 2.9	Normal	1	1	$\pm 2.9 \%$	145
Device Holder	± 3.6	Normal	1	1	$\pm 3.6 \%$	5
Power Drift	± 5.0	Rectangular	$\sqrt{3}$	1	$\pm 2.887 \%$	∞
Physical Parameters						
Phantom Shell	± 4.0	Rectangular	$\sqrt{3}$	1	$\pm 2.31 \%$	∞
Liquid conductivity (Target)	± 5.0	Rectangular	$\sqrt{3}$	0.64	$\pm 2.887 \%$	∞
Liquid conductivity (Meas.)	± 3.7	Normal	1	0.64	$\pm 3.7 \%$	∞
Liquid permittivity (Target)	± 5.0	Rectangular	$\sqrt{3}$	0.6	$\pm 2.887 \%$	∞
Liquid permittivity (Meas.)	± 4.1	Normal	1	0.6	$\pm 4.1 \%$	∞
Temp. unc. - Conductivity	± 1.8	Rectangular	$\sqrt{3}$	0.78	$\pm 1.039 \%$	∞
Temp. unc. - Permittivity	± 1.6	Rectangular	$\sqrt{3}$	0.23	$\pm 0.924 \%$	∞
Combined Standard Uncertainty					$\pm 12.0 \%$	330
Expanded Uncertainty (k=2)					$\pm 24.0 \%$	

The above measurement uncertainties are according to IEEE Std 1528 (2013)

1900 MHz Body

Error Description	Uncertainty value $\pm\%$	Probability Distribution	Divisor	(Ci) 1g	Standard (1g)	vi 2 or Veff
Measurement System						
Probe calibration	± 6.0	Normal	1	1	$\pm 6.0 \%$	∞
Axial isotropy	± 4.7	Rectangular	$\sqrt{3}$	1	$\pm 2.714 \%$	∞
Hemispherical isotropy	± 9.6	Rectangular	$\sqrt{3}$	1	$\pm 5.543 \%$	∞
Boundary Effects	± 0.8	Rectangular	$\sqrt{3}$	1	$\pm 0.462 \%$	∞
Probe Linearity	± 4.7	Rectangular	$\sqrt{3}$	1	$\pm 2.714 \%$	∞
Detection limits	± 0.25	Rectangular	$\sqrt{3}$	1	$\pm 0.145 \%$	∞
Readout Electronics	± 1.0	Normal	1	1	$\pm 1.0 \%$	∞
Response time	± 0.8	Rectangular	$\sqrt{3}$	1	$\pm 0.462 \%$	∞
Integration time	± 2.6	Rectangular	$\sqrt{3}$	1	$\pm 1.501 \%$	∞
RF Ambient Conditions	± 3.0	Rectangular	$\sqrt{3}$	1	$\pm 1.732 \%$	∞
Probe Positioner	± 0.4	Rectangular	$\sqrt{3}$	1	$\pm 0.231 \%$	∞
Probe Positioning	± 2.9	Rectangular	$\sqrt{3}$	1	$\pm 1.674 \%$	∞
Algorithms for Max. SAR Eval.	± 1.0	Rectangular	$\sqrt{3}$	1	$\pm 0.577 \%$	∞
Test Sample Related						
Device Positioning	± 2.9	Normal	1	1	$\pm 2.9 \%$	145
Device Holder	± 3.6	Normal	1	1	$\pm 3.6 \%$	5
Power Drift	± 5.0	Rectangular	$\sqrt{3}$	1	$\pm 2.887 \%$	∞
Physical Parameters						
Phantom Shell	± 4.0	Rectangular	$\sqrt{3}$	1	$\pm 2.31 \%$	∞
Liquid conductivity (Target)	± 5.0	Rectangular	$\sqrt{3}$	0.64	$\pm 2.887 \%$	∞
Liquid conductivity (Meas.)	± 4.2	Normal	1	0.64	$\pm 4.2 \%$	∞
Liquid permittivity (Target)	± 5.0	Rectangular	$\sqrt{3}$	0.6	$\pm 2.887 \%$	∞
Liquid permittivity (Meas.)	± 3.9	Normal	1	0.6	$\pm 3.9 \%$	∞
Temp. unc. - Conductivity	± 1.8	Rectangular	$\sqrt{3}$	0.78	$\pm 1.039 \%$	∞
Temp. unc. - Permittivity	± 1.7	Rectangular	$\sqrt{3}$	0.23	$\pm 0.981 \%$	∞
Combined Standard Uncertainty					$\pm 12.1 \%$	330
Expanded Uncertainty (k=2)					$\pm 24.2 \%$	

The above measurement uncertainties are according to IEEE Std 1528 (2013)

2450 MHz Head

Error Description	Uncertainty value $\pm\%$	Probability Distribution	Divisor	(Ci) 1g	Standard (1g)	vi 2 or Veff
Measurement System						
Probe calibration	± 6.0	Normal	1	1	$\pm 6.0 \%$	∞
Axial isotropy	± 4.7	Rectangular	$\sqrt{3}$	1	$\pm 2.714 \%$	∞
Hemispherical isotropy	± 9.6	Rectangular	$\sqrt{3}$	1	$\pm 5.543 \%$	∞
Boundary Effects	± 0.8	Rectangular	$\sqrt{3}$	1	$\pm 0.462 \%$	∞
Probe Linearity	± 4.7	Rectangular	$\sqrt{3}$	1	$\pm 2.714 \%$	∞
Detection limits	± 0.25	Rectangular	$\sqrt{3}$	1	$\pm 0.145 \%$	∞
Readout Electronics	± 1.0	Normal	1	1	$\pm 1.0 \%$	∞
Response time	± 0.8	Rectangular	$\sqrt{3}$	1	$\pm 0.462 \%$	∞
Integration time	± 2.6	Rectangular	$\sqrt{3}$	1	$\pm 1.501 \%$	∞
RF Ambient Conditions	± 3.0	Rectangular	$\sqrt{3}$	1	$\pm 1.732 \%$	∞
Probe Positioner	± 0.4	Rectangular	$\sqrt{3}$	1	$\pm 0.231 \%$	∞
Probe Positioning	± 2.9	Rectangular	$\sqrt{3}$	1	$\pm 1.674 \%$	∞
Algorithms for Max. SAR Eval.	± 1.0	Rectangular	$\sqrt{3}$	1	$\pm 0.577 \%$	∞
Test Sample Related						
Device Positioning	± 2.9	Normal	1	1	$\pm 2.9 \%$	145
Device Holder	± 3.6	Normal	1	1	$\pm 3.6 \%$	5
Power Drift	± 5.0	Rectangular	$\sqrt{3}$	1	$\pm 2.887 \%$	∞
Physical Parameters						
Phantom Shell	± 4.0	Rectangular	$\sqrt{3}$	1	$\pm 2.31 \%$	∞
Liquid conductivity (Target)	± 5.0	Rectangular	$\sqrt{3}$	0.64	$\pm 2.887 \%$	∞
Liquid conductivity (Meas.)	± 3.8	Normal	1	0.64	$\pm 3.8 \%$	∞
Liquid permittivity (Target)	± 5.0	Rectangular	$\sqrt{3}$	0.6	$\pm 2.887 \%$	∞
Liquid permittivity (Meas.)	± 4.2	Normal	1	0.6	$\pm 4.2 \%$	∞
Temp. unc. - Conductivity	± 2.0	Rectangular	$\sqrt{3}$	0.78	$\pm 1.155 \%$	∞
Temp. unc. - Permittivity	± 1.7	Rectangular	$\sqrt{3}$	0.23	$\pm 0.981 \%$	∞
Combined Standard Uncertainty					$\pm 12.1 \%$	330
Expanded Uncertainty (k=2)					$\pm 24.2 \%$	

The above measurement uncertainties are according to IEEE Std 1528 (2013)

2450 MHz Body

Error Description	Uncertainty value $\pm\%$	Probability Distribution	Divisor	(Ci) 1g	Standard (1g)	vi 2 or Veff
Measurement System						
Probe calibration	± 6.0	Normal	1	1	$\pm 6.0 \%$	∞
Axial isotropy	± 4.7	Rectangular	$\sqrt{3}$	1	$\pm 2.714 \%$	∞
Hemispherical isotropy	± 9.6	Rectangular	$\sqrt{3}$	1	$\pm 5.543 \%$	∞
Boundary Effects	± 0.8	Rectangular	$\sqrt{3}$	1	$\pm 0.462 \%$	∞
Probe Linearity	± 4.7	Rectangular	$\sqrt{3}$	1	$\pm 2.714 \%$	∞
Detection limits	± 0.25	Rectangular	$\sqrt{3}$	1	$\pm 0.145 \%$	∞
Readout Electronics	± 1.0	Normal	1	1	$\pm 1.0 \%$	∞
Response time	± 0.8	Rectangular	$\sqrt{3}$	1	$\pm 0.462 \%$	∞
Integration time	± 2.6	Rectangular	$\sqrt{3}$	1	$\pm 1.501 \%$	∞
RF Ambient Conditions	± 3.0	Rectangular	$\sqrt{3}$	1	$\pm 1.732 \%$	∞
Probe Positioner	± 0.4	Rectangular	$\sqrt{3}$	1	$\pm 0.231 \%$	∞
Probe Positioning	± 2.9	Rectangular	$\sqrt{3}$	1	$\pm 1.674 \%$	∞
Algorithms for Max. SAR Eval.	± 1.0	Rectangular	$\sqrt{3}$	1	$\pm 0.577 \%$	∞
Test Sample Related						
Device Positioning	± 2.9	Normal	1	1	$\pm 2.9 \%$	145
Device Holder	± 3.6	Normal	1	1	$\pm 3.6 \%$	5
Power Drift	± 5.0	Rectangular	$\sqrt{3}$	1	$\pm 2.887 \%$	∞
Physical Parameters						
Phantom Shell	± 4.0	Rectangular	$\sqrt{3}$	1	$\pm 2.31 \%$	∞
Liquid conductivity (Target)	± 5.0	Rectangular	$\sqrt{3}$	0.64	$\pm 2.887 \%$	∞
Liquid conductivity (Meas.)	± 3.9	Normal	1	0.64	$\pm 3.9 \%$	∞
Liquid permittivity (Target)	± 5.0	Rectangular	$\sqrt{3}$	0.6	$\pm 2.887 \%$	∞
Liquid permittivity (Meas.)	± 4.6	Normal	1	0.6	$\pm 4.6 \%$	∞
Temp. unc. - Conductivity	± 1.9	Rectangular	$\sqrt{3}$	0.78	$\pm 1.097 \%$	∞
Temp. unc. - Permittivity	± 1.7	Rectangular	$\sqrt{3}$	0.23	$\pm 0.981 \%$	∞
Combined Standard Uncertainty					$\pm 12.1 \%$	330
Expanded Uncertainty (k=2)					$\pm 24.2 \%$	

The above measurement uncertainties are according to IEEE Std 1528 (2013)

5300 MHz Head

Error Description	Uncertainty value $\pm\%$	Probability Distribution	Divisor	(Ci) 1g	Standard (1g)	vi 2 or Veff
Measurement System						
Probe calibration	± 6.55	Normal	1	1	$\pm 6.55 \%$	∞
Axial isotropy	± 4.7	Rectangular	$\sqrt{3}$	1	$\pm 2.714 \%$	∞
Hemispherical isotropy	± 9.6	Rectangular	$\sqrt{3}$	1	$\pm 5.543 \%$	∞
Boundary Effects	± 0.8	Rectangular	$\sqrt{3}$	1	$\pm 0.462 \%$	∞
Probe Linearity	± 4.7	Rectangular	$\sqrt{3}$	1	$\pm 2.714 \%$	∞
Detection limits	± 0.25	Rectangular	$\sqrt{3}$	1	$\pm 0.145 \%$	∞
Readout Electronics	± 1.0	Normal	1	1	$\pm 1.0 \%$	∞
Response time	± 0.8	Rectangular	$\sqrt{3}$	1	$\pm 0.462 \%$	∞
Integration time	± 2.6	Rectangular	$\sqrt{3}$	1	$\pm 1.501 \%$	∞
RF Ambient Conditions	± 3.0	Rectangular	$\sqrt{3}$	1	$\pm 1.732 \%$	∞
Probe Positioner	± 0.4	Rectangular	$\sqrt{3}$	1	$\pm 0.231 \%$	∞
Probe Positioning	± 2.9	Rectangular	$\sqrt{3}$	1	$\pm 1.674 \%$	∞
Algorithms for Max. SAR Eval.	± 1.0	Rectangular	$\sqrt{3}$	1	$\pm 0.577 \%$	∞
Test Sample Related						
Device Positioning	± 2.9	Normal	1	1	$\pm 2.9 \%$	145
Device Holder	± 3.6	Normal	1	1	$\pm 3.6 \%$	5
Power Drift	± 5.0	Rectangular	$\sqrt{3}$	1	$\pm 2.887 \%$	∞
Physical Parameters						
Phantom Shell	± 4.0	Rectangular	$\sqrt{3}$	1	$\pm 2.31 \%$	∞
Liquid conductivity (Target)	± 5.0	Rectangular	$\sqrt{3}$	0.64	$\pm 2.887 \%$	∞
Liquid conductivity (Meas.)	± 4.5	Normal	1	0.64	$\pm 4.5 \%$	∞
Liquid permittivity (Target)	± 5.0	Rectangular	$\sqrt{3}$	0.6	$\pm 2.887 \%$	∞
Liquid permittivity (Meas.)	± 4.0	Normal	1	0.6	$\pm 4.0 \%$	∞
Temp. unc. - Conductivity	± 2.1	Rectangular	$\sqrt{3}$	0.78	$\pm 1.212 \%$	∞
Temp. unc. - Permittivity	± 1.9	Rectangular	$\sqrt{3}$	0.23	$\pm 1.097 \%$	∞
Combined Standard Uncertainty					$\pm 12.4 \%$	330
Expanded Uncertainty (k=2)					$\pm 24.8\%$	

The above measurement uncertainties are according to IEEE P1528 (2013)

5300 MHz Body

Error Description	Uncertainty value $\pm\%$	Probability Distribution	Divisor	(Ci) 1g	Standard (1g)	vi 2 or Veff
Measurement System						
Probe calibration	± 6.55	Normal	1	1	$\pm 6.55 \%$	∞
Axial isotropy	± 4.7	Rectangular	$\sqrt{3}$	1	$\pm 2.714 \%$	∞
Hemispherical isotropy	± 9.6	Rectangular	$\sqrt{3}$	1	$\pm 5.543 \%$	∞
Boundary Effects	± 0.8	Rectangular	$\sqrt{3}$	1	$\pm 0.462 \%$	∞
Probe Linearity	± 4.7	Rectangular	$\sqrt{3}$	1	$\pm 2.714 \%$	∞
Detection limits	± 0.25	Rectangular	$\sqrt{3}$	1	$\pm 0.145 \%$	∞
Readout Electronics	± 1.0	Normal	1	1	$\pm 1.0 \%$	∞
Response time	± 0.8	Rectangular	$\sqrt{3}$	1	$\pm 0.462 \%$	∞
Integration time	± 2.6	Rectangular	$\sqrt{3}$	1	$\pm 1.501 \%$	∞
RF Ambient Conditions	± 3.0	Rectangular	$\sqrt{3}$	1	$\pm 1.732 \%$	∞
Probe Positioner	± 0.4	Rectangular	$\sqrt{3}$	1	$\pm 0.231 \%$	∞
Probe Positioning	± 2.9	Rectangular	$\sqrt{3}$	1	$\pm 1.674 \%$	∞
Algorithms for Max. SAR Eval.	± 1.0	Rectangular	$\sqrt{3}$	1	$\pm 0.577 \%$	∞
Test Sample Related						
Device Positioning	± 2.9	Normal	1	1	$\pm 2.9 \%$	145
Device Holder	± 3.6	Normal	1	1	$\pm 3.6 \%$	5
Power Drift	± 5.0	Rectangular	$\sqrt{3}$	1	$\pm 2.887 \%$	∞
Physical Parameters						
Phantom Shell	± 4.0	Rectangular	$\sqrt{3}$	1	$\pm 2.31 \%$	∞
Liquid conductivity (Target)	± 5.0	Rectangular	$\sqrt{3}$	0.64	$\pm 2.887 \%$	∞
Liquid conductivity (Meas.)	± 3.9	Normal	1	0.64	$\pm 3.9 \%$	∞
Liquid permittivity (Target)	± 5.0	Rectangular	$\sqrt{3}$	0.6	$\pm 2.887 \%$	∞
Liquid permittivity (Meas.)	± 4.2	Normal	1	0.6	$\pm 4.2 \%$	∞
Temp. unc. - Conductivity	± 2.0	Rectangular	$\sqrt{3}$	0.78	$\pm 1.155 \%$	∞
Temp. unc. - Permittivity	± 1.6	Rectangular	$\sqrt{3}$	0.23	$\pm 0.924 \%$	∞
Combined Standard Uncertainty					$\pm 12.4 \%$	330
Expanded Uncertainty (k=2)					$\pm 24.8\%$	

The above measurement uncertainties are according to IEEE P1528 (2013)

5600 MHz Head

Error Description	Uncertainty value $\pm\%$	Probability Distribution	Divisor	(Ci) 1g	Standard (1g)	vi 2 or Veff
Measurement System						
Probe calibration	± 6.55	Normal	1	1	$\pm 6.55 \%$	∞
Axial isotropy	± 4.7	Rectangular	$\sqrt{3}$	1	$\pm 2.714 \%$	∞
Hemispherical isotropy	± 9.6	Rectangular	$\sqrt{3}$	1	$\pm 5.543 \%$	∞
Boundary Effects	± 0.8	Rectangular	$\sqrt{3}$	1	$\pm 0.462 \%$	∞
Probe Linearity	± 4.7	Rectangular	$\sqrt{3}$	1	$\pm 2.714 \%$	∞
Detection limits	± 0.25	Rectangular	$\sqrt{3}$	1	$\pm 0.145 \%$	∞
Readout Electronics	± 1.0	Normal	1	1	$\pm 1.0 \%$	∞
Response time	± 0.8	Rectangular	$\sqrt{3}$	1	$\pm 0.462 \%$	∞
Integration time	± 2.6	Rectangular	$\sqrt{3}$	1	$\pm 1.501 \%$	∞
RF Ambient Conditions	± 3.0	Rectangular	$\sqrt{3}$	1	$\pm 1.732 \%$	∞
Probe Positioner	± 0.4	Rectangular	$\sqrt{3}$	1	$\pm 0.231 \%$	∞
Probe Positioning	± 2.9	Rectangular	$\sqrt{3}$	1	$\pm 1.674 \%$	∞
Algorithms for Max. SAR Eval.	± 1.0	Rectangular	$\sqrt{3}$	1	$\pm 0.577 \%$	∞
Test Sample Related						
Device Positioning	± 2.9	Normal	1	1	$\pm 2.9 \%$	145
Device Holder	± 3.6	Normal	1	1	$\pm 3.6 \%$	5
Power Drift	± 5.0	Rectangular	$\sqrt{3}$	1	$\pm 2.887 \%$	∞
Physical Parameters						
Phantom Shell	± 4.0	Rectangular	$\sqrt{3}$	1	$\pm 2.31 \%$	∞
Liquid conductivity (Target)	± 5.0	Rectangular	$\sqrt{3}$	0.64	$\pm 2.887 \%$	∞
Liquid conductivity (Meas.)	± 4.5	Normal	1	0.64	$\pm 4.5 \%$	∞
Liquid permittivity (Target)	± 5.0	Rectangular	$\sqrt{3}$	0.6	$\pm 2.887 \%$	∞
Liquid permittivity (Meas.)	± 3.7	Normal	1	0.6	$\pm 3.7 \%$	∞
Temp. unc. - Conductivity	± 2.0	Rectangular	$\sqrt{3}$	0.78	$\pm 1.155 \%$	∞
Temp. unc. - Permittivity	± 1.9	Rectangular	$\sqrt{3}$	0.23	$\pm 1.097 \%$	∞
Combined Standard Uncertainty					$\pm 12.4 \%$	330
Expanded Uncertainty (k=2)					$\pm 24.8\%$	

The above measurement uncertainties are according to IEEE P1528 (2013)

5600 MHz Body

Error Description	Uncertainty value $\pm\%$	Probability Distribution	Divisor	(Ci) 1g	Standard (1g)	vi 2 or Veff
Measurement System						
Probe calibration	± 6.55	Normal	1	1	$\pm 6.55 \%$	∞
Axial isotropy	± 4.7	Rectangular	$\sqrt{3}$	1	$\pm 2.714 \%$	∞
Hemispherical isotropy	± 9.6	Rectangular	$\sqrt{3}$	1	$\pm 5.543 \%$	∞
Boundary Effects	± 0.8	Rectangular	$\sqrt{3}$	1	$\pm 0.462 \%$	∞
Probe Linearity	± 4.7	Rectangular	$\sqrt{3}$	1	$\pm 2.714 \%$	∞
Detection limits	± 0.25	Rectangular	$\sqrt{3}$	1	$\pm 0.145 \%$	∞
Readout Electronics	± 1.0	Normal	1	1	$\pm 1.0 \%$	∞
Response time	± 0.8	Rectangular	$\sqrt{3}$	1	$\pm 0.462 \%$	∞
Integration time	± 2.6	Rectangular	$\sqrt{3}$	1	$\pm 1.501 \%$	∞
RF Ambient Conditions	± 3.0	Rectangular	$\sqrt{3}$	1	$\pm 1.732 \%$	∞
Probe Positioner	± 0.4	Rectangular	$\sqrt{3}$	1	$\pm 0.231 \%$	∞
Probe Positioning	± 2.9	Rectangular	$\sqrt{3}$	1	$\pm 1.674 \%$	∞
Algorithms for Max. SAR Eval.	± 1.0	Rectangular	$\sqrt{3}$	1	$\pm 0.577 \%$	∞
Test Sample Related						
Device Positioning	± 2.9	Normal	1	1	$\pm 2.9 \%$	145
Device Holder	± 3.6	Normal	1	1	$\pm 3.6 \%$	5
Power Drift	± 5.0	Rectangular	$\sqrt{3}$	1	$\pm 2.887 \%$	∞
Physical Parameters						
Phantom Shell	± 4.0	Rectangular	$\sqrt{3}$	1	$\pm 2.31 \%$	∞
Liquid conductivity (Target)	± 5.0	Rectangular	$\sqrt{3}$	0.64	$\pm 2.887 \%$	∞
Liquid conductivity (Meas.)	± 4.0	Normal	1	0.64	$\pm 4.0 \%$	∞
Liquid permittivity (Target)	± 5.0	Rectangular	$\sqrt{3}$	0.6	$\pm 2.887 \%$	∞
Liquid permittivity (Meas.)	± 4.4	Normal	1	0.6	$\pm 4.4 \%$	∞
Temp. unc. - Conductivity	± 1.7	Rectangular	$\sqrt{3}$	0.78	$\pm 0.981 \%$	∞
Temp. unc. - Permittivity	± 1.5	Rectangular	$\sqrt{3}$	0.23	$\pm 0.866 \%$	∞
Combined Standard Uncertainty					$\pm 12.4 \%$	330
Expanded Uncertainty (k=2)					$\pm 24.8 \%$	

The above measurement uncertainties are according to IEEE P1528 (2013)

16. CONCLUSION

Measurement Conclusion

The SAR measurement indicates that the EUT complies with the RF radiation exposure limits of the FCC. These measurements are taken to simulate the RF effects exposure under the worst-case conditions. Precise laboratory measures were taken to assure repeatability of the tests. The tested device complies with the requirements in respect to all parameters subject to the test. The test results and statements relate only to the item(s) tested.

Please note that the absorption and distribution of electromagnetic energy in the body are every complex phenomena that depend on the mass, shape, and size of the body, the orientation of the body with respect to the field vectors, and the electrical properties of both the body and the environment. Other variables that may play a substantial role impossible biological effect are those that characterize the environment (e.g. ambient temperature, air velocity, relative humidity, and body insulation) and those that characterize the individual (e.g. age, gender, activity level, debilitation, or disease).

Because innumerable factors may interact to determine the specific biological outcome of an exposure to electromagnetic fields, any protection guide shall consider maximal amplification of biological effects as a result of field-body interactions, environmental conditions, and physiological variables.

17. REFERENCES

- [1] Federal Communications Commission, ET Docket 93-62, Guidelines for Evaluating the Environmental Effects of Radiofrequency Radiation, Aug. 1996.
- [2] ANSI/IEEE C95.1-2005, American National Standard safety levels with respect to human exposure to radiofrequency electromagnetic fields, 3kHz to 300GHz, New York: IEEE, 2006.
- [3] ANSI/IEEE C95.1-1992, American National Standard safety levels with respect to human exposure to radiofrequency electromagnetic fields, 3kHz to 300GHz, New York: IEEE, Sept. 1992.
- [4] ANSI/IEEE C95.3-2002, IEEE Recommended Practice for the Measurement of Potentially Hazardous Electromagnetic Fields - RF and Microwave, New York: IEEE, December 2002.
- [5] IEEE Standards Coordinating Committee 39 –Standards Coordinating Committee 34 – IEEE Std. 1528-2003, Recommended Practice for Determining the Peak Spatial-Average Specific Absorption Rate (SAR) in the Human Body Due to Wireless Communications Devices.
- [6] NCRP, National Council on Radiation Protection and Measurements, Biological Effects and Exposure Criteria for Radio Frequency Electromagnetic Fields, NCRP Report No. 86, 1986. Reprinted Feb. 1995.
- [7] T. Schmid, O. Egger, N. Kuster, Automated E-field scanning system for dosimetric assessments, IEEE Transaction on Microwave Theory and Techniques, vol. 44, Jan. 1996, pp. 105-113.
- [8] K. Pokovic, T. Schmid, N. Kuster, Robust setup for precise calibration of E-field probes in tissue simulating liquids at mobile communications frequencies, ICECOM97, Oct. 1997, pp. -124.
- [9] K. Pokovic, T. Schmid, and N. Kuster, E-field Probe with improved isotropy in brain simulating liquids, Proceedings of the ELMAR, Zadar, Croatia, June 23-25, 1996, pp. 172-175.
- [10] Schmid & Partner Engineering AG, Application Note: Data Storage and Evaluation, June 1998, p2.
- [11] V. Hombach, K. Meier, M. Burkhardt, E. Kuhn, N. Kuster, The Dependence of EM Energy Absorption upon Human Modeling at 900 MHz, IEEE Transaction on Microwave Theory and Techniques, vol. 44 no. 10, Oct. 1996, pp. 1865-1873.
- [12] N. Kuster and Q. Balzano, Energy absorption mechanism by biological bodies in the near field of dipole antennas above 300MHz, IEEE Transaction on Vehicular Technology, vol. 41, no. 1, Feb. 1992, pp. 17-23.
- [13] G. Hartsgrrove, A. Kraszewski, A. Surowiec, Simulated Biological Materials for Electromagnetic Radiation Absorption Studies, University of Ottawa, Bio electromagnetics, Canada: 1987, pp. 29-36.
- [14] Q. Balzano, O. Garay, T. Manning Jr., Electromagnetic Energy Exposure of Simulated Users of Portable Cellular Telephones, IEEE Transactions on Vehicular Technology, vol. 44, no.3, Aug. 1995.
- [15] W. Gander, Computer mathematick, Birkhaeuser, Basel, 1992.
- [16] W.H. Press, S.A. Teukolsky, W.T. Vetterling, and B.P. Flannery, Numerical Recipes in C, The Art of Scientific Computing, Second edition, Cambridge University Press, 1992.
- [17] N. Kuster, R. Kastle, T. Schmid, Dosimetric evaluation of mobile communications equipment with known precision, IEEE Transaction on Communications, vol. E80-B, no. 5, May 1997, pp. 645-652.
- [18] CENELEC CLC/SC111B, European Prestandard (prENV 50166-2), Human Exposure to Electromagnetic Fields High-frequency: 10kHz-300GHz, Jan. 1995.
- [19] Prof. Dr. Niels Kuster, ETH, Eidgenössische Technische Hochschule Zürich, Dosimetric Evaluation of the Cellular Phone.

- [20] IEC 62209-1, Human exposure to radio frequency fields from hand-held and body-mounted wireless communication devices - Human models, instrumentation, and procedures - Part 1: Procedure to determine the specific absorption rate (SAR) for hand-held devices used in close proximity to the ear (frequency range of 300MHz to 3 GHz), Feb. 2005.
- [21] Industry Canada RSS-102 Radio Frequency Exposure Compliance of Radio communication Apparatus (All Frequency Bands) Issue 4, March 2010.
- [22] Health Canada Safety Code 6 Limits of Human Exposure to Radio Frequency Electromagnetic Fields in the Frequency Range from 3 kHz – 300 GHz, 2009
- [23] FCC SAR Test Procedures for 2G-3G Devices, Mobile Hotspot and UMPC Devices KDB Publications 941225,D01-D07
- [24] SAR Measurement procedures for IEEE 802.11a/b/g KDB Publication 248227 D01v02
- [25] FCC SAR Considerations for Handsets with Multiple Transmitters and Antennas, KDB Publications 648474D02-D04
- [26] FCC SAR Evaluation Considerations for Laptop, Notebook, Netbook and Tablet Computers, FCC KDB Publication 616217 D04
- [27] FCC SAR Measurement and Reporting Requirements for 100MHz – 6 GHz, KDB Publications 865664 D01-D02
- [28] FCC General RF Exposure Guidance and SAR Procedures for Dongles, KDB Publication 447498, D01-D02
- [29] 615223 D01 802 16e WI-Max SAR Guidance v01, Nov. 13, 2009
- [30] Anexo à Resolução No. 533, de 10 de September de 2009.
- [31] IEC 62209-2, Human exposure to radio frequency fields from hand-held and body-mounted wireless communication devices - Human models, instrumentation, and procedures - Part 2: Procedure to determine the specific absorption rate (SAR) for wireless communication devices used in close proximity to the human body(frequency range of 30 MHz to 6 GHz), Mar. 2010.

Attachment 1. – Probe Calibration Data

**Calibration Laboratory of
Schmid & Partner
Engineering AG**
Zeughausstrasse 43, 8004 Zurich, Switzerland



S Schweizerischer Kalibrierdienst
C Service suisse d'étalonnage
S Servizio svizzero di taratura
S Swiss Calibration Service

Accredited by the Swiss Accreditation Service (SAS)
The Swiss Accreditation Service is one of the signatories to the EA
Multilateral Agreement for the recognition of calibration certificates

Accreditation No.: **SCS 0108**



Client **DT&C (Dymstec)**

Certificate No: **EX3-3933_Sep16**

CALIBRATION CERTIFICATE

Object	EX3DV4 - SN:3933
Calibration procedure(s)	QA CAL-01.v9, QA CAL-14.v4, QA CAL-23.v5, QA CAL-25.v6 Calibration procedure for dosimetric E-field probes
Calibration date:	September 27, 2016
<p>This calibration certificate documents the traceability to national standards, which realize the physical units of measurements (SI). The measurements and the uncertainties with confidence probability are given on the following pages and are part of the certificate.</p> <p>All calibrations have been conducted in the closed laboratory facility: environment temperature (22 ± 3)°C and humidity < 70%.</p> <p>Calibration Equipment used (M&TE critical for calibration)</p>	

Primary Standards	ID	Cal Date (Certificate No.)	Scheduled Calibration
Power meter NRP	SN: 104778	06-Apr-16 (No. 217-02288/02289)	Apr-17
Power sensor NRP-Z91	SN: 103244	06-Apr-16 (No. 217-02288)	Apr-17
Power sensor NRP-Z91	SN: 103245	06-Apr-16 (No. 217-02289)	Apr-17
Reference 20 dB Attenuator	SN: S5277 (20x)	05-Apr-16 (No. 217-02293)	Apr-17
Reference Probe ES3DV2	SN: 3013	31-Dec-15 (No. ES3-3013_Dec15)	Dec-16
DAE4	SN: 660	23-Dec-15 (No. DAE4-660_Dec15)	Dec-16
Secondary Standards	ID	Check Date (in house)	Scheduled Check
Power meter E4419B	SN: GB41293874	06-Apr-16 (in house check Jun-16)	In house check: Jun-18
Power sensor E4412A	SN: MY41498087	06-Apr-16 (in house check Jun-16)	In house check: Jun-18
Power sensor E4412A	SN: 000110210	06-Apr-16 (in house check Jun-16)	In house check: Jun-18
RF generator HP 8648C	SN: US3642U01700	04-Aug-99 (in house check Jun-16)	In house check: Jun-18
Network Analyzer HP 8753E	SN: US37390585	18-Oct-01 (in house check Oct-15)	In house check: Oct-16

Calibrated by:	Name Leif Klysner	Function Laboratory Technician	Signature 
Approved by:	Name Katja Pokovic	Technical Manager	
			Issued: September 29, 2016
<p>This calibration certificate shall not be reproduced except in full without written approval of the laboratory.</p>			

Calibration Laboratory of
 Schmid & Partner
 Engineering AG
 Zeughausstrasse 43, 8004 Zurich, Switzerland



S Schweizerischer Kalibrierdienst
C Service suisse d'étalonnage
S Servizio svizzero di taratura
 Swiss Calibration Service

Accredited by the Swiss Accreditation Service (SAS)
 The Swiss Accreditation Service is one of the signatories to the EA
 Multilateral Agreement for the recognition of calibration certificates

Accreditation No.: **SCS 0108**

Glossary:

TSL	tissue simulating liquid
NORM _{x,y,z}	sensitivity in free space
ConvF	sensitivity in TSL / NORM _{x,y,z}
DCP	diode compression point
CF	crest factor (1/duty_cycle) of the RF signal
A, B, C, D	modulation dependent linearization parameters
Polarization ϕ	ϕ rotation around probe axis
Polarization ϑ	ϑ rotation around an axis that is in the plane normal to probe axis (at measurement center), i.e., $\vartheta = 0$ is normal to probe axis
Connector Angle	information used in DASY system to align probe sensor X to the robot coordinate system

Calibration is Performed According to the Following Standards:

- IEEE Std 1528-2013, "IEEE Recommended Practice for Determining the Peak Spatial-Averaged Specific Absorption Rate (SAR) in the Human Head from Wireless Communications Devices: Measurement Techniques", June 2013
- IEC 62209-1, "Procedure to measure the Specific Absorption Rate (SAR) for hand-held devices used in close proximity to the ear (frequency range of 300 MHz to 3 GHz)", February 2005
- IEC 62209-2, "Procedure to determine the Specific Absorption Rate (SAR) for wireless communication devices used in close proximity to the human body (frequency range of 30 MHz to 6 GHz)", March 2010
- KDB 865664, "SAR Measurement Requirements for 100 MHz to 6 GHz"

Methods Applied and Interpretation of Parameters:

- NORM_{x,y,z}**: Assessed for E-field polarization $\vartheta = 0$ ($f \leq 900$ MHz in TEM-cell; $f > 1800$ MHz: R22 waveguide). NORM_{x,y,z} are only intermediate values, i.e., the uncertainties of NORM_{x,y,z} does not affect the E²-field uncertainty inside TSL (see below ConvF).
- NORM(f)_{x,y,z}** = NORM_{x,y,z} * frequency_response (see Frequency Response Chart). This linearization is implemented in DASY4 software versions later than 4.2. The uncertainty of the frequency response is included in the stated uncertainty of ConvF.
- DCP_{x,y,z}**: DCP are numerical linearization parameters assessed based on the data of power sweep with CW signal (no uncertainty required). DCP does not depend on frequency nor media.
- PAR**: PAR is the Peak to Average Ratio that is not calibrated but determined based on the signal characteristics
- A_{x,y,z}; B_{x,y,z}; C_{x,y,z}; D_{x,y,z}; VR_{x,y,z}**: A, B, C, D are numerical linearization parameters assessed based on the data of power sweep for specific modulation signal. The parameters do not depend on frequency nor media. VR is the maximum calibration range expressed in RMS voltage across the diode.
- ConvF and Boundary Effect Parameters**: Assessed in flat phantom using E-field (or Temperature Transfer Standard for $f \leq 800$ MHz) and inside waveguide using analytical field distributions based on power measurements for $f > 800$ MHz. The same setups are used for assessment of the parameters applied for boundary compensation (alpha, depth) of which typical uncertainty values are given. These parameters are used in DASY4 software to improve probe accuracy close to the boundary. The sensitivity in TSL corresponds to NORM_{x,y,z} * ConvF whereby the uncertainty corresponds to that given for ConvF. A frequency dependent ConvF is used in DASY version 4.4 and higher which allows extending the validity from ± 50 MHz to ± 100 MHz.
- Spherical isotropy (3D deviation from isotropy)**: in a field of low gradients realized using a flat phantom exposed by a patch antenna.
- Sensor Offset**: The sensor offset corresponds to the offset of virtual measurement center from the probe tip (on probe axis). No tolerance required.
- Connector Angle**: The angle is assessed using the information gained by determining the NORM_x (no uncertainty required).

EX3DV4 – SN:3933

September 27, 2016

Probe EX3DV4

SN:3933

Manufactured: July 24, 2013
Calibrated: September 27, 2016

Calibrated for DASY/EASY Systems
(Note: non-compatible with DASY2 system!)

EX3DV4- SN:3933

September 27, 2016

DASY/EASY - Parameters of Probe: EX3DV4 - SN:3933

Basic Calibration Parameters

	Sensor X	Sensor Y	Sensor Z	Unc (k=2)
Norm ($\mu\text{V}/(\text{V}/\text{m})^2$) ^A	0.50	0.52	0.19	± 10.1 %
DCP (mV) ^B	103.5	101.2	90.9	

Modulation Calibration Parameters

UID	Communication System Name		A dB	B dB $\sqrt{\mu\text{V}}$	C	D dB	VR mV	Unc ^E (k=2)
0	CW	X	0.0	0.0	1.0	0.00	191.7	±3.0 %
		Y	0.0	0.0	1.0		173.7	
		Z	0.0	0.0	1.0		181.3	

The reported uncertainty of measurement is stated as the standard uncertainty of measurement multiplied by the coverage factor k=2, which for a normal distribution corresponds to a coverage probability of approximately 95%.

^A The uncertainties of Norm X,Y,Z do not affect the E²-field uncertainty inside TSL. (see Pages 5 and 6).

^B Numerical linearization parameter: uncertainty not required.

^E Uncertainty is determined using the max. deviation from linear response applying rectangular distribution and is expressed for the square of the field value.

EX3DV4– SN:3933

September 27, 2016

DASY/EASY - Parameters of Probe: EX3DV4 - SN:3933

Calibration Parameter Determined in Head Tissue Simulating Media

f (MHz) ^C	Relative Permittivity ^F	Conductivity (S/m) ^F	ConvF X	ConvF Y	ConvF Z	Alpha ^G	Depth ^G (mm)	Unc (k=2)
750	41.9	0.89	11.00	11.00	11.00	0.44	0.80	± 12.0 %
835	41.5	0.90	10.48	10.48	10.48	0.44	0.80	± 12.0 %
900	41.5	0.97	10.22	10.22	10.22	0.44	0.84	± 12.0 %
1750	40.1	1.37	8.95	8.95	8.95	0.35	0.80	± 12.0 %
1900	40.0	1.40	8.54	8.54	8.54	0.34	0.80	± 12.0 %
2300	39.5	1.67	8.01	8.01	8.01	0.26	0.98	± 12.0 %
2450	39.2	1.80	7.55	7.55	7.55	0.35	0.82	± 12.0 %
2600	39.0	1.96	7.63	7.63	7.63	0.40	0.83	± 12.0 %
3500	37.9	2.91	7.33	7.33	7.33	0.27	1.20	± 13.1 %
5200	36.0	4.66	5.31	5.31	5.31	0.35	1.80	± 13.1 %
5300	35.9	4.76	5.11	5.11	5.11	0.35	1.80	± 13.1 %
5500	35.6	4.96	4.87	4.87	4.87	0.40	1.80	± 13.1 %
5600	35.5	5.07	4.60	4.60	4.60	0.50	1.80	± 13.1 %
5800	35.3	5.27	4.52	4.52	4.52	0.50	1.80	± 13.1 %

^C Frequency validity above 300 MHz of ± 100 MHz only applies for DASY v4.4 and higher (see Page 2), else it is restricted to ± 50 MHz. The uncertainty is the RSS of the ConvF uncertainty at calibration frequency and the uncertainty for the indicated frequency band. Frequency validity below 300 MHz is ± 10, 25, 40, 50 and 70 MHz for ConvF assessments at 30, 64, 128, 150 and 220 MHz respectively. Above 5 GHz frequency validity can be extended to ± 110 MHz.

^F At frequencies below 3 GHz, the validity of tissue parameters (ϵ and σ) can be relaxed to ± 10% if liquid compensation formula is applied to measured SAR values. At frequencies above 3 GHz, the validity of tissue parameters (ϵ and σ) is restricted to ± 5%. The uncertainty is the RSS of the ConvF uncertainty for indicated target tissue parameters.

^G Alpha/Depth are determined during calibration. SPEAG warrants that the remaining deviation due to the boundary effect after compensation is always less than ± 1% for frequencies below 3 GHz and below ± 2% for frequencies between 3-6 GHz at any distance larger than half the probe tip diameter from the boundary.

EX3DV4– SN:3933

September 27, 2016

DASY/EASY - Parameters of Probe: EX3DV4 - SN:3933

Calibration Parameter Determined in Body Tissue Simulating Media

f (MHz) ^C	Relative Permittivity ^F	Conductivity (S/m) ^F	ConvF X	ConvF Y	ConvF Z	Alpha ^G	Depth ^G (mm)	Unc (k=2)
750	55.5	0.96	10.82	10.82	10.82	0.45	0.80	± 12.0 %
835	55.2	0.97	10.47	10.47	10.47	0.31	1.04	± 12.0 %
900	55.0	1.05	10.36	10.36	10.36	0.48	0.80	± 12.0 %
1750	53.4	1.49	8.43	8.43	8.43	0.43	0.80	± 12.0 %
1900	53.3	1.52	8.17	8.17	8.17	0.36	0.80	± 12.0 %
2300	52.9	1.81	7.89	7.89	7.89	0.30	0.98	± 12.0 %
2450	52.7	1.95	7.59	7.59	7.59	0.42	0.80	± 12.0 %
2600	52.5	2.16	7.48	7.48	7.48	0.32	0.95	± 12.0 %
3500	51.3	3.31	6.84	6.84	6.84	0.35	1.20	± 13.1 %
5200	49.0	5.30	4.79	4.79	4.79	0.45	1.90	± 13.1 %
5300	48.9	5.42	4.49	4.49	4.49	0.50	1.90	± 13.1 %
5500	48.6	5.65	4.03	4.03	4.03	0.55	1.90	± 13.1 %
5600	48.5	5.77	3.80	3.80	3.80	0.60	1.90	± 13.1 %
5800	48.2	6.00	3.95	3.95	3.95	0.60	1.90	± 13.1 %

^C Frequency validity above 300 MHz of ± 100 MHz only applies for DASY v4.4 and higher (see Page 2), else it is restricted to ± 50 MHz. The uncertainty is the RSS of the ConvF uncertainty at calibration frequency and the uncertainty for the indicated frequency band. Frequency validity below 300 MHz is ± 10, 25, 40, 50 and 70 MHz for ConvF assessments at 30, 64, 128, 150 and 220 MHz respectively. Above 5 GHz frequency validity can be extended to ± 110 MHz.

^F At frequencies below 3 GHz, the validity of tissue parameters (ϵ and σ) can be relaxed to ± 10% if liquid compensation formula is applied to measured SAR values. At frequencies above 3 GHz, the validity of tissue parameters (ϵ and σ) is restricted to ± 5%. The uncertainty is the RSS of the ConvF uncertainty for indicated target tissue parameters.

^G Alpha/Depth are determined during calibration. SPEAG warrants that the remaining deviation due to the boundary effect after compensation is always less than ± 1% for frequencies below 3 GHz and below ± 2% for frequencies between 3-6 GHz at any distance larger than half the probe tip diameter from the boundary.