

## Report on the RF Testing of:

KYOCERA Corporation  
Mobile Phone, Model: CB70  
FCC ID: JOYCB70

In accordance with FCC Part 27 Subpart C  
and FCC Part 27 Subpart H

Prepared for: KYOCERA Corporation  
Yokohama Office 2-1-1 Kagahara, Tsuzuki-ku  
Yokohama-shi, Kanagawa, Japan  
Phone: +81-45-943-6253 Fax: +81-45-943-6314



Japan

Add value.  
Inspire trust.

## COMMERCIAL-IN-CONFIDENCE

Document Number: JPD-TR-19184-0

### SIGNATURE

--	--	--	--

NAME	JOB TITLE	RESPONSIBLE FOR	ISSUE DATE
Hiroaki Suzuki	Deputy Manager of RF Group	Approved Signatory	

Signatures in this approval box have checked this document in line with the requirements of TÜV SÜD Japan Ltd. document control rules.

### EXECUTIVE SUMMARY

A sample(s) of this product was tested and found to be compliant with FCC Part 27 Subpart C and FCC Part 27 Subpart H.



### DISCLAIMER AND COPYRIGHT

The results in this report are applicable only to the equipment tested.  
This report shall not be re-produced except in full without the written approval of TÜV SÜD Japan Ltd.

### ACCREDITATION

This test report must not be used by the client to claim product certification, approval, or endorsement by NVLAP, NIST, or any agency of the federal government.

TÜV SÜD Japan Ltd.  
Yonezawa Testing Center  
5-4149-7 Hachimanpara,  
Yonezawa-shi, Yamagata,  
992-1128 Japan

Phone: +81 (0) 238 28 2881  
Fax: +81 (0) 238 28 2888  
[www.tuv-sud.jp](http://www.tuv-sud.jp)

## Contents

<b>1</b>	<b>Summary of Test</b> .....	<b>3</b>
1.1	Modification history of the test report.....	3
1.2	Standards.....	3
1.3	Test methods.....	3
1.4	Deviation from standards.....	3
1.5	List of applied test(s) of the EUT.....	3
1.6	Test information.....	3
1.7	Test set up.....	3
1.8	Test period.....	3
<b>2</b>	<b>Equipment Under Test</b> .....	<b>4</b>
2.1	EUT information.....	4
2.2	Modification to the EUT.....	5
2.3	Variation of family model(s).....	5
2.4	Description of test mode.....	5
<b>3</b>	<b>Configuration of Equipment</b> .....	<b>6</b>
3.1	Equipment used.....	6
3.2	System configuration.....	6
<b>4</b>	<b>Test Result</b> .....	<b>7</b>
4.1	Effective Radiated Power.....	7
4.2	Peak to Average Ratio.....	11
4.3	Occupied Bandwidth.....	16
4.4	Band Edge Spurious and Harmonic at Antenna Terminals.....	20
4.5	Radiated Emissions and Harmonic Emissions.....	37
4.6	Frequency Stability.....	43
<b>5</b>	<b>Measurement Uncertainty</b> .....	<b>45</b>
<b>6</b>	<b>Laboratory Information</b> .....	<b>46</b>
	<b>Appendix A. Test Equipment</b> .....	<b>47</b>

## 1 Summary of Test

### 1.1 Modification history of the test report

Document Number	Modification History	Issue Date
JPD-TR-19184-0	First Issue	Refer to the cover page

### 1.2 Standards

CFR47 FCC Part 27 Subpart C  
CFR47 FCC Part 27 Subpart H

### 1.3 Test methods

KDB 971168 D01 Power Meas License Digital Systems v03r01  
ANSI/TIA/EIA-603-D-2010

### 1.4 Deviation from standards

None

### 1.5 List of applied test(s) of the EUT

Test item section	Test item	Condition	Result	Remark
2.1046	Conducted Output Power	Conducted	PASS	*1
27.50	Effective Radiated Power	Radiated	PASS	-
27.50	Peak to Average Ratio	Conducted	PASS	-
2.1049	Occupied Bandwidth	Conducted	PASS	-
27.53 2.1051	Band Edge Spurious and Harmonic at Antenna Terminal	Conducted	PASS	-
27.53 2.1053	Radiated emissions and Harmonic Emissions	Radiated	PASS	-
27.54 2.1055	Frequency Stability	Conducted	PASS	-

\*1: Refer to RF Exposure Report (Test Report\_SAR)

### 1.6 Test information

None

### 1.7 Test set up

Table-top

### 1.8 Test period

15-October-2019 - 7-November-2019

## 2 Equipment Under Test

### 2.1 EUT information

Applicant	KYOCERA Corporation Yokohama Office 2-1-1 Kagahara, Tsuzuki-ku Yokohama-shi, Kanagawa, Japan Phone: +81-45-943-6253 Fax: +81-45-943-6314
Equipment Under Test (EUT)	Mobile Phone
Model number	CB70
Serial number	N/A
Trade name	Kyocera
Number of sample(s)	1
EUT condition	Pre-Production
Power rating	Battery: DC 3.85 V
Size	(W) 71.0 × (D) 159.0 × (H) 8.9 mm
Environment	Indoor and Outdoor use
Terminal limitation	-20°C to 60°C
Hardware version	DMT2
Software version	0.410HA
Firmware version	Not applicable
RF Specification	
Frequency of Operation	Up Link LTE Band X VII: 704-716 MHz  Down Link LTE Band X VII: 734-746 MHz
Modulation type	QPSK, 16QAM, 64QAM
Emission designator	BW 5M QPSK: 4M55G7D, 16QAM: 4M53W7D, 64QAM: 4M55W7D BW 10M QPSK: 9M05G7D, 16QAM: 9M03W7D, 64QAM: 9M02W7D
Effective Radiated Power (E.R.P.)	QPSK: 0.0692 W (18.4 dBm) 16QAM: 0.0603 W (17.8 dBm) 64QAM: 0.0389 W (15.9 dBm)
Antenna type	Internal antenna
Antenna gain	-7.5 dBi

## 2.2 Modification to the EUT

The table below details modifications made to the EUT during the test project.

Modification State	Description of Modification	Modification fitted by	Date of Modification
Model: CB70, Serial Number: N/A			
0	As supplied by the applicant	Not Applicable	Not Applicable

## 2.3 Variation of family model(s)

### 2.3.1 List of family model(s)

Not applicable

### 2.3.2 Reason for selection of EUT

Not applicable

## 2.4 Description of test mode

The EUT had been tested under operating condition.  
There are three channels have been tested as following:

Band	Modulation	Bandwidth	Channel	Frequency [MHz]
LTE Band X VII	QPSK, 16QAM, 64QAM	5 MHz	23755	706.5
			23790	710.0
			23825	713.5
		10 MHz	23780	709.0
			23790	710.0
			23800	711.0

The field strength of spurious emissions was measured at each position of all three axis X, Y and Z to compare the level, and the maximum noise.

The worst emission was found in X-axis and the worst case recorded.

Pre-scan has been conducted to determine the worst-case mode from all possible combinations between available modulations, data rates and antenna ports.

### 3 Configuration of Equipment

Numbers assigned to equipment on the diagram in “3.2 System configuration” correspond to the list in “3.1 Equipment used”.

Cabling and setup(s) were taken into consideration and test data was taken under worse case condition.

#### 3.1 Equipment used

No.	Equipment	Company	Model No.	Serial No.	FCC ID/DoC	Comment
1	Mobile Phone	KYOCERA	CB70	N/A	JOYCB70	EUT

#### 3.2 System configuration

1. Mobile Phone  
(EUT)

## 4 Test Result

### 4.1 Effective Radiated Power

#### 4.1.1 Measurement procedure

##### [FCC 27.50]

##### <Step 1>

The EUT and support equipment are placed on a 1 meter x 1 meter surface, 0.8 meter height styrene foam table. Radiated emission measurements are performed at 3 meter distance with the broadband antenna (Log periodic antenna). The antenna is positioned both the horizontal and vertical planes of polarization and height is varied 1 to 4 meters and stopped at height producing the maximum emission. The bandwidth of the spectrum analyzer is set to 1 MHz. The turntable is rotated by 360 degrees and stopped at azimuth of producing the maximum emission.

##### <Step 2>

The substitution antenna is replaced by the transmitter antenna (EUT).

The frequency of the signal generator is adjusted to the measurement frequency.

Level of the signal generator is adjusted to the level that is obtained from step 1, and record the emission level of signal generator.

The spectrum analyzer is set to;

- a) Span = 1.5 times the OBW
- b) RBW = 1-5% of the expected OBW, not to exceed 1 MHz
- c) VBW  $\geq 3 \times$  RBW
- d) Number of sweep points  $\geq 2 \times$  span / RBW
- e) Sweep time = auto-couple
- f) Detector = RMS (power averaging)
- g) If the EUT can be configured to transmit continuously (i.e., burst duty cycle  $\geq 98\%$ ), then set the trigger to free run.
- h) If the EUT cannot be configured to transmit continuously (i.e., burst duty cycle  $< 98\%$ ), then use a sweep trigger with the level set to enable triggering only on full power bursts and configure the EUT to transmit at full power for the entire duration of each sweep. Ensure that the sweep time is less than or equal to the transmission burst duration.
- i) Trace average at least 100 traces in power averaging (i.e., RMS) mode.
- j) Compute the power by integrating the spectrum across the OBW of the signal using the instrument's band power measurement function, with the band limits set equal to the OBW band edges.

If the instrument does not have a band power function, then sum the spectrum levels (in linear power units) at intervals equal to the RBW extending across the entire OBW of the spectrum.

##### - Test configuration

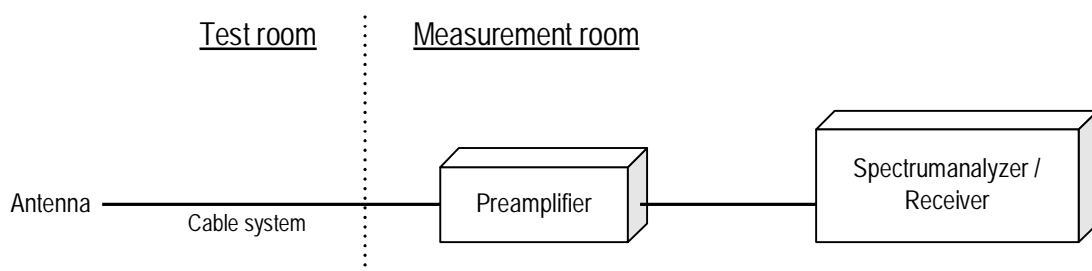



#### 4.1.2 Calculation method

Result (ERP) = S.G Reading - Cable loss + Antenna Gain  
Margin = Limit – Result (ERP)

Example:

Limit @ 710MHz : 34.7 dBm  
S.G Reading = 25.5 dBm Cable loss = 0.7 dB Ant. Gain = -10.1 dBd  
Result = 25.5 - 0.7 + (-10.1) = 14.8 dBm  
Margin = 34.7 – 14.8 = 19.9 dB

#### 4.1.3 Limit

3 W (34.7 dBm)



#### 4.1.4 Test data

Date	: 15-October-2019	Test engineer	:	
Temperature	: 18.6 [°C]			
Humidity	: 61.3 [%]			
Test place	: 3m Semi-anechoic chamber			
			:	<u>Taiki Watanabe</u>
Date	: 16-October-2019	Test engineer	:	
Temperature	: 22.1 [°C]			
Humidity	: 51.3 [%]			
Test place	: 3m Semi-anechoic chamber			
			:	<u>Taiki Watanabe</u>
Date	: 18-October-2019	Test engineer	:	
Temperature	: 22.7 [°C]			
Humidity	: 42.8 [%]			
Test place	: 3m Semi-anechoic chamber			
			:	<u>Chiaki Kanno</u>
Date	: 6-November-2019	Test engineer	:	
Temperature	: 21.7 [°C]			
Humidity	: 47.3 [%]			
Test place	: 3m Semi-anechoic chamber			
			:	<u>Chiaki Kanno</u>
Date	: 7-November-2019	Test engineer	:	
Temperature	: 20.5 [°C]			
Humidity	: 51.1 [%]			
Test place	: 3m Semi-anechoic chamber			
			:	<u>Chiaki Kanno</u>

#### [LTE Band X VII] QPSK, BW 5MHz

H/V	Frequency [MHz]	S.A Reading [dBm]	S.G Reading [dBm]	Cable loss [dB]	Ant.Gain [dBd]	Result [dBm]	Limit [dBm]	Margin [dB]
H	706.5	-16.5	24.3	0.7	-5.6	18.0	34.7	16.7
H	710.0	-16.7	24.4	0.7	-5.6	18.0	34.7	16.7
H	713.5	-16.7	24.7	0.7	-5.7	18.3	34.7	16.4

#### 16QAM, BW 5MHz

H/V	Frequency [MHz]	S.A Reading [dBm]	S.G Reading [dBm]	Cable loss [dB]	Ant.Gain [dBd]	Result [dBm]	Limit [dBm]	Margin [dB]
H	706.5	-17.4	23.4	0.7	-5.6	17.1	34.7	17.6
H	710.0	-17.1	24.0	0.7	-5.6	17.6	34.7	17.1
H	713.5	-17.2	24.2	0.7	-5.7	17.8	34.7	16.9

#### 64QAM, BW 5MHz

H/V	Frequency [MHz]	S.A Reading [dBm]	S.G Reading [dBm]	Cable loss [dB]	Ant.Gain [dBd]	Result [dBm]	Limit [dBm]	Margin [dB]
H	706.5	-18.9	21.9	0.7	-5.6	15.6	34.7	19.1
H	710.0	-19.3	21.8	0.7	-5.6	15.4	34.7	19.3
H	713.5	-19.6	21.8	0.7	-5.7	15.4	34.7	19.3

**QPSK, BW 10MHz**

H/V	Frequency [MHz]	S.A Reading [dBm]	S.G Reading [dBm]	Cable loss [dB]	Ant.Gain [dBd]	Result [dBm]	Limit [dBm]	Margin [dB]
H	709.0	-16.3	24.7	0.7	-5.6	18.3	34.7	16.4
H	710.0	-17.1	24.0	0.7	-5.6	17.6	34.7	17.1
H	711.0	-16.4	24.8	0.7	-5.6	18.4	34.7	16.3

**16QAM, BW 10MHz**

H/V	Frequency [MHz]	S.A Reading [dBm]	S.G Reading [dBm]	Cable loss [dB]	Ant.Gain [dBd]	Result [dBm]	Limit [dBm]	Margin [dB]
H	709.0	-17.0	24.0	0.7	-5.6	17.6	34.7	17.1
H	710.0	-16.9	24.2	0.7	-5.6	17.8	34.7	16.9
H	711.0	-17.3	23.9	0.7	-5.6	17.5	34.7	17.2

**64QAM, BW 10MHz**

H/V	Frequency [MHz]	S.A Reading [dBm]	S.G Reading [dBm]	Cable loss [dB]	Ant.Gain [dBd]	Result [dBm]	Limit [dBm]	Margin [dB]
H	709.0	-19.0	22.0	0.7	-5.6	15.6	34.7	19.1
H	710.0	-18.8	22.3	0.7	-5.6	15.9	34.7	18.8
H	711.0	-18.9	22.3	0.7	-5.6	15.9	34.7	18.8

## 4.2 Peak to Average Ratio

### 4.2.1 Measurement procedure

#### [FCC 27.50]

The peak to average ratio was measured with a spectrum analyzer connected to the antenna terminal.

The spectrum analyzer is set to;

- a) Power Stat CCDF mode
- b) Set resolution / measurement bandwidth  $\geq$  signal's occupied bandwidth.
- c) Set the number of counts to a value that stabilizes the measured CCDF curve.
- d) Set the measurement interval as follows:
  - 1) For continuous transmissions, set to 1ms.
  - 2) For burst transmissions, employ an external trigger that is synchronized with the EUT burst timing sequence, or use the internal burst trigger with a trigger level that allows the burst duration.
- e) Record the maximum PAPR level associated with a probability of 0.1%.

- Test configuration

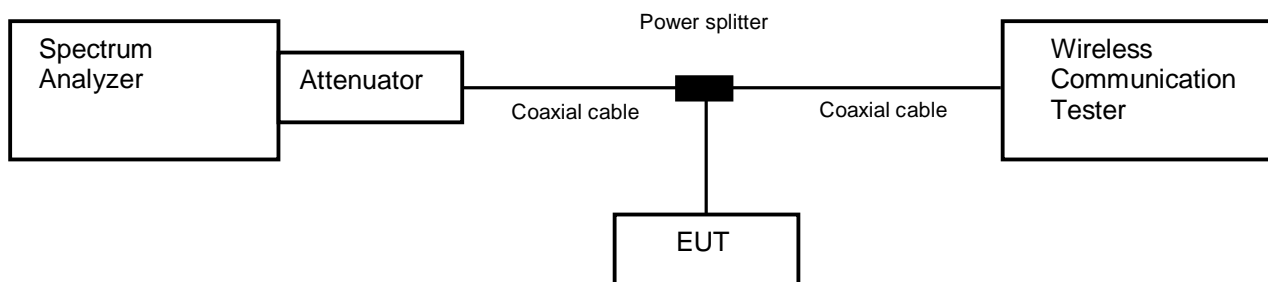

### 4.2.2 Limit

13 dB or less

#### 4.2.3 Measurement result

Date : 17-October-2019

Temperature : 22.6 [°C]

Humidity : 45.5 [%]

Test place : Shielded room No.4

Test engineer :

Chiaki Kanno

Band	Channel	Frequency [MHz]	Modulation	BW [MHz]	RB	Peak to Average Power Ratio [dB]	Limit [dB]
LTE Band X VII	23790	710.0	QPSK	5	25-0	5.82	13
				10	50-0	4.61	13
			16QAM	5	25-0	6.50	13
				10	50-0	6.24	13
			64QAM	5	25-0	6.67	13
				10	50-0	6.53	13

4.2.4 Trace data

[LTE Band X VII]  
 Channel: 23790  
 QPSK, BW 5MHz, RB25-0

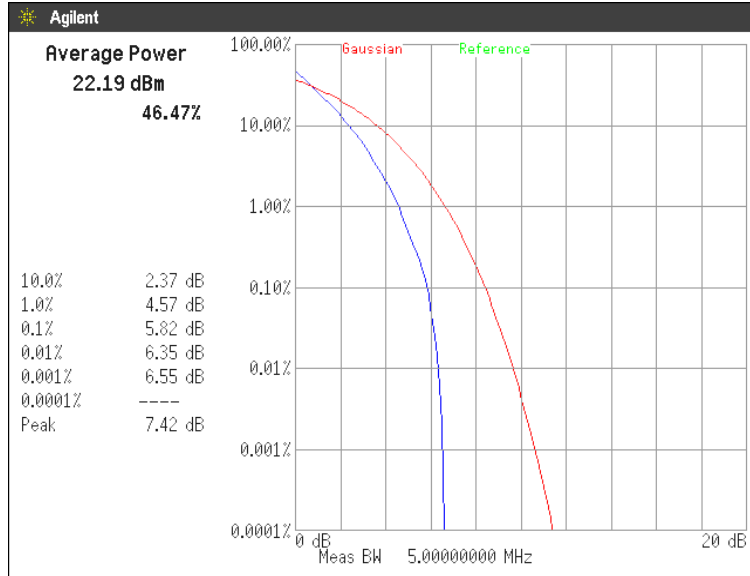

QPSK, BW 10MHz, RB50-0

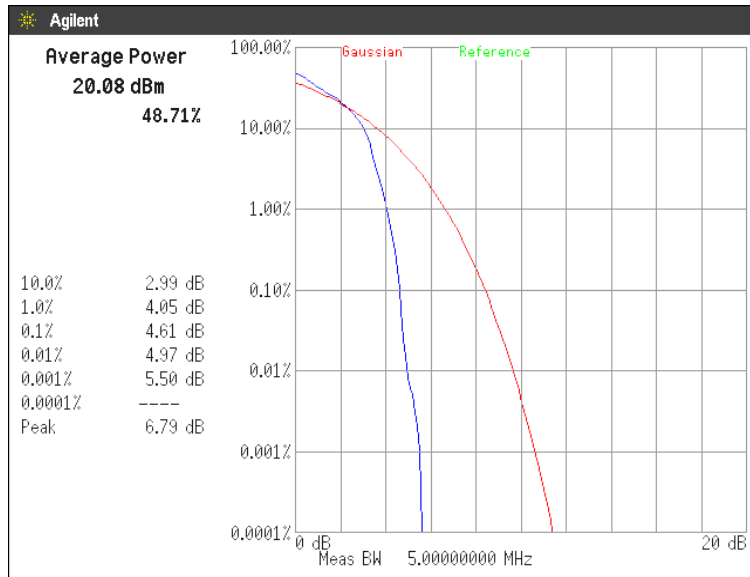

**16QAM, BW 5MHz, RB25-0**

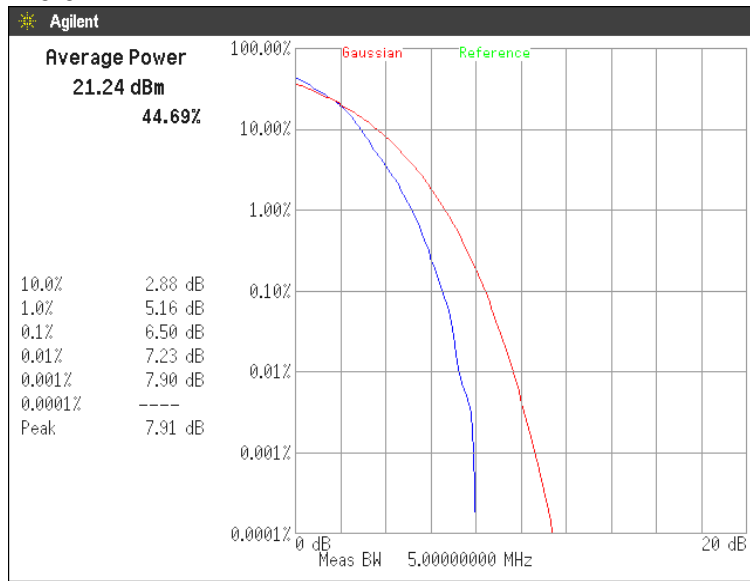

**16QAM, BW 10MHz, RB50-0**

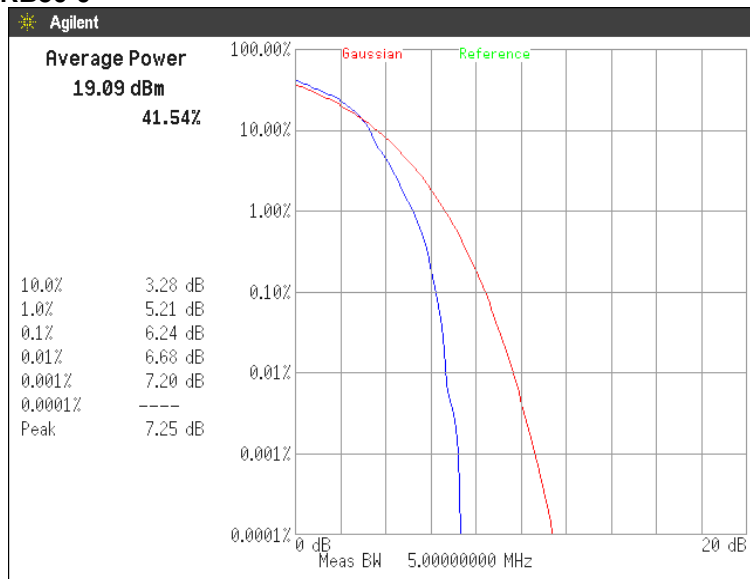

**64QAM, BW 5MHz, RB25-0**

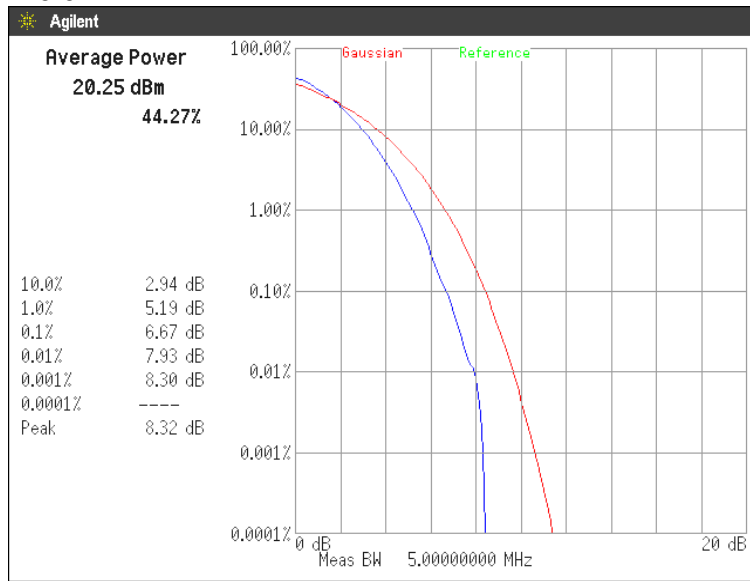

**64QAM, BW 10MHz, RB50-0**

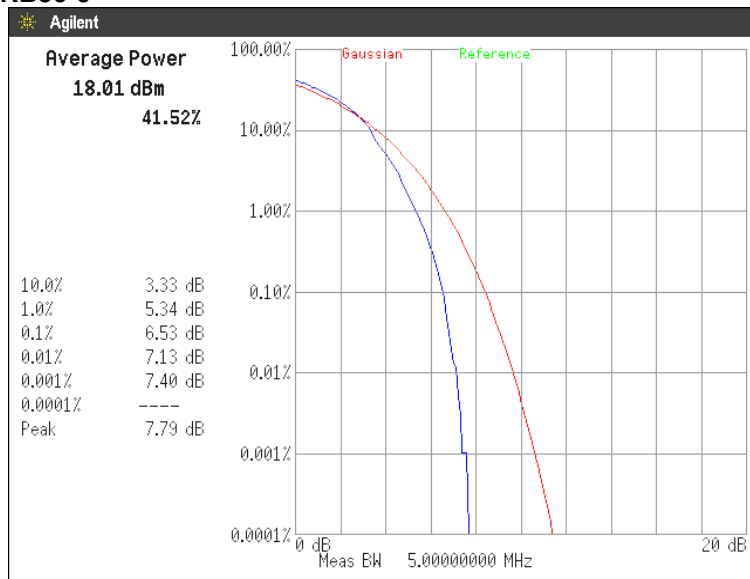

### 4.3 Occupied Bandwidth

#### 4.3.1 Measurement procedure

##### [FCC 2.1049]

The Occupied bandwidth was measured with a spectrum analyzer connected to the antenna terminal.

The spectrum analyzer is set to;

- RBW = 1-5% of the expected OBW & VBW  $\geq 3 \times$  RBW
- Detector = Peak
- Trace mode = Max hold
- Sweep time = auto-couple

- Test configuration

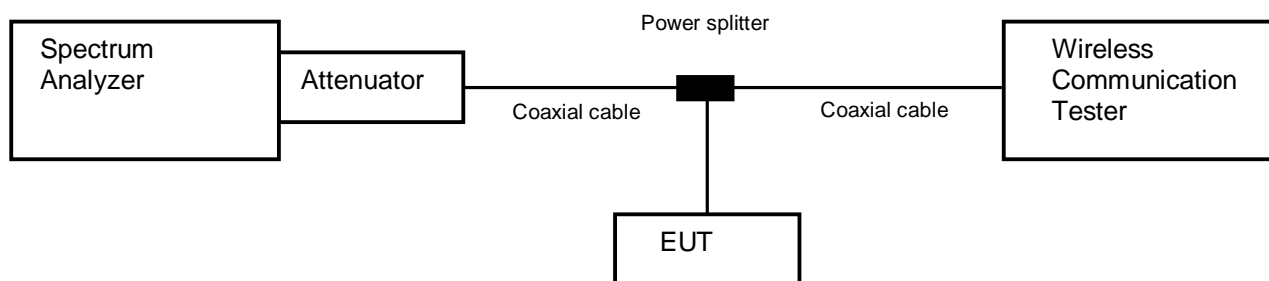

#### 4.3.2 Limit

None



### 4.3.3 Measurement result

Date : 17-October-2019

Temperature : 22.6 [°C]

Humidity : 45.5 [%]

Test place : Shielded room No.4

Test engineer :

Chiaki Kanno

BW	Mode	UL RB Allocation	UL RB Start	Frequency [MHz]	26dB Bandwidth [MHz]	99% OBW [MHz]
5MHz	QPSK	12	7	710.0	3.047	2.2952
		25	0		5.210	4.5467
	16QAM	12	7	710.0	2.987	2.2949
		25	0		5.227	4.5262
	64QAM	12	7	710.0	3.006	2.2822
		25	0		5.207	4.5530
10MHz	QPSK	25	12	710.0	5.786	4.6762
		50	0		10.277	9.0493
	16QAM	25	12	710.0	5.738	4.6363
		50	0		10.135	9.0310
	64QAM	25	12	710.0	5.749	4.6749
		50	0		10.116	9.0224



### 4.3.4 Trace data

[LTE Band X VII]  
Channel: 23790

#### QPSK, BW 5MHz

##### RB12-7

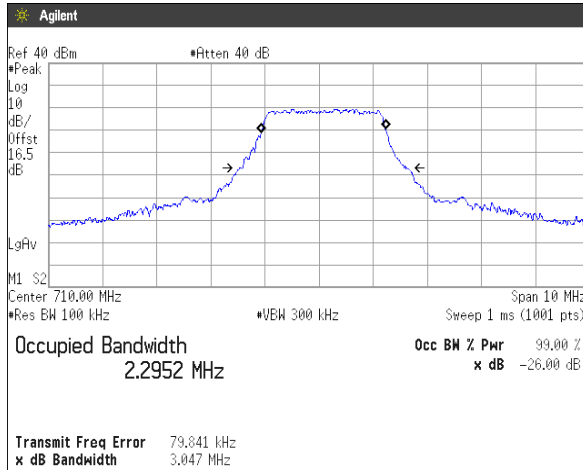

##### RB25-0

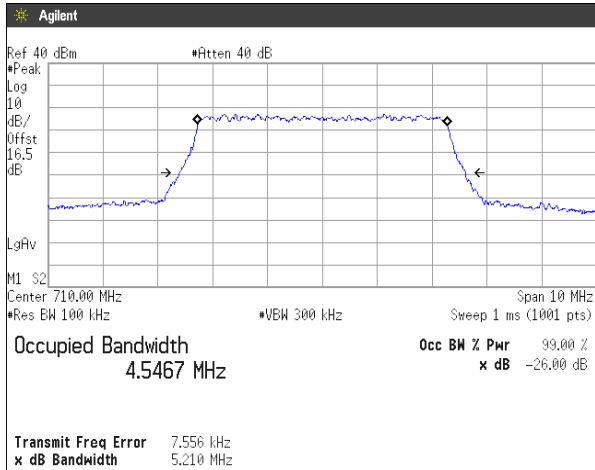

#### 16QAM, BW 5MHz

##### RB12-7

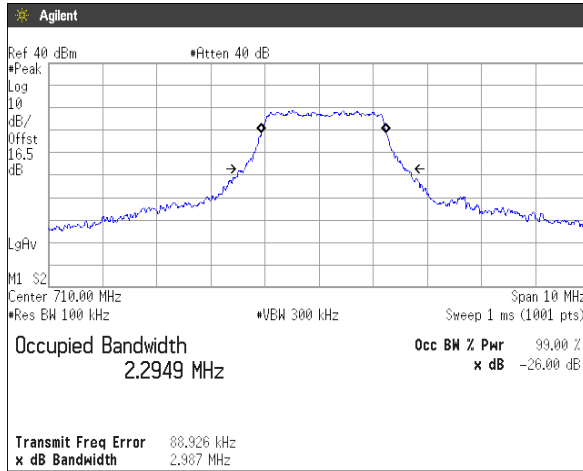

##### RB25-0

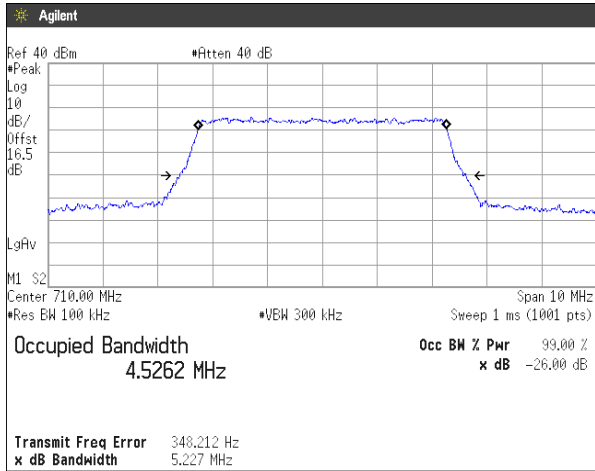

#### 64QAM, BW 5MHz

##### RB12-7

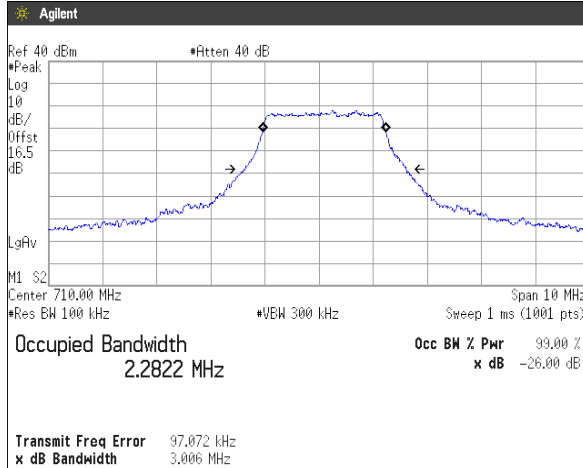

##### RB25-0

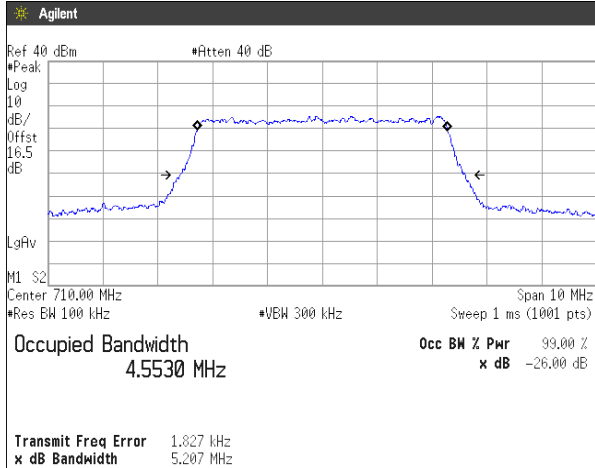

**QPSK, BW 10MHz**

**RB25-12**

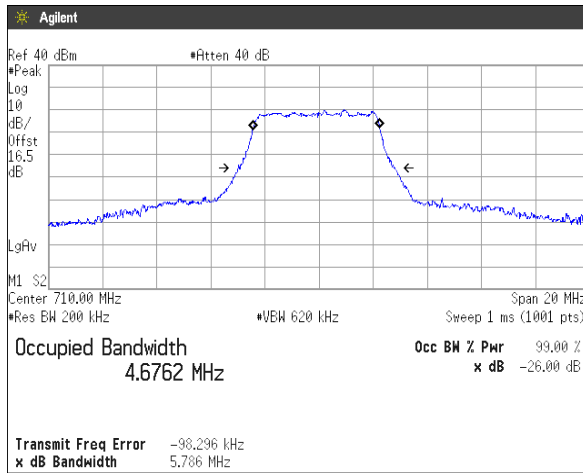

**RB50-0**

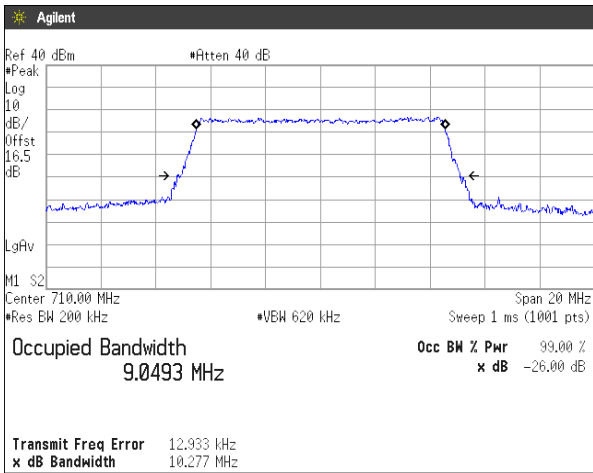

**16QAM, BW 10MHz**

**RB25-12**

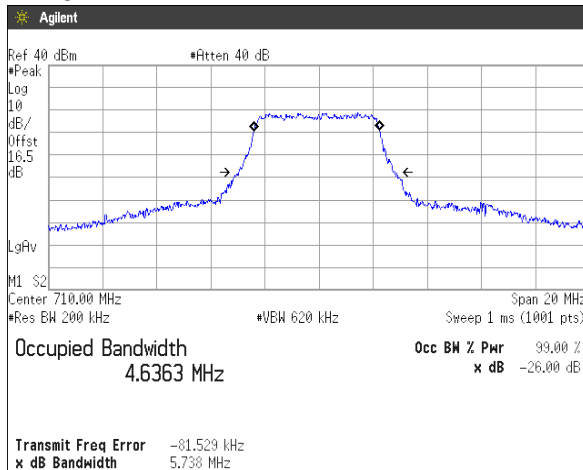

**RB50-0**

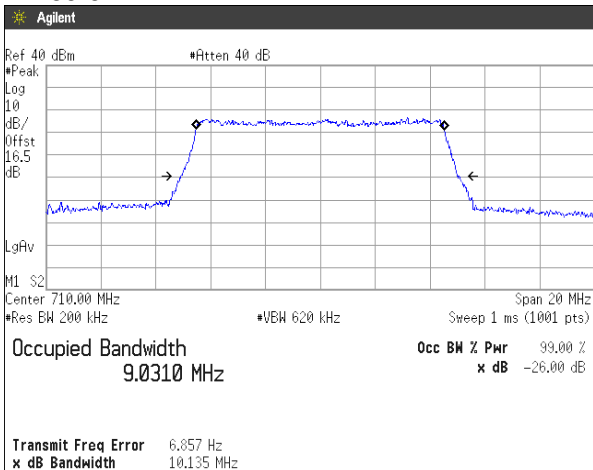

**64QAM, BW 10MHz**

**RB25-12**

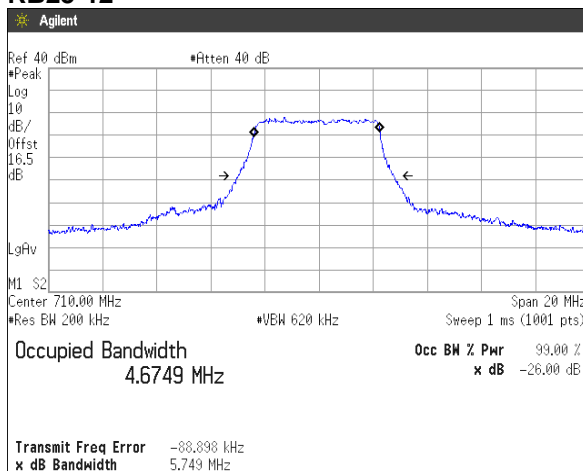

**RB50-0**

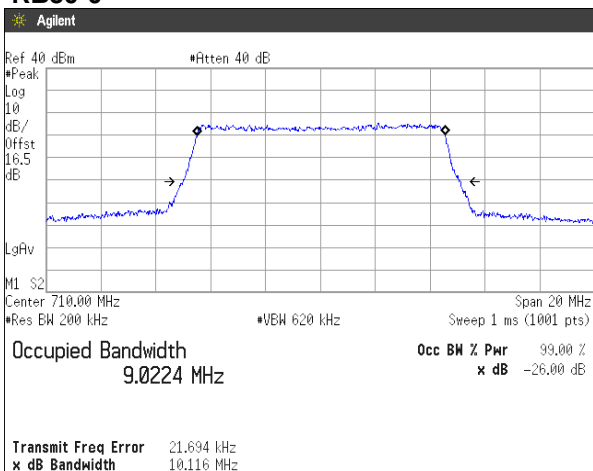

#### 4.4 Band Edge Spurious and Harmonic at Antenna Terminals

##### 4.4.1 Measurement procedure

###### [FCC 27.53, 2.1051]

The band edge spurious and harmonic was measured with a spectrum analyzer connected to the antenna terminal.

The spectrum analyzer is set to;

<Band Edge>

- Span was set large enough so as to capture all out of band emissions near the band edge
- RBW  $\geq$  1% of the emission bandwidth or 2% of the emission bandwidth
- VBW  $\geq$  3 x RBW
- Detector = RMS
- Trace mode = Max hold
- Sweep time = auto-couple
- Number of sweep point  $\geq$  2 x span / RBW

<Spurious Emissions>

- RBW = 1MHz & VBW  $\geq$  3 x RBW
- Detector = Peak
- Trace mode = Max hold
- Sweep time = auto-couple
- Number of sweep point  $\geq$  2 x span / RBW

- Test configuration

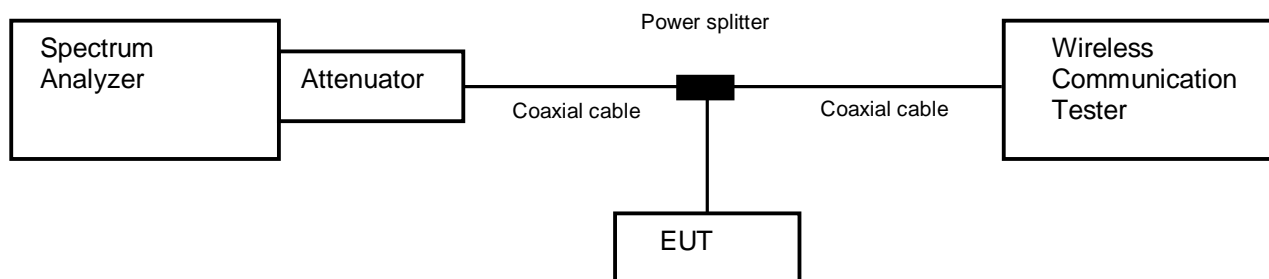

##### 4.4.2 Limit

-13 dB or less



**4.4.3 Measurement result**

Date : 17-October-2019  
 Temperature : 22.6 [°C]  
 Humidity : 45.5 [%]  
 Test place : Shielded room No.4

Test engineer : Chiaki Kanno

Date : 31-October-2019  
 Temperature : 20.8 [°C]  
 Humidity : 46.1 [%]  
 Test place : Shielded room No.4

Test engineer : Chiaki Kanno

Date : 1-November-2019  
 Temperature : 21.4 [°C]  
 Humidity : 47.4 [%]  
 Test place : Shielded room No.4

Test engineer : Chiaki Kanno

Band	Modulation	Bandwidth	Results	
LTE Band X VII	QPSK, 16QAM, 64QAM	5MHz	See the trace data	PASS
		10MHz	See the trace data	PASS



4.4.4 Trace data

[LTE Band X VII]  
 (Band Edge)  
 QPSK, BW 5MHz, RB1-0  
 Channel: Low

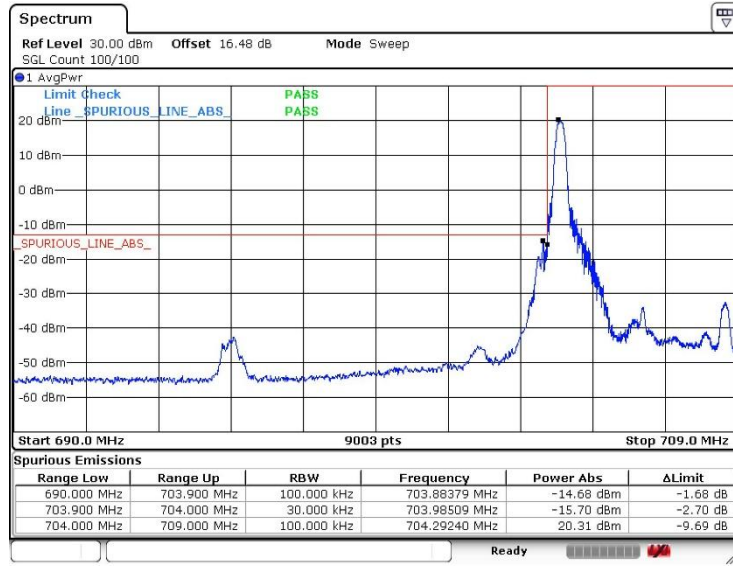

Date: 31.OCT.2019 16:52:47

QPSK, BW 5MHz, RB1-24  
 Channel: High



Date: 31.OCT.2019 17:00:36



**QPSK, BW 5MHz, RB25-0**  
**Channel: Low**

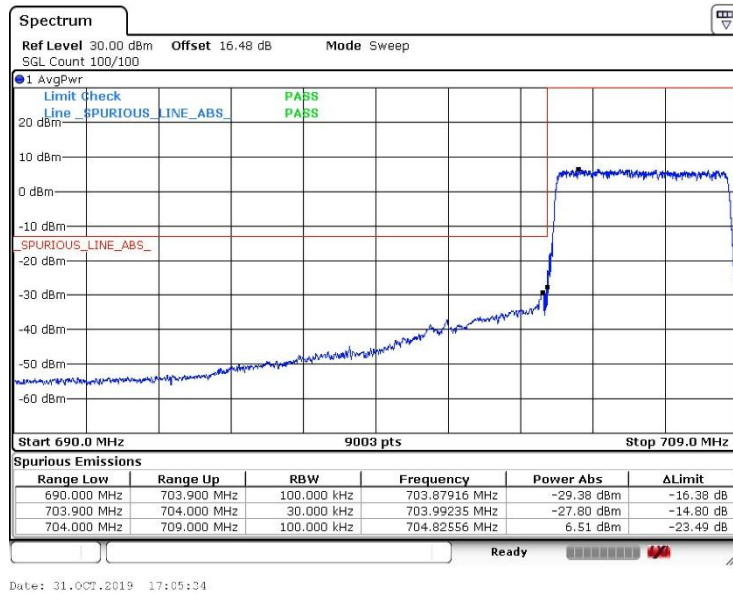

**QPSK, BW 5MHz, RB25-0**  
**Channel: High**

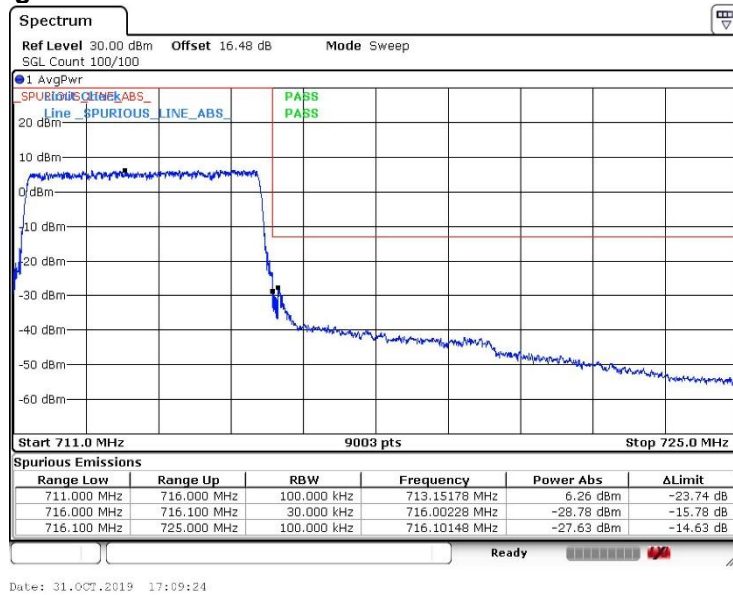



**16QAM, BW 5MHz, RB1-0**  
**Channel: Low**

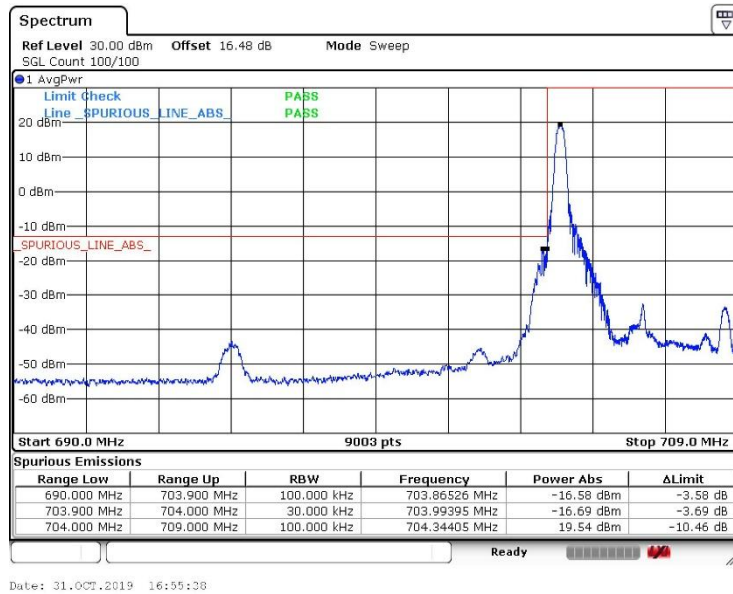

**16QAM, BW 5MHz, RB1-24**  
**Channel: High**

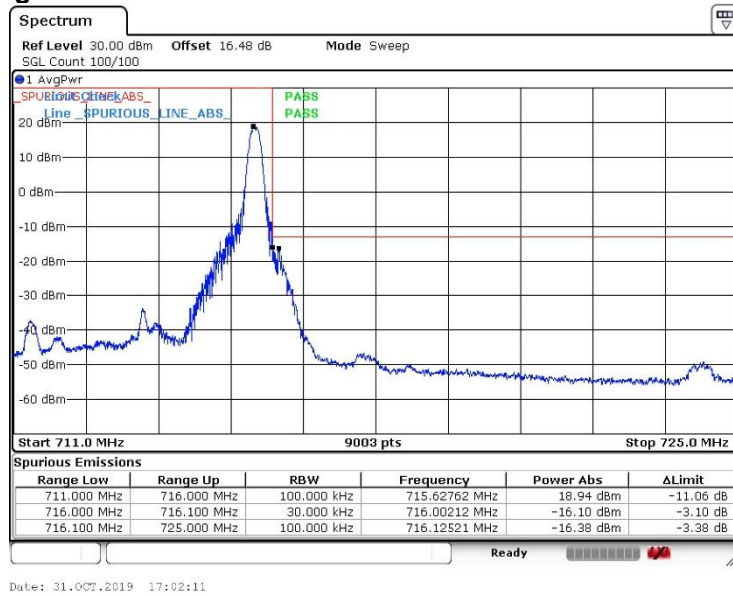





**16QAM, BW 5MHz, RB25-0**  
**Channel: Low**

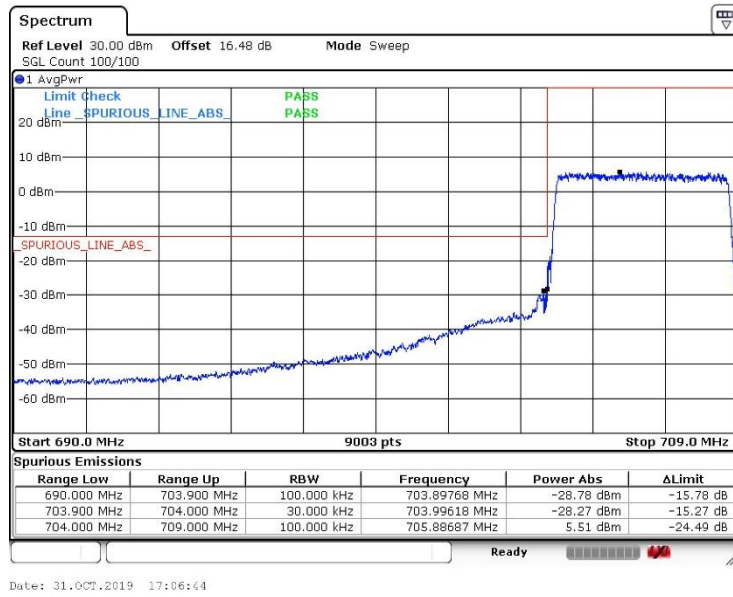

**16QAM, BW 5MHz, RB25-0**  
**Channel: High**

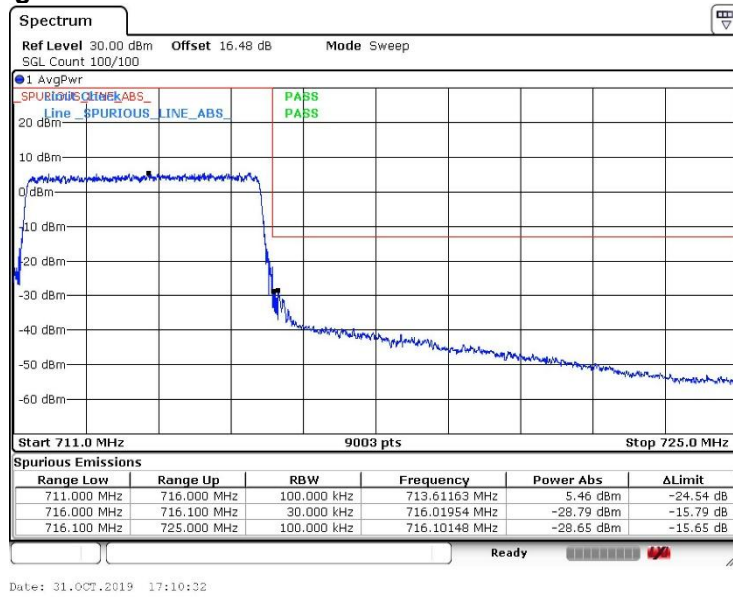



**64QAM, BW 5MHz, RB1-0**  
**Channel: Low**

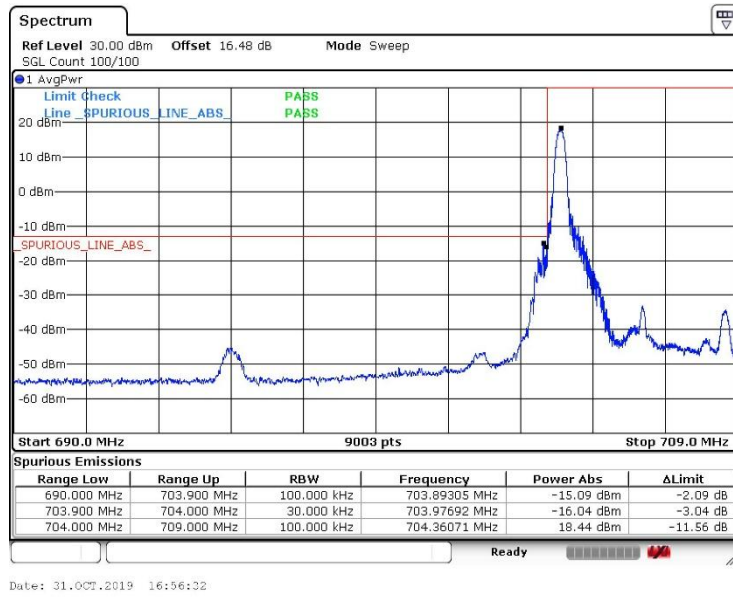

**64QAM, BW 5MHz, RB1-24**  
**Channel: High**

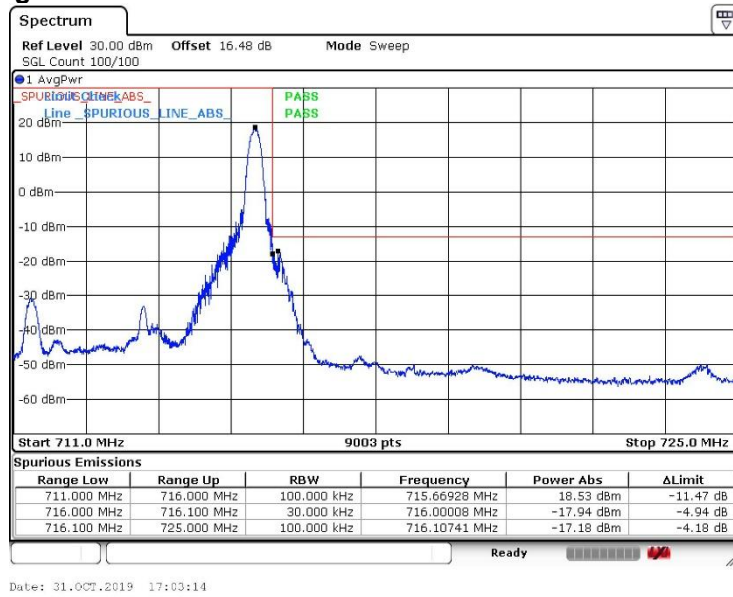



**64QAM, BW 5MHz, RB25-0**  
**Channel: Low**

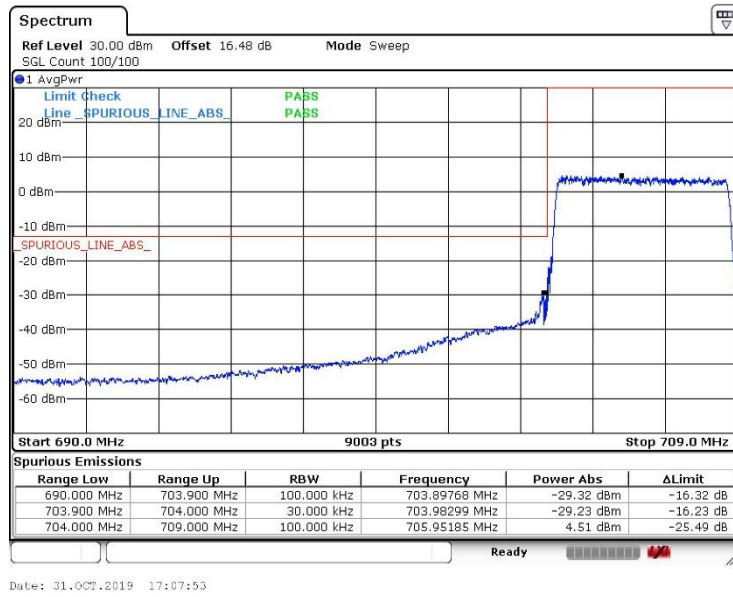

**64QAM, BW 5MHz, RB25-0**  
**Channel: High**

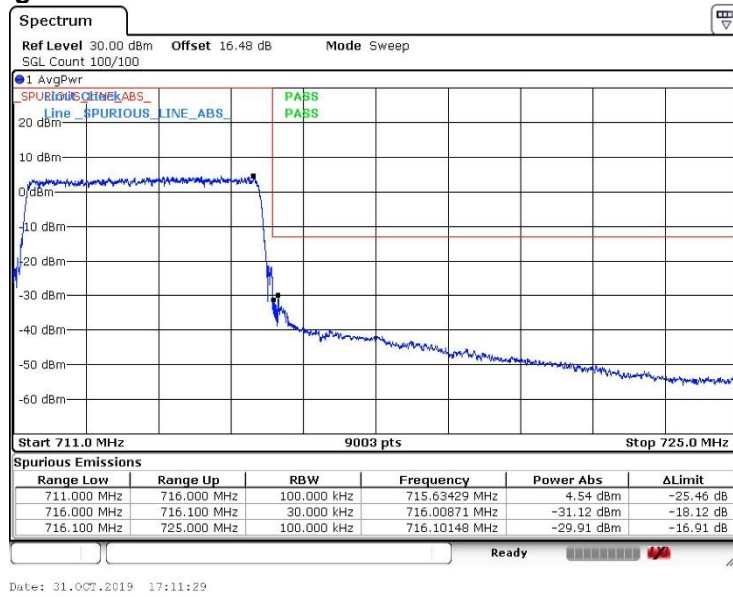



**QPSK, BW 10MHz, RB1-0**  
**Channel: Low**

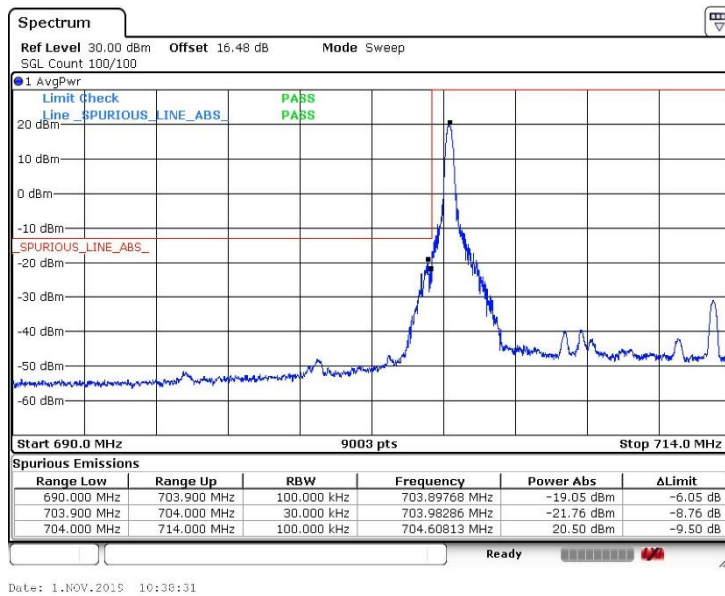

**QPSK, BW 10MHz, RB1-49**  
**Channel: High**

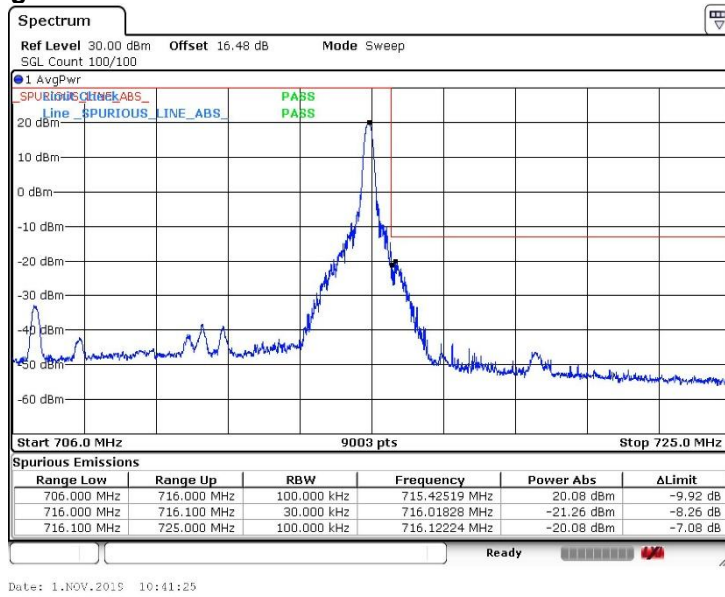



**QPSK, BW 10MHz, RB50-0**  
**Channel: Low**

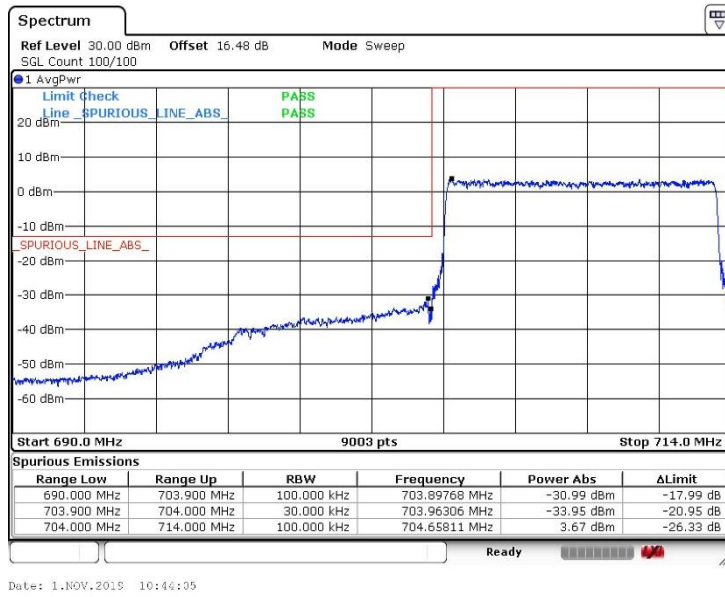

**QPSK, BW 10MHz, RB50-0**  
**Channel: High**

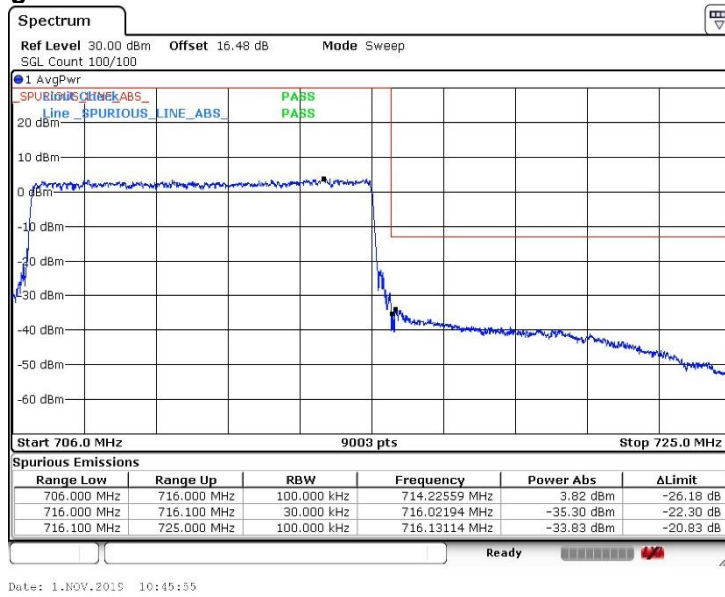



**16QAM, BW 10MHz, RB1-0**  
**Channel: Low**

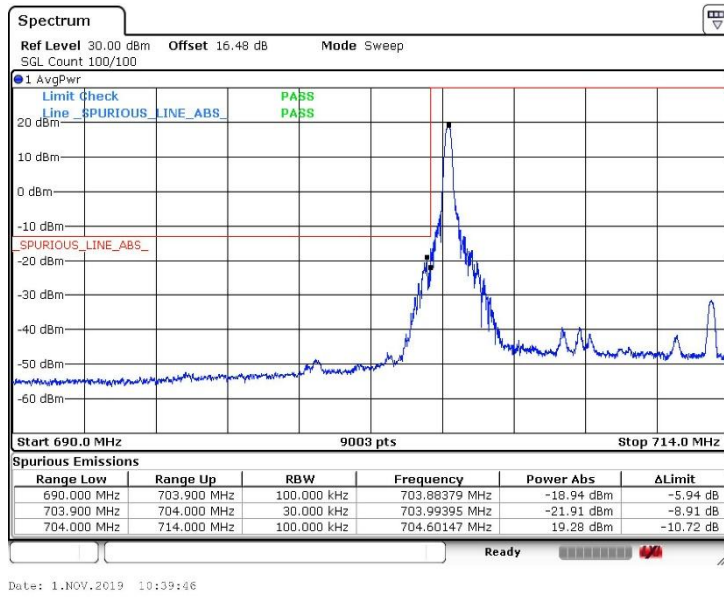

**16QAM, BW 10MHz, RB1-49**  
**Channel: High**

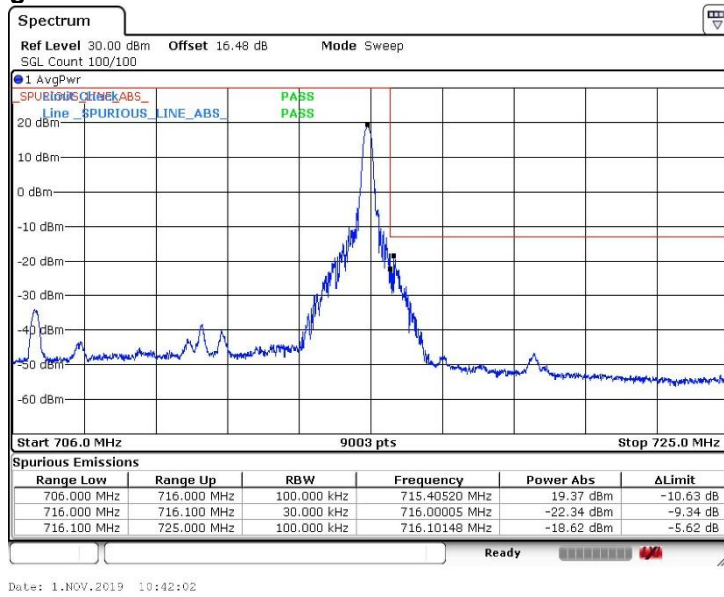



**16QAM, BW 10MHz, RB50-0**  
**Channel: Low**

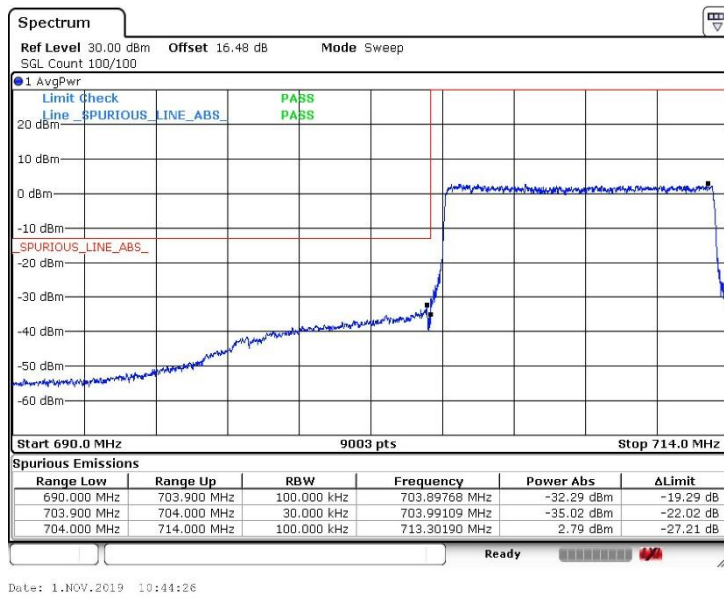

**16QAM, BW 10MHz, RB50-0**  
**Channel: High**

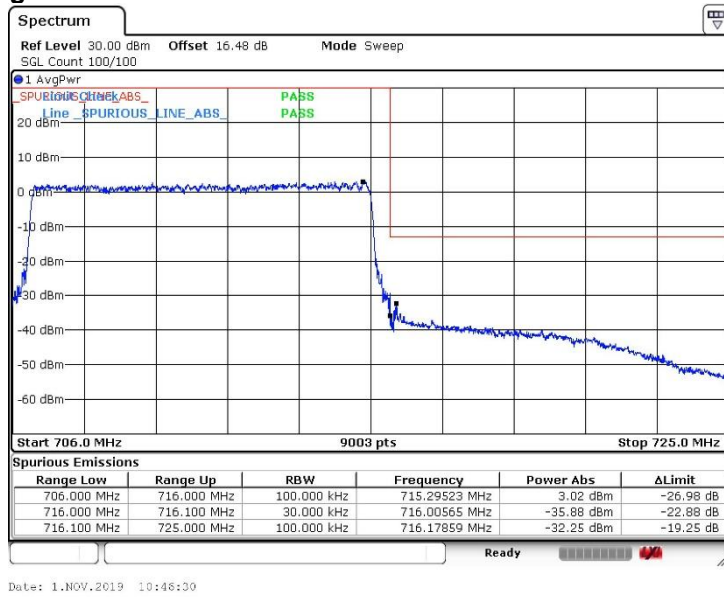



**64QAM, BW 10MHz, RB1-0**  
**Channel: Low**

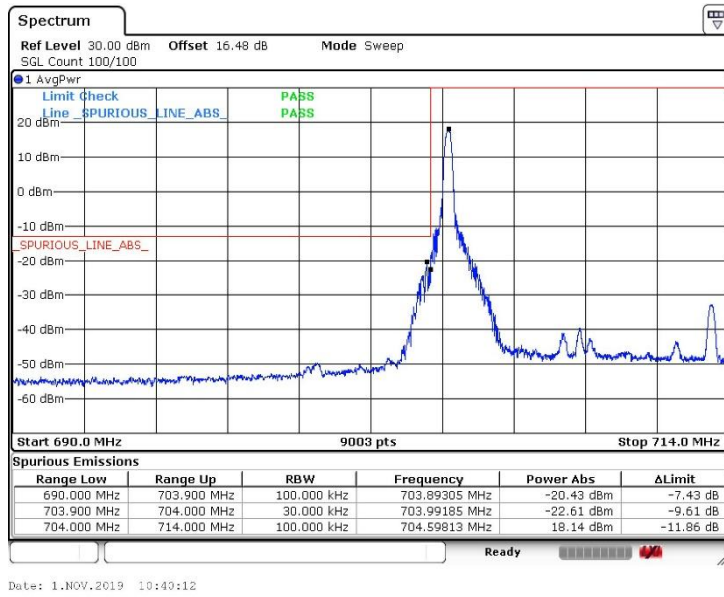

**64QAM, BW 10MHz, RB1-49**  
**Channel: High**

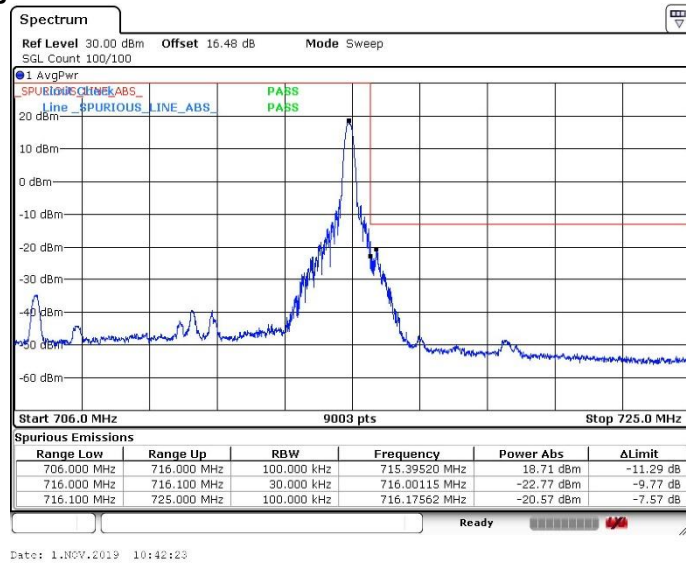





**64QAM, BW 10MHz, RB50-0**  
**Channel: Low**

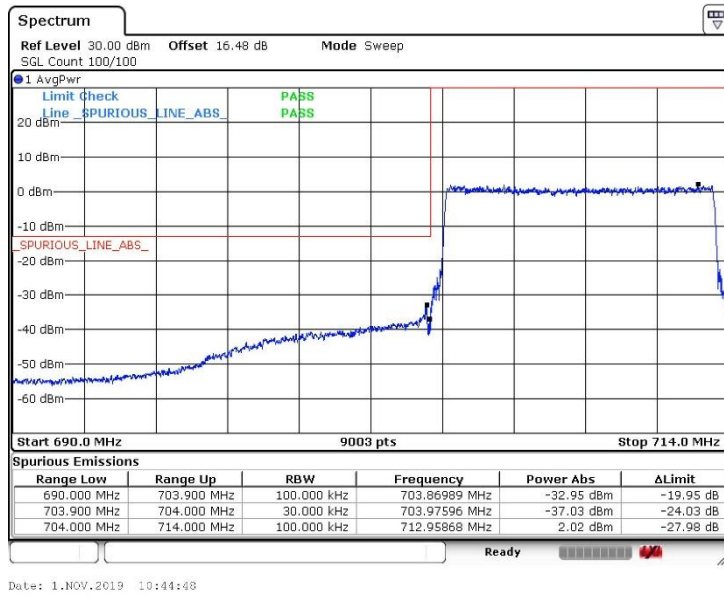

**64QAM, BW 10MHz, RB50-0**  
**Channel: High**

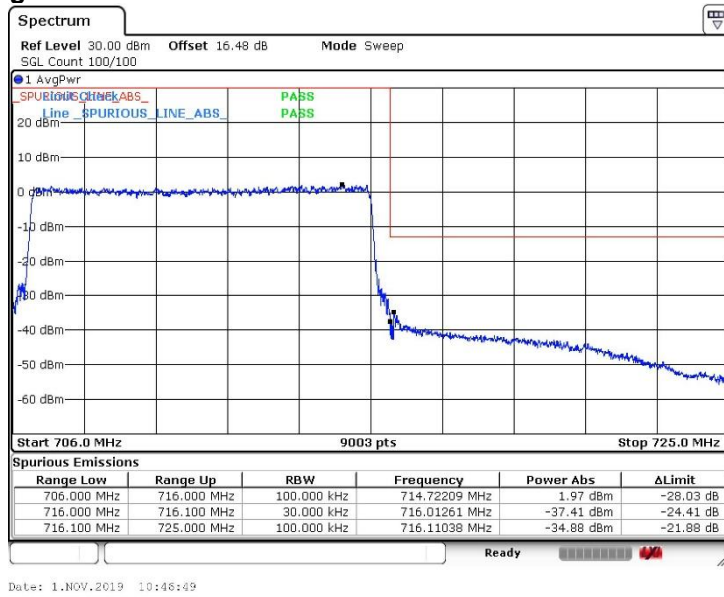



**(Spurious Emissions)**

**Note: Conducted spurious test was measured in the worst case of Effective Radiated Power.**

**QPSK, BW 10MHz, RB1-25**

**Channel: 23780**

**30MHz-5GHz**

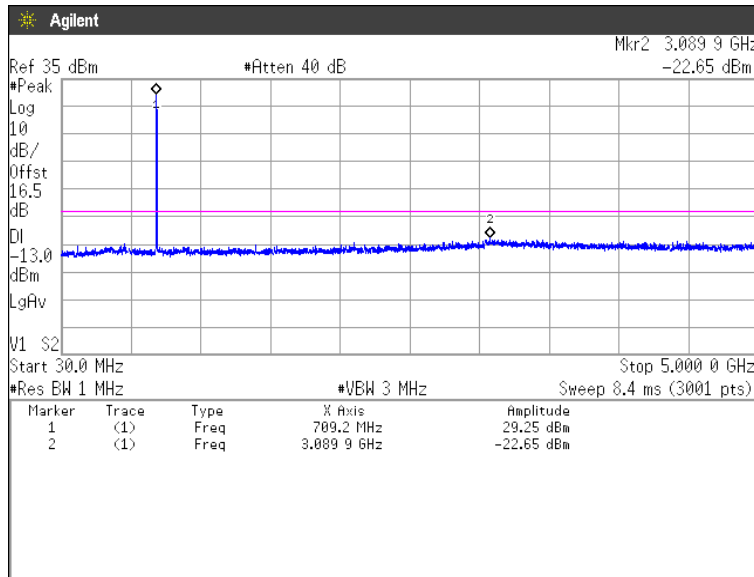

**5GHz-10GHz**

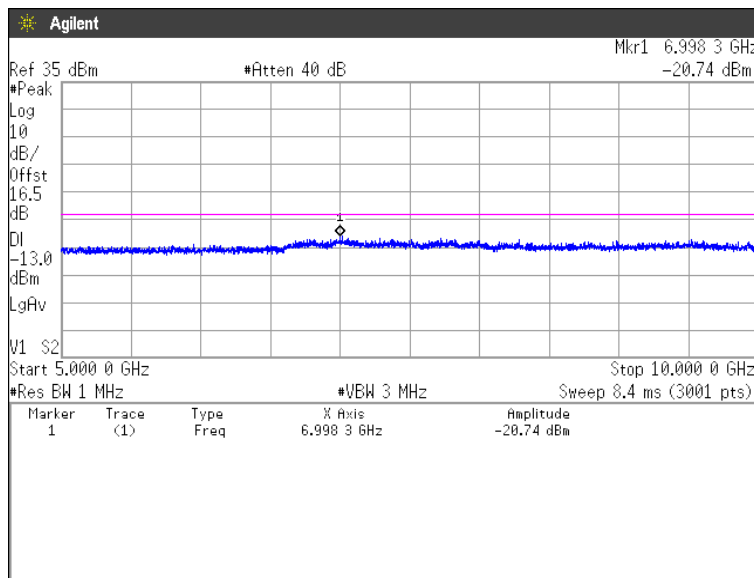



**Channel: 23790  
30MHz-5GHz**

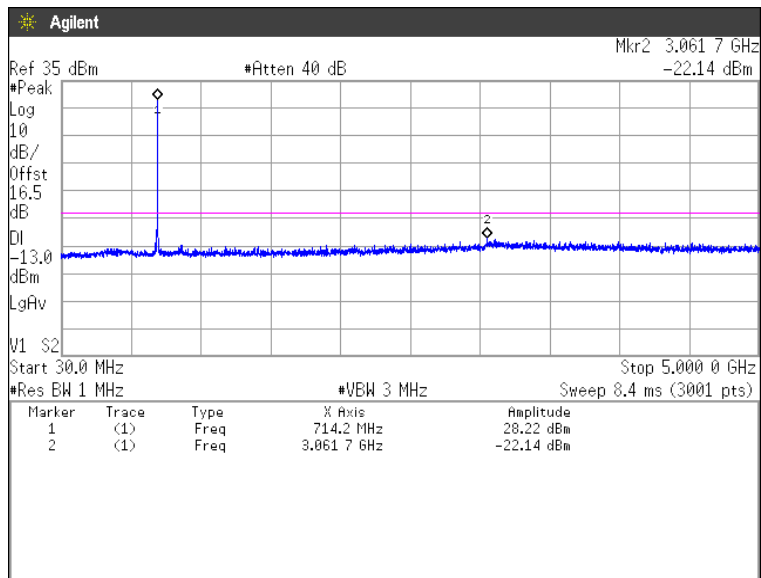

**5GHz-10GHz**

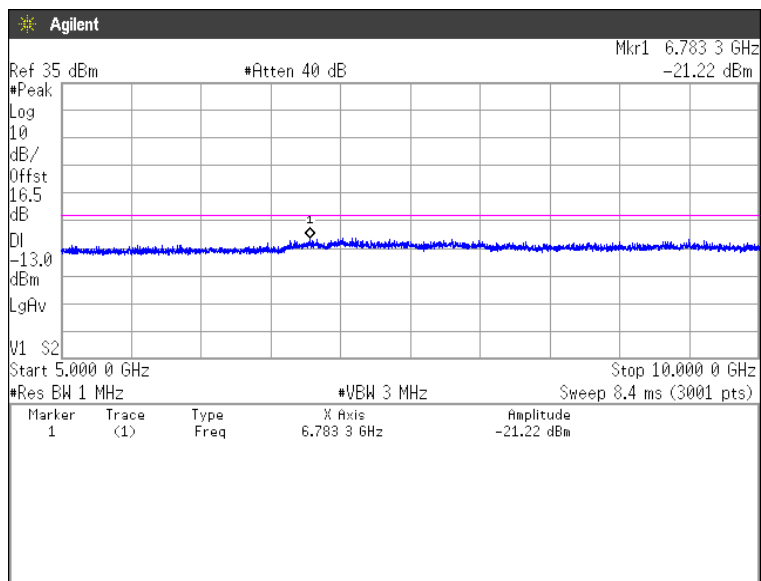



Japan

**Channel: 23800  
30MHz-5GHz**

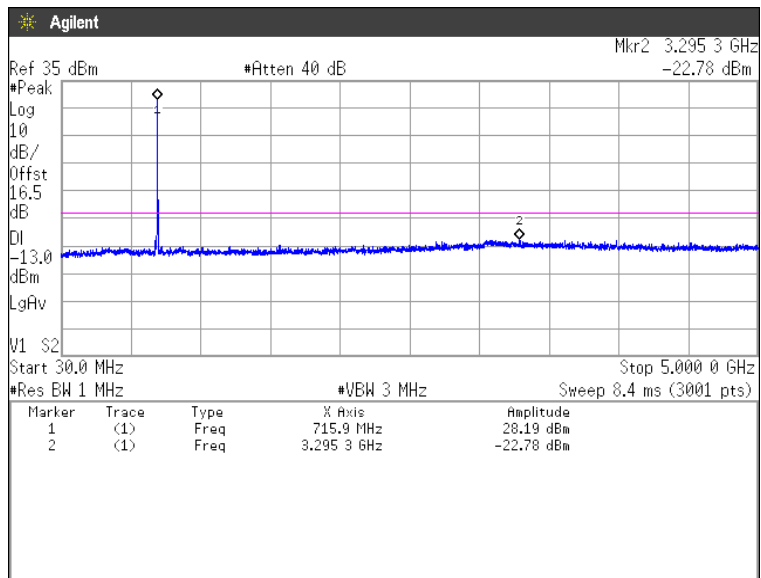

**5GHz-10GHz**

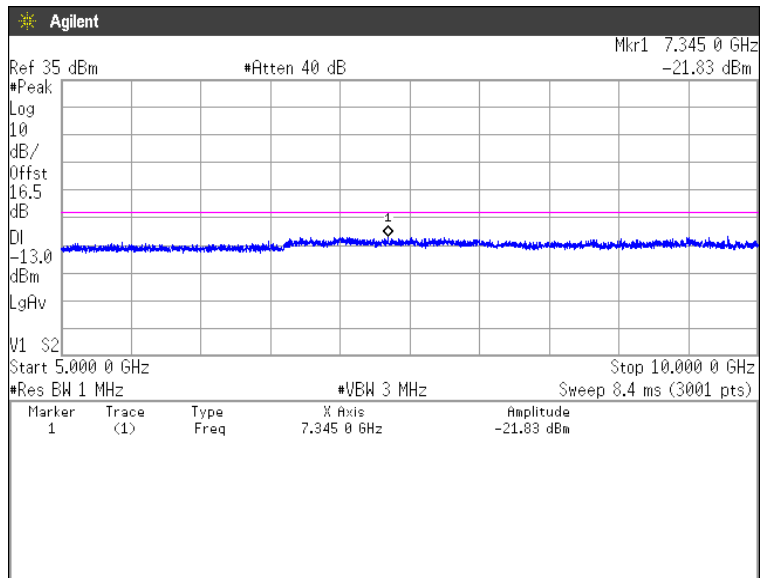

## 4.5 Radiated Emissions and Harmonic Emissions

### 4.5.1 Measurement procedure

#### [FCC 27.53, 2.1053]

##### <Step 1>

The EUT and support equipment are placed on a 1 meter x 1 meter surface, 0.8 meter height styrene foam table. Radiated emission measurements are performed at 3 meter distance with the broadband antenna (Biconical antenna, Log periodic antenna and double ridged guide antenna). The antenna is positioned both the horizontal and vertical planes of polarization and height is varied 1 to 4 meters and stopped at height producing the maximum emission.

The bandwidth of the spectrum analyzer is set to 1 MHz. The turntable is rotated by 360 degrees and stopped at azimuth of producing the maximum emission. The frequency is investigated up to 20GHz.

##### <Step 2>

The substitution antenna is replaced by the transmitter antenna (EUT).

The frequency of the signal generator is adjusted to the measurement frequency.

Level of the signal generator is adjusted to the level that is obtained from step 1, and record the emission level of signal generator.

The spectrum analyzer is set to;

- RBW = 100 kHz for below 1GHz and 1MHz for above 1GHz / VBW  $\geq 3 \times$  RBW
- Detector = Peak
- Trace mode = Max hold
- Sweep time = auto-couple

- Test configuration

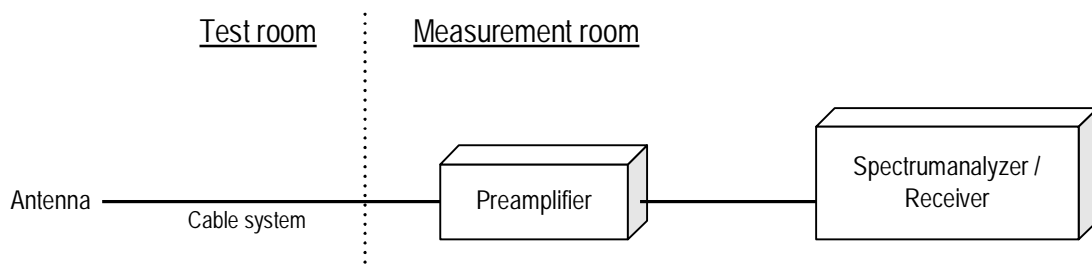



Japan

#### 4.5.2 Calculation method

Result (ERP) = S.G Reading - Cable loss + Antenna Gain  
Margin = Limit - Result (ERP)

Example:

Limit @ 1413 MHz : -13.0 dBm

S.G Reading = -55.6 dBm Cable loss = 1.0dB Ant. Gain = 5.9 dBd

Result = -55.6 - 1.0 + 5.9 = -50.7 dBm

Margin = -13.0 - (-50.7) = 37.7 dB

#### 4.5.3 Limit

-13 dBm or less

**4.5.4 Test data**

Date	: 2-November-2019	Test engineer	:	_____
Temperature	: 21.2 [°C]			
Humidity	: 33.8 [%]			
Test place	: 3m Semi-anechoic chamber			Tadahiro Seino
Date	: 5-6-November-2019	Test engineer	:	_____
Temperature	: 20.3 [°C]			
Humidity	: 50.9 [%]			
Test place	: 3m Semi-anechoic chamber			Chiaki Kanno
Date	: 7-November-2019	Test engineer	:	_____
Temperature	: 20.5 [°C]			
Humidity	: 51.1 [%]			
Test place	: 3m Semi-anechoic chamber			Chiaki Kanno

**[LTE Band X VII]  
 QPSK, BW 5MHz  
 Channel: 23755**

H/V	Frequency [MHz]	S.A Reading [dBm]	S.G Reading [dBm]	Cable loss [dB]	Ant.Gain [dBd]	Result [dBm]	Limit [dBm]	Margin [dB]
H	1413.0	-53.3	-55.3	1.0	10.4	-45.9	-13.0	32.9
H	2119.5	-53.0	-53.8	1.2	11.2	-43.9	-13.0	30.9

**Channel: 23790**

H/V	Frequency [MHz]	S.A Reading [dBm]	S.G Reading [dBm]	Cable loss [dB]	Ant.Gain [dBd]	Result [dBm]	Limit [dBm]	Margin [dB]
H	1420.0	-53.3	-55.3	1.0	10.4	-45.9	-13.0	32.9
H	2130.0	-53.9	-54.9	1.2	11.2	-44.9	-13.0	31.9

**Channel: 23825**

H/V	Frequency [MHz]	S.A Reading [dBm]	S.G Reading [dBm]	Cable loss [dB]	Ant.Gain [dBd]	Result [dBm]	Limit [dBm]	Margin [dB]
H	1427.0	-52.2	-54.2	1.0	10.5	-44.7	-13.0	31.7
H	2140.5	-52.8	-53.8	1.2	11.3	-43.7	-13.0	30.7

**16QAM, BW 5MHz****Channel: 23755**

H/V	Frequency [MHz]	S.A Reading [dBm]	S.G Reading [dBm]	Cable loss [dB]	Ant.Gain [dBd]	Result [dBm]	Limit [dBm]	Margin [dB]
H	1413.0	-53.7	-55.7	1.0	10.4	-46.3	-13.0	33.3
H	2119.5	-54.0	-54.8	1.2	11.2	-44.9	-13.0	31.9

**Channel: 23790**

H/V	Frequency [MHz]	S.A Reading [dBm]	S.G Reading [dBm]	Cable loss [dB]	Ant.Gain [dBd]	Result [dBm]	Limit [dBm]	Margin [dB]
H	1420.0	-53.5	-55.5	1.0	10.4	-46.1	-13.0	33.1
H	2130.0	-54.5	-55.5	1.2	11.2	-45.5	-13.0	32.5

**Channel: 23825**

H/V	Frequency [MHz]	S.A Reading [dBm]	S.G Reading [dBm]	Cable loss [dB]	Ant.Gain [dBd]	Result [dBm]	Limit [dBm]	Margin [dB]
H	1427.0	-53.1	-55.1	1.0	10.5	-45.6	-13.0	32.6
H	2140.5	-53.3	-54.3	1.2	11.3	-44.2	-13.0	31.2

**64QAM, BW 5MHz****Channel: 23755**

H/V	Frequency [MHz]	S.A Reading [dBm]	S.G Reading [dBm]	Cable loss [dB]	Ant.Gain [dBd]	Result [dBm]	Limit [dBm]	Margin [dB]
H	1413.0	-53.8	-55.8	1.0	10.4	-46.4	-13.0	33.4
H	2119.5	-54.0	-54.8	1.2	11.2	-44.9	-13.0	31.9

**Channel: 23790**

H/V	Frequency [MHz]	S.A Reading [dBm]	S.G Reading [dBm]	Cable loss [dB]	Ant.Gain [dBd]	Result [dBm]	Limit [dBm]	Margin [dB]
H	1420.0	-53.6	-55.6	1.0	10.4	-46.2	-13.0	33.2
H	2130.0	-54.7	-55.7	1.2	11.2	-45.7	-13.0	32.7

**Channel: 23825**

H/V	Frequency [MHz]	S.A Reading [dBm]	S.G Reading [dBm]	Cable loss [dB]	Ant.Gain [dBd]	Result [dBm]	Limit [dBm]	Margin [dB]
H	1427.0	-53.9	-55.9	1.0	10.5	-46.4	-13.0	33.4
H	2140.5	-53.6	-54.6	1.2	11.3	-44.5	-13.0	31.5



**QPSK, BW 10MHz****Channel: 23780**

H/V	Frequency [MHz]	S.A Reading [dBm]	S.G Reading [dBm]	Cable loss [dB]	Ant.Gain [dBd]	Result [dBm]	Limit [dBm]	Margin [dB]
H	1418.0	-52.9	-54.7	1.0	10.4	-45.3	-13.0	32.3
H	2127.0	-53.2	-54.1	1.2	11.2	-44.1	-13.0	31.1

**Channel: 23790**

H/V	Frequency [MHz]	S.A Reading [dBm]	S.G Reading [dBm]	Cable loss [dB]	Ant.Gain [dBd]	Result [dBm]	Limit [dBm]	Margin [dB]
H	1420.0	-52.7	-54.5	1.0	10.4	-45.1	-13.0	32.1
H	2130.0	-53.6	-54.6	1.2	11.2	-44.6	-13.0	31.6

**Channel: 23800**

H/V	Frequency [MHz]	S.A Reading [dBm]	S.G Reading [dBm]	Cable loss [dB]	Ant.Gain [dBd]	Result [dBm]	Limit [dBm]	Margin [dB]
H	1422.0	-52.6	-54.6	1.0	10.4	-45.2	-13.0	32.2
H	2133.0	-53.4	-54.2	1.2	11.3	-44.2	-13.0	31.2

**16QAM, BW 10MHz****Channel: 23780**

H/V	Frequency [MHz]	S.A Reading [dBm]	S.G Reading [dBm]	Cable loss [dB]	Ant.Gain [dBd]	Result [dBm]	Limit [dBm]	Margin [dB]
H	1418.0	-53.1	-54.9	1.0	10.4	-45.5	-13.0	32.5
H	2127.0	-53.6	-54.5	1.2	11.2	-44.5	-13.0	31.5

**Channel: 23790**

H/V	Frequency [MHz]	S.A Reading [dBm]	S.G Reading [dBm]	Cable loss [dB]	Ant.Gain [dBd]	Result [dBm]	Limit [dBm]	Margin [dB]
H	1420.0	-53.5	-55.3	1.0	10.4	-45.9	-13.0	32.9
H	2130.0	-54.2	-55.2	1.2	11.2	-45.2	-13.0	32.2

**Channel: 23800**

H/V	Frequency [MHz]	S.A Reading [dBm]	S.G Reading [dBm]	Cable loss [dB]	Ant.Gain [dBd]	Result [dBm]	Limit [dBm]	Margin [dB]
H	1422.0	-53.0	-55.0	1.0	10.4	-45.6	-13.0	32.6
H	2133.0	-53.8	-54.6	1.2	11.3	-44.6	-13.0	31.6

**64QAM, BW 10MHz****Channel: 23780**

H/V	Frequency [MHz]	S.A Reading [dBm]	S.G Reading [dBm]	Cable loss [dB]	Ant.Gain [dBd]	Result [dBm]	Limit [dBm]	Margin [dB]
H	1418.0	-53.2	-55.0	1.0	10.4	-45.6	-13.0	32.6
H	2127.0	-53.7	-54.6	1.2	11.2	-44.6	-13.0	31.6

**Channel: 23790**

H/V	Frequency [MHz]	S.A Reading [dBm]	S.G Reading [dBm]	Cable loss [dB]	Ant.Gain [dBd]	Result [dBm]	Limit [dBm]	Margin [dB]
H	1420.0	-53.5	-55.3	1.0	10.4	-45.9	-13.0	32.9
H	2130.0	-54.3	-55.3	1.2	11.2	-45.3	-13.0	32.3

**Channel: 23800**

H/V	Frequency [MHz]	S.A Reading [dBm]	S.G Reading [dBm]	Cable loss [dB]	Ant.Gain [dBd]	Result [dBm]	Limit [dBm]	Margin [dB]
H	1422.0	-53.2	-55.2	1.0	10.4	-46.7	-13.0	32.8
H	2133.0	-54.1	-54.9	1.2	11.3	-44.9	-13.0	31.9

## 4.6 Frequency Stability

### 4.6.1 Measurement procedure

[FCC 27.54, 2.1055]

The EUT was placed of an inside of an constant temperature chamber as the temperature in the chamber was varied between -30°C and +50°C. The temperature was incremented by 10°C intervals and the unit was allowed to stabilize at each measurement. The frequency drift was measured with the normal Temperature and voltage tolerance and it is presented as the ppm unit.

- Test configuration

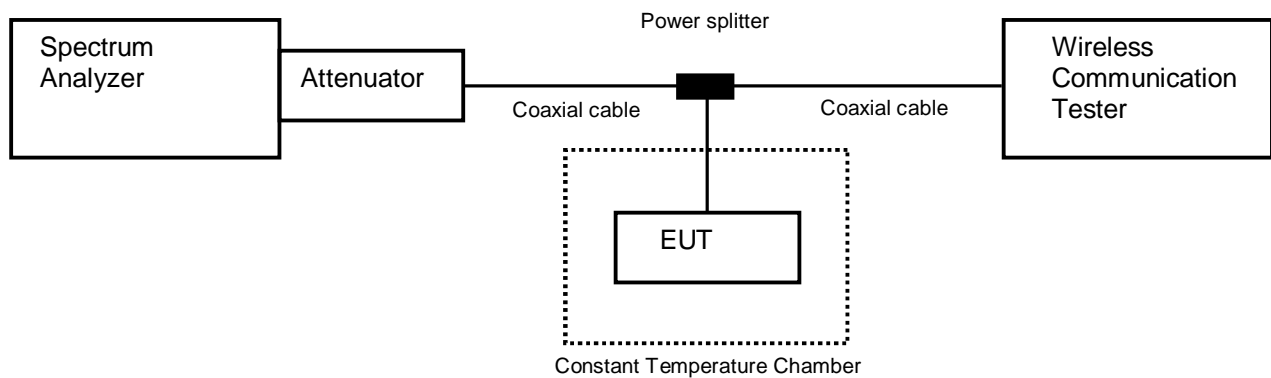

### 4.6.2 Limit

±2.5 ppm

#### 4.6.3 Measurement result

Date : 31-October-2019  
 Temperature : 20.8 [°C]  
 Humidity : 46.1 [%]  
 Test place : Shielded room No.4

Test engineer : Chiaki Kanno

#### [LTE Band X VII] (Channel: 23790)

Limit: $\pm 0.00025\% = \pm 2.5$ ppm					
Power Supply [V]	Temperature [°C]	Measurements Frequency [Hz]	Frequency Tolerance [ppm]	Limit [ppm]	Result
3.85	25(Ref.)	709,999,997	0.00000	$\pm 2.5$	Pass
	50	709,999,996	-0.00159	$\pm 2.5$	Pass
	40	709,999,997	-0.00113	$\pm 2.5$	Pass
	30	709,999,997	-0.00059	$\pm 2.5$	Pass
	20	710,000,003	0.00723	$\pm 2.5$	Pass
	10	710,000,003	0.00825	$\pm 2.5$	Pass
	0	710,000,004	0.00906	$\pm 2.5$	Pass
	-10	710,000,003	0.00772	$\pm 2.5$	Pass
	-20	710,000,003	0.00721	$\pm 2.5$	Pass
	-30	709,999,997	-0.00083	$\pm 2.5$	Pass
3.47	25	709,999,996	-0.00177	$\pm 2.5$	Pass
4.24	25	709,999,997	-0.00046	$\pm 2.5$	Pass



Calculation;

Frequency Tolerance (ppm) = Measurements Frequency (Hz) – Reference Frequency (Hz) / Reference Frequency (Hz) x 1000000

## 5 Measurement Uncertainty

Expanded uncertainties stated are calculated with a coverage Factor k=2.  
 Please note that these results are not taken into account when measurement uncertainty considerations contained in ETSI TR 100 028 Parts 1 and 2 determining compliance or non-compliance with test result.

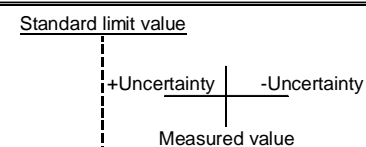
Test item	Measurement uncertainty
Conducted emission, AMN (9 kHz – 150 kHz)	±3.8 dB
Conducted emission, AMN (150 kHz – 30 MHz)	±3.3 dB
Radiated emission ( 9kHz – 30 MHz)	±3.1 dB
Radiated emission (30 MHz – 1000 MHz)	±4.9 dB
Radiated emission (1 GHz – 6 GHz)	±4.8 dB
Radiated emission (6 GHz – 18 GHz)	±5.1 dB
Radiated emission (18 GHz – 40 GHz)	±5.8 dB
Radio Frequency	±1.4 * 10 <sup>-8</sup>
RF power, conducted	±0.6 dB
Temperature	±0.6 °C
Humidity	±1.2 %
Voltage (DC)	±0.4 %
Voltage (AC, <10kHz)	±0.2 %

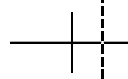
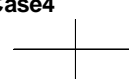
Judge	Measured value and standard limit value
PASS	<p><b>Case1</b></p>  <p>Even if it takes uncertainty into consideration, a standard limit value is fulfilled.</p>
	<p><b>Case2</b></p>  <p>Although measured value is in a standard limit value, a limit value won't be fulfilled if uncertainty is taken into consideration.</p>
FAIL	<p><b>Case3</b></p>  <p>Although measured value exceeds a standard limit value, a limit value will be fulfilled if uncertainty is taken into consideration.</p>
	<p><b>Case4</b></p>  <p>Even if it takes uncertainty into consideration, a standard limit value isn't fulfilled.</p>



## 6 Laboratory Information

Testing was performed and the report was issued at:

### **TÜV SÜD Japan Ltd. Yonezawa Testing Center**

Address: 5-4149-7 Hachimanpara, Yonezawa-shi, Yamagata, 992-1128 Japan

Phone: +81-238-28-2881

Fax: +81-238-28-2888

### **Accreditation and Registration**

NVLAP

LAB CODE: 200306-0

VLAC

Accreditation No.: VLAC-013

BSMI

Laboratory Code: SL2-IN-E-6018, SL2-A1-E-6018

Innovation, Science and Economic Development Canada

Site number	Facility	Expiration date
4224A-4	3 m Semi-anechoic chamber	27-November-2020
4224A-5	10 m Semi-anechoic chamber No. 1	27-November-2020
4224A-6	10 m Semi-anechoic chamber No. 2	14-December-2019

VCCI Council

Registration number	Expiration date
A-0166	03-July-2021

## Appendix A. Test Equipment

### Antenna port conducted test

Equipment	Company	Model No.	Serial No.	Cal. Due	Cal. Date
Spectrum analyzer	Agilent Technologies	E4440A	US44302655	31-Aug-2020	05-Aug-2019
Spectrum analyzer	ROHDE&SCHWARZ	FSV40	101731	31-Dec-2019	07-Dec-2018
Attenuator	Weinschel	56-10	J4180	31-Jul-2020	18-Jul-2019
Microwave cable	HUBER+SUHNER	SUCOFLEX 104/1m	199120/4	31-Dec-2019	18-Dec-2018
Microwave cable	HUBER+SUHNER	SUCOFELX102/2m	MY3385/2	31-Mar-2020	08-Mar-2019
Power divider	ANRITSU	K240B	020205	31-Jul-2020	19-Jul-2019
Wideband Radio Frequency Tester	ROHDE&SCHWARZ	CMW500	126079	31-Oct-2019	12-Oct-2018
Wideband Radio Frequency Tester	ROHDE&SCHWARZ	CMW500	116338	31-Aug-2020	27-Aug-2019
Temperature and humidity chamber	ESPEC	PL1KP	14007261	30-Sep-2020	03-Sep-2019

### Radiated emission

Equipment	Company	Model No.	Serial No.	Cal. Due	Cal. Date
EMI Receiver	ROHDE&SCHWARZ	ESCI	100765	30-Sep-2020	25-Sep-2019
Spectrum analyzer	Agilent Technologies	E4447A	MY46180188	30-Apr-2020	16-Apr-2019
Spectrum analyzer	Agilent Technologies	E4440A	US40420937	30-Sep-2020	26-Sep-2019
Preamplifier	SONOMA	310	372170	30-Sep-2020	26-Sep-2019
Biconical antenna	Schwarzbeck	VHA9103/BBA9106	VHA91032155	30-Sep-2020	25-Sep-2019
Log periodic antenna	Schwarzbeck	UHALP9111B	345	31-Aug-2020	27-Aug-2019
Attenuator	TAMAGAWA.ELEC	CFA-01/6dB	N/A(S465)	31-May-2020	17-May-2019
Attenuator	TAMAGAWA.ELEC	CFA-10/3dB	N/A(S503)	31-Jul-2020	17-Jul-2019
Preamplifier	TSJ	MLA-100M18-B02-40	1929118	31-Jan-2020	17-Jan-2019
Attenuator	AEROFLEX	26A-10	081217-08	31-Jan-2020	17-Jan-2019
Double ridged guide antenna	ETS LINDGREN	3117	00224193	31-Jan-2020	23-Jan-2019
Attenuator	Agilent Technologies	8491B	MY39268633	31-Mar-2020	08-Mar-2019
Double ridged guide antenna	A.H.Systems Inc.	SAS-574	469	31-Aug-2020	28-Aug-2019
Preamplifier	TSJ	MLA-1840-B03-35	1240332	31-Aug-2020	28-Aug-2019
Notch Filter	Micro-Tronics	HPM50115	004	31-Jul-2020	18-Jul-2019
Signal generator	ROHDE&SCHWARZ	SMB100A	177525	31-Jul-2020	18-Jul-2019
RF power amplifier	R&K	CGA020M602-2633R	B40240	31-May-2020	16-May-2019
Microwave cable	HUBER+SUHNER	SUCOFELX102/2m	31648	31-Mar-2020	08-Mar-2019
Dipole antenna	Schwarzbeck	VHAP	1021	31-Aug-2020	15-Aug-2019
Dipole antenna	Schwarzbeck	UHAP	993	31-Aug-2020	15-Aug-2019
Double ridged guide antenna	EMCO	3115	00058532	29-Feb-2020	12-Feb-2019
Double ridged guide antenna	ETS LINDGREN	3117	00218815	31-Dec-2019	27-Dec-2018
Wideband Radio Frequency Tester	ROHDE&SCHWARZ	CMW500	126079	31-Oct-2019	12-Oct-2018
Wideband Radio Frequency Tester	ROHDE&SCHWARZ	CMW500	116338	31-Aug-2020	27-Aug-2019
Microwave cable	HUBER+SUHNER	SUCOFLEX104/9m	MY30037/4	31-Jan-2020	16-Jan-2019
		SUCOFLEX104/1m	my24610/4	31-Jan-2020	16-Jan-2019
		SUCOFLEX104/8m	SN MY30031/4	31-Jan-2020	16-Jan-2019
		SUCOFLEX104	MY32976/4	31-Jan-2020	16-Jan-2019
		SUCOFLEX104/1.5m	MY19309/4	31-Jan-2020	16-Jan-2019
		SUCOFLEX104/7m	41625/6	31-Jan-2020	16-Jan-2019
PC	DELL	DIMENSION E521	75465BX	N/A	N/A
Software	TOYO Corporation	EP5/RE-AJ	0611193/V5.6.0	N/A	N/A
Absorber	RIKEN	PFP30	N/A	N/A	N/A
3m Semi an-echoic Chamber	TOKIN	N/A	N/A(9002-NSA)	31-May-2020	14-May-2019
3m Semi an-echoic Chamber	TOKIN	N/A	N/A(9002-SVSWR)	31-May-2020	13-May-2019

\*: The calibrations of the above equipment are traceable to NIST or equivalent standards of the reference organizations.

## Contents

<b>1</b>	<b>Summary of Test</b> .....	<b>3</b>
1.1	Modification history of the test report.....	3
1.2	Standards.....	3
1.3	Test methods.....	3
1.4	Deviation from standards.....	3
1.5	List of applied test(s) of the EUT.....	3
1.6	Test information.....	3
1.7	Test set up.....	3
1.8	Test period.....	3
<b>2</b>	<b>Equipment Under Test</b> .....	<b>4</b>
2.1	EUT information.....	4
2.2	Modification to the EUT.....	5
2.3	Variation of family model(s).....	5
2.4	Description of test mode.....	5
<b>3</b>	<b>Configuration of Equipment</b> .....	<b>6</b>
3.1	Equipment used.....	6
3.2	System configuration.....	6
<b>4</b>	<b>Test Result</b> .....	<b>7</b>
4.1	Effective Radiated Power.....	7
4.2	Peak to Average Ratio.....	11
4.3	Occupied Bandwidth.....	16
4.4	Band Edge Spurious and Harmonic at Antenna Terminals.....	20
4.5	Radiated Emissions and Harmonic Emissions.....	37
4.6	Frequency Stability.....	43
<b>5</b>	<b>Measurement Uncertainty</b> .....	<b>45</b>
<b>6</b>	<b>Laboratory Information</b> .....	<b>46</b>
	<b>Appendix A. Test Equipment</b> .....	<b>47</b>



## 1 Summary of Test

### 1.1 Modification history of the test report

Document Number	Modification History	Issue Date
JPD-TR-19184-0	First Issue	Refer to the cover page

### 1.2 Standards

CFR47 FCC Part 27 Subpart C  
CFR47 FCC Part 27 Subpart H

### 1.3 Test methods

KDB 971168 D01 Power Meas License Digital Systems v03r01  
ANSI/TIA/EIA-603-D-2010

### 1.4 Deviation from standards

None

### 1.5 List of applied test(s) of the EUT

Test item section	Test item	Condition	Result	Remark
2.1046	Conducted Output Power	Conducted	PASS	*1
27.50	Effective Radiated Power	Radiated	PASS	-
27.50	Peak to Average Ratio	Conducted	PASS	-
2.1049	Occupied Bandwidth	Conducted	PASS	-
27.53 2.1051	Band Edge Spurious and Harmonic at Antenna Terminal	Conducted	PASS	-
27.53 2.1053	Radiated emissions and Harmonic Emissions	Radiated	PASS	-
27.54 2.1055	Frequency Stability	Conducted	PASS	-

\*1: Refer to RF Exposure Report (Test Report\_SAR)

### 1.6 Test information

None

### 1.7 Test set up

Table-top

### 1.8 Test period

15-October-2019 - 7-November-2019

## 2 Equipment Under Test

### 2.1 EUT information

Applicant	KYOCERA Corporation Yokohama Office 2-1-1 Kagahara, Tsuzuki-ku Yokohama-shi, Kanagawa, Japan Phone: +81-45-943-6253 Fax: +81-45-943-6314
Equipment Under Test (EUT)	Mobile Phone
Model number	CB70
Serial number	N/A
Trade name	Kyocera
Number of sample(s)	1
EUT condition	Pre-Production
Power rating	Battery: DC 3.85 V
Size	(W) 71.0 × (D) 159.0 × (H) 8.9 mm
Environment	Indoor and Outdoor use
Terminal limitation	-20°C to 60°C
Hardware version	DMT2
Software version	0.410HA
Firmware version	Not applicable
RF Specification	
Frequency of Operation	Up Link LTE Band X VII: 704-716 MHz  Down Link LTE Band X VII: 734-746 MHz
Modulation type	QPSK, 16QAM, 64QAM
Emission designator	BW 5M QPSK: 4M55G7D, 16QAM: 4M53W7D, 64QAM: 4M55W7D BW 10M QPSK: 9M05G7D, 16QAM: 9M03W7D, 64QAM: 9M02W7D
Effective Radiated Power (E.R.P.)	QPSK: 0.0692 W (18.4 dBm) 16QAM: 0.0603 W (17.8 dBm) 64QAM: 0.0389 W (15.9 dBm)
Antenna type	Internal antenna
Antenna gain	-7.5 dBi

## 2.2 Modification to the EUT

The table below details modifications made to the EUT during the test project.

Modification State	Description of Modification	Modification fitted by	Date of Modification
Model: CB70, Serial Number: N/A			
0	As supplied by the applicant	Not Applicable	Not Applicable

## 2.3 Variation of family model(s)

### 2.3.1 List of family model(s)

Not applicable

### 2.3.2 Reason for selection of EUT

Not applicable

## 2.4 Description of test mode

The EUT had been tested under operating condition.  
There are three channels have been tested as following:

Band	Modulation	Bandwidth	Channel	Frequency [MHz]
LTE Band X VII	QPSK, 16QAM, 64QAM	5 MHz	23755	706.5
			23790	710.0
			23825	713.5
		10 MHz	23780	709.0
			23790	710.0
			23800	711.0

The field strength of spurious emissions was measured at each position of all three axis X, Y and Z to compare the level, and the maximum noise.

The worst emission was found in X-axis and the worst case recorded.

Pre-scan has been conducted to determine the worst-case mode from all possible combinations between available modulations, data rates and antenna ports.



### 3 Configuration of Equipment

Numbers assigned to equipment on the diagram in “3.2 System configuration” correspond to the list in “3.1 Equipment used”.

Cabling and setup(s) were taken into consideration and test data was taken under worse case condition.

#### 3.1 Equipment used

No.	Equipment	Company	Model No.	Serial No.	FCC ID/DoC	Comment
1	Mobile Phone	KYOCERA	CB70	N/A	JOYCB70	EUT

#### 3.2 System configuration

1. Mobile Phone  
(EUT)

## 4 Test Result

### 4.1 Effective Radiated Power

#### 4.1.1 Measurement procedure

##### [FCC 27.50]

##### <Step 1>

The EUT and support equipment are placed on a 1 meter x 1 meter surface, 0.8 meter height styrene foam table. Radiated emission measurements are performed at 3 meter distance with the broadband antenna (Log periodic antenna). The antenna is positioned both the horizontal and vertical planes of polarization and height is varied 1 to 4 meters and stopped at height producing the maximum emission. The bandwidth of the spectrum analyzer is set to 1 MHz. The turntable is rotated by 360 degrees and stopped at azimuth of producing the maximum emission.

##### <Step 2>

The substitution antenna is replaced by the transmitter antenna (EUT).

The frequency of the signal generator is adjusted to the measurement frequency.

Level of the signal generator is adjusted to the level that is obtained from step 1, and record the emission level of signal generator.

The spectrum analyzer is set to;

- a) Span = 1.5 times the OBW
- b) RBW = 1-5% of the expected OBW, not to exceed 1 MHz
- c) VBW  $\geq 3 \times$  RBW
- d) Number of sweep points  $\geq 2 \times$  span / RBW
- e) Sweep time = auto-couple
- f) Detector = RMS (power averaging)
- g) If the EUT can be configured to transmit continuously (i.e., burst duty cycle  $\geq 98\%$ ), then set the trigger to free run.
- h) If the EUT cannot be configured to transmit continuously (i.e., burst duty cycle  $< 98\%$ ), then use a sweep trigger with the level set to enable triggering only on full power bursts and configure the EUT to transmit at full power for the entire duration of each sweep. Ensure that the sweep time is less than or equal to the transmission burst duration.
- i) Trace average at least 100 traces in power averaging (i.e., RMS) mode.
- j) Compute the power by integrating the spectrum across the OBW of the signal using the instrument's band power measurement function, with the band limits set equal to the OBW band edges.

If the instrument does not have a band power function, then sum the spectrum levels (in linear power units) at intervals equal to the RBW extending across the entire OBW of the spectrum.

- Test configuration

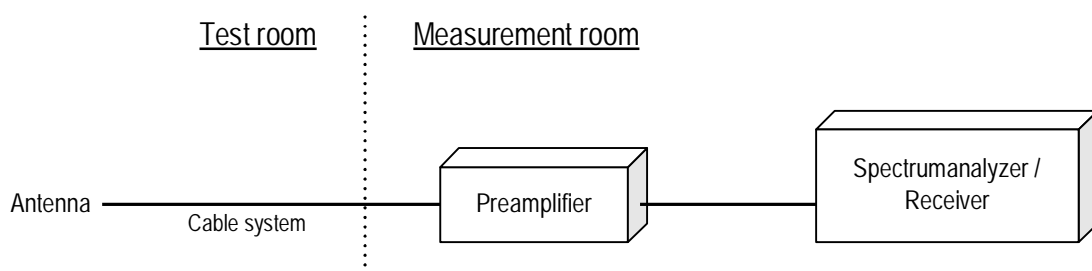



#### 4.1.2 Calculation method

Result (ERP) = S.G Reading - Cable loss + Antenna Gain  
Margin = Limit – Result (ERP)

Example:

Limit @ 710MHz : 34.7 dBm

S.G Reading = 25.5 dBm Cable loss = 0.7 dB Ant. Gain = -10.1 dBd

Result = 25.5 - 0.7 + (-10.1) = 14.8 dBm

Margin = 34.7 – 14.8 = 19.9 dB

#### 4.1.3 Limit

3 W (34.7 dBm)

**4.1.4 Test data**

Date : 15-October-2019  
 Temperature : 18.6 [°C]  
 Humidity : 61.3 [%]  
 Test place : 3m Semi-anechoic chamber

Test engineer : Taiki Watanabe

Date : 16-October-2019  
 Temperature : 22.1 [°C]  
 Humidity : 51.3 [%]  
 Test place : 3m Semi-anechoic chamber

Test engineer : Taiki Watanabe

Date : 18-October-2019  
 Temperature : 22.7 [°C]  
 Humidity : 42.8 [%]  
 Test place : 3m Semi-anechoic chamber

Test engineer : Chiaki Kanno

Date : 6-November-2019  
 Temperature : 21.7 [°C]  
 Humidity : 47.3 [%]  
 Test place : 3m Semi-anechoic chamber

Test engineer : Chiaki Kanno

Date : 7-November-2019  
 Temperature : 20.5 [°C]  
 Humidity : 51.1 [%]  
 Test place : 3m Semi-anechoic chamber

Test engineer : Chiaki Kanno

**[LTE Band X VII]  
QPSK, BW 5MHz**

H/V	Frequency [MHz]	S.A Reading [dBm]	S.G Reading [dBm]	Cable loss [dB]	Ant.Gain [dBd]	Result [dBm]	Limit [dBm]	Margin [dB]
H	706.5	-16.5	24.3	0.7	-5.6	18.0	34.7	16.7
H	710.0	-16.7	24.4	0.7	-5.6	18.0	34.7	16.7
H	713.5	-16.7	24.7	0.7	-5.7	18.3	34.7	16.4

**16QAM, BW 5MHz**

H/V	Frequency [MHz]	S.A Reading [dBm]	S.G Reading [dBm]	Cable loss [dB]	Ant.Gain [dBd]	Result [dBm]	Limit [dBm]	Margin [dB]
H	706.5	-17.4	23.4	0.7	-5.6	17.1	34.7	17.6
H	710.0	-17.1	24.0	0.7	-5.6	17.6	34.7	17.1
H	713.5	-17.2	24.2	0.7	-5.7	17.8	34.7	16.9

**64QAM, BW 5MHz**

H/V	Frequency [MHz]	S.A Reading [dBm]	S.G Reading [dBm]	Cable loss [dB]	Ant.Gain [dBd]	Result [dBm]	Limit [dBm]	Margin [dB]
H	706.5	-18.9	21.9	0.7	-5.6	15.6	34.7	19.1
H	710.0	-19.3	21.8	0.7	-5.6	15.4	34.7	19.3
H	713.5	-19.6	21.8	0.7	-5.7	15.4	34.7	19.3

**QPSK, BW 10MHz**

H/V	Frequency [MHz]	S.A Reading [dBm]	S.G Reading [dBm]	Cable loss [dB]	Ant.Gain [dBd]	Result [dBm]	Limit [dBm]	Margin [dB]
H	709.0	-16.3	24.7	0.7	-5.6	18.3	34.7	16.4
H	710.0	-17.1	24.0	0.7	-5.6	17.6	34.7	17.1
H	711.0	-16.4	24.8	0.7	-5.6	18.4	34.7	16.3

**16QAM, BW 10MHz**

H/V	Frequency [MHz]	S.A Reading [dBm]	S.G Reading [dBm]	Cable loss [dB]	Ant.Gain [dBd]	Result [dBm]	Limit [dBm]	Margin [dB]
H	709.0	-17.0	24.0	0.7	-5.6	17.6	34.7	17.1
H	710.0	-16.9	24.2	0.7	-5.6	17.8	34.7	16.9
H	711.0	-17.3	23.9	0.7	-5.6	17.5	34.7	17.2

**64QAM, BW 10MHz**

H/V	Frequency [MHz]	S.A Reading [dBm]	S.G Reading [dBm]	Cable loss [dB]	Ant.Gain [dBd]	Result [dBm]	Limit [dBm]	Margin [dB]
H	709.0	-19.0	22.0	0.7	-5.6	15.6	34.7	19.1
H	710.0	-18.8	22.3	0.7	-5.6	15.9	34.7	18.8
H	711.0	-18.9	22.3	0.7	-5.6	15.9	34.7	18.8



## 4.2 Peak to Average Ratio

### 4.2.1 Measurement procedure

#### [FCC 27.50]

The peak to average ratio was measured with a spectrum analyzer connected to the antenna terminal.

The spectrum analyzer is set to;

- a) Power Stat CCDF mode
- b) Set resolution / measurement bandwidth  $\geq$  signal's occupied bandwidth.
- c) Set the number of counts to a value that stabilizes the measured CCDF curve.
- d) Set the measurement interval as follows:
  - 1) For continuous transmissions, set to 1ms.
  - 2) For burst transmissions, employ an external trigger that is synchronized with the EUT burst timing sequence, or use the internal burst trigger with a trigger level that allows the burst duration.
- e) Record the maximum PAPR level associated with a probability of 0.1%.

- Test configuration

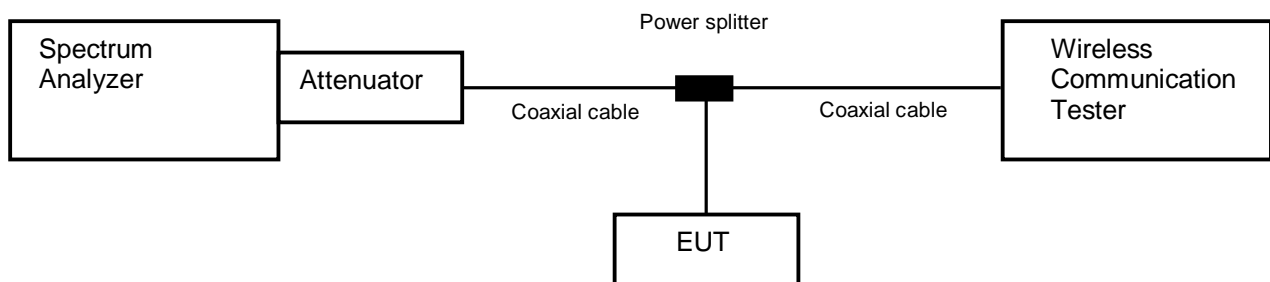

### 4.2.2 Limit

13 dB or less

#### 4.2.3 Measurement result

Date : 17-October-2019

Temperature : 22.6 [°C]

Humidity : 45.5 [%]

Test place : Shielded room No.4

Test engineer :

Chiaki Kanno

Band	Channel	Frequency [MHz]	Modulation	BW [MHz]	RB	Peak to Average Power Ratio [dB]	Limit [dB]
LTE Band X VII	23790	710.0	QPSK	5	25-0	5.82	13
				10	50-0	4.61	13
			16QAM	5	25-0	6.50	13
				10	50-0	6.24	13
			64QAM	5	25-0	6.67	13
				10	50-0	6.53	13

4.2.4 Trace data

[LTE Band X VII]  
 Channel: 23790  
 QPSK, BW 5MHz, RB25-0

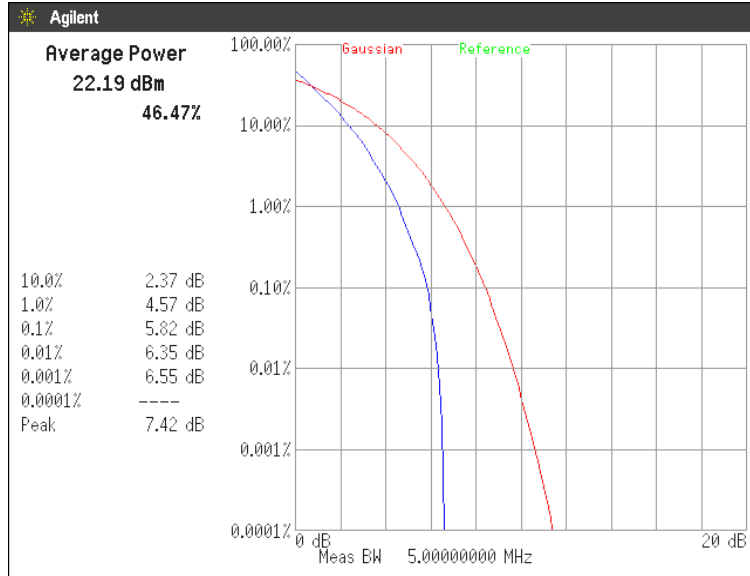

QPSK, BW 10MHz, RB50-0

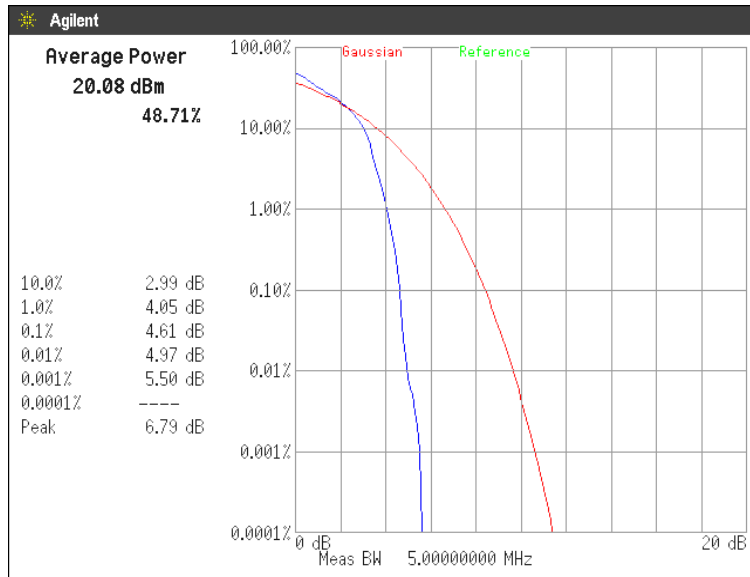

**16QAM, BW 5MHz, RB25-0**

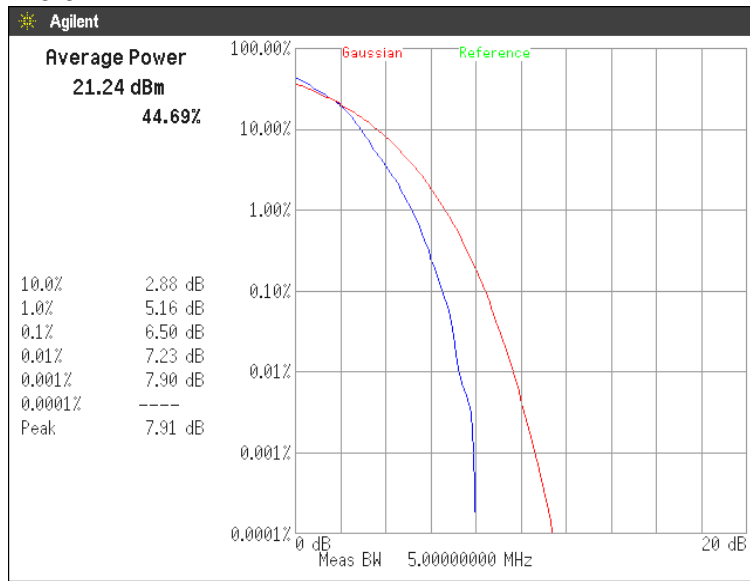

**16QAM, BW 10MHz, RB50-0**

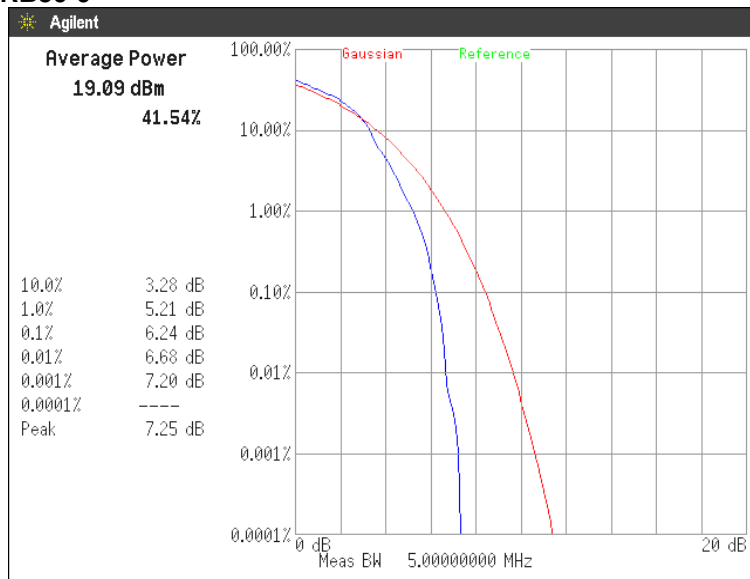

**64QAM, BW 5MHz, RB25-0**

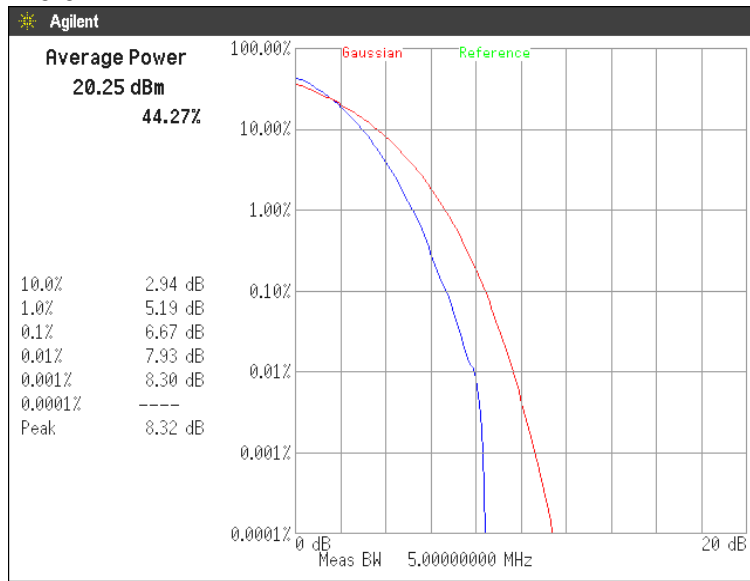

**64QAM, BW 10MHz, RB50-0**

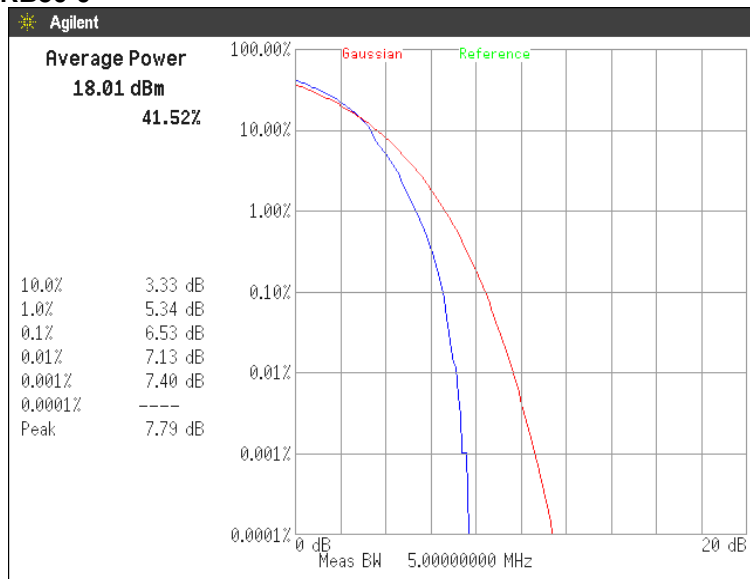

### 4.3 Occupied Bandwidth

#### 4.3.1 Measurement procedure

##### [FCC 2.1049]

The Occupied bandwidth was measured with a spectrum analyzer connected to the antenna terminal.

The spectrum analyzer is set to;

- a) RBW = 1-5% of the expected OBW & VBW  $\geq 3 \times$  RBW
- b) Detector = Peak
- c) Trace mode = Max hold
- d) Sweep time = auto-couple

- Test configuration

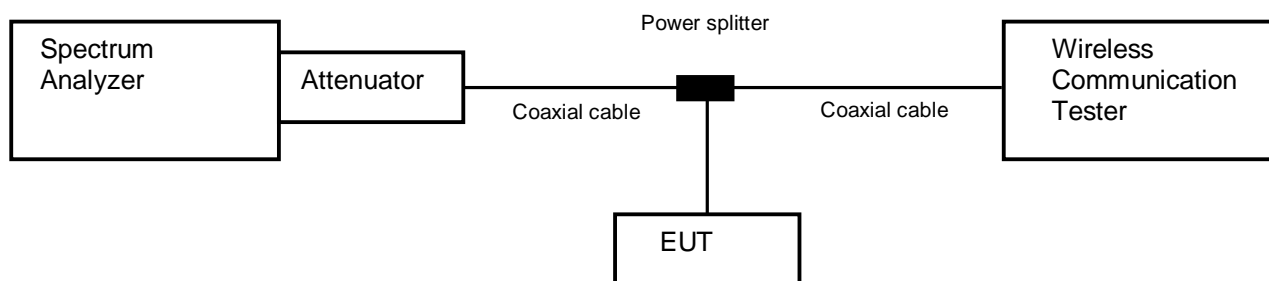

#### 4.3.2 Limit

None

### 4.3.3 Measurement result

Date : 17-October-2019

Temperature : 22.6 [°C]

Humidity : 45.5 [%]

Test place : Shielded room No.4

Test engineer :

Chiaki Kanno

BW	Mode	UL RB Allocation	UL RB Start	Frequency [MHz]	26dB Bandwidth [MHz]	99% OBW [MHz]
5MHz	QPSK	12	7	710.0	3.047	2.2952
		25	0		5.210	4.5467
	16QAM	12	7	710.0	2.987	2.2949
		25	0		5.227	4.5262
	64QAM	12	7	710.0	3.006	2.2822
		25	0		5.207	4.5530
10MHz	QPSK	25	12	710.0	5.786	4.6762
		50	0		10.277	9.0493
	16QAM	25	12	710.0	5.738	4.6363
		50	0		10.135	9.0310
	64QAM	25	12	710.0	5.749	4.6749
		50	0		10.116	9.0224



### 4.3.4 Trace data

[LTE Band X VII]  
Channel: 23790

#### QPSK, BW 5MHz

##### RB12-7

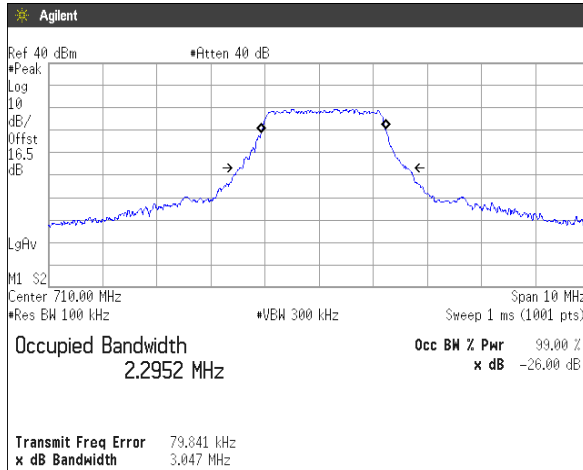

##### RB25-0

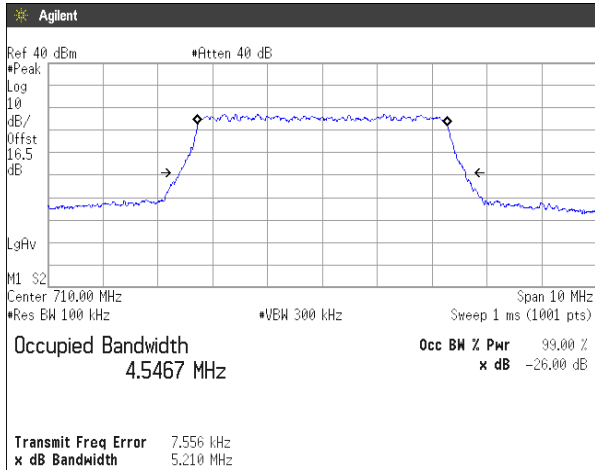

#### 16QAM, BW 5MHz

##### RB12-7

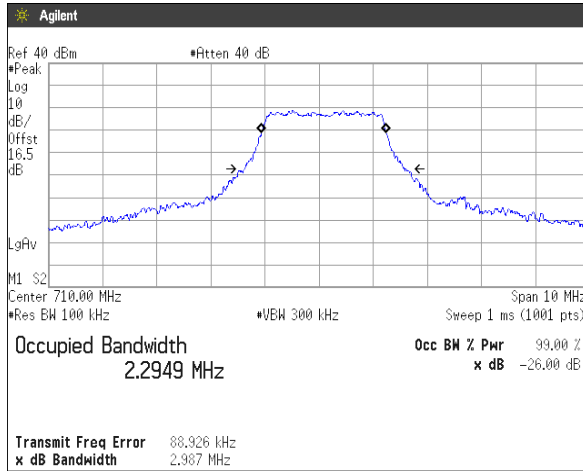

##### RB25-0

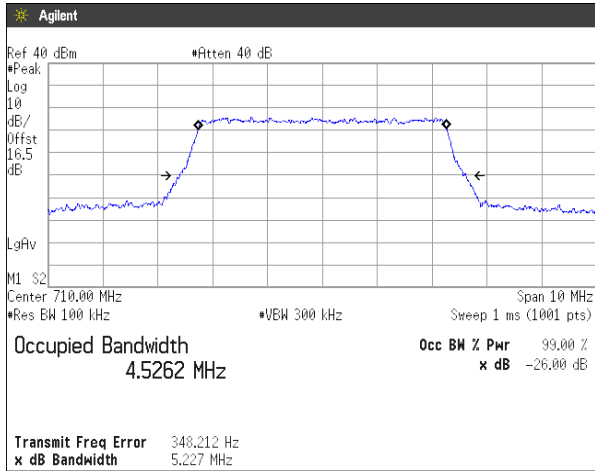

#### 64QAM, BW 5MHz

##### RB12-7

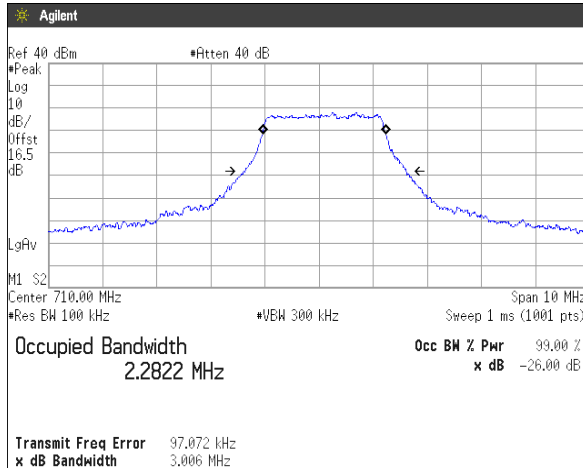

##### RB25-0

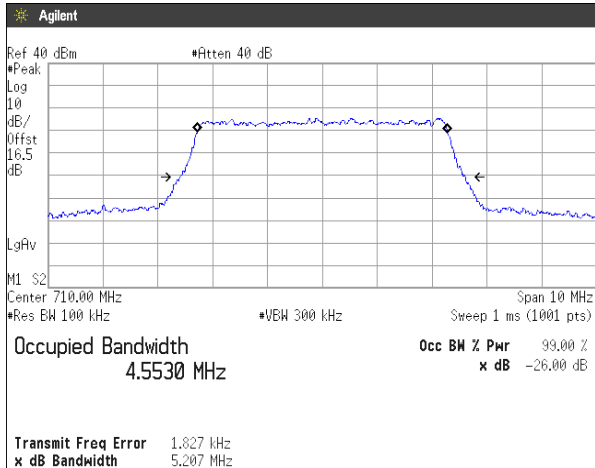





**QPSK, BW 10MHz**

**RB25-12**

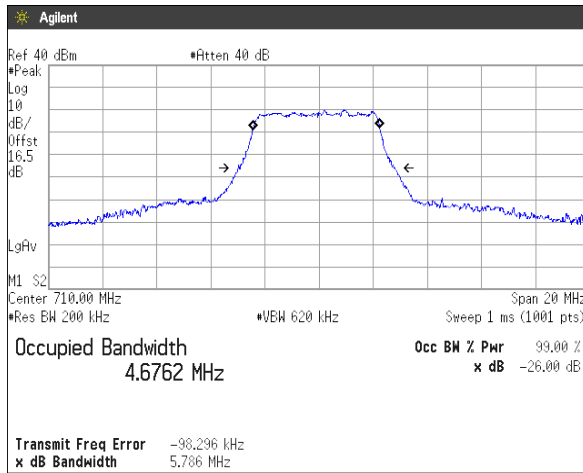

**RB50-0**

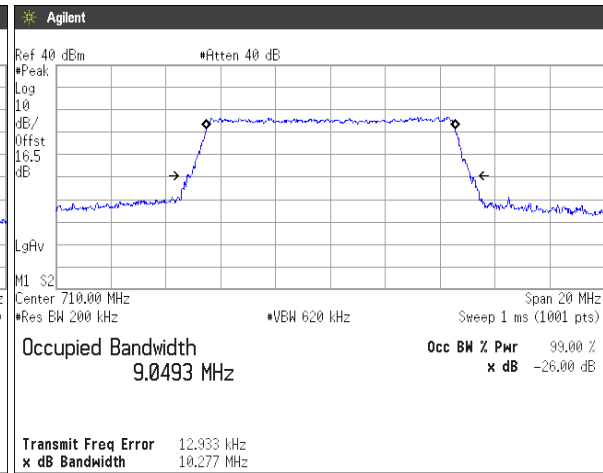

**16QAM, BW 10MHz**

**RB25-12**

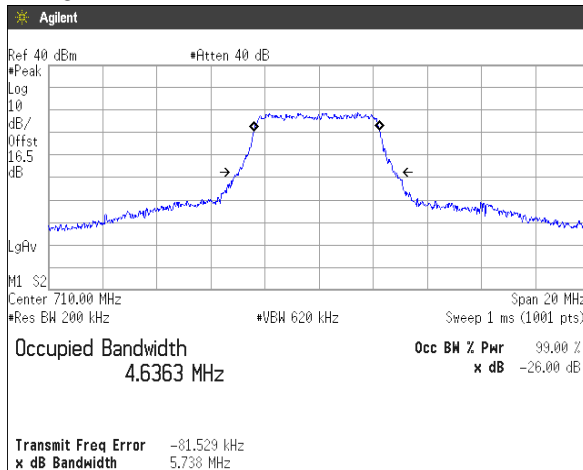

**RB50-0**

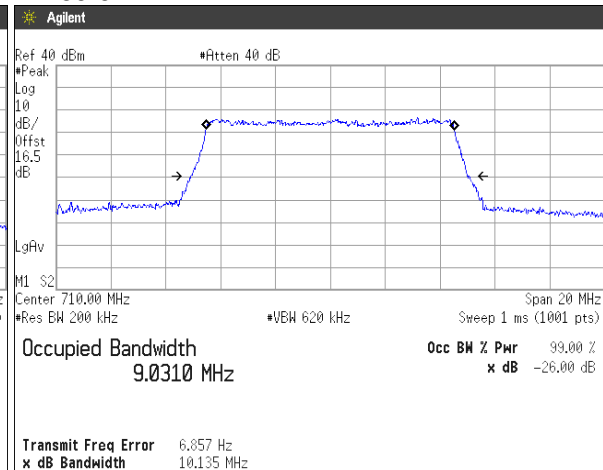

**64QAM, BW 10MHz**

**RB25-12**

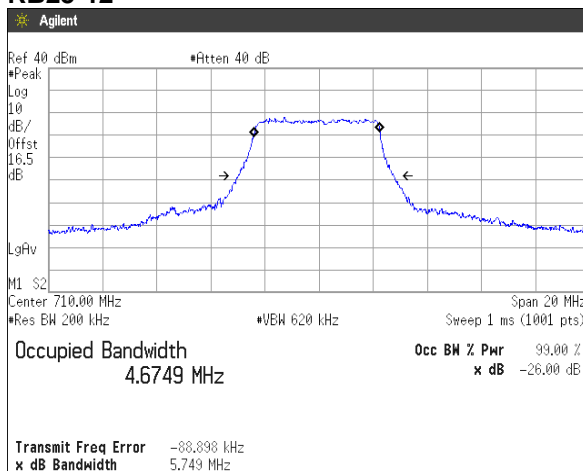

**RB50-0**

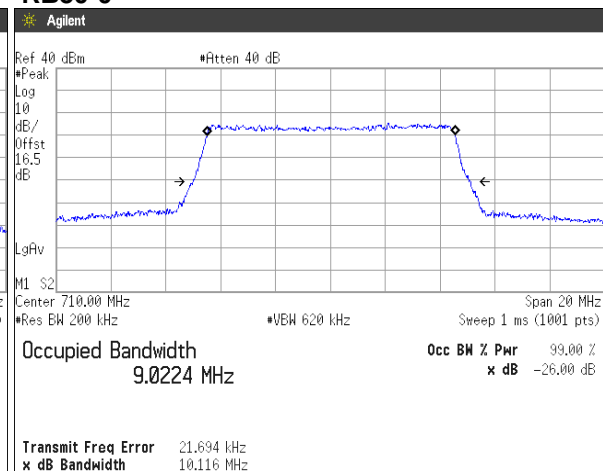

#### 4.4 Band Edge Spurious and Harmonic at Antenna Terminals

##### 4.4.1 Measurement procedure

###### [FCC 27.53, 2.1051]

The band edge spurious and harmonic was measured with a spectrum analyzer connected to the antenna terminal.

The spectrum analyzer is set to;

<Band Edge>

- Span was set large enough so as to capture all out of band emissions near the band edge
- RBW  $\geq$  1% of the emission bandwidth or 2% of the emission bandwidth
- VBW  $\geq$  3 x RBW
- Detector = RMS
- Trace mode = Max hold
- Sweep time = auto-couple
- Number of sweep point  $\geq$  2 x span / RBW

<Spurious Emissions>

- RBW = 1MHz & VBW  $\geq$  3 x RBW
- Detector = Peak
- Trace mode = Max hold
- Sweep time = auto-couple
- Number of sweep point  $\geq$  2 x span / RBW

- Test configuration

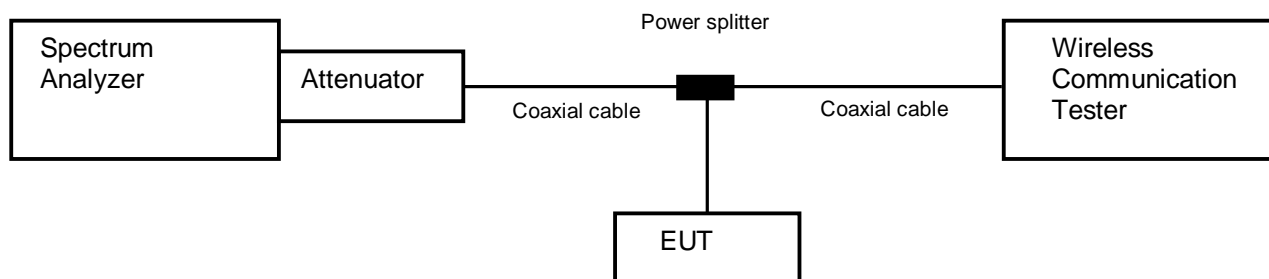

##### 4.4.2 Limit

-13 dB or less



**4.4.3 Measurement result**

Date : 17-October-2019  
 Temperature : 22.6 [°C]  
 Humidity : 45.5 [%]  
 Test place : Shielded room No.4

Test engineer : Chiaki Kanno

Date : 31-October-2019  
 Temperature : 20.8 [°C]  
 Humidity : 46.1 [%]  
 Test place : Shielded room No.4

Test engineer : Chiaki Kanno

Date : 1-November-2019  
 Temperature : 21.4 [°C]  
 Humidity : 47.4 [%]  
 Test place : Shielded room No.4

Test engineer : Chiaki Kanno

Band	Modulation	Bandwidth	Results	
LTE Band X VII	QPSK, 16QAM, 64QAM	5MHz	See the trace data	PASS
		10MHz	See the trace data	PASS



4.4.4 Trace data

[LTE Band X VII]  
 (Band Edge)  
 QPSK, BW 5MHz, RB1-0  
 Channel: Low

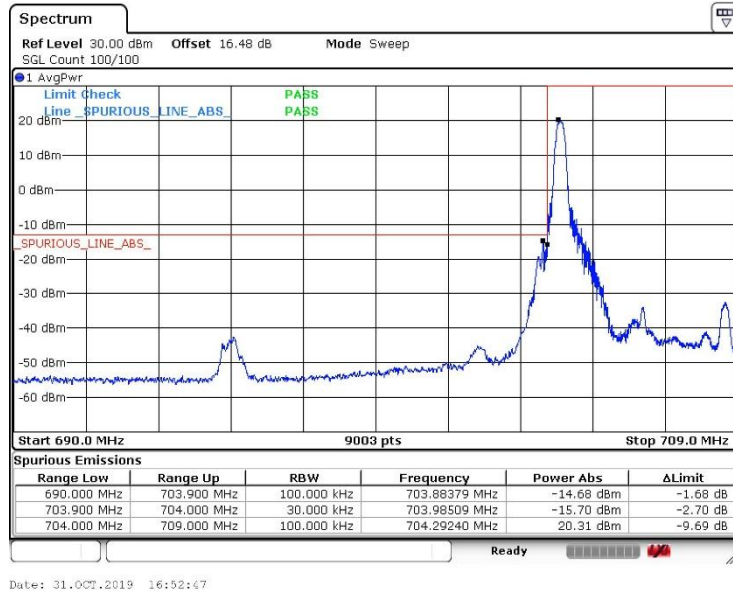

QPSK, BW 5MHz, RB1-24  
 Channel: High

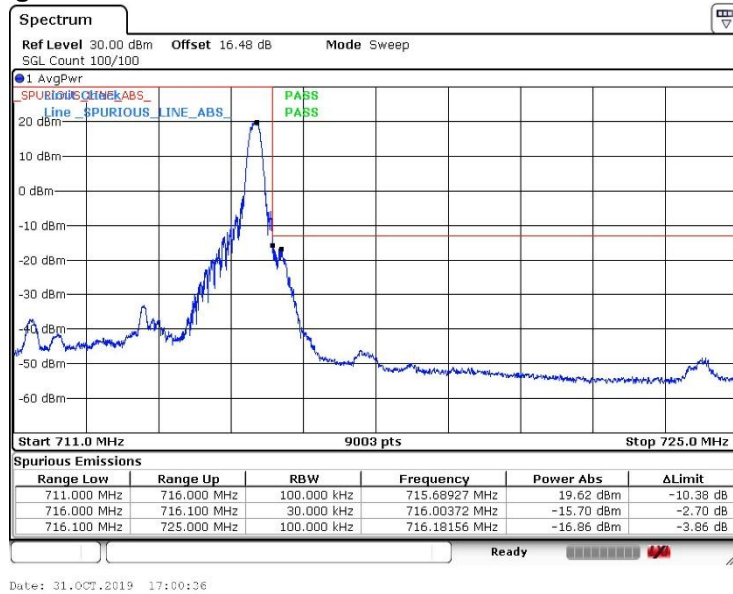



**QPSK, BW 5MHz, RB25-0**  
**Channel: Low**

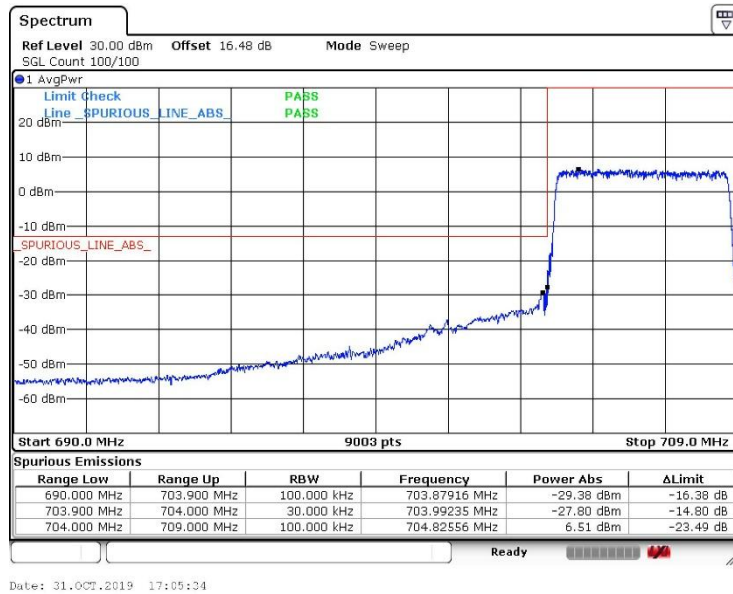

**QPSK, BW 5MHz, RB25-0**  
**Channel: High**

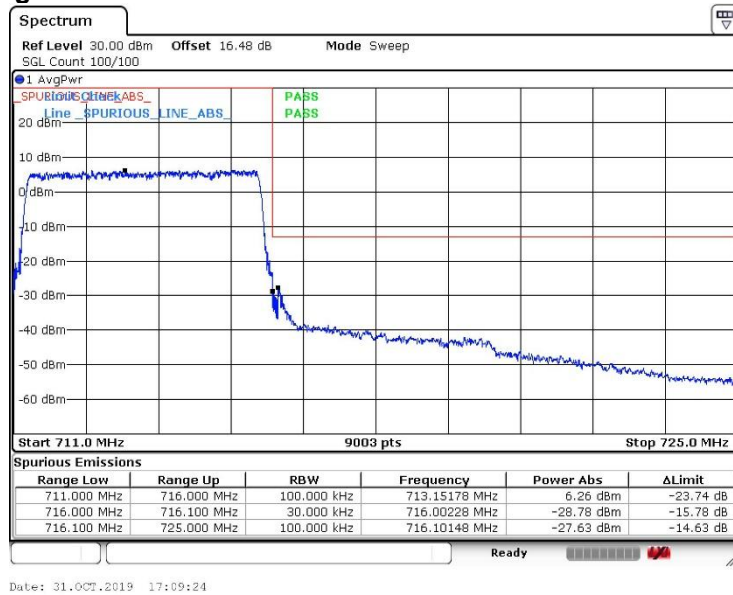



**16QAM, BW 5MHz, RB1-0**  
**Channel: Low**

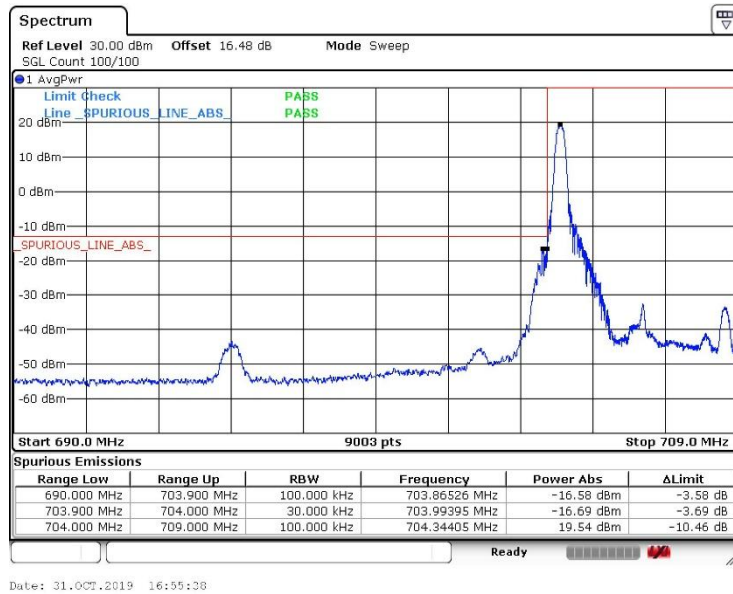

**16QAM, BW 5MHz, RB1-24**  
**Channel: High**

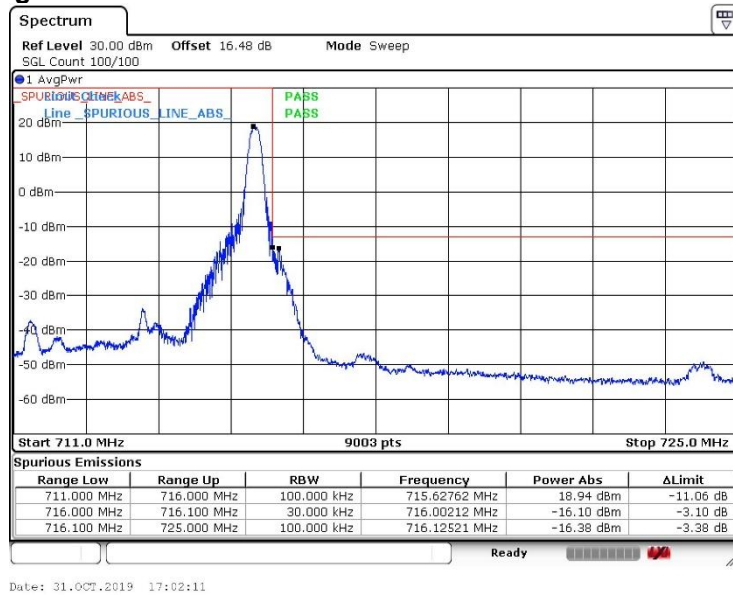



**16QAM, BW 5MHz, RB25-0**  
**Channel: Low**

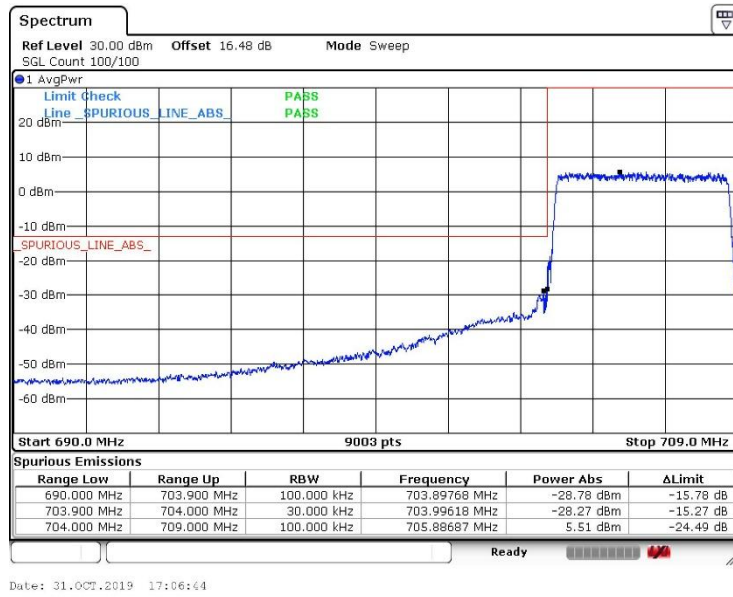

**16QAM, BW 5MHz, RB25-0**  
**Channel: High**

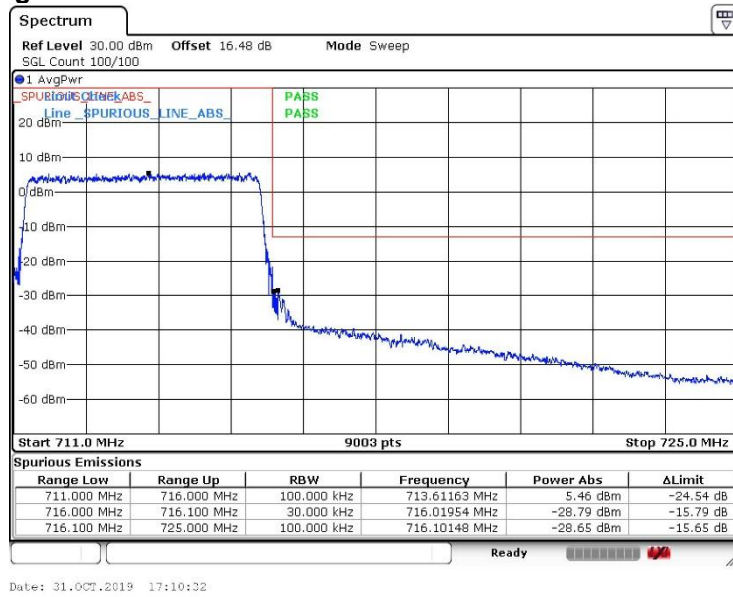



**64QAM, BW 5MHz, RB1-0**  
**Channel: Low**

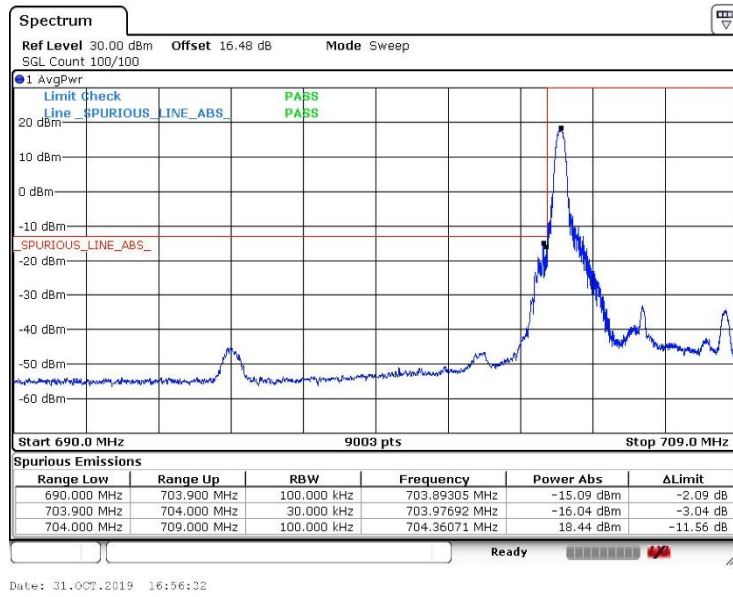

**64QAM, BW 5MHz, RB1-24**  
**Channel: High**

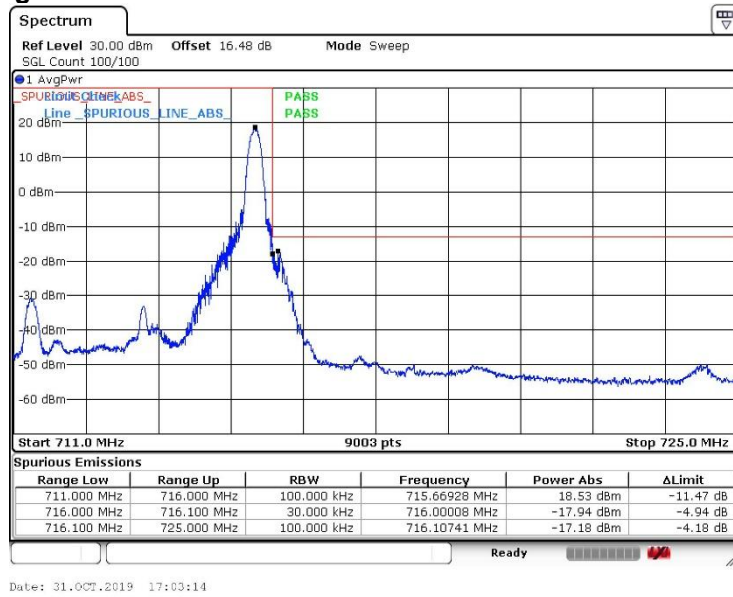





**64QAM, BW 5MHz, RB25-0**  
**Channel: Low**

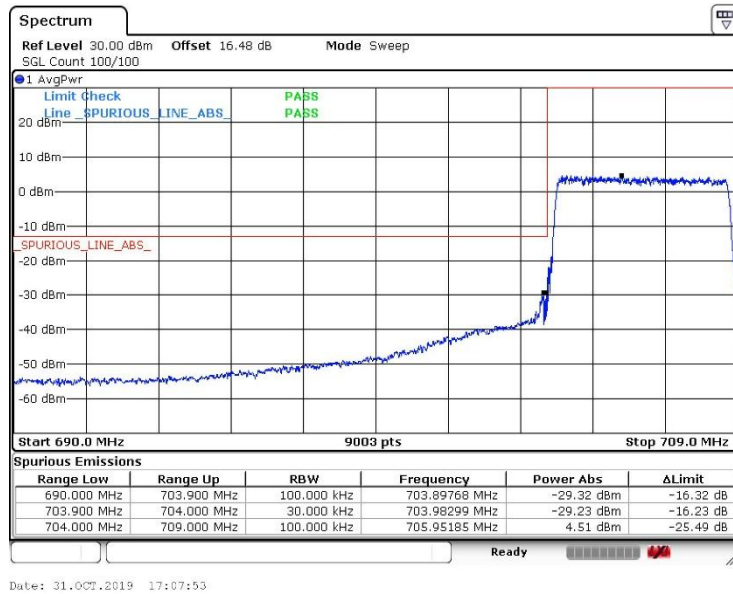

**64QAM, BW 5MHz, RB25-0**  
**Channel: High**

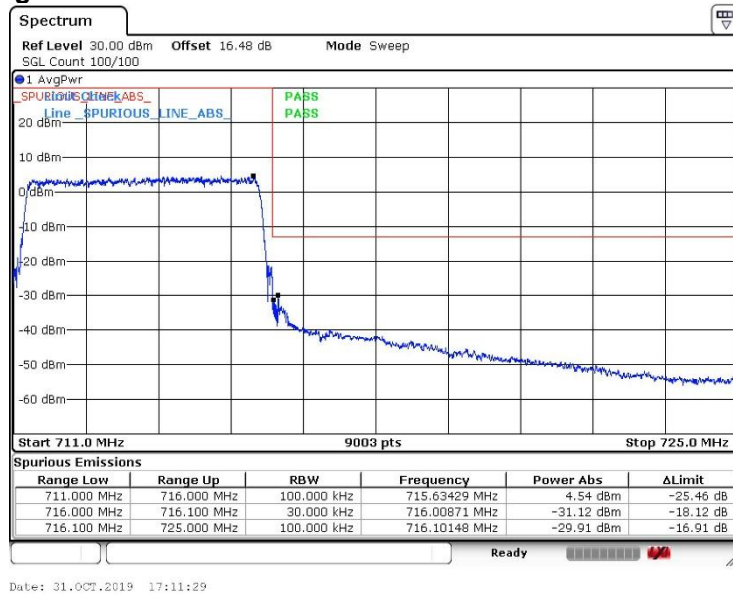



**QPSK, BW 10MHz, RB1-0**  
**Channel: Low**

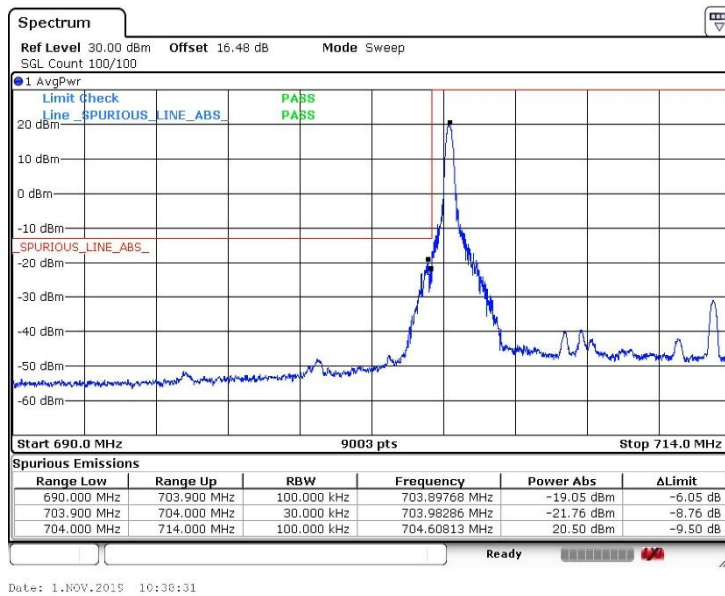

**QPSK, BW 10MHz, RB1-49**  
**Channel: High**

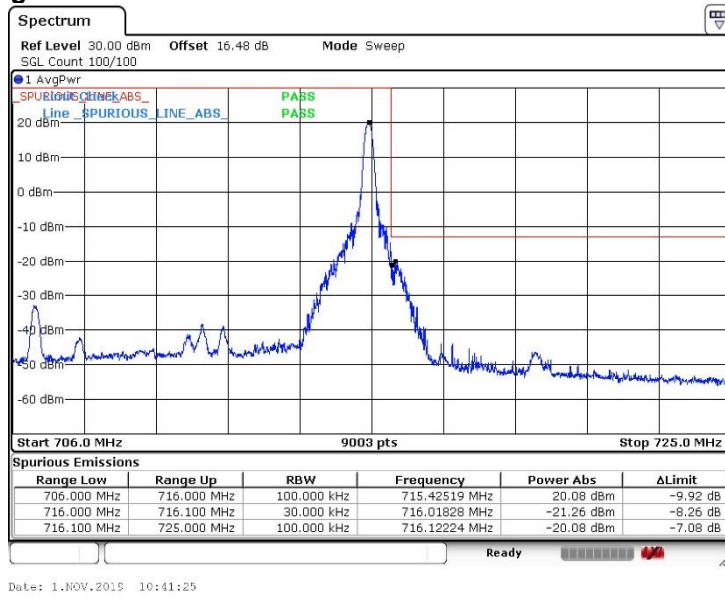



**QPSK, BW 10MHz, RB50-0**  
**Channel: Low**

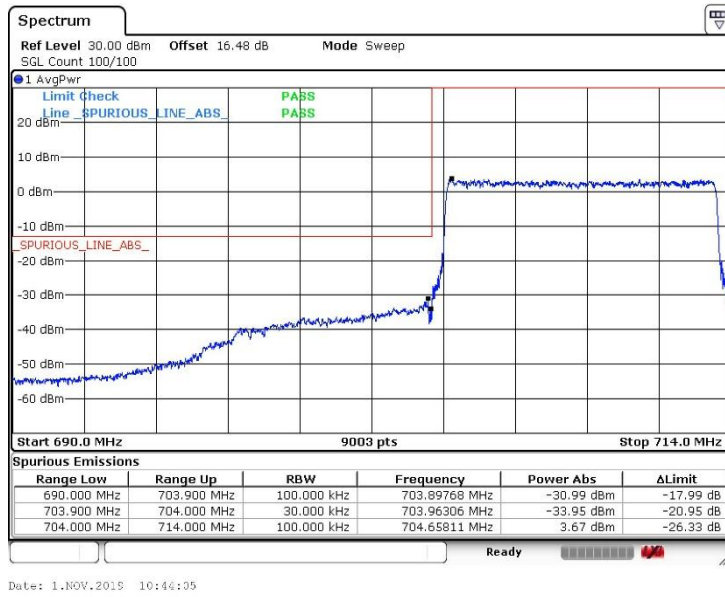

**QPSK, BW 10MHz, RB50-0**  
**Channel: High**

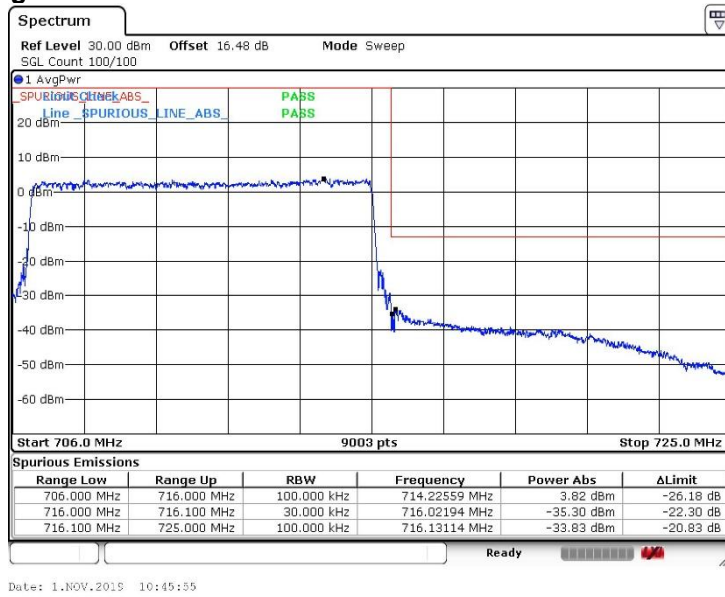



**16QAM, BW 10MHz, RB1-0**  
**Channel: Low**

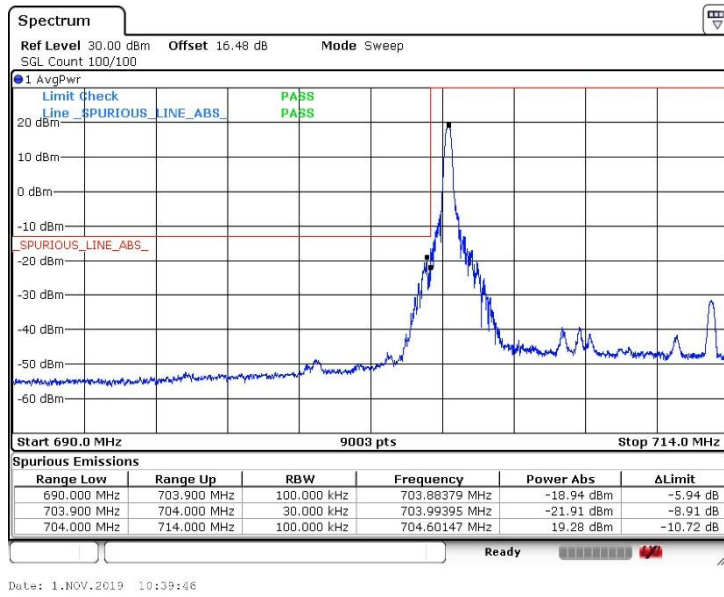

**16QAM, BW 10MHz, RB1-49**  
**Channel: High**

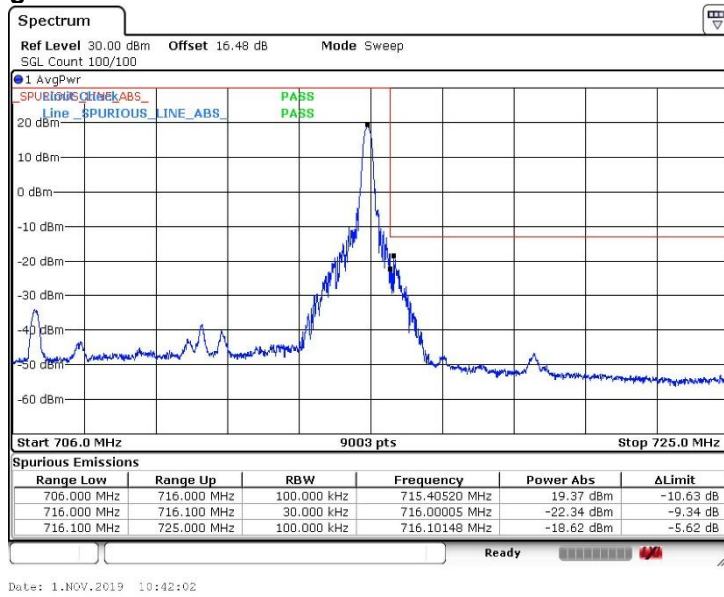



**16QAM, BW 10MHz, RB50-0**  
**Channel: Low**

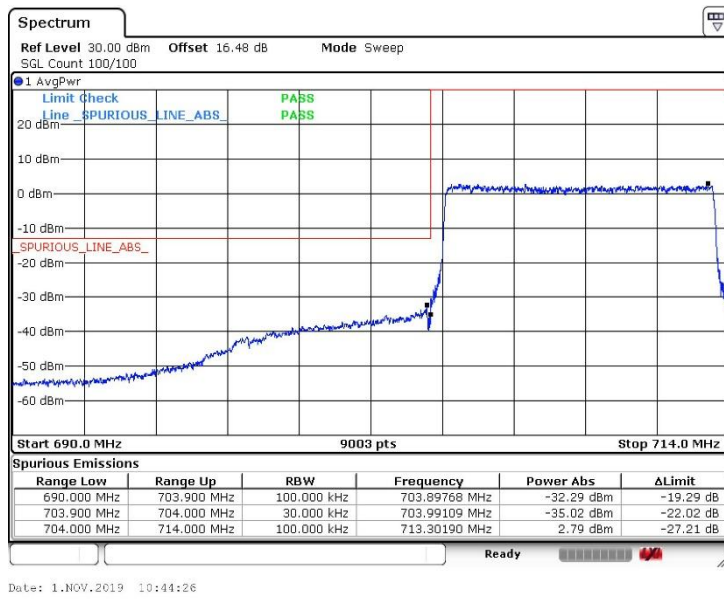

**16QAM, BW 10MHz, RB50-0**  
**Channel: High**

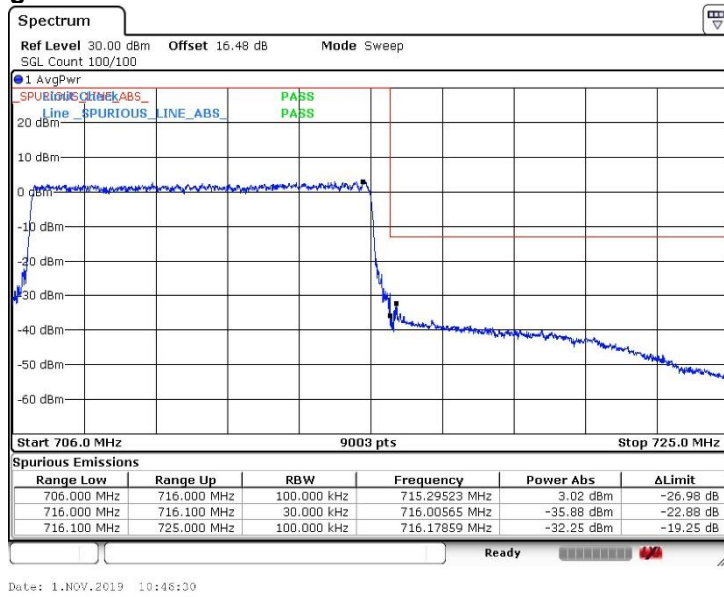

**64QAM, BW 10MHz, RB1-0**  
**Channel: Low**

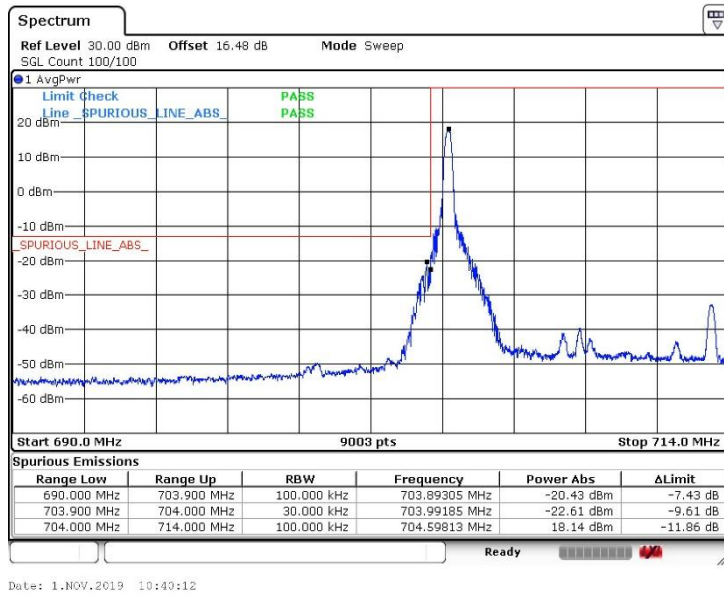

**64QAM, BW 10MHz, RB1-49**  
**Channel: High**

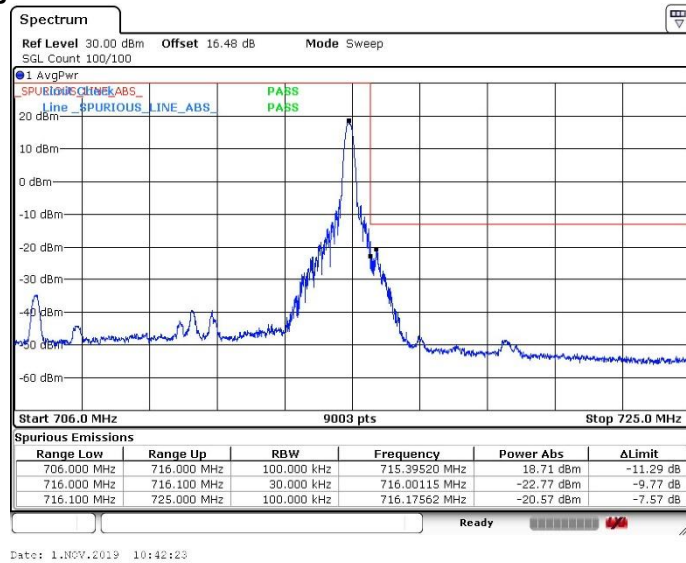



**64QAM, BW 10MHz, RB50-0**  
**Channel: Low**

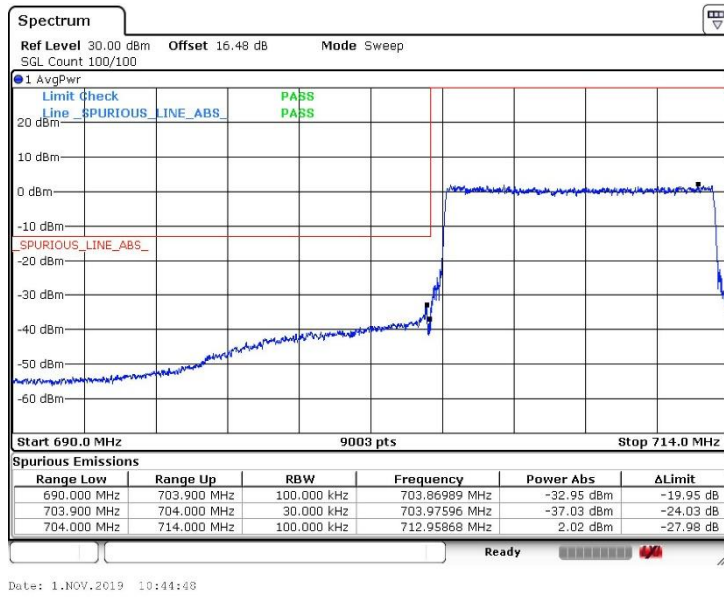

**64QAM, BW 10MHz, RB50-0**  
**Channel: High**

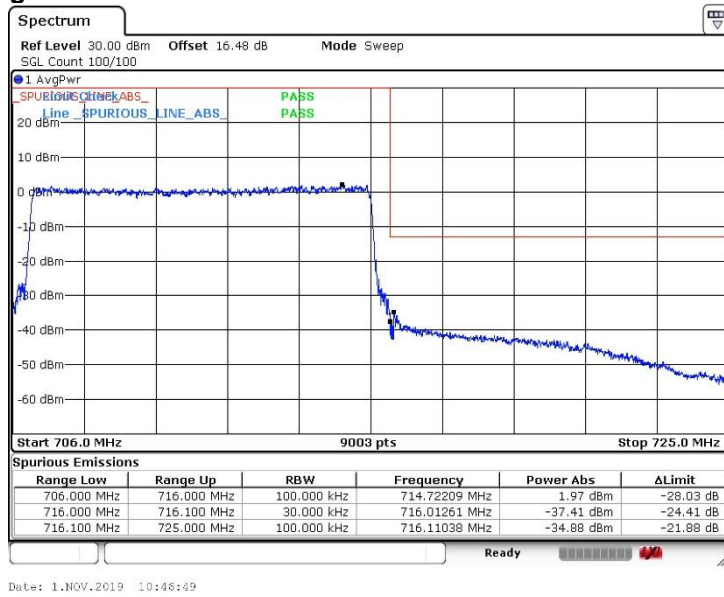



**(Spurious Emissions)**

**Note: Conducted spurious test was measured in the worst case of Effective Radiated Power.**

**QPSK, BW 10MHz, RB1-25**

**Channel: 23780**

**30MHz-5GHz**

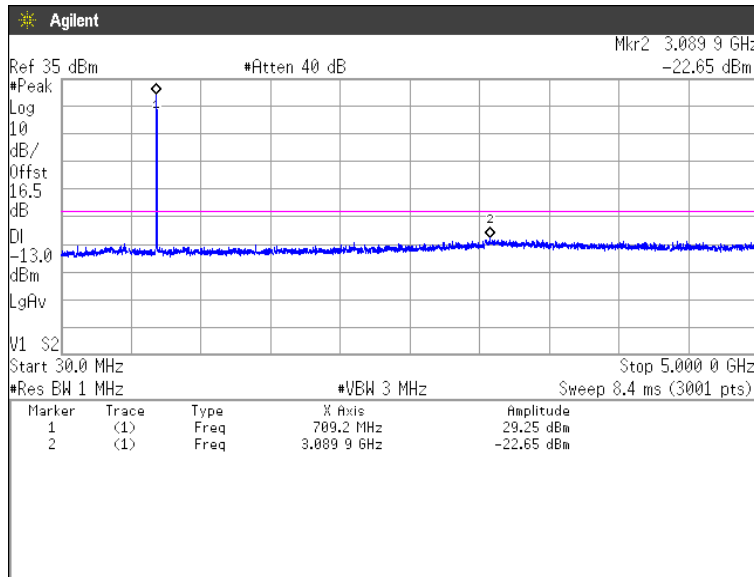

**5GHz-10GHz**

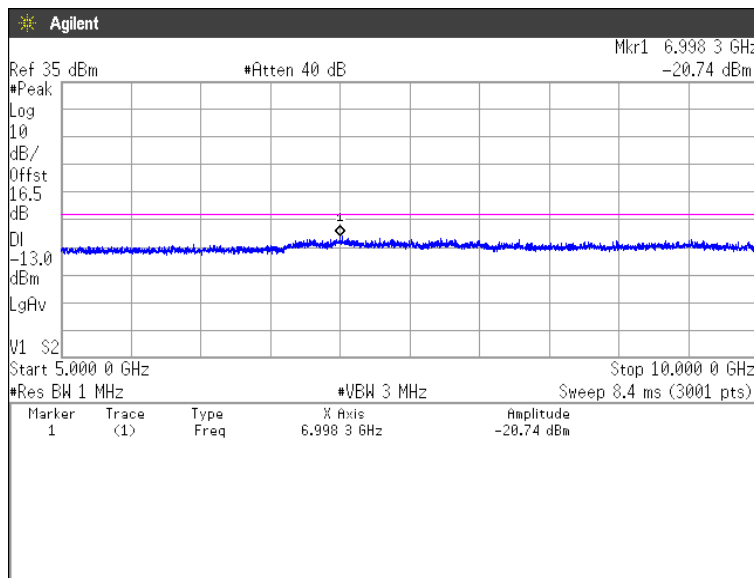





**Channel: 23790  
30MHz-5GHz**

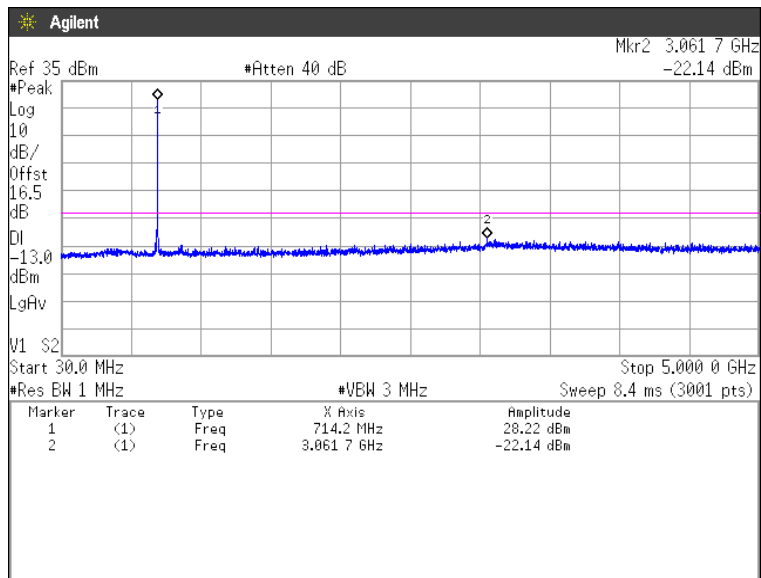

**5GHz-10GHz**

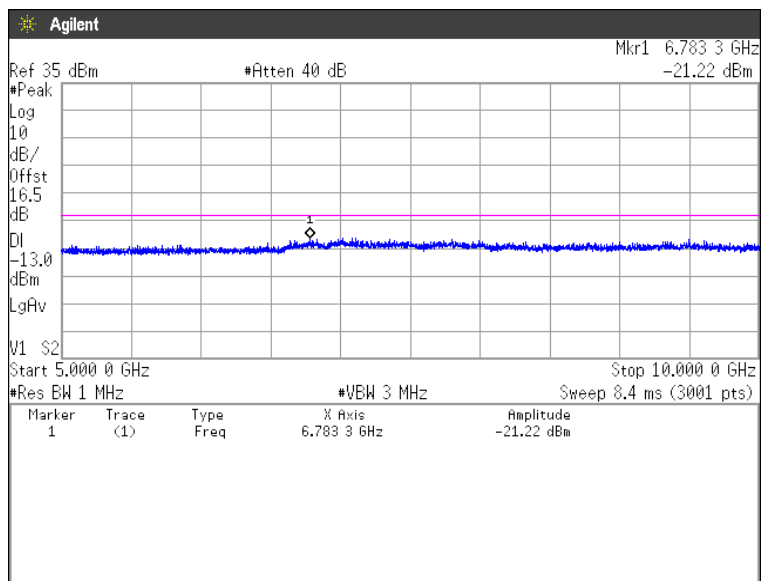



Japan

**Channel: 23800  
30MHz-5GHz**

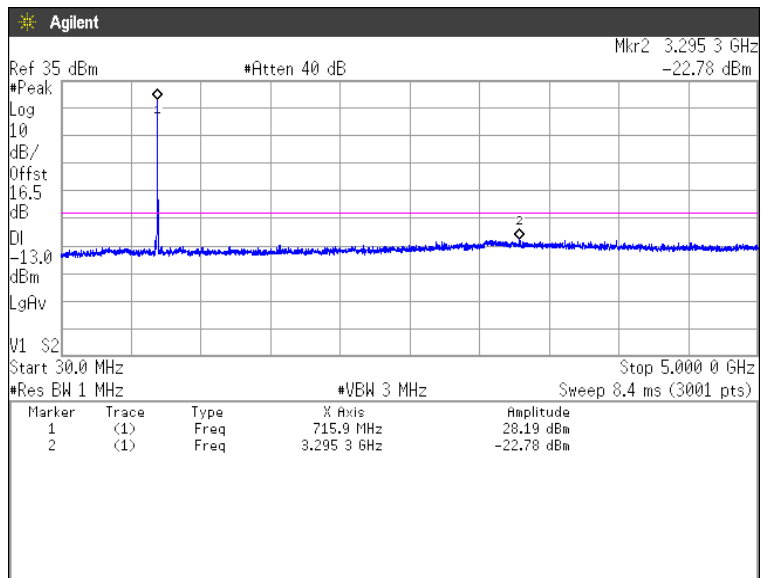

**5GHz-10GHz**

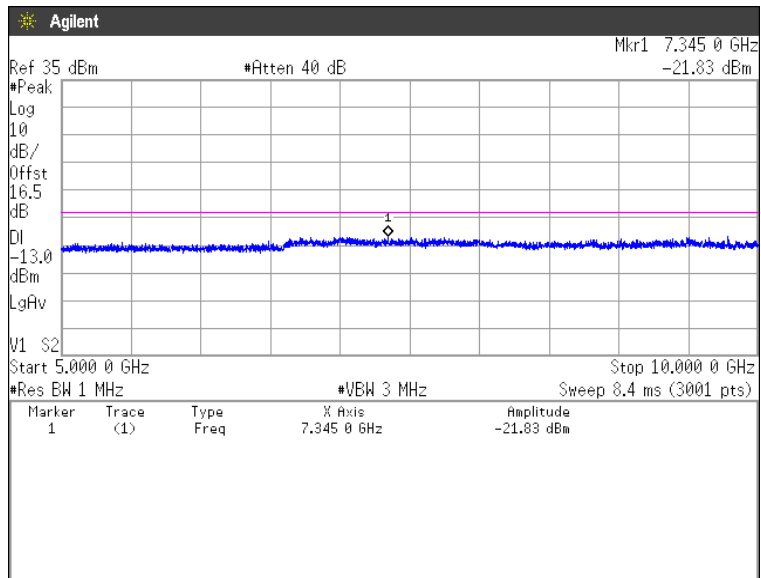

## 4.5 Radiated Emissions and Harmonic Emissions

### 4.5.1 Measurement procedure

#### [FCC 27.53, 2.1053]

##### <Step 1>

The EUT and support equipment are placed on a 1 meter x 1 meter surface, 0.8 meter height styrene foam table. Radiated emission measurements are performed at 3 meter distance with the broadband antenna (Biconical antenna, Log periodic antenna and double ridged guide antenna). The antenna is positioned both the horizontal and vertical planes of polarization and height is varied 1 to 4 meters and stopped at height producing the maximum emission.

The bandwidth of the spectrum analyzer is set to 1 MHz. The turntable is rotated by 360 degrees and stopped at azimuth of producing the maximum emission. The frequency is investigated up to 20GHz.

##### <Step 2>

The substitution antenna is replaced by the transmitter antenna (EUT).

The frequency of the signal generator is adjusted to the measurement frequency.

Level of the signal generator is adjusted to the level that is obtained from step 1, and record the emission level of signal generator.

The spectrum analyzer is set to;

- RBW = 100 kHz for below 1GHz and 1MHz for above 1GHz / VBW  $\geq 3 \times$  RBW
- Detector = Peak
- Trace mode = Max hold
- Sweep time = auto-couple

- Test configuration

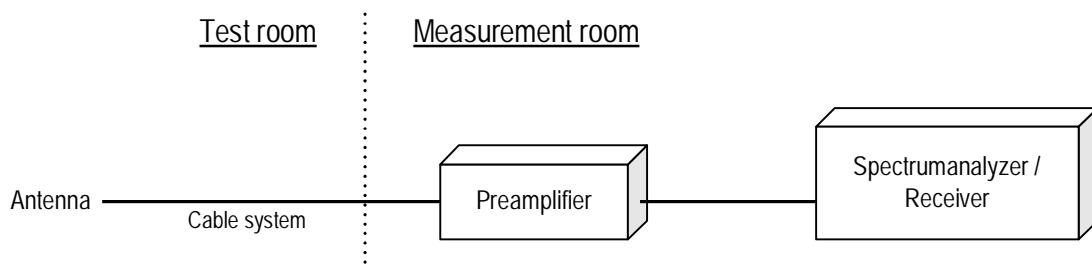



Japan

#### 4.5.2 Calculation method

Result (ERP) = S.G Reading - Cable loss + Antenna Gain  
Margin = Limit - Result (ERP)

Example:

Limit @ 1413 MHz : -13.0 dBm

S.G Reading = -55.6 dBm Cable loss = 1.0dB Ant. Gain = 5.9 dBd

Result = -55.6 - 1.0 + 5.9 = -50.7 dBm

Margin = -13.0 - (-50.7) = 37.7 dB

#### 4.5.3 Limit

-13 dBm or less

**4.5.4 Test data**

Date	: 2-November-2019	Test engineer	:	_____
Temperature	: 21.2 [°C]			
Humidity	: 33.8 [%]			
Test place	: 3m Semi-anechoic chamber			Tadahiro Seino
Date	: 5-6-November-2019	Test engineer	:	_____
Temperature	: 20.3 [°C]			
Humidity	: 50.9 [%]			
Test place	: 3m Semi-anechoic chamber			Chiaki Kanno
Date	: 7-November-2019	Test engineer	:	_____
Temperature	: 20.5 [°C]			
Humidity	: 51.1 [%]			
Test place	: 3m Semi-anechoic chamber			Chiaki Kanno

**[LTE Band X VII]  
QPSK, BW 5MHz  
Channel: 23755**

H/V	Frequency [MHz]	S.A Reading [dBm]	S.G Reading [dBm]	Cable loss [dB]	Ant.Gain [dBd]	Result [dBm]	Limit [dBm]	Margin [dB]
H	1413.0	-53.3	-55.3	1.0	10.4	-45.9	-13.0	32.9
H	2119.5	-53.0	-53.8	1.2	11.2	-43.9	-13.0	30.9

**Channel: 23790**

H/V	Frequency [MHz]	S.A Reading [dBm]	S.G Reading [dBm]	Cable loss [dB]	Ant.Gain [dBd]	Result [dBm]	Limit [dBm]	Margin [dB]
H	1420.0	-53.3	-55.3	1.0	10.4	-45.9	-13.0	32.9
H	2130.0	-53.9	-54.9	1.2	11.2	-44.9	-13.0	31.9

**Channel: 23825**

H/V	Frequency [MHz]	S.A Reading [dBm]	S.G Reading [dBm]	Cable loss [dB]	Ant.Gain [dBd]	Result [dBm]	Limit [dBm]	Margin [dB]
H	1427.0	-52.2	-54.2	1.0	10.5	-44.7	-13.0	31.7
H	2140.5	-52.8	-53.8	1.2	11.3	-43.7	-13.0	30.7

**16QAM, BW 5MHz****Channel: 23755**

H/V	Frequency [MHz]	S.A Reading [dBm]	S.G Reading [dBm]	Cable loss [dB]	Ant.Gain [dBd]	Result [dBm]	Limit [dBm]	Margin [dB]
H	1413.0	-53.7	-55.7	1.0	10.4	-46.3	-13.0	33.3
H	2119.5	-54.0	-54.8	1.2	11.2	-44.9	-13.0	31.9

**Channel: 23790**

H/V	Frequency [MHz]	S.A Reading [dBm]	S.G Reading [dBm]	Cable loss [dB]	Ant.Gain [dBd]	Result [dBm]	Limit [dBm]	Margin [dB]
H	1420.0	-53.5	-55.5	1.0	10.4	-46.1	-13.0	33.1
H	2130.0	-54.5	-55.5	1.2	11.2	-45.5	-13.0	32.5

**Channel: 23825**

H/V	Frequency [MHz]	S.A Reading [dBm]	S.G Reading [dBm]	Cable loss [dB]	Ant.Gain [dBd]	Result [dBm]	Limit [dBm]	Margin [dB]
H	1427.0	-53.1	-55.1	1.0	10.5	-45.6	-13.0	32.6
H	2140.5	-53.3	-54.3	1.2	11.3	-44.2	-13.0	31.2

**64QAM, BW 5MHz****Channel: 23755**

H/V	Frequency [MHz]	S.A Reading [dBm]	S.G Reading [dBm]	Cable loss [dB]	Ant.Gain [dBd]	Result [dBm]	Limit [dBm]	Margin [dB]
H	1413.0	-53.8	-55.8	1.0	10.4	-46.4	-13.0	33.4
H	2119.5	-54.0	-54.8	1.2	11.2	-44.9	-13.0	31.9

**Channel: 23790**

H/V	Frequency [MHz]	S.A Reading [dBm]	S.G Reading [dBm]	Cable loss [dB]	Ant.Gain [dBd]	Result [dBm]	Limit [dBm]	Margin [dB]
H	1420.0	-53.6	-55.6	1.0	10.4	-46.2	-13.0	33.2
H	2130.0	-54.7	-55.7	1.2	11.2	-45.7	-13.0	32.7

**Channel: 23825**

H/V	Frequency [MHz]	S.A Reading [dBm]	S.G Reading [dBm]	Cable loss [dB]	Ant.Gain [dBd]	Result [dBm]	Limit [dBm]	Margin [dB]
H	1427.0	-53.9	-55.9	1.0	10.5	-46.4	-13.0	33.4
H	2140.5	-53.6	-54.6	1.2	11.3	-44.5	-13.0	31.5

**QPSK, BW 10MHz****Channel: 23780**

H/V	Frequency [MHz]	S.A Reading [dBm]	S.G Reading [dBm]	Cable loss [dB]	Ant.Gain [dBd]	Result [dBm]	Limit [dBm]	Margin [dB]
H	1418.0	-52.9	-54.7	1.0	10.4	-45.3	-13.0	32.3
H	2127.0	-53.2	-54.1	1.2	11.2	-44.1	-13.0	31.1

**Channel: 23790**

H/V	Frequency [MHz]	S.A Reading [dBm]	S.G Reading [dBm]	Cable loss [dB]	Ant.Gain [dBd]	Result [dBm]	Limit [dBm]	Margin [dB]
H	1420.0	-52.7	-54.5	1.0	10.4	-45.1	-13.0	32.1
H	2130.0	-53.6	-54.6	1.2	11.2	-44.6	-13.0	31.6

**Channel: 23800**

H/V	Frequency [MHz]	S.A Reading [dBm]	S.G Reading [dBm]	Cable loss [dB]	Ant.Gain [dBd]	Result [dBm]	Limit [dBm]	Margin [dB]
H	1422.0	-52.6	-54.6	1.0	10.4	-45.2	-13.0	32.2
H	2133.0	-53.4	-54.2	1.2	11.3	-44.2	-13.0	31.2

**16QAM, BW 10MHz****Channel: 23780**

H/V	Frequency [MHz]	S.A Reading [dBm]	S.G Reading [dBm]	Cable loss [dB]	Ant.Gain [dBd]	Result [dBm]	Limit [dBm]	Margin [dB]
H	1418.0	-53.1	-54.9	1.0	10.4	-45.5	-13.0	32.5
H	2127.0	-53.6	-54.5	1.2	11.2	-44.5	-13.0	31.5

**Channel: 23790**

H/V	Frequency [MHz]	S.A Reading [dBm]	S.G Reading [dBm]	Cable loss [dB]	Ant.Gain [dBd]	Result [dBm]	Limit [dBm]	Margin [dB]
H	1420.0	-53.5	-55.3	1.0	10.4	-45.9	-13.0	32.9
H	2130.0	-54.2	-55.2	1.2	11.2	-45.2	-13.0	32.2

**Channel: 23800**

H/V	Frequency [MHz]	S.A Reading [dBm]	S.G Reading [dBm]	Cable loss [dB]	Ant.Gain [dBd]	Result [dBm]	Limit [dBm]	Margin [dB]
H	1422.0	-53.0	-55.0	1.0	10.4	-45.6	-13.0	32.6
H	2133.0	-53.8	-54.6	1.2	11.3	-44.6	-13.0	31.6

**64QAM, BW 10MHz****Channel: 23780**

H/V	Frequency [MHz]	S.A Reading [dBm]	S.G Reading [dBm]	Cable loss [dB]	Ant.Gain [dBd]	Result [dBm]	Limit [dBm]	Margin [dB]
H	1418.0	-53.2	-55.0	1.0	10.4	-45.6	-13.0	32.6
H	2127.0	-53.7	-54.6	1.2	11.2	-44.6	-13.0	31.6

**Channel: 23790**

H/V	Frequency [MHz]	S.A Reading [dBm]	S.G Reading [dBm]	Cable loss [dB]	Ant.Gain [dBd]	Result [dBm]	Limit [dBm]	Margin [dB]
H	1420.0	-53.5	-55.3	1.0	10.4	-45.9	-13.0	32.9
H	2130.0	-54.3	-55.3	1.2	11.2	-45.3	-13.0	32.3

**Channel: 23800**

H/V	Frequency [MHz]	S.A Reading [dBm]	S.G Reading [dBm]	Cable loss [dB]	Ant.Gain [dBd]	Result [dBm]	Limit [dBm]	Margin [dB]
H	1422.0	-53.2	-55.2	1.0	10.4	-46.7	-13.0	32.8
H	2133.0	-54.1	-54.9	1.2	11.3	-44.9	-13.0	31.9



## 4.6 Frequency Stability

### 4.6.1 Measurement procedure

[FCC 27.54, 2.1055]

The EUT was placed of an inside of an constant temperature chamber as the temperature in the chamber was varied between -30°C and +50°C. The temperature was incremented by 10°C intervals and the unit was allowed to stabilize at each measurement. The frequency drift was measured with the normal Temperature and voltage tolerance and it is presented as the ppm unit.

- Test configuration

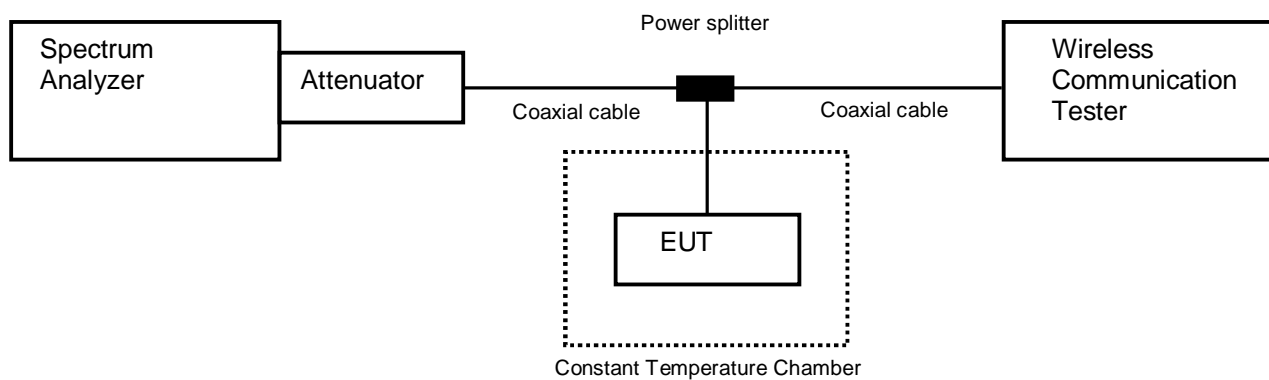

### 4.6.2 Limit

±2.5 ppm

#### 4.6.3 Measurement result

Date : 31-October-2019  
 Temperature : 20.8 [°C]  
 Humidity : 46.1 [%]  
 Test place : Shielded room No.4

Test engineer : Chiaki Kanno

#### [LTE Band X VII] (Channel: 23790)

Limit: $\pm 0.00025\% = \pm 2.5$ ppm					
Power Supply [V]	Temperature [°C]	Measurements Frequency [Hz]	Frequency Tolerance [ppm]	Limit [ppm]	Result
3.85	25(Ref.)	709,999,997	0.00000	$\pm 2.5$	Pass
	50	709,999,996	-0.00159	$\pm 2.5$	Pass
	40	709,999,997	-0.00113	$\pm 2.5$	Pass
	30	709,999,997	-0.00059	$\pm 2.5$	Pass
	20	710,000,003	0.00723	$\pm 2.5$	Pass
	10	710,000,003	0.00825	$\pm 2.5$	Pass
	0	710,000,004	0.00906	$\pm 2.5$	Pass
	-10	710,000,003	0.00772	$\pm 2.5$	Pass
	-20	710,000,003	0.00721	$\pm 2.5$	Pass
	-30	709,999,997	-0.00083	$\pm 2.5$	Pass
3.47	25	709,999,996	-0.00177	$\pm 2.5$	Pass
4.24	25	709,999,997	-0.00046	$\pm 2.5$	Pass



Calculation;

Frequency Tolerance (ppm) = Measurements Frequency (Hz) – Reference Frequency (Hz) / Reference Frequency (Hz) x 1000000

## 5 Measurement Uncertainty

Expanded uncertainties stated are calculated with a coverage Factor  $k=2$ . Please note that these results are not taken into account when measurement uncertainty considerations contained in ETSI TR 100 028 Parts 1 and 2 determining compliance or non-compliance with test result.

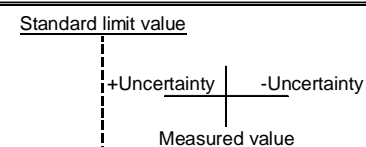
Test item	Measurement uncertainty
Conducted emission, AMN (9 kHz – 150 kHz)	$\pm 3.8$ dB
Conducted emission, AMN (150 kHz – 30 MHz)	$\pm 3.3$ dB
Radiated emission ( 9kHz – 30 MHz)	$\pm 3.1$ dB
Radiated emission (30 MHz – 1000 MHz)	$\pm 4.9$ dB
Radiated emission (1 GHz – 6 GHz)	$\pm 4.8$ dB
Radiated emission (6 GHz – 18 GHz)	$\pm 5.1$ dB
Radiated emission (18 GHz – 40 GHz)	$\pm 5.8$ dB
Radio Frequency	$\pm 1.4 * 10^{-8}$
RF power, conducted	$\pm 0.6$ dB
Temperature	$\pm 0.6$ °C
Humidity	$\pm 1.2$ %
Voltage (DC)	$\pm 0.4$ %
Voltage (AC, <10kHz)	$\pm 0.2$ %

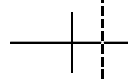
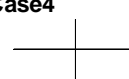
Judge	Measured value and standard limit value
PASS	<p><b>Case1</b></p>  <p>Even if it takes uncertainty into consideration, a standard limit value is fulfilled.</p>
	<p><b>Case2</b></p>  <p>Although measured value is in a standard limit value, a limit value won't be fulfilled if uncertainty is taken into consideration.</p>
FAIL	<p><b>Case3</b></p>  <p>Although measured value exceeds a standard limit value, a limit value will be fulfilled if uncertainty is taken into consideration.</p>
	<p><b>Case4</b></p>  <p>Even if it takes uncertainty into consideration, a standard limit value isn't fulfilled.</p>



## 6 Laboratory Information

Testing was performed and the report was issued at:

### TÜV SÜD Japan Ltd. Yonezawa Testing Center

Address: 5-4149-7 Hachimanpara, Yonezawa-shi, Yamagata, 992-1128 Japan  
 Phone: +81-238-28-2881  
 Fax: +81-238-28-2888

### Accreditation and Registration

NVLAP  
 LAB CODE: 200306-0

VLAC  
 Accreditation No.: VLAC-013

BSMI  
 Laboratory Code: SL2-IN-E-6018, SL2-A1-E-6018

Innovation, Science and Economic Development Canada

Site number	Facility	Expiration date
4224A-4	3 m Semi-anechoic chamber	27-November-2020
4224A-5	10 m Semi-anechoic chamber No. 1	27-November-2020
4224A-6	10 m Semi-anechoic chamber No. 2	14-December-2019

VCCI Council

Registration number	Expiration date
A-0166	03-July-2021

## Appendix A. Test Equipment

### Antenna port conducted test

Equipment	Company	Model No.	Serial No.	Cal. Due	Cal. Date
Spectrum analyzer	Agilent Technologies	E4440A	US44302655	31-Aug-2020	05-Aug-2019
Spectrum analyzer	ROHDE&SCHWARZ	FSV40	101731	31-Dec-2019	07-Dec-2018
Attenuator	Weinschel	56-10	J4180	31-Jul-2020	18-Jul-2019
Microwave cable	HUBER+SUHNER	SUCOFLEX 104/1m	199120/4	31-Dec-2019	18-Dec-2018
Microwave cable	HUBER+SUHNER	SUCOFELX102/2m	MY3385/2	31-Mar-2020	08-Mar-2019
Power divider	ANRITSU	K240B	020205	31-Jul-2020	19-Jul-2019
Wideband Radio Frequency Tester	ROHDE&SCHWARZ	CMW500	126079	31-Oct-2019	12-Oct-2018
Wideband Radio Frequency Tester	ROHDE&SCHWARZ	CMW500	116338	31-Aug-2020	27-Aug-2019
Temperature and humidity chamber	ESPEC	PL1KP	14007261	30-Sep-2020	03-Sep-2019

### Radiated emission

Equipment	Company	Model No.	Serial No.	Cal. Due	Cal. Date
EMI Receiver	ROHDE&SCHWARZ	ESCI	100765	30-Sep-2020	25-Sep-2019
Spectrum analyzer	Agilent Technologies	E4447A	MY46180188	30-Apr-2020	16-Apr-2019
Spectrum analyzer	Agilent Technologies	E4440A	US40420937	30-Sep-2020	26-Sep-2019
Preamplifier	SONOMA	310	372170	30-Sep-2020	26-Sep-2019
Biconical antenna	Schwarzbeck	VHA9103/BBA9106	VHA91032155	30-Sep-2020	25-Sep-2019
Log periodic antenna	Schwarzbeck	UHALP9111B	345	31-Aug-2020	27-Aug-2019
Attenuator	TAMAGAWA.ELEC	CFA-01/6dB	N/A(S465)	31-May-2020	17-May-2019
Attenuator	TAMAGAWA.ELEC	CFA-10/3dB	N/A(S503)	31-Jul-2020	17-Jul-2019
Preamplifier	TSJ	MLA-100M18-B02-40	1929118	31-Jan-2020	17-Jan-2019
Attenuator	AEROFLEX	26A-10	081217-08	31-Jan-2020	17-Jan-2019
Double ridged guide antenna	ETS LINDGREN	3117	00224193	31-Jan-2020	23-Jan-2019
Attenuator	Agilent Technologies	8491B	MY39268633	31-Mar-2020	08-Mar-2019
Double ridged guide antenna	A.H.Systems Inc.	SAS-574	469	31-Aug-2020	28-Aug-2019
Preamplifier	TSJ	MLA-1840-B03-35	1240332	31-Aug-2020	28-Aug-2019
Notch Filter	Micro-Tronics	HPM50115	004	31-Jul-2020	18-Jul-2019
Signal generator	ROHDE&SCHWARZ	SMB100A	177525	31-Jul-2020	18-Jul-2019
RF power amplifier	R&K	CGA020M602-2633R	B40240	31-May-2020	16-May-2019
Microwave cable	HUBER+SUHNER	SUCOFELX102/2m	31648	31-Mar-2020	08-Mar-2019
Dipole antenna	Schwarzbeck	VHAP	1021	31-Aug-2020	15-Aug-2019
Dipole antenna	Schwarzbeck	UHAP	993	31-Aug-2020	15-Aug-2019
Double ridged guide antenna	EMCO	3115	00058532	29-Feb-2020	12-Feb-2019
Double ridged guide antenna	ETS LINDGREN	3117	00218815	31-Dec-2019	27-Dec-2018
Wideband Radio Frequency Tester	ROHDE&SCHWARZ	CMW500	126079	31-Oct-2019	12-Oct-2018
Wideband Radio Frequency Tester	ROHDE&SCHWARZ	CMW500	116338	31-Aug-2020	27-Aug-2019
Microwave cable	HUBER+SUHNER	SUCOFLEX104/9m	MY30037/4	31-Jan-2020	16-Jan-2019
		SUCOFLEX104/1m	my24610/4	31-Jan-2020	16-Jan-2019
		SUCOFLEX104/8m	SN MY30031/4	31-Jan-2020	16-Jan-2019
		SUCOFLEX104	MY32976/4	31-Jan-2020	16-Jan-2019
		SUCOFLEX104/1.5m	MY19309/4	31-Jan-2020	16-Jan-2019
		SUCOFLEX104/7m	41625/6	31-Jan-2020	16-Jan-2019
PC	DELL	DIMENSION E521	75465BX	N/A	N/A
Software	TOYO Corporation	EP5/RE-AJ	0611193/V5.6.0	N/A	N/A
Absorber	RIKEN	PFP30	N/A	N/A	N/A
3m Semi an-echoic Chamber	TOKIN	N/A	N/A(9002-NSA)	31-May-2020	14-May-2019
3m Semi an-echoic Chamber	TOKIN	N/A	N/A(9002-SVSWR)	31-May-2020	13-May-2019

\*: The calibrations of the above equipment are traceable to NIST or equivalent standards of the reference organizations.