

Report on the RF Testing of:

KYOCERA Corporation
Mobile Phone, Model: CB70
FCC ID: JOYCB70

In accordance with FCC Part 24 Subpart E

Prepared for: KYOCERA Corporation
Yokohama Office 2-1-1 Kagahara, Tsuzuki-ku
Yokohama-shi, Kanagawa, Japan
Phone: +81-45-943-6253 Fax: +81-45-943-6314



COMMERCIAL-IN-CONFIDENCE

Document Number: JPD-TR-19183-0

SIGNATURE			
NAME	JOB TITLE	RESPONSIBLE FOR	ISSUE DATE
Hiroaki Suzuki	Deputy Manager of RF Group	Approved Signatory	25 NOV 2019

Signatures in this approval box have checked this document in line with the requirements of TÜV SÜD Japan Ltd. document control rules.

EXECUTIVE SUMMARY
A sample(s) of this product was tested and found to be compliant with FCC Part 24 Subpart E.

 NVLAP TESTING NVLAP LAB CODE 200306-0		DISCLAIMER AND COPYRIGHT The results in this report are applicable only to the equipment tested. This report shall not be re-produced except in full without the written approval of TÜV SÜD Japan Ltd.
		ACCREDITATION This test report must not be used by the client to claim product certification, approval, or endorsement by NVLAP, NIST, or any agency of the federal government.

TÜV SÜD Japan Ltd.
Yonezawa Testing Center
5-4149-7 Hachimanpara,
Yonezawa-shi, Yamagata,
992-1128 Japan

Phone: +81 (0) 238 28 2881
Fax: +81 (0) 238 28 2888
www.tuv-sud.jp

Contents

1	Summary of Test	3
1.1	Modification history of the test report.....	3
1.2	Standards.....	3
1.3	Test methods.....	3
1.4	Deviation from standards.....	3
1.5	List of applied test(s) of the EUT.....	3
1.6	Test information.....	3
1.7	Test set up.....	3
1.8	Test period.....	3
2	Equipment Under Test	4
2.1	EUT information.....	4
2.2	Modification to the EUT.....	5
2.3	Variation of family model(s).....	5
2.4	Description of test mode.....	5
3	Configuration of Equipment	6
3.1	Equipment used.....	6
3.2	System configuration.....	6
4	Test Result	7
4.1	Equivalent Isotropic Radiated Power.....	7
4.2	Peak to Average Ratio.....	10
4.3	Occupied Bandwidth.....	13
4.4	Band Edge Spurious and Harmonic at Antenna Terminals.....	15
4.5	Radiated Emissions and Harmonic Emissions.....	20
4.6	Frequency Stability.....	22
5	Measurement Uncertainty	24
6	Laboratory Information	25
	Appendix A. Test Equipment	26

1 Summary of Test

1.1 Modification history of the test report

Document Number	Modification History	Issue Date
JPD-TR-19183-0	First Issue	Refer to the cover page

1.2 Standards

CFR47 FCC Part 24 Subpart E

1.3 Test methods

KDB 971168 D01 Power Meas License Digital Systems v03r01
ANSI/TIA/EIA-603-D-2010

1.4 Deviation from standards

None

1.5 List of applied test(s) of the EUT

Test item section	Test item	Condition	Result	Remark
2.1046	Conducted Output Power	Conducted	PASS	*1
24.232(c)	Effective Radiated Power Equivalent Isotropic Radiated Power	Radiated	PASS	-
24.232(d)	Peak to Average Ratio	Conducted	PASS	-
24.238(a) 2.1049	Occupied Bandwidth	Conducted	PASS	-
24.238(a) 2.1051	Band Edge Spurious and Harmonic at Antenna Terminal	Conducted	PASS	-
24.238(a) 2.1053	Radiated emissions and Harmonic Emissions	Radiated	PASS	-
24.235 2.1055	Frequency Stability	Conducted	PASS	-

*1: Refer to RF Exposure Report (Test Report_SAR)

1.6 Test information

None

1.7 Test set up

Table-top

1.8 Test period

9-October-2019 - 5-November-2019



2 Equipment Under Test

2.1 EUT information

Applicant	KYOCERA Corporation Yokohama Office 2-1-1 Kagahara, Tsuzuki-ku Yokohama-shi, Kanagawa, Japan Phone: +81-45-943-6253 Fax: +81-45-943-6314
Equipment Under Test (EUT)	Mobile Phone
Model number	CB70
Serial number	N/A
Trade name	Kyocera
Number of sample(s)	1
EUT condition	Pre-Production
Power rating	Battery: DC 3.85 V
Size	(W) 71.0 × (D) 159.0 × (H) 8.9 mm
Environment	Indoor and Outdoor use
Terminal limitation	-20°C to 60°C
Hardware version	DMT2
Software version	0.410HA
Firmware version	Not applicable
RF Specification	
Frequency of Operation	Up Link GSM1900: 1850.2-1909.8 MHz Down Link GSM1900: 1930.2-1989.8 MHz
Modulation type	GSM1900: GMSK
Emission designator	GSM1900: 240KGXW
Equivalent Isotropic Radiated Power (E.I.R.P)	GSM1900: 1.6596 W (32.2 dBm)
Antenna type	Internal antenna
Antenna gain	GSM1900: 2.0 dBi

2.2 Modification to the EUT

The table below details modifications made to the EUT during the test project.

Modification State	Description of Modification	Modification fitted by	Date of Modification
Model: CB70, Serial Number: N/A			
0	As supplied by the applicant	Not Applicable	Not Applicable

2.3 Variation of family model(s)

2.3.1 List of family model(s)

Not applicable

2.3.2 Reason for selection of EUT

Not applicable

2.4 Description of test mode

The EUT had been tested under operating condition.
There are three channels have been tested as following:

Band	Channel	Frequency [MHz]
GSM1900	512	1850.2
	661	1880.0
	810	1909.8

The field strength of spurious emissions was measured at each position of all three axis X, Y and Z to compare the level, and the maximum noise.

The worst emission was found in X-axis and the worst case recorded.

Pre-scan has been conducted to determine the worst-case mode from all possible combinations between available modulations, data rates and antenna ports.



3 Configuration of Equipment

Numbers assigned to equipment on the diagram in “3.2 System configuration” correspond to the list in “3.1 Equipment used”.

Cabling and setup(s) were taken into consideration and test data was taken under worse case condition.

3.1 Equipment used

No.	Equipment	Company	Model No.	Serial No.	FCC ID/DoC	Comment
1	Mobile Phone	KYOCERA	CB70	N/A	JOYCB70	EUT

3.2 System configuration

1. Mobile Phone
(EUT)

4 Test Result

4.1 Equivalent Isotropic Radiated Power

4.1.1 Measurement procedure

[FCC 24.232(c)]

<Step 1>

The EUT and support equipment are placed on a 1 meter x 1 meter surface, 0.8 meter height styrene foam table. Radiated emission measurements are performed at 3 meter distance with the broadband antenna (double ridged guide antenna). The antenna is positioned both the horizontal and vertical planes of polarization and height is varied 1 to 4 meters and stopped at height producing the maximum emission.

The bandwidth of the spectrum analyzer is set to 1 MHz. The turntable is rotated by 360 degrees and stopped at azimuth of producing the maximum emission.

<Step 2>

The substitution antenna is replaced by the transmitter antenna (EUT).

The frequency of the signal generator is adjusted to the measurement frequency.

Level of the signal generator is adjusted to the level that is obtained from step 1, and record the emission level of signal generator.

The spectrum analyzer is set to;

- a) Span = 1.5 times the OBW
- b) RBW = 1-5% of the expected OBW, not to exceed 1 MHz
- c) VBW $\geq 3 \times$ RBW
- d) Number of sweep points $\geq 2 \times$ span / RBW
- e) Sweep time = auto-couple
- f) Detector = RMS (power averaging)
- g) If the EUT can be configured to transmit continuously (i.e., burst duty cycle $\geq 98\%$), then set the trigger to free run.
- h) If the EUT cannot be configured to transmit continuously (i.e., burst duty cycle $< 98\%$), then use a sweep trigger with the level set to enable triggering only on full power bursts and configure the EUT to transmit at full power for the entire duration of each sweep. Ensure that the sweep time is less than or equal to the transmission burst duration.
- i) Trace average at least 100 traces in power averaging (i.e., RMS) mode.
- j) Compute the power by integrating the spectrum across the OBW of the signal using the instrument's band power measurement function, with the band limits set equal to the OBW band edges. If the instrument does not have a band power function, then sum the spectrum levels (in linear power units) at intervals equal to the RBW extending across the entire OBW of the spectrum.

- Test configuration

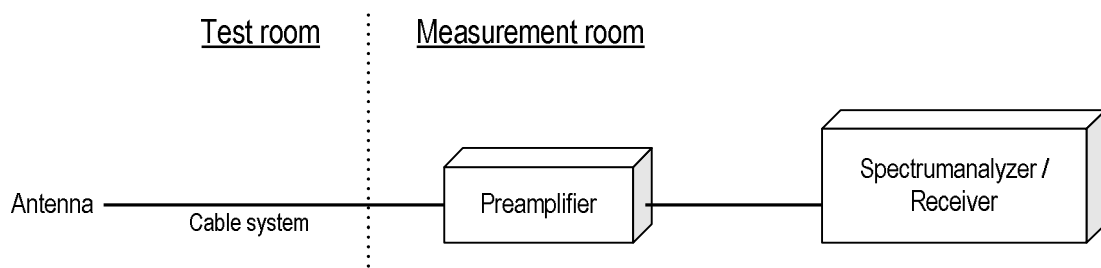



Japan

4.1.2 Calculation method

Result(EIRP) = Ant. Input - Cable loss + Antenna Gain
Margin = Limit – Result (EIRP)

Example:

Limit @ 1880 MHz : 33.0 dBm
Ant. Input = 19.3 dBm Cable loss = 1.1dB Ant. Gain = 8.3 dBi
Result = 19.3 - 1.1 + 8.3 = 26.5 dBm
Margin = 33.0 - 26.5 = 6.5 dB

4.1.3 Limit

2 W (33 dBm)



4.1.4 Test data

Date : 9-October-2019
 Temperature : 20.1 [°C]
 Humidity : 53.5 [%]
 Test place : 3m Semi-anechoic chamber

Test engineer :

Chiaki Kanno

Date : 30-October-2019
 Temperature : 20.9 [°C]
 Humidity : 42.0 [%]
 Test place : 3m Semi-anechoic chamber

Test engineer :

Chiaki Kanno

[GSM1900]

H/V	Frequency [MHz]	S.A Reading [dBm]	Ant. Input [dBm]	Cable loss [dB]	Ant.Gain [dBi]	Result [dBm]	Limit [dBm]	Margin [dB]
H	1850.2	-30.3	22.8	1.1	8.4	30.1	33.0	2.9
H	1880.0	-29.4	25.0	1.1	8.4	32.2	33.0	0.8
H	1909.8	-29.7	23.2	1.2	8.4	30.4	33.0	2.6

4.2 Peak to Average Ratio

4.2.1 Measurement procedure

[FCC 24.232(d)]

The peak to average ratio was measured with a spectrum analyzer connected to the antenna terminal.

The spectrum analyzer is set to;

[GSM1900]

- a) Span = 5 MHz
- b) RBW = 1 MHz
- c) VBW $\geq 3 \times$ RBW
- d) Detector = Peak / Average
- e) Sweep time = auto-couple
- f) Trace mode=Max hold

- Test configuration

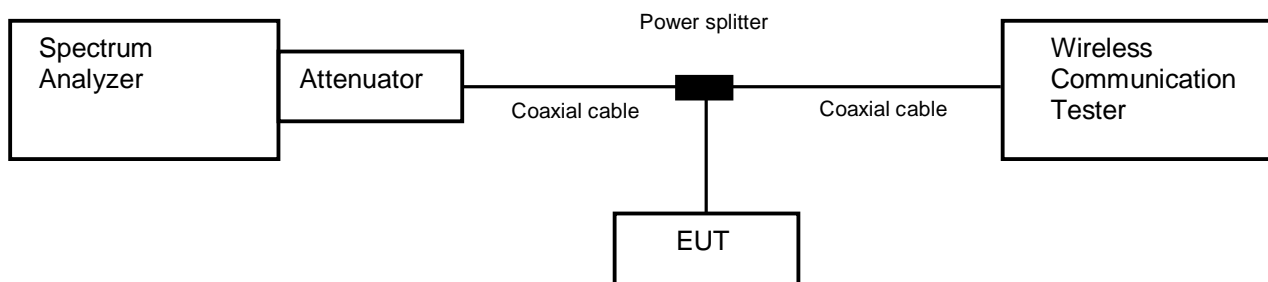

4.2.2 Limit

13 dB or less

4.2.3 Measurement result

Date : 9-October-2019
Temperature : 23.7 [°C]
Humidity : 37.9 [%] Test engineer : Tadahiro Seino
Test place : Shielded room No.4

Band	Channel	Frequency [MHz]	Peak to Average Power Ratio [dB]	Limit [dB]
GSM1900	512	1850.2	0.01	13.0
	661	1880.0	0.01	
	810	1909.8	0.02	

4.2.4 Trace data

[GSM1900]

Channel: 512

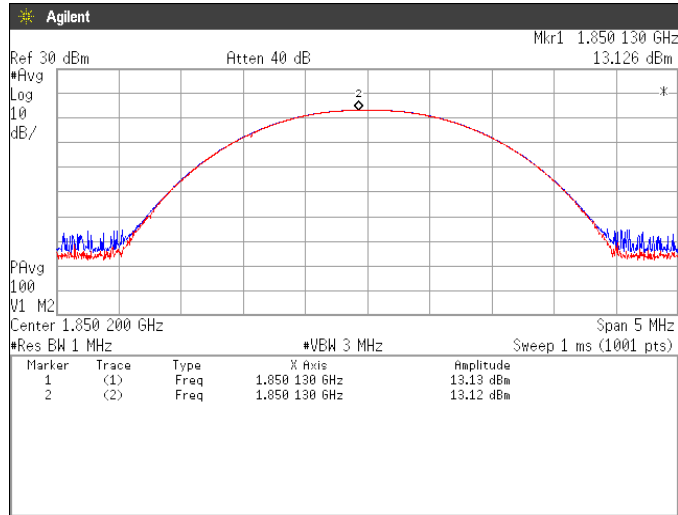

Channel: 661

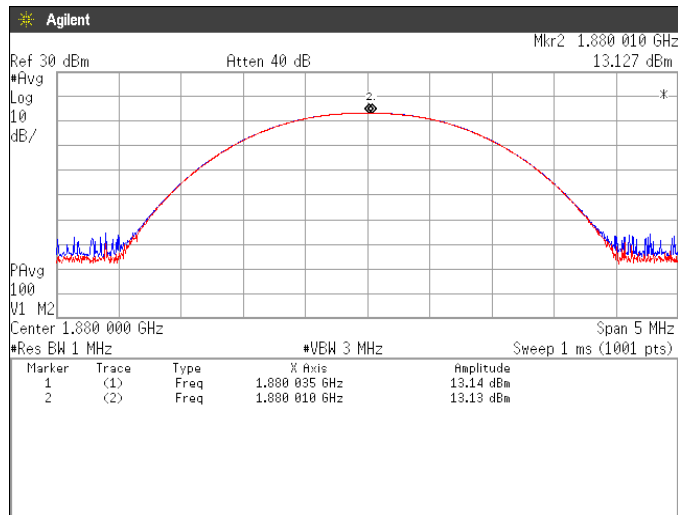

Channel: 810

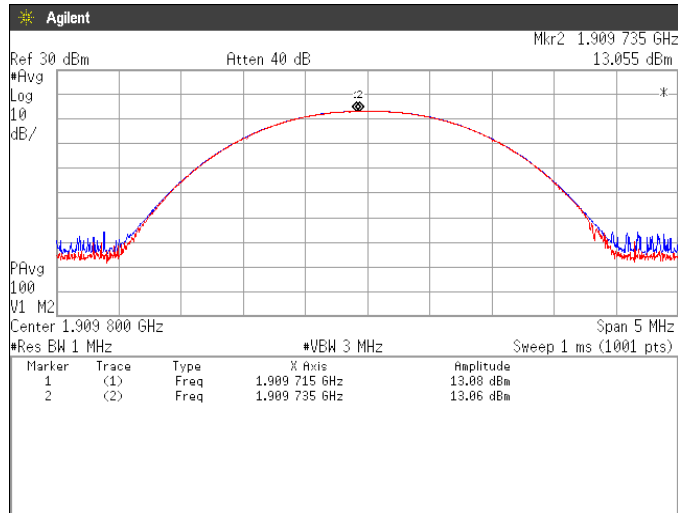

4.3 Occupied Bandwidth

4.3.1 Measurement procedure

[FCC 24.238(a), 2.1049]

The Occupied bandwidth was measured with a spectrum analyzer connected to the antenna terminal.

The spectrum analyzer is set to;

- a) RBW = 1-5% of the expected OBW & VBW $\geq 3 \times$ RBW
- b) Detector = Peak
- c) Trace mode = Max hold
- d) Sweep time = auto-couple

- Test configuration

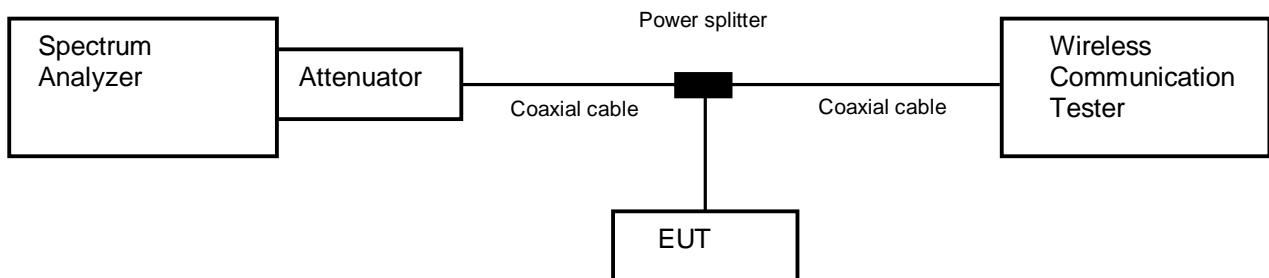

4.3.2 Limit

None

4.3.3 Measurement result

Date : 9-October-2019
 Temperature : 23.7 [°C]
 Humidity : 37.9 [%]
 Test place : Shielded room No.4

Test engineer : Tadahiro Seino

Band	Channel	Frequency [MHz]	Test Result [kHz]
GSM1900	512	1850.2	238.8089
	661	1880.0	239.5441
	810	1909.8	240.1062

4.3.4 Trace data

[GSM1900]

Channel: 512

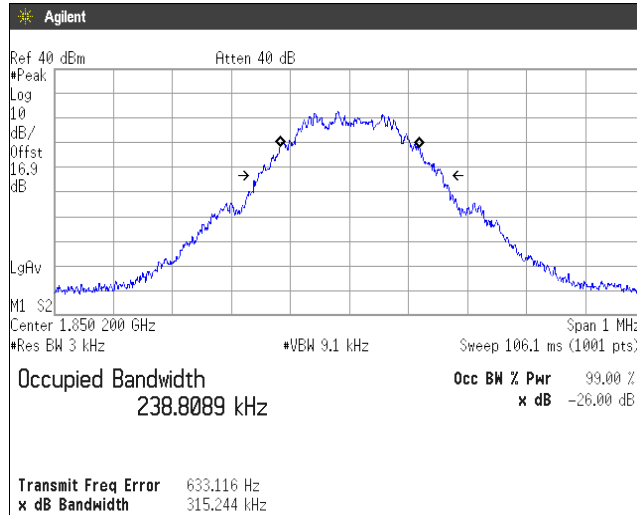

Channel: 661

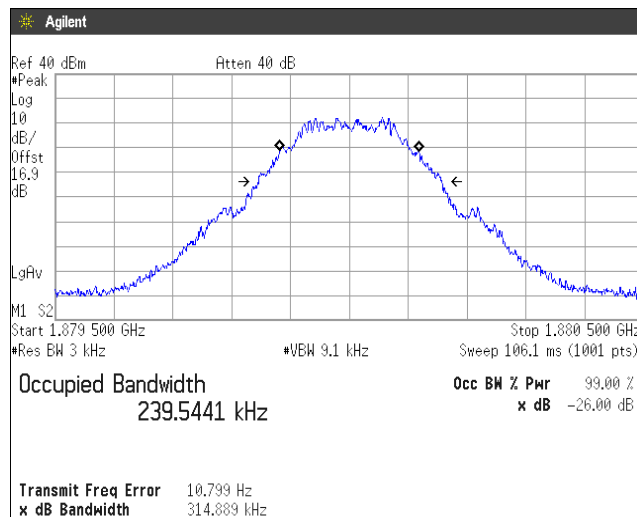

Channel: 810

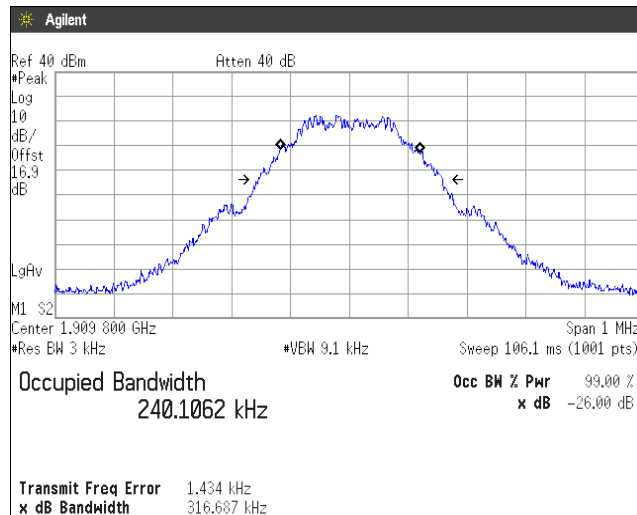

4.4 Band Edge Spurious and Harmonic at Antenna Terminals

4.4.1 Measurement procedure

[FCC 24.238(a), 2.1051]

The band edge spurious and harmonic was measured with a spectrum analyzer connected to the antenna terminal.

The spectrum analyzer is set to;

<Band Edge>

- a) Span was set large enough so as to capture all out of band emissions near the band edge
- b) RBW \geq 1% of the emission bandwidth or 2% of the emission bandwidth
- c) VBW \geq 3 x RBW
- d) Detector = RMS
- e) Trace mode = Max hold
- f) Sweep time = auto-couple
- g) Number of sweep point \geq 2 x span / RBW

<Spurious Emissions>

- a) RBW = 1MHz & VBW \geq 3 x RBW
- b) Detector = Peak
- c) Trace mode = Max hold
- d) Sweep time = auto-couple
- e) Number of sweep point \geq 2 x span / RBW

- Test configuration

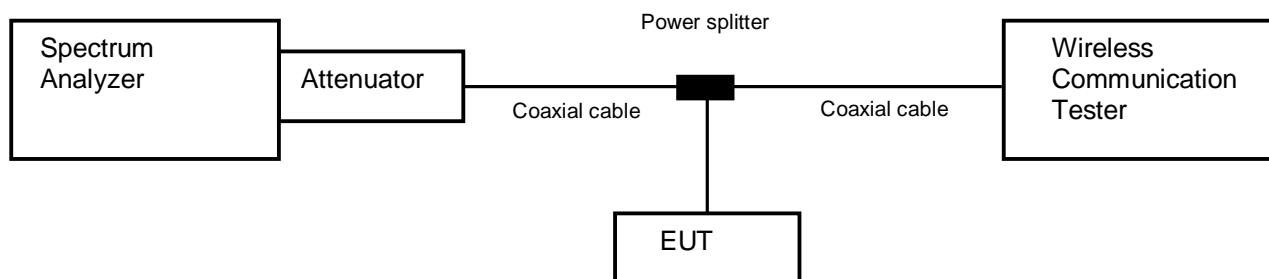

4.4.2 Limit

-13 dBm or less

4.4.3 Measurement result

Date : 17-October-2019
 Temperature : 22.6 [°C]
 Humidity : 45.5 [%]
 Test place : Shielded room No.4

Test engineer : Chiaki Kanno

Band	Channel	Frequency [MHz]	Limit [dB]	Results	
GSM1900	512	1850.2	-13.0	See the trace data	PASS
	810	1909.8	-13.0	See the trace data	PASS



4.4.4 Trace data

[GSM1900]
(Band Edge)

Channel: 512

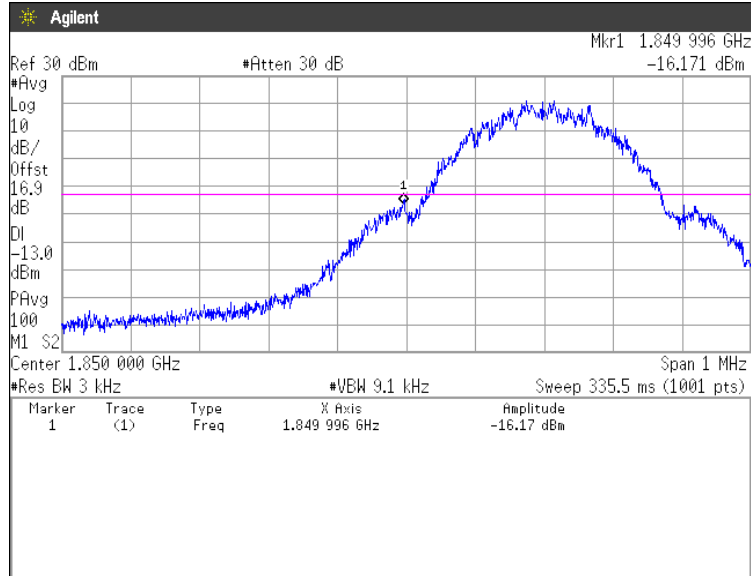

Channel: 810

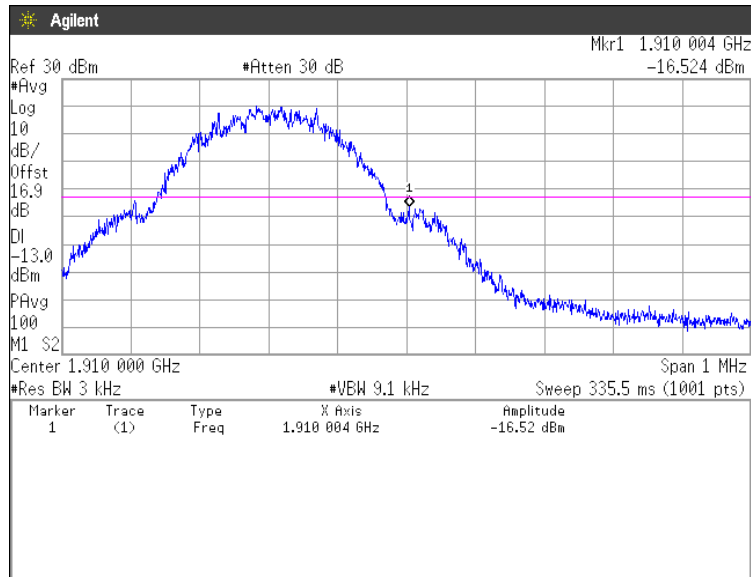



(Spurious Emissions)

Note: Conducted spurious test was measured in the worst case of conducted output power.

**Channel: 512
30MHz-5GHz**

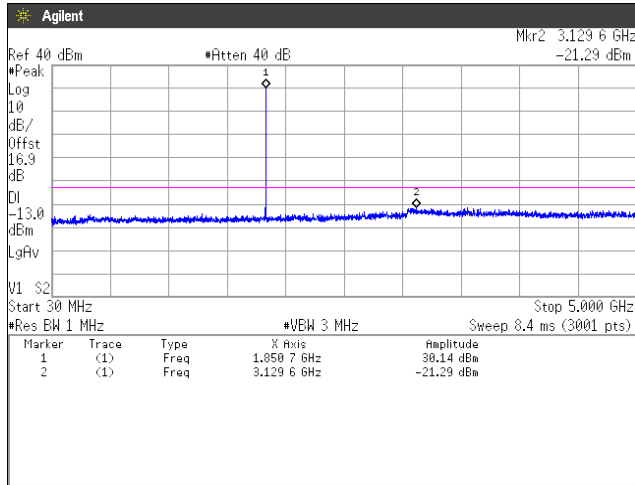

5GHz-10GHz

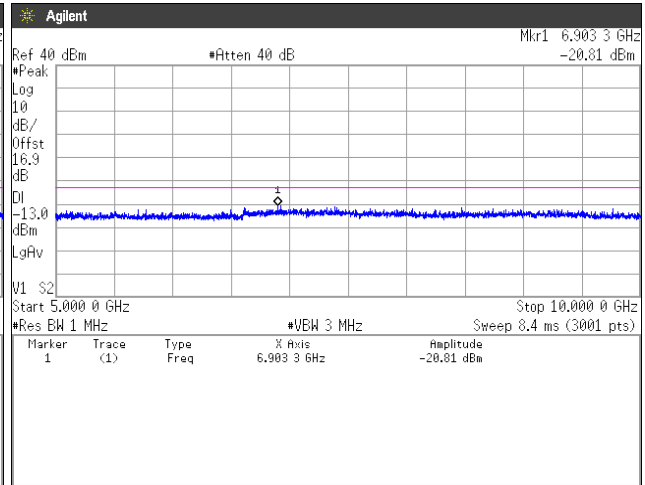

10GHz-15GHz

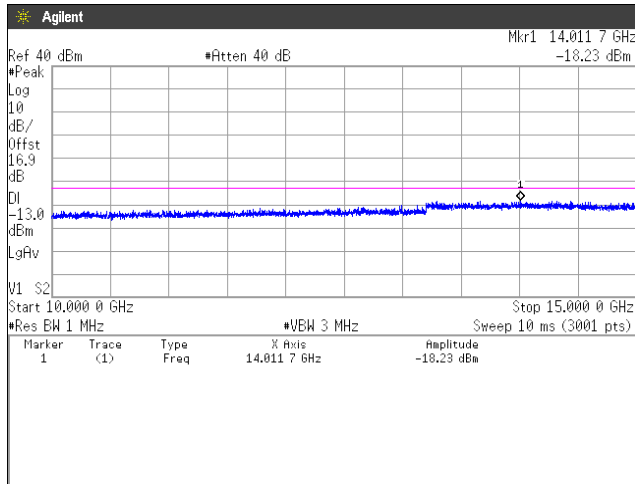

15GHz-20GHz

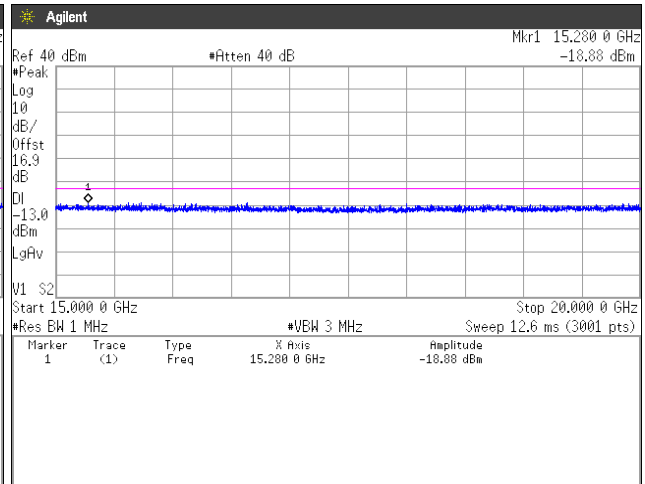



Channel: 661
30MHz-5GHz

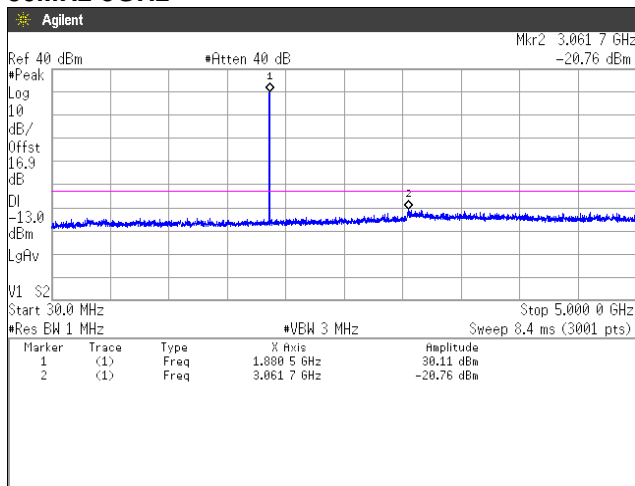

5GHz-10GHz

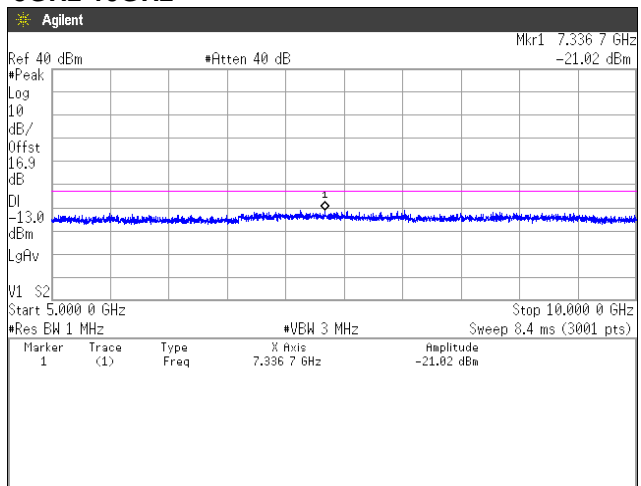

10GHz-15GHz

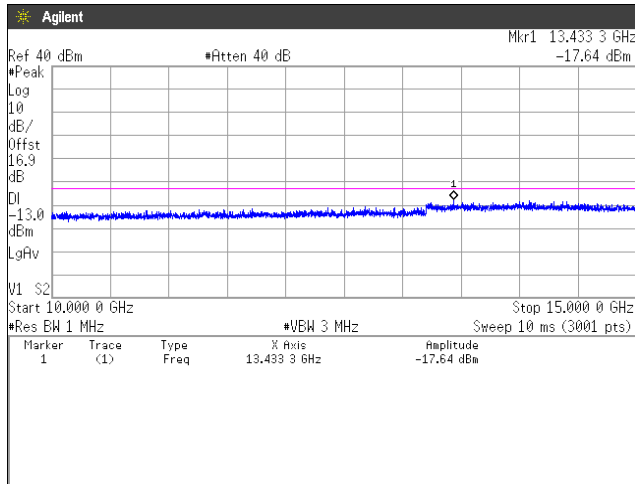

15GHz-20GHz

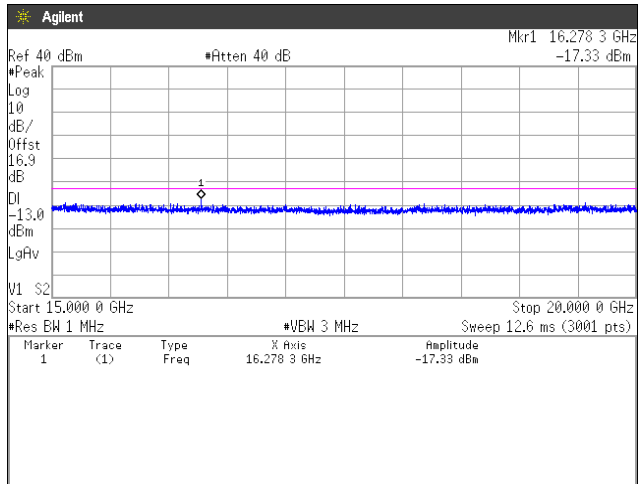



Channel: 810
30MHz-5GHz

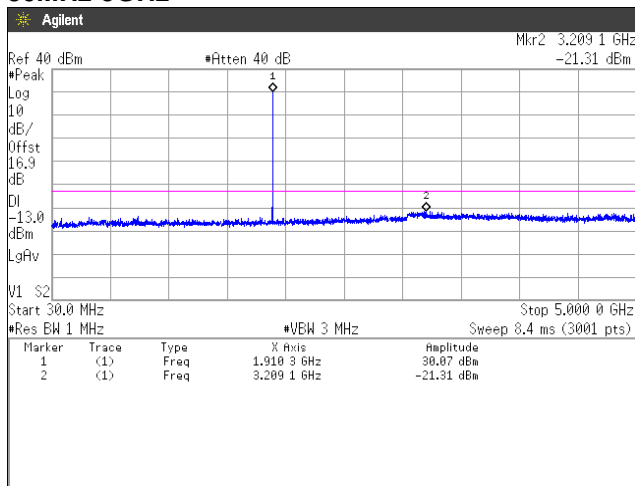

5GHz-10GHz

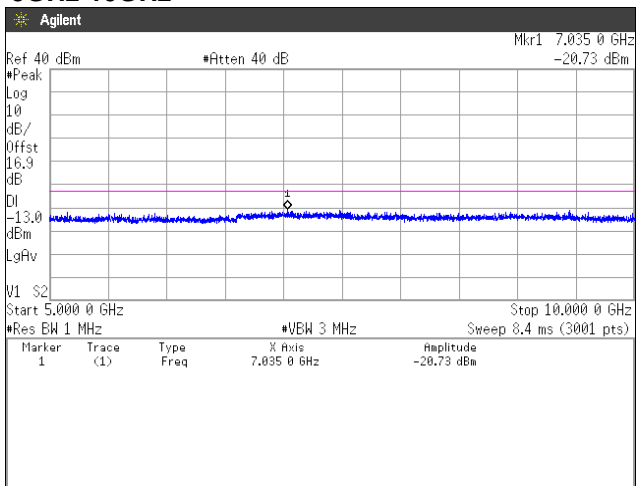

10GHz-15GHz

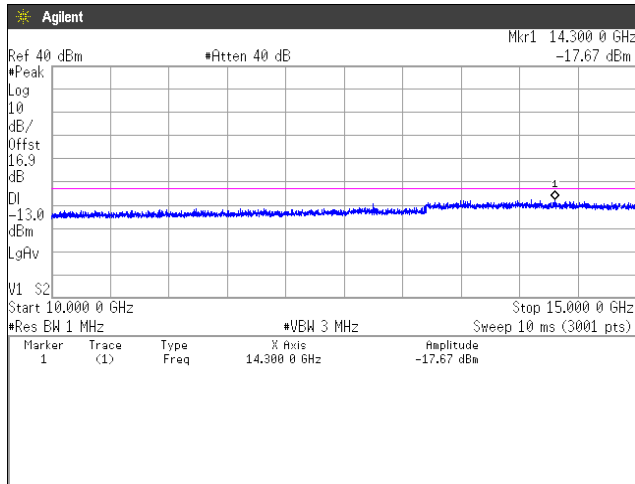

15GHz-20GHz

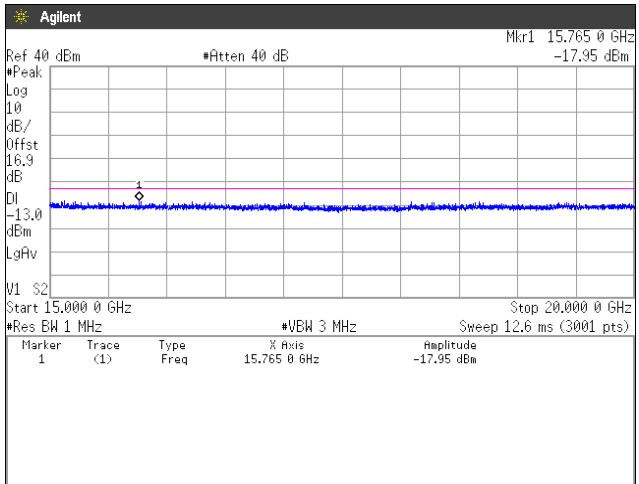

4.5 Radiated Emissions and Harmonic Emissions

4.5.1 Measurement procedure

[FCC 24.238(a), 2.1053]

<Step 1>

The EUT and support equipment are placed on a 1 meter x 1 meter surface, 0.8 meter height styrene foam table. Radiated emission measurements are performed at 3 meter distance with the broadband antenna (Biconical antenna, Log periodic antenna and double ridged guide antenna). The antenna is positioned both the horizontal and vertical planes of polarization and height is varied 1 to 4 meters and stopped at height producing the maximum emission.

The bandwidth of the spectrum analyzer is set to 1 MHz. The turntable is rotated by 360 degrees and stopped at azimuth of producing the maximum emission. The frequency is investigated up to 20 GHz.

<Step 2>

The substitution antenna is replaced by the transmitter antenna (EUT).

The frequency of the signal generator is adjusted to the measurement frequency.

Level of the signal generator is adjusted to the level that is obtained from step 1, and record the emission level of signal generator.

The spectrum analyzer is set to;

- RBW = 100 kHz for below 1 GHz and 1 MHz for above 1 GHz / VBW \geq 3 x RBW
- Detector = Peak
- Trace mode = Max hold
- Sweep time = auto-couple

- Test configuration

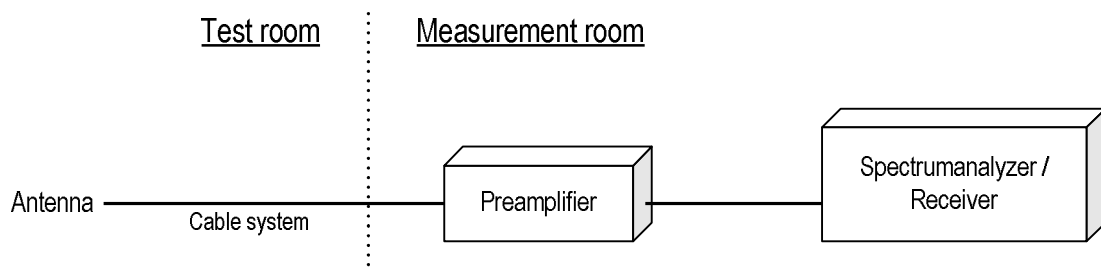

4.5.2 Calculation method

Result = Ant. Input - Cable loss + Antenna Gain

Margin = Limit – Result (EIRP)

Example:

Limit @ 3700.4 MHz : -13.0 dBm

Ant. Input = -55.6 dBm Cable loss = 1.6 dB Ant. Gain = 9.2 dBi

Result = -55.6 - 1.6 + 9.2 = -49.3 dBm

Margin = -13.0 - (-49.3) = 36.3 dB

4.5.3 Limit

-13 dBm or less

4.5.4 Test data

Date : 10-October-2019

Temperature : 20.1 [°C]

Humidity : 53.5 [%]

Test place : 3m Semi-anechoic chamber

Test engineer :

Chiaki Kanno

Date : 30-October-2019

Temperature : 20.9 [°C]

Humidity : 42.0 [%]

Test place : 3m Semi-anechoic chamber

Test engineer :

Chiaki Kanno

[GSM1900]

Channel: 512

H/V	Frequency [MHz]	S.A Reading [dBm]	Ant. Input [dBm]	Cable loss [dB]	Ant.Gain [dBi]	Result [dBm]	Limit [dBm]	Margin [dB]
H	3700.4	-52.8	-53.1	1.6	9.5	-45.2	-13.0	32.2

Channel: 661

H/V	Frequency [MHz]	S.A Reading [dBm]	Ant. Input [dBm]	Cable loss [dB]	Ant.Gain [dBi]	Result [dBm]	Limit [dBm]	Margin [dB]
H	3760.0	-54.3	-54.9	1.6	9.4	-47.1	-13.0	34.1

Channel: 810

H/V	Frequency [MHz]	S.A Reading [dBm]	Ant. Input [dBm]	Cable loss [dB]	Ant.Gain [dBi]	Result [dBm]	Limit [dBm]	Margin [dB]
H	3819.6	-54.7	-55.1	1.7	9.3	-47.4	-13.0	34.4

4.6 Frequency Stability

4.6.1 Measurement procedure

[FCC 24.235, 2.1055]

The EUT was placed of an inside of an constant temperature chamber as the temperature in the chamber was varied between -30°C and $+50^{\circ}\text{C}$. The temperature was incremented by 10°C intervals and the unit was allowed to stabilize at each measurement. The frequency drift was measured with the normal Temperature and voltage tolerance and it is presented as the ppm unit.

- Test configuration

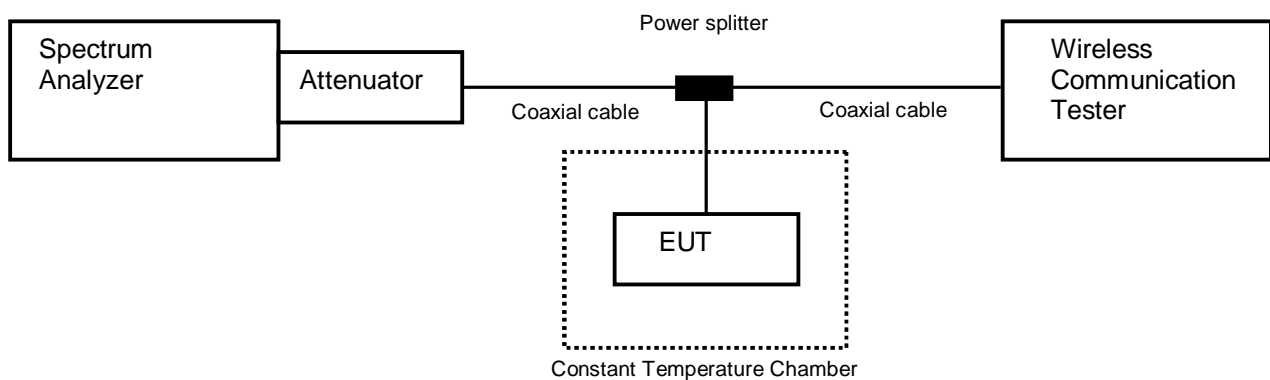

4.6.2 Limit

± 2.5 ppm

4.6.3 Measurement result

Date : 5-November-2019
 Temperature : 25.0 [°C]
 Humidity : 34.0 [%]
 Test place : Shielded room No.4

Test engineer : Tadahiro Seino

[GSM1900]

Channel: 661

Limit: $\pm 0.00025\% = \pm 2.5$ ppm					
Power Supply [V]	Temperature [°C]	Measurements Frequency [Hz]	Frequency Tolerance [ppm]	Limit [ppm]	Result
3.85	25(Ref.)	1,880,000,031	0.00000	± 2.5	Pass
	50	1,880,000,023	-0.00415	± 2.5	Pass
	40	1,880,000,030	-0.00052	± 2.5	Pass
	30	1,879,999,904	-0.06770	± 2.5	Pass
	20	1,880,000,019	-0.00610	± 2.5	Pass
	10	1,879,999,917	-0.06064	± 2.5	Pass
	0	1,880,000,028	-0.00170	± 2.5	Pass
	-10	1,880,000,023	-0.00426	± 2.5	Pass
	-20	1,880,000,013	-0.00952	± 2.5	Pass
	-30	1,880,000,011	-0.01068	± 2.5	Pass
3.47	25	1,880,000,058	0.01432	± 2.5	Pass
4.24	25	1,880,000,029	-0.00120	± 2.5	Pass



Calculation;

Frequency Tolerance (ppm) = Measurements Frequency (Hz) – Reference Frequency (Hz) / Reference Frequency (Hz) x 1000000

5 Measurement Uncertainty

Expanded uncertainties stated are calculated with a coverage Factor k=2.
 Please note that these results are not taken into account when measurement uncertainty considerations contained in ETSI TR 100 028 Parts 1 and 2 determining compliance or non-compliance with test result.

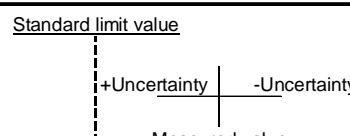
Test item	Measurement uncertainty
Conducted emission, AMN (9 kHz – 150 kHz)	±3.8 dB
Conducted emission, AMN (150 kHz – 30 MHz)	±3.3 dB
Radiated emission (9kHz – 30 MHz)	±3.1 dB
Radiated emission (30 MHz – 1000 MHz)	±4.9 dB
Radiated emission (1 GHz – 6 GHz)	±4.8 dB
Radiated emission (6 GHz – 18 GHz)	±5.1 dB
Radiated emission (18 GHz – 40 GHz)	±5.8 dB
Radio Frequency	±1.4 * 10 ⁻⁸
RF power, conducted	±0.6 dB
Temperature	±0.6 °C
Humidity	±1.2 %
Voltage (DC)	±0.4 %
Voltage (AC, <10kHz)	±0.2 %

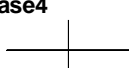
Judge	Measured value and standard limit value
PASS	<p>Case1</p>  <p>Even if it takes uncertainty into consideration, a standard limit value is fulfilled.</p>
	<p>Case2</p>  <p>Although measured value is in a standard limit value, a limit value won't be fulfilled if uncertainty is taken into consideration.</p>
FAIL	<p>Case3</p>  <p>Although measured value exceeds a standard limit value, a limit value will be fulfilled if uncertainty is taken into consideration.</p>
	<p>Case4</p>  <p>Even if it takes uncertainty into consideration, a standard limit value isn't fulfilled.</p>

6 Laboratory Information

Testing was performed and the report was issued at:

TÜV SÜD Japan Ltd. Yonezawa Testing Center

Address: 5-4149-7 Hachimanpara, Yonezawa-shi, Yamagata, 992-1128 Japan
 Phone: +81-238-28-2881
 Fax: +81-238-28-2888

Accreditation and Registration

NVLAP
 LAB CODE: 200306-0

VLAC
 Accreditation No.: VLAC-013

BSMI
 Laboratory Code: SL2-IN-E-6018, SL2-A1-E-6018

Innovation, Science and Economic Development Canada

Site number	Facility	Expiration date
4224A-4	3 m Semi-anechoic chamber	27-November-2020
4224A-5	10 m Semi-anechoic chamber No. 1	27-November-2020
4224A-6	10 m Semi-anechoic chamber No. 2	14-December-2019

VCCI Council

Registration number	Expiration date
A-0166	03-July-2021

Appendix A. Test Equipment

Antenna port conducted test

Equipment	Company	Model No.	Serial No.	Cal. Due	Cal. Date
Spectrum analyzer	Agilent Technologies	E4440A	US44302655	31-Aug-2020	05-Aug-2019
Attenuator	Weinschel	56-10	J4180	31-Jul-2020	18-Jul-2019
Microwave cable	HUBER+SUHNER	SUCOFLEX 104	199119/4	31-Mar-2020	07-Mar-2019
Microwave cable	HUBER+SUHNER	SUCOFELX102/2m	31648	31-Mar-2020	08-Mar-2019
Power divider	ANRITSU	K240B	020205	31-Jul-2020	19-Jul-2019
Wideband Radio Frequency Tester	ROHDE&SCHWARZ	CMW500	126079	31-Oct-2019	12-Oct-2018
Wideband Radio Frequency Tester	ROHDE&SCHWARZ	CMW500	116338	31-Aug-2020	27-Aug-2019
Temperature and humidity chamber	ESPEC	PL1KP	14007261	30-Sep-2020	03-Sep-2019

Radiated emission

Equipment	Company	Model No.	Serial No.	Cal. Due	Cal. Date
EMI Receiver	ROHDE&SCHWARZ	ESCI	100765	30-Sep-2020	25-Sep-2019
Spectrum analyzer	Agilent Technologies	E4447A	MY46180188	30-Apr-2020	16-Apr-2019
Spectrum analyzer	Agilent Technologies	E4440A	US40420937	30-Sep-2020	26-Sep-2019
Preamplifier	SONOMA	310	372170	30-Sep-2020	26-Sep-2019
Biconical antenna	Schwarzbeck	VHA9103/BBA9106	VHA91032155	31-Aug-2019	06-Aug-2018
Log periodic antenna	Schwarzbeck	UHALP9111B	345	31-Aug-2020	27-Aug-2019
Attenuator	TAMAGAWA.ELEC	CFA-01/6dB	N/A(S465)	31-May-2020	17-May-2019
Attenuator	TAMAGAWA.ELEC	CFA-10/3dB	N/A(S503)	31-Jul-2020	17-Jul-2019
Preamplifier	TSJ	MLA-100M18-B02-40	1929118	31-Jan-2020	17-Jan-2019
Attenuator	AEROFLEX	26A-10	081217-08	31-Jan-2020	17-Jan-2019
Double ridged guide antenna	ETS LINDGREN	3117	00224193	31-Jan-2020	23-Jan-2019
Attenuator	Agilent Technologies	8491B	MY39268633	31-Mar-2020	08-Mar-2019
Double ridged guide antenna	A.H.Systems Inc.	SAS-574	469	31-Aug-2020	28-Aug-2019
Preamplifier	TSJ	MLA-1840-B03-35	1240332	31-Aug-2020	28-Aug-2019
Band rejection filter	Micro-Tronics	BRC50720	014	31-Dec-2019	20-Dec-2018
Signal generator	ROHDE&SCHWARZ	SMB100A	177525	31-Jul-2020	18-Jul-2019
RF power amplifier	R&K	CGA020M602-2633R	B40240	31-May-2020	16-May-2019
Microwave cable	HUBER+SUHNER	SUCOFELX102/2m	31648	31-Mar-2020	08-Mar-2019
Dipole antenna	Schwarzbeck	VHAP	1021	31-Aug-2020	15-Aug-2019
Dipole antenna	Schwarzbeck	UHAP	993	31-Aug-2020	15-Aug-2019
Double ridged guide antenna	EMCO	3115	00058532	29-Feb-2020	12-Feb-2019
Double ridged guide antenna	ETS LINDGREN	3117	00218815	31-Dec-2019	27-Dec-2018
Wideband Radio Frequency Tester	ROHDE&SCHWARZ	CMW500	126079	31-Oct-2019	12-Oct-2018
Wideband Radio Frequency Tester	ROHDE&SCHWARZ	CMW500	116338	31-Aug-2020	27-Aug-2019
Microwave cable	HUBER+SUHNER	SUCOFLEX104/9m	MY30037/4	31-Jan-2020	16-Jan-2019
		SUCOFLEX104/1m	my24610/4	31-Jan-2020	16-Jan-2019
		SUCOFLEX104/8m	SN MY30031/4	31-Jan-2020	16-Jan-2019
		SUCOFLEX104	MY32976/4	31-Jan-2020	16-Jan-2019
		SUCOFLEX104/1.5m	MY19309/4	31-Jan-2020	16-Jan-2019
		SUCOFLEX104/7m	41625/6	31-Jan-2020	16-Jan-2019
PC	DELL	DIMENSION E521	75465BX	N/A	N/A
Software	TOYO Corporation	EP5/RE-AJ	0611193/V5.6.0	N/A	N/A
Absorber	RIKEN	PFP30	N/A	N/A	N/A
3m Semi an-echoic Chamber	TOKIN	N/A	N/A(9002-NSA)	31-May-2020	14-May-2019
3m Semi an-echoic Chamber	TOKIN	N/A	N/A(9002-SVSWR)	31-May-2020	13-May-2019

*: The calibrations of the above equipment are traceable to NIST or equivalent standards of the reference organizations.