

TEST REPORT

CERTIFICATE OF CONFORMITY

Standard: 47 CFR FCC Part 15, Subpart C (Section 15.247)

Report No.: RFBDKG-WTW-P23090423-1

FCC ID: JNZYR0098

Product: Wireless Keyboard

Brand: logitech G, G

Model No.: YR0098

Received Date: 2023/9/26

Test Date: 2023/9/27 ~ 2023/10/7

Issued Date: 2023/11/7

Applicant: Logitech Far East Ltd.

Address: #2 Creation Rd. 4, Science-Based Ind. Park Hsinchu Taiwan, R.O.C.

Issued By: Bureau Veritas Consumer Products Services (H.K.) Ltd., Taoyuan Branch
Hsin Chu Laboratory

Lab Address: E-2, No.1, Li Hsin 1st Road, Hsinchu Science Park, Hsinchu City 300, Taiwan

Test Location: E-2, No.1, Li Hsin 1st Road, Hsinchu Science Park, Hsinchu City 300, Taiwan

FCC Registration / 723255 / TW2022

Designation Number:

Approved by:  , Date: 2023/11/7

May Chen / Manager

This test report consists of 42 pages in total. It may be duplicated completely for legal use with the approval of the applicant. It should not be reproduced except in full, without the written approval of our laboratory. The test results in the report only apply to the tested sample. The test results in this report are traceable to the national or international standards.



Prepared by : Vito Lung / Specialist

This report is governed by, and incorporates by reference, the Conditions of Testing as posted at the date of issuance of this report at <http://www.bureauveritas.com/home/about-us/our-business/cps/about-us/terms-conditions/> and is intended for your exclusive use. Any copying or replication of this report to or for any other person or entity, or use of our name or trademark, is permitted only with our prior written permission. This report sets forth our findings solely with respect to the test samples identified herein. The results set forth in this report are not indicative or representative of the quality or characteristics of the lot from which a test sample was taken or any similar or identical product unless specifically and expressly noted. Our report includes all of the tests requested by you and the results thereof based upon the information that you provided to us. Measurement uncertainty is only provided upon request for accredited tests. Statements of conformity are based on simple acceptance criteria without taking measurement uncertainty into account, unless otherwise requested in writing. You have 60 days from date of issuance of this report to notify us of any material error or omission caused by our negligence or if you require measurement uncertainty; provided, however, that such notice shall be in writing and shall specifically address the issue you wish to raise. A failure to raise such issue within the prescribed time shall constitute your unqualified acceptance of the completeness of this report, the tests conducted and the correctness of the report contents.

Table of Contents

Release Control Record	4
1 Certificate	5
2 Summary of Test Results	6
2.1 Measurement Uncertainty	6
2.2 Supplementary Information	6
3 General Information	7
3.1 General Description	7
3.2 Antenna Description of EUT	8
3.3 Channel List	9
3.4 Test Mode Applicability and Tested Channel Detail	10
3.5 Duty Cycle of Test Signal	11
3.6 Test Program Used and Operation Descriptions	12
3.7 Connection Diagram of EUT and Peripheral Devices	12
3.8 Configuration of Peripheral Devices and Cable Connections	13
4 Test Instruments	14
4.1 RF Output Power	14
4.2 Power Spectral Density	14
4.3 6 dB Bandwidth	14
4.4 Conducted Out of Band Emissions	14
4.5 AC Power Conducted Emissions	15
4.6 Unwanted Emissions below 1 GHz	15
4.7 Unwanted Emissions above 1 GHz	16
5 Limits of Test Items	17
5.1 RF Output Power	17
5.2 Power Spectral Density	17
5.3 6 dB Bandwidth	17
5.4 Conducted Out of Band Emissions	17
5.5 AC Power Conducted Emissions	17
5.6 Unwanted Emissions below 1 GHz	17
5.7 Unwanted Emissions above 1 GHz	18
6 Test Arrangements	19
6.1 RF Output Power	19
6.1.1 Test Setup	19
6.1.2 Test Procedure	19
6.2 Power Spectral Density	19
6.2.1 Test Setup	19
6.2.2 Test Procedure	19
6.3 6 dB Bandwidth	20
6.3.1 Test Setup	20
6.3.2 Test Procedure	20
6.4 Conducted Out of Band Emissions	20
6.4.1 Test Setup	20
6.4.2 Test Procedure	20
6.5 AC Power Conducted Emissions	21
6.5.1 Test Setup	21
6.5.2 Test Procedure	21
6.6 Unwanted Emissions below 1 GHz	22
6.6.1 Test Setup	22
6.6.2 Test Procedure	23
6.7 Unwanted Emissions above 1 GHz	24
6.7.1 Test Setup	24
6.7.2 Test Procedure	24
7 Test Results of Test Item	25



7.1	RF Output Power	25
7.2	Power Spectral Density	26
7.3	6 dB Bandwidth	27
7.4	Conducted Out of Band Emissions	28
7.5	AC Power Conducted Emissions	29
7.6	Unwanted Emissions below 1 GHz	31
7.7	Unwanted Emissions above 1 GHz.....	33
8	Pictures of Test Arrangements	41
9	Information of the Testing Laboratories	42



Release Control Record

Issue No.	Description	Date Issued
RFBDKG-WTW-P23090423-1	Original release.	2023/11/7

1 Certificate

Product: Wireless Keyboard

Brand: logitech G, G

Test Model: YR0098

Sample Status: Engineering sample

Applicant: Logitech Far East Ltd.

Test Date: 2023/9/27 ~ 2023/10/7

Standard: 47 CFR FCC Part 15, Subpart C (Section 15.247)

Measurement ANSI C63.10-2013

procedure: KDB 558074 D01 15.247 Meas Guidance v05r02

The above equipment has been tested by **Bureau Veritas Consumer Products Services (H.K.) Ltd., Taoyuan Branch**, and found compliance with the requirement of the above standards. The test record, data evaluation & Equipment Under Test (EUT) configurations represented herein are true and accurate accounts of the measurements of the sample's RF characteristics under the conditions specified in this report.

2 Summary of Test Results

47 CFR FCC Part 15, Subpart C (Section 15.247)			
Standard / Clause	Test Item	Result	Remark
15.247(b)	RF Output Power	Pass	Meet the requirement of limit.
15.247(e)	Power Spectral Density	Pass	Meet the requirement of limit.
15.247(a)(2)	6 dB Bandwidth	Pass	Meet the requirement of limit.
15.247(d)	Conducted Out of Band Emissions	Pass	Meet the requirement of limit.
15.207	AC Power Conducted Emissions	Pass	Minimum passing margin is -16.49 dB at 12.38281 MHz
15.205 / 15.209 / 15.247(d)	Unwanted Emissions below 1 GHz	Pass	Minimum passing margin is -6.3 dB at 30.00 MHz
15.205 / 15.209 / 15.247(d)	Unwanted Emissions above 1 GHz	Pass	Minimum passing margin is -8 dB at 2351.17 MHz
15.203	Antenna Requirement	Pass	No antenna connector is used.

Note: Determining compliance based on the results of the compliance measurement, not taking into account measurement instrumentation uncertainty.

2.1 Measurement Uncertainty

Where relevant, the following measurement uncertainty levels have been estimated for tests performed on the EUT as specified in CISPR 16-4-2:

Parameter	Specification	Expanded Uncertainty (k=2) (±)
RF Output Power	-	1.1 dB
Power Spectral Density	-	1.3 dB
6 dB Bandwidth	-	1050.00 Hz
Conducted Out of Band Emissions	9 kHz ~ 40 GHz	2.6 dB
AC Power Conducted Emissions	150 kHz ~ 30 MHz	1.9 dB
Unwanted Emissions below 1 GHz	9 kHz ~ 30 MHz	3.1 dB
	30 MHz ~ 1 GHz	5.1 dB
Unwanted Emissions above 1 GHz	1 GHz ~ 18 GHz	5.1 dB

The other instruments specified are routine verified to remain within the calibrated levels, no measurement uncertainty is required to be calculated.

2.2 Supplementary Information

There is not any deviation from the test standards for the test method, and no modifications required for compliance.

3 General Information

3.1 General Description

Product	Wireless Keyboard
Brand	logitech G, G
Test Model	YR0098
Status of EUT	Engineering sample
Power Supply Rating	3.8 Vdc from battery or 5 Vdc from USB interface
Modulation Type	GFSK
Modulation Technology	DTS
Transfer Rate	2 Mbps
Operating Frequency	2.403 GHz ~ 2.479 GHz
Number of Channel	77
Output Power (LIGHTSPEED)	2.844 mW (4.54 dBm)

Note:

1. The EUT may have a lot of colors for marketing requirement.
2. The EUT could be supplied with battery as the following table:

Manufacturer	Model	Specification
Highpower	345085	Power Rating: 3.8Vdc, 1500mAh, 5.7Wh

3. The EUT uses following accessories.

Wireless USB dongle		
Brand	Model	
Logitech	CU0021	
Extender		
Brand	Model	
logitech G, G	502-001365	
USB-A to USB-C cable		
Brand	Model	Specification
logitech G, G	502-001478	Signal Line: shielded with 1 core, 1.8m

4. The above EUT information is declared by manufacturer and for more detailed features description, please refer to the manufacturer's specifications or User's Manual.

3.2 Antenna Description of EUT

1. The antenna information is listed as below.

Antenna Gain (dBi)	Frequency range (GHz)	Antenna Type	Connector Type
3.68	2.4~2.4835	PIFA	none

* Detail antenna specification please refer to antenna datasheet and/or antenna measurement report.

3.3 Channel List

77 channels are provided to this EUT: (LIGHTSPEED)

Channel	Freq. (MHz)	Channel	Freq. (MHz)	Channel	Freq. (MHz)	Channel	Freq. (MHz)
1	2403	21	2423	41	2443	61	2463
2	2404	22	2424	42	2444	62	2464
3	2405	23	2425	43	2445	63	2465
4	2406	24	2426	44	2446	64	2466
5	2407	25	2427	45	2447	65	2467
6	2408	26	2428	46	2448	66	2468
7	2409	27	2429	47	2449	67	2469
8	2410	28	2430	48	2450	68	2470
9	2411	29	2431	49	2451	69	2471
10	2412	30	2432	50	2452	70	2472
11	2413	31	2433	51	2453	71	2473
12	2414	32	2434	52	2454	72	2474
13	2415	33	2435	53	2455	73	2475
14	2416	34	2436	54	2456	74	2476
15	2417	35	2437	55	2457	75	2477
16	2418	36	2438	56	2458	76	2478
17	2419	37	2439	57	2459	77	2479
18	2420	38	2440	58	2460		
19	2421	39	2441	59	2461		
20	2422	40	2442	60	2462		

3.4 Test Mode Applicability and Tested Channel Detail

Pre-Scan:	1. For Unwanted Emission (below 1GHz) items: Battery/ AC Adapter. Pre-scan these modes and find the worst case as a representative test condition. 2. For AC power conducted emission items: AC Adapter/ Laptop. Only these modes as a representative test condition. 3. Pre-Scan has been conducted to determine the worst-case mode from all possible combinations between available modulations, data rates and antenna ports (if EUT with antenna diversity architecture).
Worst Case:	1. Unwanted Emission (below 1GHz) worst condition: AC Adapter 2. AC power conducted emission worst condition: Laptop 3. For other test items, the worst case was found in AC Adapter

Following channel(s) was (were) selected for the final test as listed below:

Test Item	Tested Channel	Modulation	Data Rate Parameter
RF Output Power	1, 40, 77	GFSK	2Mb/s
Power Spectral Density	1, 40, 77	GFSK	2Mb/s
6 dB Bandwidth	1, 40, 77	GFSK	2Mb/s
Conducted Out of Band Emissions	1, 40, 77	GFSK	2Mb/s
AC Power Conducted Emissions	77	GFSK	2Mb/s
Unwanted Emissions below 1 GHz	77	GFSK	2Mb/s
Unwanted Emissions above 1 GHz	1, 40, 77	GFSK	2Mb/s

3.5 Duty Cycle of Test Signal

GFSK: Duty cycle = $0.188 \text{ ms} / 0.763 \text{ ms} \times 100\% = 24.6\%$

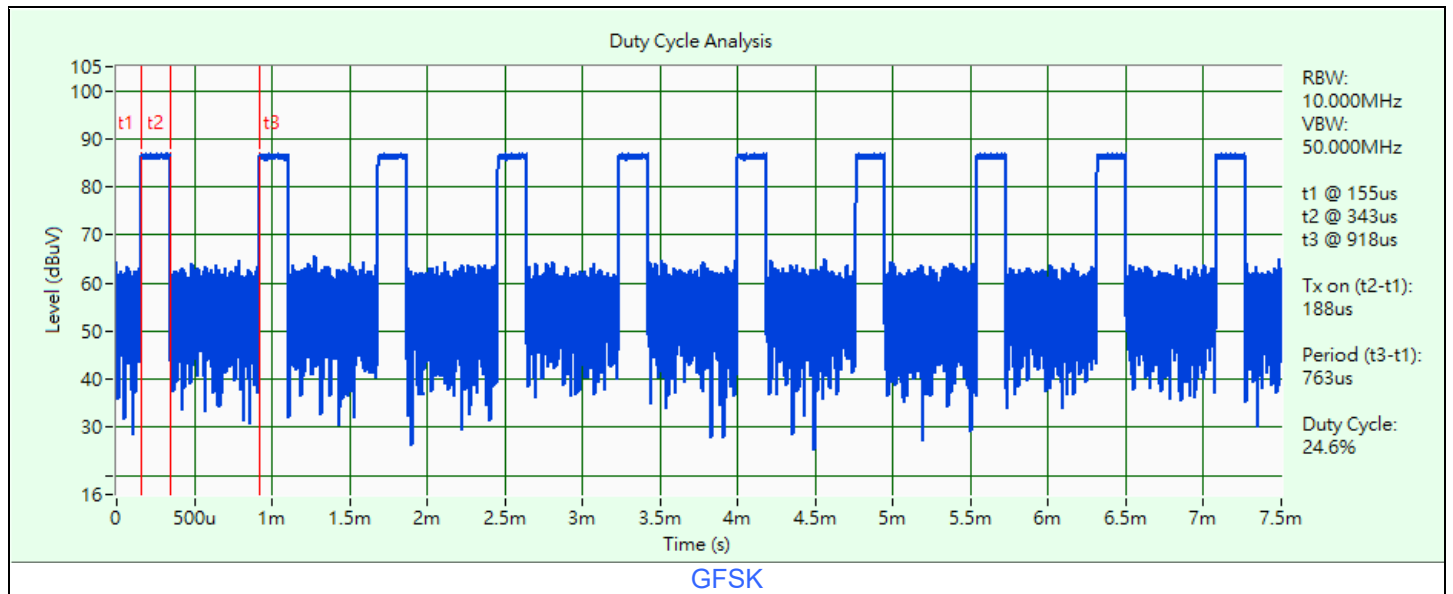

3.6 Test Program Used and Operation Descriptions

Controlling software (RF Sample with Receiver [Number Lock]) has been activated to set the EUT under transmission condition continuously at specific channel frequency.

Test Item	Operation Description
RF Output Power / Power Spectral Density / 6 dB Bandwidth / Conducted Out of Band Emissions / Unwanted Emissions above 1 GHz	LS2 TX Modulated 2403MHz LS2 TX Modulated 2442MHz LS2 TX Modulated 2479MHz
AC Power Conducted Emissions / Unwanted Emissions below 1 GHz	LS2 TX Modulated 2479MHz

3.7 Connection Diagram of EUT and Peripheral Devices

For Unwanted Emission test

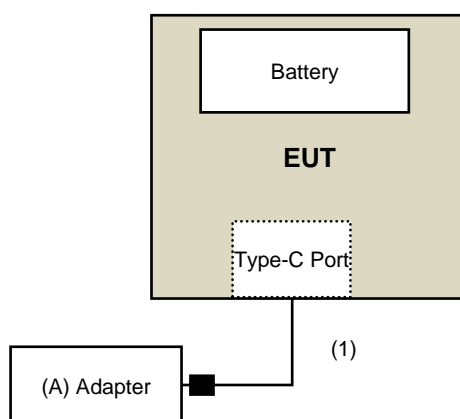

For AC Power Conducted Emission test

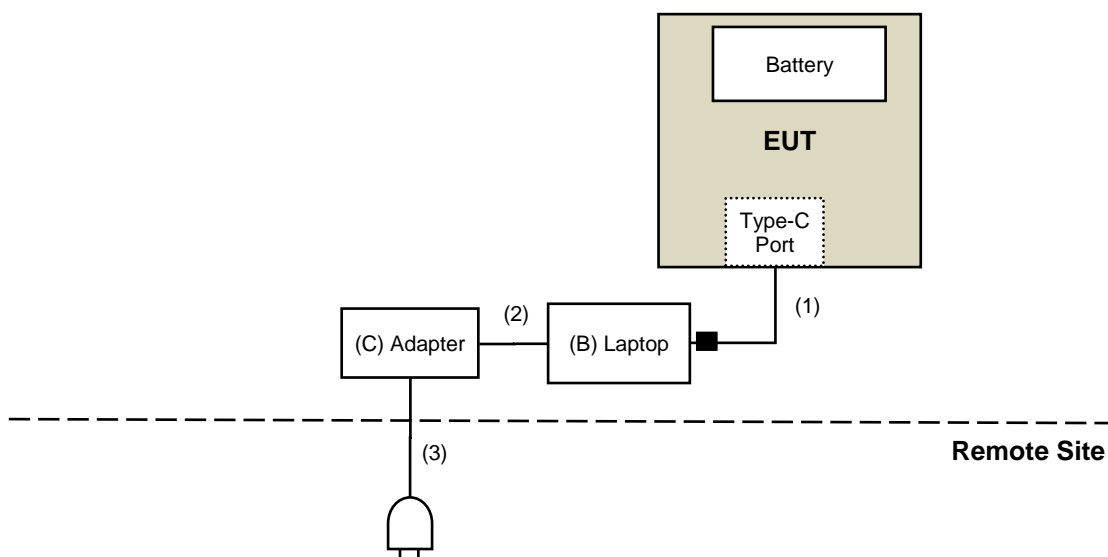

3.8 Configuration of Peripheral Devices and Cable Connections

ID	Product	Brand	Model No.	Serial No.	FCC ID	Remarks
A	Adapter	ASUS	EXA1205UA	N/A	N/A	Provided by Lab
B	Laptop	Lenovo	20U5S01X00 L14	PF-1ANPYA	N/A	Provided by Lab
C	Adapter	Lenovo	ADLX45YLC3D	SA10R16866	N/A	Provided by Lab

ID	Cable Descriptions	Qty.	Length (m)	Shielding (Yes/No)	Cores (Qty.)	Remarks
1	USB-A to USB-C cable	1	1.8	Yes	1	Supplied by applicant
2	DC Cable	1	1.7	NO	0	Provided by Lab
3	AC Power Cable	1	0.9	NO	0	Provided by Lab

4 Test Instruments

The calibration interval of the all test instruments are 12 months and the calibrations are traceable to NML/ROC and NIST/USA.

4.1 RF Output Power

Description Manufacturer	Model No.	Serial No.	Calibrated Date	Calibrated Until
Power Meter Anritsu	ML2495A	1529002	2023/6/17	2024/6/16
Pulse Power Sensor Anritsu	MA2411B	1726434	2023/6/19	2024/6/18

Notes:

1. The test was performed in Oven room 2.
2. Tested Date: 2023/9/27 ~ 2023/10/7

4.2 Power Spectral Density

Description Manufacturer	Model No.	Serial No.	Calibrated Date	Calibrated Until
MXA Signal Analyzer Keysight	N9020B	MY60112409	2023/2/18	2024/2/17
Software	ADT_RF Test Software V7.6.5.4	N/A	N/A	N/A

Notes:

1. The test was performed in Oven room 2.
2. Tested Date: 2023/9/27 ~ 2023/10/7

4.3 6 dB Bandwidth

Refer to section 4.2 to get information of the instruments.

4.4 Conducted Out of Band Emissions

Refer to section 4.2 to get information of the instruments.

4.5 AC Power Conducted Emissions

Description Manufacturer	Model No.	Serial No.	Calibrated Date	Calibrated Until
50 ohm terminal resistance	N/A	EMC-04	2022/10/25	2023/10/24
EMI Test Receiver R&S	ESCS 30	100375	2023/5/17	2024/5/16
Fixed Attenuator STI	STI02-2200-10	005	2023/7/1	2024/6/30
LISN R&S	ENV216	100071	2022/10/26	2023/10/25
RF Coaxial Cable JYEBAO	5D-FB	COCCAB-001	2023/7/1	2024/6/30
Software BVADT	BVADT_Cond_V7.3.7.4	N/A	N/A	N/A

Notes:

1. The test was performed in Conduction 1
2. Tested Date: 2023/10/6

4.6 Unwanted Emissions below 1 GHz

Description Manufacturer	Model No.	Serial No.	Calibrated Date	Calibrated Until
Bi_Log Antenna Schwarzbeck	VULB 9168	9168-0842	2022/10/24	2023/10/23
Boresight Antenna Tower & Turn Table Max-Full	MF-7802BS	MF780208530	N/A	N/A
EMI Test Receiver R&S	ESR3	102528	2023/2/10	2024/2/9
Fixed Attenuator Mini-Circuits	UNAT-5+	PAD-ATT5-02	2022/12/28	2023/12/27
Loop Antenna Electro-Metrics	EM-6879	264	2023/2/21	2024/2/20
MXA Signal Analyzer Keysight	N9020B	MY60112410	2023/3/6	2024/3/5
Preamplifier EMCI	EMC330N	980538	2023/4/6	2024/4/5
	EMC001340	980142	2023/5/8	2024/5/7
PXA Signal Analyzer Keysight	N9030B	MY57141948	2023/5/19	2024/5/18
RF Coaxial Cable JYEBAO	5D-FB	LOOPCAB-001	2022/12/19	2023/12/18
		LOOPCAB-002	2022/12/19	2023/12/18
RF Coaxial Cable PEWC	8D	966-5-1	2023/4/6	2024/4/5
		966-5-2	2023/4/6	2024/4/5
		966-5-3	2023/4/6	2024/4/5
Software	ADT_Radiated_V8.7.08	N/A	N/A	N/A

Notes:

1. The test was performed in 966 Chamber No. 5.
2. Tested Date: 2023/10/3 ~ 2023/10/4

4.7 Unwanted Emissions above 1 GHz

Description Manufacturer	Model No.	Serial No.	Calibrated Date	Calibrated Until
Boresight Antenna Tower & Turn Table Max-Full	MF-7802BS	MF780208530	N/A	N/A
EMI Test Receiver R&S	ESR3	102528	2023/2/10	2024/2/9
Horn Antenna Schwarzbeck	BBHA 9120D	9120D-1819	2022/11/13	2023/11/12
MXA Signal Analyzer Keysight	N9020B	MY60112410	2023/3/6	2024/3/5
Preamplifier EMCI	EMC12630SE	980509	2023/4/7	2024/4/6
RF Coaxial Cable EMCI	EMC104-SM-SM-1500	180503	2023/4/7	2024/4/6
	EMC104-SM-SM-2000	180501	2023/4/7	2024/4/6
	EMC104-SM-SM-6000	180506	2023/4/7	2024/4/6
Software	ADT_Radiated_V8.7.08	N/A	N/A	N/A

Notes:

1. The test was performed in 966 Chamber No. 5.
2. Tested Date: 2023/9/28

5 Limits of Test Items

5.1 RF Output Power

For systems using digital modulation in the 2400–2483.5 MHz bands: 1 Watt (30 dBm)

5.2 Power Spectral Density

The Maximum of Power Spectral Density Measurement is 8 dBm in any 3 kHz.

5.3 6 dB Bandwidth

The minimum of 6 dB Bandwidth Measurement is 0.5 MHz.

5.4 Conducted Out of Band Emissions

Below 20 dB of the highest emission level of operating band (in 100 kHz Resolution Bandwidth).

5.5 AC Power Conducted Emissions

Frequency (MHz)	Conducted Limit (dBuV)	
	Quasi-peak	Average
0.15 - 0.5	66 - 56	56 - 46
0.50 - 5.0	56	46
5.0 - 30.0	60	50

Notes:

1. The lower limit shall apply at the transition frequencies.
2. The limit decreases in line with the logarithm of the frequency in the range of 0.15 to 0.50 MHz.

5.6 Unwanted Emissions below 1 GHz

Radiated emissions up to 1 GHz which fall in the restricted bands must comply with the radiated emission limits specified as below table. Other emissions shall be at least 20 dB below the highest level of the desired power:

Frequencies (MHz)	Field Strength (microvolts/meter)	Measurement Distance (meters)
0.009 ~ 0.490	2400/F(kHz)	300
0.490 ~ 1.705	24000/F(kHz)	30
1.705 ~ 30.0	30	30
30 ~ 88	100	3
88 ~ 216	150	3
216 ~ 960	200	3
Above 960	500	3

Notes:

1. The lower limit shall apply at the transition frequencies.
2. Emission level (dBuV/m) = 20 log Emission level (uV/m).

5.7 Unwanted Emissions above 1 GHz

Radiated emissions above 1 GHz which fall in the restricted bands must comply with the radiated emission limits specified as below table. Other emissions shall be at least 20 dB below the highest level of the desired power:

Frequencies (MHz)	Field Strength (microvolts/meter)	Measurement Distance (meters)
Above 960	500	3

Notes:

1. The lower limit shall apply at the transition frequencies.
2. Emission level (dBuV/m) = 20 log Emission level (uV/m).
3. For frequencies above 1000 MHz, the field strength limits are based on average detector, however, the peak field strength of any emission shall not exceed the maximum permitted average limits, specified above by more than 20 dB under any condition of modulation.

6 Test Arrangements

6.1 RF Output Power

6.1.1 Test Setup

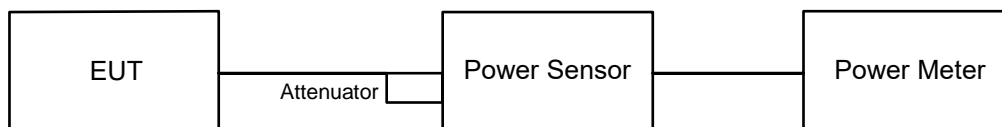

6.1.2 Test Procedure

Peak Power:

A peak power sensor was used on the output port of the EUT. A power meter was used to read the response of the peak power sensor. Record the power level.

Average Power:

Average power sensor was used to perform output power measurement, trigger and gating function of wide band power meter is enabled to measure max output power of TX on burst. Duty factor is not added to measured value.

6.2 Power Spectral Density

6.2.1 Test Setup

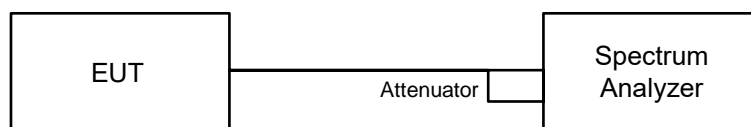

6.2.2 Test Procedure

- a. Set analyzer center frequency to DTS channel center frequency.
- b. Set the span to 1.5 times the DTS bandwidth.
- c. Set the RBW to: 3 kHz.
- d. Set the VBW $\geq 3 \times$ RBW.
- e. Detector = peak.
- f. Sweep time = auto couple.
- g. Trace mode = max hold.
- h. Allow trace to fully stabilize.
- i. Use the peak marker function to determine the maximum amplitude level within the RBW.

6.3 6 dB Bandwidth

6.3.1 Test Setup

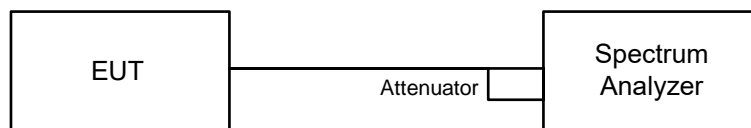

6.3.2 Test Procedure

- Set resolution bandwidth (RBW) = 100 kHz.
- Set the video bandwidth (VBW) $\geq 3 \times$ RBW, Detector = Peak.
- Trace mode = max hold.
- Sweep = auto couple.
- Measure the maximum width of the emission that is constrained by the frequencies associated with the two amplitude points (upper and lower) that are attenuated by 6 dB relative to the maximum level measured in the fundamental emission.

6.4 Conducted Out of Band Emissions

6.4.1 Test Setup

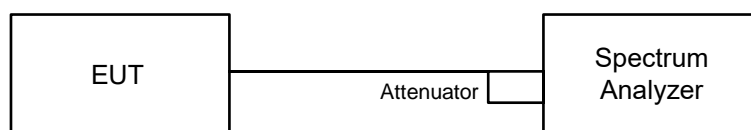

6.4.2 Test Procedure

MEASUREMENT PROCEDURE REF

- Set the RBW = 100 kHz.
- Set the VBW ≥ 300 kHz.
- Detector = peak.
- Sweep time = auto couple.
- Trace mode = max hold.
- Allow trace to fully stabilize.
- Use the peak marker function to determine the maximum power level in any 100 kHz band segment within the fundamental EBW.

MEASUREMENT PROCEDURE OOB

- Set RBW = 100 kHz.
- Set VBW ≥ 300 kHz.
- Detector = peak.
- Sweep = auto couple.
- Trace Mode = max hold.
- Allow trace to fully stabilize.
- Use the peak marker function to determine the maximum amplitude level.

6.5 AC Power Conducted Emissions

6.5.1 Test Setup

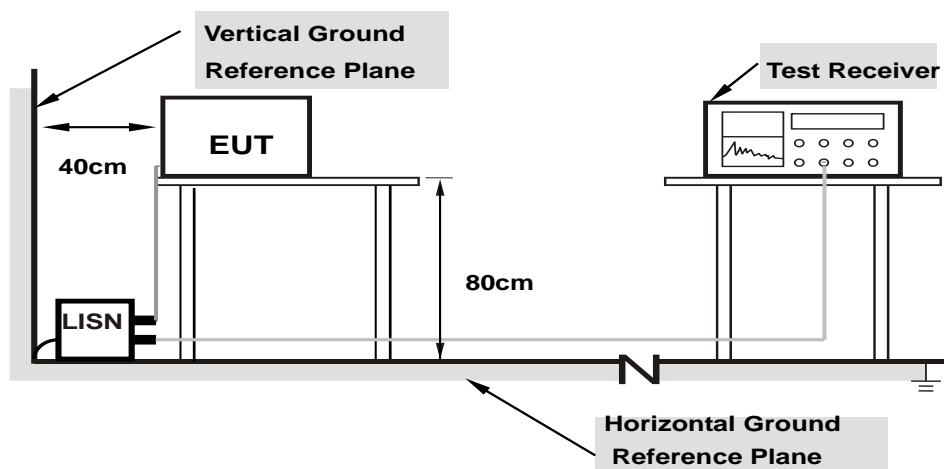

Note: 1.Support units were connected to second LISN.

For the actual test configuration, please refer to the attached file (Test Setup Photo).

6.5.2 Test Procedure

- The EUT was placed on a 0.8 meter to the top of table and placed 0.4 meters from the conducting wall of the shielded room with EUT being connected to the power mains through a line impedance stabilization network (LISN). Other support units were connected to the power mains through another LISN. The two LISNs provide 50 ohm/ 50 uH of coupling impedance for the measuring instrument.
- Both lines of the power mains connected to the EUT were checked for maximum conducted interference.
- The frequency range from 150 kHz to 30 MHz was searched. Emission levels under (Limit – 20 dB) was not recorded.

Note: The resolution bandwidth and video bandwidth of test receiver is 9 kHz for quasi-peak detection (QP) and average detection (AV) at frequency 0.15 MHz-30 MHz.

6.6 Unwanted Emissions below 1 GHz

6.6.1 Test Setup

For Radiated emission below 30 MHz

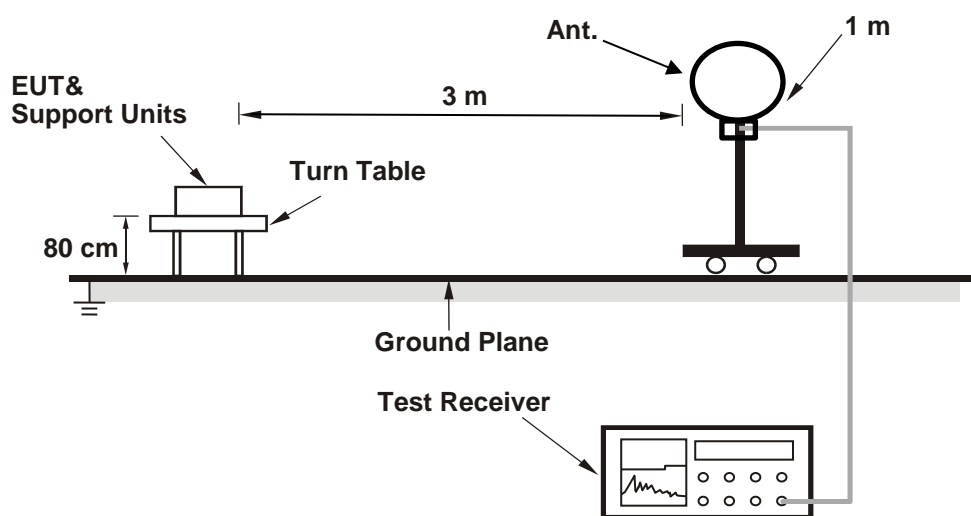

For Radiated emission above 30 MHz

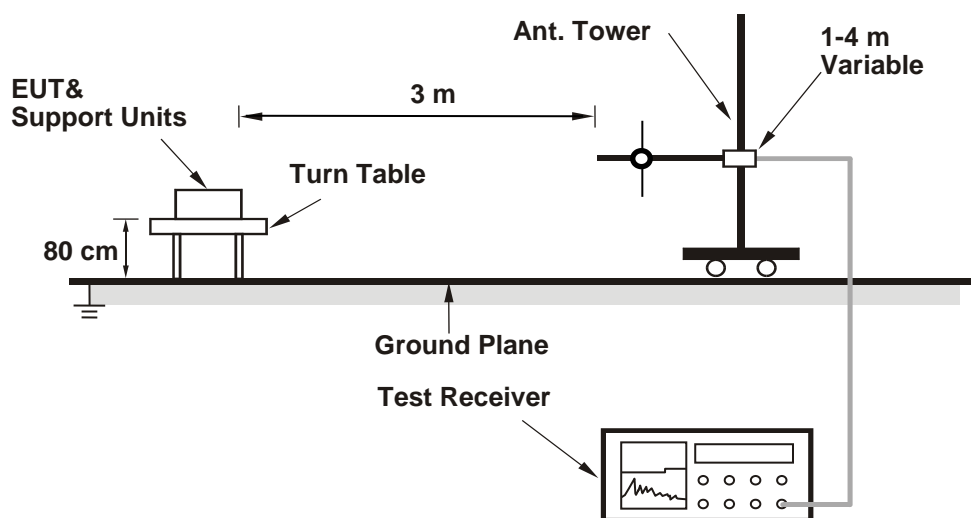

For the actual test configuration, please refer to the attached file (Test Setup Photo).

6.6.2 Test Procedure

For Radiated emission below 30 MHz

- a. The EUT was placed on the top of a rotating table 0.8 meters above the ground at 3 meter chamber room for test. The table was rotated 360 degrees to determine the position of the highest radiation.
- b. The EUT was set 3 meters away from the interference-receiving antenna, which was mounted on the top of a variable-height antenna tower.
- c. Parallel, perpendicular, and ground-parallel orientations of the antenna are set to make the measurement.
- d. For each suspected emission, the EUT was arranged to its worst case and the rotatable table was turned from 0 degrees to 360 degrees to find the maximum reading.
- e. The test-receiver system was set to Quasi-Peak Detect Function and Specified Bandwidth with Maximum Hold Mode, except for the frequency band (9 kHz to 90 kHz and 110 kHz to 490 kHz) set to average detect function and peak detect function.

Notes:

1. The resolution bandwidth and video bandwidth of test receiver/spectrum analyzer is 200 Hz at frequency below 150 kHz.
2. The resolution bandwidth and video bandwidth of test receiver/spectrum analyzer is 9 kHz or 10 kHz at frequency (150 kHz to 30 MHz).
3. All modes of operation were investigated and the worst-case emissions are reported.

For Radiated emission above 30 MHz

- a. The EUT was placed on the top of a rotating table 0.8 meters above the ground at 3 meter chamber room for test. The table was rotated 360 degrees to determine the position of the highest radiation.
- b. The EUT was set 3 meters away from the interference-receiving antenna, which was mounted on the top of a variable-height antenna tower.
- c. The height of antenna is varied from one meter to four meters above the ground to determine the maximum value of the field strength. Both horizontal and vertical polarizations of the antenna are set to make the measurement.
- d. For each suspected emission, the EUT was arranged to its worst case and then the antenna was tuned to heights from 1 meter to 4 meters and the rotatable table was turned from 0 degrees to 360 degrees to find the maximum reading.
- e. The test-receiver system was set to quasi-peak detect function and specified bandwidth with maximum hold mode when the test frequency is below 1 GHz.

Notes:

1. The resolution bandwidth and video bandwidth of test receiver/spectrum analyzer is 120 kHz for Quasi-peak detection (QP) at frequency below 1 GHz.
2. All modes of operation were investigated and the worst-case emissions are reported.

6.7 Unwanted Emissions above 1 GHz

6.7.1 Test Setup

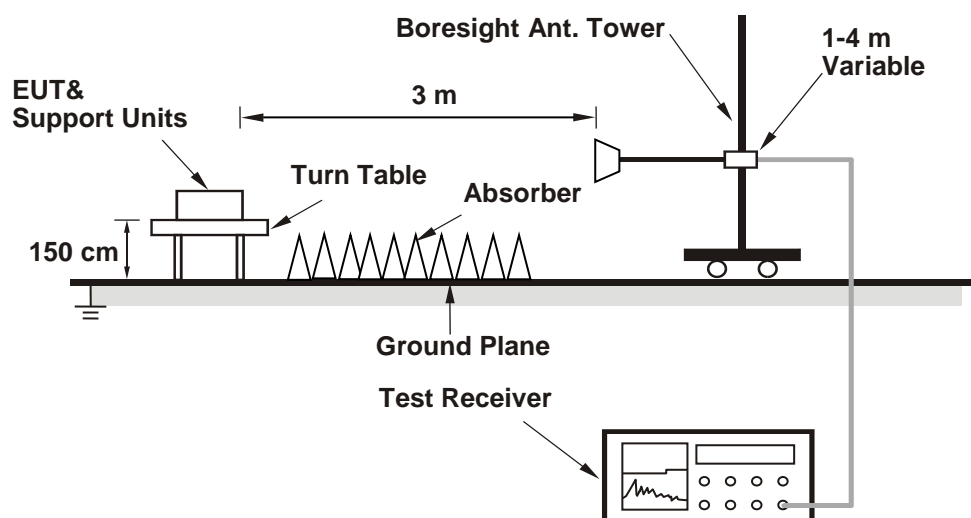

For the actual test configuration, please refer to the attached file (Test Setup Photo).

6.7.2 Test Procedure

- The EUT was placed on the top of a rotating table 1.5 meters above the ground at 3 meter chamber room for test. The table was rotated 360 degrees to determine the position of the highest radiation.
- The EUT was set 3 meters away from the interference-receiving antenna, which was mounted on the top of a variable-height antenna tower.
- The height of antenna is varied from one meter to four meters above the ground to determine the maximum value of the field strength. Both horizontal and vertical polarizations of the antenna are set to make the measurement.
- For each suspected emission, the EUT was arranged to its worst case and then the antenna was tuned to heights from 1 meter to 4 meters and the rotatable table was turned from 0 degrees to 360 degrees to find the maximum reading.
- The test-receiver system was set to peak and average detects function and specified bandwidth with maximum hold mode when the test frequency is above 1 GHz. If the peak reading value also meets average limit, measurement with the average detector is unnecessary.

Notes:

- The resolution bandwidth of test receiver/spectrum analyzer is 1 MHz and the video bandwidth is 3 MHz for Peak detection (PK) and Average detection (AV) at frequency above 1 GHz.
- For fundamental and harmonic signal measurement, according to KDB 558074 D01 15.247 Meas Guidance v05r02 section 8.1(c)(3). The spectrum analyzer settings meet the requirements of 11.12.2.4 in ANSI C63.10 for making a Peak measurement, the average value = Peak value + duty cycle correction factor. The duty cycle measurement refers to FCC 47 CFR Part 15C section 15.35 (c). For duty cycle correction factor values, see the Test Signal Duty Cycle section in this report.
- All modes of operation were investigated and the worst-case emissions are reported.

7 Test Results of Test Item

7.1 RF Output Power

Input Power:	3.8 Vdc	Environmental Conditions:	25°C, 60% RH	Tested By:	Kevin Ko
--------------	---------	---------------------------	--------------	------------	----------

For Peak Power

Chan.	Chan. Freq. (MHz)	Peak Power (mW)	Peak Power (dBm)	Power Limit (dBm)	Test Result
1	2403	2.793	4.46	30	Pass
40	2442	2.812	4.49	30	Pass
77	2479	2.844	4.54	30	Pass

Note: The antenna gain is 3.68 dBi < 6 dBi, so the output power limit shall not be reduced.

For Average Power

Chan.	Chan. Freq. (MHz)	Average Power (mW)	Average Power (dBm)
1	2403	2.773	4.43
40	2442	2.793	4.46
77	2479	2.831	4.52

7.2 Power Spectral Density

Input Power:	3.8 Vdc	Environmental Conditions:	25°C, 60% RH	Tested By:	Kevin Ko
--------------	---------	---------------------------	--------------	------------	----------

Chan.	Chan. Freq. (MHz)	PSD (dBm/3kHz)	PSD Limit (dBm/3kHz)	Test Result
1	2403	-3.33	8	Pass
40	2442	-3.16	8	Pass
77	2479	-2.68	8	Pass

Note: The antenna gain is 3.68 dBi < 6 dBi, so the power density limit shall not be reduced.

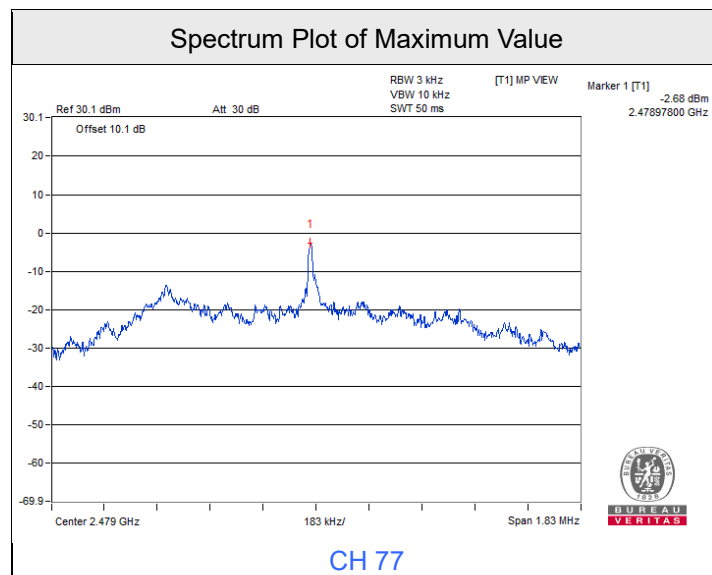

7.3 6 dB Bandwidth

Input Power:	3.8 Vdc	Environmental Conditions:	25°C, 60% RH	Tested By:	Kevin Ko
--------------	---------	---------------------------	--------------	------------	----------

Channel	Frequency (MHz)	6 dB Bandwidth (MHz)	Minimum Limit (MHz)	Test Result
1	2403	1.16	0.5	Pass
40	2442	1.18	0.5	Pass
77	2479	1.22	0.5	Pass

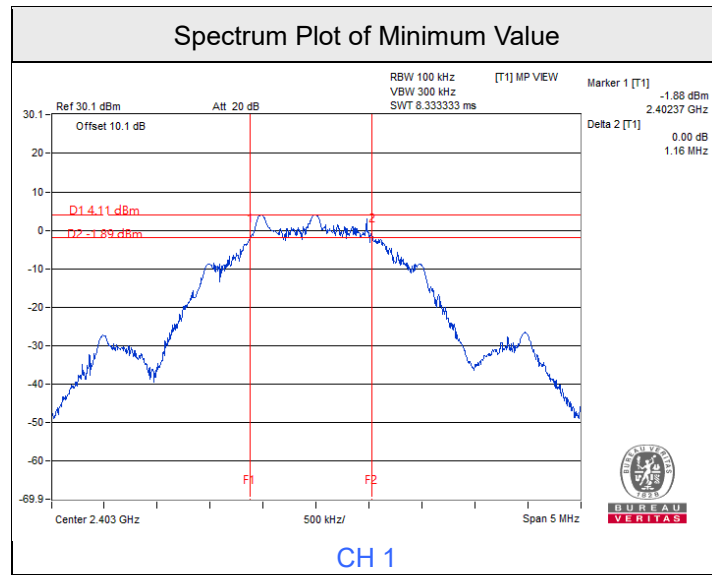



7.4 Conducted Out of Band Emissions

Input Power:	3.8 Vdc	Environmental Conditions:	25°C, 60% RH	Tested By:	Kevin Ko
--------------	---------	---------------------------	--------------	------------	----------

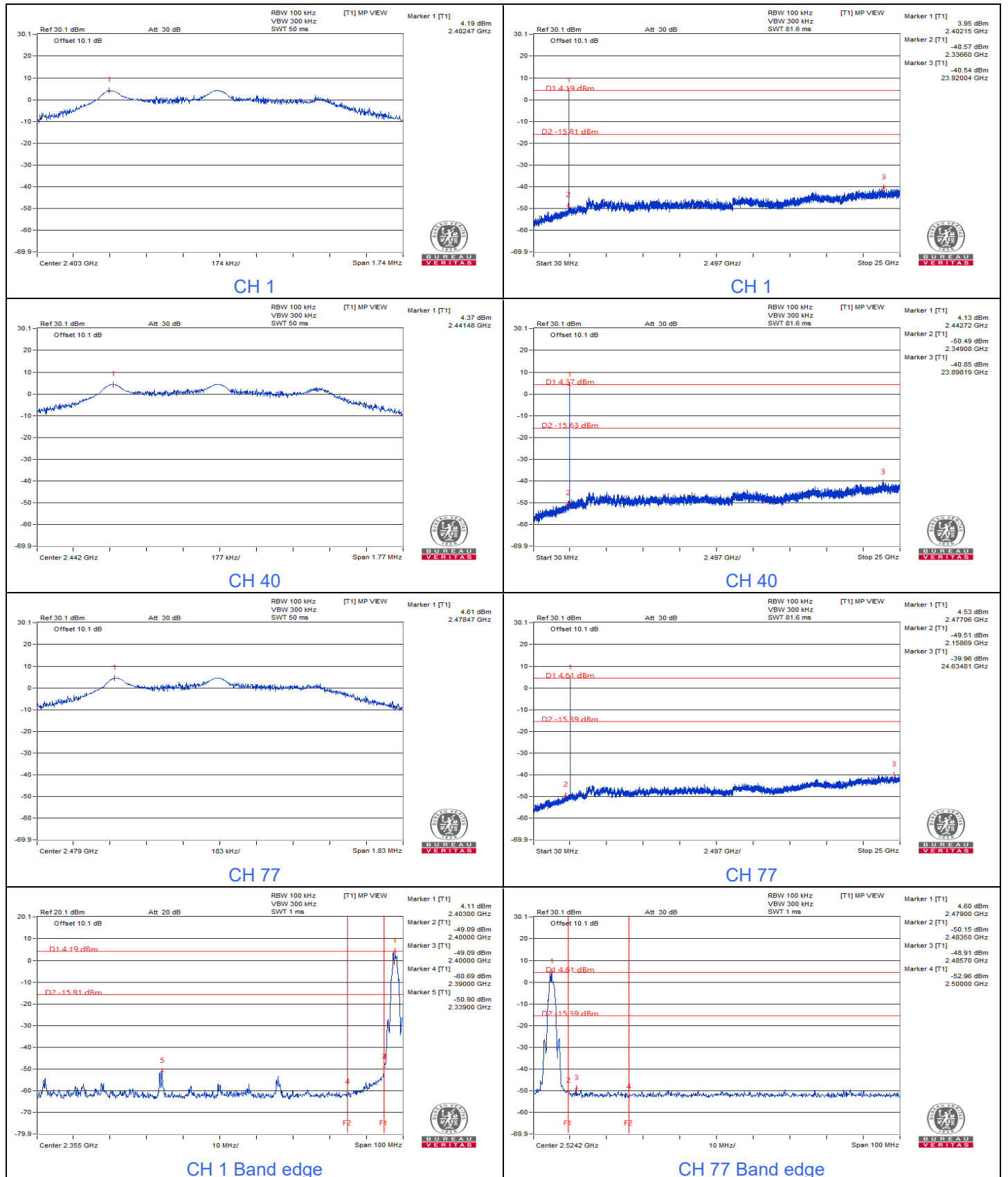

7.5 AC Power Conducted Emissions

RF Mode	GFSK	Channel	CH 77 : 2479 MHz
Frequency Range	150 kHz ~ 30 MHz	Detector Function & Resolution Bandwidth	Quasi-Peak (QP) / Average (AV), 9 kHz
Input Power (System)	120 Vac, 60 Hz	Environmental Conditions	23°C, 74% RH
Tested By	Sampson Chen		

Phase Of Power : Line (L)										
No	Frequency (MHz)	Correction Factor (dB)	Reading Value (dBuV)		Emission Level (dBuV)		Limit (dBuV)		Margin (dB)	
			Q.P.	AV.	Q.P.	AV.	Q.P.	AV.	Q.P.	AV.
1	0.15000	9.95	38.64	21.58	48.59	31.53	66.00	56.00	-17.41	-24.47
2	0.17734	9.94	37.84	24.42	47.78	34.36	64.61	54.61	-16.83	-20.25
3	0.57188	9.96	26.50	19.10	36.46	29.06	56.00	46.00	-19.54	-16.94
4	0.73984	9.97	16.47	9.27	26.44	19.24	56.00	46.00	-29.56	-26.76
5	12.38281	10.59	30.12	22.92	40.71	33.51	60.00	50.00	-19.29	-16.49
6	15.88672	10.77	26.42	21.19	37.19	31.96	60.00	50.00	-22.81	-18.04

Remarks:

1. Q.P. and AV. are abbreviations of quasi-peak and average individually.
2. The emission levels of other frequencies were very low against the limit.
3. Margin value = Emission level – Limit value
4. Correction factor = Insertion loss + Cable loss
5. Emission Level = Correction Factor + Reading Value

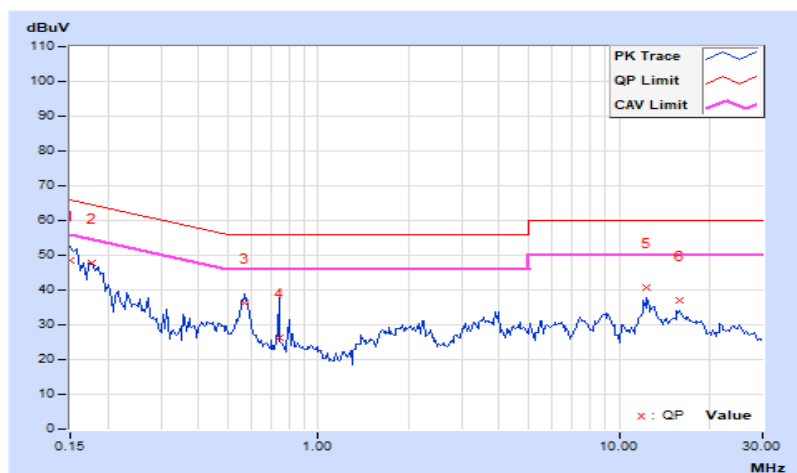

RF Mode	GFSK	Channel	CH 77 : 2479 MHz
Frequency Range	150 kHz ~ 30 MHz	Detector Function & Resolution Bandwidth	Quasi-Peak (QP) / Average (AV), 9 kHz
Input Power (System)	120 Vac, 60 Hz	Environmental Conditions	23°C, 74% RH
Tested By	Sampson Chen		

Phase Of Power : Neutral (N)										
No	Frequency (MHz)	Correction Factor (dB)	Reading Value (dBuV)		Emission Level (dBuV)		Limit (dBuV)		Margin (dB)	
			Q.P.	AV.	Q.P.	AV.	Q.P.	AV.	Q.P.	AV.
1	0.16172	9.99	34.96	14.09	44.95	24.08	65.38	55.38	-20.43	-31.30
2	0.17344	9.99	34.63	15.96	44.62	25.95	64.79	54.79	-20.17	-28.84
3	0.19297	9.99	31.48	12.43	41.47	22.42	63.91	53.91	-22.44	-31.49
4	0.56797	10.01	26.89	19.14	36.90	29.15	56.00	46.00	-19.10	-16.85
5	11.92188	10.51	26.62	19.34	37.13	29.85	60.00	50.00	-22.87	-20.15
6	20.69141	10.79	15.32	8.37	26.11	19.16	60.00	50.00	-33.89	-30.84

Remarks:

1. Q.P. and AV. are abbreviations of quasi-peak and average individually.
2. The emission levels of other frequencies were very low against the limit.
3. Margin value = Emission level – Limit value
4. Correction factor = Insertion loss + Cable loss
5. Emission Level = Correction Factor + Reading Value

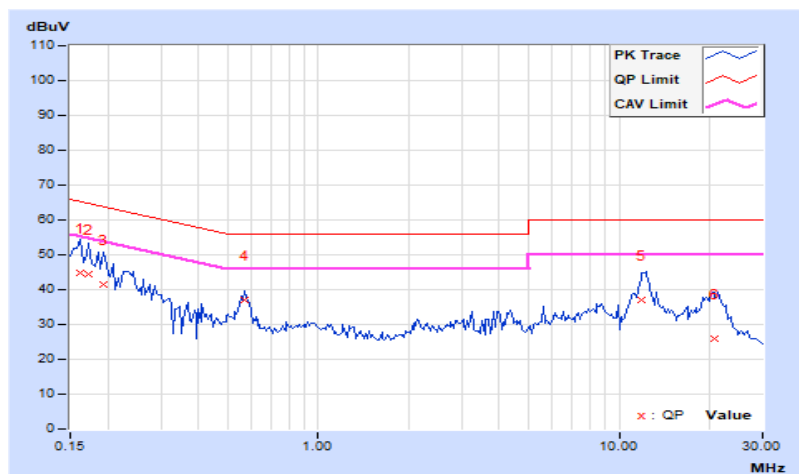

7.6 Unwanted Emissions below 1 GHz

RF Mode	GFSK	Channel	CH 77 : 2479 MHz
Frequency Range	30 MHz ~ 1 GHz	Detector Function & Bandwidth	QP: RB=120kHz, DET=Quasi-Peak
Input Power (System)	120 Vac, 60 Hz	Environmental Conditions	28°C, 75% RH
Tested By	Louis Yang		

Antenna Polarity & Test Distance : Horizontal at 3 m

No	Frequency (MHz)	Emission Level (dBuV/m)	Limit (dBuV/m)	Margin (dB)	Antenna Height (m)	Table Angle (Degree)	Raw Value (dBuV)	Correction Factor (dB/m)
1	48.85	15.2 QP	40.0	-24.8	2.00 H	151	28.9	-13.7
2	106.75	15.0 QP	43.5	-28.5	2.00 H	127	32.0	-17.0
3	162.54	16.6 QP	43.5	-26.9	1.50 H	285	29.8	-13.2
4	642.32	22.9 QP	46.0	-23.1	3.00 H	360	28.0	-5.1
5	877.65	26.1 QP	46.0	-19.9	1.50 H	10	28.1	-2.0
6	989.63	26.2 QP	54.0	-27.8	1.50 H	275	26.8	-0.6

Remarks:

1. Emission Level(dBuV/m) = Raw Value(dBuV) + Correction Factor(dB/m)
2. Correction Factor(dB/m) = Antenna Factor(dB/m) + Cable Factor(dB) – Pre-Amplifier Factor(dB)
3. Margin value = Emission Level – Limit value
4. The other emission levels were very low against the limit of frequency range 30 MHz ~ 1 GHz.
5. The frequency range 9 kHz ~ 30 MHz: all emissions are more than 20 dB below the limit, therefore do not be recorded in this report.

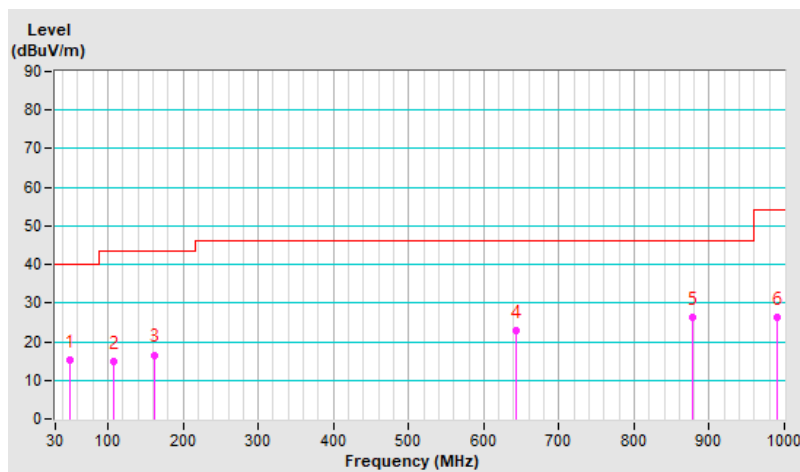

RF Mode	GFSK	Channel	CH 77 : 2479 MHz
Frequency Range	30 MHz ~ 1 GHz	Detector Function & Bandwidth	QP: RB=120kHz, DET=Quasi-Peak
Input Power (System)	120 Vac, 60 Hz	Environmental Conditions	28°C, 77% RH
Tested By	Louis Yang		

Antenna Polarity & Test Distance : Vertical at 3 m								
No	Frequency (MHz)	Emission Level (dBuV/m)	Limit (dBuV/m)	Margin (dB)	Antenna Height (m)	Table Angle (Degree)	Raw Value (dBuV)	Correction Factor (dB/m)
1	30.00	33.7 QP	40.0	-6.3	1.00 V	246	48.7	-15.0
2	51.68	30.7 QP	40.0	-9.3	1.00 V	298	44.4	-13.7
3	99.89	17.9 QP	43.5	-25.6	1.50 V	283	35.9	-18.0
4	153.05	17.2 QP	43.5	-26.3	1.50 V	360	30.2	-13.0
5	587.97	24.0 QP	46.0	-22.0	3.50 V	90	29.9	-5.9
6	972.69	28.8 QP	54.0	-25.2	3.00 V	138	29.4	-0.6

Remarks:

1. Emission Level(dBuV/m) = Raw Value(dBuV) + Correction Factor(dB/m)
2. Correction Factor(dB/m) = Antenna Factor(dB/m) + Cable Factor(dB) – Pre-Amplifier Factor(dB)
3. Margin value = Emission Level – Limit value
4. The other emission levels were very low against the limit of frequency range 30 MHz ~ 1 GHz.
5. The frequency range 9 kHz ~ 30 MHz: all emissions are more than 20 dB below the limit, therefore do not be recorded in this report.

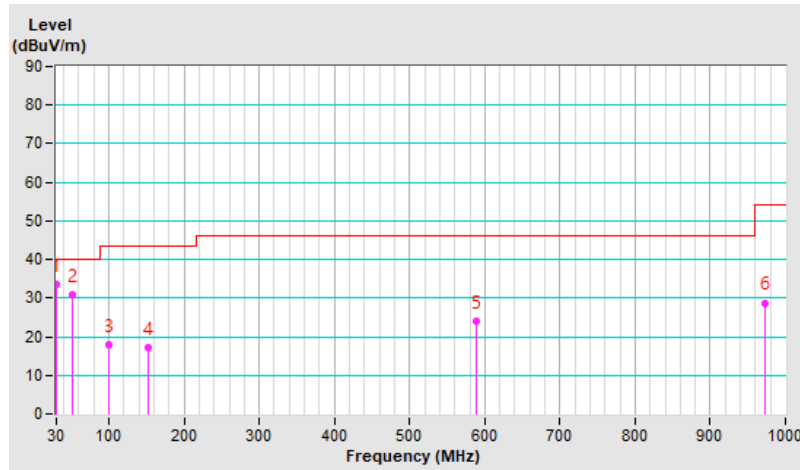

7.7 Unwanted Emissions above 1 GHz

RF Mode	GFSK	Channel	CH 1 : 2403 MHz
Frequency Range	1 GHz ~ 25 GHz	Detector Function & Bandwidth	PK: RB=1 MHz, VB=3 MHz, DET=Peak AV: RB=1 MHz, VB=3 MHz, DET=RMS
Input Power (System)	120 Vac, 60 Hz	Environmental Conditions	26°C, 75% RH
Tested By	Louis Yang		

Antenna Polarity & Test Distance : Horizontal at 3 m								
No	Frequency (MHz)	Emission Level (dBuV/m)	Limit (dBuV/m)	Margin (dB)	Antenna Height (m)	Table Angle (Degree)	Raw Value (dBuV)	Correction Factor (dB/m)
1	2390.00	55.7 PK	74.0	-18.3	1.95 H	324	58.5	-2.8
2	2390.00	45.6 AV	54.0	-8.4	1.95 H	324	48.4	-2.8
3	*2403.00	103.4 PK			1.95 H	324	106.2	-2.8
4	*2403.00	91.2 AV			1.95 H	324	94.0	-2.8
5	4806.00	35.0 PK	74.0	-39.0	1.28 H	98	33.0	2.0
6	4806.00	22.8 AV	54.0	-31.2	1.28 H	98	20.8	2.0

Remarks:

- Emission Level(dBuV/m) = Raw Value(dBuV) + Correction Factor(dB/m)
- Correction Factor(dB/m) = Antenna Factor(dB/m) + Cable Factor(dB) – Pre-Amplifier Factor(dB)
- Margin value = Emission Level – Limit value
- The other emission levels were very low against the limit.
- " * ": Fundamental frequency, the limit was restricted at the RF Output Power.
- The average value of fundamental and harmonic frequency is: Average = Peak value + 20 log(Duty cycle) Where the duty cycle correction factor is calculated from following formula:

$$20 \log(\text{Duty cycle}) = 20 \log(0.188 \text{ ms} / 0.763 \text{ ms}) = -12.2 \text{ dB}$$

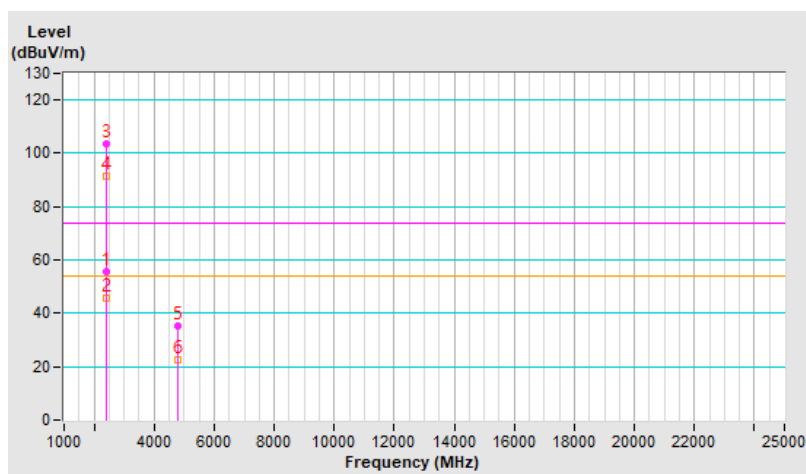

RF Mode	GFSK	Channel	CH 1 : 2403 MHz
Frequency Range	1 GHz ~ 25 GHz	Detector Function & Bandwidth	PK: RB=1 MHz, VB=3 MHz, DET=Peak AV: RB=1 MHz, VB=3 MHz, DET=RMS
Input Power (System)	120 Vac, 60 Hz	Environmental Conditions	26°C, 75% RH
Tested By	Louis Yang		

Antenna Polarity & Test Distance : Vertical at 3 m								
No	Frequency (MHz)	Emission Level (dBuV/m)	Limit (dBuV/m)	Margin (dB)	Antenna Height (m)	Table Angle (Degree)	Raw Value (dBuV)	Correction Factor (dB/m)
1	2390.00	54.9 PK	74.0	-19.1	3.01 V	246	57.7	-2.8
2	2390.00	45.6 AV	54.0	-8.4	3.01 V	246	48.4	-2.8
3	*2403.00	103.5 PK			3.01 V	246	106.3	-2.8
4	*2403.00	91.2 AV			3.01 V	246	94.0	-2.8
5	4806.00	35.7 PK	74.0	-38.3	1.52 V	253	33.7	2.0
6	4806.00	23.5 AV	54.0	-30.5	1.52 V	253	21.5	2.0

Remarks:

1. Emission Level(dBuV/m) = Raw Value(dBuV) + Correction Factor(dB/m)
2. Correction Factor(dB/m) = Antenna Factor(dB/m) + Cable Factor(dB) – Pre-Amplifier Factor(dB)
3. Margin value = Emission Level – Limit value
4. The other emission levels were very low against the limit.
5. " * ": Fundamental frequency, the limit was restricted at the RF Output Power.
6. The average value of fundamental and harmonic frequency is: Average = Peak value + 20 log(Duty cycle) Where the duty cycle correction factor is calculated from following formula:
 $20 \log(\text{Duty cycle}) = 20 \log(0.188 \text{ ms} / 0.763 \text{ ms}) = -12.2 \text{ dB}$

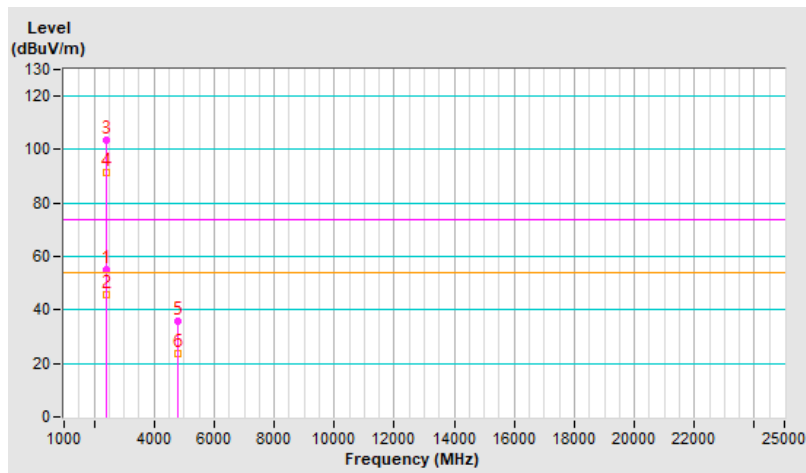

RF Mode	GFSK	Channel	CH 40 : 2442 MHz
Frequency Range	1 GHz ~ 25 GHz	Detector Function & Bandwidth	PK: RB=1 MHz, VB=3 MHz, DET=Peak AV: RB=1 MHz, VB=3 MHz, DET=RMS
Input Power (System)	120 Vac, 60 Hz	Environmental Conditions	26°C, 75% RH
Tested By	Louis Yang		

Antenna Polarity & Test Distance : Horizontal at 3 m								
No	Frequency (MHz)	Emission Level (dBuV/m)	Limit (dBuV/m)	Margin (dB)	Antenna Height (m)	Table Angle (Degree)	Raw Value (dBuV)	Correction Factor (dB/m)
1	*2442.00	102.4 PK			1.14 H	300	105.1	-2.7
2	*2442.00	90.2 AV			1.14 H	300	92.9	-2.7
3	4884.00	35.1 PK	74.0	-38.9	1.30 H	90	33.0	2.1
4	4884.00	22.9 AV	54.0	-31.1	1.30 H	90	20.8	2.1
5	7326.00	41.9 PK	74.0	-32.1	1.23 H	78	34.2	7.7
6	7326.00	29.7 AV	54.0	-24.3	1.23 H	78	22.0	7.7

Remarks:

1. Emission Level(dBuV/m) = Raw Value(dBuV) + Correction Factor(dB/m)
2. Correction Factor(dB/m) = Antenna Factor(dB/m) + Cable Factor(dB) – Pre-Amplifier Factor(dB)
3. Margin value = Emission Level – Limit value
4. The other emission levels were very low against the limit.
5. " * " : Fundamental frequency, the limit was restricted at the RF Output Power.
6. The average value of fundamental and harmonic frequency is: Average = Peak value + 20 log(Duty cycle) Where the duty cycle correction factor is calculated from following formula:
 $20 \log(\text{Duty cycle}) = 20 \log(0.188 \text{ ms} / 0.763 \text{ ms}) = -12.2 \text{ dB}$

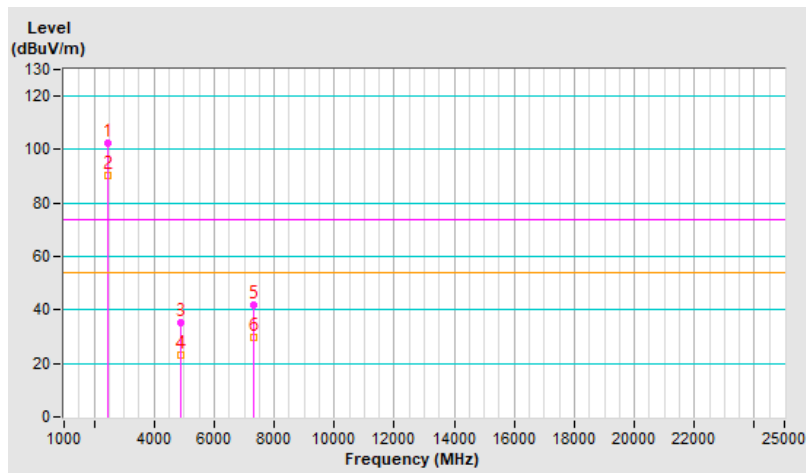

RF Mode	GFSK	Channel	CH 40 : 2442 MHz
Frequency Range	1 GHz ~ 25 GHz	Detector Function & Bandwidth	PK: RB=1 MHz, VB=3 MHz, DET=Peak AV: RB=1 MHz, VB=3 MHz, DET=RMS
Input Power (System)	120 Vac, 60 Hz	Environmental Conditions	26°C, 75% RH
Tested By	Louis Yang		

Antenna Polarity & Test Distance : Vertical at 3 m								
No	Frequency (MHz)	Emission Level (dBuV/m)	Limit (dBuV/m)	Margin (dB)	Antenna Height (m)	Table Angle (Degree)	Raw Value (dBuV)	Correction Factor (dB/m)
1	*2442.00	102.6 PK			3.29 V	251	105.3	-2.7
2	*2442.00	90.4 AV			3.29 V	251	93.1	-2.7
3	4884.00	35.5 PK	74.0	-38.5	1.40 V	254	33.4	2.1
4	4884.00	23.3 AV	54.0	-30.7	1.40 V	254	21.2	2.1
5	7326.00	39.0 PK	74.0	-35.0	1.26 V	258	31.3	7.7
6	7326.00	26.8 AV	54.0	-27.2	1.26 V	258	19.1	7.7

Remarks:

1. Emission Level(dBuV/m) = Raw Value(dBuV) + Correction Factor(dB/m)
2. Correction Factor(dB/m) = Antenna Factor(dB/m) + Cable Factor(dB) – Pre-Amplifier Factor(dB)
3. Margin value = Emission Level – Limit value
4. The other emission levels were very low against the limit.
5. " * " : Fundamental frequency, the limit was restricted at the RF Output Power.
6. The average value of fundamental and harmonic frequency is: Average = Peak value + 20 log(Duty cycle) Where the duty cycle correction factor is calculated from following formula:
 $20 \log(\text{Duty cycle}) = 20 \log(0.188 \text{ ms} / 0.763 \text{ ms}) = -12.2 \text{ dB}$

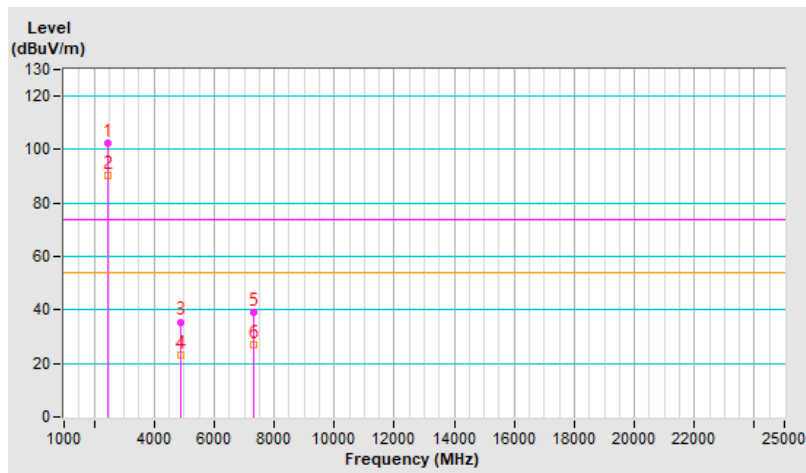

RF Mode	GFSK	Channel	CH 77 : 2479 MHz
Frequency Range	1 GHz ~ 25 GHz	Detector Function & Bandwidth	PK: RB=1 MHz, VB=3 MHz, DET=Peak AV: RB=1 MHz, VB=3 MHz, DET=RMS
Input Power (System)	120 Vac, 60 Hz	Environmental Conditions	26°C, 75% RH
Tested By	Louis Yang		

Antenna Polarity & Test Distance : Horizontal at 3 m								
No	Frequency (MHz)	Emission Level (dBUV/m)	Limit (dBUV/m)	Margin (dB)	Antenna Height (m)	Table Angle (Degree)	Raw Value (dBUV)	Correction Factor (dB/m)
1	2350.40	58.9 PK	74.0	-15.1	1.11 H	298	61.6	-2.7
2	2350.40	45.8 AV	54.0	-8.2	1.11 H	298	48.5	-2.7
3	*2479.00	101.5 PK			1.11 H	298	104.1	-2.6
4	*2479.00	89.3 AV			1.11 H	298	91.9	-2.6
5	4958.00	35.2 PK	74.0	-38.8	1.31 H	87	33.0	2.2
6	4958.00	23.0 AV	54.0	-31.0	1.31 H	87	20.8	2.2
7	7437.00	39.1 PK	74.0	-34.9	1.21 H	65	31.3	7.8
8	7437.00	26.9 AV	54.0	-27.1	1.21 H	65	19.1	7.8

Remarks:

1. Emission Level(dBUV/m) = Raw Value(dBuV) + Correction Factor(dB/m)
2. Correction Factor(dB/m) = Antenna Factor(dB/m) + Cable Factor(dB) – Pre-Amplifier Factor(dB)
3. Margin value = Emission Level – Limit value
4. The other emission levels were very low against the limit.
5. " * ": Fundamental frequency, the limit was restricted at the RF Output Power.
6. The average value of fundamental and harmonic frequency is: Average = Peak value + 20 log(Duty cycle) Where the duty cycle correction factor is calculated from following formula:
 $20 \log(\text{Duty cycle}) = 20 \log(0.188 \text{ ms} / 0.763 \text{ ms}) = -12.2 \text{ dB}$

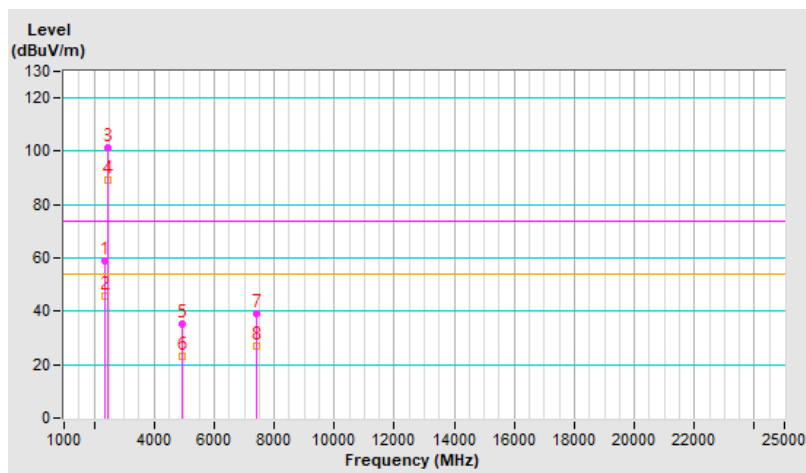

RF Mode	GFSK	Channel	CH 77 : 2479 MHz
Frequency Range	1 GHz ~ 25 GHz	Detector Function & Bandwidth	PK: RB=1 MHz, VB=3 MHz, DET=Peak AV: RB=1 MHz, VB=3 MHz, DET=RMS
Input Power (System)	120 Vac, 60 Hz	Environmental Conditions	26°C, 75% RH
Tested By	Louis Yang		

Antenna Polarity & Test Distance : Vertical at 3 m								
No	Frequency (MHz)	Emission Level (dBuV/m)	Limit (dBuV/m)	Margin (dB)	Antenna Height (m)	Table Angle (Degree)	Raw Value (dBuV)	Correction Factor (dB/m)
1	2351.17	59.4 PK	74.0	-14.6	3.17 V	245	62.1	-2.7
2	2351.17	46.0 AV	54.0	-8.0	3.17 V	245	48.7	-2.7
3	*2479.00	101.1 PK			3.17 V	245	103.7	-2.6
4	*2479.00	88.9 AV			3.17 V	245	91.5	-2.6
5	4958.00	35.2 PK	74.0	-38.8	1.36 V	259	33.0	2.2
6	4958.00	23.0 AV	54.0	-31.0	1.36 V	259	20.8	2.2
7	7437.00	39.7 PK	74.0	-34.3	1.21 V	247	31.9	7.8
8	7437.00	27.5 AV	54.0	-26.5	1.21 V	247	19.7	7.8

Remarks:

1. Emission Level(dBuV/m) = Raw Value(dBuV) + Correction Factor(dB/m)
2. Correction Factor(dB/m) = Antenna Factor(dB/m) + Cable Factor(dB) – Pre-Amplifier Factor(dB)
3. Margin value = Emission Level – Limit value
4. The other emission levels were very low against the limit.
5. " * ": Fundamental frequency, the limit was restricted at the RF Output Power.
6. The average value of fundamental and harmonic frequency is: Average = Peak value + 20 log(Duty cycle) Where the duty cycle correction factor is calculated from following formula:
 $20 \log(\text{Duty cycle}) = 20 \log(0.188 \text{ ms} / 0.763 \text{ ms}) = -12.2 \text{ dB}$

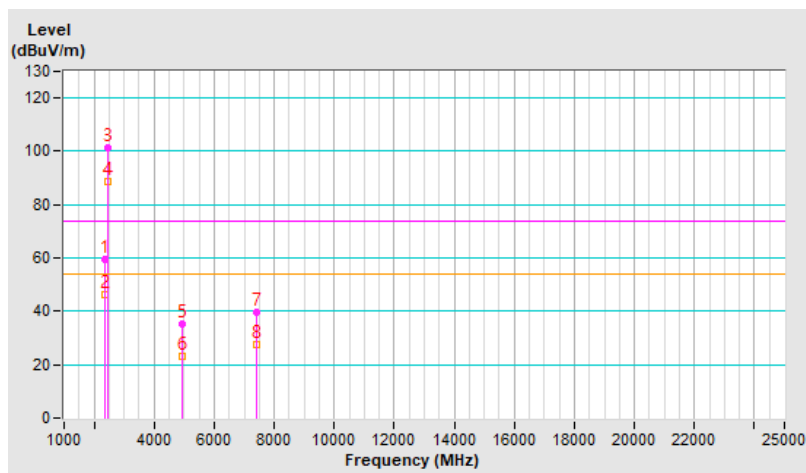

Plot of Band Edge

Frequency Range	2.31 GHz ~ 2.5 GHz	Detector Function & Bandwidth	PK: RB=1 MHz, VB=3 MHz, DET=Peak AV: RB=1 MHz, VB=3 MHz, DET=RMS
-----------------	--------------------	-------------------------------	---

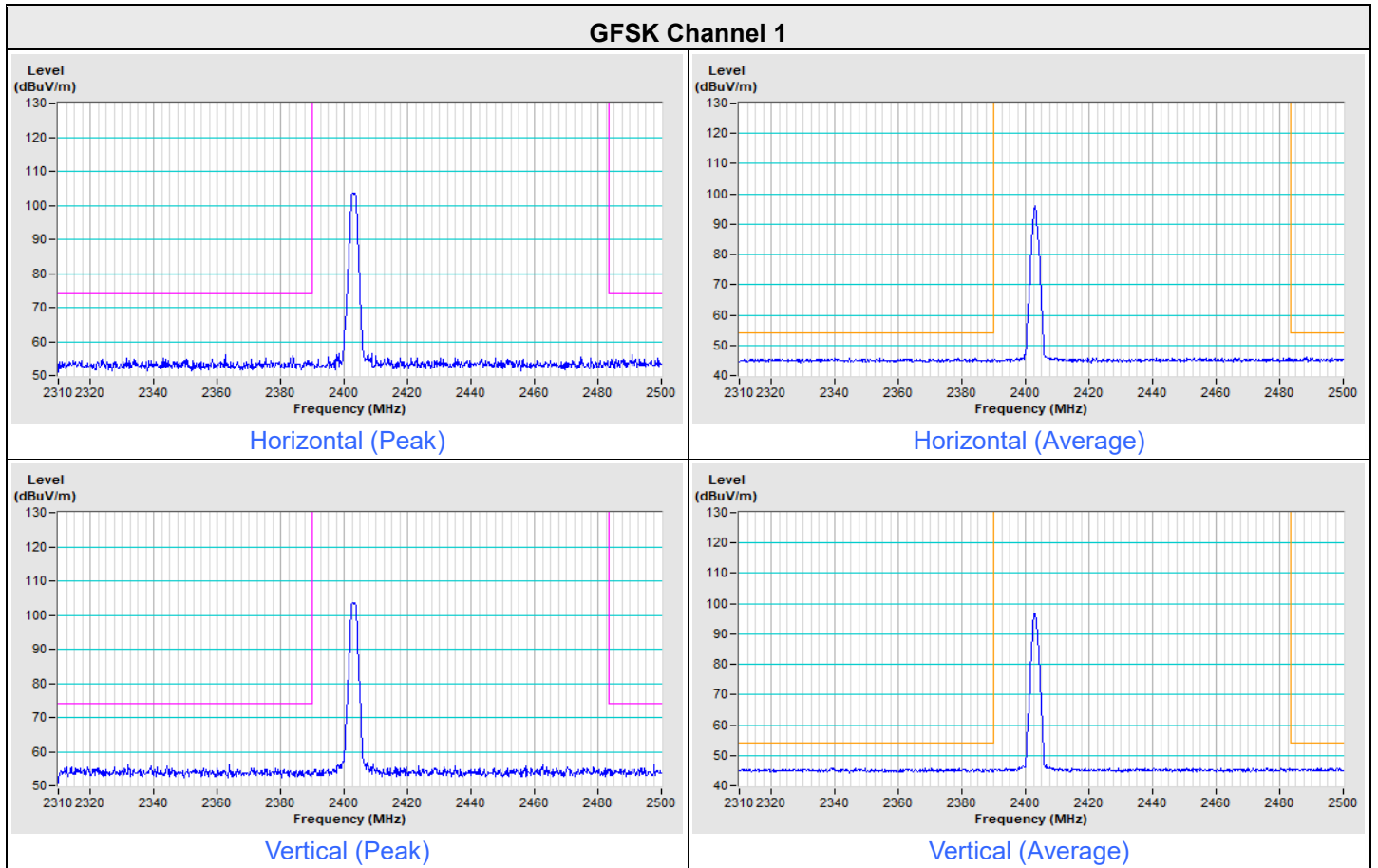

GFSK Channel 77

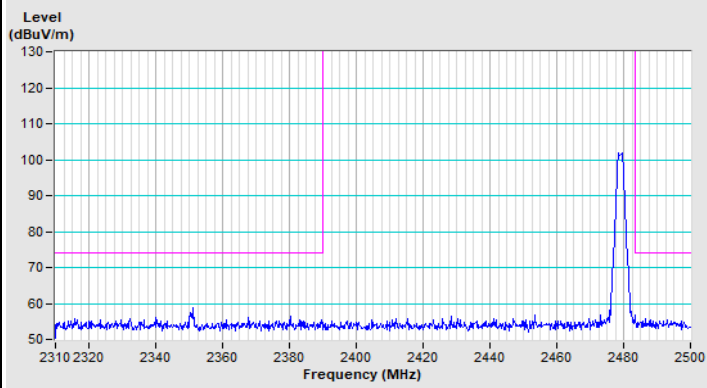

Horizontal (Peak)

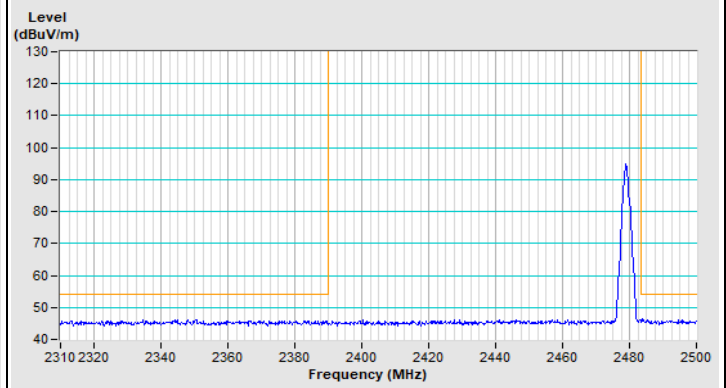

Horizontal (Average)

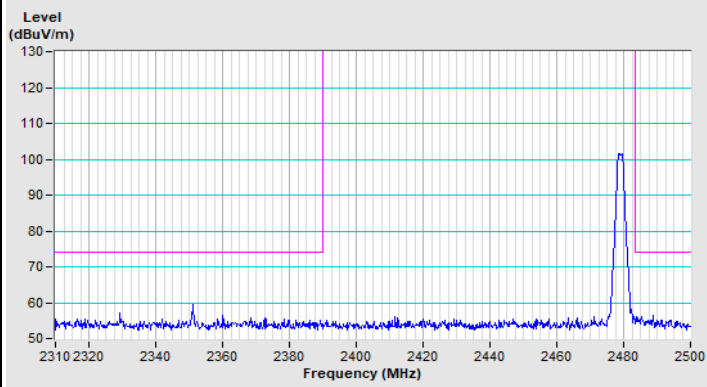

Vertical (Peak)

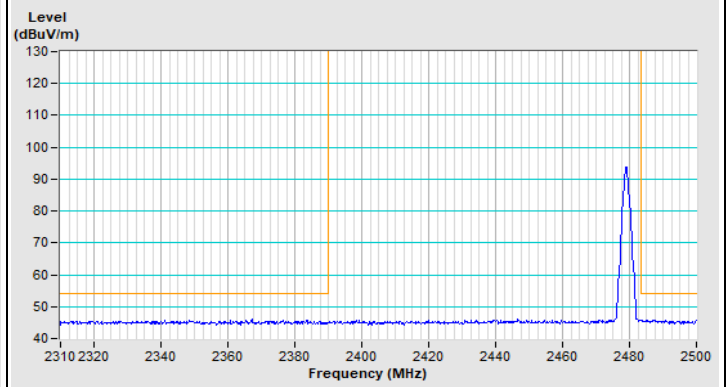

Vertical (Average)

8 Pictures of Test Arrangements

Please refer to the attached file (Test Setup Photo)

9 Information of the Testing Laboratories

We, Bureau Veritas Consumer Products Services (H.K.) Ltd., Taoyuan Branch, were founded in 1988 to provide our best service in EMC, Radio, Telecom and Safety consultation. Our laboratories are FCC recognized accredited test firms and accredited according to ISO/IEC 17025.

If you have any comments, please feel free to contact us at the following:

Lin Kou EMC/RF Lab

Tel: 886-2-26052180

Fax: 886-2-26051924

Hsin Chu EMC/RF/Telecom Lab

Tel: 886-3-6668565

Fax: 886-3-6668323

Hwa Ya EMC/RF/Safety Lab

Tel: 886-3-3183232

Fax: 886-3-3270892

Email: service.adt@bureauveritas.com

Web Site: <http://ee.bureauveritas.com.tw>

The address and road map of all our labs can be found in our web site also.

--- END ---