

TEST REPORT

CERTIFICATE OF CONFORMITY

Standard: 47 CFR FCC Part 15, Subpart C (Section 15.247)
Report No.: RFBDKG-WTW-P23070157
FCC ID: JNZYR0090
Product: Wireless Keyboard
Brand: logitech G, G
Model No.: YR0090
Received Date: 2023/7/12
Test Date: 2023/7/17 ~ 2023/7/27
Issued Date: 2023/8/14

Applicant: Logitech Far East Ltd.
Address: 3930 North First Street, San Jose, California 95134
Issued By: Bureau Veritas Consumer Products Services (H.K.) Ltd., Taoyuan Branch
Hsin Chu Laboratory
Lab Address: E-2, No.1, Li Hsin 1st Road, Hsinchu Science Park, Hsinchu City 300, Taiwan
Test Location: E-2, No.1, Li Hsin 1st Road, Hsinchu Science Park, Hsinchu City 300, Taiwan
FCC Registration / 723255 / TW2022
Designation Number:

Approved by: _____

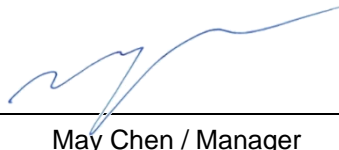

May Chen / Manager

, Date: _____

2023/8/14

This test report consists of 72 pages in total. It may be duplicated completely for legal use with the approval of the applicant. It should not be reproduced except in full, without the written approval of our laboratory. The test results in the report only apply to the tested sample. The test results in this report are traceable to the national or international standards.



Prepared by : Claire Kuan / Specialist

This report is governed by, and incorporates by reference, the Conditions of Testing as posted at the date of issuance of this report at <http://www.bureauveritas.com/home/about-us/our-business/cps/about-us/terms-conditions/> and is intended for your exclusive use. Any copying or replication of this report to or for any other person or entity, or use of our name or trademark, is permitted only with our prior written permission. This report sets forth our findings solely with respect to the test samples identified herein. The results set forth in this report are not indicative or representative of the quality or characteristics of the lot from which a test sample was taken or any similar or identical product unless specifically and expressly noted. Our report includes all of the tests requested by you and the results thereof based upon the information that you provided to us. Measurement uncertainty is only provided upon request for accredited tests. Statements of conformity are based on simple acceptance criteria without taking measurement uncertainty into account, unless otherwise requested in writing. You have 60 days from date of issuance of this report to notify us of any material error or omission caused by our negligence or if you require measurement uncertainty; provided, however, that such notice shall be in writing and shall specifically address the issue you wish to raise. A failure to raise such issue within the prescribed time shall constitute your unqualified acceptance of the completeness of this report, the tests conducted and the correctness of the report contents.

Table of Contents

Release Control Record	4
1 Certificate	5
2 Summary of Test Results	6
2.1 Measurement Uncertainty	6
2.2 Supplementary Information	6
3 General Information	7
3.1 General Description	7
3.2 Antenna Description of EUT	8
3.3 Channel List	9
3.4 Test Mode Applicability and Tested Channel Detail	10
3.5 Duty Cycle of Test Signal	11
3.6 Test Program Used and Operation Descriptions	13
3.7 Connection Diagram of EUT and Peripheral Devices	13
3.8 Configuration of Peripheral Devices and Cable Connections	13
4 Test Instruments	14
4.1 RF Output Power	14
4.2 Power Spectral Density	14
4.3 6 dB Bandwidth	14
4.4 Conducted Out of Band Emissions	14
4.5 AC Power Conducted Emissions	15
4.6 Unwanted Emissions below 1 GHz	16
4.7 Unwanted Emissions above 1 GHz	17
5 Limits of Test Items	18
5.1 RF Output Power	18
5.2 Power Spectral Density	18
5.3 6 dB Bandwidth	18
5.4 Conducted Out of Band Emissions	18
5.5 AC Power Conducted Emissions	18
5.6 Unwanted Emissions below 1 GHz	18
5.7 Unwanted Emissions above 1 GHz	19
6 Test Arrangements	20
6.1 RF Output Power	20
6.1.1 Test Setup	20
6.1.2 Test Procedure	20
6.2 Power Spectral Density	20
6.2.1 Test Setup	20
6.2.2 Test Procedure	20
6.3 6 dB Bandwidth	21
6.3.1 Test Setup	21
6.3.2 Test Procedure	21
6.4 Conducted Out of Band Emissions	21
6.4.1 Test Setup	21
6.4.2 Test Procedure	21
6.5 AC Power Conducted Emissions	22
6.5.1 Test Setup	22
6.5.2 Test Procedure	22
6.6 Unwanted Emissions below 1 GHz	23
6.6.1 Test Setup	23
6.6.2 Test Procedure	24
6.7 Unwanted Emissions above 1 GHz	25
6.7.1 Test Setup	25
6.7.2 Test Procedure	25
7 Test Results of Test Item	26



7.1	RF Output Power.....	26
7.2	Power Spectral Density.....	27
7.3	6 dB Bandwidth.....	28
7.4	Conducted Out of Band Emissions.....	29
7.5	AC Power Conducted Emissions.....	31
7.6	Unwanted Emissions below 1 GHz.....	35
7.7	Unwanted Emissions above 1 GHz.....	39
8	Pictures of Test Arrangements.....	71
9	Information of the Testing Laboratories.....	72



Release Control Record

Issue No.	Description	Date Issued
RFBDKG-WTW-P23070157	Original release.	2023/8/14

1 Certificate

Product: Wireless Keyboard

Brand: logitech G, G

Test Model: YR0090

Sample Status: Engineering sample

Applicant: Logitech Far East Ltd.

Test Date: 2023/7/17 ~ 2023/7/27

Standard: 47 CFR FCC Part 15, Subpart C (Section 15.247)

Measurement ANSI C63.10-2013

procedure: KDB 558074 D01 15.247 Meas Guidance v05r02

The above equipment has been tested by **Bureau Veritas Consumer Products Services (H.K.) Ltd., Taoyuan Branch**, and found compliance with the requirement of the above standards. The test record, data evaluation & Equipment Under Test (EUT) configurations represented herein are true and accurate accounts of the measurements of the sample's RF characteristics under the conditions specified in this report.

2 Summary of Test Results

47 CFR FCC Part 15, Subpart C (Section 15.247)			
Standard / Clause	Test Item	Result	Remark
15.247(b)	RF Output Power	Pass	Meet the requirement of limit.
15.247(e)	Power Spectral Density	Pass	Meet the requirement of limit.
15.247(a)(2)	6 dB Bandwidth	Pass	Meet the requirement of limit.
15.247(d)	Conducted Out of Band Emissions	Pass	Meet the requirement of limit.
15.207	AC Power Conducted Emissions	Pass	Minimum passing margin is -7.68 dB at 0.55625 MHz
15.205 / 15.209 / 15.247(d)	Unwanted Emissions below 1 GHz	Pass	Minimum passing margin is -4.8 dB at 41.69 MHz
15.205 / 15.209 / 15.247(d)	Unwanted Emissions above 1 GHz	Pass	Minimum passing margin is -8.1 dB at 2483.50 MHz
15.203	Antenna Requirement	Pass	No antenna connector is used.

Note: Determining compliance based on the results of the compliance measurement, not taking into account measurement instrumentation uncertainty.

2.1 Measurement Uncertainty

Where relevant, the following measurement uncertainty levels have been estimated for tests performed on the EUT as specified in CISPR 16-4-2:

Parameter	Specification	Expanded Uncertainty (k=2) (±)
Conducted Out of Band Emissions	9 kHz ~ 40 GHz	2.5 dB
AC Power Conducted Emissions	150 kHz ~ 30 MHz	1.9 dB
Unwanted Emissions below 1 GHz	9 kHz ~ 30 MHz	3.1 dB
	30 MHz ~ 1 GHz	5.1 dB
Unwanted Emissions above 1 GHz	1 GHz ~ 18 GHz	5.1 dB
	18 GHz ~ 40 GHz	5.3 dB

The other instruments specified are routine verified to remain within the calibrated levels, no measurement uncertainty is required to be calculated.

2.2 Supplementary Information

There is not any deviation from the test standards for the test method, and no modifications required for compliance.

3 General Information

3.1 General Description

Product	Wireless Keyboard
Brand	logitech G, G
Test Model	YR0090
Status of EUT	Engineering sample
Power Supply Rating	3.7 Vdc from battery or 5 Vdc from USB interface
Modulation Type	GFSK
Modulation Technology	DTS
Transfer Rate	Up to 2 Mbps (*Note 1)
Operating Frequency	2.402 GHz ~ 2.48 GHz (*Note 1)
Number of Channel	40 (*Note 1)
Output Power	BT-LE 1M: 3.784 mW (5.78 dBm) BT-LE 2M: 3.758 mW (5.75 dBm)
Accessory	Refer to Note

Note:

1. BT-LE technique supports 1Mbps and 2Mbps data rates, both have been evaluated in this test report. Refer to "section 3.3 Channel List" for more detail specification.
2. The EUT may have a lot of colors for marketing requirement.
3. The EUT of LIGHTSPEED and Bluetooth technology can't transmit simultaneously, which uses timely shared coexistence technology.
4. The EUT could be supplied with a rechargeable battery as the following table:

Wireless USB dongle		
Brand	Model	
Logitech	CU0021	
Extender		
Brand	Model	
logitech G, G	502-001365	
USB-A to USB-C cable		
Brand	Model	Specification
logitech G, G	502-001478	shielded with 1 core, 1.8 m
Battery (main source)		
Brand	Model	Specification
Springpower	325085 or 533-000204	Power Rating : 3.7 Vdc, 5.55 Wh, 1500 mAh

5. The EUT may have the 2nd source for below components:

Components list	Components Location	Remark
coax. cable	the cable that connects MB and ANT PCB	Same spec, only vendors are different
I-PEX connector	MB	Same spec, only vendors are different
FFC connector	CN1 (MB), CN1 (SWB)	Same spec, only vendors are different
crystal	XT1 (MB)	Same spec, only vendors are different
ESD diode	(MB) D5,D7,D8,D9,D10,D11,D12,D13,D14,D15,D16,D17,D18,D19,D20,D21,D22, Z5, Z6 (SWB) D1,D2,D3,D4,D5,D6,D7,D8,D9,D10,D11,D12,D13,D16, D17,Z5, Z6	Same spec, only vendors are different
charging IC	U2	Same spec, only vendors are different
Power MoS/PCB	Q1, Q2	Same spec, only vendors are different
PCB	-	Same spec, only vendors are different
Battery	-	Brand: SYNERGY Model: AHB355085PCT-03 or 533-000210 Power Rating : 3.7 Vdc, 5.6Wh, 1500mAh



6. The above EUT information is declared by manufacturer and for more detailed features description, please refer to the manufacturer's specifications or User's Manual.

3.2 Antenna Description of EUT

1. The antenna information is listed as below.

Antenna Gain (dBi)	Frequency range (GHz)	Antenna Type	Connector Type
2.55	2.4~2.4835	PIFA	none

* Detail antenna specification please refer to antenna datasheet and/or antenna measurement report.



3.3 Channel List

BT-LE channels:

RF Channel	RF Center Frequency	Channel Index	Channels Type for BT 5.x		Channels Type for BT 4.x
			Maximum Data Rate 2Mbps	Maximum Data Rate 1Mbps	Maximum Data Rate 1Mbps
0	2402 MHz	37		●	●
1	2404 MHz	0	●		●
2	2406 MHz	1	●		●
3	2408 MHz	2	●		●
4	2410 MHz	3	●		●
5	2412 MHz	4	●		●
6	2414 MHz	5	●		●
7	2416 MHz	6	●		●
8	2418 MHz	7	●		●
9	2420 MHz	8	●		●
10	2422 MHz	9	●		●
11	2424 MHz	10	●		●
12	2426 MHz	38		●	●
13	2428 MHz	11	●		●
14	2430 MHz	12	●		●
15	2432 MHz	13	●		●
16	2434 MHz	14	●		●
17	2436 MHz	15	●		●
18	2438 MHz	16	●		●
19	2440 MHz	17	●		●
20	2442 MHz	18	●		●
21	2444 MHz	19	●		●
22	2446 MHz	20	●		●
23	2448 MHz	21	●		●
24	2450 MHz	22	●		●
25	2452 MHz	23	●		●
26	2454 MHz	24	●		●
27	2456 MHz	25	●		●
28	2458 MHz	26	●		●
29	2460 MHz	27	●		●
30	2462 MHz	28	●		●
31	2464 MHz	29	●		●
32	2466 MHz	30	●		●
33	2468 MHz	31	●		●
34	2470 MHz	32	●		●
35	2472 MHz	33	●		●
36	2474 MHz	34	●		●
37	2476 MHz	35	●		●
38	2478 MHz	36	●		●
39	2480 MHz	39		●	●

3.4 Test Mode Applicability and Tested Channel Detail

Pre-Scan:	<p>1. For Unwanted Emission (below 1GHz) items: Battery/ AC Adapter. Pre-scan these modes and find the worst case as a representative test condition.</p> <p>2. For AC power conducted emission items: AC Adapter/ Laptop. Only these modes as a representative test condition.</p> <p>3. EUT has the following samples: Main source / 2nd source. Pre-scan these samples of EUT and find the worst case as a representative test condition(except Unwanted emission and AC conduction test items)</p> <p>4. Pre-Scan has been conducted to determine the worst-case mode from all possible combinations between available modulations, data rates and antenna ports (if EUT with antenna diversity architecture).</p>
Worst Case:	<p>1. Unwanted Emission (below 1GHz) worst condition:AC Adapter</p> <p>2. AC power conducted emission worst condition:AC Adapter</p> <p>3. The sample of EUT worst condition: Main source</p>

Following channel(s) was (were) selected for the final test as listed below:

Test Item	EUT Configure Mode	Mode	Tested Channel	Modulation	Data Rate Parameter
RF Output Power / Power Spectral Density	A	BT-LE 1M	0, 19, 39	GFSK	1Mb/s
		BT-LE 2M	1, 19, 38	GFSK	2Mb/s
6 dB Bandwidth / Conducted Out of Band Emissions	A	BT-LE 1M	0, 19, 39	GFSK	1Mb/s
		BT-LE 2M	1, 19, 38	GFSK	2Mb/s
AC Power Conducted Emissions	A	BT-LE 1M	39	GFSK	1Mb/s
	B	BT-LE 1M	39	GFSK	1Mb/s
Unwanted Emissions below 1 GHz	A	BT-LE 1M	39	GFSK	1Mb/s
	B	BT-LE 1M	39	GFSK	1Mb/s
Unwanted Emissions above 1 GHz	A	BT-LE 1M	0, 19, 39	GFSK	1Mb/s
		BT-LE 2M	1, 19, 38	GFSK	2Mb/s
	B	BT-LE 1M	0, 19, 39	GFSK	1Mb/s
		BT-LE 2M	1, 19, 38	GFSK	2Mb/s
EUT Configure Mode:	A	Main source			
	B	2nd source			

3.5 Duty Cycle of Test Signal

Mode A

BT-LE 1M: Duty cycle = 0.362 ms / 6.84 ms x 100% = 5.3%, duty factor = $10 * \log (1/\text{Duty cycle}) = 12.76 \text{ dB}$

BT-LE 2M: Duty cycle = 0.187 ms / 6.84 ms x 100% = 2.7%, duty factor = $10 * \log (1/\text{Duty cycle}) = 15.63 \text{ dB}$

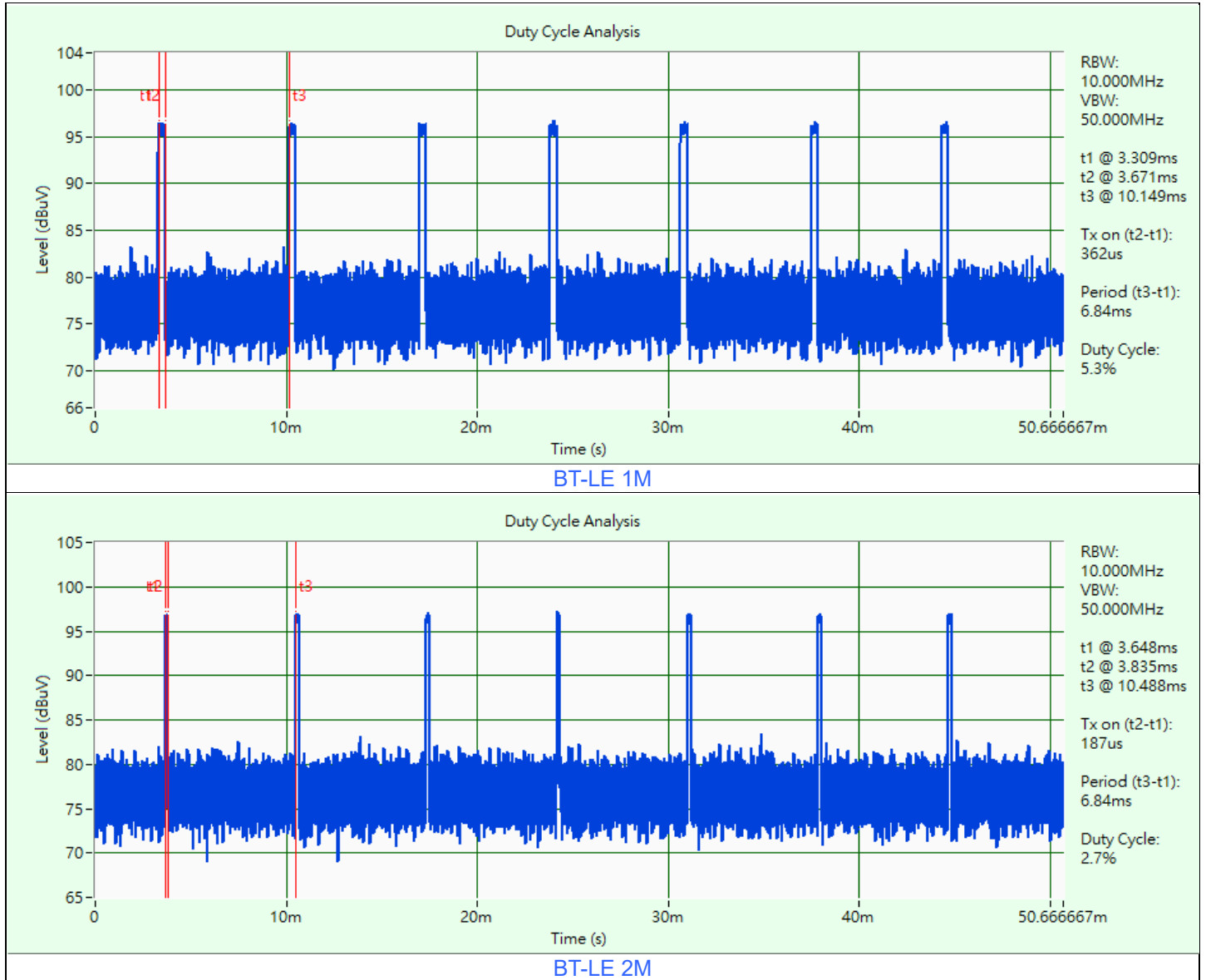



Mode B

BT-LE 1M: Duty cycle = $0.364 \text{ ms} / 6.848 \text{ ms} \times 100\% = 5.3\%$, duty factor = $10 \cdot \log (1/\text{Duty cycle}) = 12.74 \text{ dB}$

BT-LE 2M: Duty cycle = $0.188 \text{ ms} / 6.827 \text{ ms} \times 100\% = 2.8\%$, duty factor = $10 \cdot \log (1/\text{Duty cycle}) = 15.60 \text{ dB}$

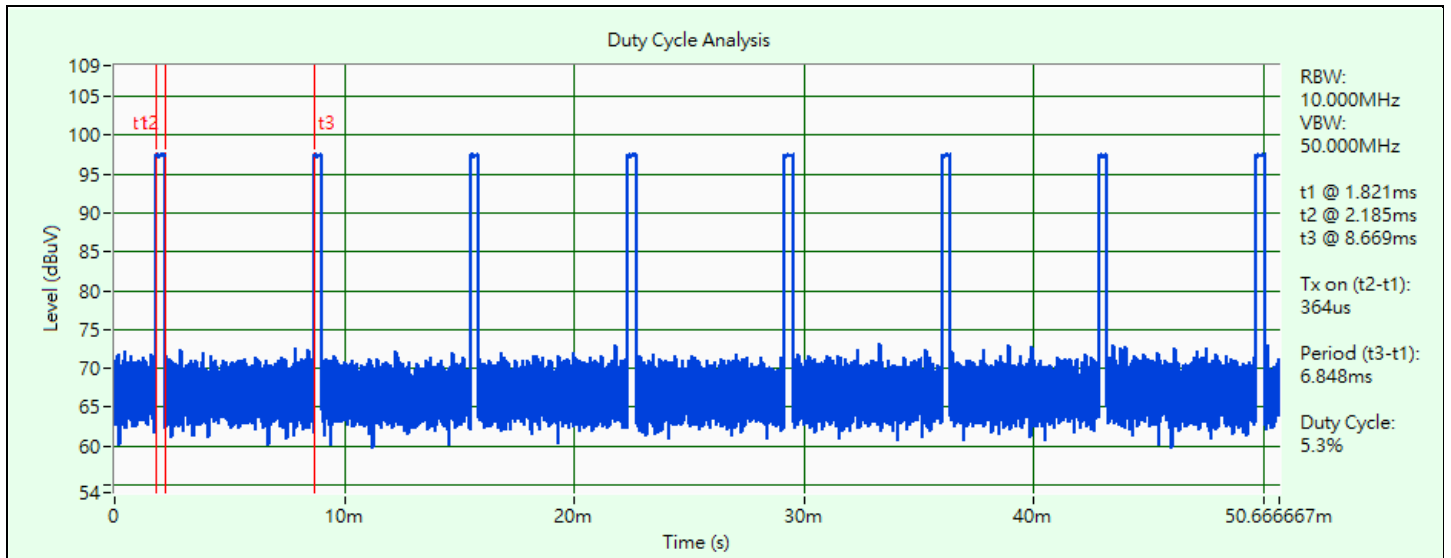

BT-LE 1M

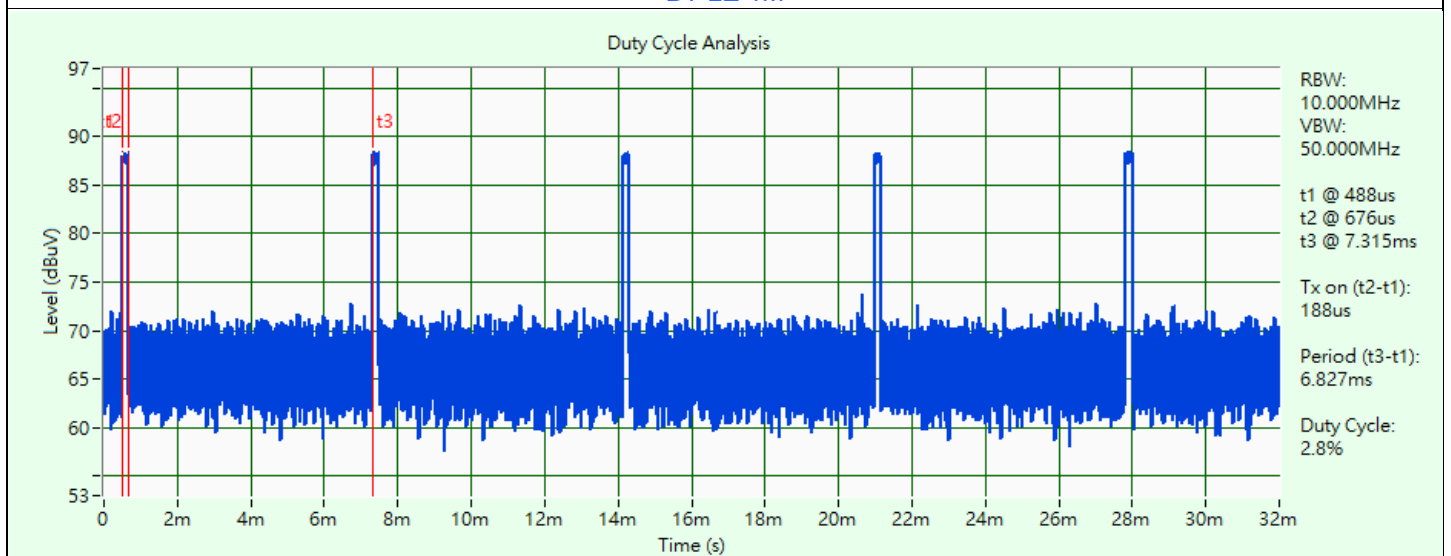

BT-LE 2M

3.6 Test Program Used and Operation Descriptions

Controlling software (RF Sample with Receiver [Number Lock]) has been activated to set the EUT under transmission condition continuously at specific channel frequency.

Test Item	Operation Description
RF Output Power / Power Spectral Density / 6 dB Bandwidth / Conducted Out of Band Emissions / Unwanted Emissions above 1 GHz	BLE1M TX Modulated 2402MHz BLE1M TX Modulated 2440MHz BLE1M TX Modulated 2480MHz BLE2M TX Modulated 2404MHz BLE2M TX Modulated 2440MHz BLE2M TX Modulated 2478MHz
AC Power Conducted Emissions / Unwanted Emissions below 1 GHz	BLE1M TX Modulated 2480MHz

3.7 Connection Diagram of EUT and Peripheral Devices

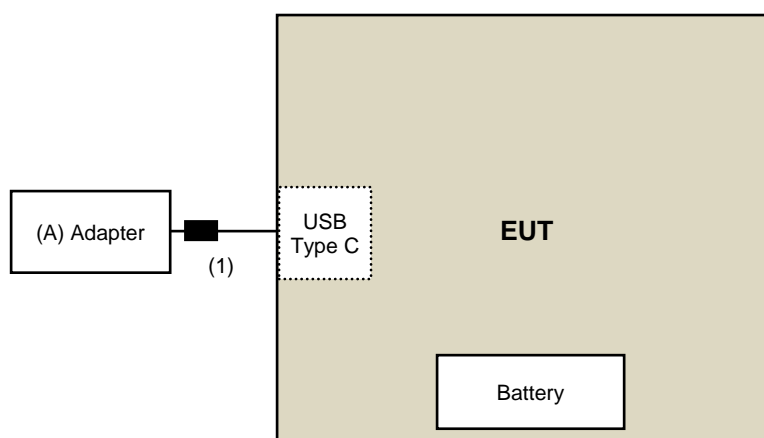

3.8 Configuration of Peripheral Devices and Cable Connections

ID	Cable Descriptions	Qty.	Length (m)	Shielding (Yes/No)	Cores (Qty.)	Remarks
1	Type A to C Cable	1	1.8	Yes	1	Supplied by applicant

4 Test Instruments

The calibration interval of the all test instruments are 12 months and the calibrations are traceable to NML/ROC and NIST/USA.

4.1 RF Output Power

Description Manufacturer	Model No.	Serial No.	Calibrated Date	Calibrated Until
Fixed Attenuator Woken	MDCS18N-10	MDCS18N-10-01	2023/3/27	2024/3/26
Power Meter Anritsu	ML2495A	1529002	2023/6/17	2024/6/16
Pulse Power Sensor Anritsu	MA2411B	1726434	2023/6/19	2024/6/18

Notes:

1. The test was performed in Oven room 2.
2. Tested Date: 2023/7/17

4.2 Power Spectral Density

Description Manufacturer	Model No.	Serial No.	Calibrated Date	Calibrated Until
Fixed Attenuator Woken	MDCS18N-10	MDCS18N-10-01	2023/3/27	2024/3/26
MXA Signal Analyzer Keysight	N9020B	MY60112409	2023/2/18	2024/2/17
Software	ADT_RF Test Software V6.6.5.4	N/A	N/A	N/A

Notes:

1. The test was performed in Oven room 2.
2. Tested Date: 2023/7/17

4.3 6 dB Bandwidth

Refer to section 4.2 to get information of the instruments.

4.4 Conducted Out of Band Emissions

Refer to section 4.2 to get information of the instruments.

4.5 AC Power Conducted Emissions

Description Manufacturer	Model No.	Serial No.	Calibrated Date	Calibrated Until
50 ohm terminal resistance	N/A	EMC-01	2022/9/27	2023/9/26
EMI Test Receiver R&S	ESCS 30	847124/029	2022/10/14	2023/10/13
Fixed Attenuator STI	STI02-2200-10	005	2023/7/1	2024/6/30
LISN R&S	ESH3-Z5	848773/004	2022/10/18	2023/10/17
RF Coaxial Cable JYEBAO	5D-FB	COCCAB-001	2023/7/1	2024/6/30
Software BVADT	BVADT_Cond_V7.3.7.4	N/A	N/A	N/A

Notes:

1. The test was performed in Conduction 1
2. Tested Date: 2023/7/27

4.6 Unwanted Emissions below 1 GHz

Description Manufacturer	Model No.	Serial No.	Calibrated Date	Calibrated Until
Bi_Log Antenna Schwarzbeck	VULB 9168	9168-0842	2022/10/24	2023/10/23
Boresight Antenna Tower & Turn Table Max-Full	MF-7802BS	MF780208530	N/A	N/A
EMI Test Receiver R&S	ESR3	102528	2023/2/10	2024/2/9
Fixed Attenuator Mini-Circuits	UNAT-5+	PAD-ATT5-02	2022/12/28	2023/12/27
Loop Antenna Electro-Metrics	EM-6879	264	2023/2/21	2024/2/20
MXA Signal Analyzer Keysight	N9020B	MY60112410	2023/3/6	2024/3/5
Preamplifier Agilent	8447D	2944A10636	2023/3/12	2024/3/11
Preamplifier EMCI	EMC330N	980538	2023/4/6	2024/4/5
PXA Signal Analyzer Keysight	N9030B	MY57141948	2023/5/19	2024/5/18
RF Coaxial Cable JYBAO	5D-FB	LOOPCAB-001	2022/12/19	2023/12/18
		LOOPCAB-002	2022/12/19	2023/12/18
RF Coaxial Cable PEWC	8D	966-5-1	2023/4/6	2024/4/5
		966-5-2	2023/4/6	2024/4/5
		966-5-3	2023/4/6	2024/4/5
Software	ADT_Radiated_V8.7.08	N/A	N/A	N/A

Notes:

1. The test was performed in 966 Chamber No. 5.
2. Tested Date: 2023/7/21

4.7 Unwanted Emissions above 1 GHz

Description Manufacturer	Model No.	Serial No.	Calibrated Date	Calibrated Until
Boresight Antenna Tower & Turn Table Max-Full	MF-7802BS	MF780208530	N/A	N/A
EMI Test Receiver R&S	ESR3	102528	2023/2/10	2024/2/9
Horn Antenna Schwarzbeck	BBHA 9120D	9120D-1819	2022/11/13	2023/11/12
	BBHA 9170	9170-739	2022/11/13	2023/11/12
MXA Signal Analyzer Keysight	N9020B	MY60112410	2023/3/6	2024/3/5
Preamplifier EMCI	EMC12630SE	980509	2023/4/7	2024/4/6
	EMC184045SE	980387	2022/12/28	2023/12/27
RF Coaxial Cable EMCI	EMC-KM-KM-4000	200214	2023/2/20	2024/2/19
	EMC102-KM-KM-1200	160924	2022/12/28	2023/12/27
	EMC104-SM-SM-1500	180503	2023/4/7	2024/4/6
	EMC104-SM-SM-2000	180501	2023/4/7	2024/4/6
	EMC104-SM-SM-6000	180506	2023/4/7	2024/4/6
Software	ADT_Radiated_V8.7.08	N/A	N/A	N/A

Notes:

1. The test was performed in 966 Chamber No. 5.
2. Tested Date: 2023/7/19 ~ 2023/7/24

5 Limits of Test Items

5.1 RF Output Power

For systems using digital modulation in the 2400–2483.5 MHz bands: 1 Watt (30 dBm)

5.2 Power Spectral Density

The Maximum of Power Spectral Density Measurement is 8 dBm in any 3 kHz.

5.3 6 dB Bandwidth

The minimum of 6 dB Bandwidth Measurement is 0.5 MHz.

5.4 Conducted Out of Band Emissions

Below 20 dB of the highest emission level of operating band (in 100 kHz Resolution Bandwidth).

5.5 AC Power Conducted Emissions

Frequency (MHz)	Conducted Limit (dBuV)	
	Quasi-peak	Average
0.15 - 0.5	66 - 56	56 - 46
0.50 - 5.0	56	46
5.0 - 30.0	60	50

Notes:

1. The lower limit shall apply at the transition frequencies.
2. The limit decreases in line with the logarithm of the frequency in the range of 0.15 to 0.50 MHz.

5.6 Unwanted Emissions below 1 GHz

Radiated emissions up to 1 GHz which fall in the restricted bands must comply with the radiated emission limits specified as below table. Other emissions shall be at least 20 dB below the highest level of the desired power:

Frequencies (MHz)	Field Strength (microvolts/meter)	Measurement Distance (meters)
0.009 ~ 0.490	2400/F(kHz)	300
0.490 ~ 1.705	24000/F(kHz)	30
1.705 ~ 30.0	30	30
30 ~ 88	100	3
88 ~ 216	150	3
216 ~ 960	200	3
Above 960	500	3

Notes:

1. The lower limit shall apply at the transition frequencies.
2. Emission level (dBuV/m) = 20 log Emission level (uV/m).

5.7 Unwanted Emissions above 1 GHz

Radiated emissions above 1 GHz which fall in the restricted bands must comply with the radiated emission limits specified as below table. Other emissions shall be at least 20 dB below the highest level of the desired power:

Frequencies (MHz)	Field Strength (microvolts/meter)	Measurement Distance (meters)
Above 960	500	3

Notes:

1. The lower limit shall apply at the transition frequencies.
2. Emission level (dBuV/m) = 20 log Emission level (uV/m).
3. For frequencies above 1000 MHz, the field strength limits are based on average detector, however, the peak field strength of any emission shall not exceed the maximum permitted average limits, specified above by more than 20 dB under any condition of modulation.

6 Test Arrangements

6.1 RF Output Power

6.1.1 Test Setup

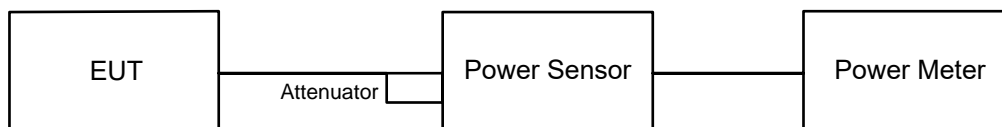

6.1.2 Test Procedure

Peak Power:

A peak power sensor was used on the output port of the EUT. A power meter was used to read the response of the peak power sensor. Record the power level.

Average Power:

Average power sensor was used to perform output power measurement, trigger and gating function of wide band power meter is enabled to measure max output power of TX on burst. Duty factor is not added to measured value.

6.2 Power Spectral Density

6.2.1 Test Setup

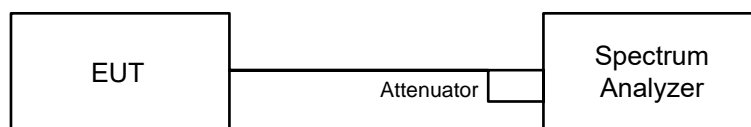

6.2.2 Test Procedure

- a. Set analyzer center frequency to DTS channel center frequency.
- b. Set the span to 1.5 times the DTS bandwidth.
- c. Set the RBW to: 3 kHz.
- d. Set the VBW $\geq 3 \times$ RBW.
- e. Detector = peak.
- f. Sweep time = auto couple.
- g. Trace mode = max hold.
- h. Allow trace to fully stabilize.
- i. Use the peak marker function to determine the maximum amplitude level within the RBW.

6.3 6 dB Bandwidth

6.3.1 Test Setup

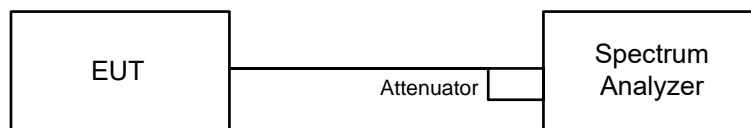

6.3.2 Test Procedure

- Set resolution bandwidth (RBW) = 100 kHz.
- Set the video bandwidth (VBW) $\geq 3 \times$ RBW, Detector = Peak.
- Trace mode = max hold.
- Sweep = auto couple.
- Measure the maximum width of the emission that is constrained by the frequencies associated with the two amplitude points (upper and lower) that are attenuated by 6 dB relative to the maximum level measured in the fundamental emission.

6.4 Conducted Out of Band Emissions

6.4.1 Test Setup

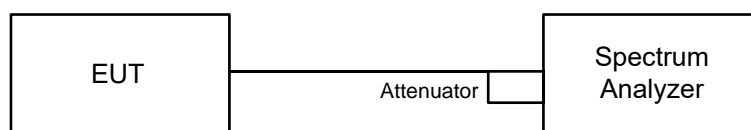

6.4.2 Test Procedure

MEASUREMENT PROCEDURE REF

- Set the RBW = 100 kHz.
- Set the VBW ≥ 300 kHz.
- Detector = peak.
- Sweep time = auto couple.
- Trace mode = max hold.
- Allow trace to fully stabilize.
- Use the peak marker function to determine the maximum power level in any 100 kHz band segment within the fundamental EBW.

MEASUREMENT PROCEDURE OOB

- Set RBW = 100 kHz.
- Set VBW ≥ 300 kHz.
- Detector = peak.
- Sweep = auto couple.
- Trace Mode = max hold.
- Allow trace to fully stabilize.
- Use the peak marker function to determine the maximum amplitude level.

6.5 AC Power Conducted Emissions

6.5.1 Test Setup

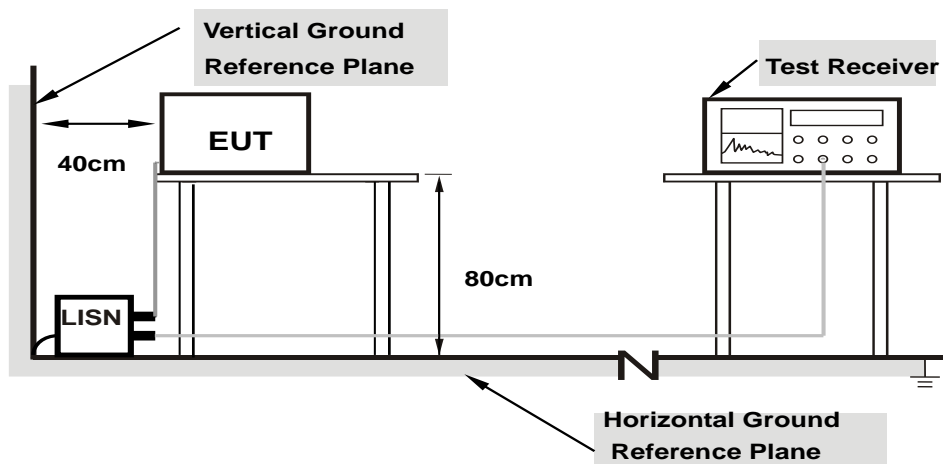

Note: 1. Support units were connected to second LISN.

For the actual test configuration, please refer to the attached file (Test Setup Photo).

6.5.2 Test Procedure

- The EUT was placed on a 0.8 meter to the top of table and placed 0.4 meters from the conducting wall of the shielded room with EUT being connected to the power mains through a line impedance stabilization network (LISN). Other support units were connected to the power mains through another LISN. The two LISNs provide 50 ohm/ 50 uH of coupling impedance for the measuring instrument.
- Both lines of the power mains connected to the EUT were checked for maximum conducted interference.
- The frequency range from 150 kHz to 30 MHz was searched. Emission levels under (Limit – 20 dB) was not recorded.

Note: The resolution bandwidth and video bandwidth of test receiver is 9 kHz for quasi-peak detection (QP) and average detection (AV) at frequency 0.15 MHz-30 MHz.

6.6 Unwanted Emissions below 1 GHz

6.6.1 Test Setup

For Radiated emission below 30 MHz

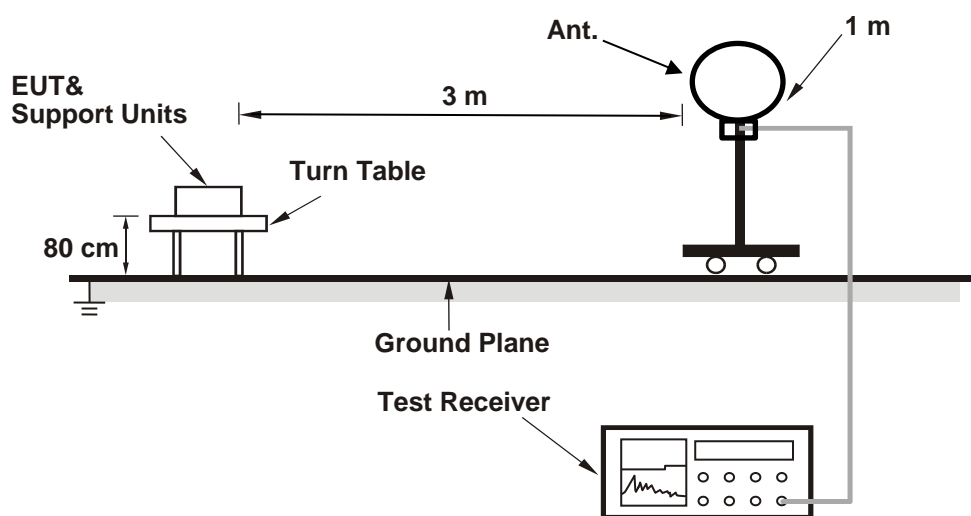

For Radiated emission above 30 MHz

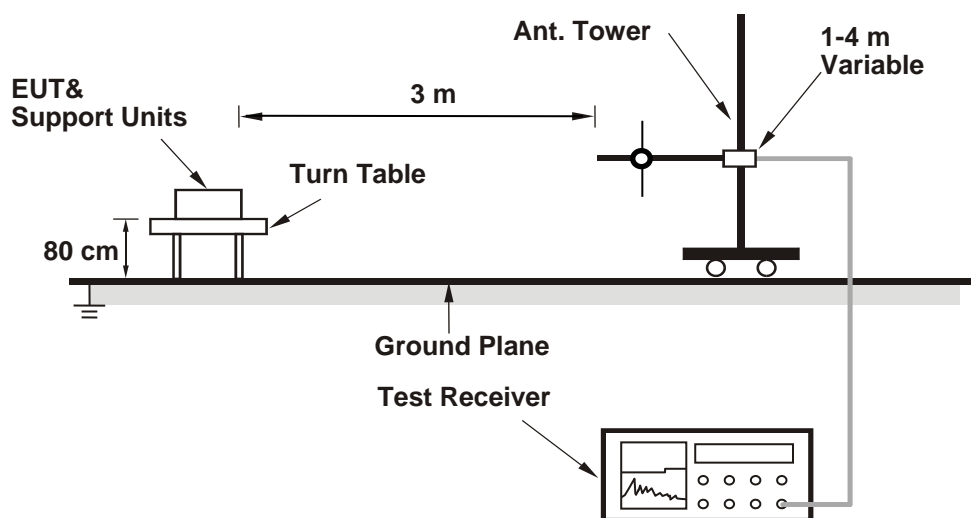

For the actual test configuration, please refer to the attached file (Test Setup Photo).

6.6.2 Test Procedure

For Radiated emission below 30 MHz

- a. The EUT was placed on the top of a rotating table 0.8 meters above the ground at 3 meter chamber room for test. The table was rotated 360 degrees to determine the position of the highest radiation.
- b. The EUT was set 3 meters away from the interference-receiving antenna, which was mounted on the top of a variable-height antenna tower.
- c. Parallel, perpendicular, and ground-parallel orientations of the antenna are set to make the measurement.
- d. For each suspected emission, the EUT was arranged to its worst case and the rotatable table was turned from 0 degrees to 360 degrees to find the maximum reading.
- e. The test-receiver system was set to Quasi-Peak Detect Function and Specified Bandwidth with Maximum Hold Mode, except for the frequency band (9 kHz to 90 kHz and 110 kHz to 490 kHz) set to average detect function and peak detect function.

Notes:

1. The resolution bandwidth and video bandwidth of test receiver/spectrum analyzer is 200 Hz at frequency below 150 kHz.
2. The resolution bandwidth and video bandwidth of test receiver/spectrum analyzer is 9 kHz or 10 kHz at frequency (150 kHz to 30 MHz).
3. All modes of operation were investigated and the worst-case emissions are reported.

For Radiated emission above 30 MHz

- a. The EUT was placed on the top of a rotating table 0.8 meters above the ground at 3 meter chamber room for test. The table was rotated 360 degrees to determine the position of the highest radiation.
- b. The EUT was set 3 meters away from the interference-receiving antenna, which was mounted on the top of a variable-height antenna tower.
- c. The height of antenna is varied from one meter to four meters above the ground to determine the maximum value of the field strength. Both horizontal and vertical polarizations of the antenna are set to make the measurement.
- d. For each suspected emission, the EUT was arranged to its worst case and then the antenna was tuned to heights from 1 meter to 4 meters and the rotatable table was turned from 0 degrees to 360 degrees to find the maximum reading.
- e. The test-receiver system was set to quasi-peak detect function and specified bandwidth with maximum hold mode when the test frequency is below 1 GHz.

Notes:

1. The resolution bandwidth and video bandwidth of test receiver/spectrum analyzer is 120 kHz for Quasi-peak detection (QP) at frequency below 1 GHz.
2. All modes of operation were investigated and the worst-case emissions are reported.

6.7 Unwanted Emissions above 1 GHz

6.7.1 Test Setup

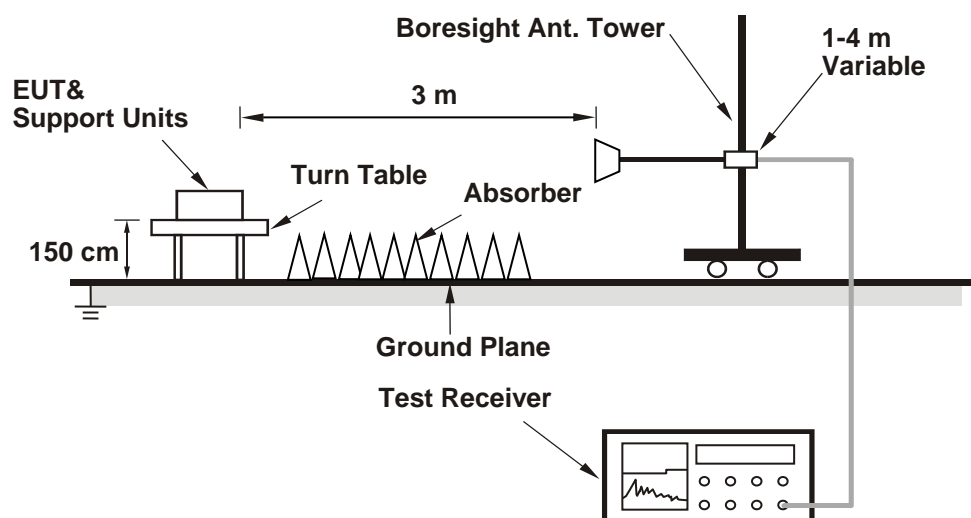

For the actual test configuration, please refer to the attached file (Test Setup Photo).

6.7.2 Test Procedure

- The EUT was placed on the top of a rotating table 1.5 meters above the ground at 3 meter chamber room for test. The table was rotated 360 degrees to determine the position of the highest radiation.
- The EUT was set 3 meters away from the interference-receiving antenna, which was mounted on the top of a variable-height antenna tower.
- The height of antenna is varied from one meter to four meters above the ground to determine the maximum value of the field strength. Both horizontal and vertical polarizations of the antenna are set to make the measurement.
- For each suspected emission, the EUT was arranged to its worst case and then the antenna was tuned to heights from 1 meter to 4 meters and the rotatable table was turned from 0 degrees to 360 degrees to find the maximum reading.
- The test-receiver system was set to peak and average detects function and specified bandwidth with maximum hold mode when the test frequency is above 1 GHz. If the peak reading value also meets average limit, measurement with the average detector is unnecessary.

Notes:

- The resolution bandwidth of test receiver/spectrum analyzer is 1 MHz and the video bandwidth is 3 MHz for Peak detection (PK) and Average detection (AV) at frequency above 1 GHz.
- According to ANSI C63.10 section 6.6.4 and 4.1.4.2.2. For fundamental and harmonic signal measurement, according to ANSI C63.10 section 7.5, the average value = peak value + duty cycle correction factor. For duty cycle correction factor values, see the Test Signal Duty Cycle section in this report.
- All modes of operation were investigated and the worst-case emissions are reported.

7 Test Results of Test Item

7.1 RF Output Power

Mode A

Input Power:	3.7 Vdc	Environmental Conditions:	25°C, 65% RH	Tested By:	Eric Peng
--------------	---------	---------------------------	--------------	------------	-----------

For Peak Power

BT-LE 1M

Chan.	Chan. Freq. (MHz)	Peak Power (mW)	Peak Power (dBm)	Power Limit (dBm)	Test Result
0	2402	3.236	5.10	30	Pass
19	2440	3.532	5.48	30	Pass
39	2480	3.784	5.78	30	Pass

Note: The antenna gain is 2.55 dBi < 6 dBi, so the output power limit shall not be reduced.

BT-LE 2M

Chan.	Chan. Freq. (MHz)	Peak Power (mW)	Peak Power (dBm)	Power Limit (dBm)	Test Result
1	2404	3.243	5.11	30	Pass
19	2440	3.532	5.48	30	Pass
38	2478	3.758	5.75	30	Pass

Note: The antenna gain is 2.55 dBi < 6 dBi, so the output power limit shall not be reduced.

For Average Power

BT-LE 1M

Chan.	Chan. Freq. (MHz)	Average Power (mW)	Average Power (dBm)
0	2402	3.119	4.94
19	2440	3.42	5.34
39	2480	3.673	5.65

BT-LE 2M

Chan.	Chan. Freq. (MHz)	Average Power (mW)	Average Power (dBm)
1	2404	3.133	4.96
19	2440	3.412	5.33
38	2478	3.664	5.64

7.2 Power Spectral Density

Mode A

Input Power:	3.7 Vdc	Environmental Conditions:	25°C, 65% RH	Tested By:	Eric Peng
--------------	---------	---------------------------	--------------	------------	-----------

BT-LE 1M

Chan.	Chan. Freq. (MHz)	PSD (dBm/3kHz)	PSD Limit (dBm/3kHz)	Test Result
0	2402	1.80	8	Pass
19	2440	2.61	8	Pass
39	2480	2.98	8	Pass

Note: The antenna gain is 2.55 dBi < 6 dBi, so the power density limit shall not be reduced.

BT-LE 2M

Chan.	Chan. Freq. (MHz)	PSD (dBm/3kHz)	PSD Limit (dBm/3kHz)	Test Result
1	2404	-1.40	8	Pass
19	2440	-0.77	8	Pass
38	2478	-1.35	8	Pass

Note: The antenna gain is 2.55 dBi < 6 dBi, so the power density limit shall not be reduced.

Spectrum Plot of Maximum Value

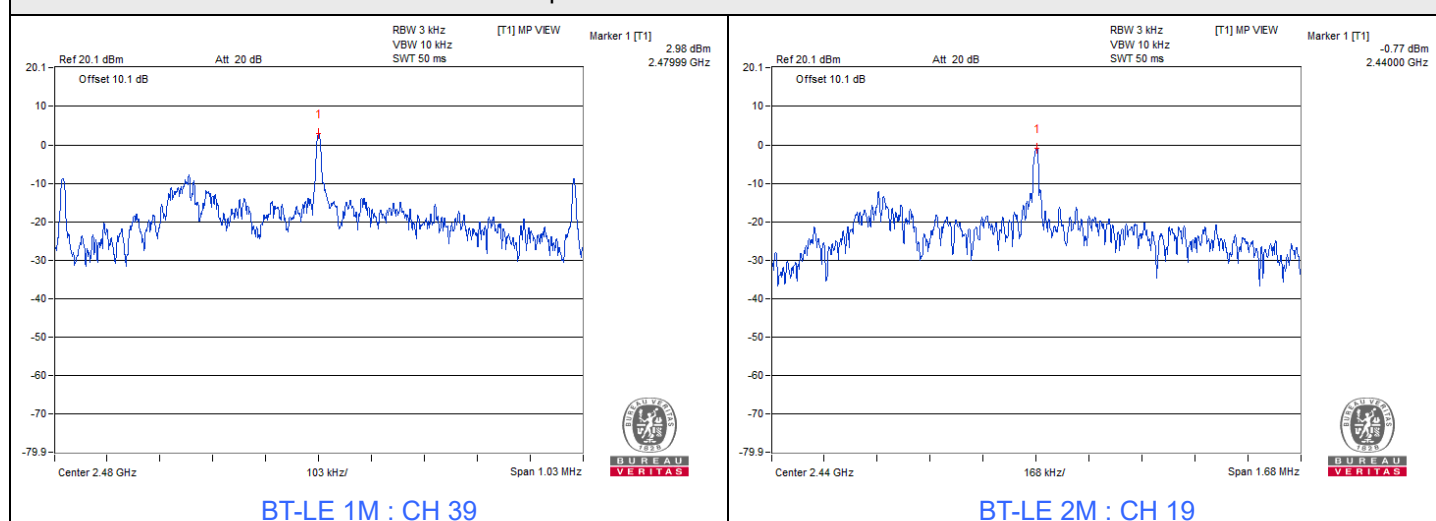

7.3 6 dB Bandwidth

Mode A

Input Power:	3.7 Vdc	Environmental Conditions:	25°C, 65% RH	Tested By:	Eric Peng
--------------	---------	---------------------------	--------------	------------	-----------

BT-LE 1M

Channel	Frequency (MHz)	6 dB Bandwidth (MHz)	Minimum Limit (MHz)	Test Result
0	2402	0.68	0.5	Pass
19	2440	0.68	0.5	Pass
39	2480	0.69	0.5	Pass

BT-LE 2M

Channel	Frequency (MHz)	6 dB Bandwidth (MHz)	Minimum Limit (MHz)	Test Result
1	2404	1.15	0.5	Pass
19	2440	1.12	0.5	Pass
38	2478	1.14	0.5	Pass

Spectrum Plot of Minimum Value

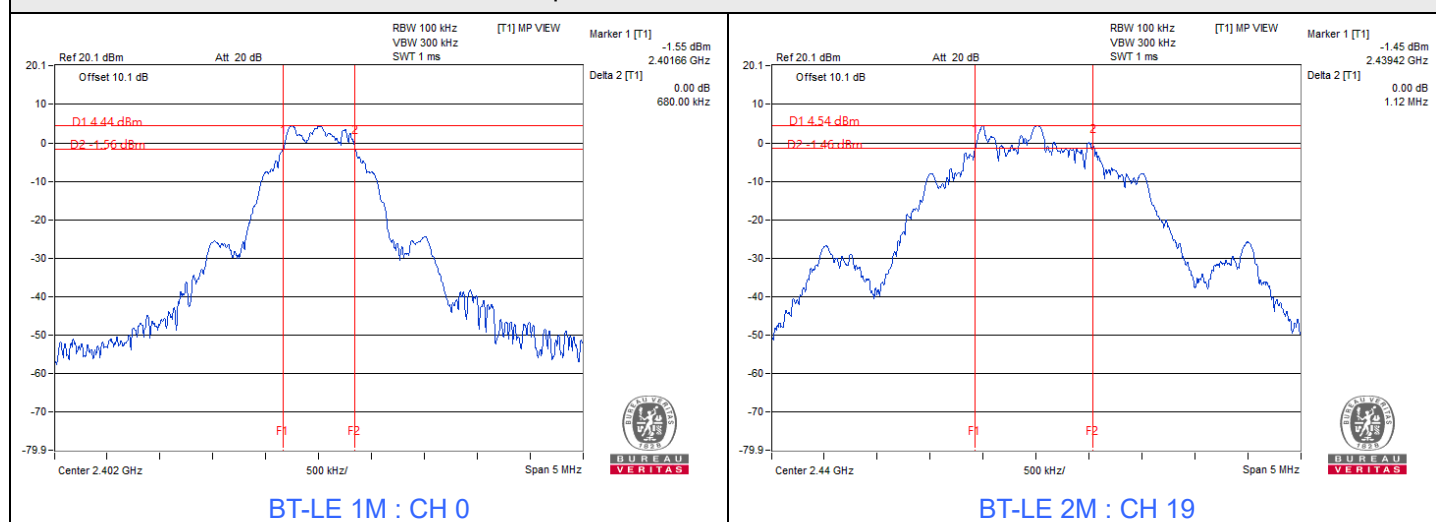



BUREAU VERITAS

7.4 Conducted Out of Band Emissions

Mode A

Input Power:	3.7 Vdc	Environmental Conditions:	25°C, 65% RH	Tested By:	Eric Peng
--------------	---------	---------------------------	--------------	------------	-----------

BT-LE 1M

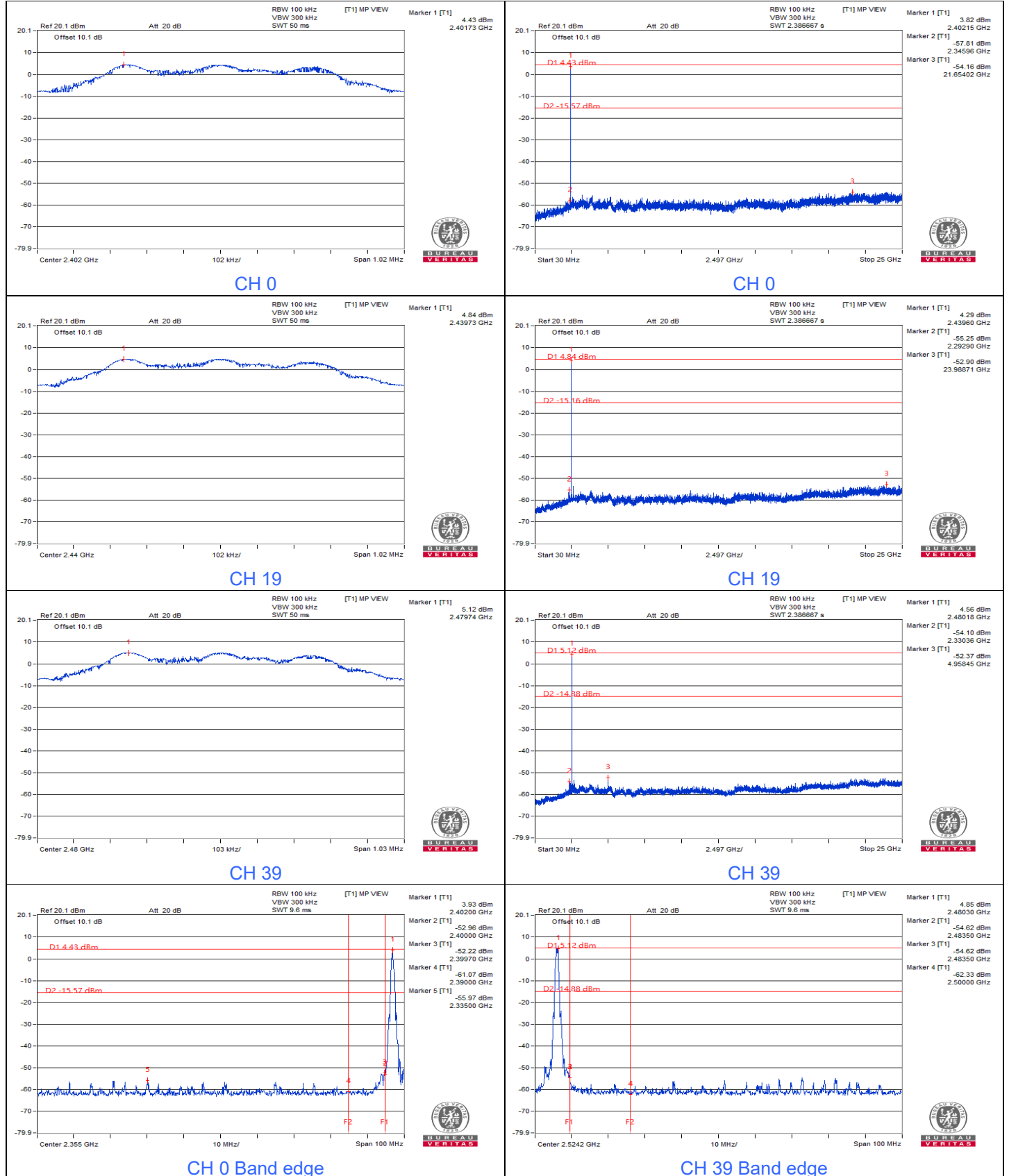



BT-LE 2M

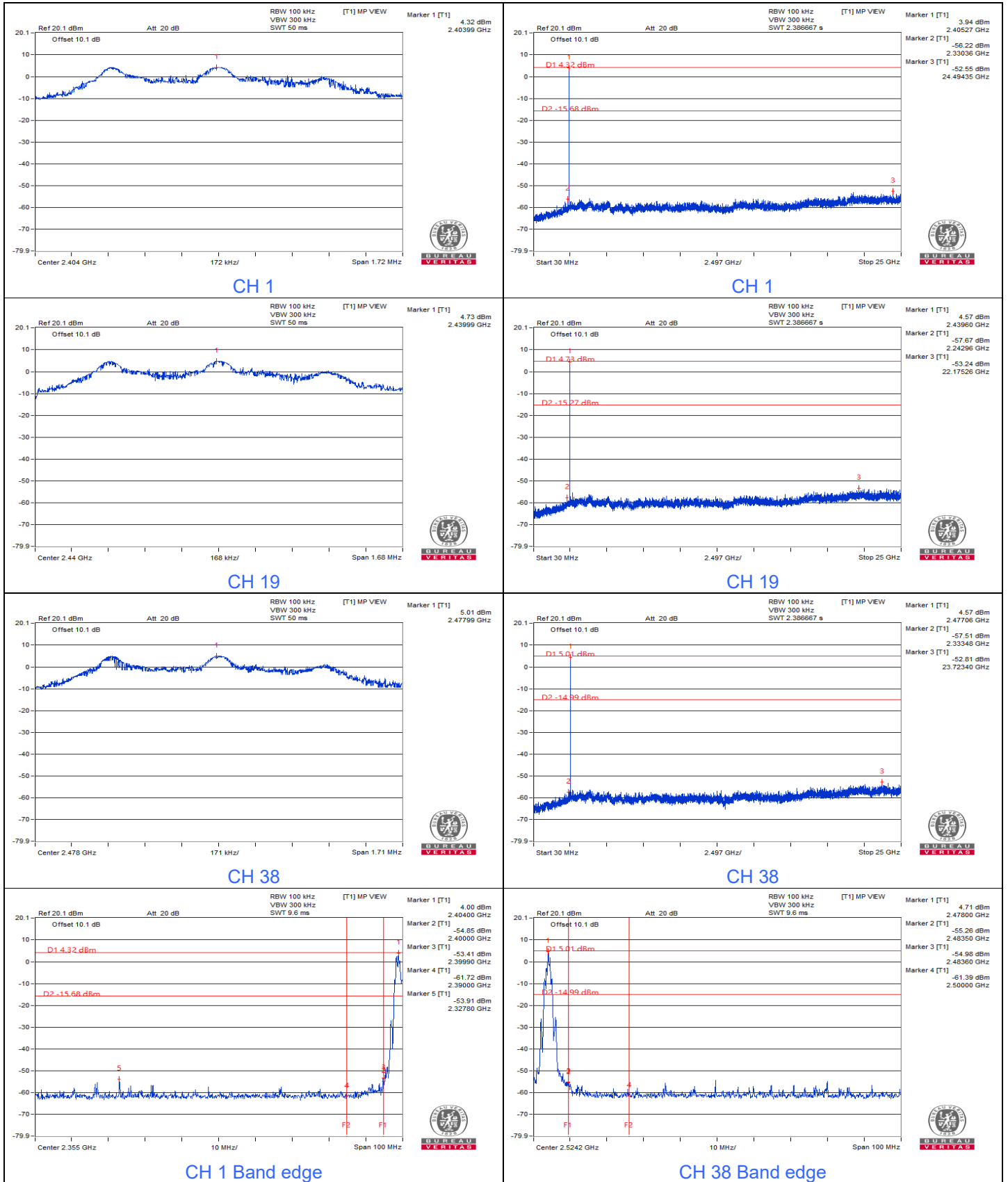

7.5 AC Power Conducted Emissions

Mode A

RF Mode	BT-LE 1M	Channel	CH 39 : 2480 MHz
Frequency Range	150kHz ~ 30MHz	Detector Function & Resolution Bandwidth	Quasi-Peak (QP) / Average (AV), 9 kHz
Input Power (System)	120 Vac, 60 Hz	Environmental Conditions	20°C, 72% RH
Tested By	Sampson Chen		

Phase Of Power : Line (L)										
No	Frequency (MHz)	Correction Factor (dB)	Reading Value (dBuV)		Emission Level (dBuV)		Limit (dBuV)		Margin (dB)	
			Q.P.	AV.	Q.P.	AV.	Q.P.	AV.	Q.P.	AV.
1	0.17344	9.95	36.72	23.50	46.67	33.45	64.79	54.79	-18.12	-21.34
2	0.21250	9.95	35.19	24.01	45.14	33.96	63.11	53.11	-17.97	-19.15
3	0.25547	9.95	32.46	22.14	42.41	32.09	61.58	51.58	-19.17	-19.49
4	0.56016	9.97	26.98	20.27	36.95	30.24	56.00	46.00	-19.05	-15.76
5	0.93125	10.00	20.47	10.32	30.47	20.32	56.00	46.00	-25.53	-25.68
6	1.95703	10.04	18.02	9.33	28.06	19.37	56.00	46.00	-27.94	-26.63

Remarks:

1. Q.P. and AV. are abbreviations of quasi-peak and average individually.
2. The emission levels of other frequencies were very low against the limit.
3. Margin value = Emission level – Limit value
4. Correction factor = Insertion loss + Cable loss
5. Emission Level = Correction Factor + Reading Value

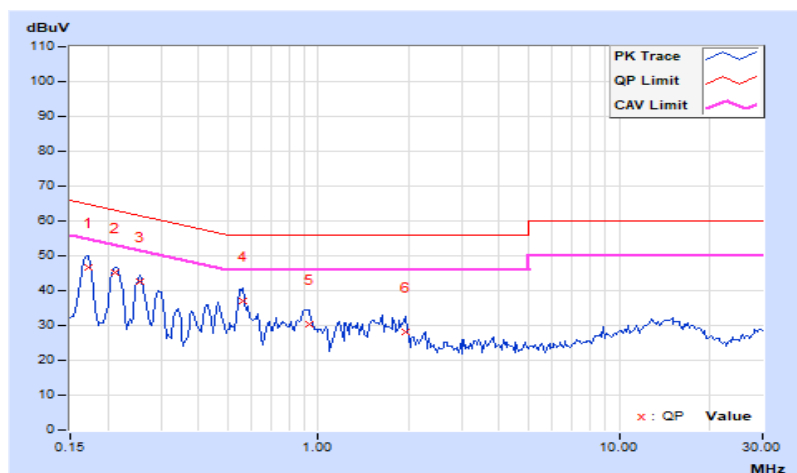

RF Mode	BT-LE 1M	Channel	CH 39 : 2480 MHz
Frequency Range	150kHz ~ 30MHz	Detector Function & Resolution Bandwidth	Quasi-Peak (QP) / Average (AV), 9 kHz
Input Power (System)	120 Vac, 60 Hz	Environmental Conditions	20°C, 72% RH
Tested By	Sampson Chen		

Phase Of Power : Neutral (N)										
No	Frequency (MHz)	Correction Factor (dB)	Reading Value (dBuV)		Emission Level (dBuV)		Limit (dBuV)		Margin (dB)	
			Q.P.	AV.	Q.P.	AV.	Q.P.	AV.	Q.P.	AV.
1	0.16953	10.00	37.46	30.63	47.46	40.63	64.98	54.98	-17.52	-14.35
2	0.21641	10.00	32.99	26.52	42.99	36.52	62.96	52.96	-19.97	-16.44
3	0.25547	10.00	31.86	25.68	41.86	35.68	61.58	51.58	-19.72	-15.90
4	0.46641	10.01	29.72	22.91	39.73	32.92	56.58	46.58	-16.85	-13.66
5	0.55625	10.02	36.04	28.30	46.06	38.32	56.00	46.00	-9.94	-7.68
6	0.91953	10.04	24.12	15.23	34.16	25.27	56.00	46.00	-21.84	-20.73

Remarks:

1. Q.P. and AV. are abbreviations of quasi-peak and average individually.
2. The emission levels of other frequencies were very low against the limit.
3. Margin value = Emission level – Limit value
4. Correction factor = Insertion loss + Cable loss
5. Emission Level = Correction Factor + Reading Value

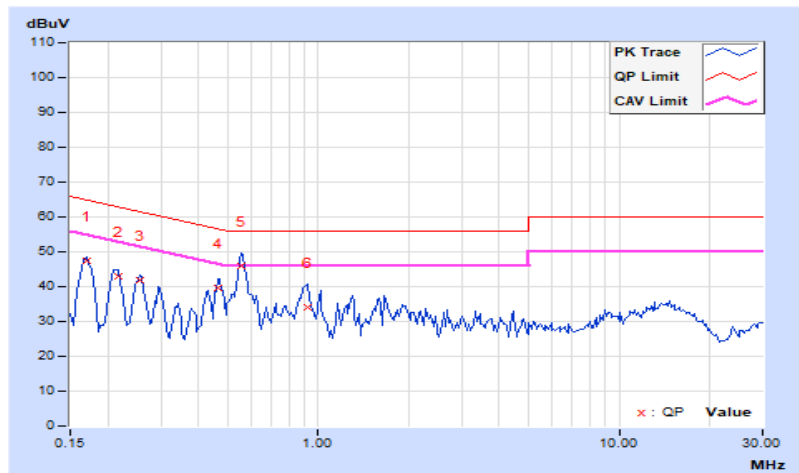

Mode B

RF Mode	BT-LE 1M	Channel	CH 39 : 2480 MHz
Frequency Range	150kHz ~ 30MHz	Detector Function & Resolution Bandwidth	Quasi-Peak (QP) / Average (AV), 9 kHz
Input Power (System)	120 Vac, 60 Hz	Environmental Conditions	20°C, 72% RH
Tested By	Sampson Chen		

Phase Of Power : Line (L)										
No	Frequency (MHz)	Correction Factor (dB)	Reading Value (dBuV)		Emission Level (dBuV)		Limit (dBuV)		Margin (dB)	
			Q.P.	AV.	Q.P.	AV.	Q.P.	AV.	Q.P.	AV.
1	0.16562	9.95	38.18	25.41	48.13	35.36	65.18	55.18	-17.05	-19.82
2	0.20859	9.95	34.21	23.40	44.16	33.35	63.26	53.26	-19.10	-19.91
3	0.24766	9.95	32.46	22.87	42.41	32.82	61.84	51.84	-19.43	-19.02
4	0.57188	9.97	25.47	16.13	35.44	26.10	56.00	46.00	-20.56	-19.90
5	1.59766	10.02	21.29	11.28	31.31	21.30	56.00	46.00	-24.69	-24.70
6	13.81641	10.87	16.21	8.22	27.08	19.09	60.00	50.00	-32.92	-30.91

Remarks:

1. Q.P. and AV. are abbreviations of quasi-peak and average individually.
2. The emission levels of other frequencies were very low against the limit.
3. Margin value = Emission level – Limit value
4. Correction factor = Insertion loss + Cable loss
5. Emission Level = Correction Factor + Reading Value

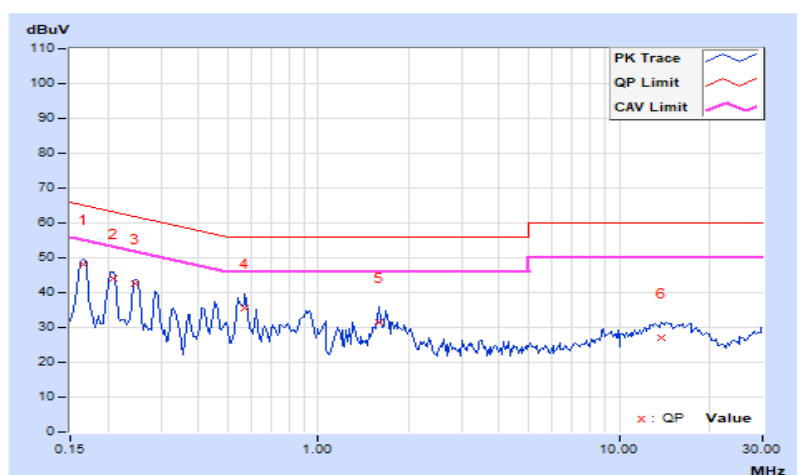

RF Mode	BT-LE 1M	Channel	CH 39 : 2480 MHz
Frequency Range	150kHz ~ 30MHz	Detector Function & Resolution Bandwidth	Quasi-Peak (QP) / Average (AV), 9 kHz
Input Power (System)	120 Vac, 60 Hz	Environmental Conditions	20°C, 72% RH
Tested By	Sampson Chen		

Phase Of Power : Neutral (N)										
No	Frequency (MHz)	Correction Factor (dB)	Reading Value (dBuV)		Emission Level (dBuV)		Limit (dBuV)		Margin (dB)	
			Q.P.	AV.	Q.P.	AV.	Q.P.	AV.	Q.P.	AV.
1	0.16562	10.00	37.86	31.53	47.86	41.53	65.18	55.18	-17.32	-13.65
2	0.20859	10.00	33.59	28.50	43.59	38.50	63.26	53.26	-19.67	-14.76
3	0.54453	10.02	32.88	23.42	42.90	33.44	56.00	46.00	-13.10	-12.56
4	0.57188	10.02	30.43	23.53	40.45	33.55	56.00	46.00	-15.55	-12.45
5	1.58594	10.08	25.61	17.46	35.69	27.54	56.00	46.00	-20.31	-18.46
6	13.04688	10.77	19.28	11.86	30.05	22.63	60.00	50.00	-29.95	-27.37

Remarks:

1. Q.P. and AV. are abbreviations of quasi-peak and average individually.
2. The emission levels of other frequencies were very low against the limit.
3. Margin value = Emission level – Limit value
4. Correction factor = Insertion loss + Cable loss
5. Emission Level = Correction Factor + Reading Value

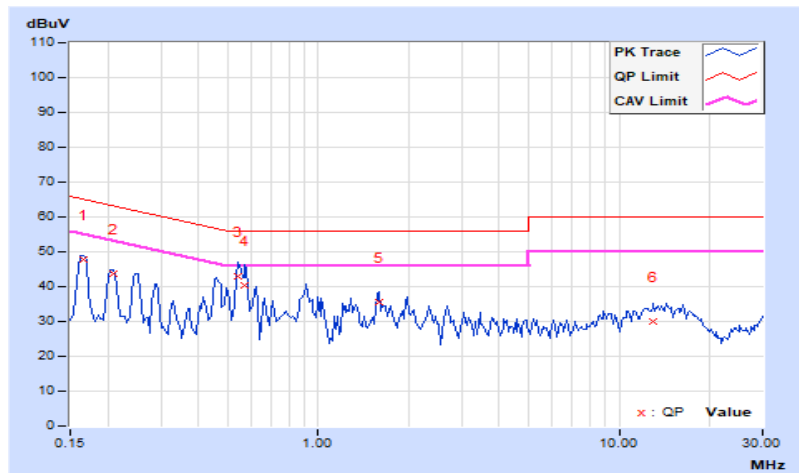

7.6 Unwanted Emissions below 1 GHz

Mode A

RF Mode	BT-LE 1M	Channel	CH 39 : 2480 MHz
Frequency Range	30 MHz ~ 1 GHz	Detector Function & Bandwidth	Quasi-Peak (QP), RB = 120kHz
Input Power (System)	120 Vac, 60 Hz	Environmental Conditions	29°C, 74% RH
Tested By	Loius Yang		

Antenna Polarity & Test Distance : Horizontal at 3 m								
No	Frequency (MHz)	Emission Level (dBuV/m)	Limit (dBuV/m)	Margin (dB)	Antenna Height (m)	Table Angle (Degree)	Raw Value (dBuV)	Correction Factor (dB/m)
1	41.74	22.8 QP	40.0	-17.2	1.50 H	229	35.9	-13.1
2	97.03	23.3 QP	43.5	-20.2	1.50 H	87	41.1	-17.8
3	176.23	20.7 QP	43.5	-22.8	1.00 H	94	34.5	-13.8
4	242.78	17.7 QP	46.0	-28.3	1.00 H	100	31.9	-14.2
5	325.33	21.3 QP	46.0	-24.7	1.00 H	122	32.6	-11.3
6	488.40	21.4 QP	46.0	-24.6	2.00 H	1	28.8	-7.4

Remarks:

1. Emission Level(dBuV/m) = Raw Value(dBuV) + Correction Factor(dB/m)
2. Correction Factor(dB/m) = Antenna Factor(dB/m) + Cable Factor(dB) – Pre-Amplifier Factor(dB)
3. Margin value = Emission Level – Limit value
4. The other emission levels were very low against the limit of frequency range 30 MHz ~ 1 GHz.
5. The frequency range 9 kHz ~ 30 MHz: all emissions are more than 20 dB below the limit, therefore do not be recorded in this report.

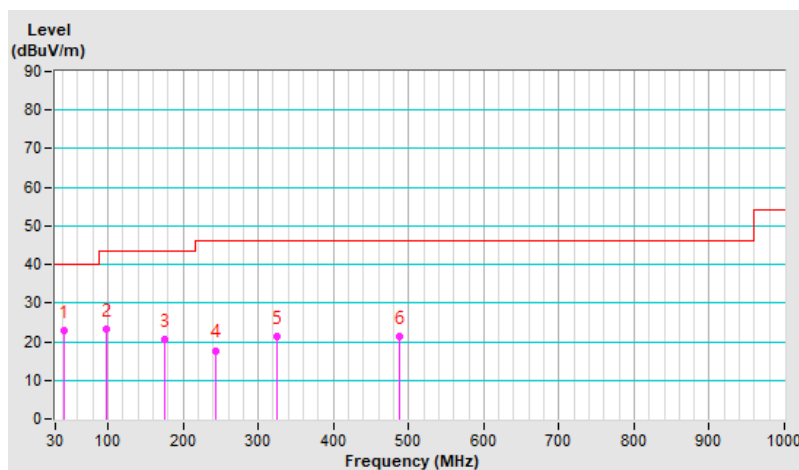

RF Mode	BT-LE 1M	Channel	CH 39 : 2480 MHz
Frequency Range	30 MHz ~ 1 GHz	Detector Function & Bandwidth	Quasi-Peak (QP), RB = 120kHz
Input Power (System)	120 Vac, 60 Hz	Environmental Conditions	29°C, 74% RH
Tested By	Loius Yang		

Antenna Polarity & Test Distance : Vertical at 3 m								
No	Frequency (MHz)	Emission Level (dBuV/m)	Limit (dBuV/m)	Margin (dB)	Antenna Height (m)	Table Angle (Degree)	Raw Value (dBuV)	Correction Factor (dB/m)
1	41.69	35.2 QP	40.0	-4.8	1.00 V	40	48.3	-13.1
2	97.08	21.2 QP	43.5	-22.3	2.00 V	5	39.0	-17.8
3	175.80	21.6 QP	43.5	-21.9	1.00 V	338	35.3	-13.7
4	242.44	19.2 QP	46.0	-26.8	1.50 V	1	33.4	-14.2
5	322.42	21.6 QP	46.0	-24.4	1.00 V	90	33.0	-11.4
6	423.69	30.3 QP	46.0	-15.7	1.50 V	194	39.1	-8.8

Remarks:

1. Emission Level(dBuV/m) = Raw Value(dBuV) + Correction Factor(dB/m)
2. Correction Factor(dB/m) = Antenna Factor(dB/m) + Cable Factor(dB) – Pre-Amplifier Factor(dB)
3. Margin value = Emission Level – Limit value
4. The other emission levels were very low against the limit of frequency range 30 MHz ~ 1 GHz.
5. The frequency range 9 kHz ~ 30 MHz: all emissions are more than 20 dB below the limit, therefore do not be recorded in this report.

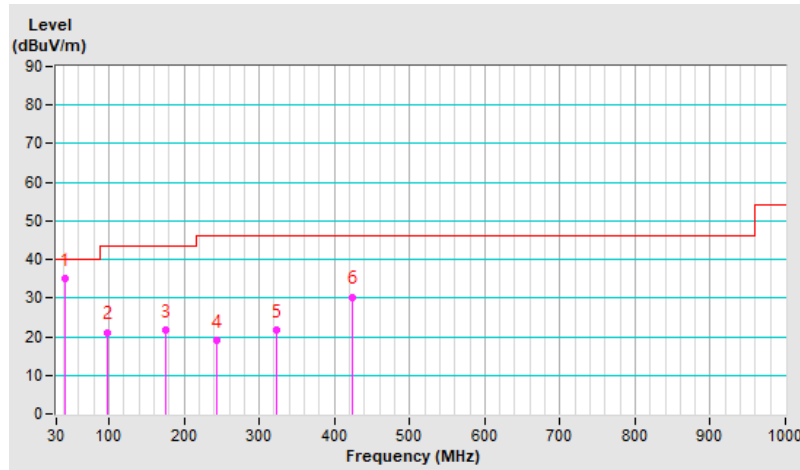

Mode B

RF Mode	BT-LE 1M	Channel	CH 39 : 2480 MHz
Frequency Range	30 MHz ~ 1 GHz	Detector Function & Bandwidth	Quasi-Peak (QP), RB = 120kHz
Input Power (System)	120 Vac, 60 Hz	Environmental Conditions	29°C, 74% RH
Tested By	Loius Yang		

Antenna Polarity & Test Distance : Horizontal at 3 m								
No	Frequency (MHz)	Emission Level (dBuV/m)	Limit (dBuV/m)	Margin (dB)	Antenna Height (m)	Table Angle (Degree)	Raw Value (dBuV)	Correction Factor (dB/m)
1	42.42	22.6 QP	40.0	-17.4	2.00 H	244	35.6	-13.0
2	96.69	24.3 QP	43.5	-19.2	2.00 H	83	42.2	-17.9
3	198.16	15.0 QP	43.5	-28.5	2.00 H	82	31.0	-16.0
4	321.79	21.2 QP	46.0	-24.8	1.00 H	136	32.6	-11.4
5	473.12	22.6 QP	46.0	-23.4	2.00 H	46	30.2	-7.6
6	608.59	25.4 QP	46.0	-20.6	2.00 H	119	30.0	-4.6

Remarks:

1. Emission Level(dBuV/m) = Raw Value(dBuV) + Correction Factor(dB/m)
2. Correction Factor(dB/m) = Antenna Factor(dB/m) + Cable Factor(dB) – Pre-Amplifier Factor(dB)
3. Margin value = Emission Level – Limit value
4. The other emission levels were very low against the limit of frequency range 30 MHz ~ 1 GHz.
5. The frequency range 9 kHz ~ 30 MHz: all emissions are more than 20 dB below the limit, therefore do not be recorded in this report.

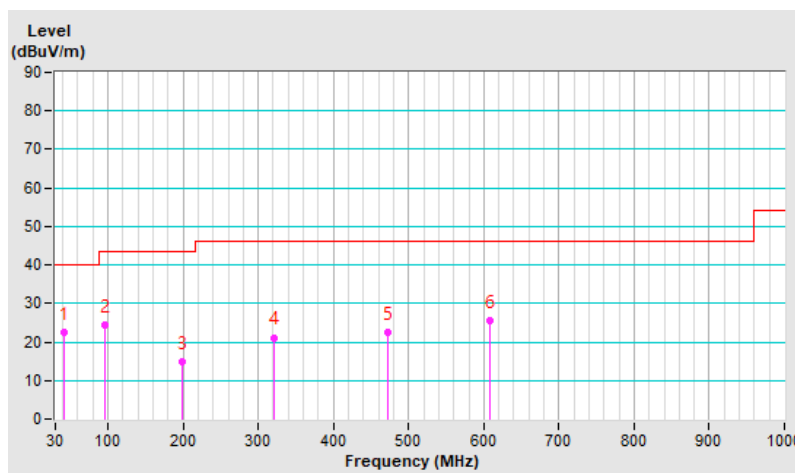

RF Mode	BT-LE 1M	Channel	CH 39 : 2480 MHz
Frequency Range	30 MHz ~ 1 GHz	Detector Function & Bandwidth	Quasi-Peak (QP), RB = 120kHz
Input Power (System)	120 Vac, 60 Hz	Environmental Conditions	29°C, 74% RH
Tested By	Loius Yang		

Antenna Polarity & Test Distance : Vertical at 3 m								
No	Frequency (MHz)	Emission Level (dBuV/m)	Limit (dBuV/m)	Margin (dB)	Antenna Height (m)	Table Angle (Degree)	Raw Value (dBuV)	Correction Factor (dB/m)
1	42.27	33.3 QP	40.0	-6.7	1.50 V	360	46.3	-13.0
2	90.29	21.2 QP	43.5	-22.3	2.00 V	360	39.8	-18.6
3	176.96	20.8 QP	43.5	-22.7	1.00 V	360	34.7	-13.9
4	244.57	17.8 QP	46.0	-28.2	2.00 V	12	31.9	-14.1
5	323.68	21.1 QP	46.0	-24.9	1.00 V	66	32.5	-11.4
6	422.68	30.3 QP	46.0	-15.7	1.50 V	144	39.1	-8.8

Remarks:

1. Emission Level(dBuV/m) = Raw Value(dBuV) + Correction Factor(dB/m)
2. Correction Factor(dB/m) = Antenna Factor(dB/m) + Cable Factor(dB) – Pre-Amplifier Factor(dB)
3. Margin value = Emission Level – Limit value
4. The other emission levels were very low against the limit of frequency range 30 MHz ~ 1 GHz.
5. The frequency range 9 kHz ~ 30 MHz: all emissions are more than 20 dB below the limit, therefore do not be recorded in this report.

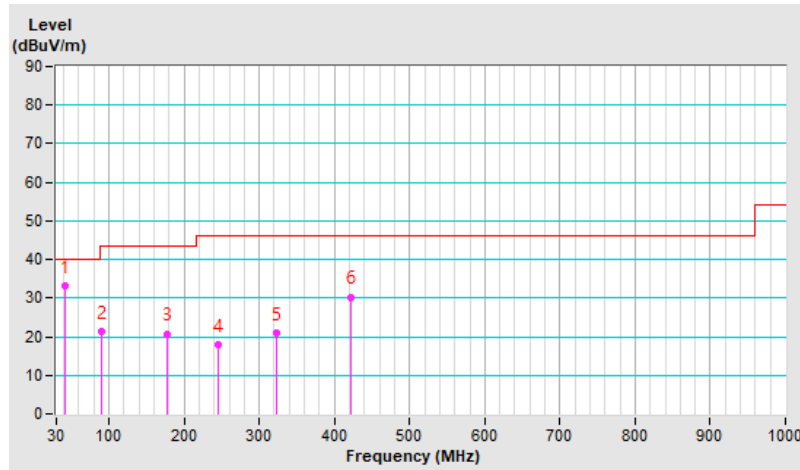

7.7 Unwanted Emissions above 1 GHz

Mode A

RF Mode	BT-LE 1M	Channel	CH 0 : 2402 MHz
Frequency Range	1 GHz ~ 25 GHz	Detector Function & Bandwidth	Peak (PK), RB = 1 MHz, VB = 3 MHz RMS (AV), RB = 1 MHz, VB = 3 MHz
Input Power (System)	120 Vac, 60 Hz	Environmental Conditions	28°C, 75% RH
Tested By	Louis Yang		

Antenna Polarity & Test Distance : Horizontal at 3 m

No	Frequency (MHz)	Emission Level (dBuV/m)	Limit (dBuV/m)	Margin (dB)	Antenna Height (m)	Table Angle (Degree)	Raw Value (dBuV)	Correction Factor (dB/m)
1	2390.00	54.5 PK	74.0	-19.5	1.00 H	332	57.2	-2.7
2	2390.00	45.1 AV	54.0	-8.9	1.00 H	332	47.8	-2.7
3	*2402.00	99.1 PK			1.00 H	332	101.8	-2.7
4	*2402.00	73.6 AV			1.00 H	332	76.3	-2.7
5	4804.00	37.5 PK	74.0	-36.5	1.03 H	340	35.9	1.6
6	4804.00	12.0 AV	54.0	-42.0	1.03 H	340	10.4	1.6

Remarks:

1. Emission Level(dBuV/m) = Raw Value(dBuV) + Correction Factor(dB/m)
2. Correction Factor(dB/m) = Antenna Factor(dB/m) + Cable Factor(dB) – Pre-Amplifier Factor(dB)
3. Margin value = Emission Level – Limit value
4. The other emission levels were very low against the limit.
5. " * " : Fundamental frequency, the limit was restricted at the RF Output Power.
6. The average value of fundamental and harmonic frequency is: Average = Peak value + 20 log(Duty cycle) Where the duty cycle correction factor is calculated from following formula:
 $20 \log(\text{Duty cycle}) = 20 \log(0.362 \text{ ms} / 6.84 \text{ ms}) = -25.5 \text{ dB}$

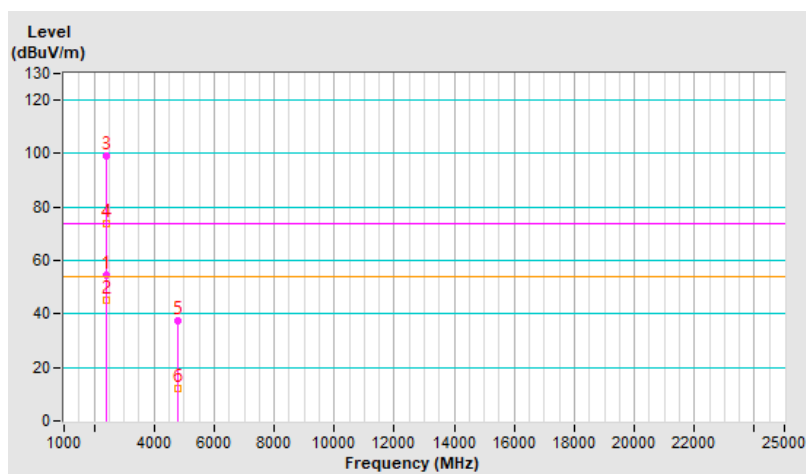

RF Mode	BT-LE 1M	Channel	CH 0 : 2402 MHz
Frequency Range	1 GHz ~ 25 GHz	Detector Function & Bandwidth	Peak (PK), RB = 1 MHz, VB = 3 MHz RMS (AV), RB = 1 MHz, VB = 3 MHz
Input Power (System)	120 Vac, 60 Hz	Environmental Conditions	28°C, 75% RH
Tested By	Louis Yang		

Antenna Polarity & Test Distance : Vertical at 3 m								
No	Frequency (MHz)	Emission Level (dBuV/m)	Limit (dBuV/m)	Margin (dB)	Antenna Height (m)	Table Angle (Degree)	Raw Value (dBuV)	Correction Factor (dB/m)
1	2390.00	53.7 PK	74.0	-20.3	1.00 V	116	56.4	-2.7
2	2390.00	44.8 AV	54.0	-9.2	1.00 V	116	47.5	-2.7
3	*2402.00	96.1 PK			1.00 V	116	98.8	-2.7
4	*2402.00	70.6 AV			1.00 V	116	73.3	-2.7
5	4804.00	43.8 PK	74.0	-30.2	1.00 V	226	42.2	1.6
6	4804.00	18.3 AV	54.0	-35.7	1.00 V	226	16.7	1.6

Remarks:

1. Emission Level(dBuV/m) = Raw Value(dBuV) + Correction Factor(dB/m)
2. Correction Factor(dB/m) = Antenna Factor(dB/m) + Cable Factor(dB) – Pre-Amplifier Factor(dB)
3. Margin value = Emission Level – Limit value
4. The other emission levels were very low against the limit.
5. " * " : Fundamental frequency, the limit was restricted at the RF Output Power.
6. The average value of fundamental and harmonic frequency is: Average = Peak value + 20 log(Duty cycle) Where the duty cycle correction factor is calculated from following formula:
 $20 \log(\text{Duty cycle}) = 20 \log(0.362 \text{ ms} / 6.84 \text{ ms}) = -25.5 \text{ dB}$

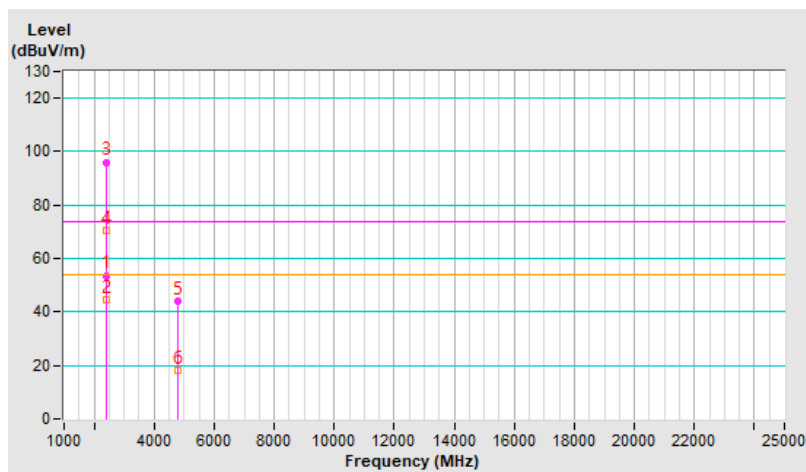

RF Mode	BT-LE 1M	Channel	CH 19 : 2440 MHz
Frequency Range	1 GHz ~ 25 GHz	Detector Function & Bandwidth	Peak (PK), RB = 1 MHz, VB = 3 MHz RMS (AV), RB = 1 MHz, VB = 3 MHz
Input Power (System)	120 Vac, 60 Hz	Environmental Conditions	28°C, 75% RH
Tested By	Louis Yang		

Antenna Polarity & Test Distance : Horizontal at 3 m								
No	Frequency (MHz)	Emission Level (dBuV/m)	Limit (dBuV/m)	Margin (dB)	Antenna Height (m)	Table Angle (Degree)	Raw Value (dBuV)	Correction Factor (dB/m)
1	*2440.00	98.6 PK			1.05 H	330	101.3	-2.7
2	*2440.00	73.1 AV			1.05 H	330	75.8	-2.7
3	4880.00	37.4 PK	74.0	-36.6	1.05 H	328	35.9	1.5
4	4880.00	11.9 AV	54.0	-42.1	1.05 H	328	10.4	1.5
5	7320.00	47.7 PK	74.0	-26.3	1.00 H	112	40.5	7.2
6	7320.00	22.2 AV	54.0	-31.8	1.00 H	112	15.0	7.2

Remarks:

1. Emission Level(dBuV/m) = Raw Value(dBuV) + Correction Factor(dB/m)
2. Correction Factor(dB/m) = Antenna Factor(dB/m) + Cable Factor(dB) – Pre-Amplifier Factor(dB)
3. Margin value = Emission Level – Limit value
4. The other emission levels were very low against the limit.
5. " * ": Fundamental frequency, the limit was restricted at the RF Output Power.
6. The average value of fundamental and harmonic frequency is: Average = Peak value + 20 log(Duty cycle) Where the duty cycle correction factor is calculated from following formula:
 $20 \log(\text{Duty cycle}) = 20 \log(0.362 \text{ ms} / 6.84 \text{ ms}) = -25.5 \text{ dB}$

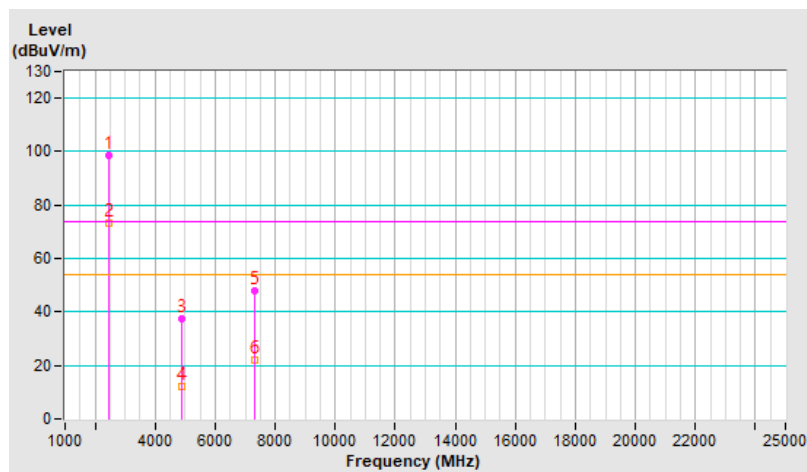

RF Mode	BT-LE 1M	Channel	CH 19 : 2440 MHz
Frequency Range	1 GHz ~ 25 GHz	Detector Function & Bandwidth	Peak (PK), RB = 1 MHz, VB = 3 MHz RMS (AV), RB = 1 MHz, VB = 3 MHz
Input Power (System)	120 Vac, 60 Hz	Environmental Conditions	28°C, 75% RH
Tested By	Louis Yang		

Antenna Polarity & Test Distance : Vertical at 3 m								
No	Frequency (MHz)	Emission Level (dBuV/m)	Limit (dBuV/m)	Margin (dB)	Antenna Height (m)	Table Angle (Degree)	Raw Value (dBuV)	Correction Factor (dB/m)
1	*2440.00	96.3 PK			1.03 V	118	99.0	-2.7
2	*2440.00	70.8 AV			1.03 V	118	73.5	-2.7
3	4880.00	42.3 PK	74.0	-31.7	1.03 V	209	40.8	1.5
4	4880.00	16.8 AV	54.0	-37.2	1.03 V	209	15.3	1.5
5	7320.00	46.9 PK	74.0	-27.1	1.08 V	200	39.7	7.2
6	7320.00	21.4 AV	54.0	-32.6	1.08 V	200	14.2	7.2

Remarks:

1. Emission Level(dBuV/m) = Raw Value(dBuV) + Correction Factor(dB/m)
2. Correction Factor(dB/m) = Antenna Factor(dB/m) + Cable Factor(dB) – Pre-Amplifier Factor(dB)
3. Margin value = Emission Level – Limit value
4. The other emission levels were very low against the limit.
5. " * " : Fundamental frequency, the limit was restricted at the RF Output Power.
6. The average value of fundamental and harmonic frequency is: Average = Peak value + 20 log(Duty cycle) Where the duty cycle correction factor is calculated from following formula:
 $20 \log(\text{Duty cycle}) = 20 \log(0.362 \text{ ms} / 6.84 \text{ ms}) = -25.5 \text{ dB}$

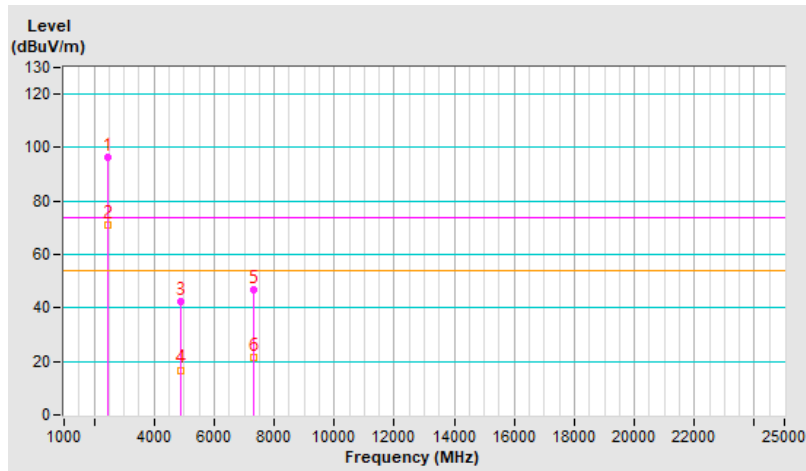

RF Mode	BT-LE 1M	Channel	CH 39 : 2480 MHz
Frequency Range	1 GHz ~ 25 GHz	Detector Function & Bandwidth	Peak (PK), RB = 1 MHz, VB = 3 MHz RMS (AV), RB = 1 MHz, VB = 3 MHz
Input Power (System)	120 Vac, 60 Hz	Environmental Conditions	28°C, 75% RH
Tested By	Louis Yang		

Antenna Polarity & Test Distance : Horizontal at 3 m								
No	Frequency (MHz)	Emission Level (dBuV/m)	Limit (dBuV/m)	Margin (dB)	Antenna Height (m)	Table Angle (Degree)	Raw Value (dBuV)	Correction Factor (dB/m)
1	*2480.00	97.5 PK			1.20 H	336	100.2	-2.7
2	*2480.00	72.0 AV			1.20 H	336	74.7	-2.7
3	2483.50	54.8 PK	74.0	-19.2	1.20 H	336	57.5	-2.7
4	2483.50	44.7 AV	54.0	-9.3	1.20 H	336	47.4	-2.7
5	4960.00	37.5 PK	74.0	-36.5	1.02 H	341	35.8	1.7
6	4960.00	12.0 AV	54.0	-42.0	1.02 H	341	10.3	1.7
7	7440.00	48.3 PK	74.0	-25.7	1.09 H	116	40.8	7.5
8	7440.00	22.8 AV	54.0	-31.2	1.09 H	116	15.3	7.5

Remarks:

1. Emission Level(dBuV/m) = Raw Value(dBuV) + Correction Factor(dB/m)
2. Correction Factor(dB/m) = Antenna Factor(dB/m) + Cable Factor(dB) – Pre-Amplifier Factor(dB)
3. Margin value = Emission Level – Limit value
4. The other emission levels were very low against the limit.
5. " * ": Fundamental frequency, the limit was restricted at the RF Output Power.
6. The average value of fundamental and harmonic frequency is: Average = Peak value + 20 log(Duty cycle) Where the duty cycle correction factor is calculated from following formula:
 $20 \log(\text{Duty cycle}) = 20 \log(0.362 \text{ ms} / 6.84 \text{ ms}) = -25.5 \text{ dB}$

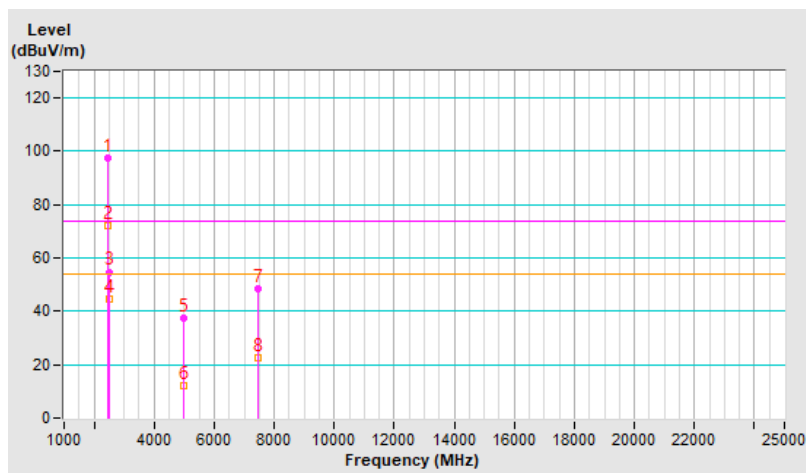

RF Mode	BT-LE 1M	Channel	CH 39 : 2480 MHz
Frequency Range	1 GHz ~ 25 GHz	Detector Function & Bandwidth	Peak (PK), RB = 1 MHz, VB = 3 MHz RMS (AV), RB = 1 MHz, VB = 3 MHz
Input Power (System)	120 Vac, 60 Hz	Environmental Conditions	28°C, 75% RH
Tested By	Louis Yang		

Antenna Polarity & Test Distance : Vertical at 3 m								
No	Frequency (MHz)	Emission Level (dBuV/m)	Limit (dBuV/m)	Margin (dB)	Antenna Height (m)	Table Angle (Degree)	Raw Value (dBuV)	Correction Factor (dB/m)
1	*2480.00	93.8 PK			1.23 V	117	96.5	-2.7
2	*2480.00	68.3 AV			1.23 V	117	71.0	-2.7
3	2483.50	55.8 PK	74.0	-18.2	1.23 V	117	58.5	-2.7
4	2483.50	44.6 AV	54.0	-9.4	1.23 V	117	47.3	-2.7
5	4960.00	43.0 PK	74.0	-31.0	1.03 V	227	41.3	1.7
6	4960.00	17.5 AV	54.0	-36.5	1.03 V	227	15.8	1.7
7	7440.00	47.6 PK	74.0	-26.4	1.15 V	220	40.1	7.5
8	7440.00	22.1 AV	54.0	-31.9	1.15 V	220	14.6	7.5

Remarks:

1. Emission Level(dBuV/m) = Raw Value(dBuV) + Correction Factor(dB/m)
2. Correction Factor(dB/m) = Antenna Factor(dB/m) + Cable Factor(dB) – Pre-Amplifier Factor(dB)
3. Margin value = Emission Level – Limit value
4. The other emission levels were very low against the limit.
5. " * ": Fundamental frequency, the limit was restricted at the RF Output Power.
6. The average value of fundamental and harmonic frequency is: Average = Peak value + 20 log(Duty cycle) Where the duty cycle correction factor is calculated from following formula:
 $20 \log(\text{Duty cycle}) = 20 \log(0.362 \text{ ms} / 6.84 \text{ ms}) = -25.5 \text{ dB}$

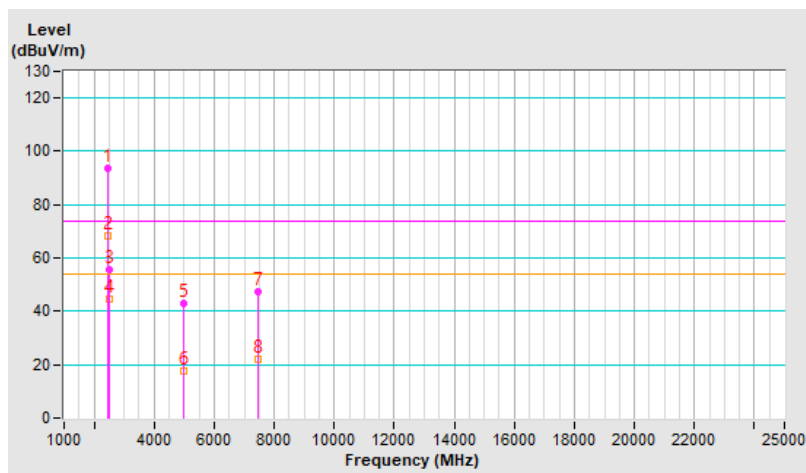

RF Mode	BT-LE 2M	Channel	CH 1 : 2404 MHz
Frequency Range	1 GHz ~ 25 GHz	Detector Function & Bandwidth	Peak (PK), RB = 1 MHz, VB = 3 MHz RMS (AV), RB = 1 MHz, VB = 3 MHz
Input Power (System)	120 Vac, 60 Hz	Environmental Conditions	28°C, 75% RH
Tested By	Louis Yang		

Antenna Polarity & Test Distance : Horizontal at 3 m								
No	Frequency (MHz)	Emission Level (dBuV/m)	Limit (dBuV/m)	Margin (dB)	Antenna Height (m)	Table Angle (Degree)	Raw Value (dBuV)	Correction Factor (dB/m)
1	2390.00	55.5 PK	74.0	-18.5	1.01 H	334	58.2	-2.7
2	2390.00	45.1 AV	54.0	-8.9	1.01 H	334	47.8	-2.7
3	*2404.00	99.3 PK			1.01 H	334	102.0	-2.7
4	*2404.00	68.0 AV			1.01 H	334	70.7	-2.7
5	4808.00	38.1 PK	74.0	-35.9	1.04 H	323	36.6	1.5
6	4808.00	6.8 AV	54.0	-47.2	1.04 H	323	5.3	1.5

Remarks:

1. Emission Level(dBuV/m) = Raw Value(dBuV) + Correction Factor(dB/m)
2. Correction Factor(dB/m) = Antenna Factor(dB/m) + Cable Factor(dB) – Pre-Amplifier Factor(dB)
3. Margin value = Emission Level – Limit value
4. The other emission levels were very low against the limit.
5. " * " : Fundamental frequency, the limit was restricted at the RF Output Power.
6. The average value of fundamental and harmonic frequency is: Average = Peak value + 20 log(Duty cycle) Where the duty cycle correction factor is calculated from following formula:
 $20 \log(\text{Duty cycle}) = 20 \log(0.187 \text{ ms} / 6.84 \text{ ms}) = -31.3 \text{ dB}$

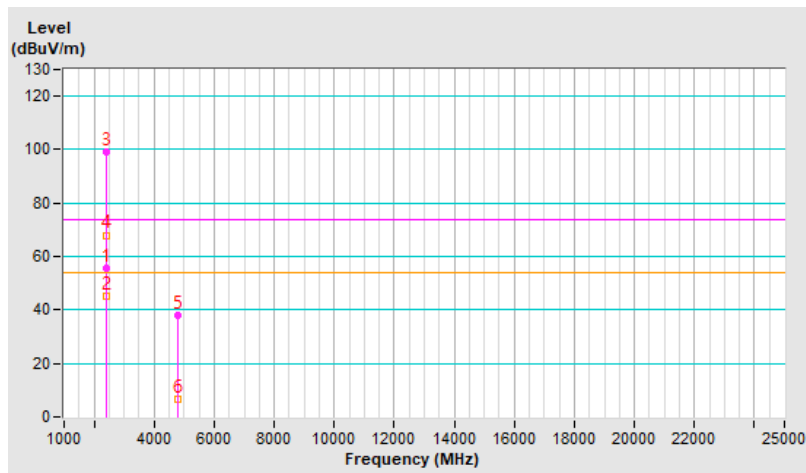

RF Mode	BT-LE 2M	Channel	CH 1 : 2404 MHz
Frequency Range	1 GHz ~ 25 GHz	Detector Function & Bandwidth	Peak (PK), RB = 1 MHz, VB = 3 MHz RMS (AV), RB = 1 MHz, VB = 3 MHz
Input Power (System)	120 Vac, 60 Hz	Environmental Conditions	28°C, 75% RH
Tested By	Louis Yang		

Antenna Polarity & Test Distance : Vertical at 3 m								
No	Frequency (MHz)	Emission Level (dBuV/m)	Limit (dBuV/m)	Margin (dB)	Antenna Height (m)	Table Angle (Degree)	Raw Value (dBuV)	Correction Factor (dB/m)
1	2390.00	54.1 PK	74.0	-19.9	1.00 V	116	56.8	-2.7
2	2390.00	45.0 AV	54.0	-9.0	1.00 V	116	47.7	-2.7
3	*2404.00	95.8 PK			1.00 V	116	98.5	-2.7
4	*2404.00	64.5 AV			1.00 V	116	67.2	-2.7
5	4808.00	42.4 PK	74.0	-31.6	1.02 V	206	40.9	1.5
6	4808.00	11.1 AV	54.0	-42.9	1.02 V	206	9.6	1.5

Remarks:

1. Emission Level(dBuV/m) = Raw Value(dBuV) + Correction Factor(dB/m)
2. Correction Factor(dB/m) = Antenna Factor(dB/m) + Cable Factor(dB) – Pre-Amplifier Factor(dB)
3. Margin value = Emission Level – Limit value
4. The other emission levels were very low against the limit.
5. " * " : Fundamental frequency, the limit was restricted at the RF Output Power.
6. The average value of fundamental and harmonic frequency is: Average = Peak value + 20 log(Duty cycle) Where the duty cycle correction factor is calculated from following formula:
 $20 \log(\text{Duty cycle}) = 20 \log(0.187 \text{ ms} / 6.84 \text{ ms}) = -31.3 \text{ dB}$

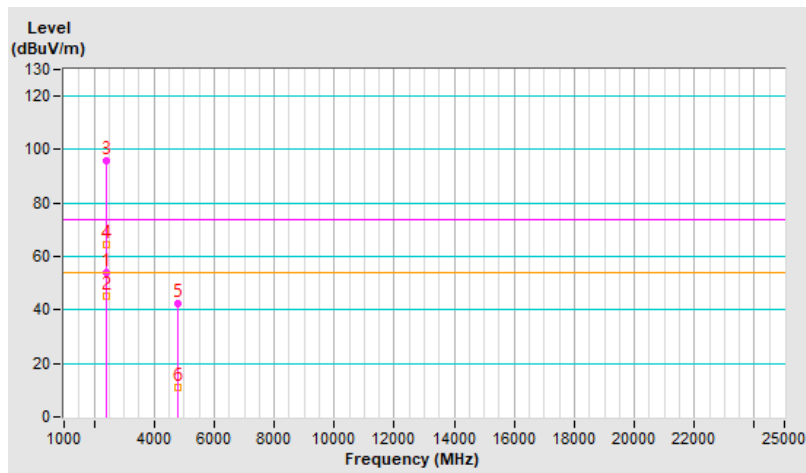

RF Mode	BT-LE 2M	Channel	CH 19 : 2440 MHz
Frequency Range	1 GHz ~ 25 GHz	Detector Function & Bandwidth	Peak (PK), RB = 1 MHz, VB = 3 MHz RMS (AV), RB = 1 MHz, VB = 3 MHz
Input Power (System)	120 Vac, 60 Hz	Environmental Conditions	28°C, 75% RH
Tested By	Louis Yang		

Antenna Polarity & Test Distance : Horizontal at 3 m								
No	Frequency (MHz)	Emission Level (dBuV/m)	Limit (dBuV/m)	Margin (dB)	Antenna Height (m)	Table Angle (Degree)	Raw Value (dBuV)	Correction Factor (dB/m)
1	*2440.00	98.9 PK			1.03 H	328	101.6	-2.7
2	*2440.00	67.6 AV			1.03 H	328	70.3	-2.7
3	4880.00	37.9 PK	74.0	-36.1	1.04 H	328	36.4	1.5
4	4880.00	6.6 AV	54.0	-47.4	1.04 H	328	5.1	1.5
5	7320.00	48.5 PK	74.0	-25.5	1.05 H	104	41.3	7.2
6	7320.00	17.2 AV	54.0	-36.8	1.05 H	104	10.0	7.2

Remarks:

1. Emission Level(dBuV/m) = Raw Value(dBuV) + Correction Factor(dB/m)
2. Correction Factor(dB/m) = Antenna Factor(dB/m) + Cable Factor(dB) – Pre-Amplifier Factor(dB)
3. Margin value = Emission Level – Limit value
4. The other emission levels were very low against the limit.
5. " * ": Fundamental frequency, the limit was restricted at the RF Output Power.
6. The average value of fundamental and harmonic frequency is: Average = Peak value + 20 log(Duty cycle) Where the duty cycle correction factor is calculated from following formula:
 $20 \log(\text{Duty cycle}) = 20 \log(0.187 \text{ ms} / 6.84 \text{ ms}) = -31.3 \text{ dB}$

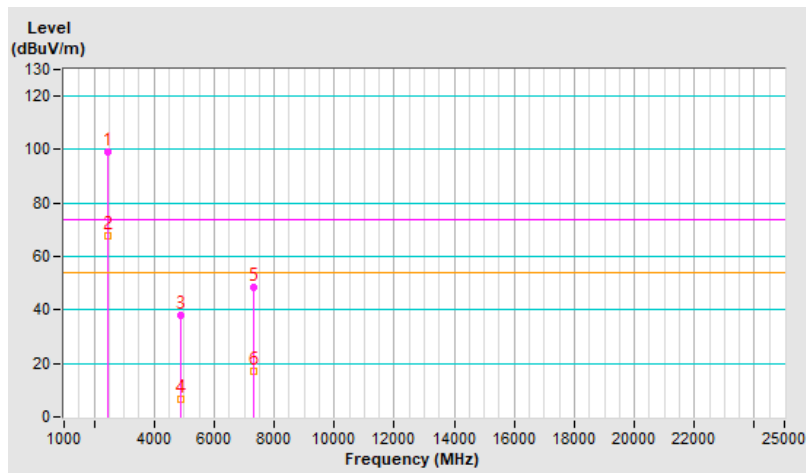

RF Mode	BT-LE 2M	Channel	CH 19 : 2440 MHz
Frequency Range	1 GHz ~ 25 GHz	Detector Function & Bandwidth	Peak (PK), RB = 1 MHz, VB = 3 MHz RMS (AV), RB = 1 MHz, VB = 3 MHz
Input Power (System)	120 Vac, 60 Hz	Environmental Conditions	28°C, 75% RH
Tested By	Louis Yang		

Antenna Polarity & Test Distance : Vertical at 3 m								
No	Frequency (MHz)	Emission Level (dBuV/m)	Limit (dBuV/m)	Margin (dB)	Antenna Height (m)	Table Angle (Degree)	Raw Value (dBuV)	Correction Factor (dB/m)
1	*2440.00	96.2 PK			1.00 V	128	98.9	-2.7
2	*2440.00	64.9 AV			1.00 V	128	67.6	-2.7
3	4880.00	42.8 PK	74.0	-31.2	1.04 V	208	41.3	1.5
4	4880.00	11.5 AV	54.0	-42.5	1.04 V	208	10.0	1.5
5	7320.00	47.5 PK	74.0	-26.5	1.18 V	208	40.3	7.2
6	7320.00	16.2 AV	54.0	-37.8	1.18 V	208	9.0	7.2

Remarks:

1. Emission Level(dBuV/m) = Raw Value(dBuV) + Correction Factor(dB/m)
2. Correction Factor(dB/m) = Antenna Factor(dB/m) + Cable Factor(dB) – Pre-Amplifier Factor(dB)
3. Margin value = Emission Level – Limit value
4. The other emission levels were very low against the limit.
5. " * " : Fundamental frequency, the limit was restricted at the RF Output Power.
6. The average value of fundamental and harmonic frequency is: Average = Peak value + 20 log(Duty cycle) Where the duty cycle correction factor is calculated from following formula:
 $20 \log(\text{Duty cycle}) = 20 \log(0.187 \text{ ms} / 6.84 \text{ ms}) = -31.3 \text{ dB}$

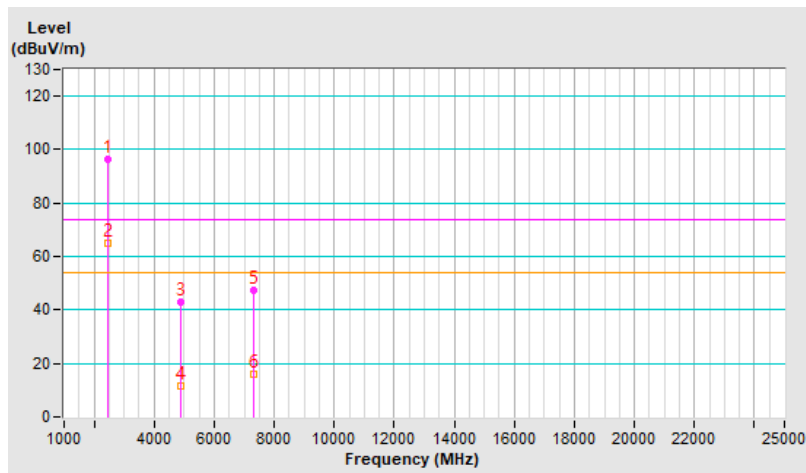

RF Mode	BT-LE 2M	Channel	CH 38 : 2478 MHz
Frequency Range	1 GHz ~ 25 GHz	Detector Function & Bandwidth	Peak (PK), RB = 1 MHz, VB = 3 MHz RMS (AV), RB = 1 MHz, VB = 3 MHz
Input Power (System)	120 Vac, 60 Hz	Environmental Conditions	28°C, 75% RH
Tested By	Louis Yang		

Antenna Polarity & Test Distance : Horizontal at 3 m								
No	Frequency (MHz)	Emission Level (dBuV/m)	Limit (dBuV/m)	Margin (dB)	Antenna Height (m)	Table Angle (Degree)	Raw Value (dBuV)	Correction Factor (dB/m)
1	*2478.00	97.7 PK			1.23 H	338	100.4	-2.7
2	*2478.00	66.4 AV			1.23 H	338	69.1	-2.7
3	2483.50	55.7 PK	74.0	-18.3	1.23 H	338	58.4	-2.7
4	2483.50	45.9 AV	54.0	-8.1	1.23 H	338	48.6	-2.7
5	4956.00	37.7 PK	74.0	-36.3	1.03 H	343	36.0	1.7
6	4956.00	6.4 AV	54.0	-47.6	1.03 H	343	4.7	1.7
7	7434.00	47.8 PK	74.0	-26.2	1.05 H	108	40.4	7.4
8	7434.00	16.5 AV	54.0	-37.5	1.05 H	108	9.1	7.4

Remarks:

1. Emission Level(dBuV/m) = Raw Value(dBuV) + Correction Factor(dB/m)
2. Correction Factor(dB/m) = Antenna Factor(dB/m) + Cable Factor(dB) – Pre-Amplifier Factor(dB)
3. Margin value = Emission Level – Limit value
4. The other emission levels were very low against the limit.
5. " * ": Fundamental frequency, the limit was restricted at the RF Output Power.
6. The average value of fundamental and harmonic frequency is: Average = Peak value + 20 log(Duty cycle) Where the duty cycle correction factor is calculated from following formula:
 $20 \log(\text{Duty cycle}) = 20 \log(0.187 \text{ ms} / 6.84 \text{ ms}) = -31.3 \text{ dB}$

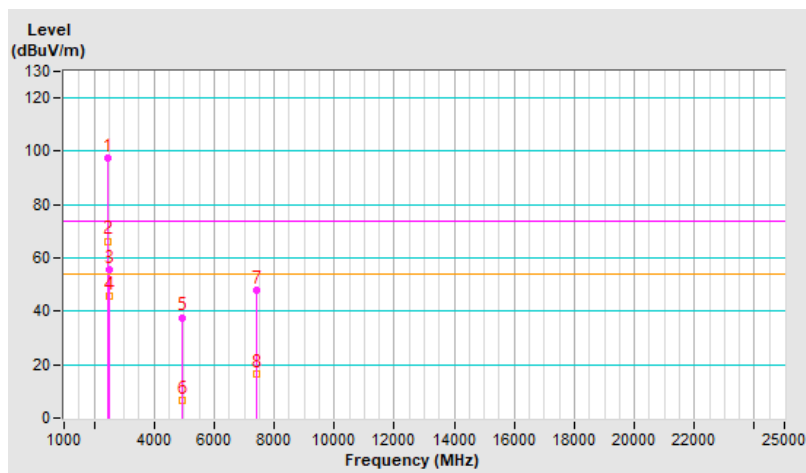

RF Mode	BT-LE 2M	Channel	CH 38 : 2478 MHz
Frequency Range	1 GHz ~ 25 GHz	Detector Function & Bandwidth	Peak (PK), RB = 1 MHz, VB = 3 MHz RMS (AV), RB = 1 MHz, VB = 3 MHz
Input Power (System)	120 Vac, 60 Hz	Environmental Conditions	28°C, 75% RH
Tested By	Louis Yang		

Antenna Polarity & Test Distance : Vertical at 3 m								
No	Frequency (MHz)	Emission Level (dBuV/m)	Limit (dBuV/m)	Margin (dB)	Antenna Height (m)	Table Angle (Degree)	Raw Value (dBuV)	Correction Factor (dB/m)
1	*2478.00	94.0 PK			1.21 V	115	96.7	-2.7
2	*2478.00	62.7 AV			1.21 V	115	65.4	-2.7
3	2483.50	54.6 PK	74.0	-19.4	1.21 V	115	57.3	-2.7
4	2483.50	44.8 AV	54.0	-9.2	1.21 V	115	47.5	-2.7
5	4956.00	42.9 PK	74.0	-31.1	1.00 V	223	41.2	1.7
6	4956.00	11.6 AV	54.0	-42.4	1.00 V	223	9.9	1.7
7	7434.00	47.2 PK	74.0	-26.8	1.17 V	202	39.8	7.4
8	7434.00	15.9 AV	54.0	-38.1	1.17 V	202	8.5	7.4

Remarks:

1. Emission Level(dBuV/m) = Raw Value(dBuV) + Correction Factor(dB/m)
2. Correction Factor(dB/m) = Antenna Factor(dB/m) + Cable Factor(dB) – Pre-Amplifier Factor(dB)
3. Margin value = Emission Level – Limit value
4. The other emission levels were very low against the limit.
5. " * ": Fundamental frequency, the limit was restricted at the RF Output Power.
6. The average value of fundamental and harmonic frequency is: Average = Peak value + 20 log(Duty cycle) Where the duty cycle correction factor is calculated from following formula:
 $20 \log(\text{Duty cycle}) = 20 \log(0.187 \text{ ms} / 6.84 \text{ ms}) = -31.3 \text{ dB}$

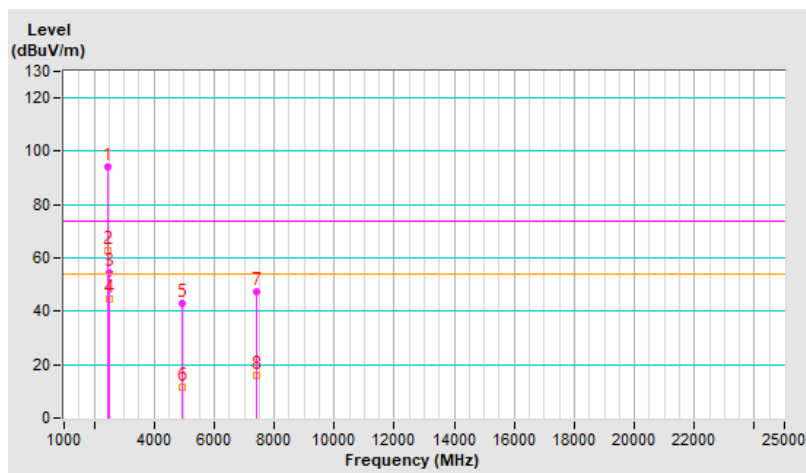

Mode B

RF Mode	BT-LE 1M	Channel	CH 0 : 2402 MHz
Frequency Range	1 GHz ~ 25 GHz	Detector Function & Bandwidth	Peak (PK), RB = 1 MHz, VB = 3 MHz RMS (AV), RB = 1 MHz, VB = 3 MHz
Input Power (System)	120 Vac, 60 Hz	Environmental Conditions	28°C, 75% RH
Tested By	Louis Yang		

Antenna Polarity & Test Distance : Horizontal at 3 m								
No	Frequency (MHz)	Emission Level (dBuV/m)	Limit (dBuV/m)	Margin (dB)	Antenna Height (m)	Table Angle (Degree)	Raw Value (dBuV)	Correction Factor (dB/m)
1	2390.00	55.0 PK	74.0	-19.0	2.53 H	338	57.7	-2.7
2	2390.00	45.0 AV	54.0	-9.0	2.53 H	338	47.7	-2.7
3	*2402.00	97.7 PK			2.53 H	338	100.4	-2.7
4	*2402.00	72.2 AV			2.53 H	338	74.9	-2.7
5	4804.00	42.7 PK	74.0	-31.3	1.01 H	322	41.1	1.6
6	4804.00	17.2 AV	54.0	-36.8	1.01 H	322	15.6	1.6

Remarks:

- Emission Level(dBuV/m) = Raw Value(dBuV) + Correction Factor(dB/m)
- Correction Factor(dB/m) = Antenna Factor(dB/m) + Cable Factor(dB) – Pre-Amplifier Factor(dB)
- Margin value = Emission Level – Limit value
- The other emission levels were very low against the limit.
- " * ": Fundamental frequency, the limit was restricted at the RF Output Power.
- The average value of fundamental and harmonic frequency is: Average = Peak value + 20 log(Duty cycle) Where the duty cycle correction factor is calculated from following formula:
 $20 \log(\text{Duty cycle}) = 20 \log(0.364 \text{ ms} / 6.848 \text{ ms}) = -25.5 \text{ dB}$

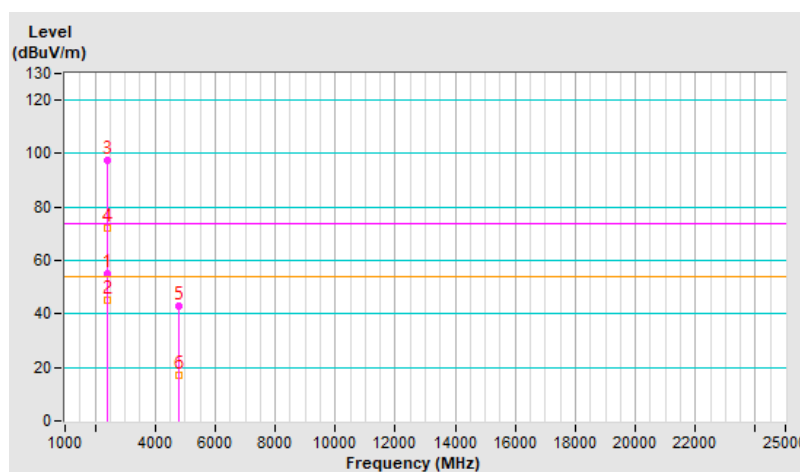

RF Mode	BT-LE 1M	Channel	CH 0 : 2402 MHz
Frequency Range	1 GHz ~ 25 GHz	Detector Function & Bandwidth	Peak (PK), RB = 1 MHz, VB = 3 MHz RMS (AV), RB = 1 MHz, VB = 3 MHz
Input Power (System)	120 Vac, 60 Hz	Environmental Conditions	28°C, 75% RH
Tested By	Louis Yang		

Antenna Polarity & Test Distance : Vertical at 3 m								
No	Frequency (MHz)	Emission Level (dBuV/m)	Limit (dBuV/m)	Margin (dB)	Antenna Height (m)	Table Angle (Degree)	Raw Value (dBuV)	Correction Factor (dB/m)
1	2390.00	54.5 PK	74.0	-19.5	1.00 V	113	57.2	-2.7
2	2390.00	44.9 AV	54.0	-9.1	1.00 V	113	47.6	-2.7
3	*2402.00	97.3 PK			1.00 V	113	100.0	-2.7
4	*2402.00	71.8 AV			1.00 V	113	74.5	-2.7
5	4804.00	43.1 PK	74.0	-30.9	1.09 V	228	41.5	1.6
6	4804.00	17.6 AV	54.0	-36.4	1.09 V	228	16.0	1.6

Remarks:

1. Emission Level(dBuV/m) = Raw Value(dBuV) + Correction Factor(dB/m)
2. Correction Factor(dB/m) = Antenna Factor(dB/m) + Cable Factor(dB) – Pre-Amplifier Factor(dB)
3. Margin value = Emission Level – Limit value
4. The other emission levels were very low against the limit.
5. " * " : Fundamental frequency, the limit was restricted at the RF Output Power.
6. The average value of fundamental and harmonic frequency is: Average = Peak value + 20 log(Duty cycle) Where the duty cycle correction factor is calculated from following formula:
 $20 \log(\text{Duty cycle}) = 20 \log(0.364 \text{ ms} / 6.848 \text{ ms}) = -25.5 \text{ dB}$

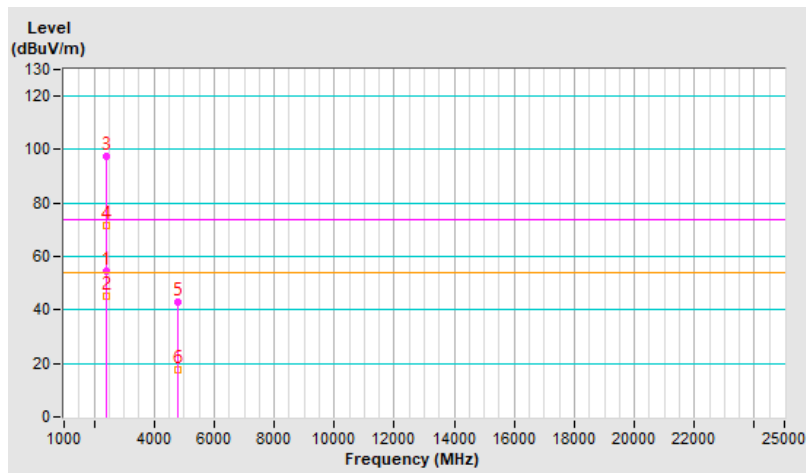

RF Mode	BT-LE 1M	Channel	CH 19 : 2440 MHz
Frequency Range	1 GHz ~ 25 GHz	Detector Function & Bandwidth	Peak (PK), RB = 1 MHz, VB = 3 MHz RMS (AV), RB = 1 MHz, VB = 3 MHz
Input Power (System)	120 Vac, 60 Hz	Environmental Conditions	28°C, 75% RH
Tested By	Louis Yang		

Antenna Polarity & Test Distance : Horizontal at 3 m								
No	Frequency (MHz)	Emission Level (dBuV/m)	Limit (dBuV/m)	Margin (dB)	Antenna Height (m)	Table Angle (Degree)	Raw Value (dBuV)	Correction Factor (dB/m)
1	*2440.00	97.4 PK			2.55 H	353	100.1	-2.7
2	*2440.00	71.9 AV			2.55 H	353	74.6	-2.7
3	4880.00	42.6 PK	74.0	-31.4	1.04 H	312	41.1	1.5
4	4880.00	17.1 AV	54.0	-36.9	1.04 H	312	15.6	1.5
5	7320.00	43.7 PK	74.0	-30.3	1.09 H	102	36.5	7.2
6	7320.00	18.2 AV	54.0	-35.8	1.09 H	102	11.0	7.2

Remarks:

1. Emission Level(dBuV/m) = Raw Value(dBuV) + Correction Factor(dB/m)
2. Correction Factor(dB/m) = Antenna Factor(dB/m) + Cable Factor(dB) – Pre-Amplifier Factor(dB)
3. Margin value = Emission Level – Limit value
4. The other emission levels were very low against the limit.
5. " * " : Fundamental frequency, the limit was restricted at the RF Output Power.
6. The average value of fundamental and harmonic frequency is: Average = Peak value + 20 log(Duty cycle) Where the duty cycle correction factor is calculated from following formula:
 $20 \log(\text{Duty cycle}) = 20 \log(0.364 \text{ ms} / 6.848 \text{ ms}) = -25.5 \text{ dB}$

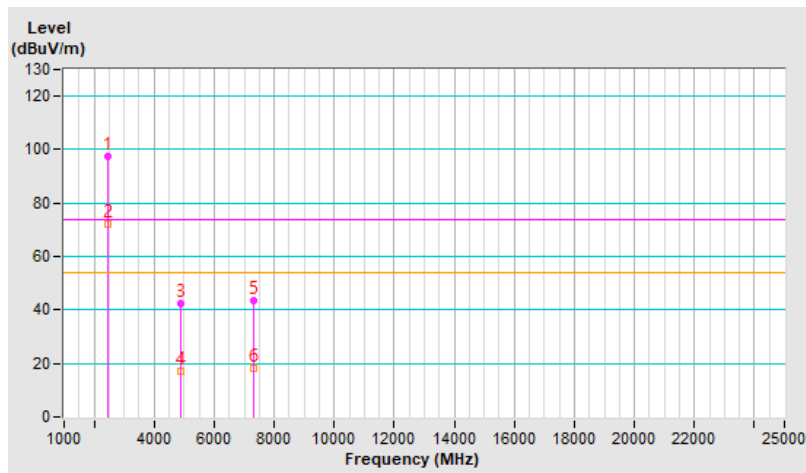

RF Mode	BT-LE 1M	Channel	CH 19 : 2440 MHz
Frequency Range	1 GHz ~ 25 GHz	Detector Function & Bandwidth	Peak (PK), RB = 1 MHz, VB = 3 MHz RMS (AV), RB = 1 MHz, VB = 3 MHz
Input Power (System)	120 Vac, 60 Hz	Environmental Conditions	28°C, 75% RH
Tested By	Louis Yang		

Antenna Polarity & Test Distance : Vertical at 3 m								
No	Frequency (MHz)	Emission Level (dBuV/m)	Limit (dBuV/m)	Margin (dB)	Antenna Height (m)	Table Angle (Degree)	Raw Value (dBuV)	Correction Factor (dB/m)
1	*2440.00	96.9 PK			1.02 V	102	99.6	-2.7
2	*2440.00	71.4 AV			1.02 V	102	74.1	-2.7
3	4880.00	43.8 PK	74.0	-30.2	1.12 V	212	42.3	1.5
4	4880.00	18.3 AV	54.0	-35.7	1.12 V	212	16.8	1.5
5	7320.00	47.1 PK	74.0	-26.9	1.10 V	148	39.9	7.2
6	7320.00	21.6 AV	54.0	-32.4	1.10 V	148	14.4	7.2

Remarks:

1. Emission Level(dBuV/m) = Raw Value(dBuV) + Correction Factor(dB/m)
2. Correction Factor(dB/m) = Antenna Factor(dB/m) + Cable Factor(dB) – Pre-Amplifier Factor(dB)
3. Margin value = Emission Level – Limit value
4. The other emission levels were very low against the limit.
5. " * ": Fundamental frequency, the limit was restricted at the RF Output Power.
6. The average value of fundamental and harmonic frequency is: Average = Peak value + 20 log(Duty cycle) Where the duty cycle correction factor is calculated from following formula:
 $20 \log(\text{Duty cycle}) = 20 \log(0.364 \text{ ms} / 6.848 \text{ ms}) = -25.5 \text{ dB}$

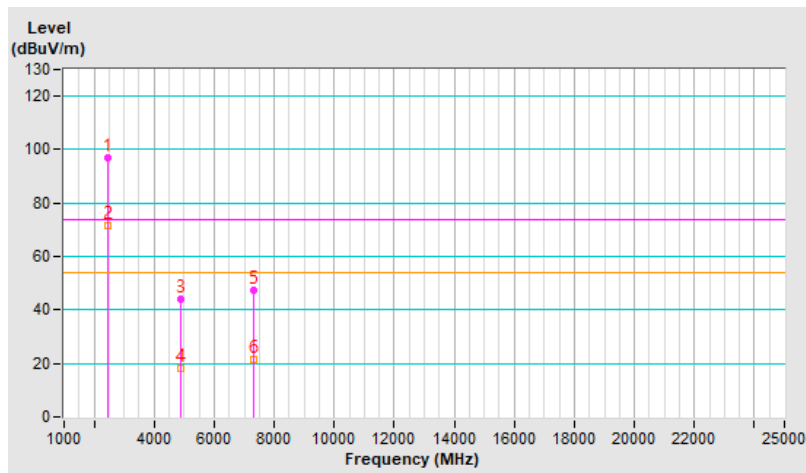

RF Mode	BT-LE 1M	Channel	CH 39 : 2480 MHz
Frequency Range	1 GHz ~ 25 GHz	Detector Function & Bandwidth	Peak (PK), RB = 1 MHz, VB = 3 MHz RMS (AV), RB = 1 MHz, VB = 3 MHz
Input Power (System)	120 Vac, 60 Hz	Environmental Conditions	28°C, 75% RH
Tested By	Louis Yang		

Antenna Polarity & Test Distance : Horizontal at 3 m								
No	Frequency (MHz)	Emission Level (dBuV/m)	Limit (dBuV/m)	Margin (dB)	Antenna Height (m)	Table Angle (Degree)	Raw Value (dBuV)	Correction Factor (dB/m)
1	*2480.00	101.1 PK			1.00 H	339	103.8	-2.7
2	*2480.00	75.6 AV			1.00 H	339	78.3	-2.7
3	2483.50	54.4 PK	74.0	-19.6	1.00 H	339	57.1	-2.7
4	2483.50	45.4 AV	54.0	-8.6	1.00 H	339	48.1	-2.7
5	4960.00	55.0 PK	74.0	-19.0	1.04 H	335	53.3	1.7
6	4960.00	29.5 AV	54.0	-24.5	1.04 H	335	27.8	1.7
7	7440.00	43.2 PK	74.0	-30.8	1.00 H	90	35.7	7.5
8	7440.00	17.7 AV	54.0	-36.3	1.00 H	90	10.2	7.5

Remarks:

1. Emission Level(dBuV/m) = Raw Value(dBuV) + Correction Factor(dB/m)
2. Correction Factor(dB/m) = Antenna Factor(dB/m) + Cable Factor(dB) – Pre-Amplifier Factor(dB)
3. Margin value = Emission Level – Limit value
4. The other emission levels were very low against the limit.
5. " * ": Fundamental frequency, the limit was restricted at the RF Output Power.
6. The average value of fundamental and harmonic frequency is: Average = Peak value + 20 log(Duty cycle) Where the duty cycle correction factor is calculated from following formula:
 $20 \log(\text{Duty cycle}) = 20 \log(0.364 \text{ ms} / 6.848 \text{ ms}) = -25.5 \text{ dB}$

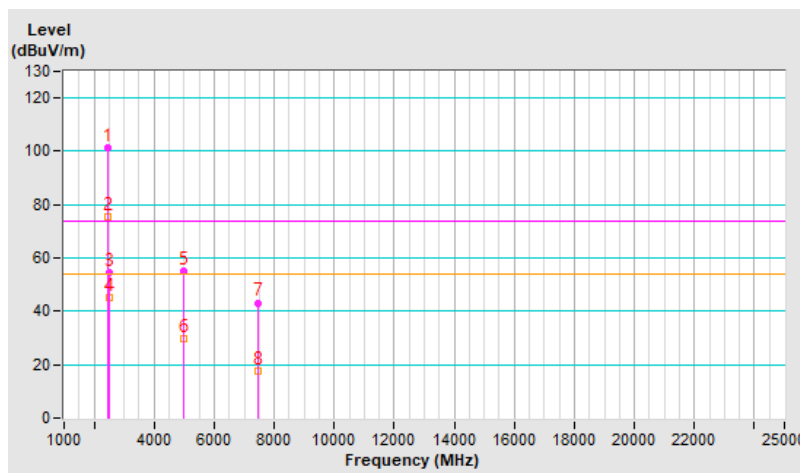

RF Mode	BT-LE 1M	Channel	CH 39 : 2480 MHz
Frequency Range	1 GHz ~ 25 GHz	Detector Function & Bandwidth	Peak (PK), RB = 1 MHz, VB = 3 MHz RMS (AV), RB = 1 MHz, VB = 3 MHz
Input Power (System)	120 Vac, 60 Hz	Environmental Conditions	28°C, 75% RH
Tested By	Louis Yang		

Antenna Polarity & Test Distance : Vertical at 3 m								
No	Frequency (MHz)	Emission Level (dBuV/m)	Limit (dBuV/m)	Margin (dB)	Antenna Height (m)	Table Angle (Degree)	Raw Value (dBuV)	Correction Factor (dB/m)
1	*2480.00	90.3 PK			1.03 V	117	93.0	-2.7
2	*2480.00	64.8 AV			1.03 V	117	67.5	-2.7
3	2483.50	55.7 PK	74.0	-18.3	1.03 V	117	58.4	-2.7
4	2483.50	44.8 AV	54.0	-9.2	1.03 V	117	47.5	-2.7
5	4960.00	43.6 PK	74.0	-30.4	1.12 V	225	41.9	1.7
6	4960.00	18.1 AV	54.0	-35.9	1.12 V	225	16.4	1.7
7	7440.00	47.1 PK	74.0	-26.9	1.06 V	161	39.6	7.5
8	7440.00	21.6 AV	54.0	-32.4	1.06 V	161	14.1	7.5

Remarks:

- Emission Level(dBuV/m) = Raw Value(dBuV) + Correction Factor(dB/m)
- Correction Factor(dB/m) = Antenna Factor(dB/m) + Cable Factor(dB) – Pre-Amplifier Factor(dB)
- Margin value = Emission Level – Limit value
- The other emission levels were very low against the limit.
- " * ": Fundamental frequency, the limit was restricted at the RF Output Power.
- The average value of fundamental and harmonic frequency is: Average = Peak value + 20 log(Duty cycle) Where the duty cycle correction factor is calculated from following formula:
 $20 \log(\text{Duty cycle}) = 20 \log(0.364 \text{ ms} / 6.848 \text{ ms}) = -25.5 \text{ dB}$

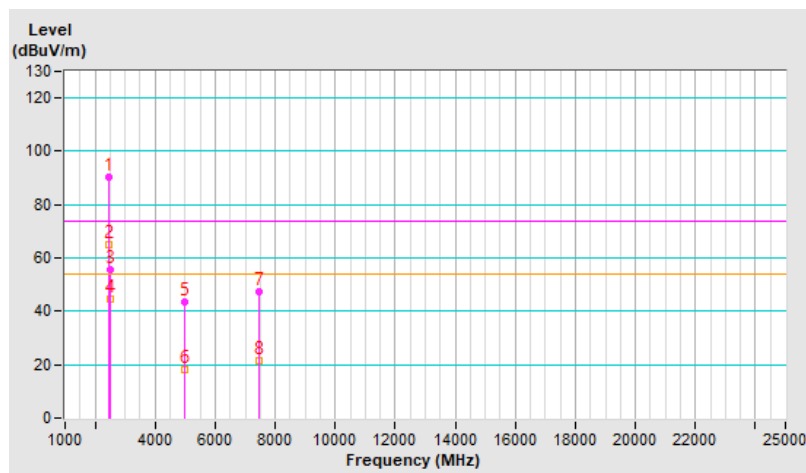

RF Mode	BT-LE 2M	Channel	CH 1 : 2404 MHz
Frequency Range	1 GHz ~ 25 GHz	Detector Function & Bandwidth	Peak (PK), RB = 1 MHz, VB = 3 MHz RMS (AV), RB = 1 MHz, VB = 3 MHz
Input Power (System)	120 Vac, 60 Hz	Environmental Conditions	28°C, 75% RH
Tested By	Louis Yang		

Antenna Polarity & Test Distance : Horizontal at 3 m								
No	Frequency (MHz)	Emission Level (dBuV/m)	Limit (dBuV/m)	Margin (dB)	Antenna Height (m)	Table Angle (Degree)	Raw Value (dBuV)	Correction Factor (dB/m)
1	2390.00	55.3 PK	74.0	-18.7	1.04 H	83	58.0	-2.7
2	2390.00	44.5 AV	54.0	-9.5	1.04 H	83	47.2	-2.7
3	*2404.00	98.7 PK			1.04 H	83	101.4	-2.7
4	*2404.00	67.5 AV			1.04 H	83	70.2	-2.7
5	4808.00	43.2 PK	74.0	-30.8	1.02 H	339	41.7	1.5
6	4808.00	12.0 AV	54.0	-42.0	1.02 H	339	10.5	1.5

Remarks:

1. Emission Level(dBuV/m) = Raw Value(dBuV) + Correction Factor(dB/m)
2. Correction Factor(dB/m) = Antenna Factor(dB/m) + Cable Factor(dB) – Pre-Amplifier Factor(dB)
3. Margin value = Emission Level – Limit value
4. The other emission levels were very low against the limit.
5. " * " : Fundamental frequency, the limit was restricted at the RF Output Power.
6. The average value of fundamental and harmonic frequency is: Average = Peak value + 20 log(Duty cycle) Where the duty cycle correction factor is calculated from following formula:
 $20 \log(\text{Duty cycle}) = 20 \log(0.188 \text{ ms} / 6.827 \text{ ms}) = -31.2 \text{ dB}$

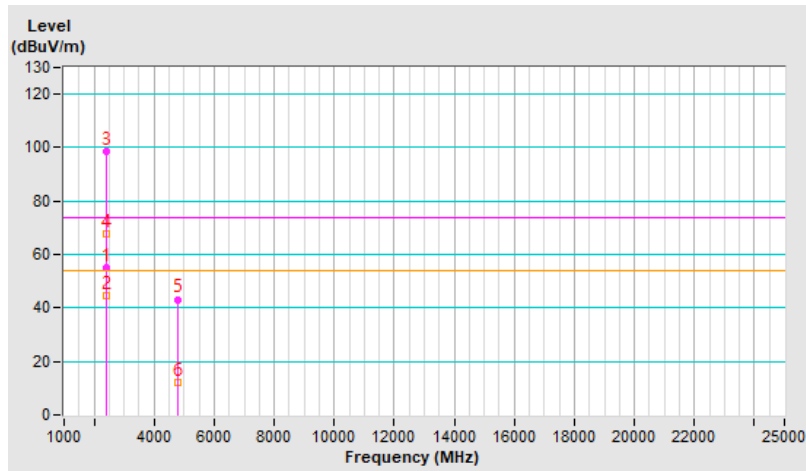

RF Mode	BT-LE 2M	Channel	CH 1 : 2404 MHz
Frequency Range	1 GHz ~ 25 GHz	Detector Function & Bandwidth	Peak (PK), RB = 1 MHz, VB = 3 MHz RMS (AV), RB = 1 MHz, VB = 3 MHz
Input Power (System)	120 Vac, 60 Hz	Environmental Conditions	28°C, 75% RH
Tested By	Louis Yang		

Antenna Polarity & Test Distance : Vertical at 3 m								
No	Frequency (MHz)	Emission Level (dBuV/m)	Limit (dBuV/m)	Margin (dB)	Antenna Height (m)	Table Angle (Degree)	Raw Value (dBuV)	Correction Factor (dB/m)
1	2390.00	54.0 PK	74.0	-20.0	1.00 V	114	56.7	-2.7
2	2390.00	44.5 AV	54.0	-9.5	1.00 V	114	47.2	-2.7
3	*2404.00	96.9 PK			1.00 V	114	99.6	-2.7
4	*2404.00	65.7 AV			1.00 V	114	68.4	-2.7
5	4808.00	44.1 PK	74.0	-29.9	1.10 V	215	42.6	1.5
6	4808.00	12.9 AV	54.0	-41.1	1.10 V	215	11.4	1.5

Remarks:

1. Emission Level(dBuV/m) = Raw Value(dBuV) + Correction Factor(dB/m)
2. Correction Factor(dB/m) = Antenna Factor(dB/m) + Cable Factor(dB) – Pre-Amplifier Factor(dB)
3. Margin value = Emission Level – Limit value
4. The other emission levels were very low against the limit.
5. " * " : Fundamental frequency, the limit was restricted at the RF Output Power.
6. The average value of fundamental and harmonic frequency is: Average = Peak value + 20 log(Duty cycle) Where the duty cycle correction factor is calculated from following formula:
 $20 \log(\text{Duty cycle}) = 20 \log(0.188 \text{ ms} / 6.827 \text{ ms}) = -31.2 \text{ dB}$

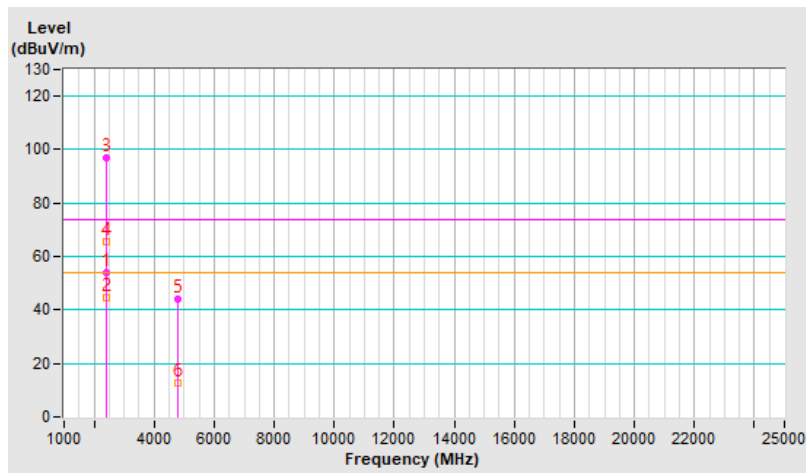

RF Mode	BT-LE 2M	Channel	CH 19 : 2440 MHz
Frequency Range	1 GHz ~ 25 GHz	Detector Function & Bandwidth	Peak (PK), RB = 1 MHz, VB = 3 MHz RMS (AV), RB = 1 MHz, VB = 3 MHz
Input Power (System)	120 Vac, 60 Hz	Environmental Conditions	28°C, 75% RH
Tested By	Louis Yang		

Antenna Polarity & Test Distance : Horizontal at 3 m								
No	Frequency (MHz)	Emission Level (dBuV/m)	Limit (dBuV/m)	Margin (dB)	Antenna Height (m)	Table Angle (Degree)	Raw Value (dBuV)	Correction Factor (dB/m)
1	*2440.00	98.7 PK			1.06 H	78	101.4	-2.7
2	*2440.00	67.5 AV			1.06 H	78	70.2	-2.7
3	4880.00	42.5 PK	74.0	-31.5	1.03 H	343	41.0	1.5
4	4880.00	11.3 AV	54.0	-42.7	1.03 H	343	9.8	1.5
5	7320.00	43.5 PK	74.0	-30.5	1.00 H	82	36.3	7.2
6	7320.00	12.3 AV	54.0	-41.7	1.00 H	82	5.1	7.2

Remarks:

1. Emission Level(dBuV/m) = Raw Value(dBuV) + Correction Factor(dB/m)
2. Correction Factor(dB/m) = Antenna Factor(dB/m) + Cable Factor(dB) – Pre-Amplifier Factor(dB)
3. Margin value = Emission Level – Limit value
4. The other emission levels were very low against the limit.
5. " * ": Fundamental frequency, the limit was restricted at the RF Output Power.
6. The average value of fundamental and harmonic frequency is: Average = Peak value + 20 log(Duty cycle) Where the duty cycle correction factor is calculated from following formula:
 $20 \log(\text{Duty cycle}) = 20 \log(0.188 \text{ ms} / 6.827 \text{ ms}) = -31.2 \text{ dB}$

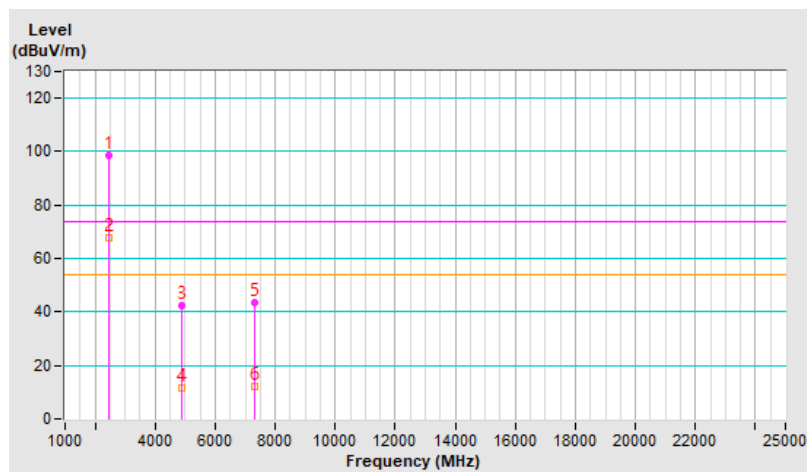

RF Mode	BT-LE 2M	Channel	CH 19 : 2440 MHz
Frequency Range	1 GHz ~ 25 GHz	Detector Function & Bandwidth	Peak (PK), RB = 1 MHz, VB = 3 MHz RMS (AV), RB = 1 MHz, VB = 3 MHz
Input Power (System)	120 Vac, 60 Hz	Environmental Conditions	28°C, 75% RH
Tested By	Louis Yang		

Antenna Polarity & Test Distance : Vertical at 3 m								
No	Frequency (MHz)	Emission Level (dBuV/m)	Limit (dBuV/m)	Margin (dB)	Antenna Height (m)	Table Angle (Degree)	Raw Value (dBuV)	Correction Factor (dB/m)
1	*2440.00	96.9 PK			1.02 V	108	99.6	-2.7
2	*2440.00	65.7 AV			1.02 V	108	68.4	-2.7
3	4880.00	44.0 PK	74.0	-30.0	1.15 V	199	42.5	1.5
4	4880.00	12.8 AV	54.0	-41.2	1.15 V	199	11.3	1.5
5	7320.00	47.1 PK	74.0	-26.9	1.11 V	150	39.9	7.2
6	7320.00	15.9 AV	54.0	-38.1	1.11 V	150	8.7	7.2

Remarks:

1. Emission Level(dBuV/m) = Raw Value(dBuV) + Correction Factor(dB/m)
2. Correction Factor(dB/m) = Antenna Factor(dB/m) + Cable Factor(dB) – Pre-Amplifier Factor(dB)
3. Margin value = Emission Level – Limit value
4. The other emission levels were very low against the limit.
5. " * ": Fundamental frequency, the limit was restricted at the RF Output Power.
6. The average value of fundamental and harmonic frequency is: Average = Peak value + 20 log(Duty cycle) Where the duty cycle correction factor is calculated from following formula:
 $20 \log(\text{Duty cycle}) = 20 \log(0.188 \text{ ms} / 6.827 \text{ ms}) = -31.2 \text{ dB}$

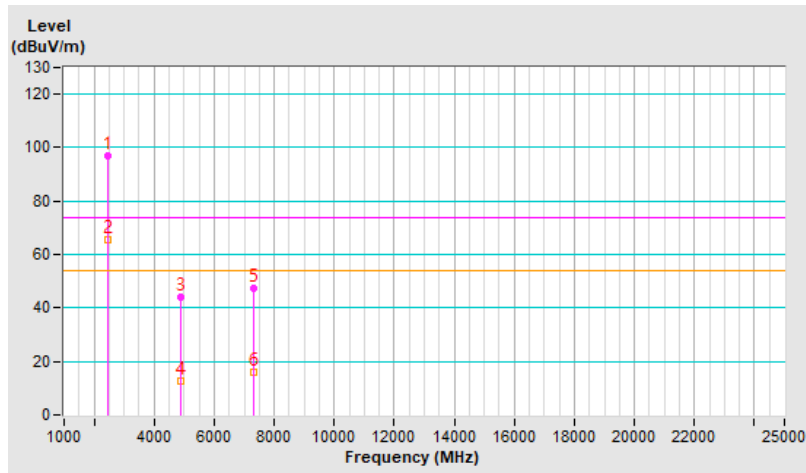

RF Mode	BT-LE 2M	Channel	CH 38 : 2478 MHz
Frequency Range	1 GHz ~ 25 GHz	Detector Function & Bandwidth	Peak (PK), RB = 1 MHz, VB = 3 MHz RMS (AV), RB = 1 MHz, VB = 3 MHz
Input Power (System)	120 Vac, 60 Hz	Environmental Conditions	28°C, 75% RH
Tested By	Louis Yang		

Antenna Polarity & Test Distance : Horizontal at 3 m								
No	Frequency (MHz)	Emission Level (dBuV/m)	Limit (dBuV/m)	Margin (dB)	Antenna Height (m)	Table Angle (Degree)	Raw Value (dBuV)	Correction Factor (dB/m)
1	*2478.00	92.6 PK			1.00 H	340	95.3	-2.7
2	*2478.00	61.4 AV			1.00 H	340	64.1	-2.7
3	2483.50	54.1 PK	74.0	-19.9	1.00 H	340	56.8	-2.7
4	2483.50	45.0 AV	54.0	-9.0	1.00 H	340	47.7	-2.7
5	4956.00	42.6 PK	74.0	-31.4	1.04 H	351	40.9	1.7
6	4956.00	11.4 AV	54.0	-42.6	1.04 H	351	9.7	1.7
7	7434.00	42.9 PK	74.0	-31.1	1.02 H	97	35.5	7.4
8	7434.00	11.7 AV	54.0	-42.3	1.02 H	97	4.3	7.4

Remarks:

1. Emission Level(dBuV/m) = Raw Value(dBuV) + Correction Factor(dB/m)
2. Correction Factor(dB/m) = Antenna Factor(dB/m) + Cable Factor(dB) – Pre-Amplifier Factor(dB)
3. Margin value = Emission Level – Limit value
4. The other emission levels were very low against the limit.
5. " * ": Fundamental frequency, the limit was restricted at the RF Output Power.
6. The average value of fundamental and harmonic frequency is: Average = Peak value + 20 log(Duty cycle) Where the duty cycle correction factor is calculated from following formula:
 $20 \log(\text{Duty cycle}) = 20 \log(0.188 \text{ ms} / 6.827 \text{ ms}) = -31.2 \text{ dB}$

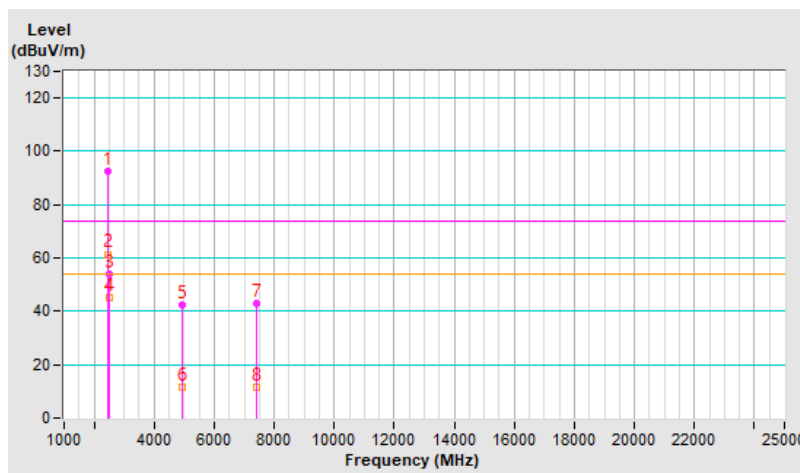

RF Mode	BT-LE 2M	Channel	CH 38 : 2478 MHz
Frequency Range	1 GHz ~ 25 GHz	Detector Function & Bandwidth	Peak (PK), RB = 1 MHz, VB = 3 MHz RMS (AV), RB = 1 MHz, VB = 3 MHz
Input Power (System)	120 Vac, 60 Hz	Environmental Conditions	28°C, 75% RH
Tested By	Louis Yang		

Antenna Polarity & Test Distance : Vertical at 3 m								
No	Frequency (MHz)	Emission Level (dBuV/m)	Limit (dBuV/m)	Margin (dB)	Antenna Height (m)	Table Angle (Degree)	Raw Value (dBuV)	Correction Factor (dB/m)
1	*2478.00	90.2 PK			1.00 V	117	92.9	-2.7
2	*2478.00	59.0 AV			1.00 V	117	61.7	-2.7
3	2483.50	54.0 PK	74.0	-20.0	1.00 V	117	56.7	-2.7
4	2483.50	44.8 AV	54.0	-9.2	1.00 V	117	47.5	-2.7
5	4956.00	43.9 PK	74.0	-30.1	1.13 V	198	42.2	1.7
6	4956.00	12.7 AV	54.0	-41.3	1.13 V	198	11.0	1.7
7	7434.00	47.2 PK	74.0	-26.8	1.12 V	139	39.8	7.4
8	7434.00	16.0 AV	54.0	-38.0	1.12 V	139	8.6	7.4

Remarks:

1. Emission Level(dBuV/m) = Raw Value(dBuV) + Correction Factor(dB/m)
2. Correction Factor(dB/m) = Antenna Factor(dB/m) + Cable Factor(dB) – Pre-Amplifier Factor(dB)
3. Margin value = Emission Level – Limit value
4. The other emission levels were very low against the limit.
5. " * ": Fundamental frequency, the limit was restricted at the RF Output Power.
6. The average value of fundamental and harmonic frequency is: Average = Peak value + 20 log(Duty cycle) Where the duty cycle correction factor is calculated from following formula:
 $20 \log(\text{Duty cycle}) = 20 \log(0.188 \text{ ms} / 6.827 \text{ ms}) = -31.2 \text{ dB}$

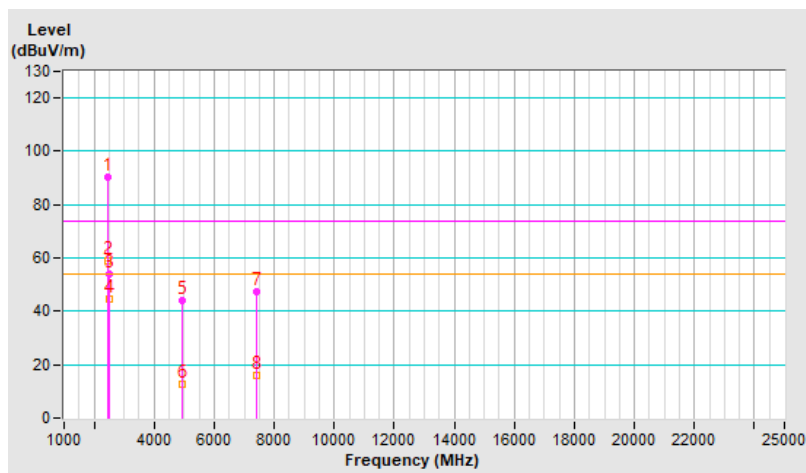

Plot of Band Edge_Mode A

Mode A

Frequency Range	2.31 GHz ~ 2.5 GHz	Detector Function & Bandwidth	Peak (PK), RB = 1 MHz, VB = 3 MHz RMS (AV), RB = 1 MHz, VB = 3 MHz
-----------------	--------------------	-------------------------------	---

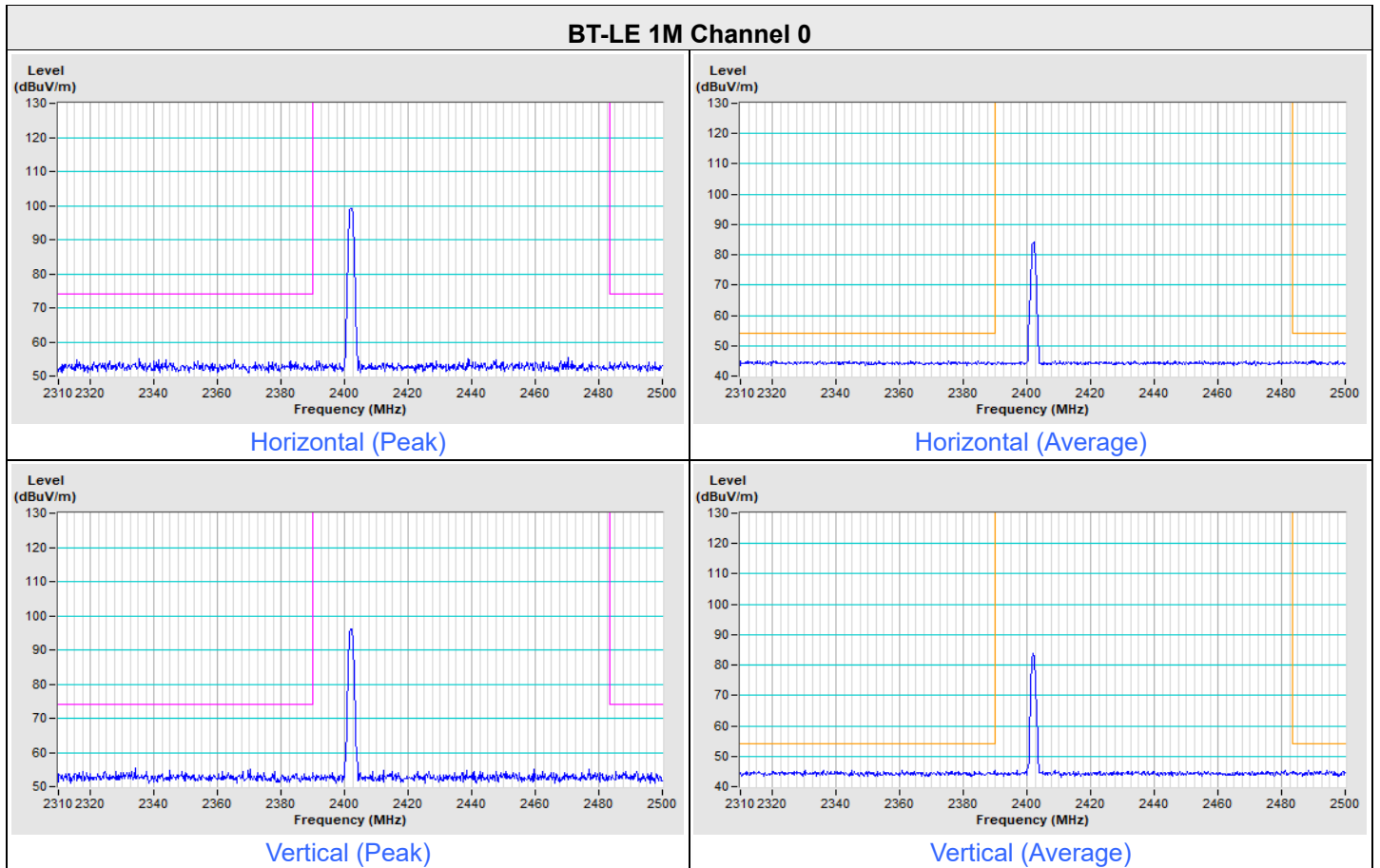

BT-LE 1M Channel 39

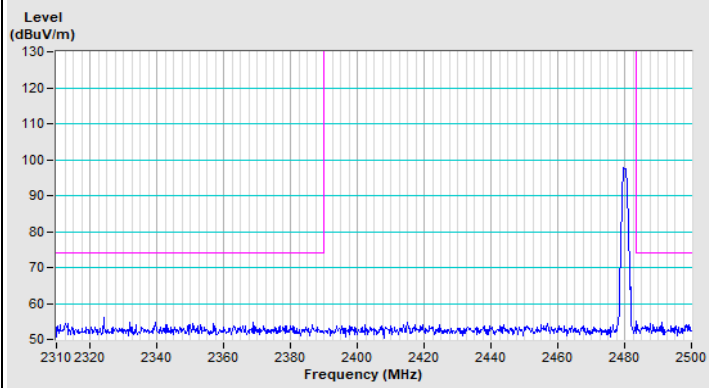

Horizontal (Peak)

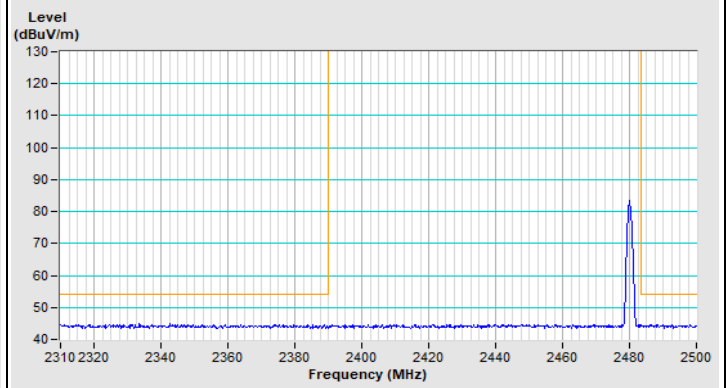

Horizontal (Average)

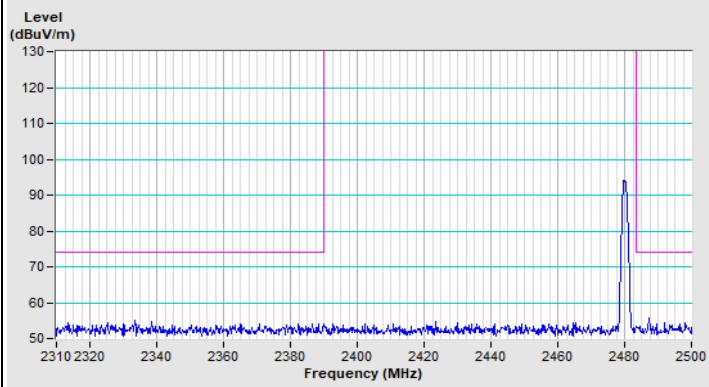

Vertical (Peak)

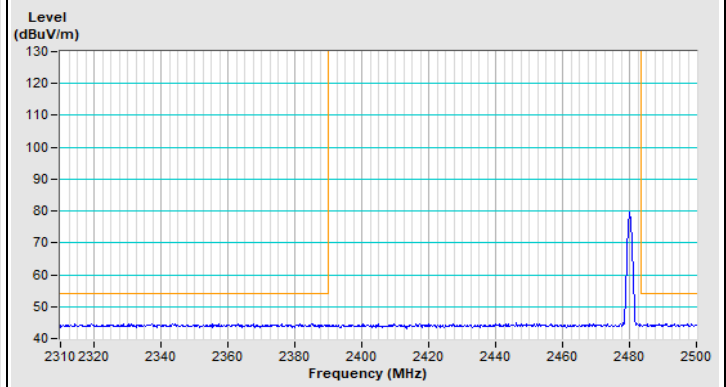

Vertical (Average)

Frequency Range	2.31 GHz ~ 2.5 GHz	Detector Function & Bandwidth	Peak (PK), RB = 1 MHz, VB = 3 MHz RMS (AV), RB = 1 MHz, VB = 3 MHz
-----------------	--------------------	-------------------------------	---

BT-LE 2M Channel 1

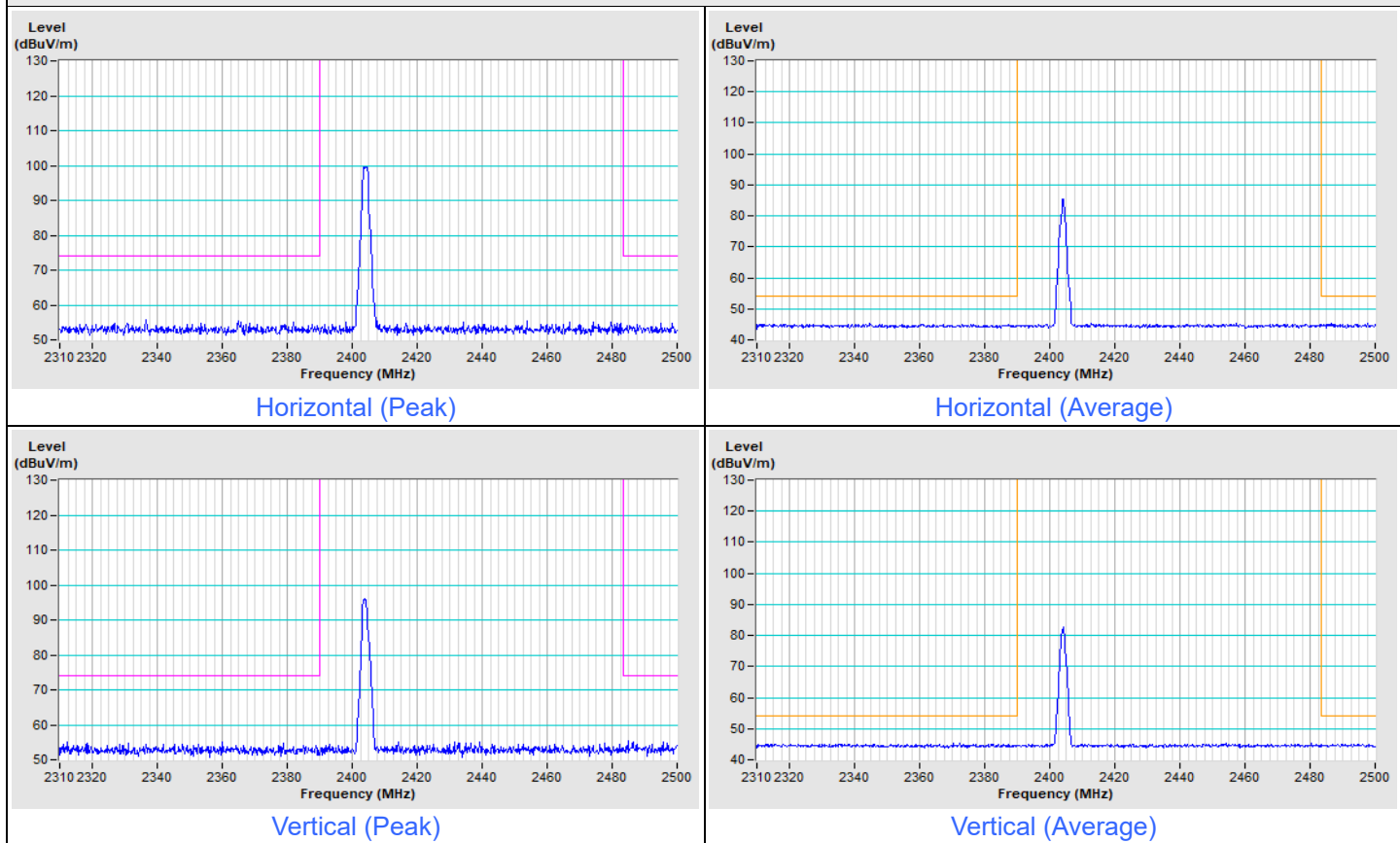

BT-LE 2M Channel 38

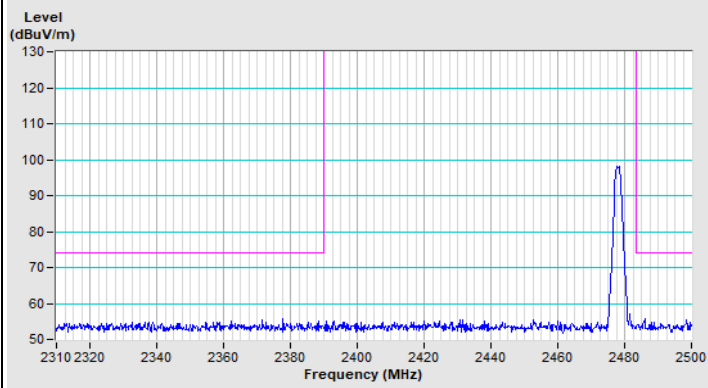

Horizontal (Peak)

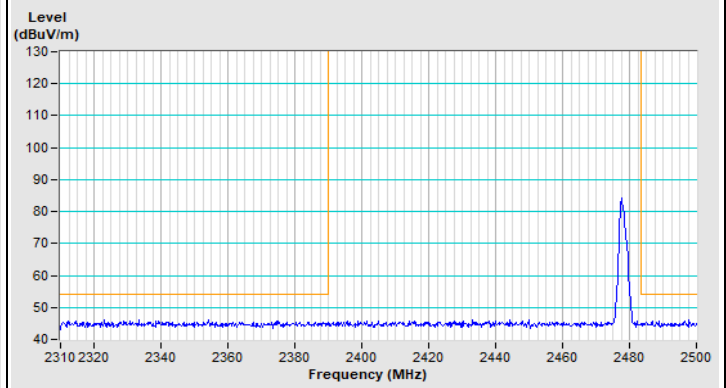

Horizontal (Average)

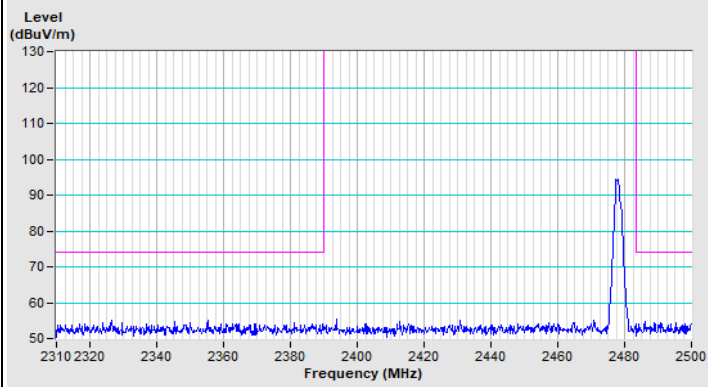

Vertical (Peak)

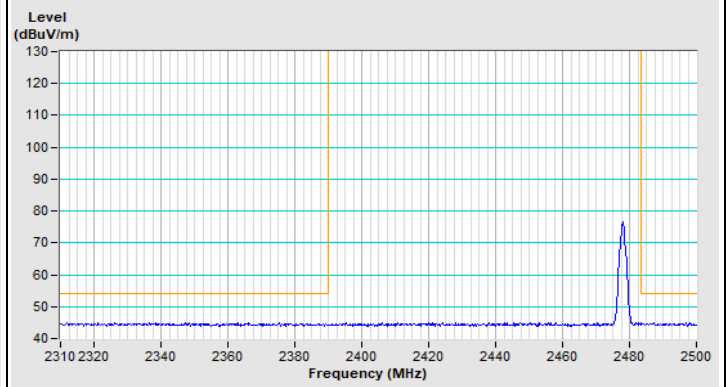

Vertical (Average)

Plot of Band Edge_Mode B

Mode B

Frequency Range	2.31 GHz ~ 2.5 GHz	Detector Function & Bandwidth	Peak (PK), RB = 1 MHz, VB = 3 MHz RMS (AV), RB = 1 MHz, VB = 3 MHz
-----------------	--------------------	-------------------------------	---

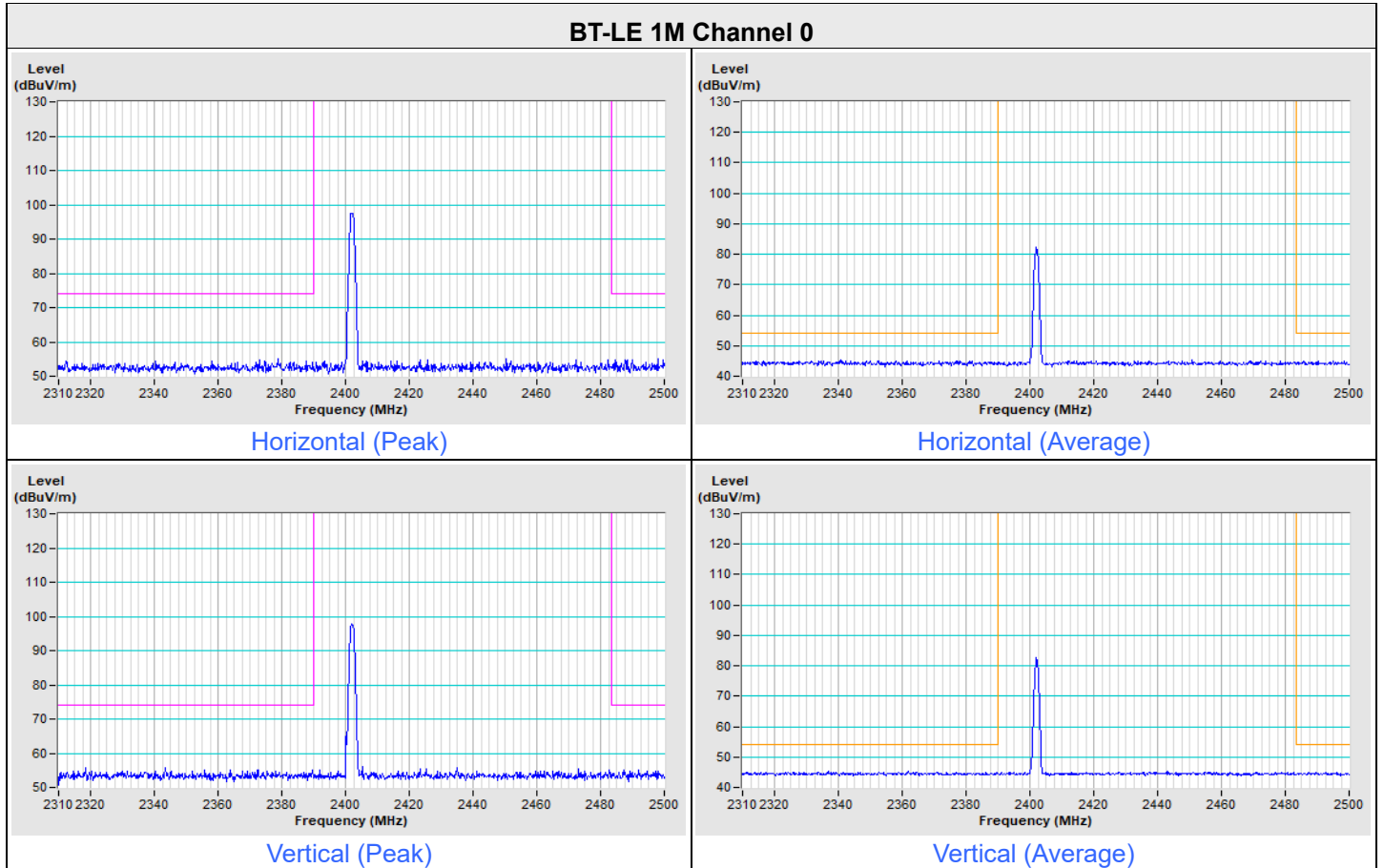

BT-LE 1M Channel 39

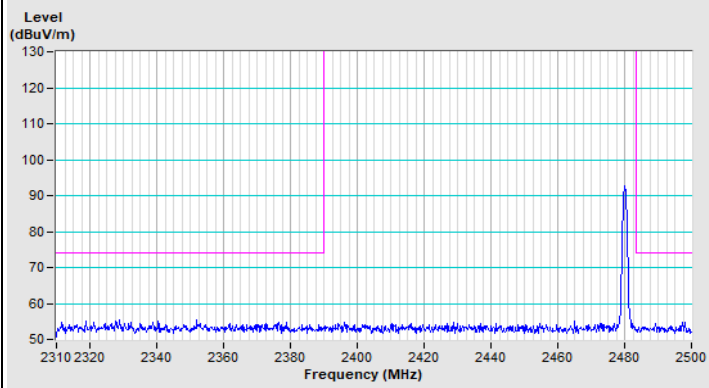

Horizontal (Peak)

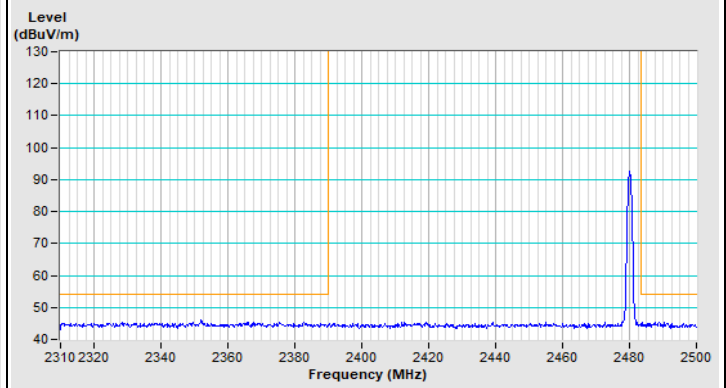

Horizontal (Average)

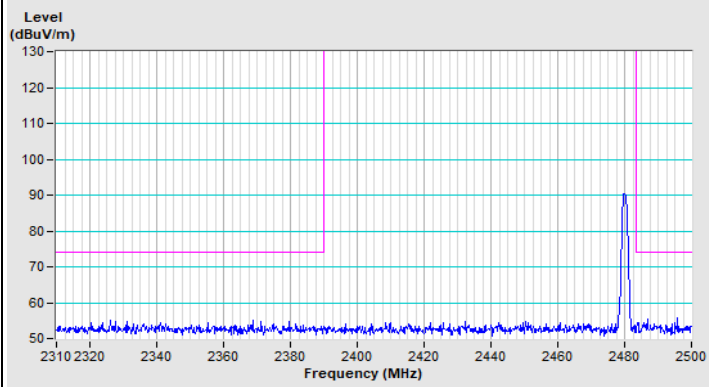

Vertical (Peak)

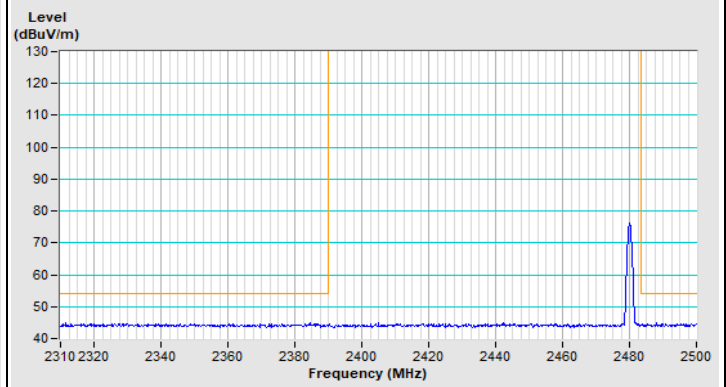

Vertical (Average)

Frequency Range	2.31 GHz ~ 2.5 GHz	Detector Function & Bandwidth	Peak (PK), RB = 1 MHz, VB = 3 MHz RMS (AV), RB = 1 MHz, VB = 3 MHz
-----------------	--------------------	-------------------------------	---

BT-LE 2M Channel 1

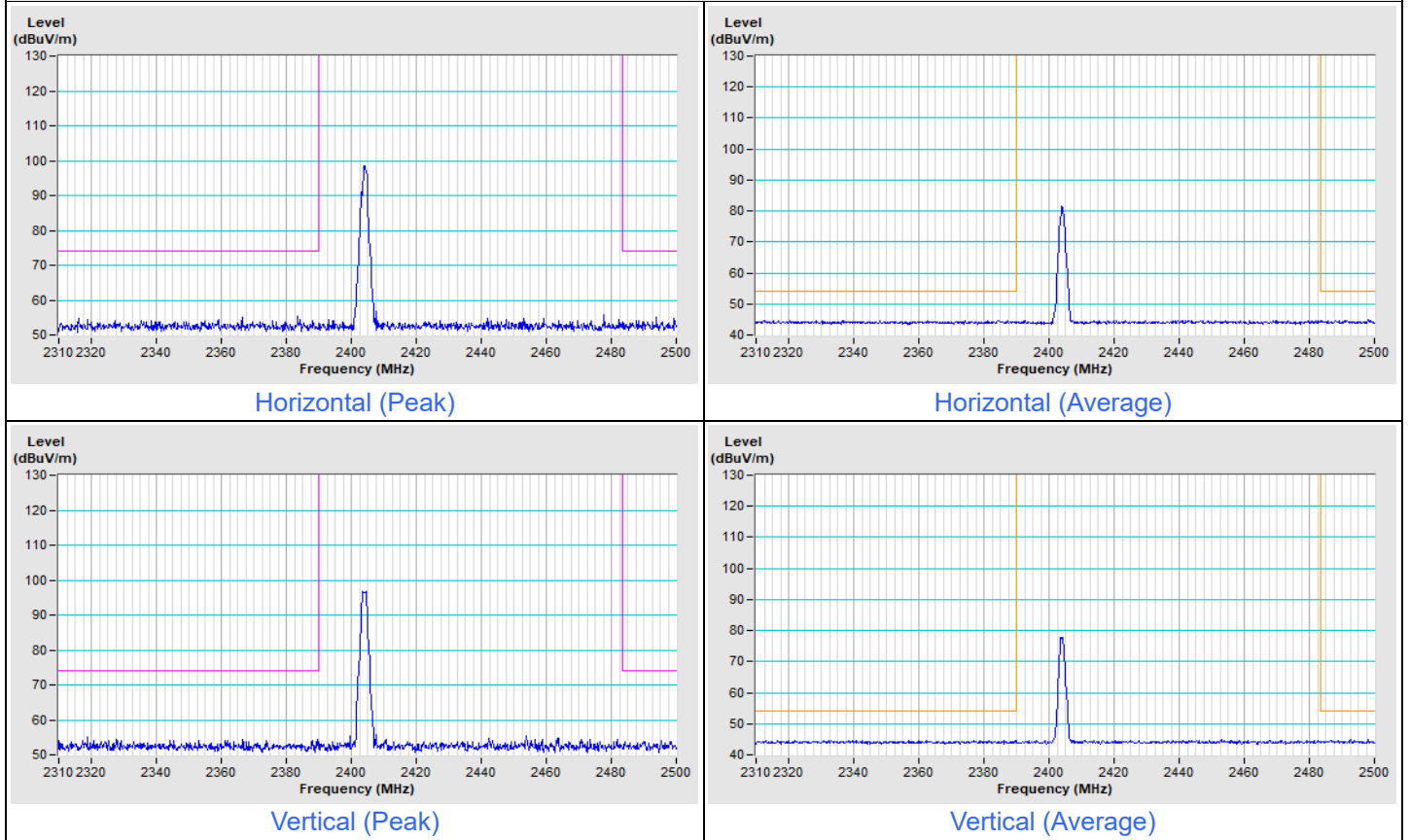

BT-LE 2M Channel 38

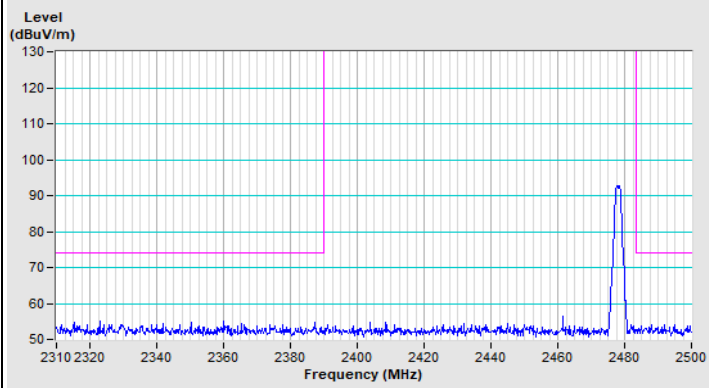

Horizontal (Peak)

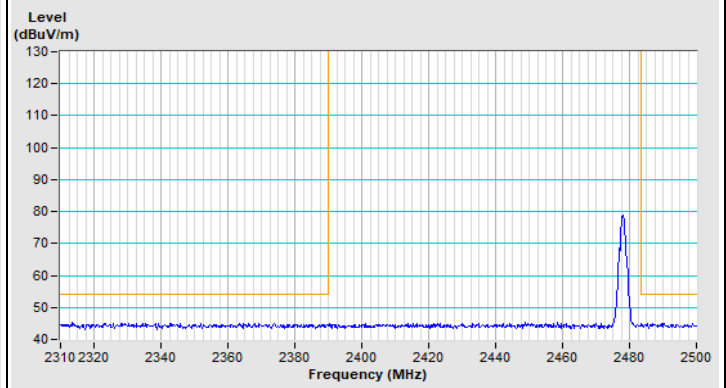

Horizontal (Average)

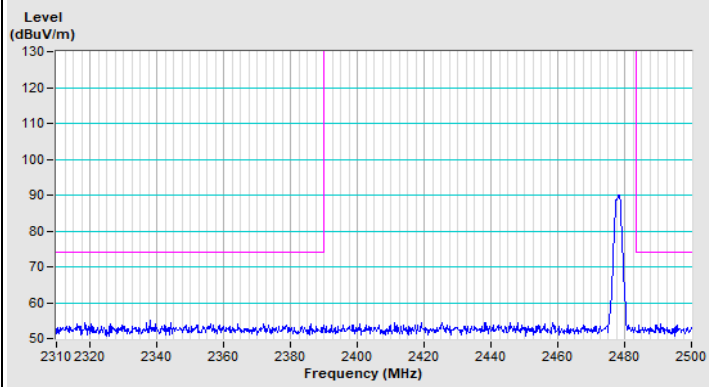

Vertical (Peak)

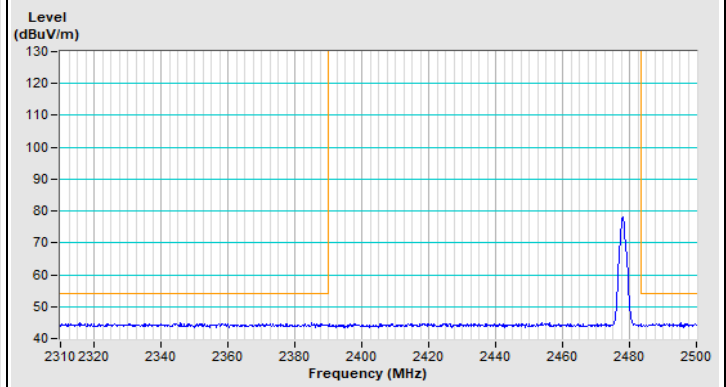

Vertical (Average)

8 Pictures of Test Arrangements

Please refer to the attached file (Test Setup Photo)

9 Information of the Testing Laboratories

We, Bureau Veritas Consumer Products Services (H.K.) Ltd., Taoyuan Branch, were founded in 1988 to provide our best service in EMC, Radio, Telecom and Safety consultation. Our laboratories are FCC recognized accredited test firms and accredited according to ISO/IEC 17025.

If you have any comments, please feel free to contact us at the following:

Lin Kou EMC/RF Lab

Tel: 886-2-26052180

Fax: 886-2-26051924

Hsin Chu EMC/RF/Telecom Lab

Tel: 886-3-6668565

Fax: 886-3-6668323

Hwa Ya EMC/RF/Safety Lab

Tel: 886-3-3183232

Fax: 886-3-3270892

Email: service.adt@bureauveritas.com

Web Site: <http://ee.bureauveritas.com.tw>

The address and road map of all our labs can be found in our web site also.

--- END ---