

## FCC Test Report

**Report No.:** RF180802E09-1

**FCC ID:** JNZYR0069

**Test Model:** Y-R0069

**Received Date:** Aug. 02, 2018

**Test Date:** Aug. 07 to 09, 2018

**Issued Date:** Aug. 22, 2018

**Applicant:** LOGITECH FAR EAST LTD.

**Address:** #2 Creation Rd. 4, Science-Based Ind. Park Hsinchu Taiwan, R.O.C.

**Issued By:** Bureau Veritas Consumer Products Services (H.K.) Ltd., Taoyuan Branch  
Hsin Chu Laboratory

**Lab Address:** E-2, No.1, Li Hsin 1st Road, Hsinchu Science Park, Hsinchu City 300,  
Taiwan R.O.C.

**Test Location :** E-2, No.1, Li Hsin 1st Road, Hsinchu Science Park, Hsinchu City 300,  
Taiwan R.O.C.

**FCC Registration /  
Designation Number:** 723255 / TW2022



This report is for your exclusive use. Any copying or replication of this report to or for any other person or entity, or use of our name or trademark, is permitted only with our prior written permission. This report sets forth our findings solely with respect to the test samples identified herein. The results set forth in this report are not indicative or representative of the quality or characteristics of the lot from which a test sample was taken or any similar or identical product unless specifically and expressly noted. Our report includes all of the tests requested by you and the results thereof based upon the information that you provided to us. You have 60 days from date of issuance of this report to notify us of any material error or omission caused by our negligence, provided, however, that such notice shall be in writing and shall specifically address the issue you wish to raise. A failure to raise such issue within the prescribed time shall constitute your unqualified acceptance of the completeness of this report, the tests conducted and the correctness of the report contents. Unless specific mention, the uncertainty of measurement has been explicitly taken into account to declare the compliance or non-compliance to the specification. The report must not be used by the client to claim product certification, approval, or endorsement by TAF or any government agencies.

## Table of Contents

<b>Release Control Record</b> .....	<b>4</b>
<b>1 Certificate of Conformity</b> .....	<b>5</b>
<b>2 Summary of Test Results</b> .....	<b>6</b>
2.1 Measurement Uncertainty .....	6
2.2 Modification Record .....	6
<b>3 General Information</b> .....	<b>7</b>
3.1 General Description of EUT .....	7
3.2 Description of Test Modes .....	8
3.2.1 Test Mode Applicability and Tested Channel Detail .....	9
3.3 Duty Cycle of Test Signal .....	11
3.4 Description of Support Units .....	12
3.4.1 Configuration of System under Test .....	13
3.5 General Description of Applied Standards .....	14
<b>4 Test Types and Results</b> .....	<b>15</b>
4.1 Radiated Emission and Bandedge Measurement .....	15
4.1.1 Limits of Radiated Emission and Bandedge Measurement .....	15
4.1.2 Test Instruments .....	16
4.1.3 Test Procedures .....	17
4.1.4 Deviation from Test Standard .....	17
4.1.5 Test Setup .....	18
4.1.6 EUT Operating Conditions .....	19
4.1.7 Test Results (Mode 1) .....	20
4.2 Conducted Emission Measurement .....	28
4.2.1 Limits of Conducted Emission Measurement .....	28
4.2.2 Test Instruments .....	28
4.2.3 Test Procedures .....	29
4.2.4 Deviation from Test Standard .....	29
4.2.5 Test Setup .....	29
4.2.6 EUT Operating Conditions .....	29
4.2.7 Test Results (Mode 1) .....	30
4.2.8 Test Results (Mode 2) .....	34
4.3 6dB Bandwidth Measurement .....	38
4.3.1 Limits of 6dB Bandwidth Measurement .....	38
4.3.2 Test Setup .....	38
4.3.3 Test Instruments .....	38
4.3.4 Test Procedure .....	38
4.3.5 Deviation from Test Standard .....	38
4.3.6 EUT Operating Conditions .....	38
4.3.7 Test Result (Mode 1) .....	39
4.4 Conducted Output Power Measurement .....	41
4.4.1 Limits of Conducted Output Power Measurement .....	41
4.4.2 Test Setup .....	41
4.4.3 Test Instruments .....	41
4.4.4 Test Procedures .....	41
4.4.5 Deviation from Test Standard .....	41
4.4.6 EUT Operating Conditions .....	41
4.4.7 Test Results (Mode 1) .....	42
4.5 Power Spectral Density Measurement .....	44
4.5.1 Limits of Power Spectral Density Measurement .....	44
4.5.2 Test Setup .....	44
4.5.3 Test Instruments .....	44
4.5.4 Test Procedure .....	44
4.5.5 Deviation from Test Standard .....	44

4.5.6 EUT Operating Condition .....	44
4.5.7 Test Results (Mode 1).....	45
4.6 Conducted Out of Band Emission Measurement.....	47
4.6.1 Limits of Conducted Out of Band Emission Measurement.....	47
4.6.2 Test Setup.....	47
4.6.3 Test Instruments .....	47
4.6.4 Test Procedure .....	47
4.6.5 Deviation from Test Standard .....	47
4.6.6 EUT Operating Condition .....	47
4.6.7 Test Results (Mode 1).....	48
<b>5 Pictures of Test Arrangements.....</b>	<b>50</b>
<b>Appendix – Information on the Testing Laboratories .....</b>	<b>51</b>

### Release Control Record

Issue No.	Description	Date Issued
RF180802E09-1	Original release.	Aug. 22, 2018

## 1 Certificate of Conformity

**Product:** Wireless Keyboard

**Brand:** logitech G

**Test Model:** Y-R0069

**Sample Status:** ENGINEERING SAMPLE

**Applicant:** LOGITECH FAR EAST LTD.

**Test Date:** Aug. 07 to 09, 2018

**Standards:** 47 CFR FCC Part 15, Subpart C (Section 15.247)  
ANSI C63.10: 2013

The above equipment has been tested by **Bureau Veritas Consumer Products Services (H.K.) Ltd., Taoyuan Branch**, and found compliance with the requirement of the above standards. The test record, data evaluation & Equipment Under Test (EUT) configurations represented herein are true and accurate accounts of the measurements of the sample's EMC characteristics under the conditions specified in this report.

**Prepared by :** Mary Ko , **Date:** Aug. 22, 2018  
Mary Ko / Specialist

**Approved by :** May Chen , **Date:** Aug. 22, 2018  
May Chen / Manager

## 2 Summary of Test Results

47 CFR FCC Part 15, Subpart C (SECTION 15.247)			
FCC Clause	Test Item	Result	Remarks
15.207	AC Power Conducted Emission	PASS	Meet the requirement of limit. Minimum passing margin is -15.75dB at 0.15000MHz.
15.205 & 209 & 15.247(d)	Radiated Emissions & Band Edge Measurement	PASS	Meet the requirement of limit. Minimum passing margin is -3.1dB at 2370.00MHz.
15.247(d)	Antenna Port Emission	PASS	Meet the requirement of limit.
15.247(a)(2)	6dB bandwidth	PASS	Meet the requirement of limit.
15.247(b)	Conducted power	PASS	Meet the requirement of limit.
15.247(e)	Power Spectral Density	PASS	Meet the requirement of limit.
15.203	Antenna Requirement	PASS	No antenna connector is used.

### 2.1 Measurement Uncertainty

Where relevant, the following measurement uncertainty levels have been estimated for tests performed on the EUT as specified in CISPR 16-4-2:

Measurement	Frequency	Expanded Uncertainty (k=2) ( $\pm$ )
Conducted Emissions at mains ports	150kHz ~ 30MHz	1.84 dB
Radiated Emissions up to 1 GHz	30MHz ~ 1GHz	5.33 dB
Radiated Emissions above 1 GHz	1GHz ~ 6GHz	5.10 dB
	6GHz ~ 18GHz	4.85 dB
	18GHz ~ 40GHz	5.24 dB

### 2.2 Modification Record

There were no modifications required for compliance.

### 3 General Information

#### 3.1 General Description of EUT

Product	Wireless Keyboard
PMN	G915
Brand	logitech G
Test Model	Y-R0069
Status of EUT	ENGINEERING SAMPLE
Power Supply Rating	3.7Vdc from battery or 5Vdc from USB interface
Modulation Type	GFSK
Modulation Technology	DTS
Transfer Rate	Up to 2Mbps
Operating Frequency	<b>LE 1M (BT 4.0):</b> 2402MHz ~ 2480MHz <b>LE 2M (BT 5.0):</b> 2404MHz ~ 2478MHz
Number of Channel	<b>LE 1M (BT 4.0):</b> 40 <b>LE 2M (BT 5.0):</b> 38
Output Power	<b>LE 1M (BT 4.0):</b> 3.698mW <b>LE 2M (BT 5.0):</b> 3.681mW
Antenna Type	Refer to Note
Antenna Connector	NA
Accessory Device	NA
Data Cable Supplied	USB to Micro USB cable x 1 (shielded, 1.8m with one core)

Note:

- The EUT may have a lot of colors for marketing requirement.
- The antenna provided to the EUT, please refer to the following table:

Antenna No.	Brand	Model	Antenna Gain(dBi)	Frequency range (GHz)	Antenna Type	Connecter Type
1	TAGEO	CAN4311712112453K	5.60	2.4~2.4835	Ceramic Antenna	NA

- The EUT could be supplied with rechargeable battery as the following table:

Brand Name	Model No.	Spec.
SYNERGY SCIENTECH CORP	AHB355085PCT-02	3.7V, 1500mAh

- For radiated emissions, the EUT was pre-tested under the following modes:

Test Mode	Description
Mode A	Power from USB adapter
Mode B	Power from Battery

From the above modes, the worst case was found in **Mode A**. Therefore only the test data of the mode was recorded in this report.

- The device wireless function will be disable automatically when the device is connected to the host equipment through USB cable.
- The above EUT information is declared by manufacturer and for more detailed features description, please refer to the manufacturer's specifications or user's manual.

### 3.2 Description of Test Modes

#### Technology LE 1M (BT 4.0)

40 channels are provided for BT-LE mode:

Channel	Freq. (MHz)	Channel	Freq. (MHz)	Channel	Freq. (MHz)	Channel	Freq. (MHz)
0	2402	10	2422	20	2442	30	2462
1	2404	11	2424	21	2444	31	2464
2	2406	12	2426	22	2446	32	2466
3	2408	13	2428	23	2448	33	2468
4	2410	14	2430	24	2450	34	2470
5	2412	15	2432	25	2452	35	2472
6	2414	16	2434	26	2454	36	2474
7	2416	17	2436	27	2456	37	2476
8	2418	18	2438	28	2458	38	2478
9	2420	19	2440	29	2460	39	2480

#### Technology LE 2M (BT 5.0)

38 channels are provided for BT-LE mode:

Channel	Freq. (MHz)	Channel	Freq. (MHz)	Channel	Freq. (MHz)	Channel	Freq. (MHz)
1	2404	11	2424	21	2444	31	2464
2	2406	12	2426	22	2446	32	2466
3	2408	13	2428	23	2448	33	2468
4	2410	14	2430	24	2450	34	2470
5	2412	15	2432	25	2452	35	2472
6	2414	16	2434	26	2454	36	2474
7	2416	17	2436	27	2456	37	2476
8	2418	18	2438	28	2458	38	2478
9	2420	19	2440	29	2460		
10	2422	20	2442	30	2462		



### 3.2.1 Test Mode Applicability and Tested Channel Detail

EUT CONFIGURE MODE	APPLICABLE TO				DESCRIPTION
	RE $\geq$ 1G	RE<1G	PLC	APCM	
1	√	√	√	√	Powered from USB adapter
2	-	-	√	-	Powered from Laptop

Where **RE $\geq$ 1G**: Radiated Emission above 1GHz      **RE<1G**: Radiated Emission below 1GHz  
**PLC**: Power Line Conducted Emission      **APCM**: Antenna Port Conducted Measurement

**Note:** 1. "-" means no effect.

#### **Radiated Emission Test (Above 1GHz):**

- Pre-Scan has been conducted to determine the worst-case mode from all possible combinations between available modulations, data rates and antenna ports (if EUT with antenna diversity architecture).
- Following channel(s) was (were) selected for the final test as listed below.

AVAILABLE CHANNEL	TESTED CHANNEL	MODULATION TYPE	DATA RATE (Mbps)
0 to 39	0, 19, 39	GFSK	1
1 to 38	1, 19, 38	GFSK	2

#### **Radiated Emission Test (Below 1GHz):**

- Pre-Scan has been conducted to determine the worst-case mode from all possible combinations between available modulations, data rates and antenna ports (if EUT with antenna diversity architecture).
- Following channel(s) was (were) selected for the final test as listed below.

AVAILABLE CHANNEL	TESTED CHANNEL	MODULATION TYPE	DATA RATE (Mbps)
0 to 39	39	GFSK	1
1 to 38	38	GFSK	2

#### **Power Line Conducted Emission Test:**

- Pre-Scan has been conducted to determine the worst-case mode from all possible combinations between available modulations, data rates and antenna ports (if EUT with antenna diversity architecture).
- Following channel(s) was (were) selected for the final test as listed below.

AVAILABLE CHANNEL	TESTED CHANNEL	MODULATION TYPE	DATA RATE (Mbps)
0 to 39	39	GFSK	1
1 to 38	38	GFSK	2

**Antenna Port Conducted Measurement:**

- This item includes all test value of each mode, but only includes spectrum plot of worst value of each mode.
- Pre-Scan has been conducted to determine the worst-case mode from all possible combinations between available modulations, data rates and antenna ports (if EUT with antenna diversity architecture).
- Following channel(s) was (were) selected for the final test as listed below.

AVAILABLE CHANNEL	TESTED CHANNEL	MODULATION TYPE	DATA RATE (Mbps)
0 to 39	0, 19, 39	GFSK	1
1 to 38	1, 19, 38	GFSK	2

**Test Condition:**

APPLICABLE TO	ENVIRONMENTAL CONDITIONS	INPUT POWER (System)	TESTED BY
RE $\geq$ 1G	22deg. C, 64%RH	120Vac, 60Hz	Robert Cheng
RE<1G	21deg. C, 65%RH	120Vac, 60Hz	Frank Chuang
PLC	24deg. C, 76%RH	120Vac, 60Hz	Andy Ho
APCM	25deg. C, 60%RH	120Vac, 60Hz	Jyunchun Lin

### 3.3 Duty Cycle of Test Signal

#### Technology LE 1M (BT 4.0)

Duty cycle of test signal is < 98 %, duty factor shall be considered.

Duty cycle = 0.3 ms/0.981 ms = 0.306, Duty factor =  $10 * \log(1/0.306) = 5.15$

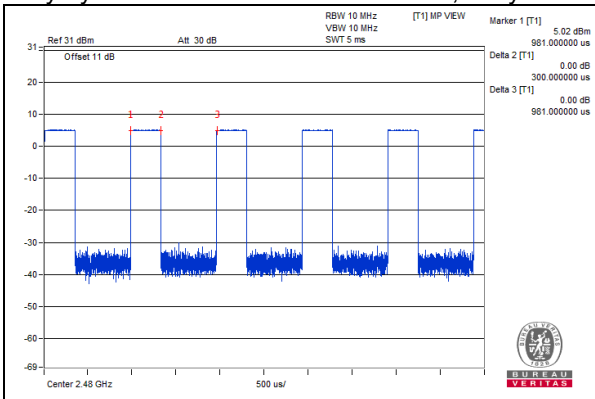

#### Technology LE 2M (BT 5.0)

Duty cycle of test signal is < 98 %, duty factor shall be considered.

Duty cycle = 0.173 ms/0.977 ms = 0.177, Duty factor =  $10 * \log(1/0.177) = 7.52$

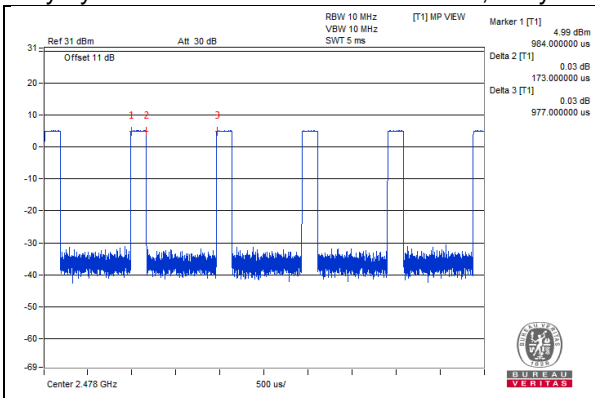

### 3.4 Description of Support Units

The EUT has been tested as an independent unit together with other necessary accessories or support units. The following support units or accessories were used to form a representative test configuration during the tests.

ID	Product	Brand	Model No.	Serial No.	FCC ID	Remarks
A.	USB Adapter	ASUS	EXA1205UA	NA	NA	Provided by Lab
B.	Laptop	DELL	E6420	B92T3R1	FCC DoC	Provided by Lab

Note:

1. All power cords of the above support units are non-shielded (1.8m).

ID	Descriptions	Qty.	Length (m)	Shielding (Yes/No)	Cores (Qty.)	Remarks
1.	USB Cable	1	1.8	Yes	1	Supplied by client

Note: The core(s) is(are) originally attached to the cable(s).

### 3.4.1 Configuration of System under Test

#### USB adapter mode:

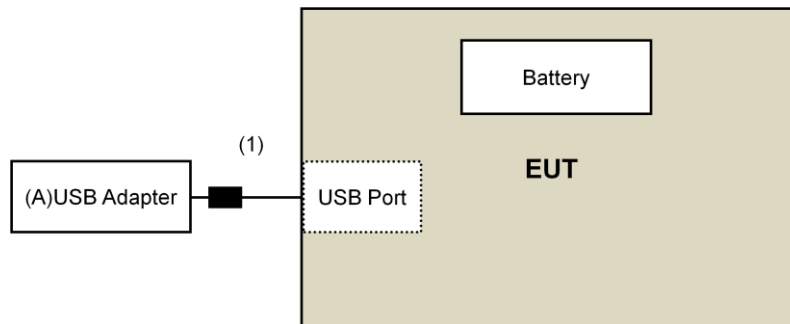

#### Laptop mode:

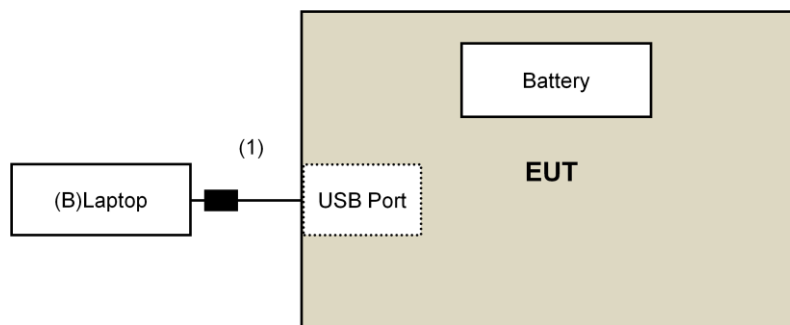

### 3.5 General Description of Applied Standards

The EUT is a RF Product. According to the specifications of the manufacturer, it must comply with the requirements of the following standards:

**FCC Part 15, Subpart C (15.247)**

**KDB 558074 D01 DTS Meas Guidance v04**

ANSI C63.10-2013

All test items have been performed and recorded as per the above standards.

## 4 Test Types and Results

### 4.1 Radiated Emission and Bandedge Measurement

#### 4.1.1 Limits of Radiated Emission and Bandedge Measurement

Radiated emissions which fall in the restricted bands must comply with the radiated emission limits specified as below table. Other emissions shall be at least 20dB below the highest level of the desired power:

Frequencies (MHz)	Field Strength (microvolts/meter)	Measurement Distance (meters)
0.009 ~ 0.490	2400/F(kHz)	300
0.490 ~ 1.705	24000/F(kHz)	30
1.705 ~ 30.0	30	30
30 ~ 88	100	3
88 ~ 216	150	3
216 ~ 960	200	3
Above 960	500	3

**Note:**

1. The lower limit shall apply at the transition frequencies.
2. Emission level (dBuV/m) = 20 log Emission level (uV/m).
3. For frequencies above 1000MHz, the field strength limits are based on average detector, however, the peak field strength of any emission shall not exceed the maximum permitted average limits, specified above by more than 20dB under any condition of modulation.

## 4.1.2 Test Instruments

DESCRIPTION & MANUFACTURER	MODEL NO.	SERIAL NO.	CALIBRATED DATE	CALIBRATED UNTIL
Test Receiver Keysight	N9038A	MY54450088	July 05, 2018	July 04, 2019
Pre-Amplifier EMCI	EMC001340	980142	Feb. 09, 2018	Feb. 08, 2019
Loop Antenna <sup>(*)</sup> Electro-Metrics	EM-6879	264	Dec. 16, 2016	Dec. 15, 2018
RF Cable	NA	LOOPCAB-001	Jan. 15, 2018	Jan. 14, 2019
RF Cable	NA	LOOPCAB-002	Jan. 15, 2018	Jan. 14, 2019
Pre-Amplifier Mini-Circuits	ZFL-1000VH2B	AMP-ZFL-01	Nov. 09, 2017	Nov. 08, 2018
Trilog Broadband Antenna SCHWARZBECK	VULB 9168	9168-406	Nov. 29, 2017	Nov. 28, 2018
RF Cable	8D	966-4-1	Mar. 21, 2018	Mar. 20, 2019
RF Cable	8D	966-4-2	Mar. 21, 2018	Mar. 20, 2019
RF Cable	8D	966-4-3	Mar. 21, 2018	Mar. 20, 2019
Fixed attenuator Mini-Circuits	UNAT-5+	PAD-3m-4-01	Oct. 03, 2017	Oct. 02, 2018
Horn_Antenna SCHWARZBECK	BBHA 9120D	9120D-783	Dec. 12, 2017	Dec. 11, 2018
Pre-Amplifier EMCI	EMC12630SE	980385	Jan. 29, 2018	Jan. 28, 2019
RF Cable	EMC104-SM-SM-1200	160923	Jan. 29, 2018	Jan. 28, 2019
RF Cable	EMC104-SM-SM-2000	150318	Jan. 29, 2018	Jan. 28, 2019
RF Cable	EMC104-SM-SM-5000	150321	Jan. 29, 2018	Jan. 28, 2019
Pre-Amplifier EMCI	EMC184045SE	980387	Jan. 29, 2018	Jan. 28, 2019
Horn_Antenna SCHWARZBECK	BBHA 9170	BBHA9170608	Dec. 14, 2017	Dec. 13, 2018
RF Cable	EMC102-KM-KM-1200	160925	Jan. 29, 2018	Jan. 28, 2019
Software	ADT_Radiated_V8.7.08	NA	NA	NA
Boresight Antenna Tower & Turn Table Max-Full	MF-7802BS	MF780208530	NA	NA
Spectrum Analyzer R&S	FSv40	100964	June 20, 2018	June 19, 2019
Power meter Anritsu	ML2495A	1014008	May 09, 2018	May 08, 2019
Power sensor Anritsu	MA2411B	0917122	May 09, 2018	May 08, 2019

**Note:**

1. The calibration interval of the above test instruments is 12 months and the calibrations are traceable to NML/ROC and NIST/USA.
2. \*The calibration interval of the above test instruments is 24 months and the calibrations are traceable to NML/ROC and NIST/USA.
3. The test was performed in 966 Chamber No. 4.
4. The CANADA Site Registration No. is 20331-2
5. Loop antenna was used for all emissions below 30 MHz.
6. Tested Date: Aug. 07 to 09, 2018



#### 4.1.3 Test Procedures

##### **For Radiated emission below 30MHz**

- a. The EUT was placed on the top of a rotating table 0.8 meters above the ground at a 3 meter chamber room. The table was rotated 360 degrees to determine the position of the highest radiation.
- b. The EUT was set 3 meters away from the interference-receiving antenna, which was mounted on the top of a variable-height antenna tower.
- c. Parallel, perpendicular, and ground-parallel orientations of the antenna are set to make the measurement.
- d. For each suspected emission, the EUT was arranged to its worst case and the rotatable table was turned from 0 degrees to 360 degrees to find the maximum reading.
- e. The test-receiver system was set to Quasi-Peak Detect Function and Specified Bandwidth with Maximum Hold Mode.

##### **Note:**

1. The resolution bandwidth and video bandwidth of test receiver/spectrum analyzer is 9kHz at frequency below 30MHz.

##### **For Radiated emission above 30MHz**

- a. The EUT was placed on the top of a rotating table 0.8 meters (for 30MHz ~ 1GHz) / 1.5 meters (for above 1GHz) above the ground at 3 meter chamber room for test. The table was rotated 360 degrees to determine the position of the highest radiation.
- b. The EUT was set 3 meters away from the interference-receiving antenna, which was mounted on the top of a variable-height antenna tower.
- c. The height of antenna is varied from one meter to four meters above the ground to determine the maximum value of the field strength. Both horizontal and vertical polarizations of the antenna are set to make the measurement.
- d. For each suspected emission, the EUT was arranged to its worst case and then the antenna was tuned to heights from 1 meter to 4 meters and the rotatable table was turned from 0 degrees to 360 degrees to find the maximum reading.
- e. The test-receiver system was set to quasi-peak detect function and specified bandwidth with maximum hold mode when the test frequency is below 1 GHz.
- f. The test-receiver system was set to peak and average detect function and specified bandwidth with maximum hold mode when the test frequency is above 1 GHz. If the peak reading value also meets average limit, measurement with the average detector is unnecessary.

##### **Note:**

1. The resolution bandwidth and video bandwidth of test receiver/spectrum analyzer is 120kHz for Quasi-peak detection (QP) at frequency below 1GHz.
2. The resolution bandwidth of test receiver/spectrum analyzer is 1 MHz and the video bandwidth is 3 MHz for Peak detection (PK) at frequency above 1GHz.
3. The resolution bandwidth of test receiver/spectrum analyzer is 1MHz and the video bandwidth is  $\geq 1/T$  (Duty cycle  $< 98\%$ ) or 10Hz (Duty cycle  $\geq 98\%$ ) for Average detection (AV) at frequency above 1GHz.
4. All modes of operation were investigated and the worst-case emissions are reported.

#### 4.1.4 Deviation from Test Standard

No deviation.

#### 4.1.5 Test Setup

##### For Radiated emission below 30MHz

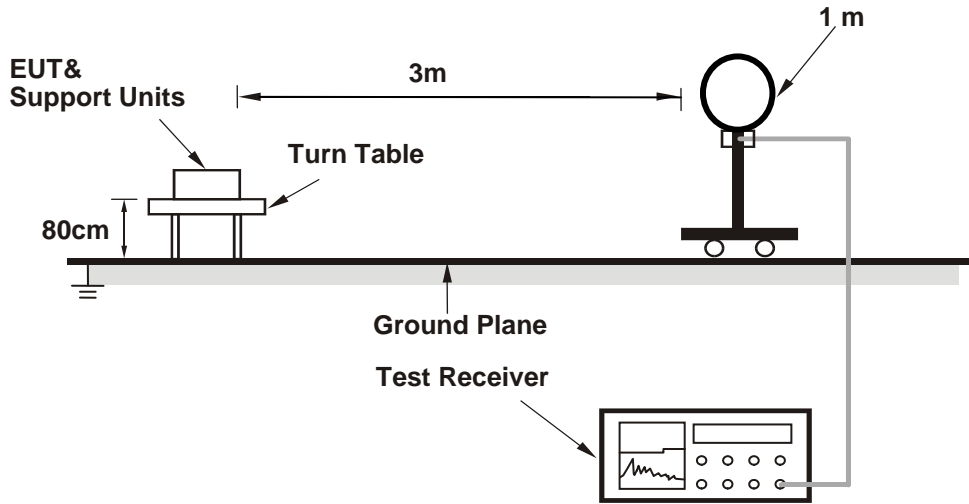

##### For Radiated emission 30MHz to 1GHz

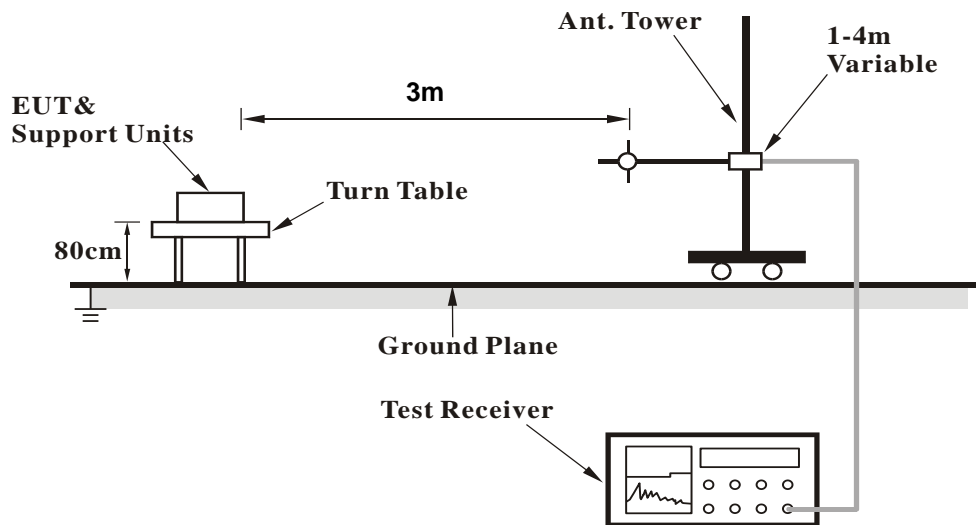

### For Radiated emission above 1GHz

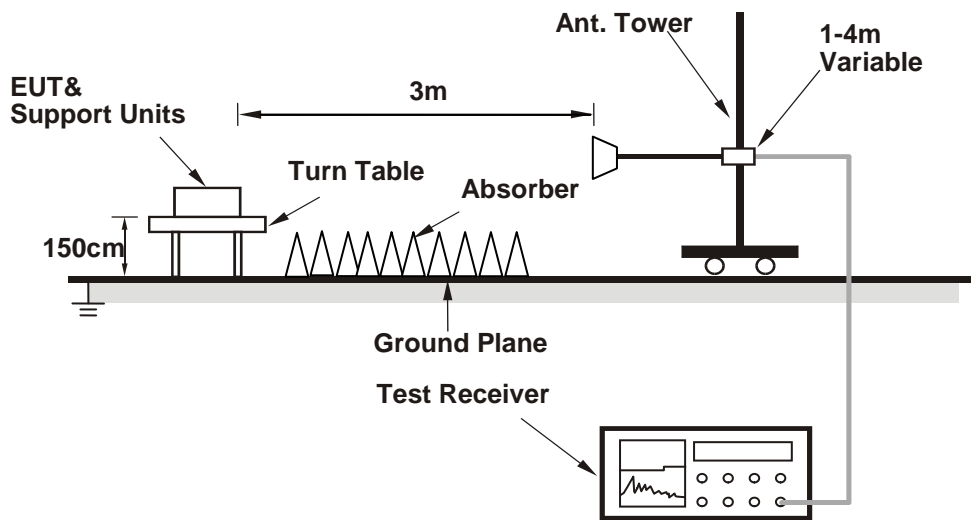

For the actual test configuration, please refer to the attached file (Test Setup Photo).

#### 4.1.6 EUT Operating Conditions

- a. Placed the EUT on the testing table.
- b. Controlling software (Press "Num\_Lock" key, then "Notepad" ) has been activated to set the EUT on specific status.

## 4.1.7 Test Results (Mode 1)

## Technology LE 1M (BT 4.0)

## Above 1GHz Data:

<b>CHANNEL</b>	TX Channel 0	<b>DETECTOR FUNCTION</b>	Peak (PK)
<b>FREQUENCY RANGE</b>	1GHz ~ 25GHz		Average (AV)

**ANTENNA POLARITY & TEST DISTANCE: HORIZONTAL AT 3 M**

NO.	FREQ. (MHz)	EMISSION LEVEL (dBuV/m)	LIMIT (dBuV/m)	MARGIN (dB)	ANTENNA HEIGHT (m)	TABLE ANGLE (Degree)	RAW VALUE (dBuV)	CORRECTION FACTOR (dB/m)
1	2370.00	55.2 PK	74.0	-18.8	1.30 H	244	57.3	-2.1
2	<b>2370.00</b>	<b>50.9 AV</b>	<b>54.0</b>	<b>-3.1</b>	<b>1.30 H</b>	<b>244</b>	<b>53.0</b>	<b>-2.1</b>
3	2390.00	53.6 PK	74.0	-20.4	1.30 H	244	55.8	-2.2
4	2390.00	48.9 AV	54.0	-5.1	1.30 H	244	51.1	-2.2
5	*2402.00	106.3 PK			1.30 H	244	108.6	-2.3
6	*2402.00	105.6 AV			1.30 H	244	107.9	-2.3
7	4804.00	51.9 PK	74.0	-22.1	1.18 H	261	50.1	1.8
8	4804.00	48.2 AV	54.0	-5.8	1.18 H	261	46.4	1.8

**ANTENNA POLARITY & TEST DISTANCE: VERTICAL AT 3 M**

NO.	FREQ. (MHz)	EMISSION LEVEL (dBuV/m)	LIMIT (dBuV/m)	MARGIN (dB)	ANTENNA HEIGHT (m)	TABLE ANGLE (Degree)	RAW VALUE (dBuV)	CORRECTION FACTOR (dB/m)
1	2370.00	53.2 PK	74.0	-20.8	2.59 V	292	55.3	-2.1
2	2370.00	49.4 AV	54.0	-4.6	2.59 V	292	51.5	-2.1
3	2390.00	52.9 PK	74.0	-21.1	2.59 V	292	55.1	-2.2
4	2390.00	48.0 AV	54.0	-6.0	2.59 V	292	50.2	-2.2
5	*2402.00	105.1 PK			2.59 V	292	107.4	-2.3
6	*2402.00	104.9 AV			2.59 V	292	107.2	-2.3
7	4804.00	52.2 PK	74.0	-21.8	3.42 V	298	50.4	1.8
8	4804.00	47.7 AV	54.0	-6.3	3.42 V	298	45.9	1.8

**REMARKS:**

1. Emission Level(dBuV/m) = Raw Value(dBuV) + Correction Factor(dB/m)
2. Correction Factor(dB/m) = Antenna Factor(dB/m) + Cable Factor(dB) – Pre-Amplifier Factor(dB)
3. The other emission levels were very low against the limit.
4. Margin value = Emission Level – Limit value
5. " \* ": Fundamental frequency.

<b>CHANNEL</b>	TX Channel 19	<b>DETECTOR FUNCTION</b>	Peak (PK)
<b>FREQUENCY RANGE</b>	1GHz ~ 25GHz		Average (AV)

**ANTENNA POLARITY & TEST DISTANCE: HORIZONTAL AT 3 M**

NO.	FREQ. (MHz)	EMISSION LEVEL (dBuV/m)	LIMIT (dBuV/m)	MARGIN (dB)	ANTENNA HEIGHT (m)	TABLE ANGLE (Degree)	RAW VALUE (dBuV)	CORRECTION FACTOR (dB/m)
1	*2440.00	105.4 PK			1.33 H	244	108.0	-2.6
2	*2440.00	104.0 AV			1.33 H	244	106.6	-2.6
3	4880.00	52.4 PK	74.0	-21.6	1.23 H	258	50.4	2.0
4	4880.00	48.7 AV	54.0	-5.3	1.23 H	258	46.7	2.0
5	7320.00	52.9 PK	74.0	-21.1	2.18 H	117	44.5	8.4
6	7320.00	43.1 AV	54.0	-10.9	2.18 H	117	34.7	8.4

**ANTENNA POLARITY & TEST DISTANCE: VERTICAL AT 3 M**

NO.	FREQ. (MHz)	EMISSION LEVEL (dBuV/m)	LIMIT (dBuV/m)	MARGIN (dB)	ANTENNA HEIGHT (m)	TABLE ANGLE (Degree)	RAW VALUE (dBuV)	CORRECTION FACTOR (dB/m)
1	*2440.00	104.6 PK			2.60 V	292	107.2	-2.6
2	*2440.00	103.2 AV			2.60 V	292	105.8	-2.6
3	4880.00	52.7 PK	74.0	-21.3	3.43 V	284	50.7	2.0
4	4880.00	48.2 AV	54.0	-5.8	3.43 V	284	46.2	2.0
5	7320.00	55.6 PK	74.0	-18.4	1.31 V	111	47.2	8.4
6	7320.00	48.6 AV	54.0	-5.4	1.31 V	111	40.2	8.4

**REMARKS:**

1. Emission Level(dBuV/m) = Raw Value(dBuV) + Correction Factor(dB/m)
2. Correction Factor(dB/m) = Antenna Factor(dB/m) + Cable Factor(dB) – Pre-Amplifier Factor(dB)
3. The other emission levels were very low against the limit.
4. Margin value = Emission Level – Limit value
5. " \* ": Fundamental frequency.

<b>CHANNEL</b>	TX Channel 39	<b>DETECTOR FUNCTION</b>	Peak (PK)
<b>FREQUENCY RANGE</b>	1GHz ~ 25GHz		Average (AV)

**ANTENNA POLARITY & TEST DISTANCE: HORIZONTAL AT 3 M**

NO.	FREQ. (MHz)	EMISSION LEVEL (dBuV/m)	LIMIT (dBuV/m)	MARGIN (dB)	ANTENNA HEIGHT (m)	TABLE ANGLE (Degree)	RAW VALUE (dBuV)	CORRECTION FACTOR (dB/m)
1	*2480.00	104.2 PK			1.45 H	239	106.8	-2.6
2	*2480.00	103.1 AV			1.45 H	239	105.7	-2.6
3	2483.50	53.7 PK	74.0	-20.3	1.45 H	239	56.1	-2.4
4	2483.50	48.9 AV	54.0	-5.1	1.45 H	239	51.3	-2.4
5	4960.00	52.5 PK	74.0	-21.5	1.20 H	254	50.4	2.1
6	4960.00	48.7 AV	54.0	-5.3	1.20 H	254	46.6	2.1
7	7440.00	52.7 PK	74.0	-21.3	2.17 H	104	43.9	8.8
8	7440.00	43.0 AV	54.0	-11.0	2.17 H	104	34.2	8.8

**ANTENNA POLARITY & TEST DISTANCE: VERTICAL AT 3 M**

NO.	FREQ. (MHz)	EMISSION LEVEL (dBuV/m)	LIMIT (dBuV/m)	MARGIN (dB)	ANTENNA HEIGHT (m)	TABLE ANGLE (Degree)	RAW VALUE (dBuV)	CORRECTION FACTOR (dB/m)
1	*2480.00	103.4 PK			2.64 V	284	106.0	-2.6
2	*2480.00	102.3 AV			2.64 V	284	104.9	-2.6
3	2483.50	52.2 PK	74.0	-21.8	2.64 V	284	54.6	-2.4
4	2483.50	47.6 AV	54.0	-6.4	2.64 V	284	50.0	-2.4
5	4960.00	52.1 PK	74.0	-21.9	3.38 V	288	50.0	2.1
6	4960.00	47.8 AV	54.0	-6.2	3.38 V	288	45.7	2.1
7	7440.00	56.2 PK	74.0	-17.8	1.35 V	107	47.4	8.8
8	7440.00	48.9 AV	54.0	-5.1	1.35 V	107	40.1	8.8

**REMARKS:**

1. Emission Level(dBuV/m) = Raw Value(dBuV) + Correction Factor(dB/m)
2. Correction Factor(dB/m) = Antenna Factor(dB/m) + Cable Factor(dB) – Pre-Amplifier Factor(dB)
3. The other emission levels were very low against the limit.
4. Margin value = Emission Level – Limit value
5. " \* ": Fundamental frequency.

**Below 1GHz Data:**

<b>CHANNEL</b>	TX Channel 39	<b>DETECTOR FUNCTION</b>	Quasi-Peak (QP)
<b>FREQUENCY RANGE</b>	9kHz ~ 1GHz		

**ANTENNA POLARITY & TEST DISTANCE: HORIZONTAL AT 3 M**

NO.	FREQ. (MHz)	EMISSION LEVEL (dBuV/m)	LIMIT (dBuV/m)	MARGIN (dB)	ANTENNA HEIGHT (m)	TABLE ANGLE (Degree)	RAW VALUE (dBuV)	CORRECTION FACTOR (dB/m)
1	114.34	37.0 QP	43.5	-6.5	1.50 H	264	47.2	-10.2
2	166.04	37.1 QP	43.5	-6.4	1.50 H	314	45.1	-8.0
3	225.09	35.3 QP	46.0	-10.7	1.50 H	199	46.4	-11.1
4	272.45	32.1 QP	46.0	-13.9	1.00 H	312	40.0	-7.9
5	466.45	28.1 QP	46.0	-17.9	1.50 H	245	30.5	-2.4
6	655.19	28.8 QP	46.0	-17.2	1.00 H	180	27.4	1.4

**ANTENNA POLARITY & TEST DISTANCE: VERTICAL AT 3 M**

NO.	FREQ. (MHz)	EMISSION LEVEL (dBuV/m)	LIMIT (dBuV/m)	MARGIN (dB)	ANTENNA HEIGHT (m)	TABLE ANGLE (Degree)	RAW VALUE (dBuV)	CORRECTION FACTOR (dB/m)
1	72.92	26.9 QP	40.0	-13.1	1.00 V	68	37.5	-10.6
2	166.04	32.6 QP	43.5	-10.9	1.00 V	234	40.6	-8.0
3	225.87	31.6 QP	46.0	-14.4	1.00 V	52	42.7	-11.1
4	291.61	31.5 QP	46.0	-14.5	2.00 V	210	38.8	-7.3
5	589.35	28.7 QP	46.0	-17.3	1.50 V	316	28.5	0.2
6	759.49	31.8 QP	46.0	-14.2	1.50 V	283	28.5	3.3

**REMARKS:**

1. Emission Level(dBuV/m) = Raw Value(dBuV) + Correction Factor(dB/m)
2. Correction Factor(dB/m) = Antenna Factor(dB/m) + Cable Factor(dB) – Pre-Amplifier Factor(dB)
3. The other emission levels were very low against the limit.
4. Margin value = Emission Level – Limit value

**Technology LE 2M (BT 5.0)**

**Above 1GHz Data:**

<b>CHANNEL</b>	TX Channel 1	<b>DETECTOR FUNCTION</b>	Peak (PK)
<b>FREQUENCY RANGE</b>	1GHz ~ 25GHz		Average (AV)

**ANTENNA POLARITY & TEST DISTANCE: HORIZONTAL AT 3 M**

NO.	FREQ. (MHz)	EMISSION LEVEL (dBuV/m)	LIMIT (dBuV/m)	MARGIN (dB)	ANTENNA HEIGHT (m)	TABLE ANGLE (Degree)	RAW VALUE (dBuV)	CORRECTION FACTOR (dB/m)
1	2390.00	54.4 PK	74.0	-19.6	1.01 H	247	56.6	-2.2
2	2390.00	50.3 AV	54.0	-3.7	1.01 H	247	52.5	-2.2
3	*2404.00	106.4 PK			1.01 H	247	108.7	-2.3
4	*2404.00	105.7 AV			1.01 H	247	108.0	-2.3
5	4808.00	52.9 PK	74.0	-21.1	1.16 H	244	51.1	1.8
6	4808.00	48.8 AV	54.0	-5.2	1.16 H	244	47.0	1.8

**ANTENNA POLARITY & TEST DISTANCE: VERTICAL AT 3 M**

NO.	FREQ. (MHz)	EMISSION LEVEL (dBuV/m)	LIMIT (dBuV/m)	MARGIN (dB)	ANTENNA HEIGHT (m)	TABLE ANGLE (Degree)	RAW VALUE (dBuV)	CORRECTION FACTOR (dB/m)
1	2390.00	52.7 PK	74.0	-21.3	2.56 V	297	54.9	-2.2
2	2390.00	48.9 AV	54.0	-5.1	2.56 V	297	51.1	-2.2
3	*2404.00	105.8 PK			2.56 V	297	108.1	-2.3
4	*2404.00	104.9 AV			2.56 V	297	107.2	-2.3
5	4808.00	52.1 PK	74.0	-21.9	3.36 V	284	50.3	1.8
6	4808.00	47.6 AV	54.0	-6.4	3.36 V	284	45.8	1.8

**REMARKS:**

1. Emission Level(dBuV/m) = Raw Value(dBuV) + Correction Factor(dB/m)
2. Correction Factor(dB/m) = Antenna Factor(dB/m) + Cable Factor(dB) – Pre-Amplifier Factor(dB)
3. The other emission levels were very low against the limit.
4. Margin value = Emission Level – Limit value
5. " \* ": Fundamental frequency.



<b>CHANNEL</b>	TX Channel 19	<b>DETECTOR FUNCTION</b>	Peak (PK)
<b>FREQUENCY RANGE</b>	1GHz ~ 25GHz		Average (AV)

**ANTENNA POLARITY & TEST DISTANCE: HORIZONTAL AT 3 M**

NO.	FREQ. (MHz)	EMISSION LEVEL (dBuV/m)	LIMIT (dBuV/m)	MARGIN (dB)	ANTENNA HEIGHT (m)	TABLE ANGLE (Degree)	RAW VALUE (dBuV)	CORRECTION FACTOR (dB/m)
1	*2440.00	105.1 PK			1.31 H	246	107.7	-2.6
2	*2440.00	104.1 AV			1.31 H	246	106.7	-2.6
3	4880.00	53.0 PK	74.0	-21.0	1.16 H	267	51.0	2.0
4	4880.00	49.0 AV	54.0	-5.0	1.16 H	267	47.0	2.0
5	7320.00	52.9 PK	74.0	-21.1	2.11 H	94	44.5	8.4
6	7320.00	43.2 AV	54.0	-10.8	2.11 H	94	34.8	8.4

**ANTENNA POLARITY & TEST DISTANCE: VERTICAL AT 3 M**

NO.	FREQ. (MHz)	EMISSION LEVEL (dBuV/m)	LIMIT (dBuV/m)	MARGIN (dB)	ANTENNA HEIGHT (m)	TABLE ANGLE (Degree)	RAW VALUE (dBuV)	CORRECTION FACTOR (dB/m)
1	*2440.00	104.2 PK			2.53 V	292	106.8	-2.6
2	*2440.00	103.5 AV			2.53 V	292	106.1	-2.6
3	4880.00	52.3 PK	74.0	-21.7	3.37 V	303	50.3	2.0
4	4880.00	47.8 AV	54.0	-6.2	3.37 V	303	45.8	2.0
5	7320.00	56.2 PK	74.0	-17.8	1.30 V	98	47.8	8.4
6	7320.00	48.7 AV	54.0	-5.3	1.30 V	98	40.3	8.4

**REMARKS:**

1. Emission Level(dBuV/m) = Raw Value(dBuV) + Correction Factor(dB/m)
2. Correction Factor(dB/m) = Antenna Factor(dB/m) + Cable Factor(dB) – Pre-Amplifier Factor(dB)
3. The other emission levels were very low against the limit.
4. Margin value = Emission Level – Limit value
5. " \* ": Fundamental frequency.

<b>CHANNEL</b>	TX Channel 38	<b>DETECTOR FUNCTION</b>	Peak (PK)
<b>FREQUENCY RANGE</b>	1GHz ~ 25GHz		Average (AV)

**ANTENNA POLARITY & TEST DISTANCE: HORIZONTAL AT 3 M**

NO.	FREQ. (MHz)	EMISSION LEVEL (dBuV/m)	LIMIT (dBuV/m)	MARGIN (dB)	ANTENNA HEIGHT (m)	TABLE ANGLE (Degree)	RAW VALUE (dBuV)	CORRECTION FACTOR (dB/m)
1	*2478.00	103.8 PK			1.18 H	256	106.4	-2.6
2	*2478.00	103.1 AV			1.18 H	256	105.7	-2.6
3	2483.50	54.6 PK	74.0	-19.4	1.18 H	256	57.0	-2.4
4	2483.50	45.8 AV	54.0	-8.2	1.18 H	256	48.2	-2.4
5	4956.00	52.5 PK	74.0	-21.5	1.24 H	262	50.4	2.1
6	4956.00	48.7 AV	54.0	-5.3	1.24 H	262	46.6	2.1
7	7434.00	53.1 PK	74.0	-20.9	2.19 H	114	44.3	8.8
8	7434.00	43.1 AV	54.0	-10.9	2.19 H	114	34.3	8.8

**ANTENNA POLARITY & TEST DISTANCE: VERTICAL AT 3 M**

NO.	FREQ. (MHz)	EMISSION LEVEL (dBuV/m)	LIMIT (dBuV/m)	MARGIN (dB)	ANTENNA HEIGHT (m)	TABLE ANGLE (Degree)	RAW VALUE (dBuV)	CORRECTION FACTOR (dB/m)
1	*2478.00	103.1 PK			2.55 V	282	105.7	-2.6
2	*2478.00	102.4 AV			2.55 V	282	105.0	-2.6
3	2483.50	53.2 PK	74.0	-20.8	2.55 V	282	55.6	-2.4
4	2483.50	44.1 AV	54.0	-9.9	2.55 V	282	46.5	-2.4
5	4956.00	52.1 PK	74.0	-21.9	3.40 V	273	50.0	2.1
6	4956.00	47.7 AV	54.0	-6.3	3.40 V	273	45.6	2.1
7	7434.00	56.6 PK	74.0	-17.4	1.37 V	101	47.8	8.8
8	7434.00	49.3 AV	54.0	-4.7	1.37 V	101	40.5	8.8

**REMARKS:**

1. Emission Level(dBuV/m) = Raw Value(dBuV) + Correction Factor(dB/m)
2. Correction Factor(dB/m) = Antenna Factor(dB/m) + Cable Factor(dB) – Pre-Amplifier Factor(dB)
3. The other emission levels were very low against the limit.
4. Margin value = Emission Level – Limit value
5. " \* ": Fundamental frequency.

**Below 1GHz Data:**

<b>CHANNEL</b>	TX Channel 38	<b>DETECTOR FUNCTION</b>	Quasi-Peak (QP)
<b>FREQUENCY RANGE</b>	9kHz ~ 1GHz		

**ANTENNA POLARITY & TEST DISTANCE: HORIZONTAL AT 3 M**

NO.	FREQ. (MHz)	EMISSION LEVEL (dBuV/m)	LIMIT (dBuV/m)	MARGIN (dB)	ANTENNA HEIGHT (m)	TABLE ANGLE (Degree)	RAW VALUE (dBuV)	CORRECTION FACTOR (dB/m)
1	110.34	31.2 QP	43.5	-12.3	1.00 H	302	41.9	-10.7
2	166.02	36.9 QP	43.5	-6.6	1.50 H	313	44.9	-8.0
3	224.56	37.7 QP	46.0	-8.3	1.00 H	290	48.9	-11.2
4	266.53	32.1 QP	46.0	-13.9	1.00 H	293	40.4	-8.3
5	464.75	29.5 QP	46.0	-16.5	1.50 H	256	31.9	-2.4
6	640.78	28.8 QP	46.0	-17.2	1.50 H	65	27.4	1.4

**ANTENNA POLARITY & TEST DISTANCE: VERTICAL AT 3 M**

NO.	FREQ. (MHz)	EMISSION LEVEL (dBuV/m)	LIMIT (dBuV/m)	MARGIN (dB)	ANTENNA HEIGHT (m)	TABLE ANGLE (Degree)	RAW VALUE (dBuV)	CORRECTION FACTOR (dB/m)
1	119.09	26.5 QP	43.5	-17.0	1.00 V	197	36.3	-9.8
2	182.53	36.3 QP	43.5	-7.2	1.00 V	336	46.1	-9.8
3	217.43	35.2 QP	46.0	-10.8	1.00 V	328	46.4	-11.2
4	296.02	29.6 QP	46.0	-16.4	1.50 V	204	36.8	-7.2
5	433.52	25.8 QP	46.0	-20.2	1.00 V	213	28.8	-3.0
6	647.89	28.9 QP	46.0	-17.1	2.00 V	246	27.5	1.4

**REMARKS:**

1. Emission Level(dBuV/m) = Raw Value(dBuV) + Correction Factor(dB/m)
2. Correction Factor(dB/m) = Antenna Factor(dB/m) + Cable Factor(dB) – Pre-Amplifier Factor(dB)
3. The other emission levels were very low against the limit.
4. Margin value = Emission Level – Limit value

## 4.2 Conducted Emission Measurement

### 4.2.1 Limits of Conducted Emission Measurement

Frequency (MHz)	Conducted Limit (dBuV)	
	Quasi-peak	Average
0.15 - 0.5	66 - 56	56 - 46
0.50 - 5.0	56	46
5.0 - 30.0	60	50

Note: 1. The lower limit shall apply at the transition frequencies.

2. The limit decreases in line with the logarithm of the frequency in the range of 0.15 to 0.50MHz.

### 4.2.2 Test Instruments

DESCRIPTION & MANUFACTURER	MODEL NO.	SERIAL NO.	CALIBRATED DATE	CALIBRATED UNTIL
Test Receiver R&S	ESCS 30	847124/029	Nov. 01, 2017	Oct. 31, 2018
Line-Impedance Stabilization Network (for EUT) R&S	ESH3-Z5	848773/004	Nov. 15, 2017	Nov. 14, 2018
Line-Impedance Stabilization Network (for Peripheral) R&S	ENV216	100072	June 04, 2018	June 03, 2019
50 ohms Terminator	N/A	EMC-02	Sep. 22, 2017	Sep. 21, 2018
RF Cable	5D-FB	COCCAB-001	Sep. 29, 2017	Sep. 28, 2018
Fixed attenuator EMCI	STI02-2200-10	003	Mar. 16, 2018	Mar. 15, 2019
Software BVADT	BVADT_Cond_ V7.3.7.4	NA	NA	NA

**Note:**

1. The calibration interval of the above test instruments are 12 months and the calibrations are traceable to NML/ROC and NIST/USA.
2. The test was performed in Conduction 1.
3. Tested Date: Aug. 09, 2018

#### 4.2.3 Test Procedures

- The EUT was placed 0.4 meters from the conducting wall of the shielded room with EUT being connected to the power mains through a line impedance stabilization network (LISN). Other support units were connected to the power mains through another LISN. The two LISNs provide 50 ohm/ 50uH of coupling impedance for the measuring instrument.
- Both lines of the power mains connected to the EUT were checked for maximum conducted interference.
- The frequency range from 150kHz to 30MHz was searched. Emission levels under (Limit - 20dB) was not recorded.

**NOTE:** The resolution bandwidth and video bandwidth of test receiver is 9kHz for quasi-peak detection (QP) and average detection (AV) at frequency 0.15MHz-30MHz.

#### 4.2.4 Deviation from Test Standard

No deviation.

#### 4.2.5 Test Setup

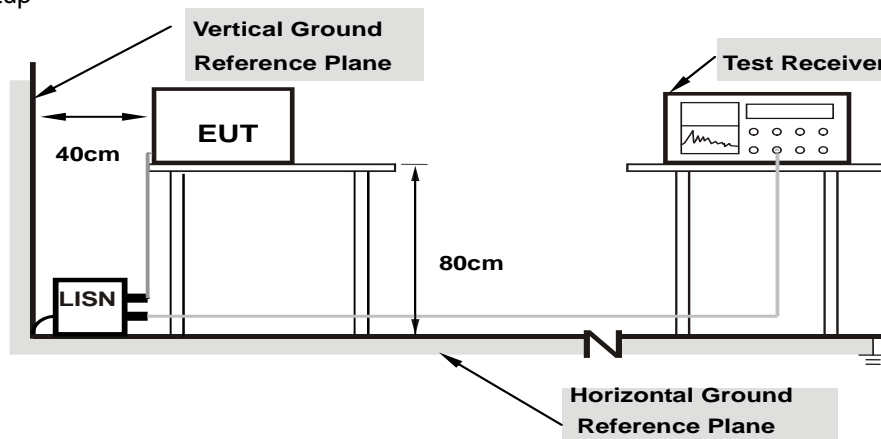

**Note:** 1.Support units were connected to second LISN.

For the actual test configuration, please refer to the attached file (Test Setup Photo).

#### 4.2.6 EUT Operating Conditions

Same as 4.1.6.

4.2.7 Test Results (Mode 1)

Technology LE 1M (BT 4.0)

Phase	Line (L)	Detector Function	Quasi-Peak (QP) / Average (AV)
-------	----------	-------------------	--------------------------------

No	Freq. [MHz]	Corr.	Reading Value		Emission Level		Limit		Margin	
		Factor	[dB (uV)]		[dB (uV)]		[dB (uV)]		(dB)	
	(dB)	Q.P.	AV.	Q.P.	AV.	Q.P.	AV.	Q.P.	AV.	
1	0.15000	10.05	35.92	22.51	45.97	32.56	66.00	56.00	-20.03	-23.44
2	0.19297	10.07	30.49	20.00	40.56	30.07	63.91	53.91	-23.35	-23.84
3	0.22812	10.08	26.39	12.84	36.47	22.92	62.52	52.52	-26.05	-29.60
4	0.36484	10.11	27.04	12.98	37.15	23.09	58.62	48.62	-21.47	-25.53
5	3.97266	10.34	22.49	8.39	32.83	18.73	56.00	46.00	-23.17	-27.27
6	14.31250	11.01	20.12	12.35	31.13	23.36	60.00	50.00	-28.87	-26.64

REMARKS:

1. Q.P. and AV. are abbreviations of quasi-peak and average individually.
2. The emission levels of other frequencies were very low against the limit.
3. Margin value = Emission level - Limit value
4. Correction factor = Insertion loss + Cable loss
5. Emission Level = Correction Factor + Reading Value.

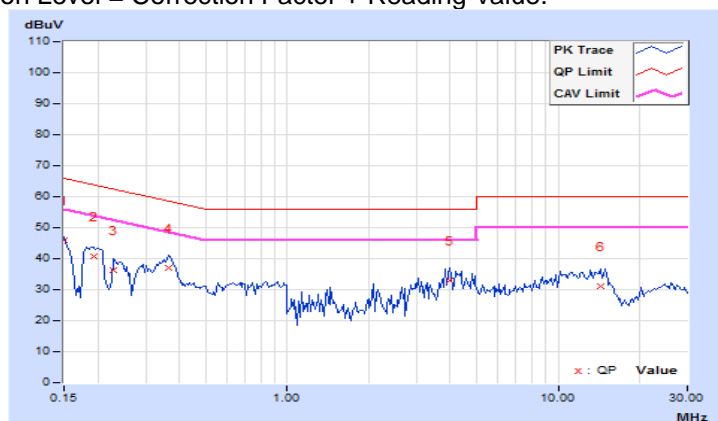

Phase	Neutral (N)	Detector Function	Quasi-Peak (QP) / Average (AV)
-------	-------------	-------------------	--------------------------------

No	Freq. [MHz]	Corr. Factor	Reading Value [dB (uV)]		Emission Level [dB (uV)]		Limit [dB (uV)]		Margin (dB)	
		(dB)	Q.P.	AV.	Q.P.	AV.	Q.P.	AV.	Q.P.	AV.
	1	0.15000	9.95	33.32	17.50	43.27	27.45	66.00	56.00	-22.73
2	0.18516	9.97	29.08	14.34	39.05	24.31	64.25	54.25	-25.20	-29.94
3	0.37266	10.01	26.11	14.25	36.12	24.26	58.44	48.44	-22.32	-24.18
4	0.98984	10.04	20.70	7.42	30.74	17.46	56.00	46.00	-25.26	-28.54
5	4.02734	10.19	24.25	9.52	34.44	19.71	56.00	46.00	-21.56	-26.29
6	10.88672	10.60	20.26	9.79	30.86	20.39	60.00	50.00	-29.14	-29.61

**REMARKS:**

1. Q.P. and AV. are abbreviations of quasi-peak and average individually.
2. The emission levels of other frequencies were very low against the limit.
3. Margin value = Emission level - Limit value
4. Correction factor = Insertion loss + Cable loss
5. Emission Level = Correction Factor + Reading Value.

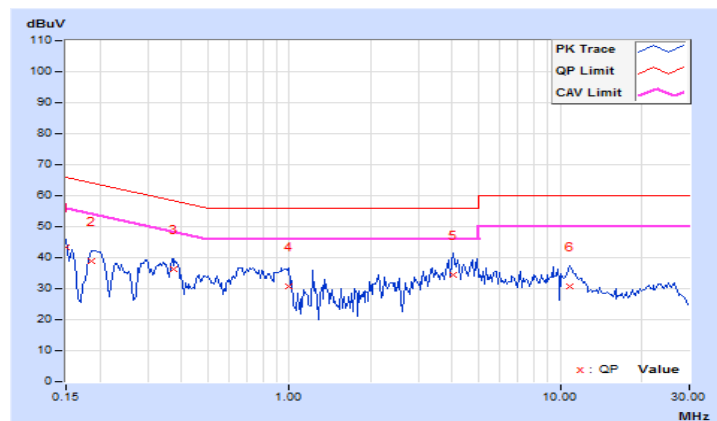

**Technology LE 2M (BT 5.0)**

Phase	Line (L)	Detector Function	Quasi-Peak (QP) / Average (AV)
-------	----------	-------------------	--------------------------------

No	Freq. [MHz]	Corr.	Reading Value		Emission Level		Limit		Margin	
		Factor	[dB (uV)]		[dB (uV)]		[dB (uV)]		(dB)	
	(dB)	Q.P.	AV.	Q.P.	AV.	Q.P.	AV.	Q.P.	AV.	
1	0.15000	10.05	34.78	22.13	44.83	32.18	66.00	56.00	-21.17	-23.82
2	0.18906	10.06	30.26	19.98	40.32	30.04	64.08	54.08	-23.76	-24.04
3	0.36875	10.11	28.10	14.73	38.21	24.84	58.53	48.53	-20.32	-23.69
4	3.11719	10.29	19.86	5.61	30.15	15.90	56.00	46.00	-25.85	-30.10
5	4.30469	10.36	22.64	8.12	33.00	18.48	56.00	46.00	-23.00	-27.52
6	14.71094	11.04	19.73	11.52	30.77	22.56	60.00	50.00	-29.23	-27.44

**REMARKS:**

1. Q.P. and AV. are abbreviations of quasi-peak and average individually.
2. The emission levels of other frequencies were very low against the limit.
3. Margin value = Emission level - Limit value
4. Correction factor = Insertion loss + Cable loss
5. Emission Level = Correction Factor + Reading Value.

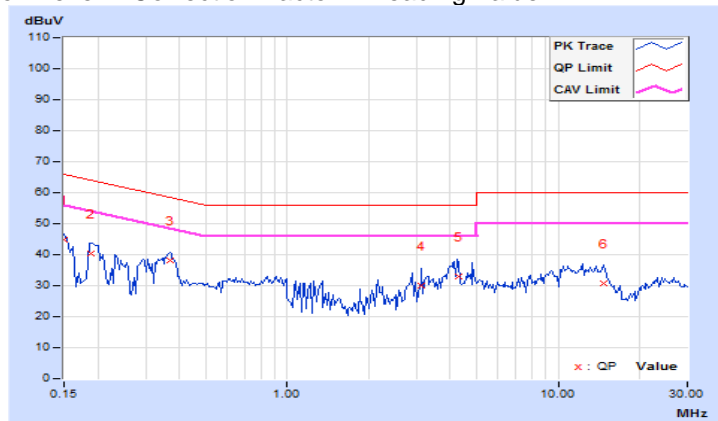



Phase	Neutral (N)	Detector Function	Quasi-Peak (QP) / Average (AV)
-------	-------------	-------------------	--------------------------------

No	Freq. [MHz]	Corr. Factor	Reading Value [dB (uV)]		Emission Level [dB (uV)]		Limit [dB (uV)]		Margin (dB)	
		(dB)	Q.P.	AV.	Q.P.	AV.	Q.P.	AV.	Q.P.	AV.
	1	0.15000	9.95	32.47	15.75	42.42	25.70	66.00	56.00	-23.58
2	0.30234	10.00	24.11	10.38	34.11	20.38	60.18	50.18	-26.07	-29.80
3	0.73984	10.03	21.61	7.05	31.64	17.08	56.00	46.00	-24.36	-28.92
4	4.14453	10.20	25.80	10.96	36.00	21.16	56.00	46.00	-20.00	-24.84
5	10.53516	10.57	21.03	9.87	31.60	20.44	60.00	50.00	-28.40	-29.56
6	25.62500	11.23	15.10	2.00	26.33	13.23	60.00	50.00	-33.67	-36.77

**REMARKS:**

1. Q.P. and AV. are abbreviations of quasi-peak and average individually.
2. The emission levels of other frequencies were very low against the limit.
3. Margin value = Emission level - Limit value
4. Correction factor = Insertion loss + Cable loss
5. Emission Level = Correction Factor + Reading Value.

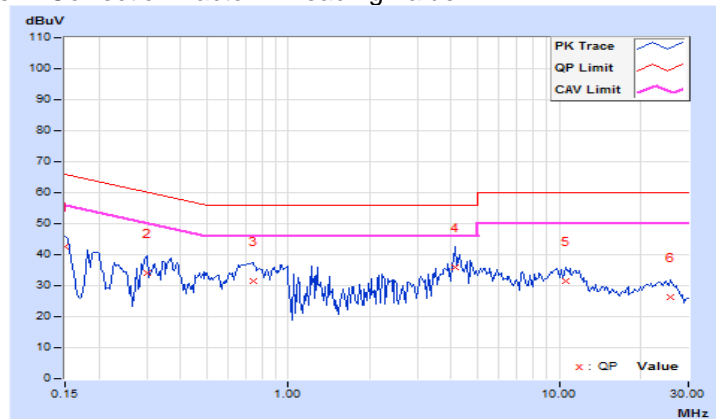

4.2.8 Test Results (Mode 2)  
Technology LE 1M (BT 4.0)

Phase	Line (L)	Detector Function	Quasi-Peak (QP) / Average (AV)
-------	----------	-------------------	--------------------------------

No	Freq. [MHz]	Corr.	Reading Value		Emission Level		Limit		Margin	
		Factor	[dB (uV)]		[dB (uV)]		[dB (uV)]		(dB)	
	(dB)	Q.P.	AV.	Q.P.	AV.	Q.P.	AV.	Q.P.	AV.	
1	0.15000	10.03	37.00	15.36	47.03	25.39	66.00	56.00	-18.97	-30.61
2	0.22422	10.07	27.03	10.18	37.10	20.25	62.66	52.66	-25.56	-32.41
3	1.99609	10.19	23.69	15.20	33.88	25.39	56.00	46.00	-22.12	-20.61
4	3.74609	10.26	24.76	17.94	35.02	28.20	56.00	46.00	-20.98	-17.80
5	7.66406	10.43	20.85	14.79	31.28	25.22	60.00	50.00	-28.72	-24.78
6	12.32422	10.67	21.14	14.64	31.81	25.31	60.00	50.00	-28.19	-24.69

**REMARKS:**

1. Q.P. and AV. are abbreviations of quasi-peak and average individually.
2. The emission levels of other frequencies were very low against the limit.
3. Margin value = Emission level - Limit value
4. Correction factor = Insertion loss + Cable loss
5. Emission Level = Correction Factor + Reading Value.

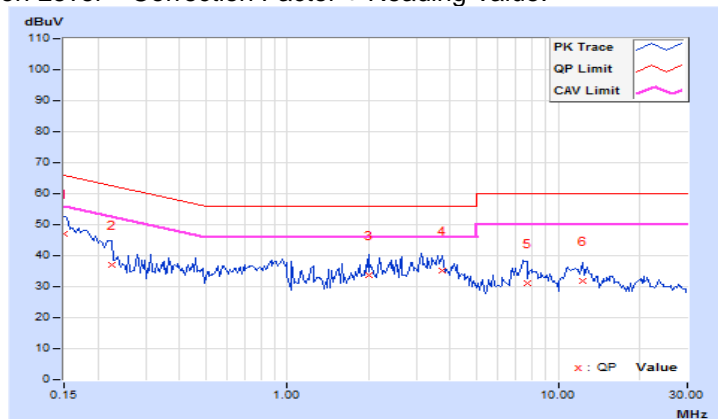

Phase	Neutral (N)	Detector Function	Quasi-Peak (QP) / Average (AV)
-------	-------------	-------------------	--------------------------------

No	Freq. [MHz]	Corr. Factor	Reading Value [dB (uV)]		Emission Level [dB (uV)]		Limit [dB (uV)]		Margin (dB)	
		(dB)	Q.P.	AV.	Q.P.	AV.	Q.P.	AV.	Q.P.	AV.
	1	0.15000	9.94	38.44	15.93	48.38	25.87	66.00	56.00	-17.62
2	0.22812	9.97	28.52	9.10	38.49	19.07	62.52	52.52	-24.03	-33.45
3	0.90000	10.02	20.98	10.08	31.00	20.10	56.00	46.00	-25.00	-25.90
4	3.19141	10.11	25.16	18.14	35.27	28.25	56.00	46.00	-20.73	-17.75
5	7.64844	10.29	22.02	15.75	32.31	26.04	60.00	50.00	-27.69	-23.96
6	20.05078	10.90	17.79	11.86	28.69	22.76	60.00	50.00	-31.31	-27.24

**REMARKS:**

1. Q.P. and AV. are abbreviations of quasi-peak and average individually.
2. The emission levels of other frequencies were very low against the limit.
3. Margin value = Emission level - Limit value
4. Correction factor = Insertion loss + Cable loss
5. Emission Level = Correction Factor + Reading Value.

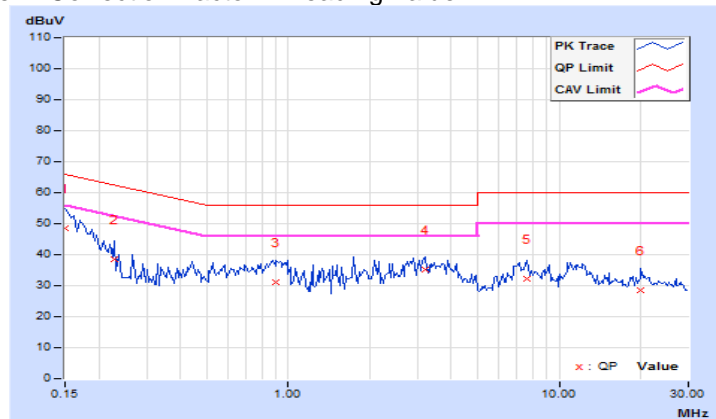

**Technology LE 2M (BT 5.0)**

Phase	Line (L)	Detector Function	Quasi-Peak (QP) / Average (AV)
-------	----------	-------------------	--------------------------------

No	Freq. [MHz]	Corr. Factor	Reading Value [dB (uV)]		Emission Level [dB (uV)]		Limit [dB (uV)]		Margin (dB)	
		(dB)	Q.P.	AV.	Q.P.	AV.	Q.P.	AV.	Q.P.	AV.
	1	0.15000	10.03	37.61	13.98	47.64	24.01	66.00	56.00	-18.36
2	0.15781	10.04	34.33	12.80	44.37	22.84	65.58	55.58	-21.21	-32.74
3	2.91797	10.23	25.12	17.96	35.35	28.19	56.00	46.00	-20.65	-17.81
4	3.55078	10.25	25.42	18.67	35.67	28.92	56.00	46.00	-20.33	-17.08
5	7.47656	10.43	21.34	14.99	31.77	25.42	60.00	50.00	-28.23	-24.58
6	20.17578	11.10	16.32	10.74	27.42	21.84	60.00	50.00	-32.58	-28.16

**REMARKS:**

1. Q.P. and AV. are abbreviations of quasi-peak and average individually.
2. The emission levels of other frequencies were very low against the limit.
3. Margin value = Emission level - Limit value
4. Correction factor = Insertion loss + Cable loss
5. Emission Level = Correction Factor + Reading Value.

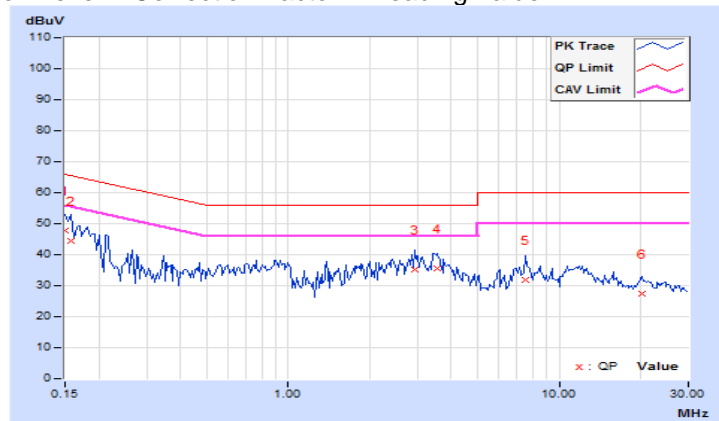

Phase	Neutral (N)	Detector Function	Quasi-Peak (QP) / Average (AV)
-------	-------------	-------------------	--------------------------------

No	Freq. [MHz]	Corr. Factor	Reading Value [dB (uV)]		Emission Level [dB (uV)]		Limit [dB (uV)]		Margin (dB)	
		(dB)	Q.P.	AV.	Q.P.	AV.	Q.P.	AV.	Q.P.	AV.
	<b>1</b>	<b>0.15000</b>	<b>9.94</b>	<b>40.31</b>	<b>15.38</b>	<b>50.25</b>	<b>25.32</b>	<b>66.00</b>	<b>56.00</b>	<b>-15.75</b>
2	0.18516	9.96	35.28	20.02	45.24	29.98	64.25	54.25	-19.01	-24.27
3	0.88047	10.02	21.49	10.06	31.51	20.08	56.00	46.00	-24.49	-25.92
4	2.73828	10.10	24.35	16.82	34.45	26.92	56.00	46.00	-21.55	-19.08
5	3.64844	10.13	24.71	17.85	34.84	27.98	56.00	46.00	-21.16	-18.02
6	11.83594	10.49	21.80	15.61	32.29	26.10	60.00	50.00	-27.71	-23.90

**REMARKS:**

1. Q.P. and AV. are abbreviations of quasi-peak and average individually.
2. The emission levels of other frequencies were very low against the limit.
3. Margin value = Emission level - Limit value
4. Correction factor = Insertion loss + Cable loss
5. Emission Level = Correction Factor + Reading Value.

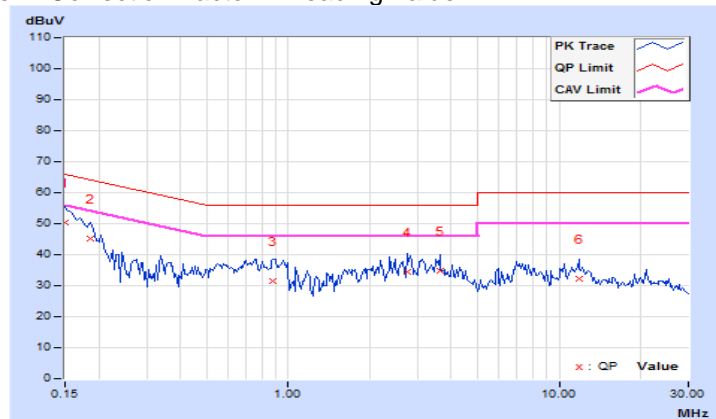

### 4.3 6dB Bandwidth Measurement

#### 4.3.1 Limits of 6dB Bandwidth Measurement

The minimum of 6dB Bandwidth Measurement is 0.5 MHz.

#### 4.3.2 Test Setup

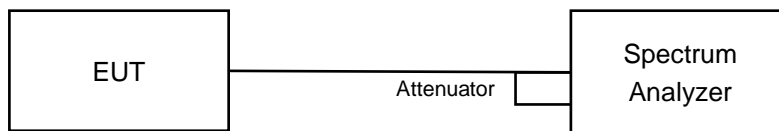

#### 4.3.3 Test Instruments

Refer to section 4.1.2 to get information of above instrument.

#### 4.3.4 Test Procedure

- a. Set resolution bandwidth (RBW) = 100kHz
- b. Set the video bandwidth (VBW)  $\geq 3 \times$  RBW, Detector = Peak.
- c. Trace mode = max hold.
- d. Sweep = auto couple.
- e. Measure the maximum width of the emission that is constrained by the frequencies associated with the two amplitude points (upper and lower) that are attenuated by 6 dB relative to the maximum level measured in the fundamental emission

#### 4.3.5 Deviation from Test Standard

No deviation.

#### 4.3.6 EUT Operating Conditions

The software provided by client to enable the EUT under transmission condition continuously at lowest, middle and highest channel frequencies individually.

4.3.7 Test Result (Mode 1)

Technology LE 1M (BT 4.0)

Channel	Frequency (MHz)	6dB Bandwidth (MHz)	Minimum Limit (MHz)	Pass / Fail
0	2402	0.69	0.5	Pass
19	2440	0.69	0.5	Pass
39	2480	0.70	0.5	Pass

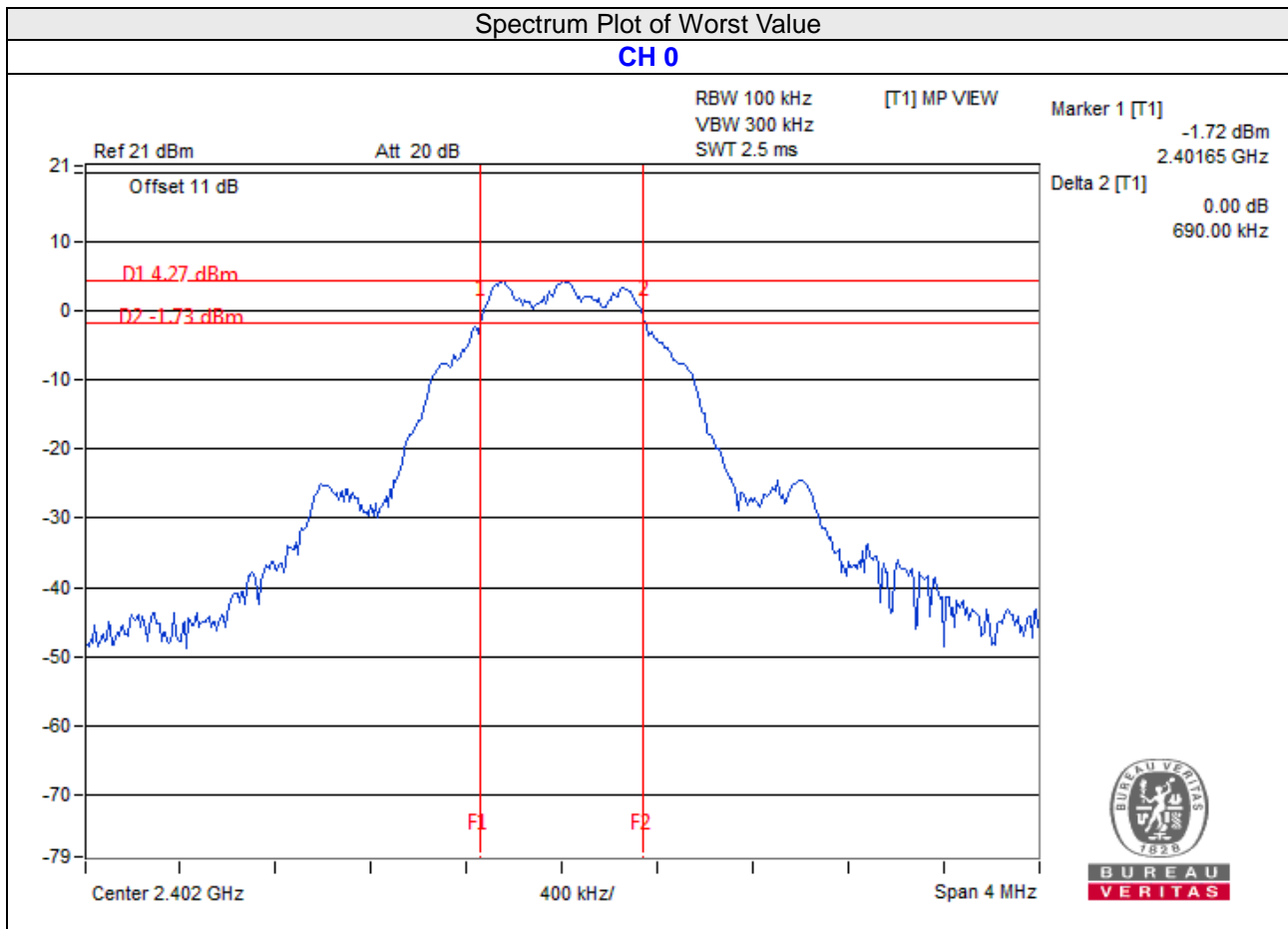

**Technology LE 2M (BT 5.0)**

Channel	Frequency (MHz)	6dB Bandwidth (MHz)	Minimum Limit (MHz)	Pass / Fail
1	2404	1.18	0.5	Pass
19	2440	1.15	0.5	Pass
38	2478	1.19	0.5	Pass

**Spectrum Plot of Worst Value**

**CH 19**

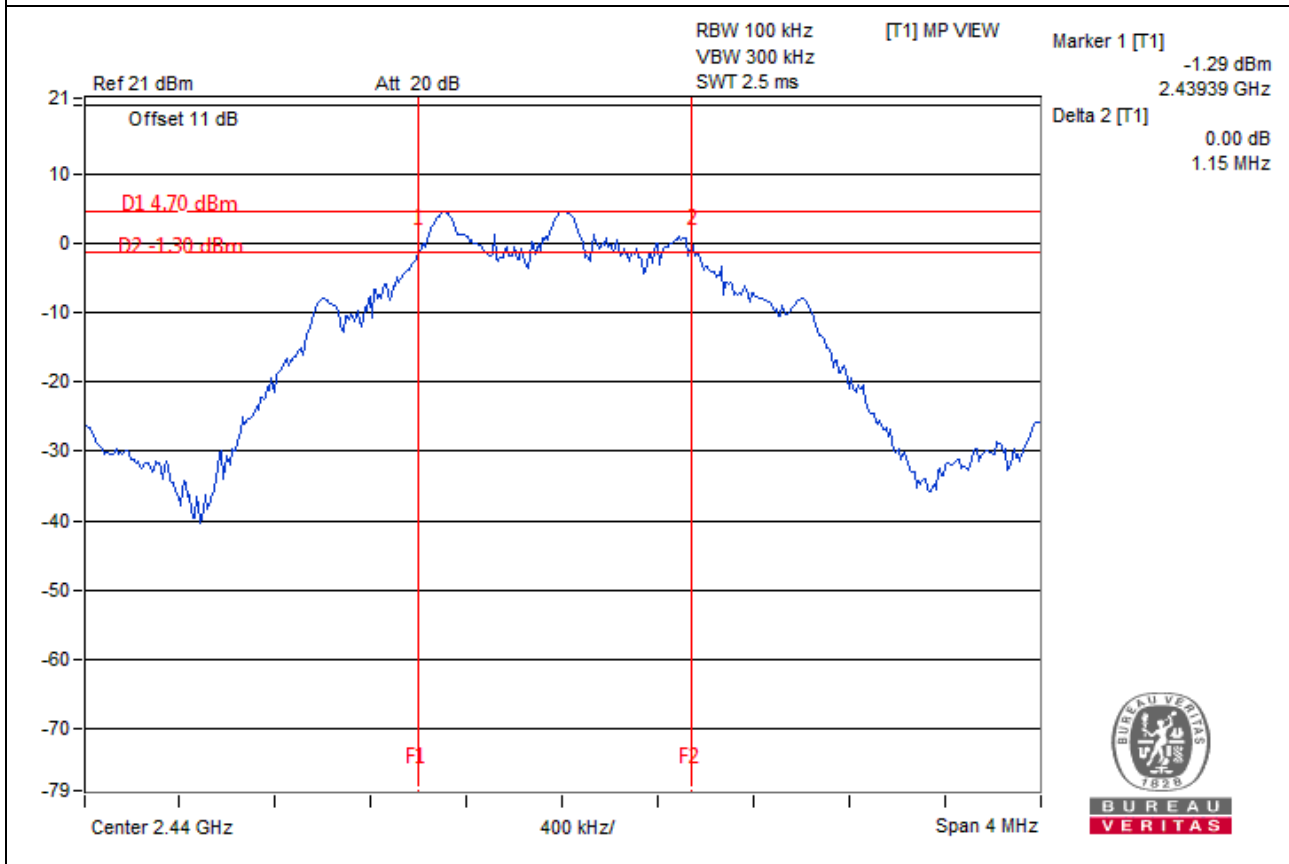



## 4.4 Conducted Output Power Measurement

### 4.4.1 Limits of Conducted Output Power Measurement

For systems using digital modulation in the 2400–2483.5 MHz bands: 1 Watt (30dBm)

### 4.4.2 Test Setup

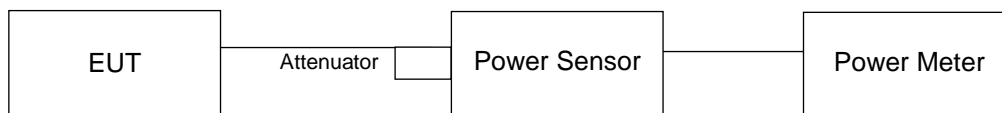

### 4.4.3 Test Instruments

Refer to section 4.1.2 to get information of above instrument.

### 4.4.4 Test Procedures

A peak power sensor was used on the output port of the EUT. A power meter was used to read the response of the peak power sensor. Record the power level.

Average power sensor was used to perform output power measurement, trigger and gating function of wide band power meter is enabled to measure max output power of TX on burst. Duty factor is not added to measured value.

### 4.4.5 Deviation from Test Standard

No deviation.

### 4.4.6 EUT Operating Conditions

Same as Item 4.3.6.

#### 4.4.7 Test Results (Mode 1)

##### Technology LE 1M (BT 4.0)

##### FOR PEAK POWER

Channel	Frequency (MHz)	Peak Power (mW)	Peak Power (dBm)	Limit (dBm)	Pass/Fail
0	2402	3.013	4.79	30	Pass
19	2440	3.373	5.28	30	Pass
39	2480	3.698	5.68	30	Pass

##### FOR AVERAGE POWER

Channel	Frequency (MHz)	Average Power (mW)	Average Power (dBm)
0	2402	2.924	4.66
19	2440	3.281	5.16
39	2480	3.606	5.57

**Technology LE 2M (BT 5.0)**
**FOR PEAK POWER**

Channel	Frequency (MHz)	Peak Power (mW)	Peak Power (dBm)	Limit (dBm)	Pass/Fail
1	2404	3.034	4.82	30	Pass
19	2440	3.35	5.25	30	Pass
38	2478	3.681	5.66	30	Pass

**FOR AVERAGE POWER**

Channel	Frequency (MHz)	Average Power (mW)	Average Power (dBm)
1	2404	2.951	4.70
19	2440	3.258	5.13
38	2478	3.597	5.56

## 4.5 Power Spectral Density Measurement

### 4.5.1 Limits of Power Spectral Density Measurement

The Maximum of Power Spectral Density Measurement is 8dBm in any 3kHz.

### 4.5.2 Test Setup

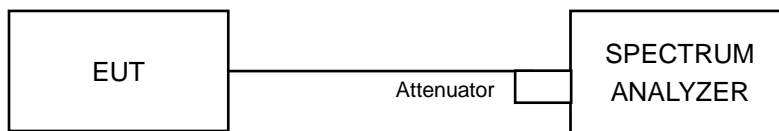

### 4.5.3 Test Instruments

Refer to section 4.1.2 to get information of above instrument.

### 4.5.4 Test Procedure

- a. Set analyzer center frequency to DTS channel center frequency.
- b. Set the span to 1.5 times the DTS bandwidth.
- c. Set the RBW to:  $3 \text{ kHz} \leq \text{RBW} \leq 100 \text{ kHz}$ .
- d. Set the VBW  $\geq 3 \times \text{RBW}$ .
- e. Detector = peak.
- f. Sweep time = auto couple.
- g. Trace mode = max hold.
- h. Allow trace to fully stabilize.
- i. Use the peak marker function to determine the maximum amplitude level within the RBW.

### 4.5.5 Deviation from Test Standard

No deviation.

### 4.5.6 EUT Operating Condition

Same as Item 4.3.6.

4.5.7 Test Results (Mode 1)

Technology LE 1M (BT 4.0)

Channel	Freq. (MHz)	PSD (dBm/3kHz)	Limit (dBm/3kHz)	Pass /Fail
0	2402	0.56	8	Pass
19	2440	1.04	8	Pass
39	2480	1.26	8	Pass

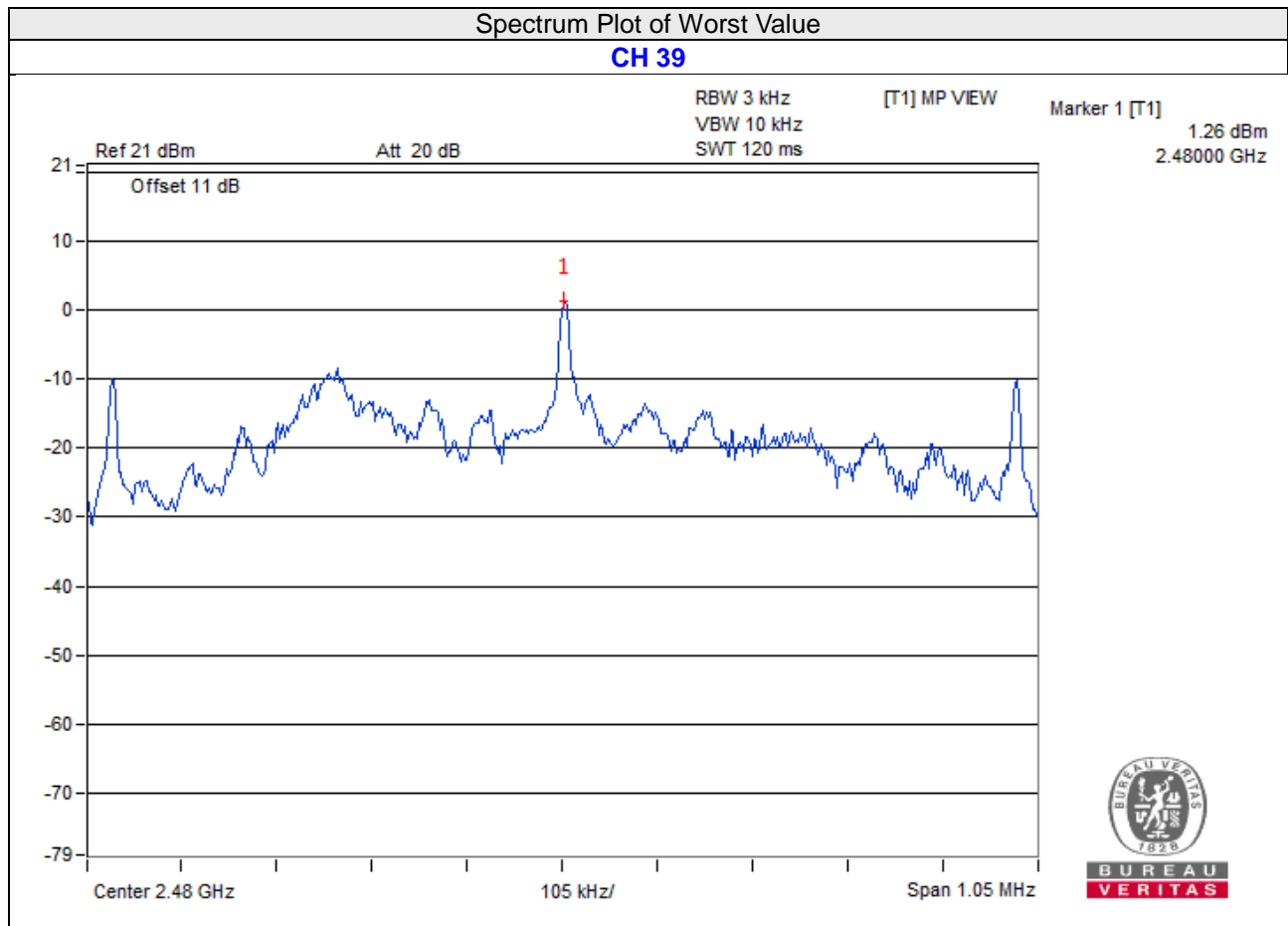

**Technology LE 2M (BT 5.0)**

Channel	Freq. (MHz)	PSD (dBm/3kHz)	Limit (dBm/3kHz)	Pass /Fail
1	2404	-3.76	8	Pass
19	2440	-3.27	8	Pass
38	2478	-2.71	8	Pass

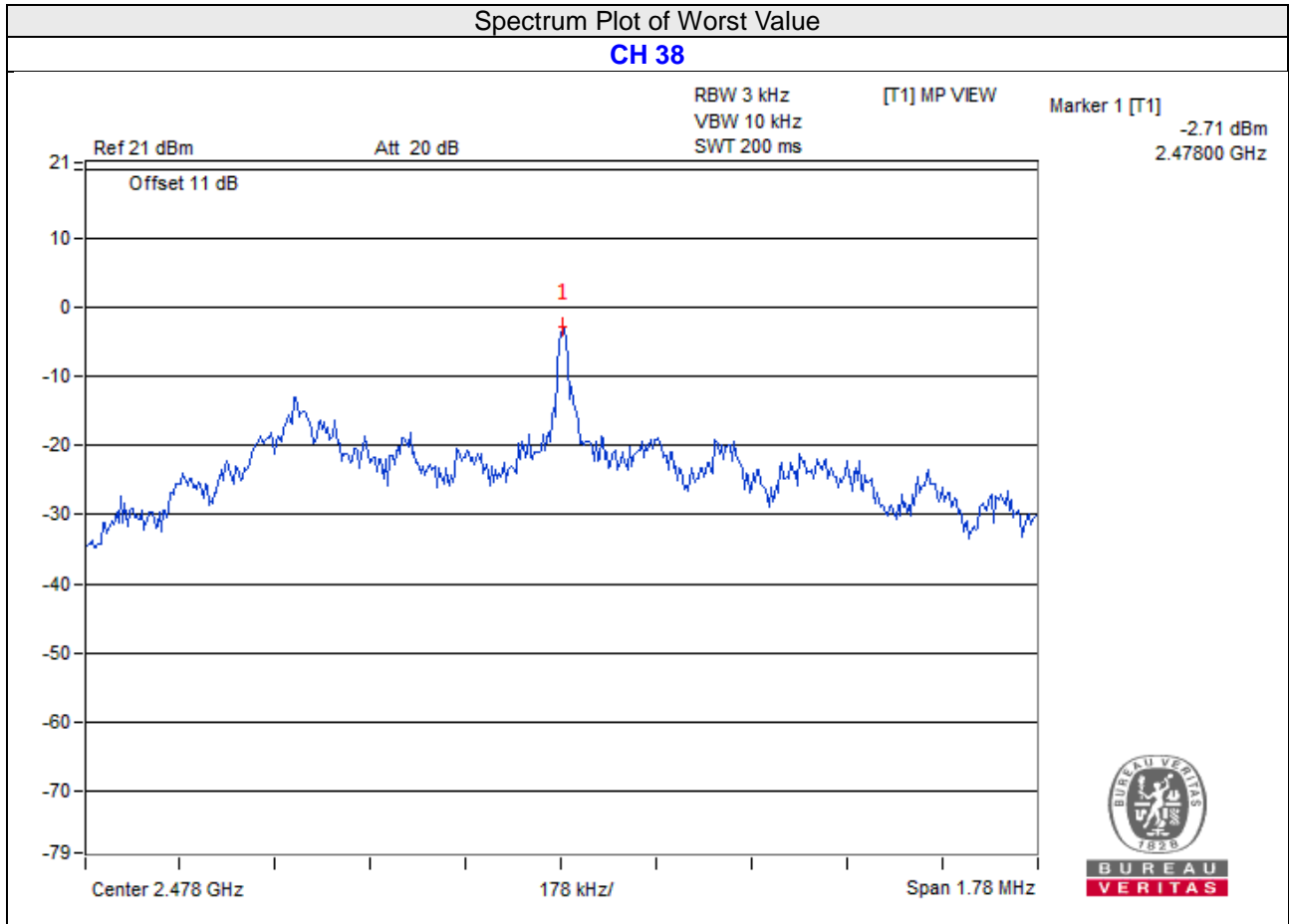

## 4.6 Conducted Out of Band Emission Measurement

### 4.6.1 Limits of Conducted Out of Band Emission Measurement

Below 20dB of the highest emission level of operating band (in 100kHz Resolution Bandwidth).

### 4.6.2 Test Setup

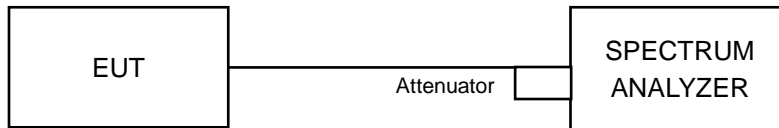

### 4.6.3 Test Instruments

Refer to section 4.1.2 to get information of above instrument.

### 4.6.4 Test Procedure

#### MEASUREMENT PROCEDURE REF

1. Set the RBW = 100 kHz.
2. Set the VBW  $\geq$  300 kHz.
3. Detector = peak.
4. Sweep time = auto couple.
5. Trace mode = max hold.
6. Allow trace to fully stabilize.
7. Use the peak marker function to determine the maximum power level in any 100 kHz band segment within the fundamental EBW.

#### MEASUREMENT PROCEDURE OOB

1. Set RBW = 100 kHz.
2. Set VBW  $\geq$  300 kHz.
3. Detector = peak.
4. Sweep = auto couple.
5. Trace Mode = max hold.
6. Allow trace to fully stabilize.
7. Use the peak marker function to determine the maximum amplitude level.

### 4.6.5 Deviation from Test Standard

No deviation.

### 4.6.6 EUT Operating Condition

Same as Item 4.3.6.

### 4.6.7 Test Results (Mode 1)

#### Technology LE 1M (BT 4.0)

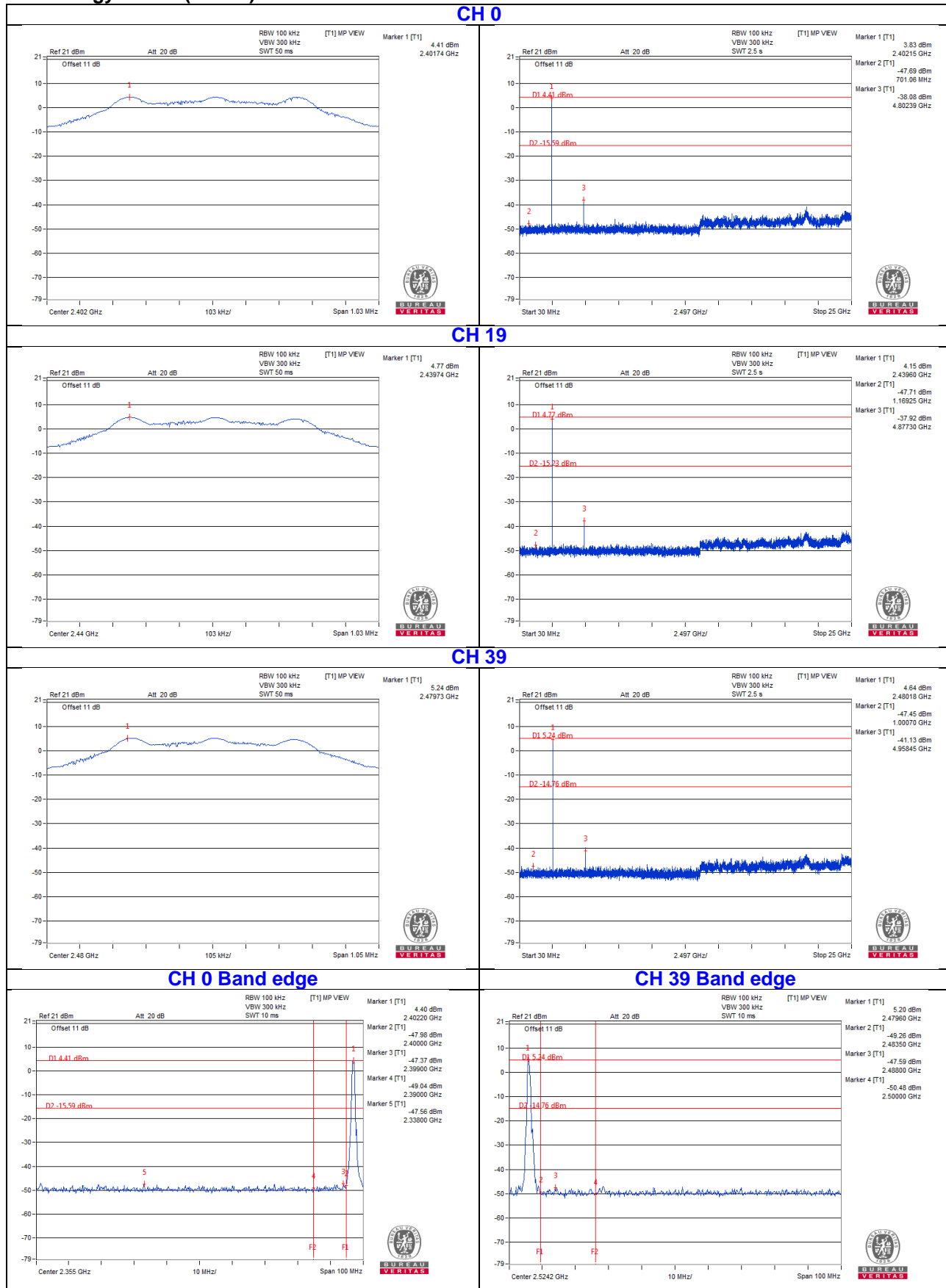



# Technology LE 2M (BT 5.0)

## CH 1

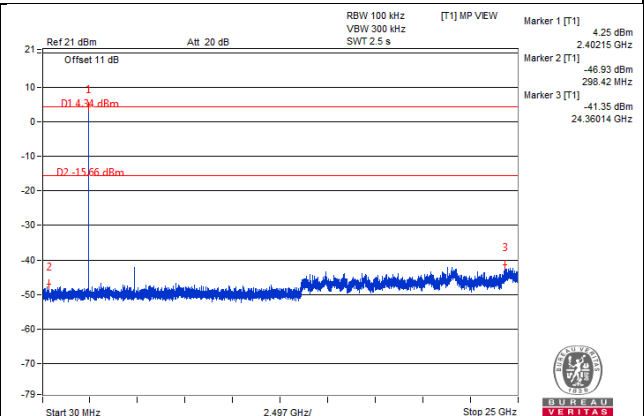
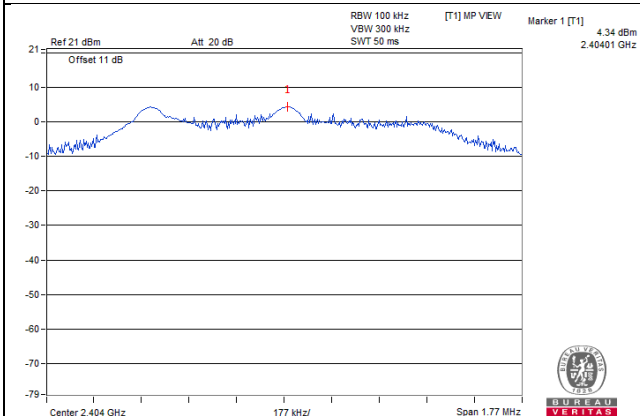

## CH 19

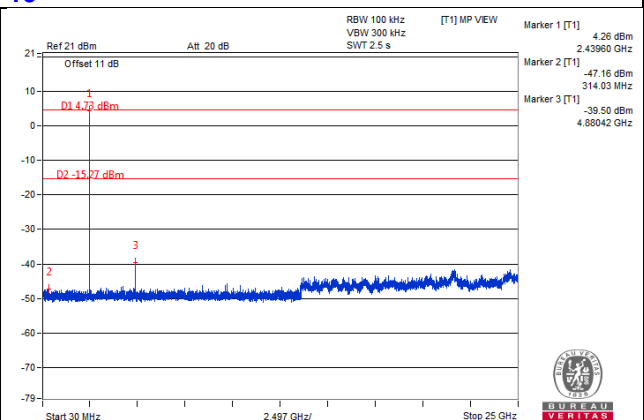
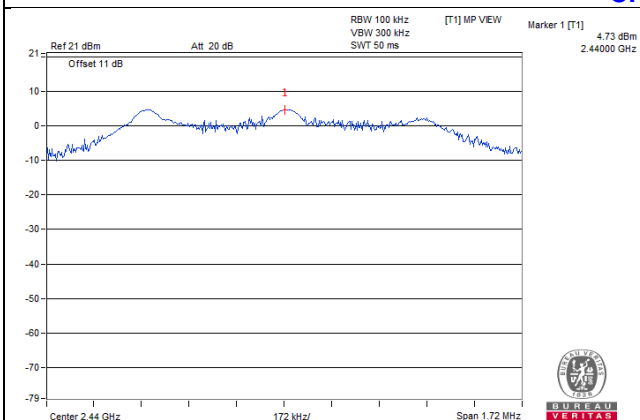

## CH 38

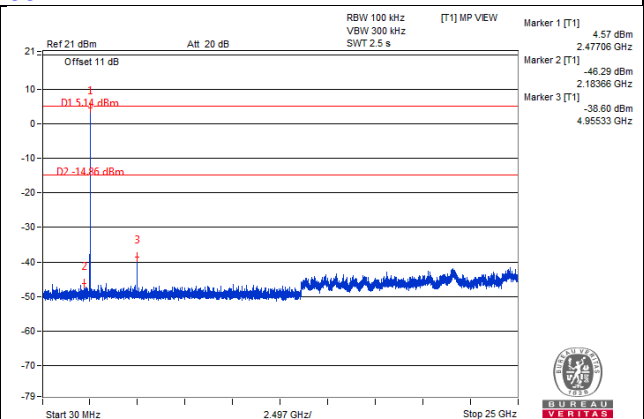
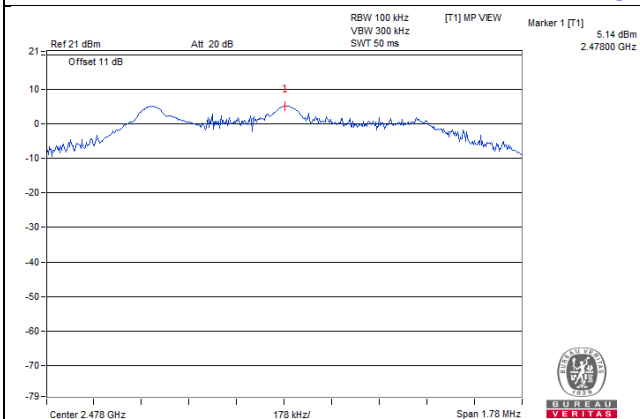

## CH 1 Band edge

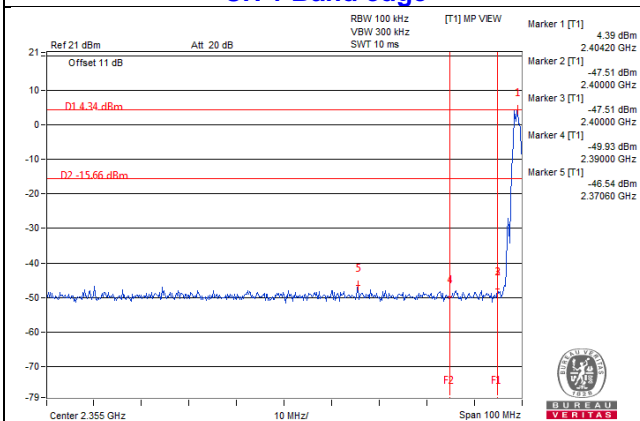

## CH 38 Band edge

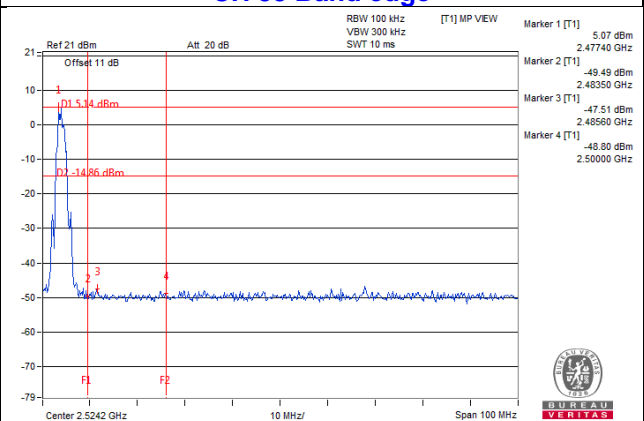

## 5 Pictures of Test Arrangements

Please refer to the attached file (Test Setup Photo).

## Appendix – Information on the Testing Laboratories

We, Bureau Veritas Consumer Products Services (H.K.) Ltd., Taoyuan Branch, were founded in 1988 to provide our best service in EMC, Radio, Telecom and Safety consultation. Our laboratories are FCC recognized accredited test firms and accredited according to ISO/IEC 17025.

If you have any comments, please feel free to contact us at the following:

**Linko EMC/RF Lab**

Tel: 886-2-26052180

Fax: 886-2-26051924

**Hsin Chu EMC/RF/Telecom Lab**

Tel: 886-3-6668565

Fax: 886-3-6668323

**Hwa Ya EMC/RF/Safety Lab**

Tel: 886-3-3183232

Fax: 886-3-3270892

**Email:** [service.adt@tw.bureauveritas.com](mailto:service.adt@tw.bureauveritas.com)

**Web Site:** [www.bureauveritas-adt.com](http://www.bureauveritas-adt.com)

The address and road map of all our labs can be found in our web site also.

--- END ---