

TEST REPORT

CERTIFICATE OF CONFORMITY

Standard: 47 CFR FCC Part 15, Subpart C (Section 15.247)

Report No.: RFBDKG-WTW-P22080047

FCC ID: JNZVR0034

Product: Camera and Speakerphone

Brand: Logitech

Model No.: VR0034

Received Date: 2022/8/2

Test Date: 2022/9/2 ~ 2023/3/30

Issued Date: 2023/4/21

Applicant: Logitech Far East Ltd

Address: 3930 North First Street, San Jose, California 95134

Issued By: Bureau Veritas Consumer Products Services (H.K.) Ltd., Taoyuan Branch
Hsin Chu Laboratory

Lab Address: E-2, No.1, Li Hsin 1st Road, Hsinchu Science Park, Hsinchu City 300, Taiwan

Test Location: E-2, No.1, Li Hsin 1st Road, Hsinchu Science Park, Hsinchu City 300, Taiwan

FCC Registration / 723255 / TW2022

Designation Number:

Approved by: _____, **Date:** 2023/4/21
May Chen / Manager

This test report consists of 74 pages in total. It may be duplicated completely for legal use with the approval of the applicant. It should not be reproduced except in full, without the written approval of our laboratory. The test results in the report only apply to the tested sample. The test results in this report are traceable to the national or international standards.

Prepared by : Luna Yu / Specialist



This report is governed by, and incorporates by reference, the Conditions of Testing as posted at the date of issuance of this report at <http://www.bureauveritas.com/home/about-us/our-business/cps/about-us/terms-conditions/> and is intended for your exclusive use. Any copying or replication of this report to or for any other person or entity, or use of our name or trademark, is permitted only with our prior written permission. This report sets forth our findings solely with respect to the test samples identified herein. The results set forth in this report are not indicative or representative of the quality or characteristics of the lot from which a test sample was taken or any similar or identical product unless specifically and expressly noted. Our report includes all of the tests requested by you and the results thereof based upon the information that you provided to us. Measurement uncertainty is only provided upon request for accredited tests. Statements of conformity are based on simple acceptance criteria without taking measurement uncertainty into account, unless otherwise requested in writing. You have 60 days from date of issuance of this report to notify us of any material error or omission caused by our negligence or if you require measurement uncertainty; provided, however, that such notice shall be in writing and shall specifically address the issue you wish to raise. A failure to raise such issue within the prescribed time shall constitute your unqualified acceptance of the completeness of this report, the tests conducted and the correctness of the report contents.

Table of Contents

Release Control Record	4
1 Certificate.....	5
2 Summary of Test Results	6
2.1 Measurement Uncertainty	6
2.2 Supplementary Information	6
3 General Information	7
3.1 General Description	7
3.2 Antenna Description of EUT	8
3.3 Channel List.....	9
3.4 Test Mode Applicability and Tested Channel Detail.....	10
3.5 Duty Cycle of Test Signal.....	11
3.6 Test Program Used and Operation Descriptions	13
3.7 Connection Diagram of EUT and Peripheral Devices	13
3.8 Configuration of Peripheral Devices and Cable Connections	14
4 Test Instruments	15
4.1 RF Output Power.....	15
4.2 Power Spectral Density	15
4.3 6 dB Bandwidth	15
4.4 Conducted Out of Band Emissions	15
4.5 AC Power Conducted Emissions	16
4.6 Unwanted Emissions below 1 GHz	16
4.7 Unwanted Emissions above 1 GHz.....	17
5 Limits of Test Items.....	18
5.1 RF Output Power.....	18
5.2 Power Spectral Density	18
5.3 6 dB Bandwidth	18
5.4 Conducted Out of Band Emissions	18
5.5 AC Power Conducted Emissions	18
5.6 Unwanted Emissions below 1 GHz	19
5.7 Unwanted Emissions above 1 GHz.....	19
6 Test Arrangements.....	20
6.1 RF Output Power.....	20
6.1.1 Test Setup	20
6.1.2 Test Procedure.....	20
6.2 Power Spectral Density	20
6.2.1 Test Setup	20
6.2.2 Test Procedure.....	20
6.3 6 dB Bandwidth	21
6.3.1 Test Setup	21
6.3.2 Test Procedure.....	21
6.4 Conducted Out of Band Emissions	21
6.4.1 Test Setup	21
6.4.2 Test Procedure.....	21
6.5 AC Power Conducted Emissions	22
6.5.1 Test Setup	22
6.5.2 Test Procedure.....	22
6.6 Unwanted Emissions below 1 GHz	23
6.6.1 Test Setup	23
6.6.2 Test Procedure.....	24
6.7 Unwanted Emissions above 1 GHz.....	25
6.7.1 Test Setup	25
6.7.2 Test Procedure.....	25
7 Test Results of Test Item	26



7.1	RF Output Power	26
7.2	Power Spectral Density	29
7.3	6 dB Bandwidth	31
7.4	Conducted Out of Band Emissions	33
7.5	AC Power Conducted Emissions	41
7.6	Unwanted Emissions below 1 GHz	43
7.7	Unwanted Emissions above 1 GHz	45
8	Pictures of Test Arrangements	73
9	Information of the Testing Laboratories	74



Release Control Record

Issue No.	Description	Date Issued
RFBDKG-WTW-P22080047	Original release.	2023/4/21

1 Certificate

Product: Camera and Speakerphone

Brand: Logitech

Test Model: VR0034

Sample Status: Engineering sample

Applicant: Logitech Far East Ltd

Test Date: 2022/9/2 ~ 2023/3/30

Standard: 47 CFR FCC Part 15, Subpart C (Section 15.247)

Measurement ANSI C63.10-2013

procedure: KDB 558074 D01 15.247 Meas Guidance v05r02

KDB 662911 D01 Multiple Transmitter Output v02r01

The above equipment has been tested by **Bureau Veritas Consumer Products Services (H.K.) Ltd., Taoyuan Branch**, and found compliance with the requirement of the above standards. The test record, data evaluation & Equipment Under Test (EUT) configurations represented herein are true and accurate accounts of the measurements of the sample's RF characteristics under the conditions specified in this report.

2 Summary of Test Results

47 CFR FCC Part 15, Subpart C (Section 15.247)			
Standard / Clause	Test Item	Result	Remark
15.247(b)	RF Output Power	Pass	Meet the requirement of limit.
15.247(e)	Power Spectral Density	Pass	Meet the requirement of limit.
15.247(a)(2)	6 dB Bandwidth	Pass	Meet the requirement of limit.
15.247(d)	Conducted Out of Band Emissions	Pass	Meet the requirement of limit.
15.207	AC Power Conducted Emissions	Pass	Minimum passing margin is -22.26 dB at 0.36484 MHz
15.205 / 15.209 / 15.247(d)	Unwanted Emissions below 1 GHz	Pass	Minimum passing margin is -5.0 dB at 33.45 MHz
15.205 / 15.209 / 15.247(d)	Unwanted Emissions above 1 GHz	Pass	Minimum passing margin is -4.2 dB at 4824.00 MHz
15.203	Antenna Requirement	Pass	Antenna connector is ipex(MHF) not a standard connector.

Note: Determining compliance based on the results of the compliance measurement, not taking into account measurement instrumentation uncertainty.

2.1 Measurement Uncertainty

Where relevant, the following measurement uncertainty levels have been estimated for tests performed on the EUT as specified in CISPR 16-4-2:

Measurement	Specification	Expanded Uncertainty (k=2) (±)
Conducted Out of Band Emissions	9 kHz ~ 40 GHz	2.5 dB
AC Power Conducted Emissions	150 kHz ~ 30 MHz	1.9 dB
Unwanted Emissions below 1 GHz	9 kHz ~ 30 MHz	3.1 dB
	30 MHz ~ 1 GHz	5.4 dB
Unwanted Emissions above 1 GHz	1 GHz ~ 18 GHz	5.0 dB
	18 GHz ~ 40 GHz	5.3 dB

The other instruments specified are routine verified to remain within the calibrated levels, no measurement uncertainty is required to be calculated.

2.2 Supplementary Information

There is not any deviation from the test standards for the test method, and no modifications required for compliance.

3 General Information

3.1 General Description

Product	Camera and Speakerphone
Brand	Logitech
Test Model	VR0034
Status of EUT	Engineering sample
Power Supply Rating	Refer to Note
Modulation Type	CCK, DQPSK, DBPSK for DSSS 64QAM, 16QAM, QPSK, BPSK for OFDM 256QAM for OFDM in VHT mode 1024QAM for OFDMA in 11ax mode
Modulation Technology	DSSS, OFDM, OFDMA
Transfer Rate	802.11b: Up to 11 Mbps 802.11g: Up to 54 Mbps 802.11n: Up to 300 Mbps VHT: Up to 400 Mbps 802.11ax: Up to 573.5 Mbps
Operating Frequency	2.412 GHz ~ 2.462 GHz
Number of Channel	802.11b, 802.11g, 802.11n (HT20), VHT20, 802.11ax (HE20): 11 802.11n (HT40), VHT40, 802.11ax (HE40): 7
Output Power	629.925 mW (27.99 dBm)

Note:

1. The EUT uses following accessories.

Adapter		
Brand	Model	Rating
Aohai	A931-190210W-M3	Input: 100-240V, 50/60Hz, 1.2A AC input cable: Unshielded, 1m Output: 19V, 2.1A, 39.9W DC output cable: Unshielded, 1.5m, one core
HDMI cable		
Brand	Model	signal line
ELKA	502-001199	2m, Shielded
USB Type-A to Type-C cable		
Brand	Model	signal line
JEM	502-000986	2.2m, Shielded

2. There are Bluetooth and WLAN (2.4 GHz & 5 GHz) technology used for the EUT.

3. Simultaneously transmission condition.

Condition	Technology	
1	WLAN (2.4 GHz)	WLAN (5 GHz)
2	WLAN (2.4 GHz)	Bluetooth
3	WLAN (5 GHz)	Bluetooth

Note: The emission of the simultaneous operation has been evaluated and no non-compliance was found.

4. The above EUT information is declared by manufacturer and for more detailed features description, please refer to the manufacturer's specifications or user's manual.

3.2 Antenna Description of EUT

1. The antenna information is listed as below.

Antenna NO.	RF Chain NO.	Antenna Net Gain (dBi)	Frequency range (GHz)	Antenna Type	Connector Type	Cable Length (mm)
WIFI 0	WF0	5.5	2.4~2.4835	Dipole	ipex(MHF)	122
		4.98	5.18~5.24			
		4.94	5.26~5.32			
		5.89	5.5~5.720			
		5.85	5.745~5.825			
WIFI 1	WF1	5.76	2.4~2.4835	Dipole	ipex(MHF)	77
		5.77	5.18~5.24			
		5.19	5.26~5.32			
		5.58	5.5~5.720			
		5.66	5.745~5.825			
Bluetooth	-	3.48	2.4~2.4835	Dipole	ipex(MHF)	87

* Detail antenna specification please refer to antenna datasheet and/or antenna measurement report.

2. The EUT incorporates a MIMO function:

2.4 GHz Band		
Modulation Mode	TX & RX Configuration	
802.11b	2TX	2RX
802.11g	2TX	2RX
802.11n (HT20)	2TX	2RX
802.11n (HT40)	2TX	2RX
VHT20	2TX	2RX
VHT40	2TX	2RX
802.11ax (HE20)	2TX	2RX
802.11ax (HE40)	2TX	2RX

Note:

- The modulation and bandwidth are similar for 802.11n mode for 20 MHz (40 MHz), VHT mode for 20 MHz (40 MHz), and 802.11ax mode for 20 MHz (40 MHz), therefore the manufacturer will control the power for 802.11n/VHT mode is the same as the 802.11ax or more lower than it and investigated worst case to representative mode in test report.

3.3 Channel List

11 channels are provided for 802.11b, 802.11g, 802.11n (HT20), VHT20, 802.11ax (HE20):

Channel	Frequency	Channel	Frequency
1	2412 MHz	7	2442 MHz
2	2417 MHz	8	2447 MHz
3	2422 MHz	9	2452 MHz
4	2427 MHz	10	2457 MHz
5	2432 MHz	11	2462 MHz
6	2437 MHz		

7 channels are provided for 802.11n (HT40), VHT40, 802.11ax (HE40):

Channel	Frequency	Channel	Frequency
3	2422 MHz	7	2442 MHz
4	2427 MHz	8	2447 MHz
5	2432 MHz	9	2452 MHz
6	2437 MHz		

3.4 Test Mode Applicability and Tested Channel Detail

Pre-Scan:	1. Pre-Scan has been conducted to determine the worst-case mode from all possible combinations between available modulations, data rates and antenna ports (if EUT with antenna diversity architecture).
-----------	--

Following channel(s) was (were) selected for the final test as listed below:

Test Item	Mode	Tested Channel	Modulation	Data Rate Parameter
RF Output Power	802.11b	1, 6, 11	DBPSK	1Mb/s
	802.11g	1, 6, 11	BPSK	6Mb/s
	VHT20	1, 6, 11	BPSK	MCS0
	VHT40	3, 6, 9	BPSK	MCS0
	802.11ax (HE20)	1, 6, 11	BPSK	MCS0
	802.11ax (HE40)	3, 6, 9	BPSK	MCS0
Power Spectral Density / 6 dB Bandwidth / Conducted Out of Band Emissions	802.11b	1, 6, 11	DBPSK	1Mb/s
	802.11g	1, 6, 11	BPSK	6Mb/s
	802.11ax (HE20)	1, 6, 11	BPSK	MCS0
	802.11ax (HE40)	3, 6, 9	BPSK	MCS0
AC Power Conducted Emissions	802.11b	6	DBPSK	1Mb/s
Unwanted Emissions below 1 GHz	802.11b	6	DBPSK	1Mb/s
Unwanted Emissions above 1 GHz	802.11b	1, 6, 11	DBPSK	1Mb/s
	802.11g	1, 6, 11	BPSK	6Mb/s
	802.11ax (HE20)	1, 6, 11	BPSK	MCS0
	802.11ax (HE40)	3, 6, 9	BPSK	MCS0

Note:
 Partial RU (resource unit) mechanism is not supported.

3.5 Duty Cycle of Test Signal

802.11b: Duty cycle = 8.386 ms / 8.762 ms x 100% = 95.7%, duty factor = 10 * log (1/Duty cycle) = 0.19 dB

802.11g: Duty cycle = 1.392 ms / 1.768 ms x 100% = 78.7%, duty factor = 10 * log (1/Duty cycle) = 1.04 dB

802.11ax (HE20): Duty cycle = 1.014 ms / 1.409 ms x 100% = 72.0%, duty factor = 10 * log (1/Duty cycle) = 1.43 dB

802.11ax (HE40): Duty cycle = 0.54 ms / 0.91 ms x 100% = 59.3%, duty factor = 10 * log (1/Duty cycle) = 2.27 dB

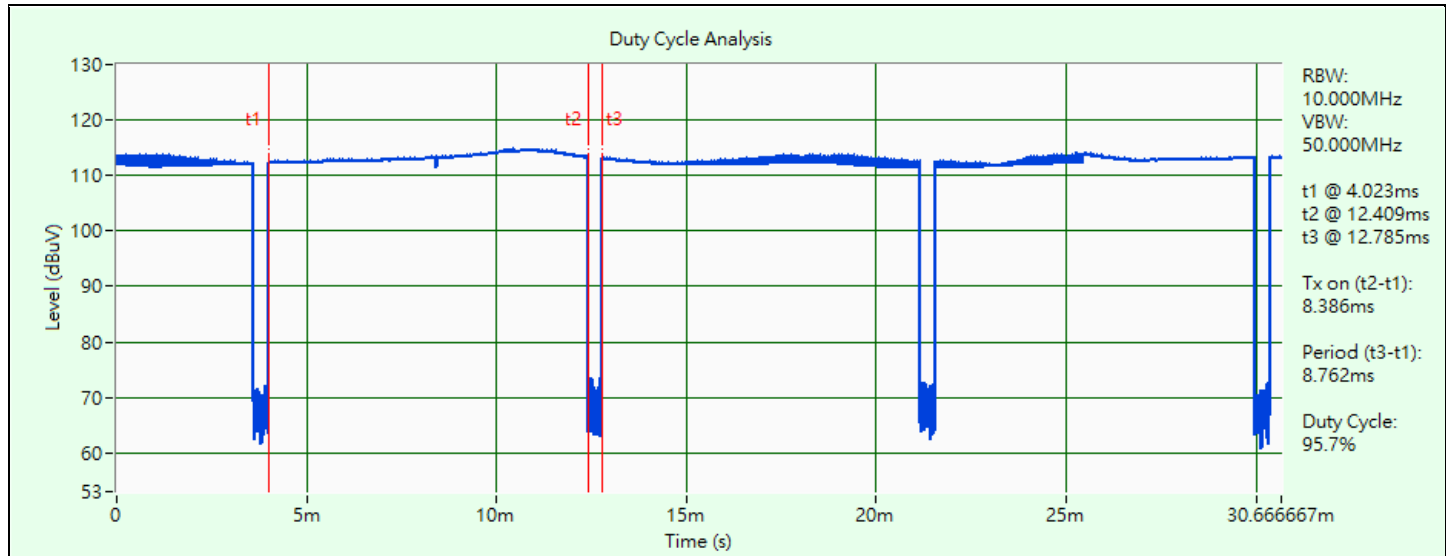

802.11b

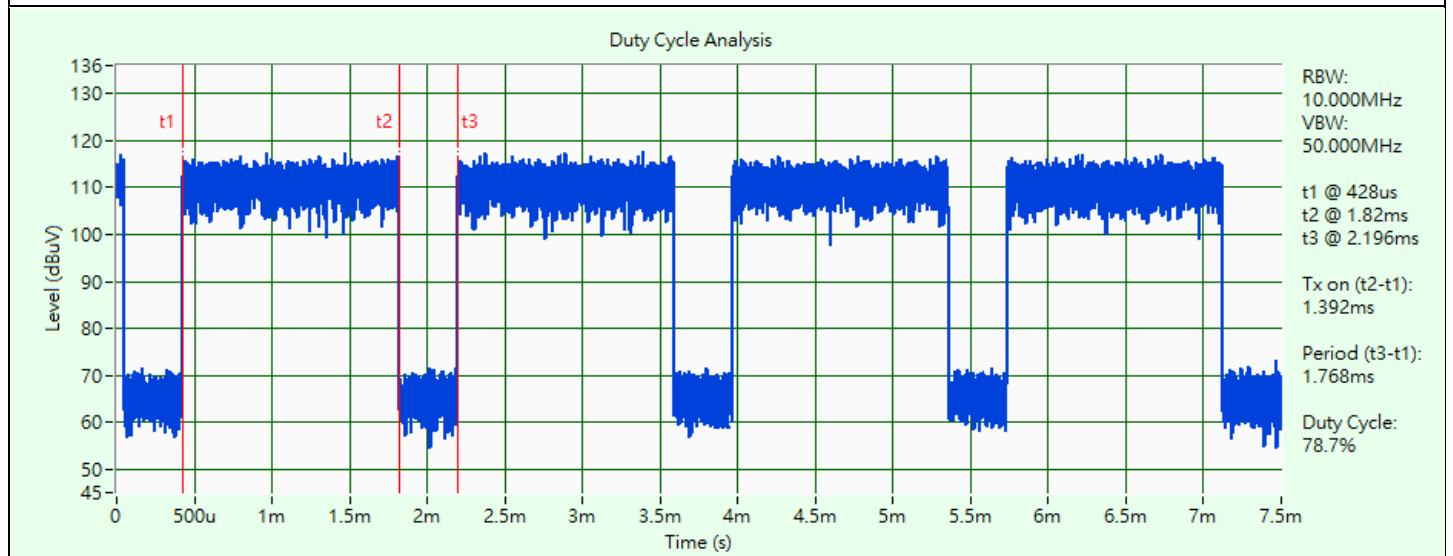

802.11g

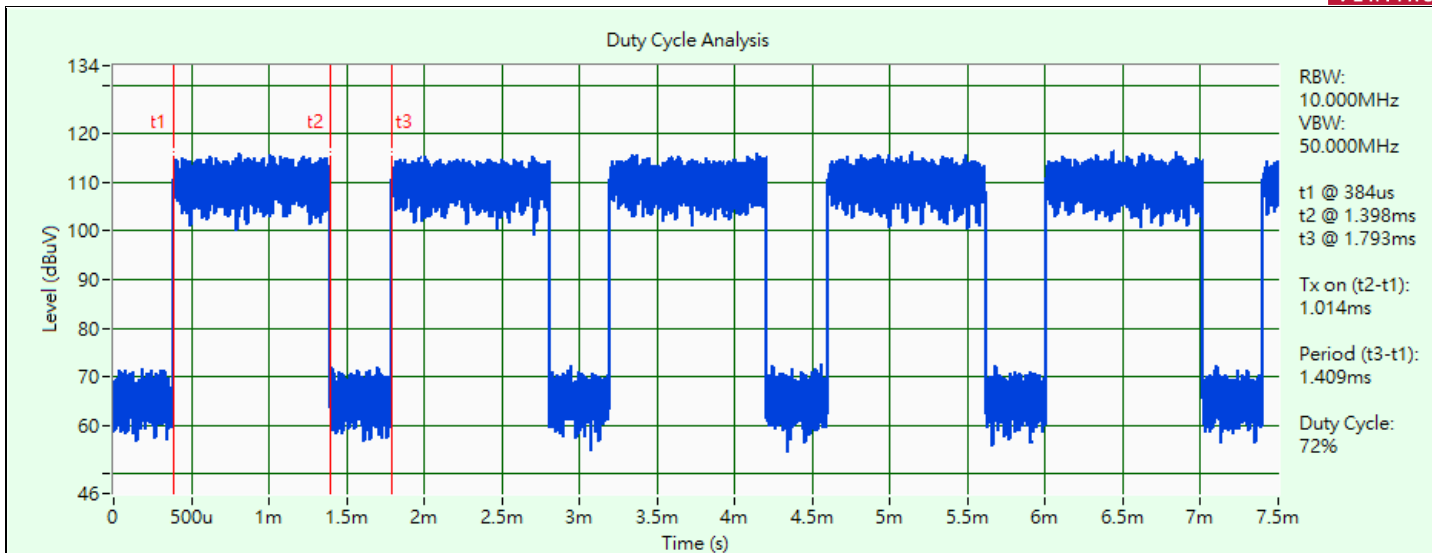

802.11ax (HE20)

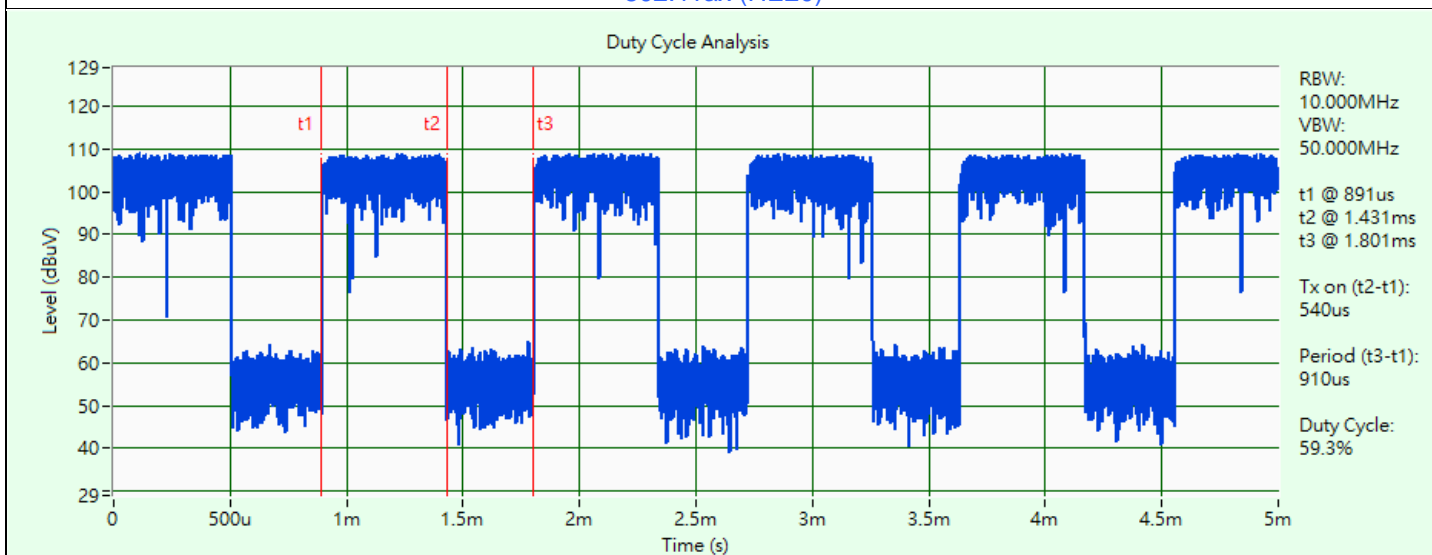

802.11ax (HE40)

3.6 Test Program Used and Operation Descriptions

Controlling software (adb paste WIFI Command) has been activated to set the EUT under transmission condition continuously at specific channel frequency.

3.7 Connection Diagram of EUT and Peripheral Devices

For AC Power Conducted Emission test

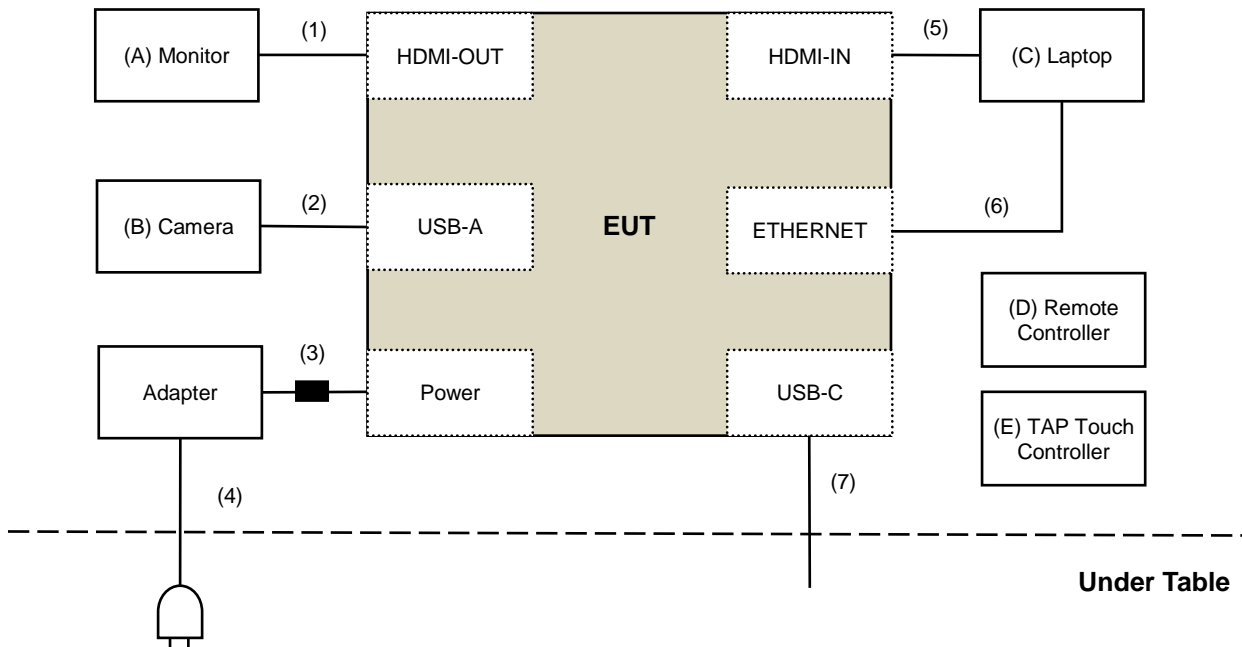

For Unwanted Emission test

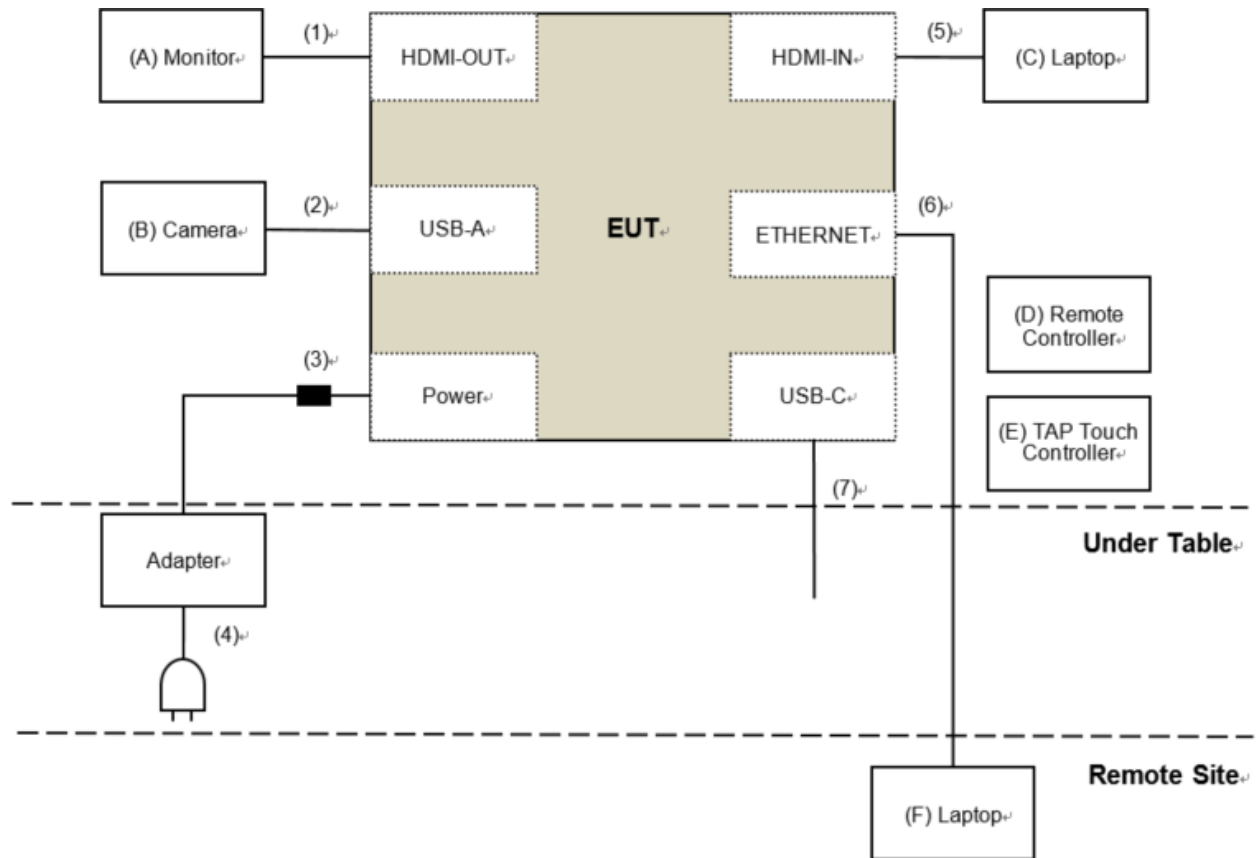

3.8 Configuration of Peripheral Devices and Cable Connections

ID	Product	Brand	Model No.	Serial No.	FCC ID	Remarks
A	Monitor	DELL	P2415Q	CN-0J1P7F-QDC00-85L-13GB-A09	DoC	Provided by Lab
B	Camera	Logitech	N/A	N/A	N/A	Supplied by applicant
C	Laptop	Lenovo	20U5S01X00 L14	PF-1ANPYA	N/A	Provided by Lab
D	Remote controller	Logitech	N/A	N/A	N/A	Supplied by applicant
E	TAP Touch Controller	Logitech	VU0053	N/A	N/A	Supplied by applicant
F	Laptop	Lenovo	20U5S01X00 L14	PF-28LKK7	N/A	Provided by Lab

ID	Cable Descriptions	Qty.	Length (m)	Shielding (Yes/No)	Cores (Qty.)	Remarks
1	HDMI cable	1	2	Yes	0	Supplied by applicant
2	USB Type-A to Type-C cable	1	2.2	Yes	0	Supplied by applicant
3	DC Cable	1	1.5	No	1	Supplied by applicant
4	AC Cable	1	1	No	0	Supplied by applicant
5	HDMI cable	3	1.8	Yes	0	Provided by Lab
6	RJ45	1	10	No	0	Provided by Lab
7	USB Type A to USB Type C Cable	1	2	Yes	0	Provided by Lab

4 Test Instruments

The calibration interval of the all test instruments are 12 months and the calibrations are traceable to NML/ROC and NIST/USA.

4.1 RF Output Power

Description Manufacturer	Model No.	Serial No.	Calibrated Date	Calibrated Until
Power Meter Anritsu	ML2495A	1529002	2022/6/22	2023/6/21
Pulse Power Sensor Anritsu	MA2411B	1726434	2022/6/22	2023/6/21

Notes:

1. The test was performed in Oven room 2.
2. Tested Date: 2023/3/29

4.2 Power Spectral Density

Description Manufacturer	Model No.	Serial No.	Calibrated Date	Calibrated Until
Attenuator WOKEN	MDCS18N-10	MDCS18N-10-01	2022/4/5	2023/4/4
Software	ADT_RF Test Software V6.6.5.4	N/A	N/A	N/A
Spectrum Analyzer Keysight	N9020B	MY60112409	2023/2/18	2024/2/17

Notes:

1. The test was performed in Oven room 2.
2. Tested Date: 2023/3/29

4.3 6 dB Bandwidth

Refer to section 4.2 to get information of the instruments.

4.4 Conducted Out of Band Emissions

Refer to section 4.2 to get information of the instruments.

4.5 AC Power Conducted Emissions

Description Manufacturer	Model No.	Serial No.	Calibrated Date	Calibrated Until
50 ohm terminal resistance	N/A	EMC-01	2022/9/27	2023/9/26
Fixed attenuator STI	STI02-2200-10	005	2022/8/24	2023/8/23
LISN R&S	ESH3-Z5	848773/004	2022/10/18	2023/10/17
RF Coaxial Cable JYEBO	5D-FB	COCCAB-001	2022/8/24	2023/8/23
Software BVADT	BVADT_Cond_V7.3.7.4	N/A	N/A	N/A
TEST RECEIVER R&S	ESCS 30	847124/029	2022/10/14	2023/10/13

Notes:

1. The test was performed in Conduction 1
2. Tested Date: 2023/3/22

4.6 Unwanted Emissions below 1 GHz

Description Manufacturer	Model No.	Serial No.	Calibrated Date	Calibrated Until
Antenna Tower & Turn Table Max-Full	MF-7802	MF780208406	N/A	N/A
Fix tool for Boresight antenna tower BV	FBA-01	FBA_SIP01	N/A	N/A
Fixed attenuator Mini-Circuits	UNAT-5+	PAD-3m-3-01	2022/9/14	2023/9/13
LOOP ANTENNA Electro-Metrics	EM-6879	264	2023/2/21	2024/2/20
Pre_Amplifier Agilent	8447D	2944A10636	2023/3/12	2024/3/11
Pre_Amplifier Mini-Circuits	ZFL-1000VH2	QA0838008	2022/10/4	2023/10/3
RF Coaxial Cable COMMATE/PEWC	8D	966-3-2	2023/2/17	2024/2/16
		966-4-1	2023/2/18	2024/2/17
		966-3-3	2023/2/17	2024/2/16
RF Coaxial Cable JYEBO	5D-FB	LOOPCAB-001	2022/12/19	2023/12/18
		LOOPCAB-002	2022/12/19	2023/12/18
Software	ADT_Radiated_V8.7.08	N/A	N/A	N/A
Spectrum Analyzer KEYSIGHT	N9030B	MY57142938	2022/4/26	2023/4/25
Test Receiver KEYSIGHT	N9038A	MY59050100	2022/6/20	2023/6/19
Trilog Broadband Antenna Schwarzbeck	VULB 9168	9168-361	2022/10/21	2023/10/20

Notes:

1. The test was performed in 966 Chamber No. 3.
2. Tested Date: 2023/3/30

4.7 Unwanted Emissions above 1 GHz

Description Manufacturer	Model No.	Serial No.	Calibrated Date	Calibrated Until
Antenna Tower & Turn Table Max-Full	MF-7802	MF780208406	N/A	N/A
Fix tool for Boresight antenna tower BV	FBA-01	FBA_SIP01	N/A	N/A
Horn Antenna Schwarzbeck	BBHA 9170	9170-739	2021/11/14 2022/11/13	2022/11/13 2023/11/12
	BBHA9120-D	9120D-406	2021/11/14 2022/11/13	2022/11/13 2023/11/12
Pre_Amplifier EMCI	EMC12630SE	980384	2022/1/10 2022/12/28	2023/1/9 2023/12/27
	EMC184045SE	980387	2022/1/10 2022/12/28	2023/1/9 2023/12/27
RF Cable EMCI	EMC104-SM-SM-6000	210201	2022/5/10	2023/5/9
RF Cable-Frequency range: 1- 40GHz EMCI	EMC102-KM-KM-1200	160924	2022/1/10 2022/12/28	2023/1/9 2023/12/27
RF Coaxial Cable EMCI	EMC-KM-KM-4000	200214	2022/3/8 2023/2/20	2023/3/7 2024/2/19
	EMC104-SM-SM-1500	180504	2022/4/25	2023/4/24
	EMC104-SM-SM-2000	180601	2022/6/6	2023/6/5
Software	ADT_Radiated_V8.7.08	N/A	N/A	N/A
Spectrum Analyzer KEYSIGHT	N9030B	MY57142938	2022/4/26	2023/4/25
Test Receiver KEYSIGHT	N9038A	MY59050100	2022/6/20	2023/6/19

Notes:

1. The test was performed in 966 Chamber No. 3.
2. Tested Date: 2022/9/2 ~ 2023/3/10

5 Limits of Test Items

5.1 RF Output Power

For systems using digital modulation in the 2400–2483.5 MHz bands: 1 Watt (30 dBm)

Per KDB 662911 D01 Multiple Transmitter Output Method of conducted output power measurement on IEEE 802.11 devices,

Array Gain = 0 dB (i.e., no array gain) for $N_{ANT} \leq 4$;

Array Gain = 0 dB (i.e., no array gain) for channel widths ≥ 40 MHz for any N_{ANT} ;

Array Gain = $5 \log(N_{ANT}/N_{SS})$ dB or 3 dB, whichever is less, for 20-MHz channel widths with $N_{ANT} \geq 5$.

For power measurements on all other devices: Array Gain = $10 \log(N_{ANT}/N_{SS})$ dB.

5.2 Power Spectral Density

The Maximum of Power Spectral Density Measurement is 8 dBm in any 3 kHz.

5.3 6 dB Bandwidth

The minimum of 6 dB Bandwidth Measurement is 0.5 MHz.

5.4 Conducted Out of Band Emissions

Below 20 dB of the highest emission level of operating band (in 100 kHz Resolution Bandwidth).

5.5 AC Power Conducted Emissions

Frequency (MHz)	Conducted Limit (dBuV)	
	Quasi-peak	Average
0.15 - 0.5	66 - 56	56 - 46
0.50 - 5.0	56	46
5.0 - 30.0	60	50

Notes:

1. The lower limit shall apply at the transition frequencies.
2. The limit decreases in line with the logarithm of the frequency in the range of 0.15 to 0.50 MHz.

5.6 Unwanted Emissions below 1 GHz

Radiated emissions up to 1 GHz which fall in the restricted bands must comply with the radiated emission limits specified as below table. Other emissions shall be at least 20 dB below the highest level of the desired power:

Frequencies (MHz)	Field Strength (microvolts/meter)	Measurement Distance (meters)
0.009 ~ 0.490	2400/F(kHz)	300
0.490 ~ 1.705	24000/F(kHz)	30
1.705 ~ 30.0	30	30
30 ~ 88	100	3
88 ~ 216	150	3
216 ~ 960	200	3
Above 960	500	3

Notes:

1. The lower limit shall apply at the transition frequencies.
2. Emission level (dBuV/m) = 20 log Emission level (uV/m).

5.7 Unwanted Emissions above 1 GHz

Radiated emissions above 1 GHz which fall in the restricted bands must comply with the radiated emission limits specified as below table. Other emissions shall be at least 20 dB below the highest level of the desired power:

Frequencies (MHz)	Field Strength (microvolts/meter)	Measurement Distance (meters)
Above 960	500	3

Notes:

1. The lower limit shall apply at the transition frequencies.
2. Emission level (dBuV/m) = 20 log Emission level (uV/m).
3. For frequencies above 1000 MHz, the field strength limits are based on average detector, however, the peak field strength of any emission shall not exceed the maximum permitted average limits, specified above by more than 20 dB under any condition of modulation.

6 Test Arrangements

6.1 RF Output Power

6.1.1 Test Setup

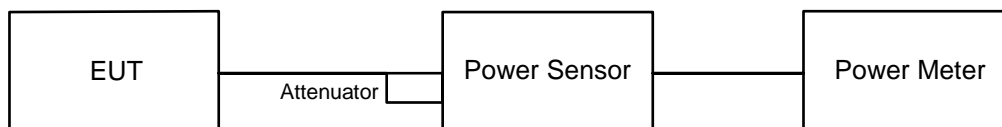

6.1.2 Test Procedure

Peak Power:

A peak power sensor was used on the output port of the EUT. A power meter was used to read the response of the peak power sensor. Record the power level.

Average Power:

Average power sensor was used to perform output power measurement, trigger and gating function of wide band power meter is enabled to measure max output power of TX on burst. Duty factor is not added to measured value.

6.2 Power Spectral Density

6.2.1 Test Setup

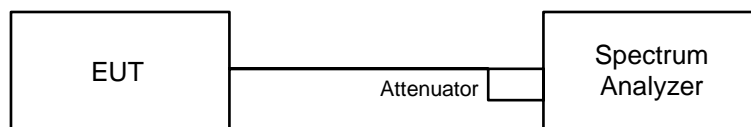

6.2.2 Test Procedure

- a. Set analyzer center frequency to DTS channel center frequency.
- b. Set the span to 1.5 times the DTS bandwidth.
- c. Set the RBW to: 3 kHz.
- d. Set the VBW $\geq 3 \times$ RBW.
- e. Detector = peak.
- f. Sweep time = auto couple.
- g. Trace mode = max hold.
- h. Allow trace to fully stabilize.
- i. Use the peak marker function to determine the maximum amplitude level within the RBW.

6.3 6 dB Bandwidth

6.3.1 Test Setup

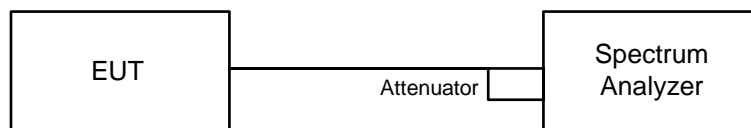

6.3.2 Test Procedure

- a. Set resolution bandwidth (RBW) = 100 kHz.
- b. Set the video bandwidth (VBW) $\geq 3 \times$ RBW, Detector = Peak.
- c. Trace mode = max hold.
- d. Sweep = auto couple.
- e. Measure the maximum width of the emission that is constrained by the frequencies associated with the two amplitude points (upper and lower) that are attenuated by 6 dB relative to the maximum level measured in the fundamental emission.

6.4 Conducted Out of Band Emissions

6.4.1 Test Setup

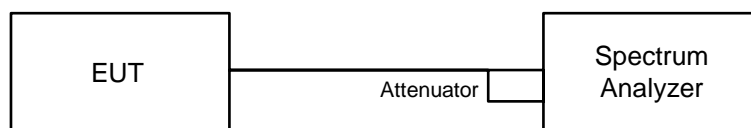

6.4.2 Test Procedure

MEASUREMENT PROCEDURE REF

- a. Set the RBW = 100 kHz.
- b. Set the VBW ≥ 300 kHz.
- c. Detector = peak.
- d. Sweep time = auto couple.
- e. Trace mode = max hold.
- f. Allow trace to fully stabilize.
- g. Use the peak marker function to determine the maximum power level in any 100 kHz band segment within the fundamental EBW.

MEASUREMENT PROCEDURE OOB

- a. Set RBW = 100 kHz.
- b. Set VBW ≥ 300 kHz.
- c. Detector = peak.
- d. Sweep = auto couple.
- e. Trace Mode = max hold.
- f. Allow trace to fully stabilize.
- g. Use the peak marker function to determine the maximum amplitude level.

6.5 AC Power Conducted Emissions

6.5.1 Test Setup

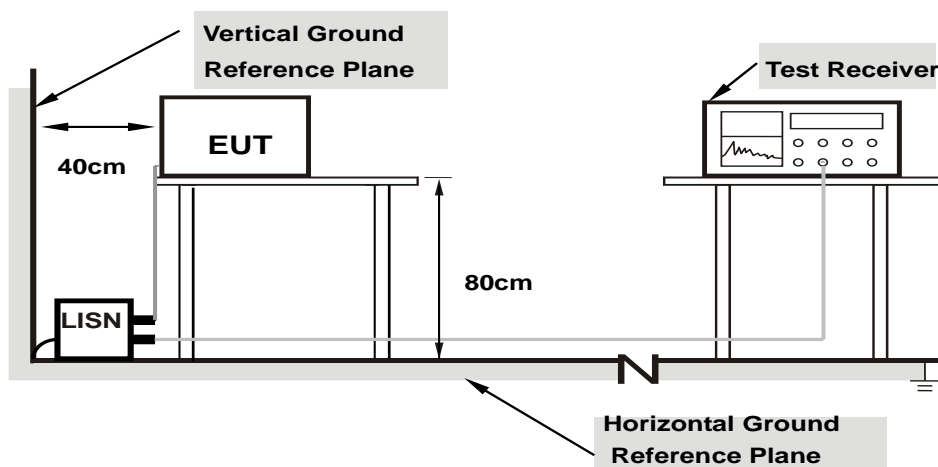

Note: 1.Support units were connected to second LISN.

For the actual test configuration, please refer to the attached file (Test Setup Photo).

6.5.2 Test Procedure

- The EUT was placed on a 0.8 meter to the top of table and placed 0.4 meters from the conducting wall of the shielded room with EUT being connected to the power mains through a line impedance stabilization network (LISN). Other support units were connected to the power mains through another LISN. The two LISNs provide 50 ohm/ 50 uH of coupling impedance for the measuring instrument.
- Both lines of the power mains connected to the EUT were checked for maximum conducted interference.
- The frequency range from 150 kHz to 30 MHz was searched. Emission levels under (Limit – 20 dB) was not recorded.

Note: The resolution bandwidth and video bandwidth of test receiver is 9 kHz for quasi-peak detection (QP) and average detection (AV) at frequency 0.15 MHz-30 MHz.

6.6 Unwanted Emissions below 1 GHz

6.6.1 Test Setup

For Radiated emission below 30 MHz

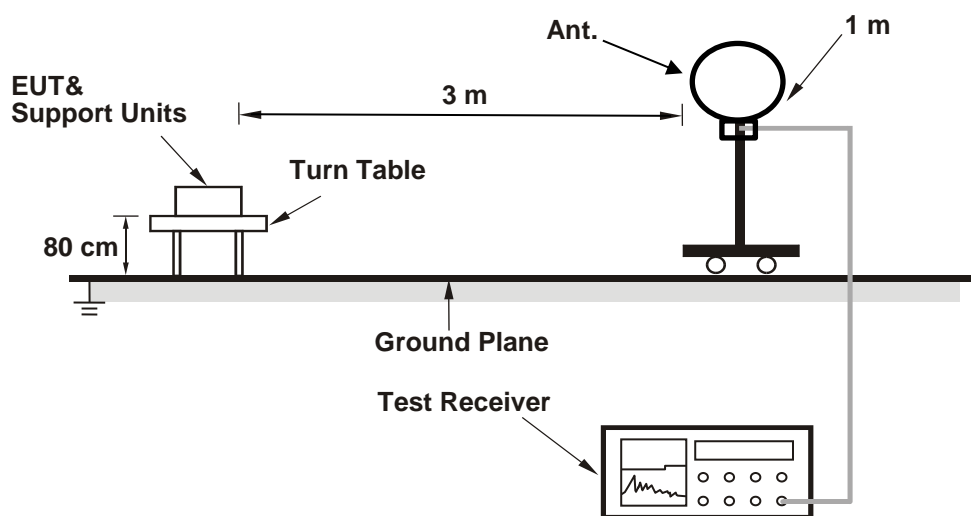

For Radiated emission above 30 MHz

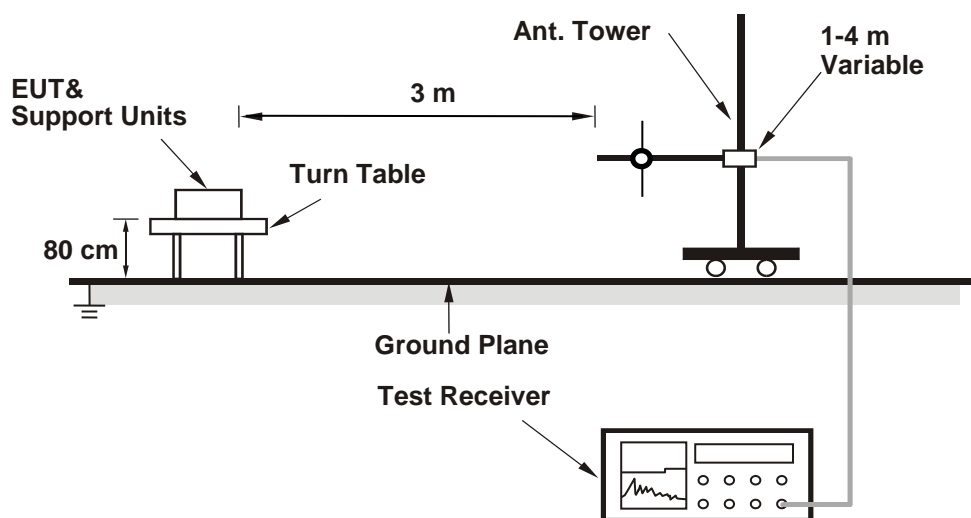

For the actual test configuration, please refer to the attached file (Test Setup Photo).

6.6.2 Test Procedure

For Radiated emission below 30 MHz

- a. The EUT was placed on the top of a rotating table 0.8 meters above the ground at 3 meter chamber room for test. The table was rotated 360 degrees to determine the position of the highest radiation.
- b. The EUT was set 3 meters away from the interference-receiving antenna, which was mounted on the top of a variable-height antenna tower.
- c. Parallel, perpendicular, and ground-parallel orientations of the antenna are set to make the measurement.
- d. For each suspected emission, the EUT was arranged to its worst case and the rotatable table was turned from 0 degrees to 360 degrees to find the maximum reading.
- e. The test-receiver system was set to Quasi-Peak Detect Function and Specified Bandwidth with Maximum Hold Mode, except for the frequency band (9 kHz to 90 kHz and 110 kHz to 490 kHz) set to average detect function and peak detect function.

Notes:

1. The resolution bandwidth and video bandwidth of test receiver/spectrum analyzer is 200 Hz at frequency below 150 kHz.
2. The resolution bandwidth and video bandwidth of test receiver/spectrum analyzer is 9 kHz or 10 kHz at frequency (150 kHz to 30 MHz).
3. All modes of operation were investigated and the worst-case emissions are reported.

For Radiated emission above 30 MHz

- a. The EUT was placed on the top of a rotating table 0.8 meters above the ground at 3 meter chamber room for test. The table was rotated 360 degrees to determine the position of the highest radiation.
- b. The EUT was set 3 meters away from the interference-receiving antenna, which was mounted on the top of a variable-height antenna tower.
- c. The height of antenna is varied from one meter to four meters above the ground to determine the maximum value of the field strength. Both horizontal and vertical polarizations of the antenna are set to make the measurement.
- d. For each suspected emission, the EUT was arranged to its worst case and then the antenna was tuned to heights from 1 meter to 4 meters and the rotatable table was turned from 0 degrees to 360 degrees to find the maximum reading.
- e. The test-receiver system was set to quasi-peak detect function and specified bandwidth with maximum hold mode when the test frequency is below 1 GHz.

Notes:

1. The resolution bandwidth and video bandwidth of test receiver/spectrum analyzer is 120 kHz for Quasi-peak detection (QP) at frequency below 1 GHz.
2. All modes of operation were investigated and the worst-case emissions are reported.

6.7 Unwanted Emissions above 1 GHz

6.7.1 Test Setup

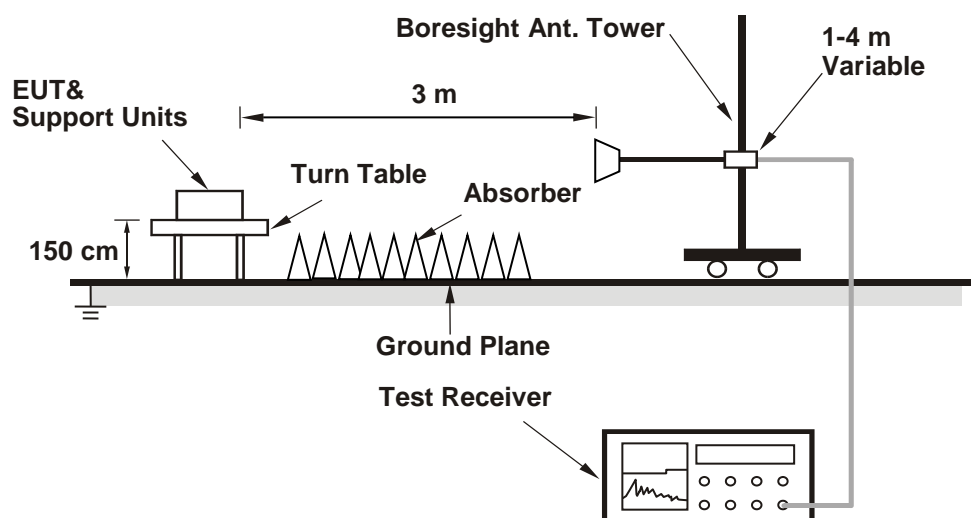

For the actual test configuration, please refer to the attached file (Test Setup Photo).

6.7.2 Test Procedure

- The EUT was placed on the top of a rotating table 1.5 meters above the ground at 3 meter chamber room for test. The table was rotated 360 degrees to determine the position of the highest radiation.
- The EUT was set 3 meters away from the interference-receiving antenna, which was mounted on the top of a variable-height antenna tower.
- The height of antenna is varied from one meter to four meters above the ground to determine the maximum value of the field strength. Both horizontal and vertical polarizations of the antenna are set to make the measurement.
- For each suspected emission, the EUT was arranged to its worst case and then the antenna was tuned to heights from 1 meter to 4 meters and the rotatable table was turned from 0 degrees to 360 degrees to find the maximum reading.
- The test-receiver system was set to peak and average detects function and specified bandwidth with maximum hold mode when the test frequency is above 1 GHz. If the peak reading value also meets average limit, measurement with the average detector is unnecessary.

Notes:

- The resolution bandwidth of test receiver/spectrum analyzer is 1 MHz and the video bandwidth is 3 MHz for Peak detection (PK) and Average detection (AV) at frequency above 1 GHz.
- For fundamental and harmonic signal measurement, the resolution bandwidth of test receiver/spectrum analyzer is 1 MHz and the video bandwidth is $\geq 1/T$ (Duty cycle $< 98\%$) or 10 Hz (Duty cycle $\geq 98\%$) for Average detection (AV) at frequency above 1 GHz.
- All modes of operation were investigated and the worst-case emissions are reported.

7 Test Results of Test Item

7.1 RF Output Power

Input Power:	120 Vac, 60 Hz	Environmental Conditions:	25°C, 61% RH	Tested By:	John Peng
--------------	----------------	---------------------------	--------------	------------	-----------

For Peak Power

802.11b

Chan.	Chan. Freq. (MHz)	Peak Power (dBm)		Total Power (mW)	Total Power (dBm)	Power Limit (dBm)	Test Result
		Chain 0	Chain 1				
1	2412	24.28	23.96	516.803	27.13	30	Pass
6	2437	25.14	24.80	628.583	27.98	30	Pass
11	2462	22.92	22.84	388.194	25.89	30	Pass

Notes:

1. Directional gain is the maximum gain of antennas.
2. The maximum gain is 5.76 dBi < 6 dBi, so the output power limit shall not be reduced.

802.11g

Chan.	Chan. Freq. (MHz)	Peak Power (dBm)		Total Power (mW)	Total Power (dBm)	Power Limit (dBm)	Test Result
		Chain 0	Chain 1				
1	2412	23.63	23.28	443.489	26.47	30	Pass
6	2437	25.13	24.83	629.925	27.99	30	Pass
11	2462	25.03	24.83	622.508	27.94	30	Pass

Notes:

1. Directional gain is the maximum gain of antennas.
2. The maximum gain is 5.76 dBi < 6 dBi, so the output power limit shall not be reduced.

VHT20

Chan.	Chan. Freq. (MHz)	Peak Power (dBm)		Total Power (mW)	Total Power (dBm)	Power Limit (dBm)	Test Result
		Chain 0	Chain 1				
1	2412	23.35	23.89	461.178	26.64	30	Pass
6	2437	25.22	24.56	618.419	27.91	30	Pass
11	2462	23.65	23.61	461.354	26.64	30	Pass

Notes:

1. Directional gain is the maximum gain of antennas.
2. The maximum gain is 5.76 dBi < 6 dBi, so the output power limit shall not be reduced.

VHT40

Chan.	Chan. Freq. (MHz)	Peak Power (dBm)		Total Power (mW)	Total Power (dBm)	Power Limit (dBm)	Test Result
		Chain 0	Chain 1				
3	2422	22.41	22.32	344.789	25.38	30	Pass
6	2437	23.76	23.58	465.718	26.68	30	Pass
9	2452	21.06	21.77	277.958	24.44	30	Pass

Notes:

1. Directional gain is the maximum gain of antennas.
2. The maximum gain is 5.76 dBi < 6 dBi, so the output power limit shall not be reduced.

802.11ax (HE20)

Chan.	Chan. Freq. (MHz)	Peak Power (dBm)		Total Power (mW)	Total Power (dBm)	Power Limit (dBm)	Test Result
		Chain 0	Chain 1				
1	2412	23.59	24.13	487.381	26.88	30	Pass
6	2437	25.30	24.60	627.247	27.97	30	Pass
11	2462	23.94	23.85	490.403	26.91	30	Pass

Notes:

1. Directional gain is the maximum gain of antennas.
2. The maximum gain is 5.76 dBi < 6 dBi, so the output power limit shall not be reduced.

802.11ax (HE40)

Chan.	Chan. Freq. (MHz)	Peak Power (dBm)		Total Power (mW)	Total Power (dBm)	Power Limit (dBm)	Test Result
		Chain 0	Chain 1				
3	2422	22.67	22.55	364.814	25.62	30	Pass
6	2437	24.03	23.79	492.261	26.92	30	Pass
9	2452	21.31	22.05	295.532	24.71	30	Pass

Notes:

1. Directional gain is the maximum gain of antennas.
2. The maximum gain is 5.76 dBi < 6 dBi, so the output power limit shall not be reduced.

For Average Power

802.11b

Chan.	Chan. Freq. (MHz)	Average Power (dBm)		Total Average Power (mW)	Total Average Power (dBm)
		Chain 0	Chain 1		
1	2412	22.46	22.03	335.786	25.26
6	2437	23.38	23.05	419.608	26.23
11	2462	20.63	20.47	227.041	23.56

802.11g

Chan.	Chan. Freq. (MHz)	Average Power (dBm)		Total Average Power (mW)	Total Average Power (dBm)
		Chain 0	Chain 1		
1	2412	16.01	15.47	75.14	18.76
6	2437	17.80	17.45	115.846	20.64
11	2462	17.85	17.78	120.933	20.83

VHT20

Chan.	Chan. Freq. (MHz)	Average Power (dBm)		Total Average Power (mW)	Total Average Power (dBm)
		Chain 0	Chain 1		
1	2412	15.87	15.21	71.826	18.56
6	2437	17.70	17.10	110.171	20.42
11	2462	16.07	15.65	77.186	18.88

VHT40

Chan.	Chan. Freq. (MHz)	Average Power (dBm)		Total Average Power (mW)	Total Average Power (dBm)
		Chain 0	Chain 1		
3	2422	14.91	14.54	59.419	17.74
6	2437	16.00	15.25	73.307	18.65
9	2452	13.96	13.72	48.439	16.85

802.11ax (HE20)

Chan.	Chan. Freq. (MHz)	Average Power (dBm)		Total Average Power (mW)	Total Average Power (dBm)
		Chain 0	Chain 1		
1	2412	16.08	15.48	75.869	18.80
6	2437	17.91	17.30	115.505	20.63
11	2462	16.29	15.94	81.824	19.13

802.11ax (HE40)

Chan.	Chan. Freq. (MHz)	Average Power (dBm)		Total Average Power (mW)	Total Average Power (dBm)
		Chain 0	Chain 1		
3	2422	15.12	14.83	62.918	17.99
6	2437	16.20	15.48	77.005	18.87
9	2452	14.25	13.98	51.611	17.13

7.2 Power Spectral Density

Input Power:	120 Vac, 60 Hz	Environmental Conditions:	25°C, 61% RH	Tested By:	John Peng
--------------	----------------	---------------------------	--------------	------------	-----------

802.11b

Chan.	Chan. Freq. (MHz)	PSD (dBm/3kHz)		Total PSD (dBm/3kHz)	PSD Limit (dBm/3kHz)	Test Result
		Chain 0	Chain 1			
1	2412	-2.23	-4.06	-0.04	5.36	Pass
6	2437	-3.48	-0.80	1.07	5.36	Pass
11	2462	-4.62	-4.58	-1.59	5.36	Pass

Notes:

- Method E) 2) b) Measure and sum spectral maxima across the outputs of KDB 662911 is using for calculating total power density.
- Directional gain = $10 \log[(10^{\text{Chain0}/20} + 10^{\text{Chain1}/20})^2 / 2]$
- The directional gain is 8.64 dBi > 6 dBi, so the power density limit shall be reduced to $8 - (8.64 - 6) = 5.36$ dBm/3kHz.

802.11g

Chan.	Chan. Freq. (MHz)	PSD (dBm/3kHz)		Total PSD (dBm/3kHz)	PSD Limit (dBm/3kHz)	Test Result
		Chain 0	Chain 1			
1	2412	-10.58	-10.86	-7.71	5.36	Pass
6	2437	-10.31	-9.58	-6.92	5.36	Pass
11	2462	-9.74	-10.26	-6.98	5.36	Pass

Notes:

- Method E) 2) b) Measure and sum spectral maxima across the outputs of KDB 662911 is using for calculating total power density.
- Directional gain = $10 \log[(10^{\text{Chain0}/20} + 10^{\text{Chain1}/20})^2 / 2]$
- The directional gain is 8.64 dBi > 6 dBi, so the power density limit shall be reduced to $8 - (8.64 - 6) = 5.36$ dBm/3kHz.

802.11ax (HE20)

Chan.	Chan. Freq. (MHz)	PSD (dBm/3kHz)		Total PSD (dBm/3kHz)	PSD Limit (dBm/3kHz)	Test Result
		Chain 0	Chain 1			
1	2412	-10.84	-11.66	-8.22	5.36	Pass
6	2437	-8.68	-8.95	-5.80	5.36	Pass
11	2462	-10.97	-12.08	-8.48	5.36	Pass

Notes:

- Method E) 2) b) Measure and sum spectral maxima across the outputs of KDB 662911 is using for calculating total power density.
- Directional gain = $10 \log[(10^{\text{Chain0}/20} + 10^{\text{Chain1}/20})^2 / 2]$
- The directional gain is 8.64 dBi > 6 dBi, so the power density limit shall be reduced to $8 - (8.64 - 6) = 5.36$ dBm/3kHz.



802.11ax (HE40)

Chan.	Chan. Freq. (MHz)	PSD (dBm/3kHz)		Total PSD (dBm/3kHz)	PSD Limit (dBm/3kHz)	Test Result
		Chain 0	Chain 1			
3	2422	-14.34	-15.34	-11.80	5.36	Pass
6	2437	-14.01	-14.34	-11.16	5.36	Pass
9	2452	-16.20	-16.72	-13.44	5.36	Pass

Notes:

- Method E) 2) b) Measure and sum spectral maxima across the outputs of KDB 662911 is using for calculating total power density.
- Directional gain = $10 \log[(10^{\text{Chain0}/20} + 10^{\text{Chain1}/20})^2 / 2]$
- The directional gain is 8.64 dBi > 6 dBi, so the power density limit shall be reduced to $8 - (8.64 - 6) = 5.36$ dBm/3kHz.

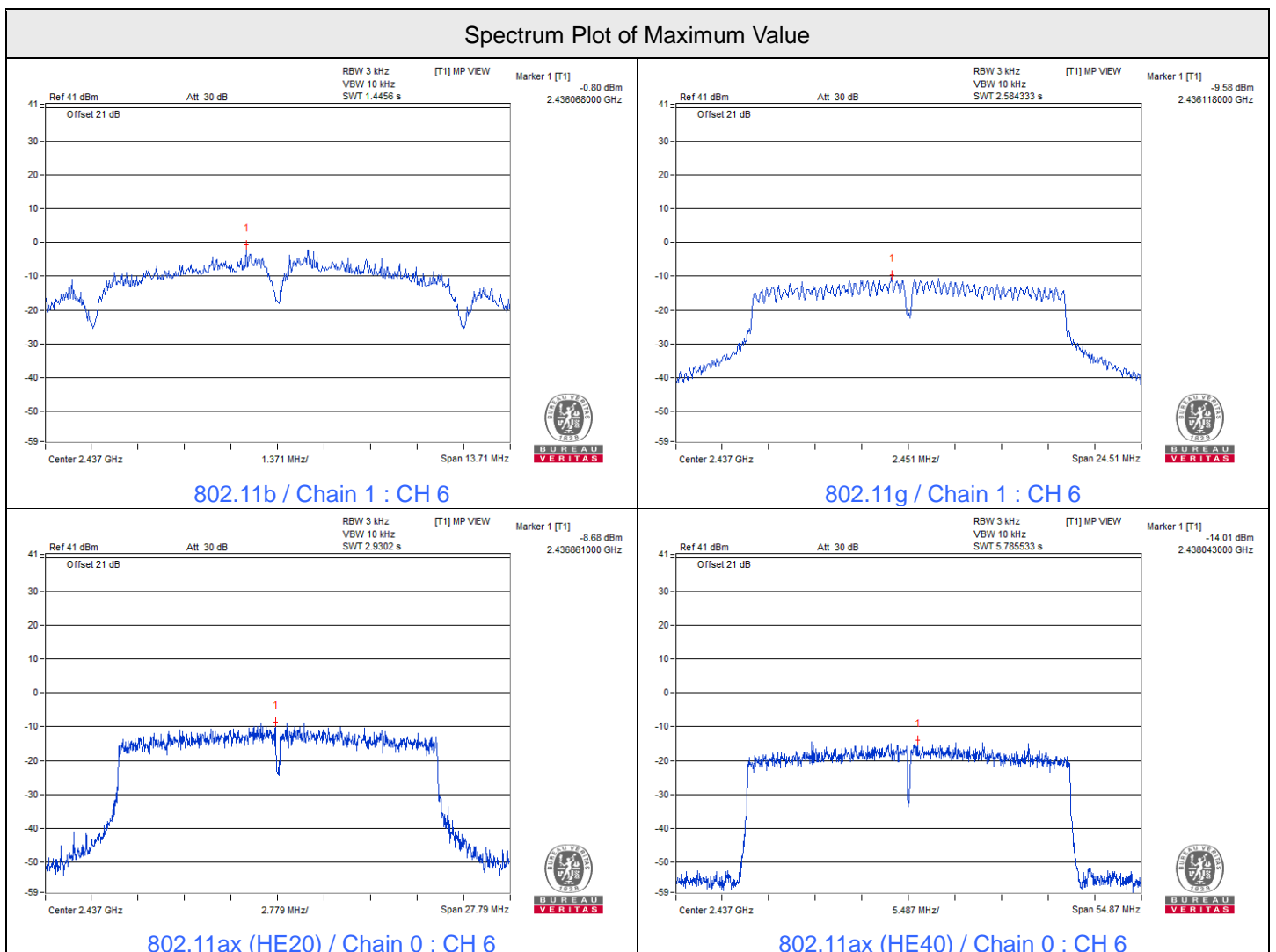

7.3 6 dB Bandwidth

Input Power:	120 Vac, 60 Hz	Environmental Conditions:	25°C, 61% RH	Tested By:	John Peng
--------------	----------------	---------------------------	--------------	------------	-----------

802.11b

Channel	Frequency (MHz)	6 dB Bandwidth (MHz)		Minimum Limit (MHz)	Test Result
		Chain 0	Chain 1		
1	2412	9.04	8.10	0.5	Pass
6	2437	9.11	9.14	0.5	Pass
11	2462	8.10	8.10	0.5	Pass

802.11g

Channel	Frequency (MHz)	6 dB Bandwidth (MHz)		Minimum Limit (MHz)	Test Result
		Chain 0	Chain 1		
1	2412	15.17	15.17	0.5	Pass
6	2437	15.35	16.34	0.5	Pass
11	2462	15.47	16.32	0.5	Pass

802.11ax (HE20)

Channel	Frequency (MHz)	6 dB Bandwidth (MHz)		Minimum Limit (MHz)	Test Result
		Chain 0	Chain 1		
1	2412	17.65	17.57	0.5	Pass
6	2437	18.53	18.09	0.5	Pass
11	2462	18.56	18.68	0.5	Pass

802.11ax (HE40)

Channel	Frequency (MHz)	6 dB Bandwidth (MHz)		Minimum Limit (MHz)	Test Result
		Chain 0	Chain 1		
3	2422	36.52	36.36	0.5	Pass
6	2437	36.58	35.21	0.5	Pass
9	2452	37.25	35.54	0.5	Pass

Spectrum Plot of Minimum Value

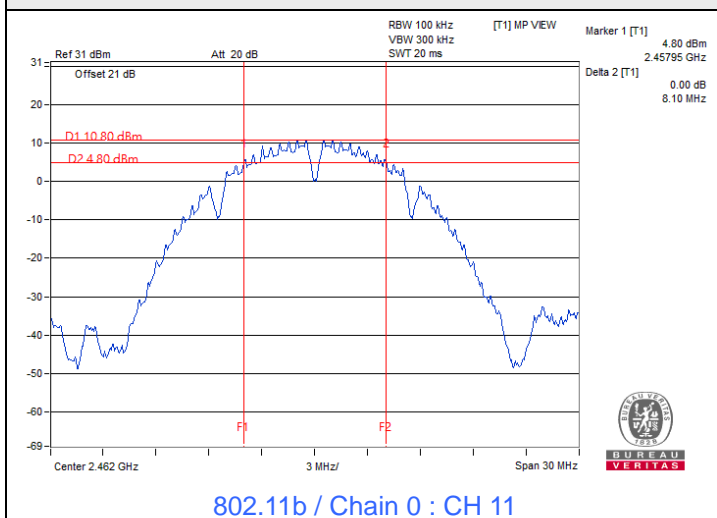

802.11b / Chain 0 : CH 11

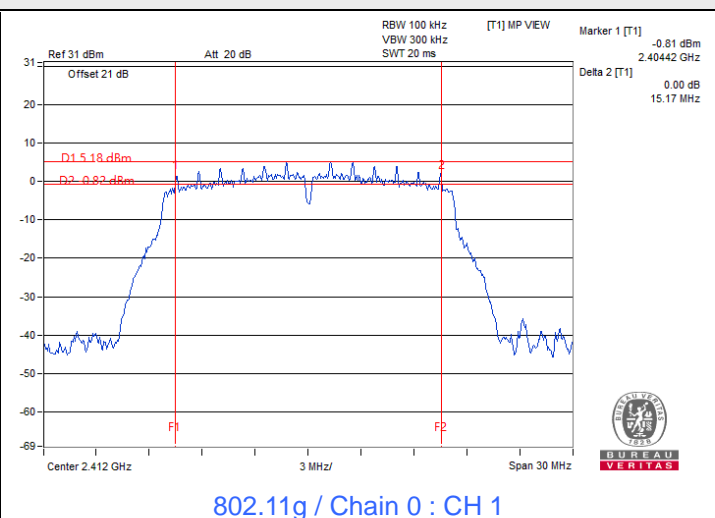

802.11g / Chain 0 : CH 1

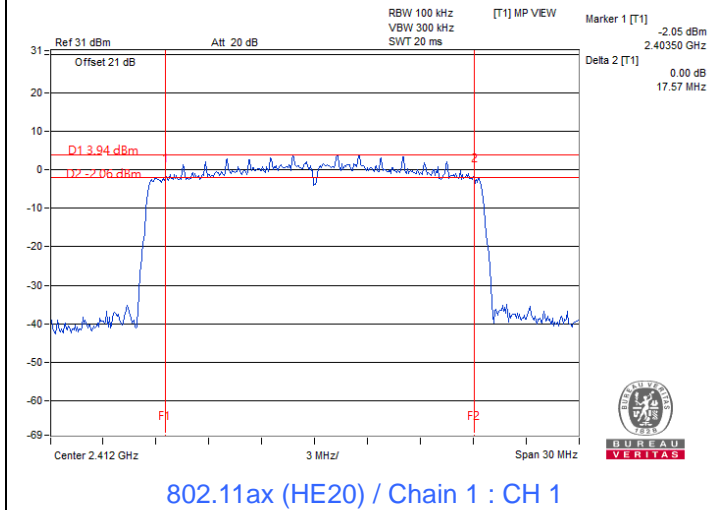

802.11ax (HE20) / Chain 1 : CH 1

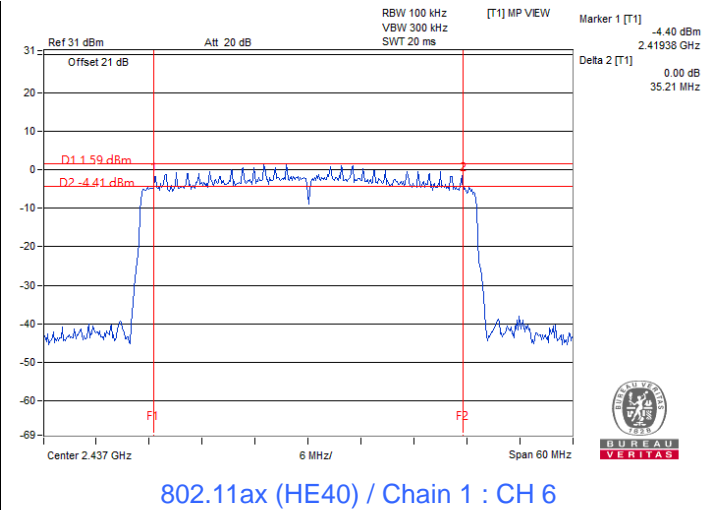

802.11ax (HE40) / Chain 1 : CH 6

7.4 Conducted Out of Band Emissions

Input Power:	120 Vac, 60 Hz	Environmental Conditions:	25°C, 61% RH	Tested By:	John Peng
--------------	----------------	---------------------------	--------------	------------	-----------

802.11b

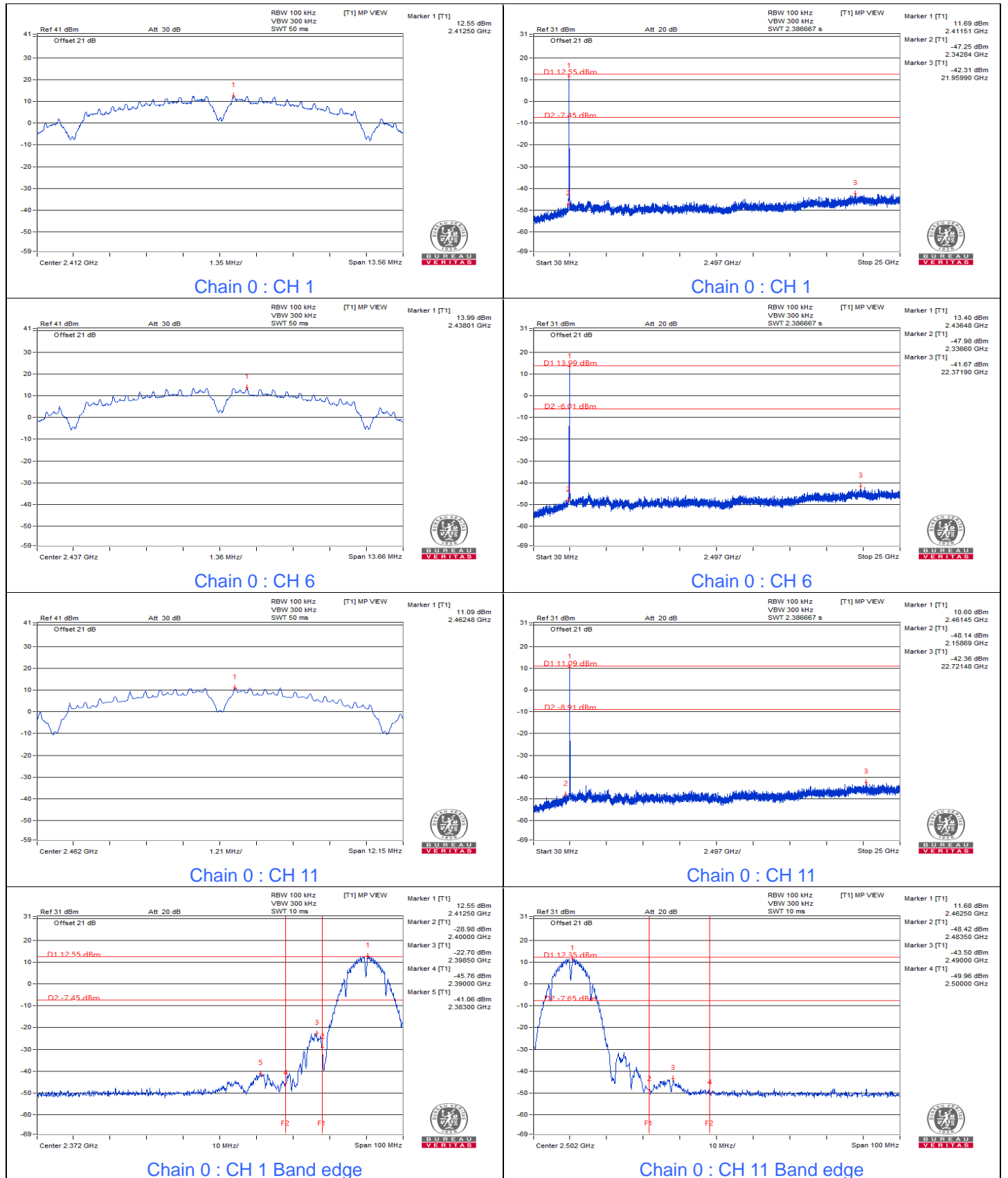

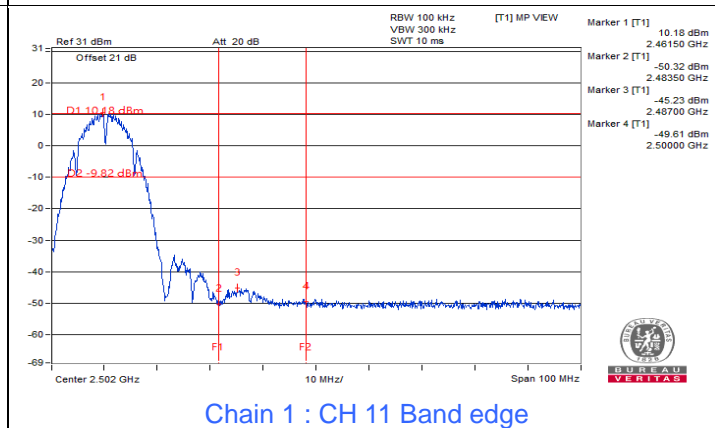
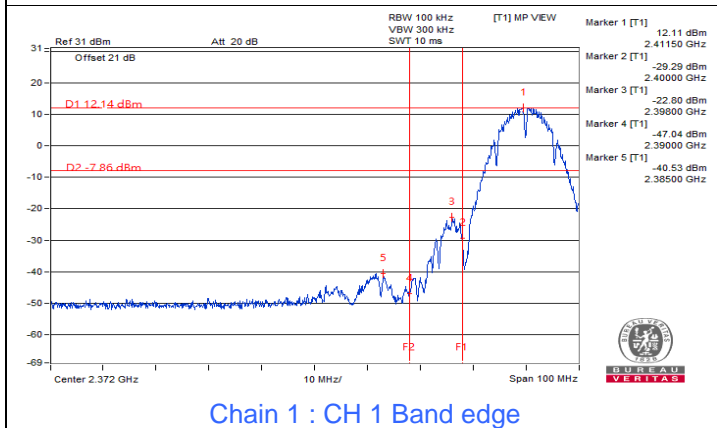
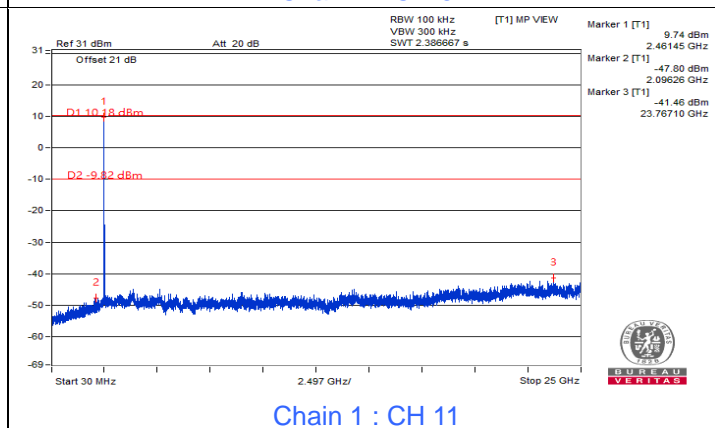
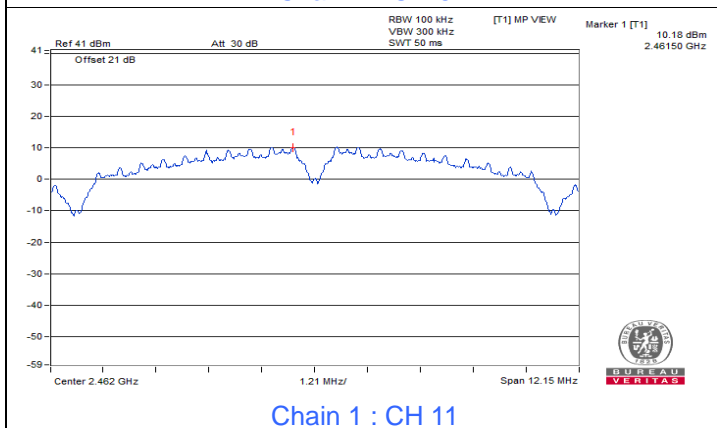
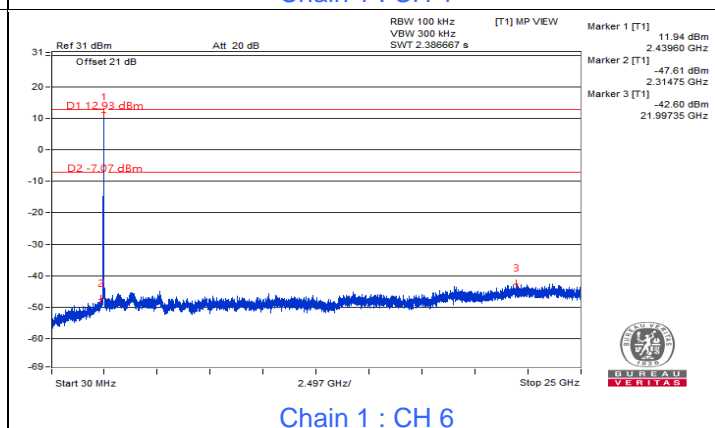
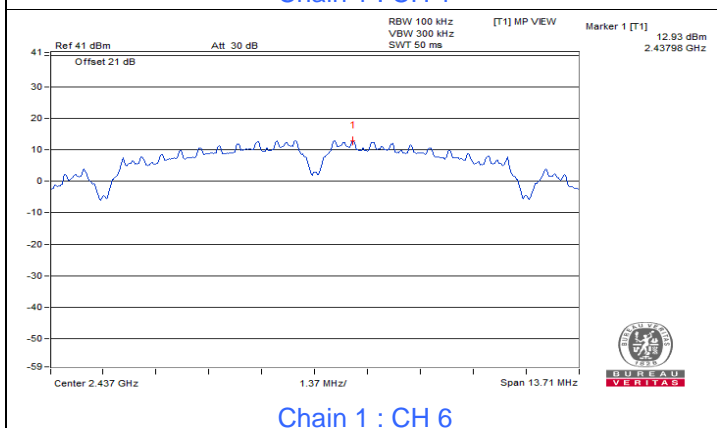
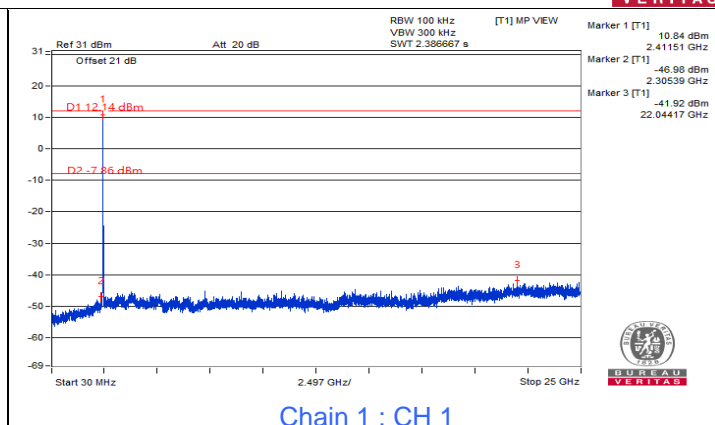
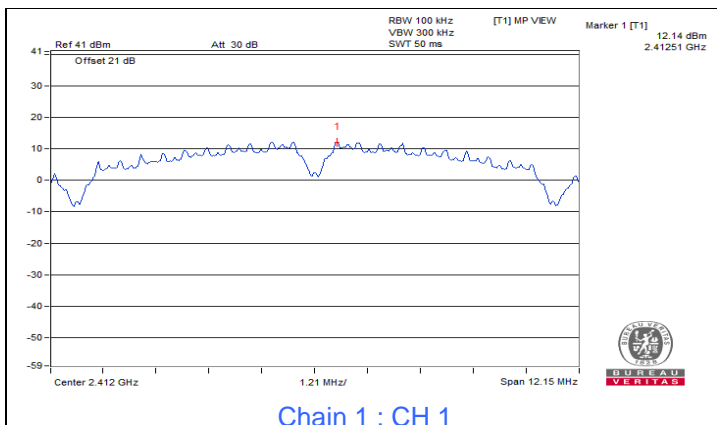



802.11g

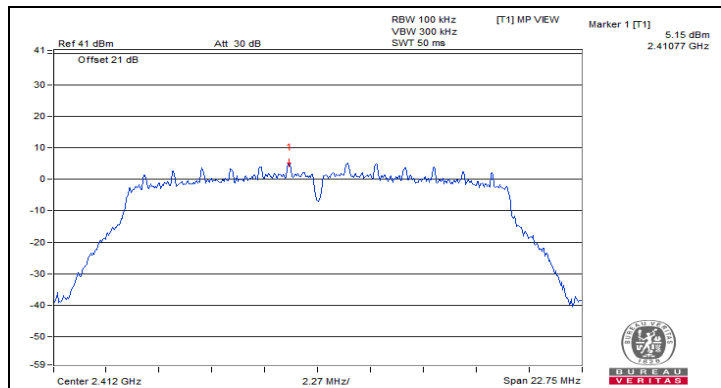

Chain 0 : CH 1

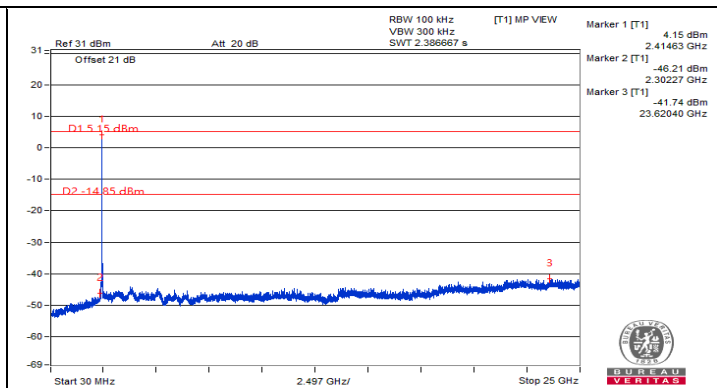

Chain 0 : CH 1

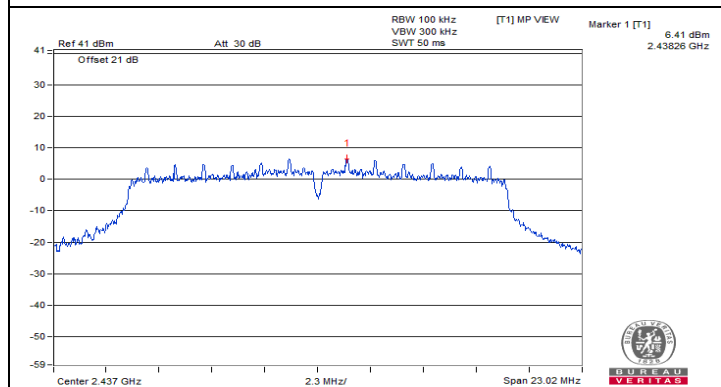

Chain 0 : CH 6

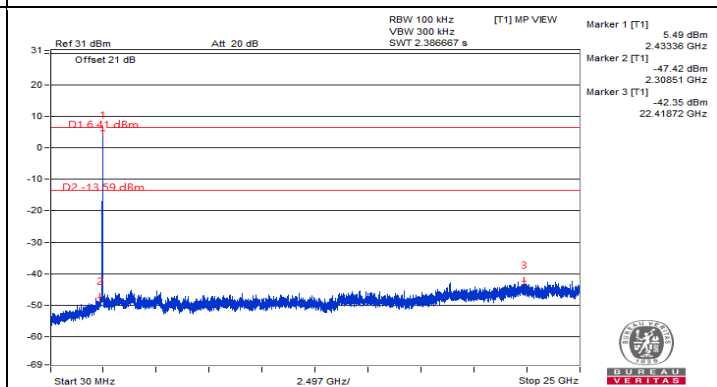

Chain 0 : CH 6

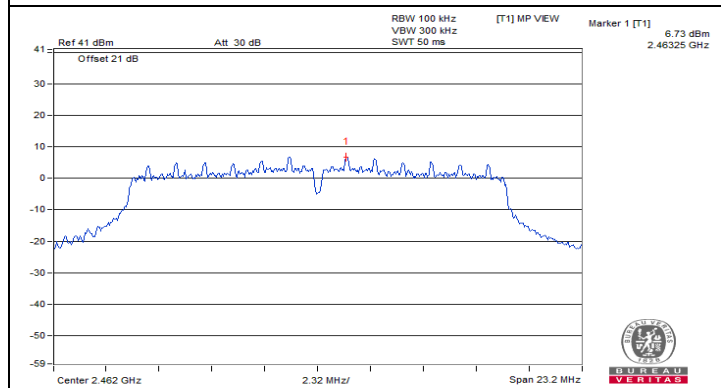

Chain 0 : CH 11

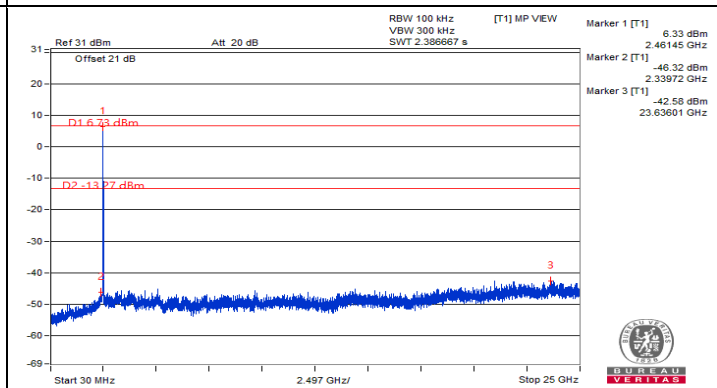

Chain 0 : CH 11

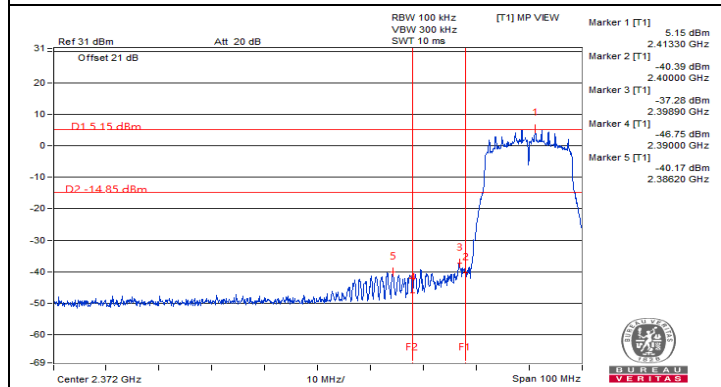

Chain 0 : CH 1 Band edge

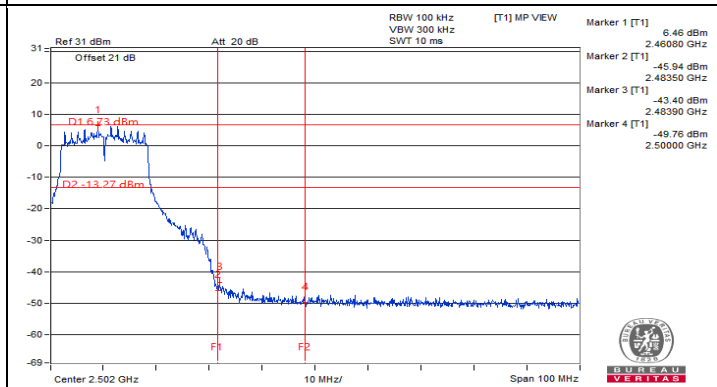

Chain 0 : CH 11 Band edge

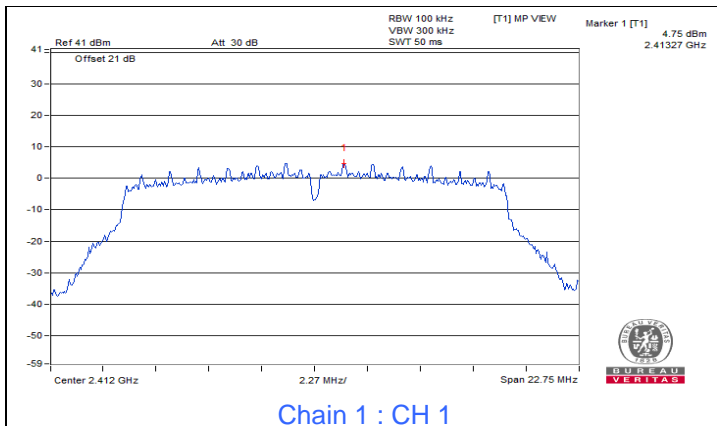

Chain 1 : CH 1

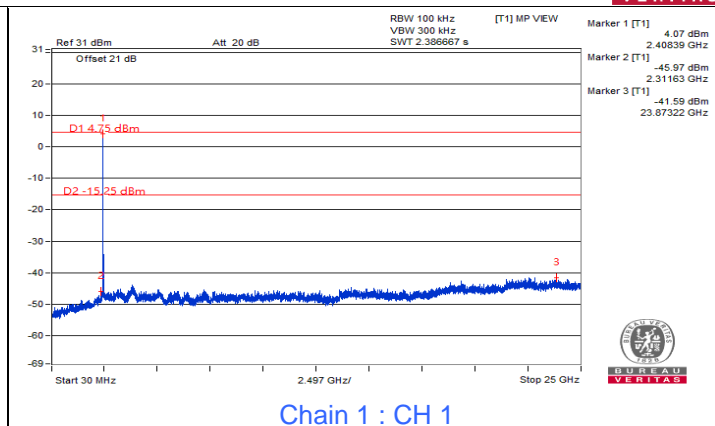

Chain 1 : CH 1

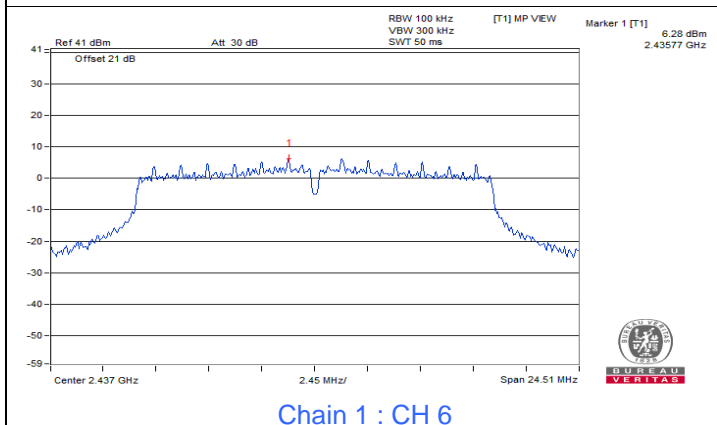

Chain 1 : CH 6

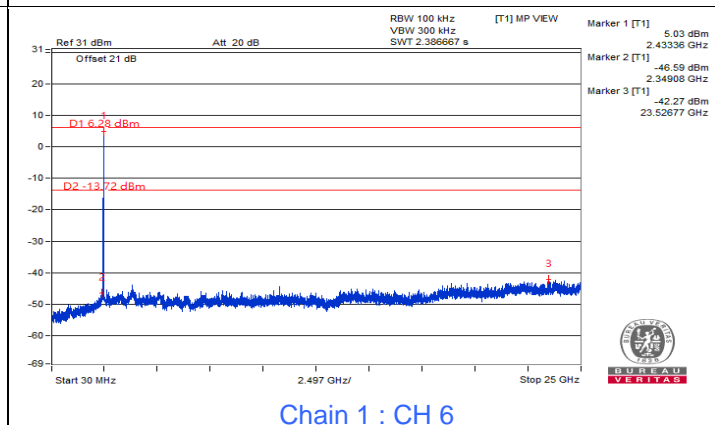

Chain 1 : CH 6

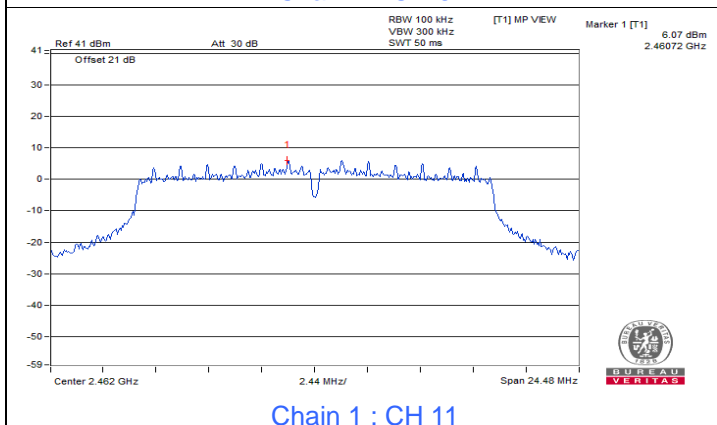

Chain 1 : CH 11

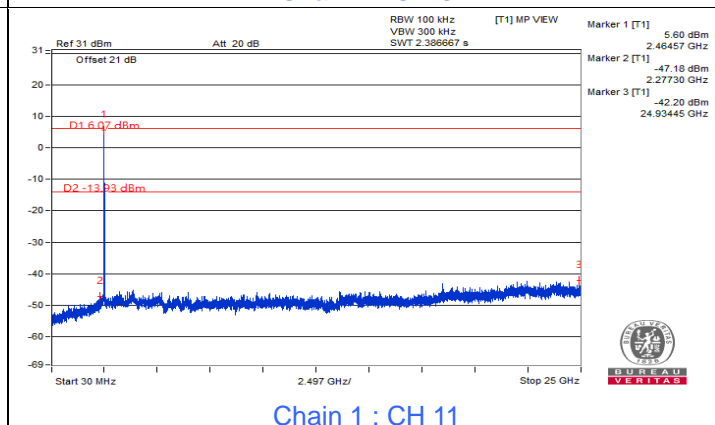

Chain 1 : CH 11

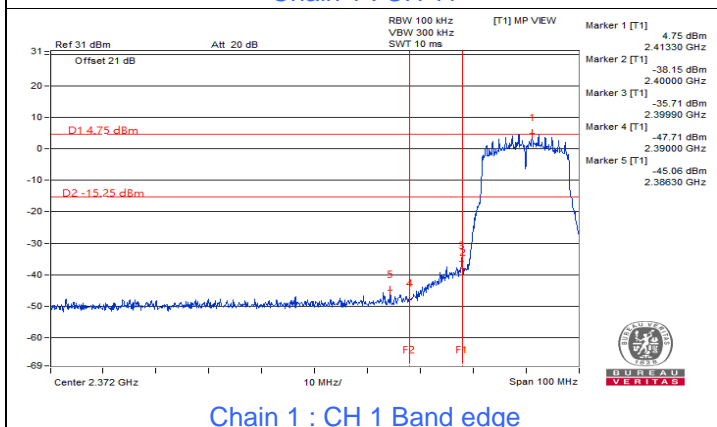

Chain 1 : CH 1 Band edge

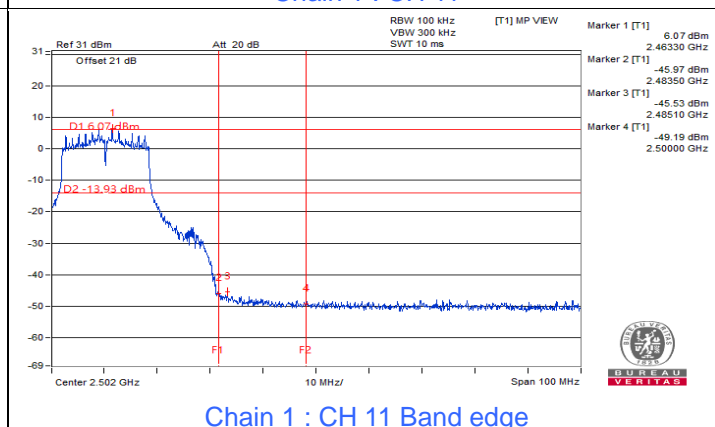

Chain 1 : CH 11 Band edge



802.11ax (HE20)

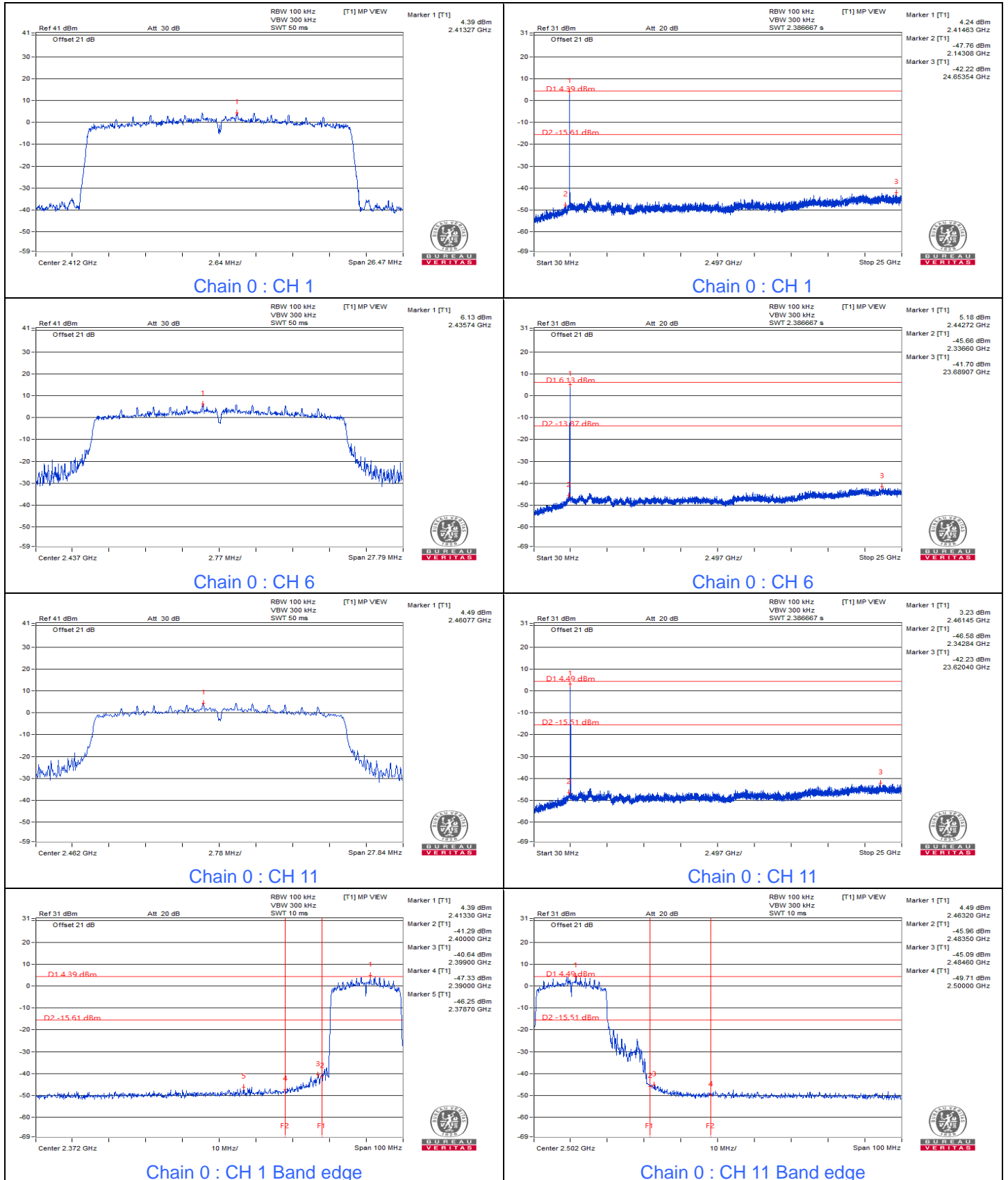

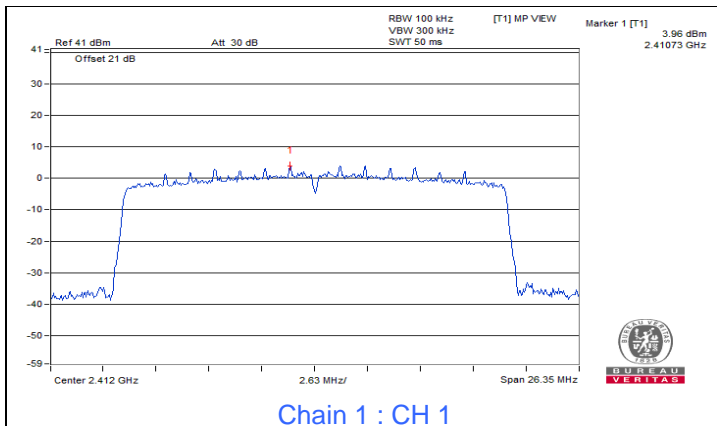

Chain 1 : CH 1

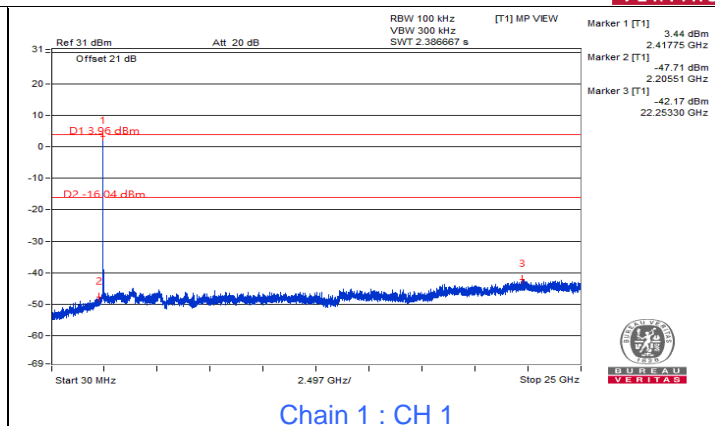

Chain 1 : CH 1

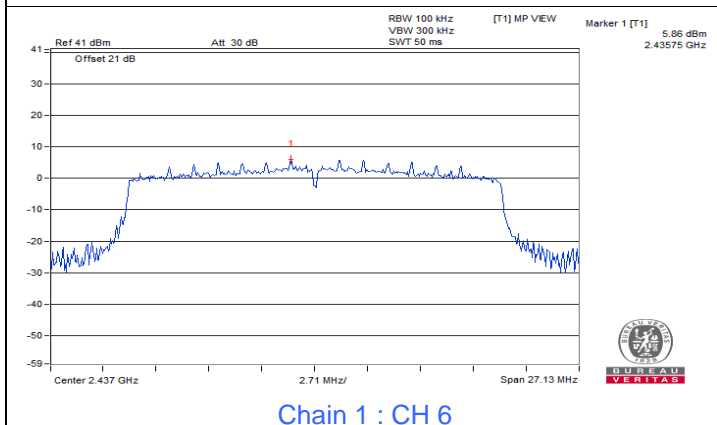

Chain 1 : CH 6

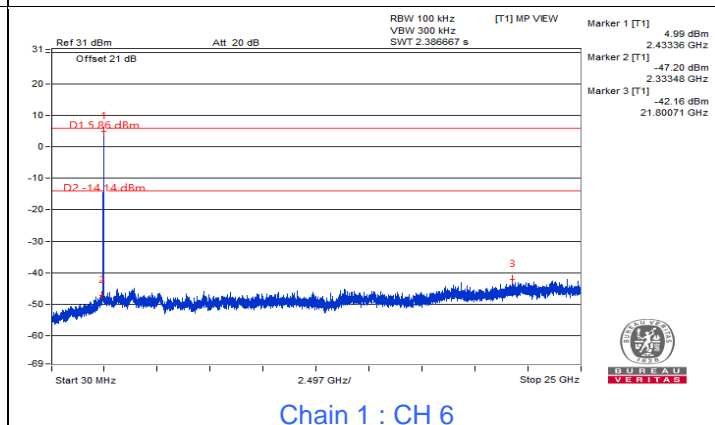

Chain 1 : CH 6

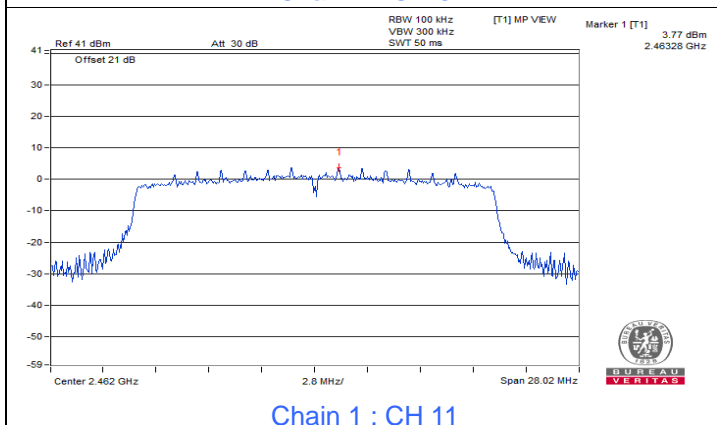

Chain 1 : CH 11

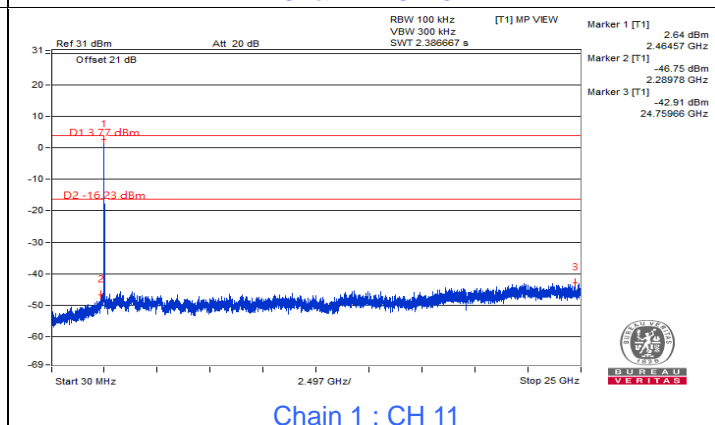

Chain 1 : CH 11

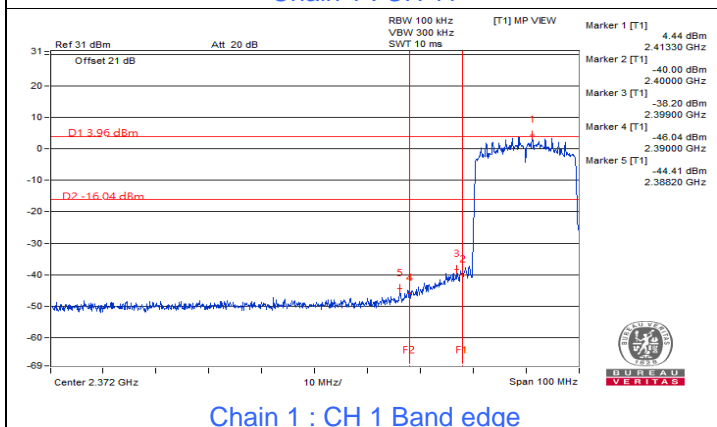

Chain 1 : CH 1 Band edge

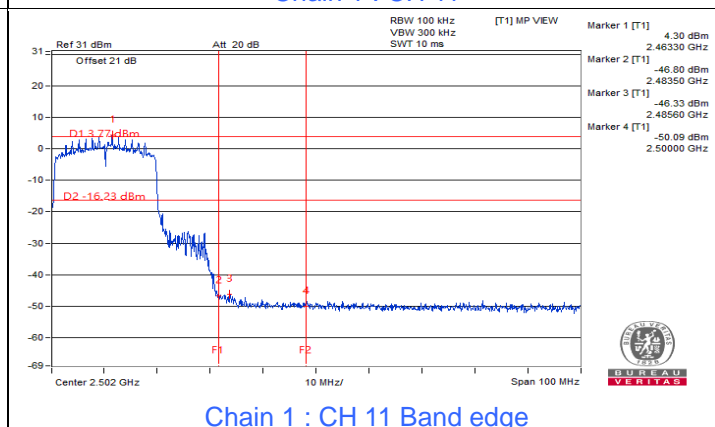

Chain 1 : CH 11 Band edge



BUREAU VERITAS

802.11ax (HE40)

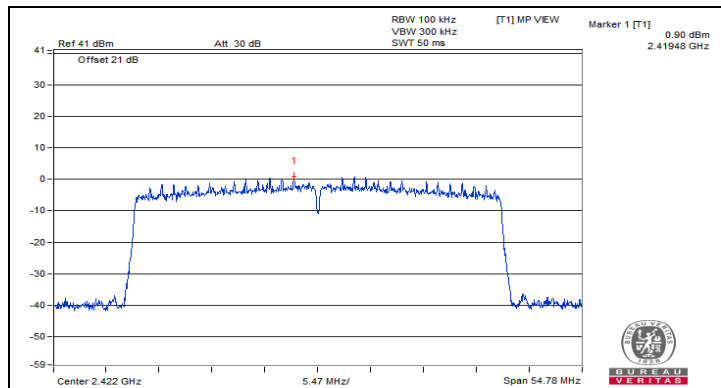

Chain 0 : CH 3

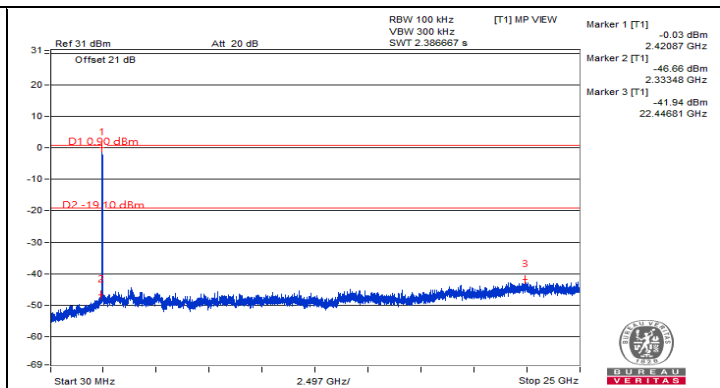

Chain 0 : CH 3

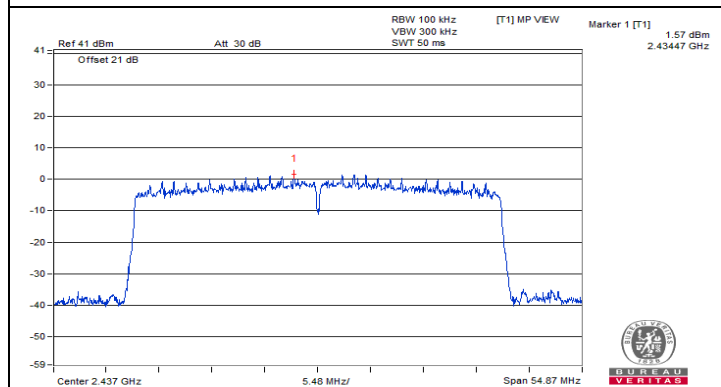

Chain 0 : CH 6

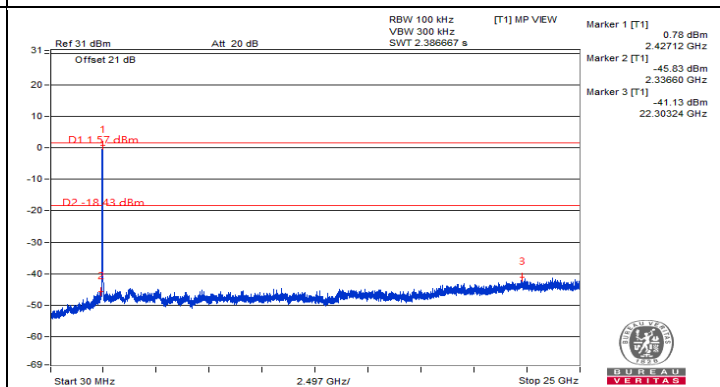

Chain 0 : CH 6

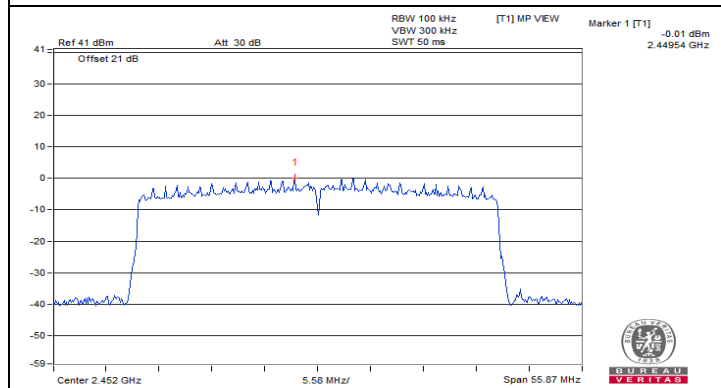

Chain 0 : CH 9

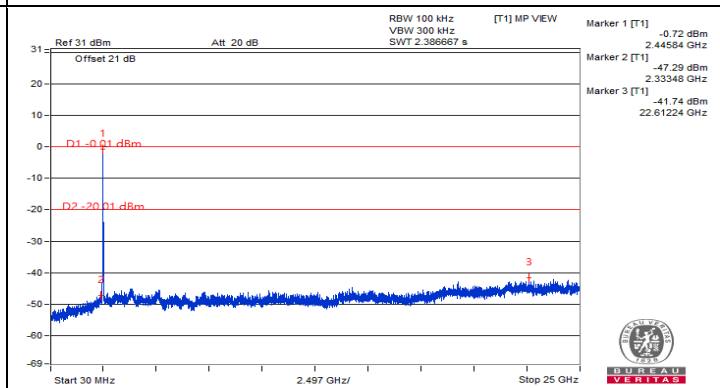

Chain 0 : CH 9

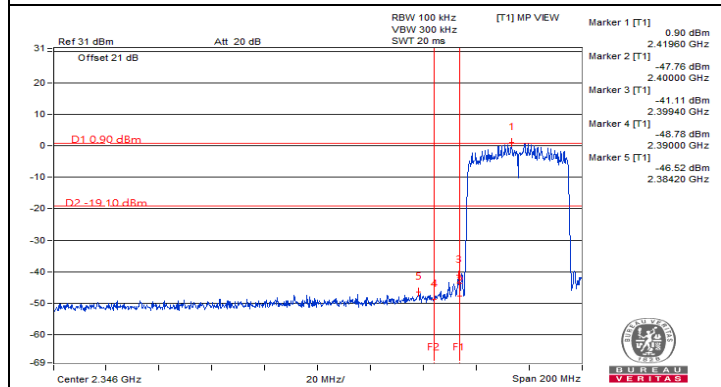

Chain 0 : CH 3 Band edge

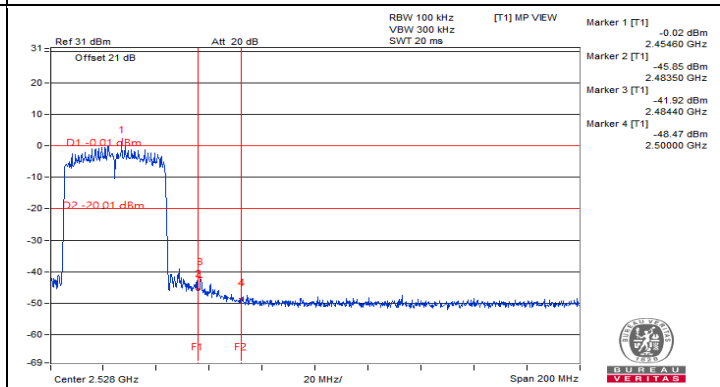

Chain 0 : CH 9 Band edge

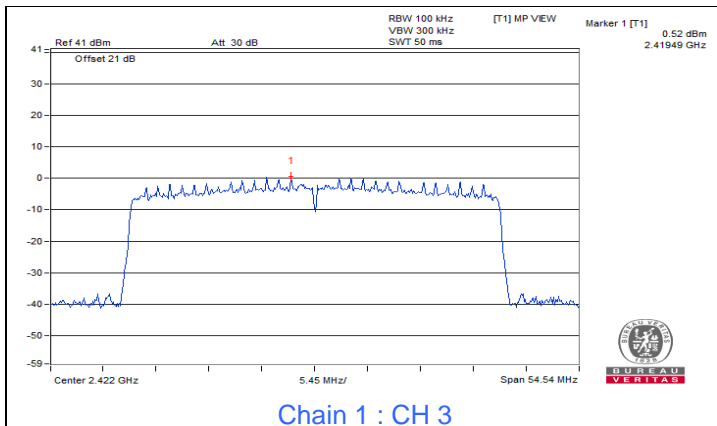

Chain 1 : CH 3

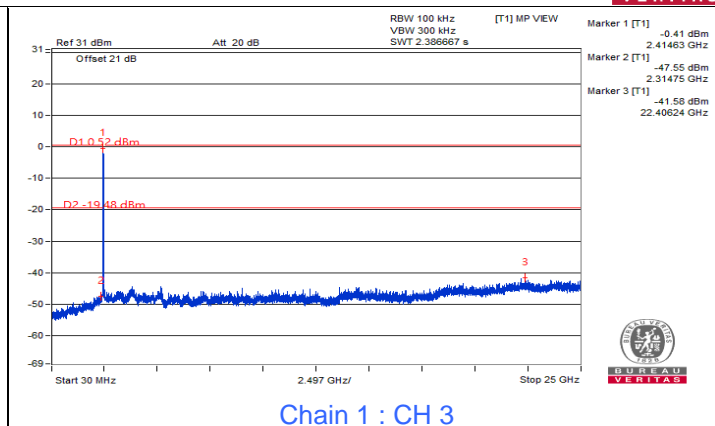

Chain 1 : CH 3

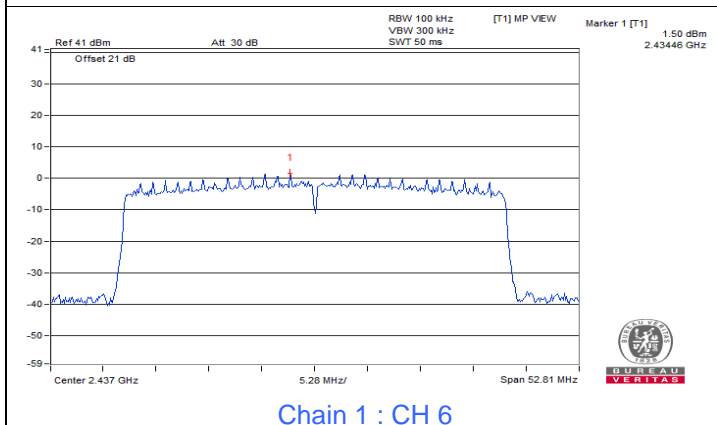

Chain 1 : CH 6

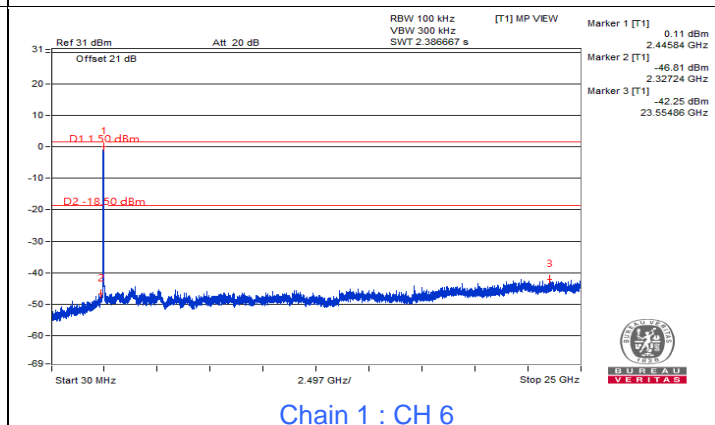

Chain 1 : CH 6

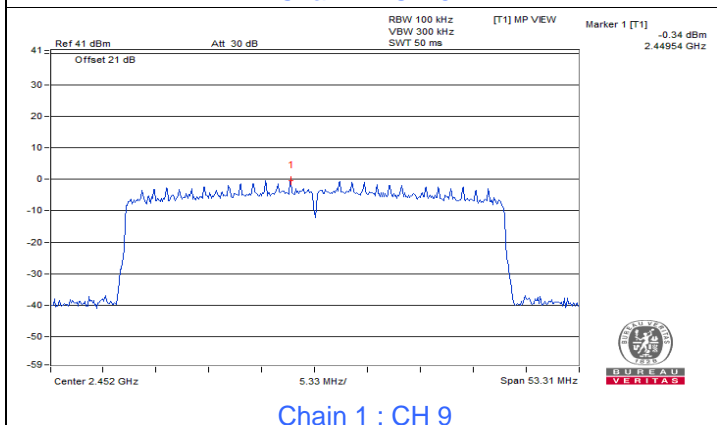

Chain 1 : CH 9

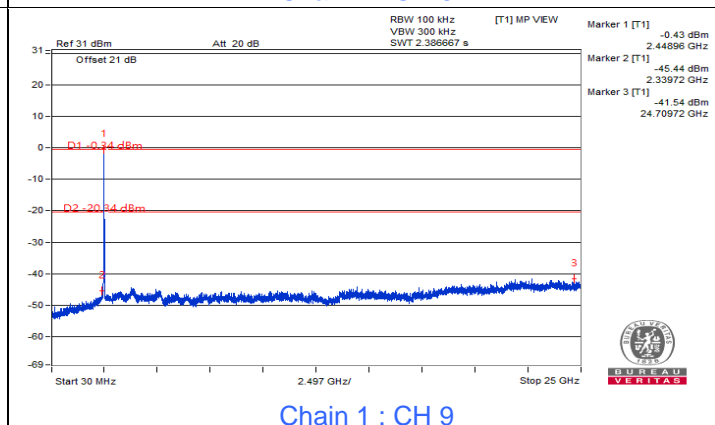

Chain 1 : CH 9

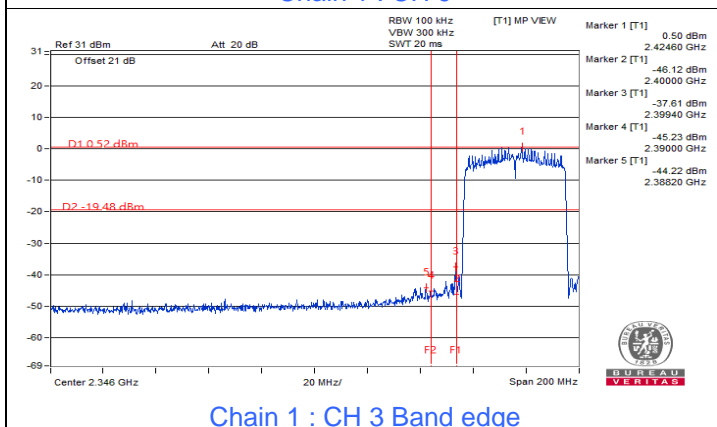

Chain 1 : CH 3 Band edge

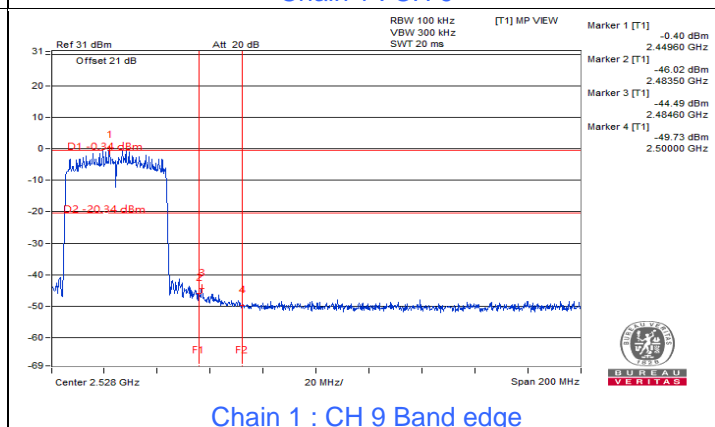

Chain 1 : CH 9 Band edge

7.5 AC Power Conducted Emissions

RF Mode	802.11b	Channel	CH 6 : 2437 MHz
Frequency Range	150kHz ~ 30MHz	Detector Function & Resolution Bandwidth	Quasi-Peak (QP) / Average (AV), 9 kHz
Input Power	120 Vac, 60 Hz	Environmental Conditions	23°C, 66% RH
Tested By	Sampson Chen		

Phase Of Power : Line (L)										
No	Frequency (MHz)	Correction Factor (dB)	Reading Value (dBuV)		Emission Level (dBuV)		Limit (dBuV)		Margin (dB)	
			Q.P.	AV.	Q.P.	AV.	Q.P.	AV.	Q.P.	AV.
1	0.15000	9.96	29.69	15.64	39.65	25.60	66.00	56.00	-26.35	-30.40
2	0.17344	9.96	26.16	12.53	36.12	22.49	64.79	54.79	-28.67	-32.30
3	0.31406	9.97	22.90	12.53	32.87	22.50	59.86	49.86	-26.99	-27.36
4	0.36484	9.97	24.37	16.39	34.34	26.36	58.62	48.62	-24.28	-22.26
5	10.36719	10.51	16.03	10.15	26.54	20.66	60.00	50.00	-33.46	-29.34
6	28.21875	11.23	21.76	15.96	32.99	27.19	60.00	50.00	-27.01	-22.81

Remarks:

1. Q.P. and AV. are abbreviations of quasi-peak and average individually.
2. The emission levels of other frequencies were very low against the limit.
3. Margin value = Emission level – Limit value
4. Correction factor = Insertion loss + Cable loss
5. Emission Level = Correction Factor + Reading Value

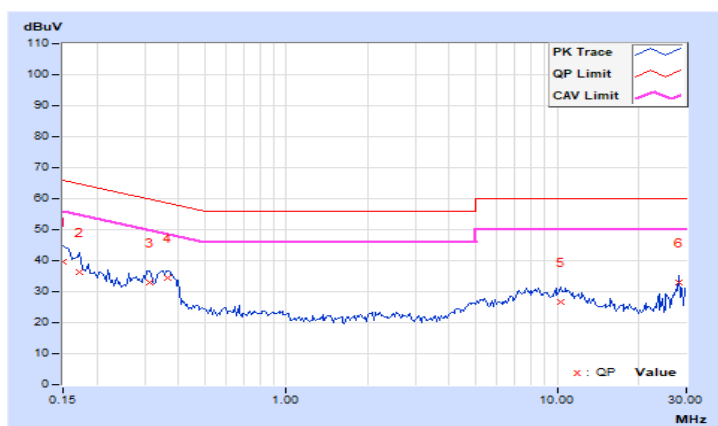

RF Mode	802.11b	Channel	CH 6 : 2437 MHz
Frequency Range	150kHz ~ 30MHz	Detector Function & Resolution Bandwidth	Quasi-Peak (QP) / Average (AV), 9 kHz
Input Power	120 Vac, 60 Hz	Environmental Conditions	23°C, 66% RH
Tested By	Sampson Chen		

Phase Of Power : Neutral (N)										
No	Frequency (MHz)	Correction Factor (dB)	Reading Value (dBuV)		Emission Level (dBuV)		Limit (dBuV)		Margin (dB)	
			Q.P.	AV.	Q.P.	AV.	Q.P.	AV.	Q.P.	AV.
1	0.15391	9.93	28.62	13.54	38.55	23.47	65.79	55.79	-27.24	-32.32
2	0.18516	9.94	20.89	8.38	30.83	18.32	64.25	54.25	-33.42	-35.93
3	0.31406	9.94	17.85	8.33	27.79	18.27	59.86	49.86	-32.07	-31.59
4	0.35313	9.94	21.06	10.59	31.00	20.53	58.89	48.89	-27.89	-28.36
5	10.66016	10.40	18.06	12.23	28.46	22.63	60.00	50.00	-31.54	-27.37
6	28.23047	10.87	19.03	11.55	29.90	22.42	60.00	50.00	-30.10	-27.58

Remarks:

1. Q.P. and AV. are abbreviations of quasi-peak and average individually.
2. The emission levels of other frequencies were very low against the limit.
3. Margin value = Emission level – Limit value
4. Correction factor = Insertion loss + Cable loss
5. Emission Level = Correction Factor + Reading Value

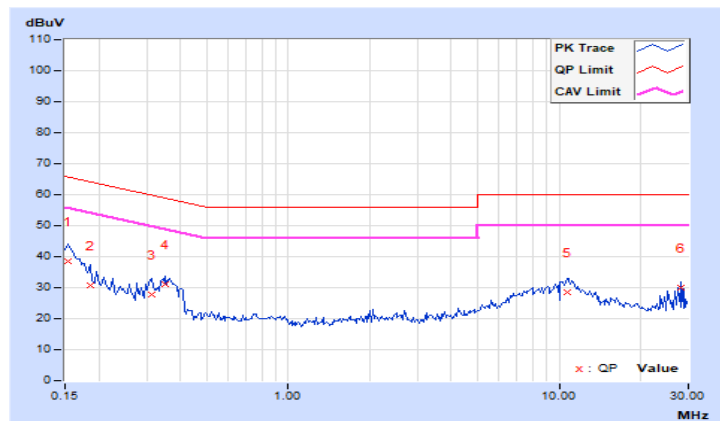

7.6 Unwanted Emissions below 1 GHz

RF Mode	802.11b	Channel	CH 6 : 2437 MHz
Frequency Range	30 MHz ~ 1 GHz	Detector Function & Bandwidth	(QP) RB = 120kHz
Input Power	120 Vac, 60 Hz	Environmental Conditions	25°C, 68% RH
Tested By	Tom Yang		

Antenna Polarity & Test Distance : Horizontal at 3 m								
No	Frequency (MHz)	Emission Level (dBuV/m)	Limit (dBuV/m)	Margin (dB)	Antenna Height (m)	Table Angle (Degree)	Raw Value (dBuV)	Correction Factor (dB/m)
1	33.10	27.8 QP	40.0	-12.2	2.00 H	243	37.0	-9.2
2	131.31	32.4 QP	43.5	-11.1	1.50 H	81	41.5	-9.1
3	215.92	34.3 QP	43.5	-9.2	1.00 H	334	45.4	-11.1
4	374.91	35.8 QP	46.0	-10.2	1.00 H	8	41.5	-5.7
5	509.83	30.9 QP	46.0	-15.1	2.00 H	55	33.4	-2.5
6	575.99	34.7 QP	46.0	-11.3	1.50 H	214	35.9	-1.2

Remarks:

1. Emission Level(dBuV/m) = Raw Value(dBuV) + Correction Factor(dB/m)
2. Correction Factor(dB/m) = Antenna Factor(dB/m) + Cable Factor(dB) – Pre-Amplifier Factor(dB)
3. Margin value = Emission Level – Limit value
4. The other emission levels were very low against the limit of frequency range 30 MHz ~ 1 GHz.
5. The emission levels were very low against the limit of frequency range 9 kHz ~ 30 MHz: the amplitude of spurious emissions attenuated more than 20 dB below the permissible value to be report.

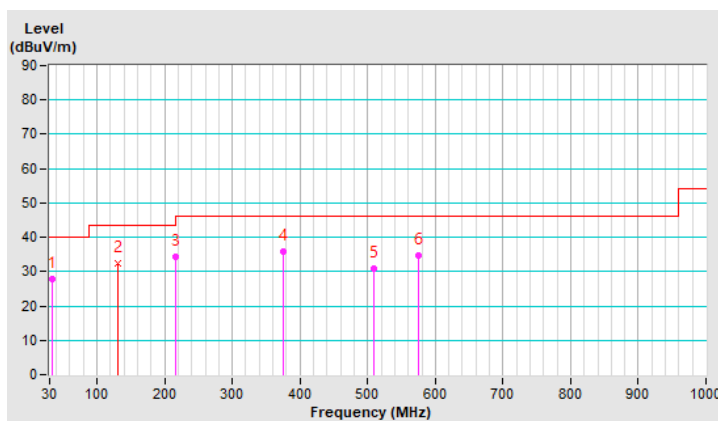

RF Mode	802.11b	Channel	CH 6 : 2437 MHz
Frequency Range	30 MHz ~ 1 GHz	Detector Function & Bandwidth	(QP) RB = 120kHz
Input Power	120 Vac, 60 Hz	Environmental Conditions	25°C, 68% RH
Tested By	Tom Yang		

Antenna Polarity & Test Distance : Vertical at 3 m								
No	Frequency (MHz)	Emission Level (dBuV/m)	Limit (dBuV/m)	Margin (dB)	Antenna Height (m)	Table Angle (Degree)	Raw Value (dBuV)	Correction Factor (dB/m)
1	33.45	35.0 QP	40.0	-5.0	1.00 V	135	44.1	-9.1
2	109.08	34.2 QP	43.5	-9.3	1.50 V	360	45.2	-11.0
3	196.33	32.6 QP	43.5	-10.9	1.00 V	340	43.7	-11.1
4	282.81	32.2 QP	46.0	-13.8	1.00 V	152	40.3	-8.1
5	375.00	29.5 QP	46.0	-16.5	1.00 V	8	35.2	-5.7
6	718.63	28.0 QP	46.0	-18.0	1.50 V	227	27.0	1.0

Remarks:

1. Emission Level(dBuV/m) = Raw Value(dBuV) + Correction Factor(dB/m)
2. Correction Factor(dB/m) = Antenna Factor(dB/m) + Cable Factor(dB) – Pre-Amplifier Factor(dB)
3. Margin value = Emission Level – Limit value
4. The other emission levels were very low against the limit of frequency range 30 MHz ~ 1 GHz.
5. The emission levels were very low against the limit of frequency range 9 kHz ~ 30 MHz: the amplitude of spurious emissions attenuated more than 20 dB below the permissible value to be report.

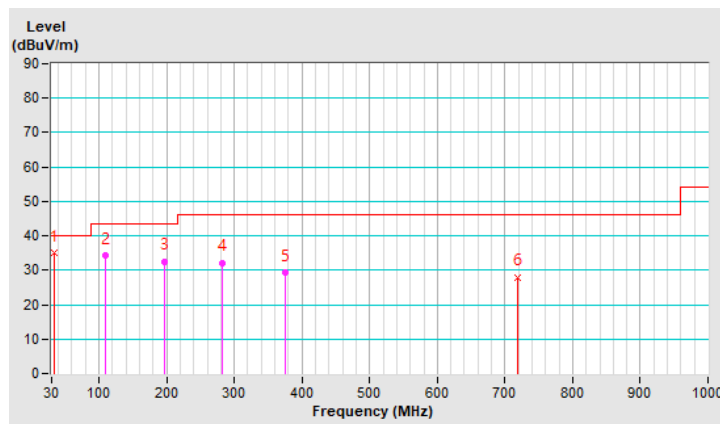

7.7 Unwanted Emissions above 1 GHz

RF Mode	802.11b	Channel	CH 1 : 2412 MHz
Frequency Range	1 GHz ~ 25 GHz	Detector Function & Bandwidth	(PK) RB = 1 MHz, VB = 3 MHz (AV) RB = 1 MHz, VB = 200 Hz
Input Power	120 Vac, 60 Hz	Environmental Conditions	25°C, 69% RH
Tested By	Nelson Teng		

Antenna Polarity & Test Distance : Horizontal at 3 m								
No	Frequency (MHz)	Emission Level (dBuV/m)	Limit (dBuV/m)	Margin (dB)	Antenna Height (m)	Table Angle (Degree)	Raw Value (dBuV)	Correction Factor (dB/m)
1	2390.00	59.0 PK	74.0	-15.0	1.27 H	1	59.9	-0.9
2	2390.00	49.0 AV	54.0	-5.0	1.27 H	1	49.9	-0.9
3	*2412.00	111.4 PK			1.27 H	1	112.2	-0.8
4	*2412.00	109.0 AV			1.27 H	1	109.8	-0.8
5	4824.00	47.7 PK	74.0	-26.3	1.04 H	198	44.0	3.7
6	4824.00	46.7 AV	54.0	-7.3	1.04 H	198	43.0	3.7

Remarks:

1. Emission Level(dBuV/m) = Raw Value(dBuV) + Correction Factor(dB/m)
2. Correction Factor(dB/m) = Antenna Factor(dB/m) + Cable Factor(dB) – Pre-Amplifier Factor(dB)
3. Margin value = Emission Level – Limit value
4. The other emission levels were very low against the limit.
5. " * ": Fundamental frequency, the limit was restricted at the RF Output Power.

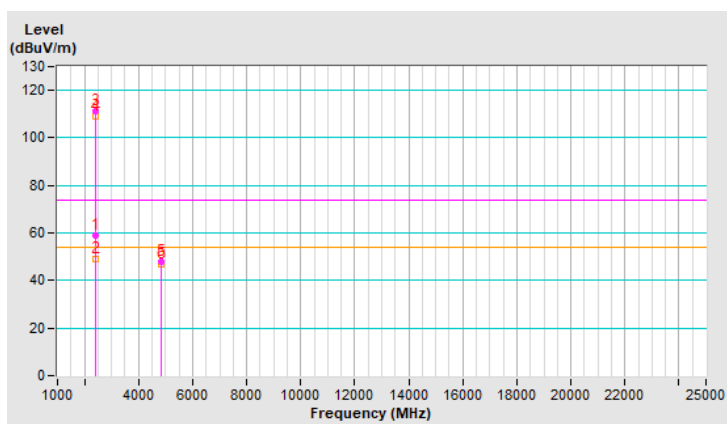

RF Mode	802.11b	Channel	CH 1 : 2412 MHz
Frequency Range	1 GHz ~ 25 GHz	Detector Function & Bandwidth	(PK) RB = 1 MHz, VB = 3 MHz (AV) RB = 1 MHz, VB = 200 Hz
Input Power	120 Vac, 60 Hz	Environmental Conditions	25°C, 69% RH
Tested By	Nelson Teng		

Antenna Polarity & Test Distance : Vertical at 3 m								
No	Frequency (MHz)	Emission Level (dBUV/m)	Limit (dBUV/m)	Margin (dB)	Antenna Height (m)	Table Angle (Degree)	Raw Value (dBUV)	Correction Factor (dB/m)
1	2390.00	58.8 PK	74.0	-15.2	1.46 V	131	59.7	-0.9
2	2390.00	46.9 AV	54.0	-7.1	1.46 V	131	47.8	-0.9
3	*2412.00	109.2 PK			1.46 V	131	110.0	-0.8
4	*2412.00	106.8 AV			1.46 V	131	107.6	-0.8
5	4824.00	51.2 PK	74.0	-22.8	1.45 V	153	47.5	3.7
6	4824.00	49.8 AV	54.0	-4.2	1.45 V	153	46.1	3.7

Remarks:

1. Emission Level(dBUV/m) = Raw Value(dBUV) + Correction Factor(dB/m)
2. Correction Factor(dB/m) = Antenna Factor(dB/m) + Cable Factor(dB) – Pre-Amplifier Factor(dB)
3. Margin value = Emission Level – Limit value
4. The other emission levels were very low against the limit.
5. " * " : Fundamental frequency, the limit was restricted at the RF Output Power.

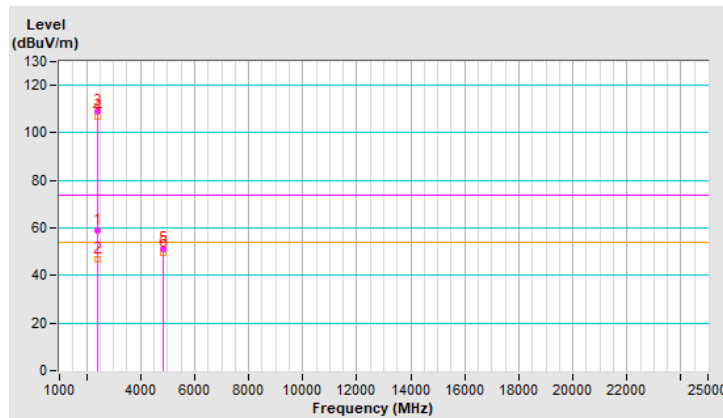

RF Mode	802.11b	Channel	CH 6 : 2437 MHz
Frequency Range	1 GHz ~ 25 GHz	Detector Function & Bandwidth	(PK) RB = 1 MHz, VB = 3 MHz (AV) RB = 1 MHz, VB = 200 Hz
Input Power	120 Vac, 60 Hz	Environmental Conditions	25°C, 69% RH
Tested By	Nelson Teng		

Antenna Polarity & Test Distance : Horizontal at 3 m								
No	Frequency (MHz)	Emission Level (dBuV/m)	Limit (dBuV/m)	Margin (dB)	Antenna Height (m)	Table Angle (Degree)	Raw Value (dBuV)	Correction Factor (dB/m)
1	2390.00	59.0 PK	74.0	-15.0	1.60 H	29	59.9	-0.9
2	2390.00	48.9 AV	54.0	-5.1	1.60 H	29	49.8	-0.9
3	*2437.00	115.6 PK			1.60 H	29	116.4	-0.8
4	*2437.00	113.3 AV			1.60 H	29	114.1	-0.8
5	2483.50	55.7 PK	74.0	-18.3	1.60 H	29	56.6	-0.9
6	2483.50	44.3 AV	54.0	-9.7	1.60 H	29	45.2	-0.9
7	4874.00	48.2 PK	74.0	-25.8	1.04 H	191	44.5	3.7
8	4874.00	47.0 AV	54.0	-7.0	1.04 H	191	43.3	3.7
9	7311.00	44.7 PK	74.0	-29.3	1.00 H	134	34.2	10.5
10	7311.00	41.1 AV	54.0	-12.9	1.00 H	134	30.6	10.5

Remarks:

1. Emission Level(dBuV/m) = Raw Value(dBuV) + Correction Factor(dB/m)
2. Correction Factor(dB/m) = Antenna Factor(dB/m) + Cable Factor(dB) – Pre-Amplifier Factor(dB)
3. Margin value = Emission Level – Limit value
4. The other emission levels were very low against the limit.
5. " * " : Fundamental frequency, the limit was restricted at the RF Output Power.

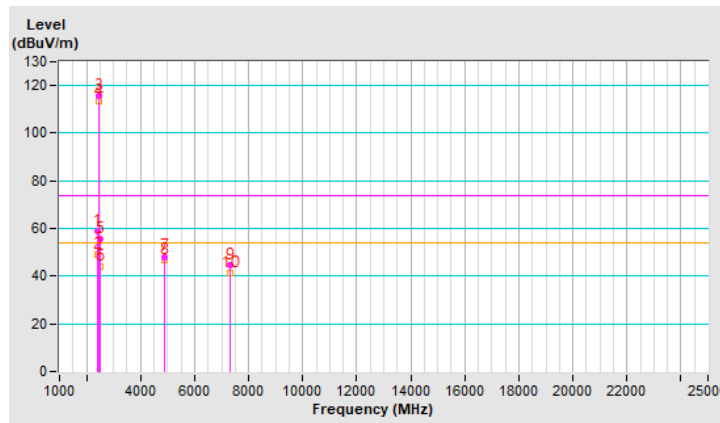

RF Mode	802.11b	Channel	CH 6 : 2437 MHz
Frequency Range	1 GHz ~ 25 GHz	Detector Function & Bandwidth	(PK) RB = 1 MHz, VB = 3 MHz (AV) RB = 1 MHz, VB = 200 Hz
Input Power	120 Vac, 60 Hz	Environmental Conditions	25°C, 69% RH
Tested By	Nelson Teng		

Antenna Polarity & Test Distance : Vertical at 3 m								
No	Frequency (MHz)	Emission Level (dBuV/m)	Limit (dBuV/m)	Margin (dB)	Antenna Height (m)	Table Angle (Degree)	Raw Value (dBuV)	Correction Factor (dB/m)
1	2390.00	57.1 PK	74.0	-16.9	1.09 V	54	58.0	-0.9
2	2390.00	45.1 AV	54.0	-8.9	1.09 V	54	46.0	-0.9
3	*2437.00	110.8 PK			1.09 V	54	111.6	-0.8
4	*2437.00	108.6 AV			1.09 V	54	109.4	-0.8
5	2483.50	56.8 PK	74.0	-17.2	1.09 V	54	57.7	-0.9
6	2483.50	44.1 AV	54.0	-9.9	1.09 V	54	45.0	-0.9
7	4874.00	50.5 PK	74.0	-23.5	1.44 V	151	46.8	3.7
8	4874.00	49.3 AV	54.0	-4.7	1.44 V	151	45.6	3.7
9	7311.00	42.0 PK	74.0	-32.0	1.24 V	163	31.5	10.5
10	7311.00	37.7 AV	54.0	-16.3	1.24 V	163	27.2	10.5

Remarks:

1. Emission Level(dBuV/m) = Raw Value(dBuV) + Correction Factor(dB/m)
2. Correction Factor(dB/m) = Antenna Factor(dB/m) + Cable Factor(dB) – Pre-Amplifier Factor(dB)
3. Margin value = Emission Level – Limit value
4. The other emission levels were very low against the limit.
5. " * ": Fundamental frequency, the limit was restricted at the RF Output Power.

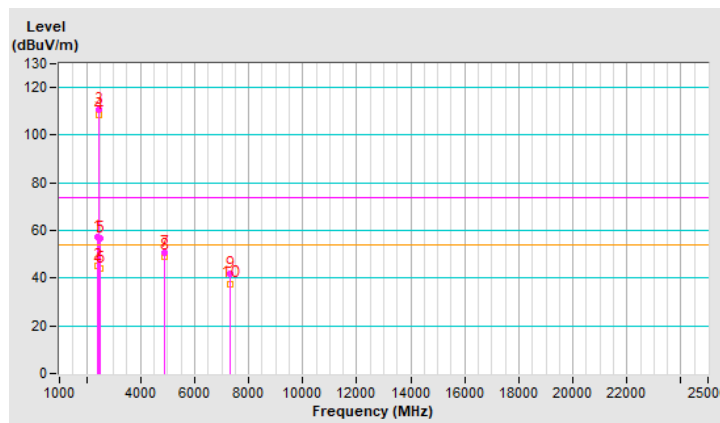

RF Mode	802.11b	Channel	CH 11 : 2462 MHz
Frequency Range	1 GHz ~ 25 GHz	Detector Function & Bandwidth	(PK) RB = 1 MHz, VB = 3 MHz (AV) RB = 1 MHz, VB = 200 Hz
Input Power	120 Vac, 60 Hz	Environmental Conditions	25°C, 69% RH
Tested By	Nelson Teng		

Antenna Polarity & Test Distance : Horizontal at 3 m								
No	Frequency (MHz)	Emission Level (dBuV/m)	Limit (dBuV/m)	Margin (dB)	Antenna Height (m)	Table Angle (Degree)	Raw Value (dBuV)	Correction Factor (dB/m)
1	*2462.00	112.3 PK			1.24 H	11	113.1	-0.8
2	*2462.00	109.8 AV			1.24 H	11	110.6	-0.8
3	2483.50	57.9 PK	74.0	-16.1	1.24 H	11	58.8	-0.9
4	2483.50	49.5 AV	54.0	-4.5	1.24 H	11	50.4	-0.9
5	4924.00	48.8 PK	74.0	-25.2	1.09 H	201	45.0	3.8
6	4924.00	47.4 AV	54.0	-6.6	1.09 H	201	43.6	3.8
7	7386.00	44.5 PK	74.0	-29.5	1.05 H	135	34.4	10.1
8	7386.00	40.7 AV	54.0	-13.3	1.05 H	135	30.6	10.1

Remarks:

1. Emission Level(dBuV/m) = Raw Value(dBuV) + Correction Factor(dB/m)
2. Correction Factor(dB/m) = Antenna Factor(dB/m) + Cable Factor(dB) – Pre-Amplifier Factor(dB)
3. Margin value = Emission Level – Limit value
4. The other emission levels were very low against the limit.
5. " * " : Fundamental frequency, the limit was restricted at the RF Output Power.

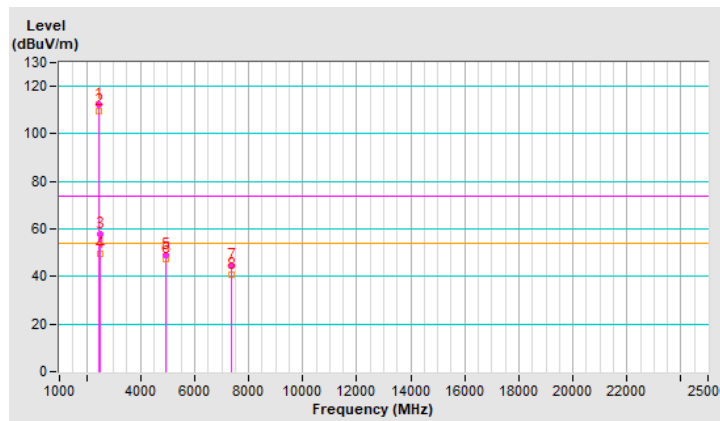

RF Mode	802.11b	Channel	CH 11 : 2462 MHz
Frequency Range	1 GHz ~ 25 GHz	Detector Function & Bandwidth	(PK) RB = 1 MHz, VB = 3 MHz (AV) RB = 1 MHz, VB = 200 Hz
Input Power	120 Vac, 60 Hz	Environmental Conditions	25°C, 69% RH
Tested By	Nelson Teng		

Antenna Polarity & Test Distance : Vertical at 3 m

No	Frequency (MHz)	Emission Level (dBuV/m)	Limit (dBuV/m)	Margin (dB)	Antenna Height (m)	Table Angle (Degree)	Raw Value (dBuV)	Correction Factor (dB/m)
1	*2462.00	108.1 PK			1.06 V	54	108.9	-0.8
2	*2462.00	106.0 AV			1.06 V	54	106.8	-0.8
3	2483.50	57.6 PK	74.0	-16.4	1.06 V	54	58.5	-0.9
4	2483.50	47.9 AV	54.0	-6.1	1.06 V	54	48.8	-0.9
5	4924.00	50.6 PK	74.0	-23.4	1.40 V	164	46.8	3.8
6	4924.00	49.6 AV	54.0	-4.4	1.40 V	164	45.8	3.8
7	7386.00	42.1 PK	74.0	-31.9	1.20 V	168	32.0	10.1
8	7386.00	37.8 AV	54.0	-16.2	1.20 V	168	27.7	10.1

Remarks:

1. Emission Level(dBuV/m) = Raw Value(dBuV) + Correction Factor(dB/m)
2. Correction Factor(dB/m) = Antenna Factor(dB/m) + Cable Factor(dB) – Pre-Amplifier Factor(dB)
3. Margin value = Emission Level – Limit value
4. The other emission levels were very low against the limit.
5. " * " : Fundamental frequency, the limit was restricted at the RF Output Power.

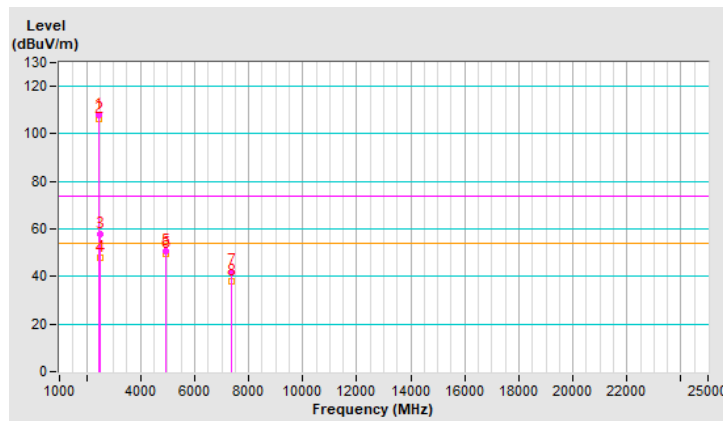

RF Mode	802.11g	Channel	CH 1 : 2412 MHz
Frequency Range	1 GHz ~ 25 GHz	Detector Function & Bandwidth	(PK) RB = 1 MHz, VB = 3 MHz (AV) RB = 1 MHz, VB = 1 kHz
Input Power	120 Vac, 60 Hz	Environmental Conditions	25°C, 69% RH
Tested By	Nelson Teng		

Antenna Polarity & Test Distance : Horizontal at 3 m

No	Frequency (MHz)	Emission Level (dBuV/m)	Limit (dBuV/m)	Margin (dB)	Antenna Height (m)	Table Angle (Degree)	Raw Value (dBuV)	Correction Factor (dB/m)
1	2390.00	61.0 PK	74.0	-13.0	1.00 H	14	61.9	-0.9
2	2390.00	48.2 AV	54.0	-5.8	1.00 H	14	49.1	-0.9
3	*2412.00	109.7 PK			1.00 H	14	110.5	-0.8
4	*2412.00	100.9 AV			1.00 H	14	101.7	-0.8
5	4824.00	48.9 PK	74.0	-25.1	1.02 H	17	45.2	3.7
6	4824.00	34.1 AV	54.0	-19.9	1.02 H	17	30.4	3.7

Remarks:

1. Emission Level(dBuV/m) = Raw Value(dBuV) + Correction Factor(dB/m)
2. Correction Factor(dB/m) = Antenna Factor(dB/m) + Cable Factor(dB) – Pre-Amplifier Factor(dB)
3. Margin value = Emission Level – Limit value
4. The other emission levels were very low against the limit.
5. " * " : Fundamental frequency, the limit was restricted at the RF Output Power.

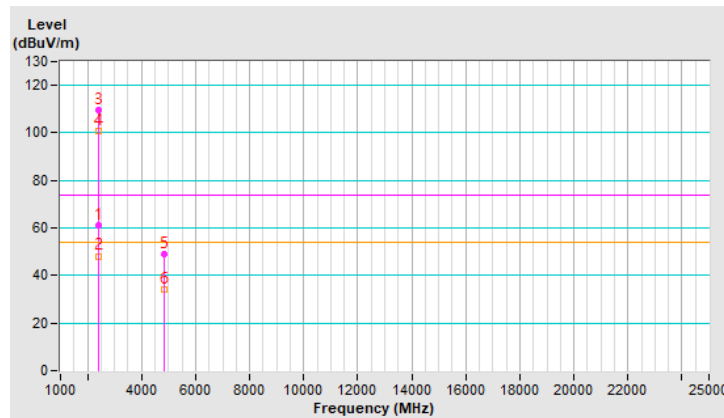

RF Mode	802.11g	Channel	CH 1 : 2412 MHz
Frequency Range	1 GHz ~ 25 GHz	Detector Function & Bandwidth	(PK) RB = 1 MHz, VB = 3 MHz (AV) RB = 1 MHz, VB = 1 kHz
Input Power	120 Vac, 60 Hz	Environmental Conditions	25°C, 69% RH
Tested By	Nelson Teng		

Antenna Polarity & Test Distance : Vertical at 3 m								
No	Frequency (MHz)	Emission Level (dBUV/m)	Limit (dBUV/m)	Margin (dB)	Antenna Height (m)	Table Angle (Degree)	Raw Value (dBUV)	Correction Factor (dB/m)
1	2390.00	58.4 PK	74.0	-15.6	1.01 V	91	59.3	-0.9
2	2390.00	45.8 AV	54.0	-8.2	1.01 V	91	46.7	-0.9
3	*2412.00	106.2 PK			1.01 V	91	107.0	-0.8
4	*2412.00	97.5 AV			1.01 V	91	98.3	-0.8
5	4824.00	43.9 PK	74.0	-30.1	1.14 V	156	40.2	3.7
6	4824.00	31.9 AV	54.0	-22.1	1.14 V	156	28.2	3.7

Remarks:

1. Emission Level(dBUV/m) = Raw Value(dBUV) + Correction Factor(dB/m)
2. Correction Factor(dB/m) = Antenna Factor(dB/m) + Cable Factor(dB) – Pre-Amplifier Factor(dB)
3. Margin value = Emission Level – Limit value
4. The other emission levels were very low against the limit.
5. " * " : Fundamental frequency, the limit was restricted at the RF Output Power.

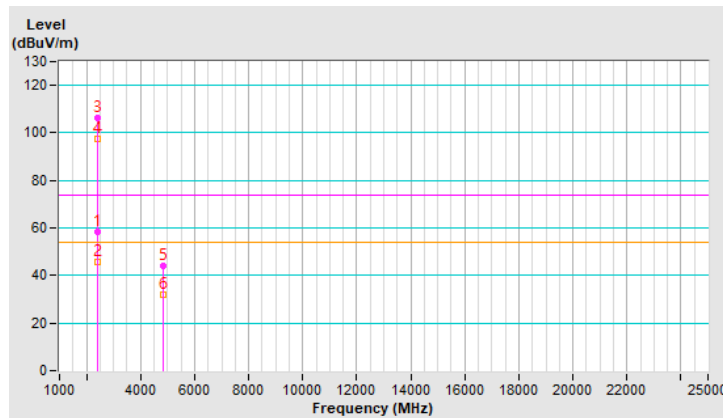

RF Mode	802.11g	Channel	CH 6 : 2437 MHz
Frequency Range	1 GHz ~ 25 GHz	Detector Function & Bandwidth	(PK) RB = 1 MHz, VB = 3 MHz (AV) RB = 1 MHz, VB = 1 kHz
Input Power	120 Vac, 60 Hz	Environmental Conditions	25°C, 69% RH
Tested By	Nelson Teng		

Antenna Polarity & Test Distance : Horizontal at 3 m

No	Frequency (MHz)	Emission Level (dBuV/m)	Limit (dBuV/m)	Margin (dB)	Antenna Height (m)	Table Angle (Degree)	Raw Value (dBuV)	Correction Factor (dB/m)
1	2390.00	60.9 PK	74.0	-13.1	1.03 H	18	61.8	-0.9
2	2390.00	49.4 AV	54.0	-4.6	1.03 H	18	50.3	-0.9
3	*2437.00	112.7 PK			1.03 H	18	113.5	-0.8
4	*2437.00	104.1 AV			1.03 H	18	104.9	-0.8
5	2483.50	57.8 PK	74.0	-16.2	1.03 H	18	58.7	-0.9
6	2483.50	45.8 AV	54.0	-8.2	1.03 H	18	46.7	-0.9
7	4874.00	48.8 PK	74.0	-25.2	1.03 H	18	45.1	3.7
8	4874.00	33.7 AV	54.0	-20.3	1.03 H	18	30.0	3.7
9	7311.00	37.2 PK	74.0	-36.8	1.99 H	186	26.7	10.5
10	7311.00	26.1 AV	54.0	-27.9	1.99 H	186	15.6	10.5

Remarks:

1. Emission Level(dBuV/m) = Raw Value(dBuV) + Correction Factor(dB/m)
2. Correction Factor(dB/m) = Antenna Factor(dB/m) + Cable Factor(dB) – Pre-Amplifier Factor(dB)
3. Margin value = Emission Level – Limit value
4. The other emission levels were very low against the limit.
5. " * " : Fundamental frequency, the limit was restricted at the RF Output Power.

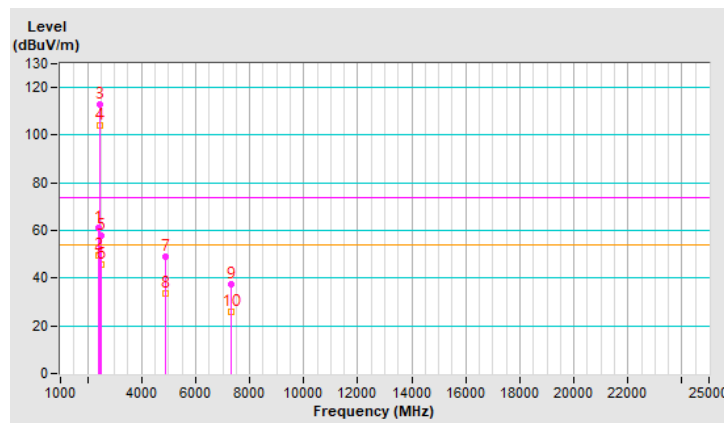

RF Mode	802.11g	Channel	CH 6 : 2437 MHz
Frequency Range	1 GHz ~ 25 GHz	Detector Function & Bandwidth	(PK) RB = 1 MHz, VB = 3 MHz (AV) RB = 1 MHz, VB = 1 kHz
Input Power	120 Vac, 60 Hz	Environmental Conditions	25°C, 69% RH
Tested By	Nelson Teng		

Antenna Polarity & Test Distance : Vertical at 3 m								
No	Frequency (MHz)	Emission Level (dBuV/m)	Limit (dBuV/m)	Margin (dB)	Antenna Height (m)	Table Angle (Degree)	Raw Value (dBuV)	Correction Factor (dB/m)
1	2390.00	57.3 PK	74.0	-16.7	1.12 V	278	58.2	-0.9
2	2390.00	44.8 AV	54.0	-9.2	1.12 V	278	45.7	-0.9
3	*2437.00	106.7 PK			1.12 V	278	107.5	-0.8
4	*2437.00	97.5 AV			1.12 V	278	98.3	-0.8
5	2483.50	55.2 PK	74.0	-18.8	1.12 V	278	56.1	-0.9
6	2483.50	43.8 AV	54.0	-10.2	1.12 V	278	44.7	-0.9
7	4874.00	44.2 PK	74.0	-29.8	1.16 V	161	40.5	3.7
8	4874.00	32.3 AV	54.0	-21.7	1.16 V	161	28.6	3.7
9	7311.00	36.3 PK	74.0	-37.7	1.28 V	152	25.8	10.5
10	7311.00	25.1 AV	54.0	-28.9	1.28 V	152	14.6	10.5

Remarks:

1. Emission Level(dBuV/m) = Raw Value(dBuV) + Correction Factor(dB/m)
2. Correction Factor(dB/m) = Antenna Factor(dB/m) + Cable Factor(dB) – Pre-Amplifier Factor(dB)
3. Margin value = Emission Level – Limit value
4. The other emission levels were very low against the limit.
5. " * ": Fundamental frequency, the limit was restricted at the RF Output Power.

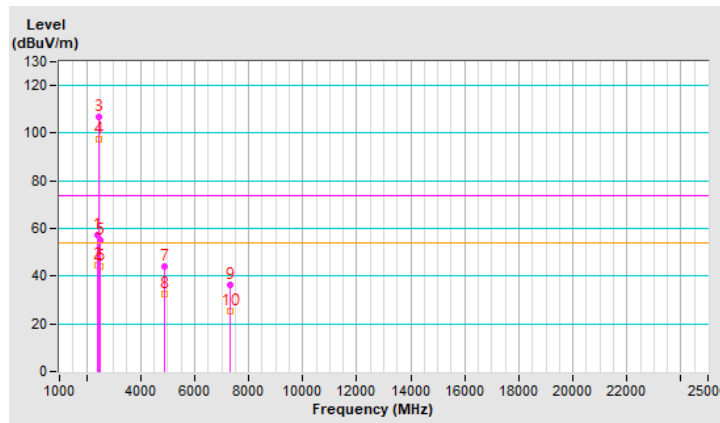

RF Mode	802.11g	Channel	CH 11 : 2462 MHz
Frequency Range	1 GHz ~ 25 GHz	Detector Function & Bandwidth	(PK) RB = 1 MHz, VB = 3 MHz (AV) RB = 1 MHz, VB = 1 kHz
Input Power	120 Vac, 60 Hz	Environmental Conditions	25°C, 69% RH
Tested By	Nelson Teng		

Antenna Polarity & Test Distance : Horizontal at 3 m

No	Frequency (MHz)	Emission Level (dBuV/m)	Limit (dBuV/m)	Margin (dB)	Antenna Height (m)	Table Angle (Degree)	Raw Value (dBuV)	Correction Factor (dB/m)
1	*2462.00	111.8 PK			1.09 H	5	112.6	-0.8
2	*2462.00	102.8 AV			1.09 H	5	103.6	-0.8
3	2483.50	63.5 PK	74.0	-10.5	1.09 H	5	64.4	-0.9
4	2483.50	48.2 AV	54.0	-5.8	1.09 H	5	49.1	-0.9
5	4924.00	48.4 PK	74.0	-25.6	1.00 H	21	44.6	3.8
6	4924.00	33.6 AV	54.0	-20.4	1.00 H	21	29.8	3.8
7	7386.00	37.0 PK	74.0	-37.0	1.96 H	172	26.9	10.1
8	7386.00	26.0 AV	54.0	-28.0	1.96 H	172	15.9	10.1

Remarks:

1. Emission Level(dBuV/m) = Raw Value(dBuV) + Correction Factor(dB/m)
2. Correction Factor(dB/m) = Antenna Factor(dB/m) + Cable Factor(dB) – Pre-Amplifier Factor(dB)
3. Margin value = Emission Level – Limit value
4. The other emission levels were very low against the limit.
5. " * " : Fundamental frequency, the limit was restricted at the RF Output Power.

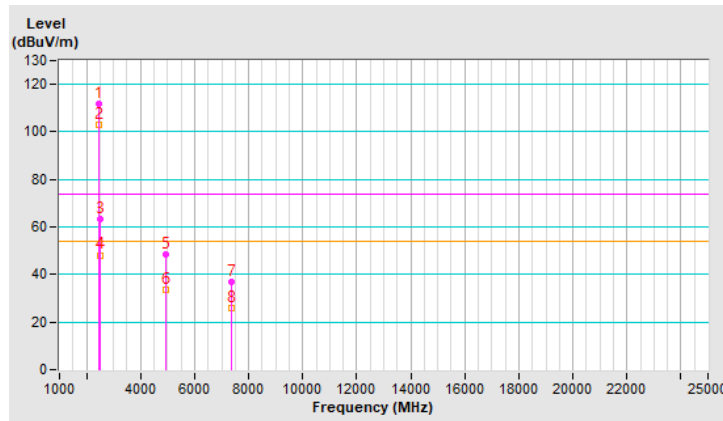

RF Mode	802.11g	Channel	CH 11 : 2462 MHz
Frequency Range	1 GHz ~ 25 GHz	Detector Function & Bandwidth	(PK) RB = 1 MHz, VB = 3 MHz (AV) RB = 1 MHz, VB = 1 kHz
Input Power	120 Vac, 60 Hz	Environmental Conditions	25°C, 69% RH
Tested By	Nelson Teng		

Antenna Polarity & Test Distance : Vertical at 3 m

No	Frequency (MHz)	Emission Level (dBuV/m)	Limit (dBuV/m)	Margin (dB)	Antenna Height (m)	Table Angle (Degree)	Raw Value (dBuV)	Correction Factor (dB/m)
1	*2462.00	107.8 PK			1.26 V	313	108.6	-0.8
2	*2462.00	98.3 AV			1.26 V	313	99.1	-0.8
3	2483.50	61.1 PK	74.0	-12.9	1.26 V	313	62.0	-0.9
4	2483.50	46.6 AV	54.0	-7.4	1.26 V	313	47.5	-0.9
5	4924.00	44.8 PK	74.0	-29.2	1.18 V	155	41.0	3.8
6	4924.00	32.7 AV	54.0	-21.3	1.18 V	155	28.9	3.8
7	7386.00	36.0 PK	74.0	-38.0	1.26 V	156	25.9	10.1
8	7386.00	25.0 AV	54.0	-29.0	1.26 V	156	14.9	10.1

Remarks:

1. Emission Level(dBuV/m) = Raw Value(dBuV) + Correction Factor(dB/m)
2. Correction Factor(dB/m) = Antenna Factor(dB/m) + Cable Factor(dB) – Pre-Amplifier Factor(dB)
3. Margin value = Emission Level – Limit value
4. The other emission levels were very low against the limit.
5. " * ": Fundamental frequency, the limit was restricted at the RF Output Power.

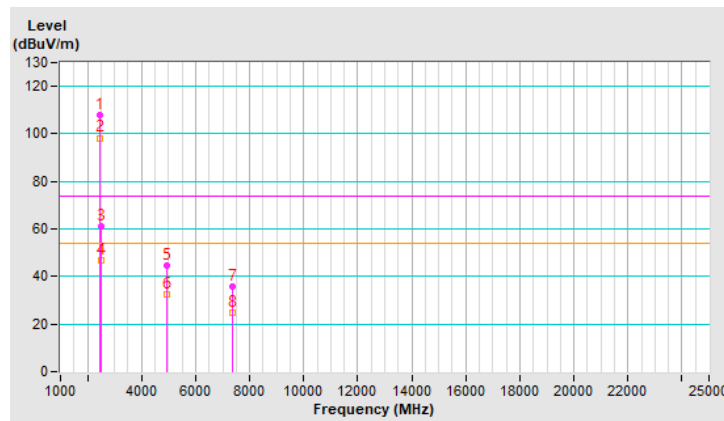

RF Mode	802.11ax (HE20)	Channel	CH 1 : 2412 MHz
Frequency Range	1 GHz ~ 25 GHz	Detector Function & Bandwidth	(PK) RB = 1 MHz, VB = 3 MHz (AV) RB = 1 MHz, VB = 1 kHz
Input Power	120 Vac, 60 Hz	Environmental Conditions	25°C, 69% RH
Tested By	Nelson Teng		

Antenna Polarity & Test Distance : Horizontal at 3 m

No	Frequency (MHz)	Emission Level (dBuV/m)	Limit (dBuV/m)	Margin (dB)	Antenna Height (m)	Table Angle (Degree)	Raw Value (dBuV)	Correction Factor (dB/m)
1	2390.00	65.2 PK	74.0	-8.8	1.02 H	360	66.1	-0.9
2	2390.00	48.9 AV	54.0	-5.1	1.02 H	360	49.8	-0.9
3	*2412.00	112.1 PK			1.02 H	360	112.9	-0.8
4	*2412.00	101.2 AV			1.02 H	360	102.0	-0.8
5	4824.00	40.0 PK	74.0	-34.0	2.38 H	191	36.3	3.7
6	4824.00	28.3 AV	54.0	-25.7	2.38 H	191	24.6	3.7

Remarks:

1. Emission Level(dBuV/m) = Raw Value(dBuV) + Correction Factor(dB/m)
2. Correction Factor(dB/m) = Antenna Factor(dB/m) + Cable Factor(dB) – Pre-Amplifier Factor(dB)
3. Margin value = Emission Level – Limit value
4. The other emission levels were very low against the limit.
5. " * " : Fundamental frequency, the limit was restricted at the RF Output Power.

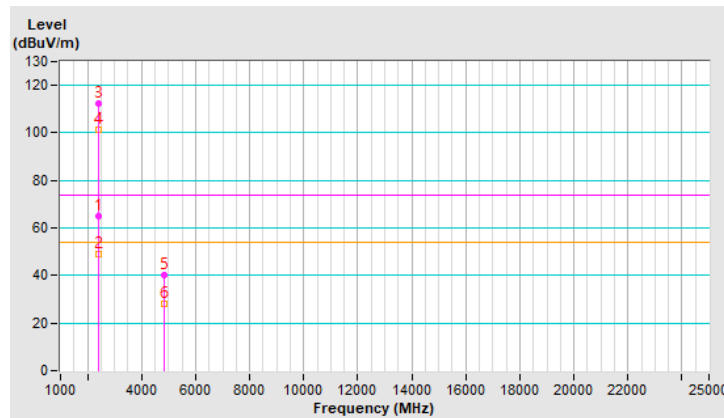

RF Mode	802.11ax (HE20)	Channel	CH 1 : 2412 MHz
Frequency Range	1 GHz ~ 25 GHz	Detector Function & Bandwidth	(PK) RB = 1 MHz, VB = 3 MHz (AV) RB = 1 MHz, VB = 1 kHz
Input Power	120 Vac, 60 Hz	Environmental Conditions	25°C, 69% RH
Tested By	Nelson Teng		

Antenna Polarity & Test Distance : Vertical at 3 m								
No	Frequency (MHz)	Emission Level (dBuV/m)	Limit (dBuV/m)	Margin (dB)	Antenna Height (m)	Table Angle (Degree)	Raw Value (dBuV)	Correction Factor (dB/m)
1	2390.00	58.9 PK	74.0	-15.1	1.43 V	133	59.8	-0.9
2	2390.00	45.5 AV	54.0	-8.5	1.43 V	133	46.4	-0.9
3	*2412.00	105.2 PK			1.43 V	133	106.0	-0.8
4	*2412.00	94.2 AV			1.43 V	133	95.0	-0.8
5	4824.00	44.1 PK	74.0	-29.9	1.22 V	151	40.4	3.7
6	4824.00	32.4 AV	54.0	-21.6	1.22 V	151	28.7	3.7

Remarks:

1. Emission Level(dBuV/m) = Raw Value(dBuV) + Correction Factor(dB/m)
2. Correction Factor(dB/m) = Antenna Factor(dB/m) + Cable Factor(dB) – Pre-Amplifier Factor(dB)
3. Margin value = Emission Level – Limit value
4. The other emission levels were very low against the limit.
5. " * " : Fundamental frequency, the limit was restricted at the RF Output Power.

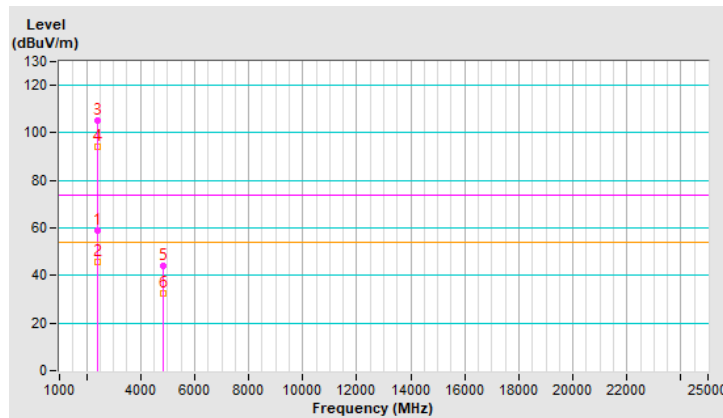

RF Mode	802.11ax (HE20)	Channel	CH 6 : 2437 MHz
Frequency Range	1 GHz ~ 25 GHz	Detector Function & Bandwidth	(PK) RB = 1 MHz, VB = 3 MHz (AV) RB = 1 MHz, VB = 1 kHz
Input Power	120 Vac, 60 Hz	Environmental Conditions	25°C, 69% RH
Tested By	Nelson Teng		

Antenna Polarity & Test Distance : Horizontal at 3 m								
No	Frequency (MHz)	Emission Level (dBUV/m)	Limit (dBUV/m)	Margin (dB)	Antenna Height (m)	Table Angle (Degree)	Raw Value (dBUV)	Correction Factor (dB/m)
1	2390.00	62.6 PK	74.0	-11.4	1.04 H	360	63.5	-0.9
2	2390.00	49.2 AV	54.0	-4.8	1.04 H	360	50.1	-0.9
3	*2437.00	114.7 PK			1.04 H	360	115.5	-0.8
4	*2437.00	103.9 AV			1.04 H	360	104.7	-0.8
5	2483.50	58.4 PK	74.0	-15.6	1.04 H	360	59.3	-0.9
6	2483.50	45.6 AV	54.0	-8.4	1.04 H	360	46.5	-0.9
7	4874.00	40.2 PK	74.0	-33.8	2.36 H	176	36.5	3.7
8	4874.00	28.4 AV	54.0	-25.6	2.36 H	176	24.7	3.7
9	7311.00	40.6 PK	74.0	-33.4	1.21 H	136	30.1	10.5
10	7311.00	26.7 AV	54.0	-27.3	1.21 H	136	16.2	10.5

Remarks:

1. Emission Level(dBUV/m) = Raw Value(dBUV) + Correction Factor(dB/m)
2. Correction Factor(dB/m) = Antenna Factor(dB/m) + Cable Factor(dB) – Pre-Amplifier Factor(dB)
3. Margin value = Emission Level – Limit value
4. The other emission levels were very low against the limit.
5. " * " : Fundamental frequency, the limit was restricted at the RF Output Power.

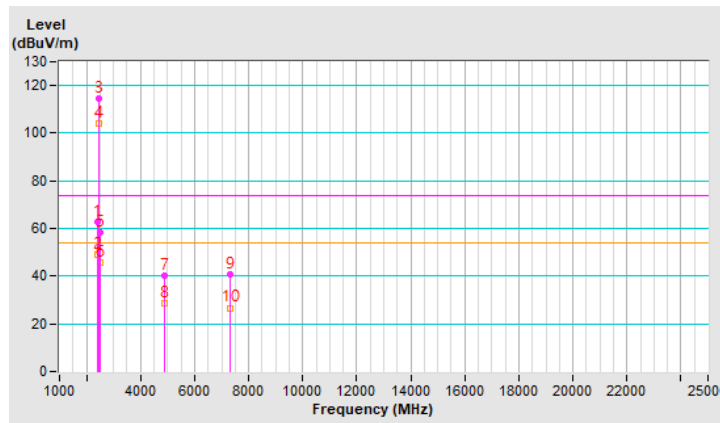

RF Mode	802.11ax (HE20)	Channel	CH 6 : 2437 MHz
Frequency Range	1 GHz ~ 25 GHz	Detector Function & Bandwidth	(PK) RB = 1 MHz, VB = 3 MHz (AV) RB = 1 MHz, VB = 1 kHz
Input Power	120 Vac, 60 Hz	Environmental Conditions	25°C, 69% RH
Tested By	Nelson Teng		

Antenna Polarity & Test Distance : Vertical at 3 m								
No	Frequency (MHz)	Emission Level (dBuV/m)	Limit (dBuV/m)	Margin (dB)	Antenna Height (m)	Table Angle (Degree)	Raw Value (dBuV)	Correction Factor (dB/m)
1	2390.00	57.5 PK	74.0	-16.5	1.05 V	52	58.4	-0.9
2	2390.00	45.4 AV	54.0	-8.6	1.05 V	52	46.3	-0.9
3	*2437.00	109.2 PK			1.05 V	52	110.0	-0.8
4	*2437.00	98.7 AV			1.05 V	52	99.5	-0.8
5	2483.50	56.3 PK	74.0	-17.7	1.05 V	52	57.2	-0.9
6	2483.50	44.6 AV	54.0	-9.4	1.05 V	52	45.5	-0.9
7	4874.00	44.3 PK	74.0	-29.7	1.19 V	167	40.6	3.7
8	4874.00	32.8 AV	54.0	-21.2	1.19 V	167	29.1	3.7
9	7311.00	43.1 PK	74.0	-30.9	1.09 V	185	32.6	10.5
10	7311.00	28.8 AV	54.0	-25.2	1.09 V	185	18.3	10.5

Remarks:

1. Emission Level(dBuV/m) = Raw Value(dBuV) + Correction Factor(dB/m)
2. Correction Factor(dB/m) = Antenna Factor(dB/m) + Cable Factor(dB) – Pre-Amplifier Factor(dB)
3. Margin value = Emission Level – Limit value
4. The other emission levels were very low against the limit.
5. " * " : Fundamental frequency, the limit was restricted at the RF Output Power.

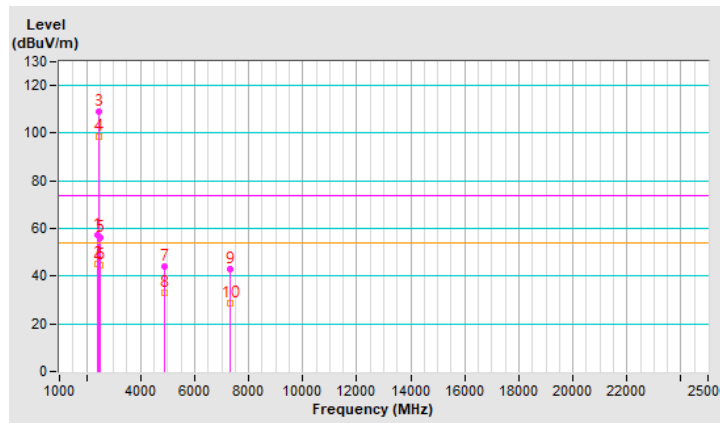

RF Mode	802.11ax (HE20)	Channel	CH 11 : 2462 MHz
Frequency Range	1 GHz ~ 25 GHz	Detector Function & Bandwidth	(PK) RB = 1 MHz, VB = 3 MHz (AV) RB = 1 MHz, VB = 1 kHz
Input Power	120 Vac, 60 Hz	Environmental Conditions	25°C, 69% RH
Tested By	Nelson Teng		

Antenna Polarity & Test Distance : Horizontal at 3 m

No	Frequency (MHz)	Emission Level (dBuV/m)	Limit (dBuV/m)	Margin (dB)	Antenna Height (m)	Table Angle (Degree)	Raw Value (dBuV)	Correction Factor (dB/m)
1	*2462.00	111.1 PK			1.02 H	334	111.9	-0.8
2	*2462.00	100.1 AV			1.02 H	334	100.9	-0.8
3	2483.50	65.6 PK	74.0	-8.4	1.02 H	334	66.5	-0.9
4	2483.50	49.1 AV	54.0	-4.9	1.02 H	334	50.0	-0.9
5	4924.00	40.4 PK	74.0	-33.6	2.36 H	186	36.6	3.8
6	4924.00	28.8 AV	54.0	-25.2	2.36 H	186	25.0	3.8
7	7386.00	40.8 PK	74.0	-33.2	1.16 H	128	30.7	10.1
8	7386.00	27.0 AV	54.0	-27.0	1.16 H	128	16.9	10.1

Remarks:

1. Emission Level(dBuV/m) = Raw Value(dBuV) + Correction Factor(dB/m)
2. Correction Factor(dB/m) = Antenna Factor(dB/m) + Cable Factor(dB) – Pre-Amplifier Factor(dB)
3. Margin value = Emission Level – Limit value
4. The other emission levels were very low against the limit.
5. " * ": Fundamental frequency, the limit was restricted at the RF Output Power.

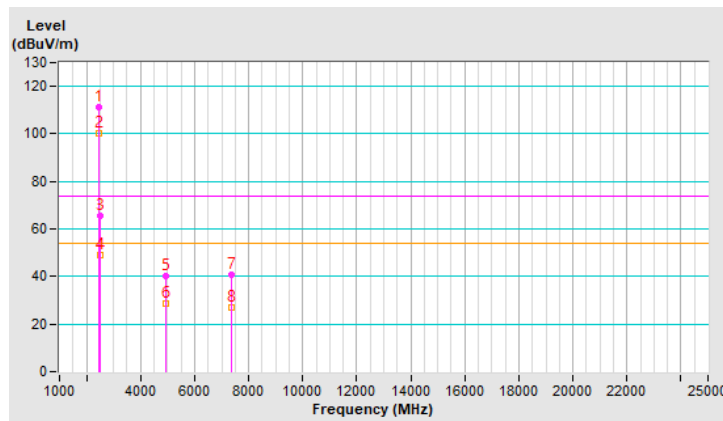

RF Mode	802.11ax (HE20)	Channel	CH 11 : 2462 MHz
Frequency Range	1 GHz ~ 25 GHz	Detector Function & Bandwidth	(PK) RB = 1 MHz, VB = 3 MHz (AV) RB = 1 MHz, VB = 1 kHz
Input Power	120 Vac, 60 Hz	Environmental Conditions	25°C, 69% RH
Tested By	Nelson Teng		

Antenna Polarity & Test Distance : Vertical at 3 m								
No	Frequency (MHz)	Emission Level (dBuV/m)	Limit (dBuV/m)	Margin (dB)	Antenna Height (m)	Table Angle (Degree)	Raw Value (dBuV)	Correction Factor (dB/m)
1	*2462.00	107.3 PK			1.29 V	312	108.1	-0.8
2	*2462.00	96.0 AV			1.29 V	312	96.8	-0.8
3	2483.50	57.8 PK	74.0	-16.2	1.29 V	312	58.7	-0.9
4	2483.50	47.1 AV	54.0	-6.9	1.29 V	312	48.0	-0.9
5	4924.00	44.6 PK	74.0	-29.4	1.23 V	155	40.8	3.8
6	4924.00	33.2 AV	54.0	-20.8	1.23 V	155	29.4	3.8
7	7386.00	43.0 PK	74.0	-31.0	1.13 V	189	32.9	10.1
8	7386.00	28.6 AV	54.0	-25.4	1.13 V	189	18.5	10.1

Remarks:

1. Emission Level(dBuV/m) = Raw Value(dBuV) + Correction Factor(dB/m)
2. Correction Factor(dB/m) = Antenna Factor(dB/m) + Cable Factor(dB) – Pre-Amplifier Factor(dB)
3. Margin value = Emission Level – Limit value
4. The other emission levels were very low against the limit.
5. " * ": Fundamental frequency, the limit was restricted at the RF Output Power.

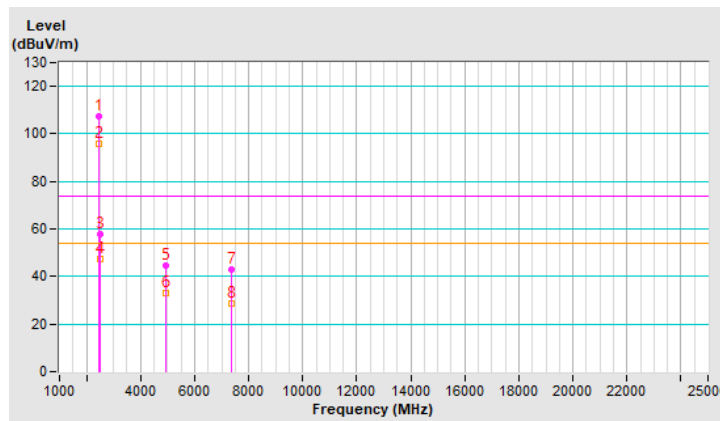

RF Mode	802.11ax (HE40)	Channel	CH 3 : 2422 MHz
Frequency Range	1 GHz ~ 25 GHz	Detector Function & Bandwidth	(PK) RB = 1 MHz, VB = 3 MHz (AV) RB = 1 MHz, VB = 2 kHz
Input Power	120 Vac, 60 Hz	Environmental Conditions	25°C, 69% RH
Tested By	Nelson Teng		

Antenna Polarity & Test Distance : Horizontal at 3 m

No	Frequency (MHz)	Emission Level (dBuV/m)	Limit (dBuV/m)	Margin (dB)	Antenna Height (m)	Table Angle (Degree)	Raw Value (dBuV)	Correction Factor (dB/m)
1	2390.00	61.7 PK	74.0	-12.3	1.04 H	12	62.6	-0.9
2	2390.00	49.7 AV	54.0	-4.3	1.04 H	12	50.6	-0.9
3	*2422.00	107.2 PK			1.04 H	12	108.0	-0.8
4	*2422.00	97.2 AV			1.04 H	12	98.0	-0.8
5	4844.00	39.3 PK	74.0	-34.7	2.35 H	162	35.6	3.7
6	4844.00	27.5 AV	54.0	-26.5	2.35 H	162	23.8	3.7
7	7266.00	41.1 PK	74.0	-32.9	1.21 H	146	30.7	10.4
8	7266.00	27.0 AV	54.0	-27.0	1.21 H	146	16.6	10.4

Remarks:

1. Emission Level(dBuV/m) = Raw Value(dBuV) + Correction Factor(dB/m)
2. Correction Factor(dB/m) = Antenna Factor(dB/m) + Cable Factor(dB) – Pre-Amplifier Factor(dB)
3. Margin value = Emission Level – Limit value
4. The other emission levels were very low against the limit.
5. " * " : Fundamental frequency, the limit was restricted at the RF Output Power.

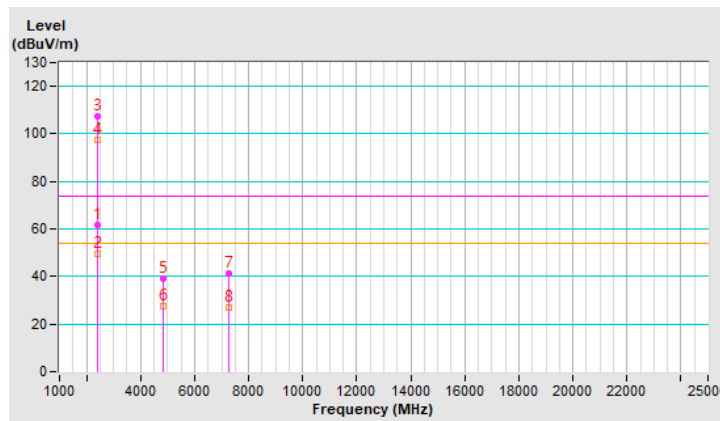

RF Mode	802.11ax (HE40)	Channel	CH 3 : 2422 MHz
Frequency Range	1 GHz ~ 25 GHz	Detector Function & Bandwidth	(PK) RB = 1 MHz, VB = 3 MHz (AV) RB = 1 MHz, VB = 2 kHz
Input Power	120 Vac, 60 Hz	Environmental Conditions	25°C, 69% RH
Tested By	Nelson Teng		

Antenna Polarity & Test Distance : Vertical at 3 m								
No	Frequency (MHz)	Emission Level (dBUV/m)	Limit (dBUV/m)	Margin (dB)	Antenna Height (m)	Table Angle (Degree)	Raw Value (dBUV)	Correction Factor (dB/m)
1	2390.00	58.9 PK	74.0	-15.1	1.00 V	61	59.8	-0.9
2	2390.00	47.9 AV	54.0	-6.1	1.00 V	61	48.8	-0.9
3	*2422.00	102.8 PK			1.00 V	61	103.6	-0.8
4	*2422.00	92.7 AV			1.00 V	61	93.5	-0.8
5	4844.00	43.8 PK	74.0	-30.2	1.20 V	138	40.1	3.7
6	4844.00	32.8 AV	54.0	-21.2	1.20 V	138	29.1	3.7
7	7266.00	43.0 PK	74.0	-31.0	1.00 V	167	32.6	10.4
8	7266.00	28.1 AV	54.0	-25.9	1.00 V	167	17.7	10.4

Remarks:

1. Emission Level(dBUV/m) = Raw Value(dBUV) + Correction Factor(dB/m)
2. Correction Factor(dB/m) = Antenna Factor(dB/m) + Cable Factor(dB) – Pre-Amplifier Factor(dB)
3. Margin value = Emission Level – Limit value
4. The other emission levels were very low against the limit.
5. " * ": Fundamental frequency, the limit was restricted at the RF Output Power.

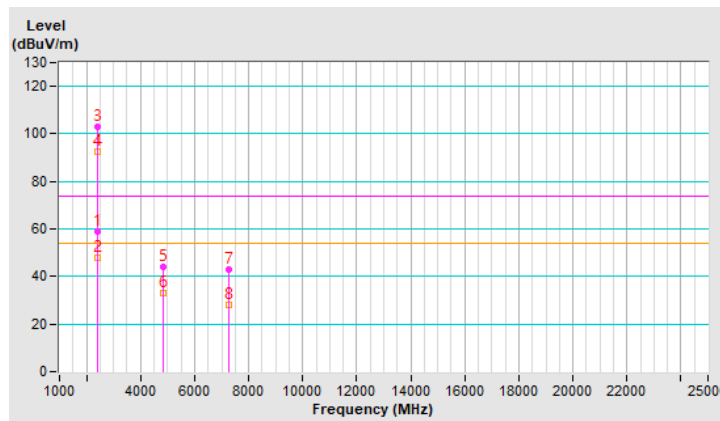

RF Mode	802.11ax (HE40)	Channel	CH 6 : 2437 MHz
Frequency Range	1 GHz ~ 25 GHz	Detector Function & Bandwidth	(PK) RB = 1 MHz, VB = 3 MHz (AV) RB = 1 MHz, VB = 2 kHz
Input Power	120 Vac, 60 Hz	Environmental Conditions	25°C, 69% RH
Tested By	Nelson Teng		

Antenna Polarity & Test Distance : Horizontal at 3 m

No	Frequency (MHz)	Emission Level (dBuV/m)	Limit (dBuV/m)	Margin (dB)	Antenna Height (m)	Table Angle (Degree)	Raw Value (dBuV)	Correction Factor (dB/m)
1	2390.00	59.4 PK	74.0	-14.6	1.25 H	18	60.3	-0.9
2	2390.00	48.8 AV	54.0	-5.2	1.25 H	18	49.7	-0.9
3	*2437.00	110.0 PK			1.25 H	18	110.8	-0.8
4	*2437.00	98.2 AV			1.25 H	18	99.0	-0.8
5	2483.50	61.1 PK	74.0	-12.9	1.25 H	18	62.0	-0.9
6	2483.50	47.5 AV	54.0	-6.5	1.25 H	18	48.4	-0.9
7	4874.00	39.9 PK	74.0	-34.1	2.34 H	163	36.2	3.7
8	4874.00	28.0 AV	54.0	-26.0	2.34 H	163	24.3	3.7
9	7311.00	40.4 PK	74.0	-33.6	1.16 H	137	29.9	10.5
10	7311.00	26.5 AV	54.0	-27.5	1.16 H	137	16.0	10.5

Remarks:

1. Emission Level(dBuV/m) = Raw Value(dBuV) + Correction Factor(dB/m)
2. Correction Factor(dB/m) = Antenna Factor(dB/m) + Cable Factor(dB) – Pre-Amplifier Factor(dB)
3. Margin value = Emission Level – Limit value
4. The other emission levels were very low against the limit.
5. " * ": Fundamental frequency, the limit was restricted at the RF Output Power.

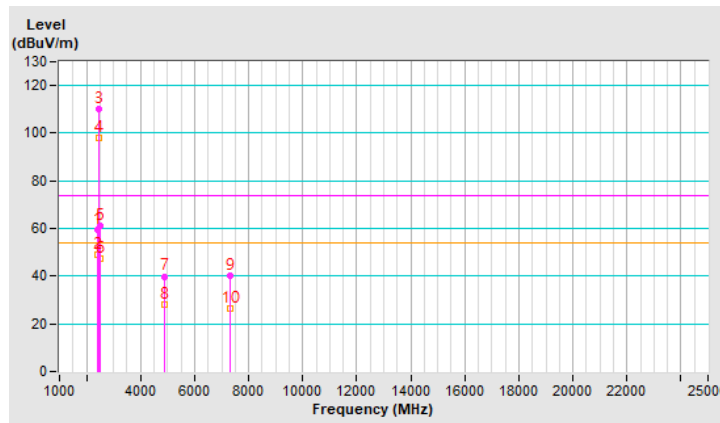

RF Mode	802.11ax (HE40)	Channel	CH 6 : 2437 MHz
Frequency Range	1 GHz ~ 25 GHz	Detector Function & Bandwidth	(PK) RB = 1 MHz, VB = 3 MHz (AV) RB = 1 MHz, VB = 2 kHz
Input Power	120 Vac, 60 Hz	Environmental Conditions	25°C, 69% RH
Tested By	Nelson Teng		

Antenna Polarity & Test Distance : Vertical at 3 m								
No	Frequency (MHz)	Emission Level (dBUV/m)	Limit (dBUV/m)	Margin (dB)	Antenna Height (m)	Table Angle (Degree)	Raw Value (dBUV)	Correction Factor (dB/m)
1	2390.00	56.3 PK	74.0	-17.7	1.45 V	271	57.2	-0.9
2	2390.00	45.6 AV	54.0	-8.4	1.45 V	271	46.5	-0.9
3	*2437.00	103.0 PK			1.45 V	271	103.8	-0.8
4	*2437.00	92.1 AV			1.45 V	271	92.9	-0.8
5	2483.50	56.1 PK	74.0	-17.9	1.45 V	271	57.0	-0.9
6	2483.50	44.8 AV	54.0	-9.2	1.45 V	271	45.7	-0.9
7	4874.00	43.6 PK	74.0	-30.4	1.15 V	149	39.9	3.7
8	4874.00	32.6 AV	54.0	-21.4	1.15 V	149	28.9	3.7
9	7311.00	42.8 PK	74.0	-31.2	1.03 V	161	32.3	10.5
10	7311.00	28.2 AV	54.0	-25.8	1.03 V	161	17.7	10.5

Remarks:

1. Emission Level(dBUV/m) = Raw Value(dBUV) + Correction Factor(dB/m)
2. Correction Factor(dB/m) = Antenna Factor(dB/m) + Cable Factor(dB) – Pre-Amplifier Factor(dB)
3. Margin value = Emission Level – Limit value
4. The other emission levels were very low against the limit.
5. " * ": Fundamental frequency, the limit was restricted at the RF Output Power.

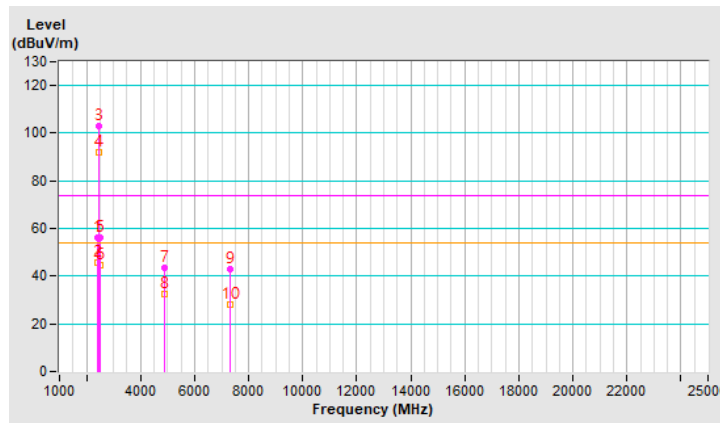

RF Mode	802.11ax (HE40)	Channel	CH 9 : 2452 MHz
Frequency Range	1 GHz ~ 25 GHz	Detector Function & Bandwidth	(PK) RB = 1 MHz, VB = 3 MHz (AV) RB = 1 MHz, VB = 2 kHz
Input Power	120 Vac, 60 Hz	Environmental Conditions	25°C, 69% RH
Tested By	Nelson Teng		

Antenna Polarity & Test Distance : Horizontal at 3 m

No	Frequency (MHz)	Emission Level (dBuV/m)	Limit (dBuV/m)	Margin (dB)	Antenna Height (m)	Table Angle (Degree)	Raw Value (dBuV)	Correction Factor (dB/m)
1	*2452.00	107.6 PK			1.37 H	29	108.4	-0.8
2	*2452.00	95.3 AV			1.37 H	29	96.1	-0.8
3	2483.50	61.7 PK	74.0	-12.3	1.37 H	29	62.6	-0.9
4	2483.50	49.2 AV	54.0	-4.8	1.37 H	29	50.1	-0.9
5	4904.00	39.8 PK	74.0	-34.2	2.30 H	177	36.1	3.7
6	4904.00	27.7 AV	54.0	-26.3	2.30 H	177	24.0	3.7
7	7356.00	40.3 PK	74.0	-33.7	1.12 H	142	30.1	10.2
8	7356.00	26.1 AV	54.0	-27.9	1.12 H	142	15.9	10.2

Remarks:

1. Emission Level(dBuV/m) = Raw Value(dBuV) + Correction Factor(dB/m)
2. Correction Factor(dB/m) = Antenna Factor(dB/m) + Cable Factor(dB) – Pre-Amplifier Factor(dB)
3. Margin value = Emission Level – Limit value
4. The other emission levels were very low against the limit.
5. " * " : Fundamental frequency, the limit was restricted at the RF Output Power.

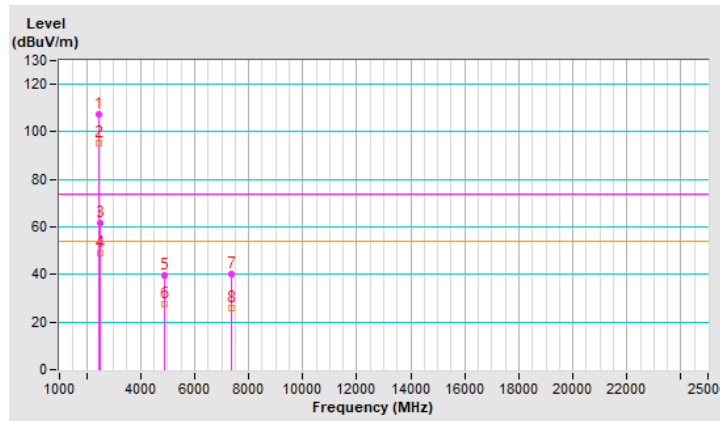

RF Mode	802.11ax (HE40)	Channel	CH 9 : 2452 MHz
Frequency Range	1 GHz ~ 25 GHz	Detector Function & Bandwidth	(PK) RB = 1 MHz, VB = 3 MHz (AV) RB = 1 MHz, VB = 2 kHz
Input Power	120 Vac, 60 Hz	Environmental Conditions	25°C, 69% RH
Tested By	Nelson Teng		

Antenna Polarity & Test Distance : Vertical at 3 m								
No	Frequency (MHz)	Emission Level (dBuV/m)	Limit (dBuV/m)	Margin (dB)	Antenna Height (m)	Table Angle (Degree)	Raw Value (dBuV)	Correction Factor (dB/m)
1	*2452.00	102.3 PK			1.59 V	273	103.1	-0.8
2	*2452.00	92.2 AV			1.59 V	273	93.0	-0.8
3	2483.50	59.5 PK	74.0	-14.5	1.59 V	273	60.4	-0.9
4	2483.50	47.4 AV	54.0	-6.6	1.59 V	273	48.3	-0.9
5	4904.00	43.4 PK	74.0	-30.6	1.21 V	154	39.7	3.7
6	4904.00	32.6 AV	54.0	-21.4	1.21 V	154	28.9	3.7
7	7356.00	42.8 PK	74.0	-31.2	1.00 V	154	32.6	10.2
8	7356.00	28.2 AV	54.0	-25.8	1.00 V	154	18.0	10.2

Remarks:

1. Emission Level(dBuV/m) = Raw Value(dBuV) + Correction Factor(dB/m)
2. Correction Factor(dB/m) = Antenna Factor(dB/m) + Cable Factor(dB) – Pre-Amplifier Factor(dB)
3. Margin value = Emission Level – Limit value
4. The other emission levels were very low against the limit.
5. " * ": Fundamental frequency, the limit was restricted at the RF Output Power.

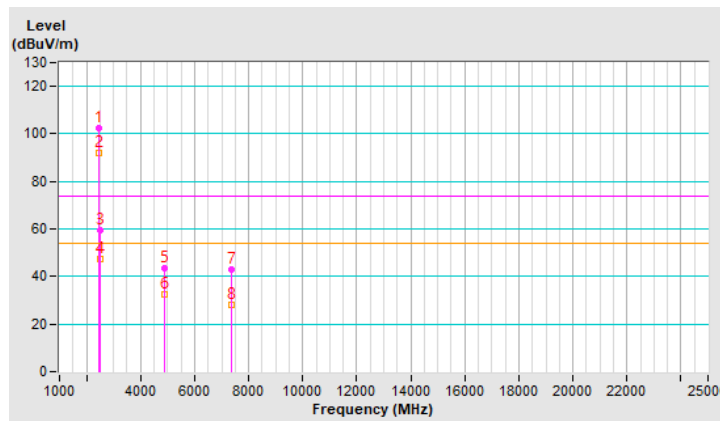



Plot of Band Edge

802.11b Channel 1

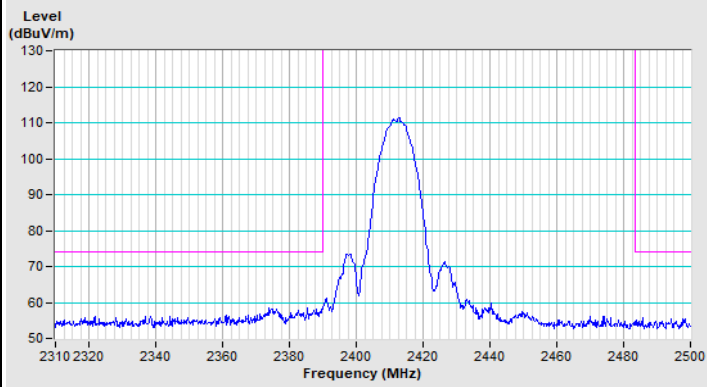

Horizontal (Peak)

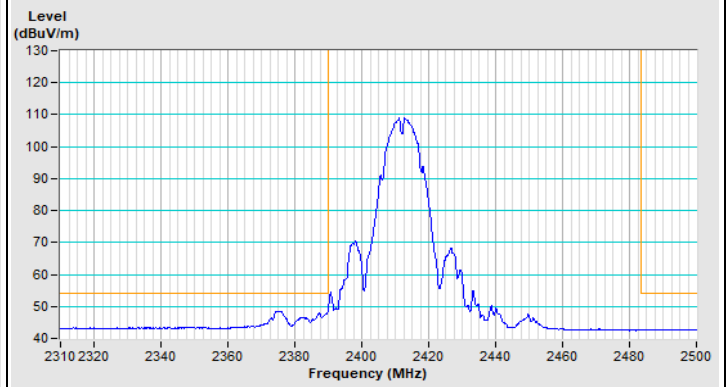

Horizontal (Average)

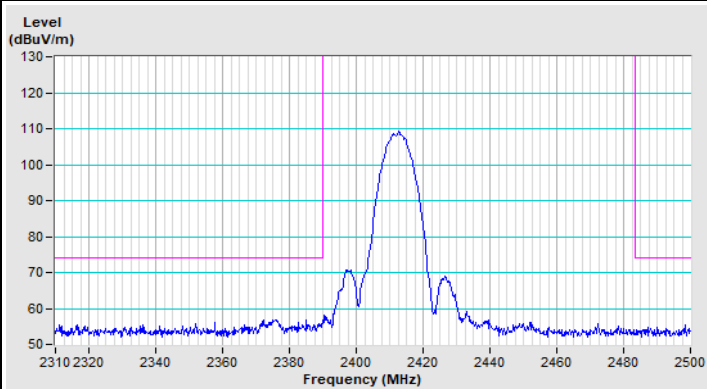

Vertical (Peak)

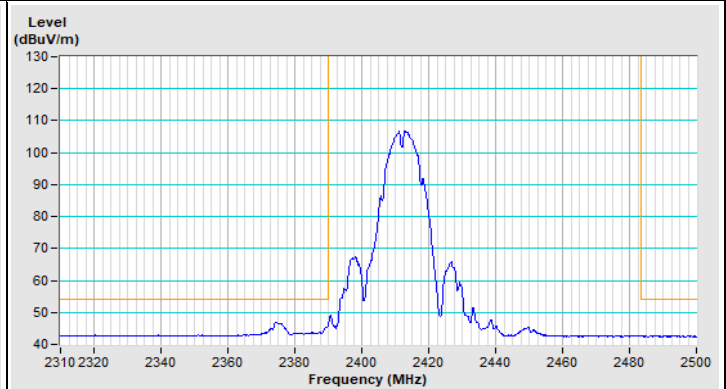

Vertical (Average)

802.11b Channel 11

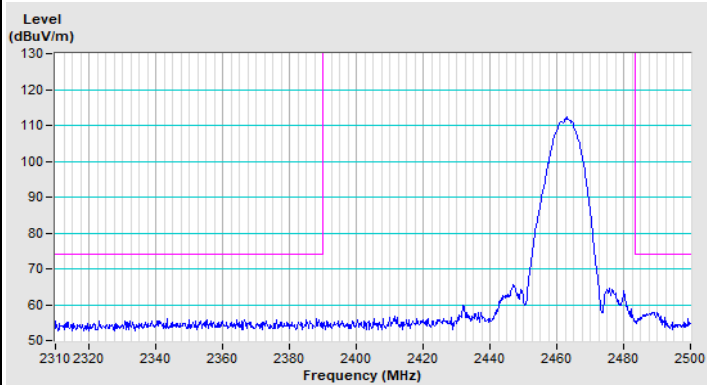

Horizontal (Peak)

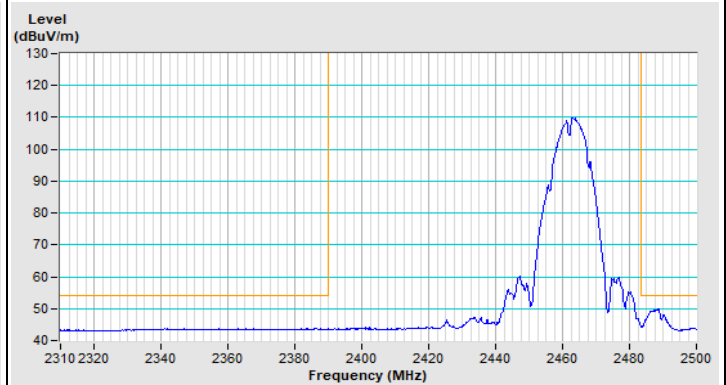

Horizontal (Average)

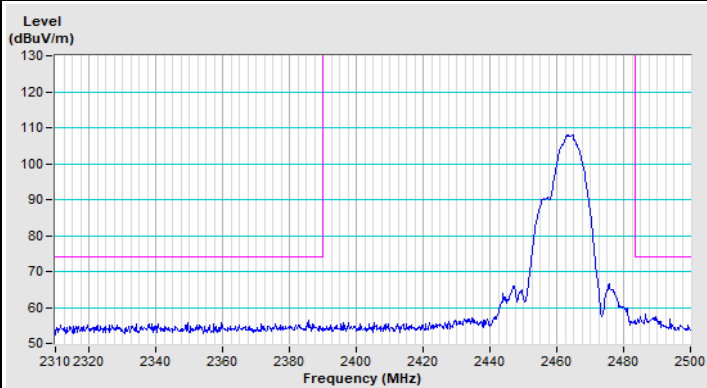

Vertical (Peak)

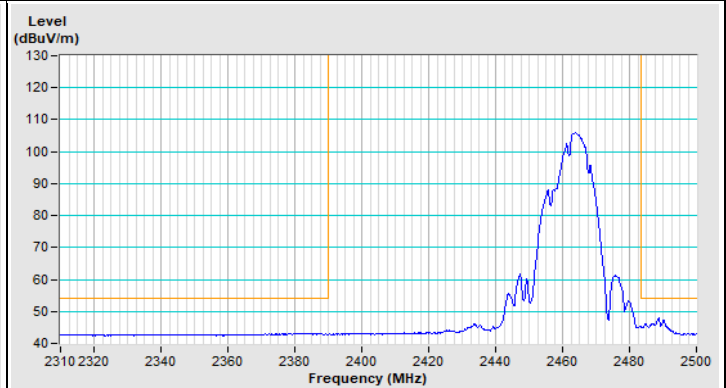

Vertical (Average)

802.11g Channel 1

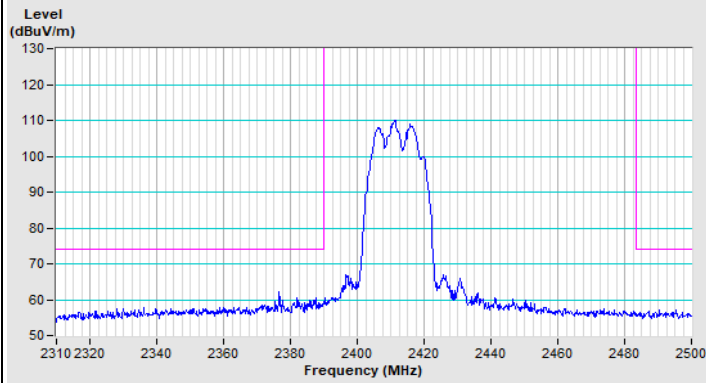

Horizontal (Peak)

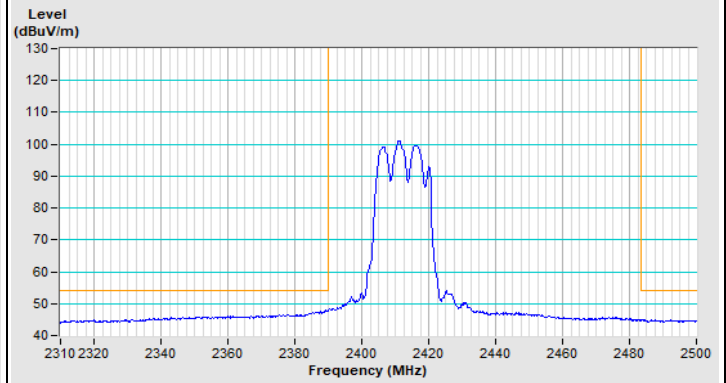

Horizontal (Average)

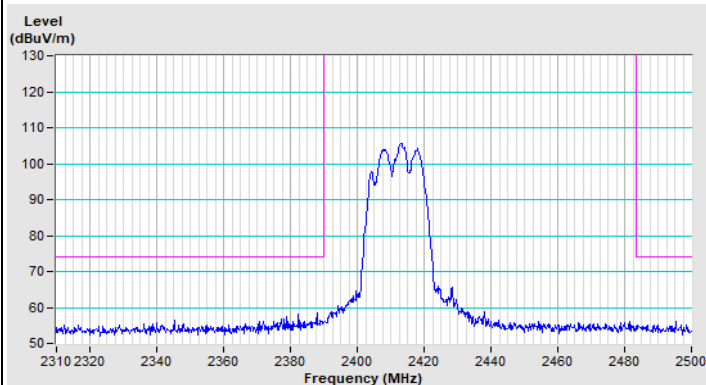

Vertical (Peak)

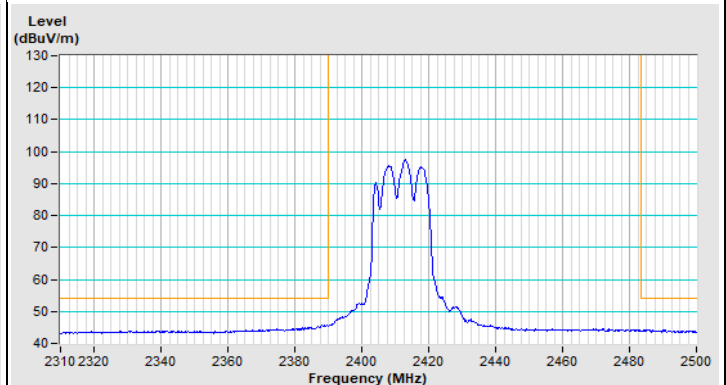

Vertical (Average)

802.11g Channel 11

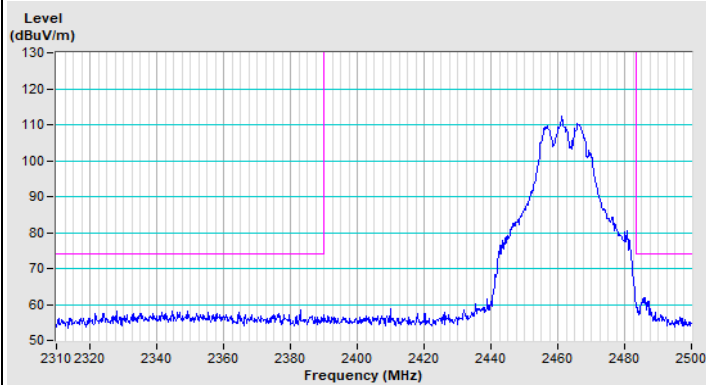

Horizontal (Peak)

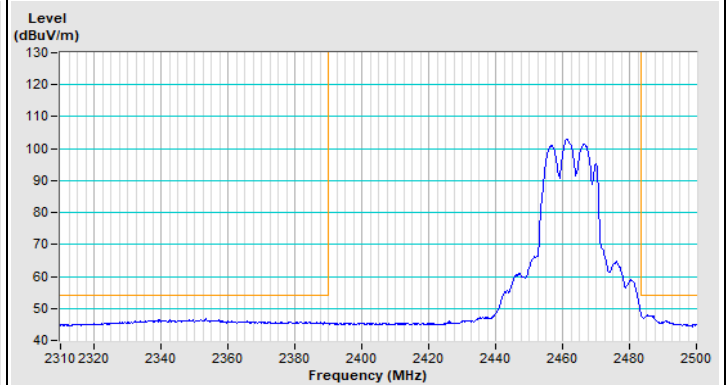

Horizontal (Average)

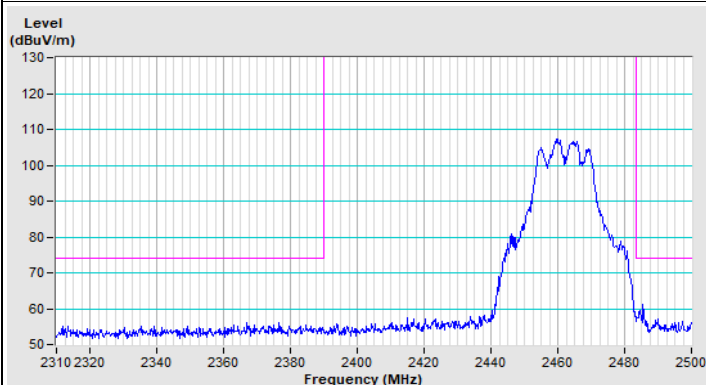

Vertical (Peak)

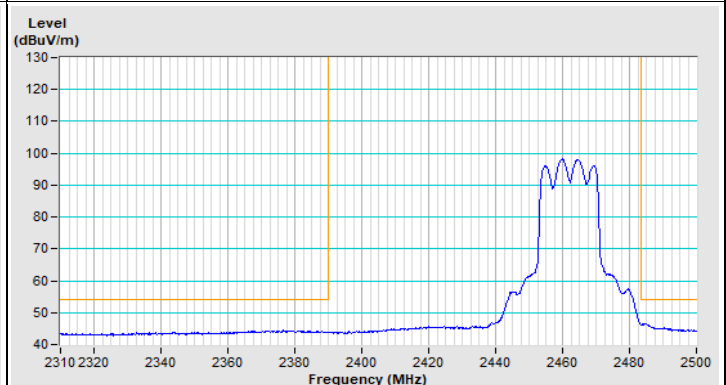

Vertical (Average)

802.11ax (HE20) Channel 1

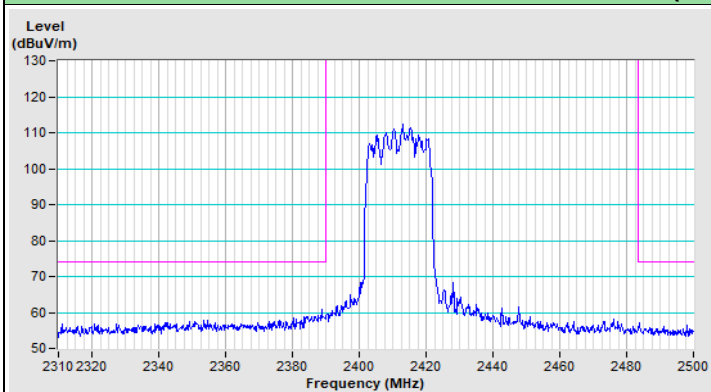

Horizontal (Peak)

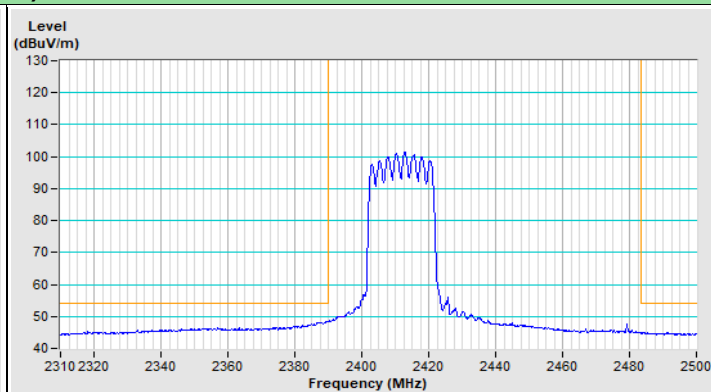

Horizontal (Average)

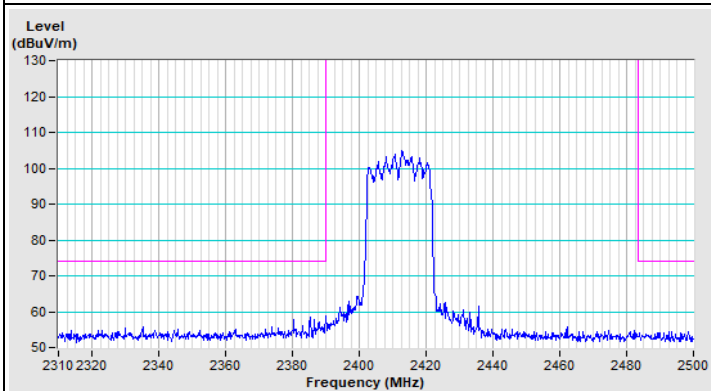

Vertical (Peak)

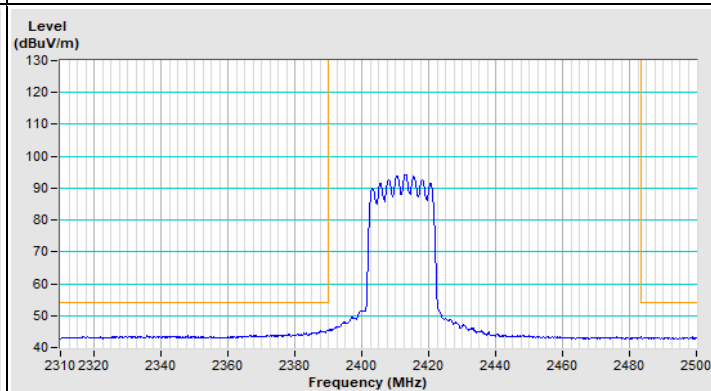

Vertical (Average)

802.11ax (HE20) Channel 11

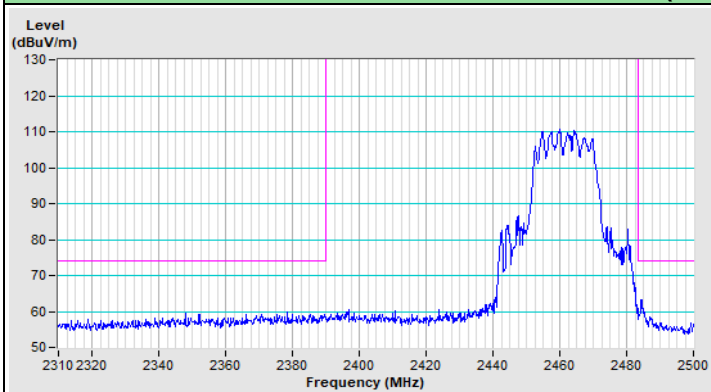

Horizontal (Peak)

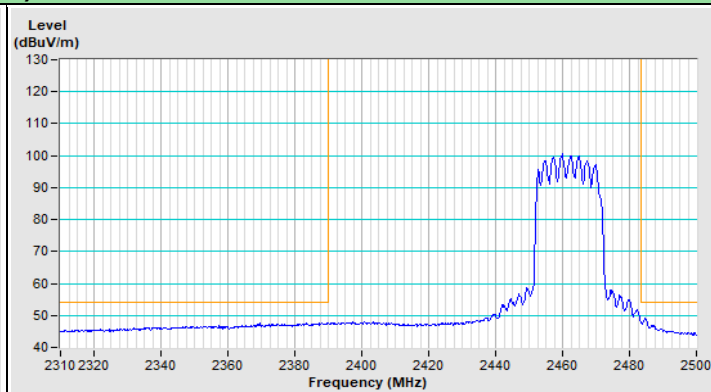

Horizontal (Average)

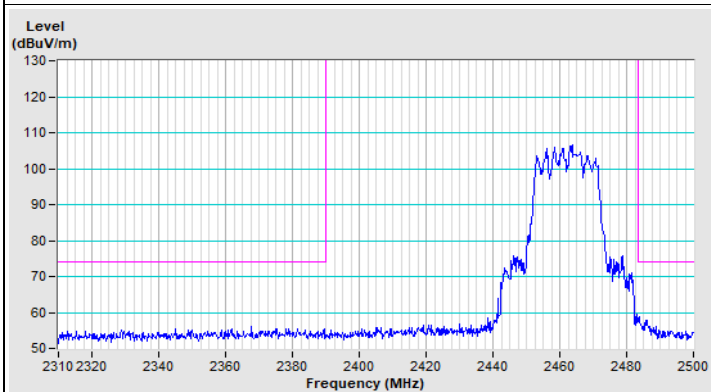

Vertical (Peak)

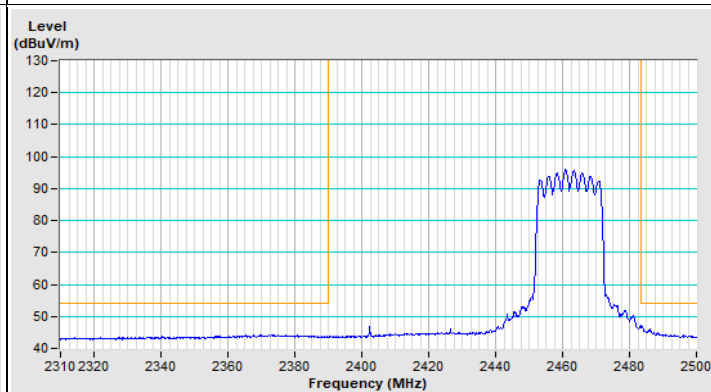

Vertical (Average)

802.11ax (HE40) Channel 3

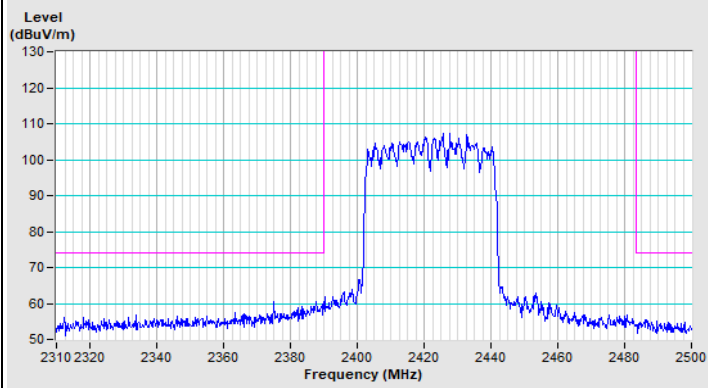

Horizontal (Peak)

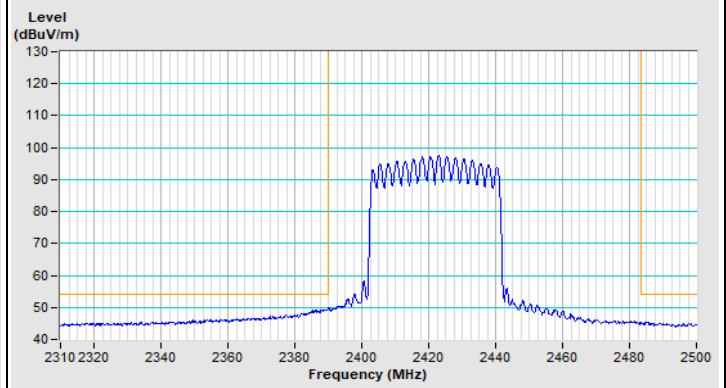

Horizontal (Average)

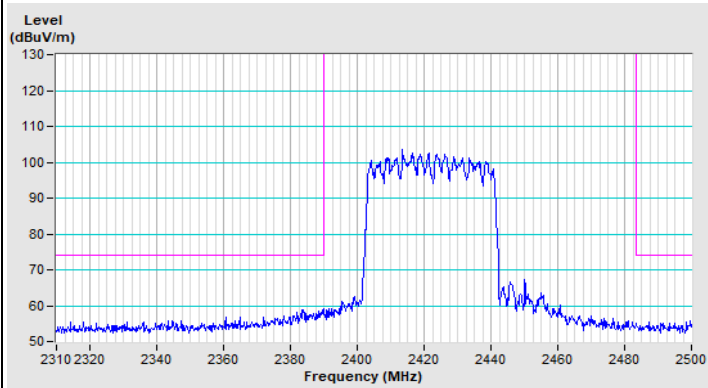

Vertical (Peak)

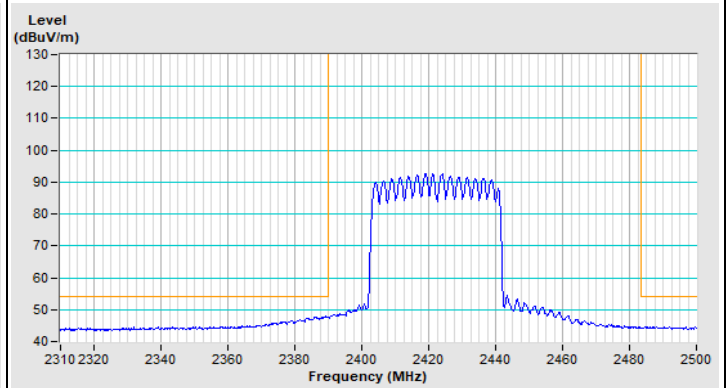

Vertical (Average)

802.11ax (HE40) Channel 9

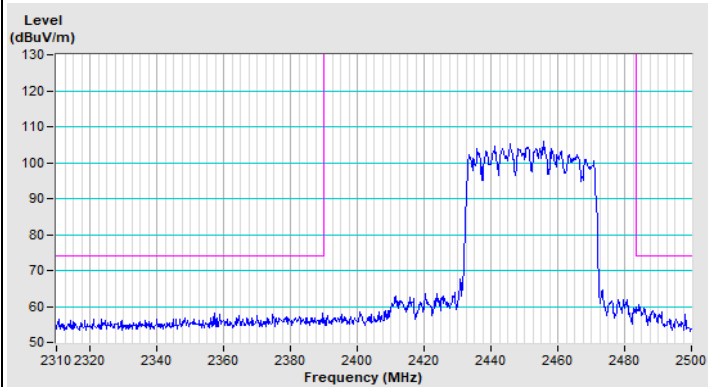

Horizontal (Peak)

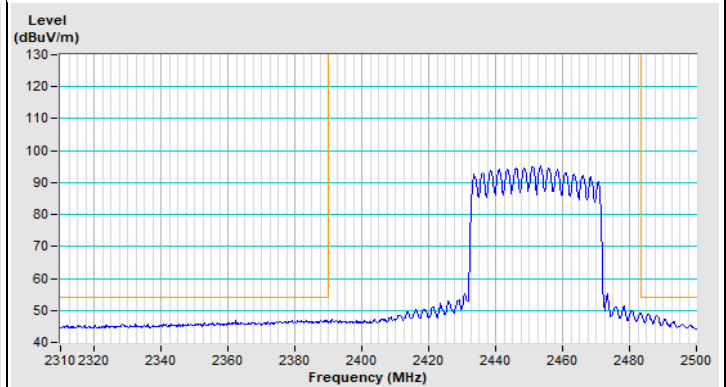

Horizontal (Average)

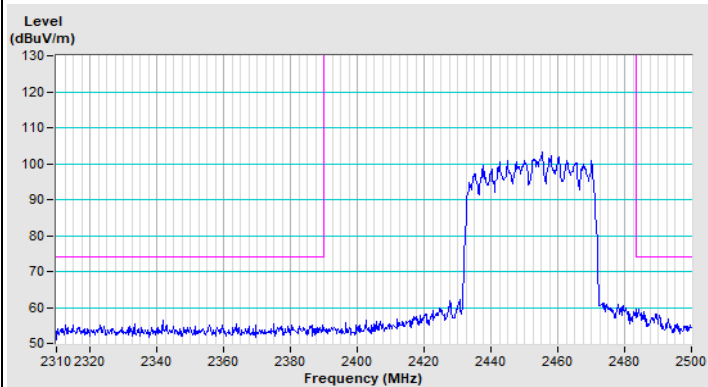

Vertical (Peak)

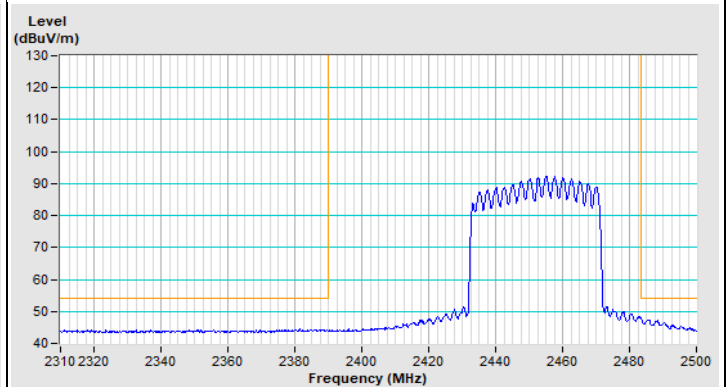

Vertical (Average)

8 Pictures of Test Arrangements

Please refer to the attached file (Test Setup Photo)

9 Information of the Testing Laboratories

We, Bureau Veritas Consumer Products Services (H.K.) Ltd., Taoyuan Branch, were founded in 1988 to provide our best service in EMC, Radio, Telecom and Safety consultation. Our laboratories are FCC recognized accredited test firms and accredited according to ISO/IEC 17025.

If you have any comments, please feel free to contact us at the following:

Lin Kou EMC/RF Lab

Tel: 886-2-26052180

Fax: 886-2-26051924

Hsin Chu EMC/RF/Telecom Lab

Tel: 886-3-6668565

Fax: 886-3-6668323

Hwa Ya EMC/RF/Safety Lab

Tel: 886-3-3183232

Fax: 886-3-3270892

Email: service.adt@bureauveritas.com

Web Site: <http://ee.bureauveritas.com.tw>

The address and road map of all our labs can be found in our web site also.

--- END ---