

Logitech

Antenna Under Test (AUT)

Report

Antenna P/N: 420-006520 - Antenna 0 ; 420-006521- Antenna 1

Equipment Type: Antenna

Manufacturer: Novocomms (Suzhou) Limited

Test Location: Novocomms (Suzhou) Limited

No.5 Zhonghong road, SND, Suzhou city, Jiangsu Province, China

Tested by: Duke Huang

Test Date: June, 30, 2023

Report Release History

Report version	Description	Date Issued
V1	Original release	
V2	Updated antenna test site info, added antenna part numbers	
V3	Updated antenna chamber test software asterisk note. Replaced "Model Name" with antenna part number. Added antenna manufacturer address.	12/13/2023

Table of Contents

1. EUT Antenna Information	3
2. 3D Radiation Pattern Measurement	3
2.1 Test Location	3
2.2 Description of the anechoic chamber	3
2.3 Test Instruments	4
2.4 Test Procedure	5
2.6 Test Setup photos	6
2.7 Antenna Gain	9

1. EUT Antenna Information

- 1) Antenna Material : FPC
- 2) Antenna Type : Printed F (connector : IPEX MHF I)
- 3) Antenna Dimension:
- 4) Operating Frequency : 2.4 GHz - 2.4835 GHz; 5.1GHz – 7.125GHz
- 5) Input Impedance : 50 Ω
- 6) Standing-Wave Ratio : < 2.6

2. 3D Radiation Pattern Measurement

2.1 Test Location

3D radiation pattern measurement in the anechoic chamber

2.2 Description of the anechoic chamber

Length: 3.062m

Width: 3.120m

Height: 2.932m

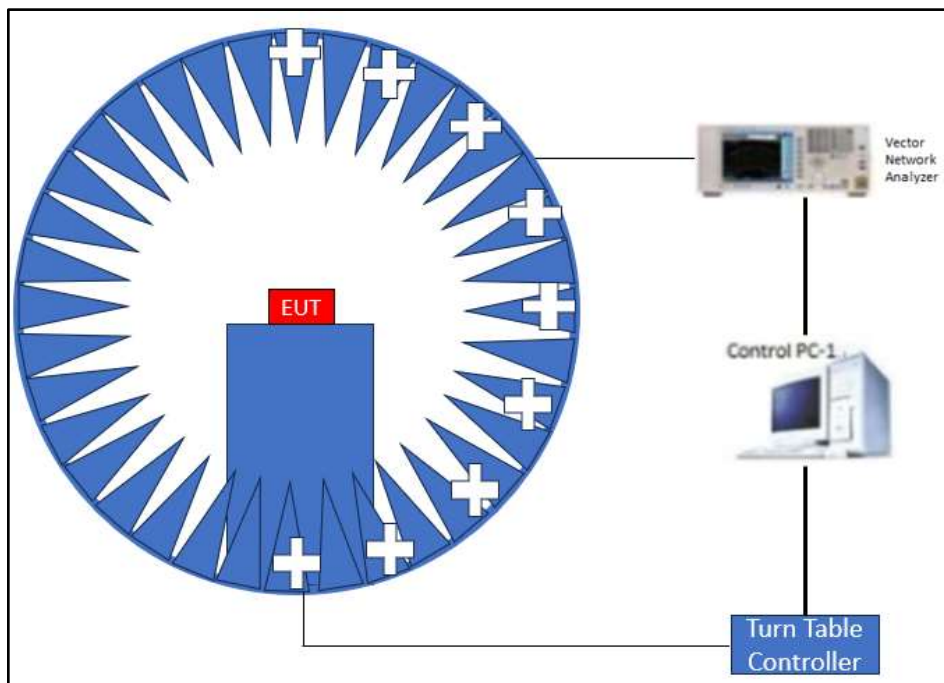

2.3 Test Instruments

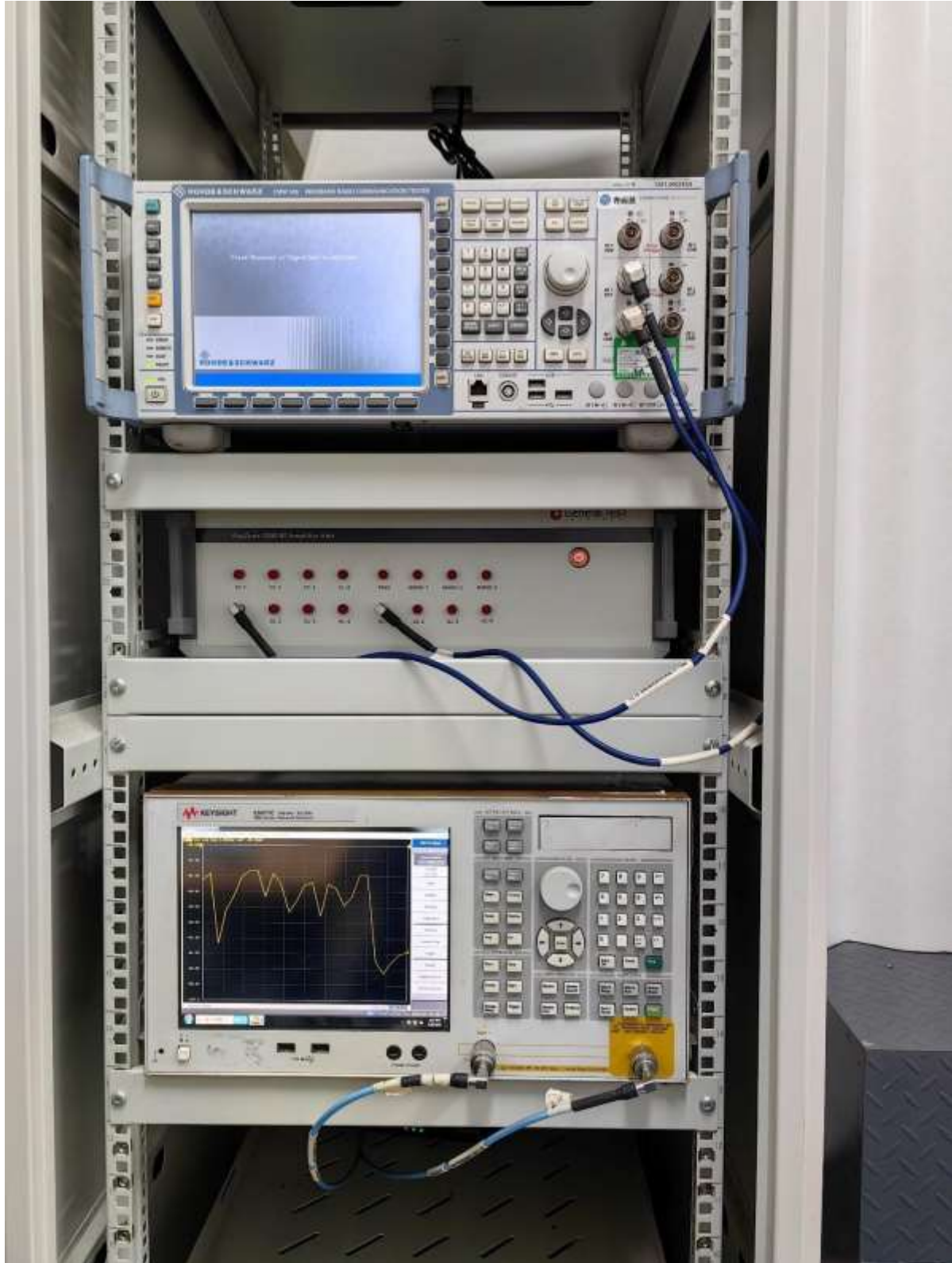

Description	Model No.	Last Calibration [^]
Vector Network Analyzer Keysight	E5071C	Feb/2023
Chamber	GTS Rayzone 2800*	March/2023

Notes: [^]The calibration interval of the above test instruments is 12 months

* Test software used is GTS MaxSign Libra version 1.1.8

2.4 Test Procedure

- i. Measure loss of the RF test cable.
- ii. Solder the test RF cable to the Antenna.
- iii. Mount the DUT on the mast of the chamber, record the coordinates and take pictures.
- iv. Calibrate the chamber where the connection to source from the VNA Port 1.
- v. Compensate for the loss from the test cable from item 2.4.i.
- vi. Read the channel power level on the Network analyzer and record in the following positions.
 1. The mast is then stepped between 0 to 360 degrees along the horizontal plane in 15-degree increments.
 2. Data is recorded using the VNA for both theta (Port2) and phi (Port3) polarizations at each position.

2.7 Antenna Gain

Ant0			
Frequency	Efficiency (dB)	Efficiency%	Gain
2412	-3.64	43.29	4.18
2437	-3.44	45.32	4.49
2462	-2.71	53.64	4.50
5180	-2.41	57.39	5.92
5210	-2.18	60.58	6.08
5240	-1.97	63.49	6.4
5260	-2.09	61.87	6.31
5290	-1.86	65.19	6.40
5320	-1.74	66.99	6.3
5500	-2.70	53.7	6.91

5600	-3.12	48.75	6.93
5720	-3.89	40.81	6.43
5745	-3.8	41.67	6.53
5775	-3.97	40.05	6.25
5825	-3.73	42.40	6.15
6115	-3.72	42.43	4.33
6275	-3.83	41.40	2.80
6415	-1.89	64.75	5.31
6435	-1.54	70.11	5.64
6475	-1.98	63.35	5.47
6515	-1.46	71.52	6.38
6535	-0.85	82.16	7.03
6695	-1.49	70.88	6.03
6855	-3.47	44.98	4.55
6895	-5.24	29.91	2.81
7015	-3.92	40.56	2.89
7095	-3.90	40.79	2.83

ANT1			
Frequency	Efficiency (dB)	Efficiency%	Gain
2412	-3.77	41.99	2.88
2437	-3.81	41.64	3.41
2462	-3.82	41.50	3.36
5180	-2.2	60.28	4.93
5210	-1.79	66.29	5.10
5240	-1.33	73.64	5.65
5260	-1.33	73.59	5.72
5290	-0.70	85.15	6.43
5320	-0.31	93.17	6.69
5500	-0.81	83.06	6.44
5600	-1.19	76.08	6.09
5720	-3.39	45.83	3.81
5745	-3.64	43.29	3.69
5775	-4.30	37.19	3.11

5825	-4.97	31.84	2.61
6115	-3.18	48.12	4.69
6275	-2.79	52.61	5.44
6415	-2.04	62.54	5.75
6435	-1.85	65.29	5.78
6475	-2.53	55.88	4.78
6515	-1.99	63.31	5.44
6535	-1.38	72.76	6.00
6695	-1.38	72.86	6.81
6855	-4.49	35.59	3.46
6895	-6.72	21.28	1.09
7015	-7.24	18.87	0.51
7095	-8.59	13.83	-1.11

3D Pattern Test Plot
Antenna 0

Scale:



2412

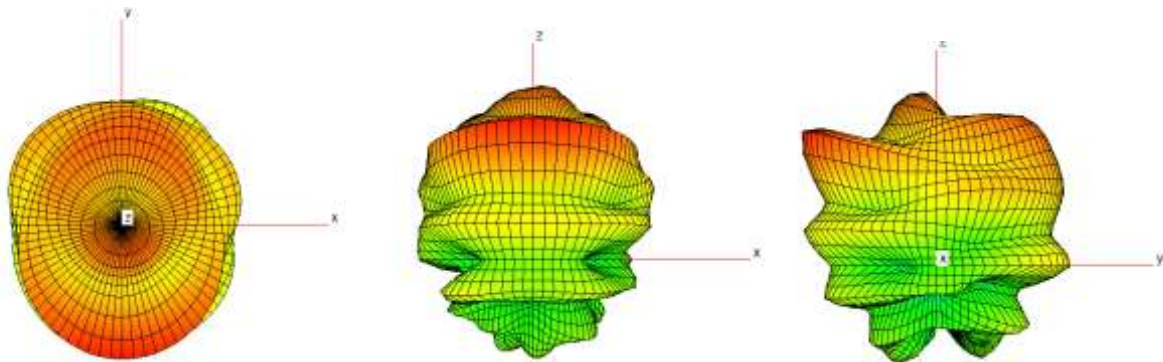

2437

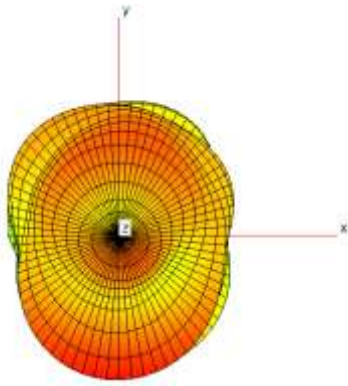

2462

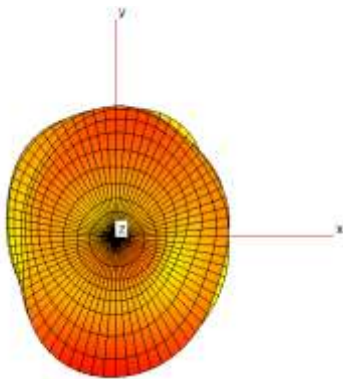
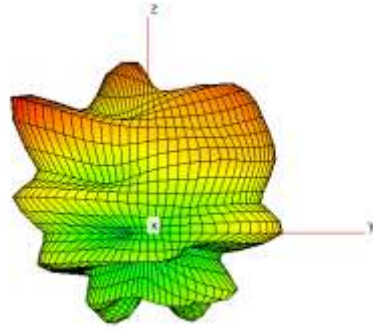
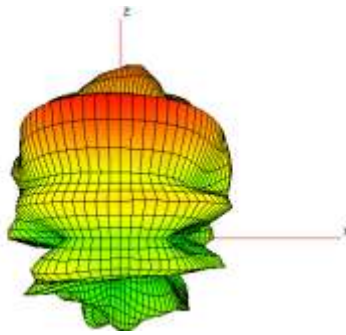

5180

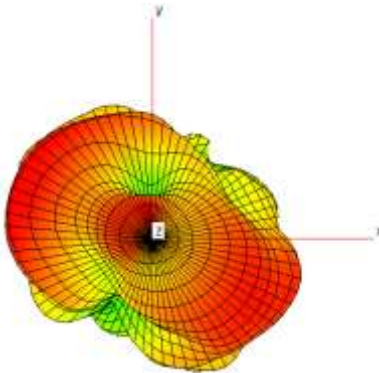
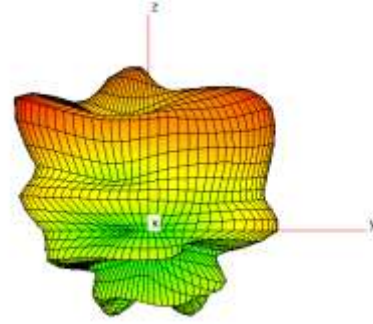
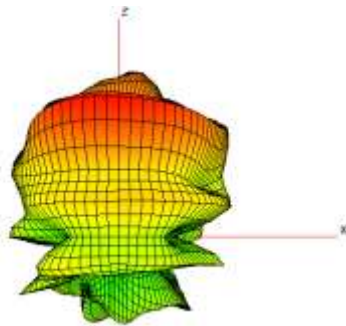

5210

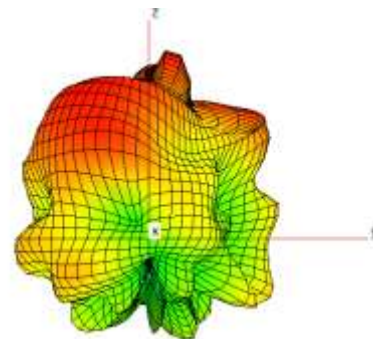
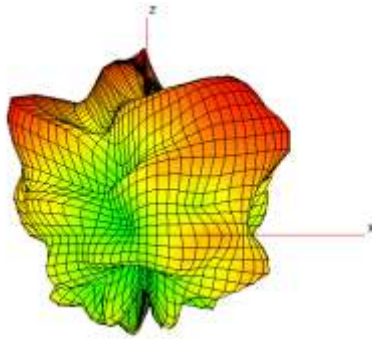

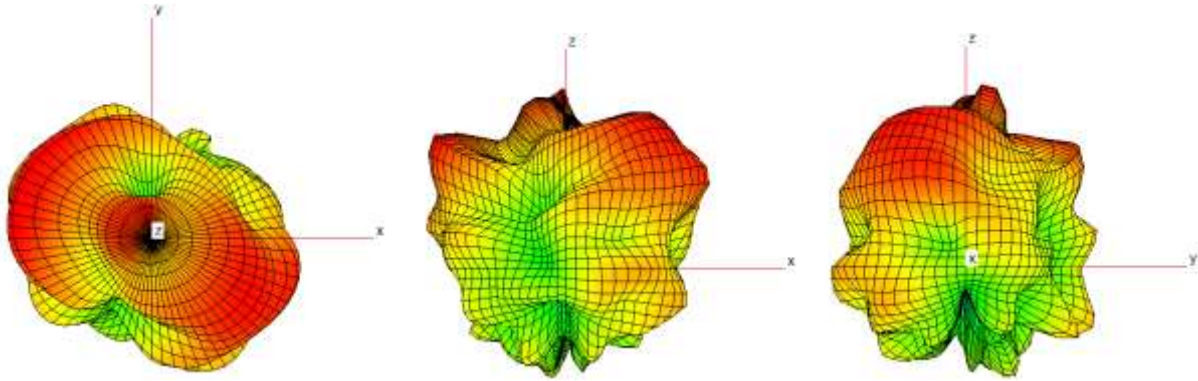

5240

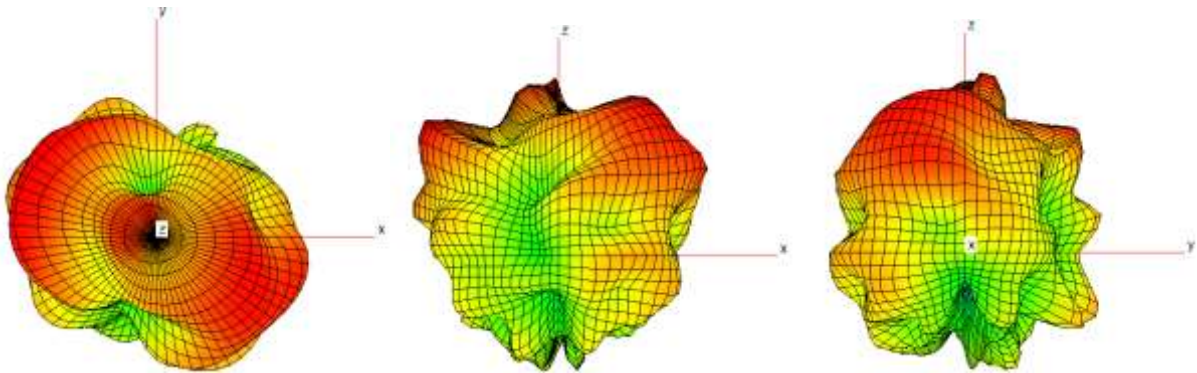

5250

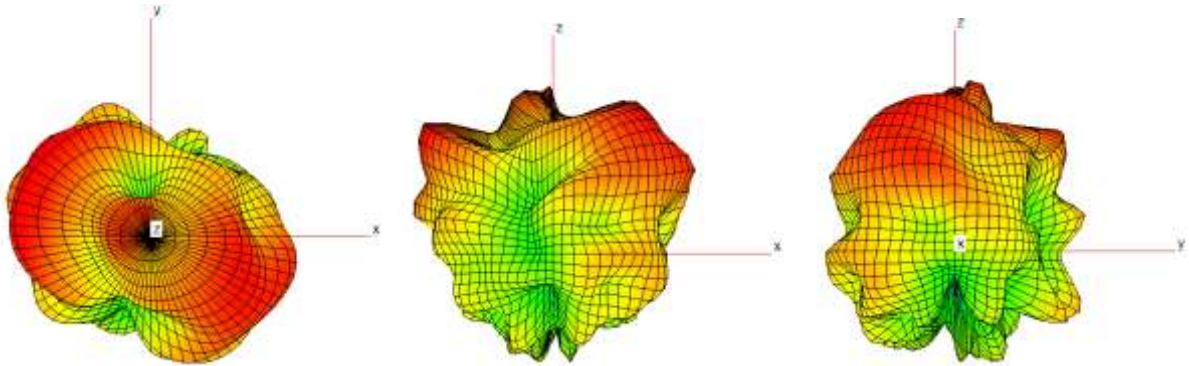

5290

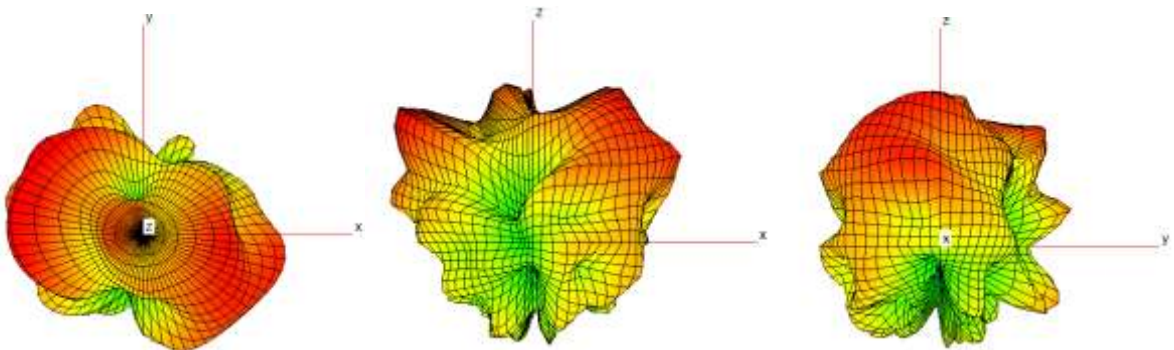

5320

Report No: AGY-700-032073

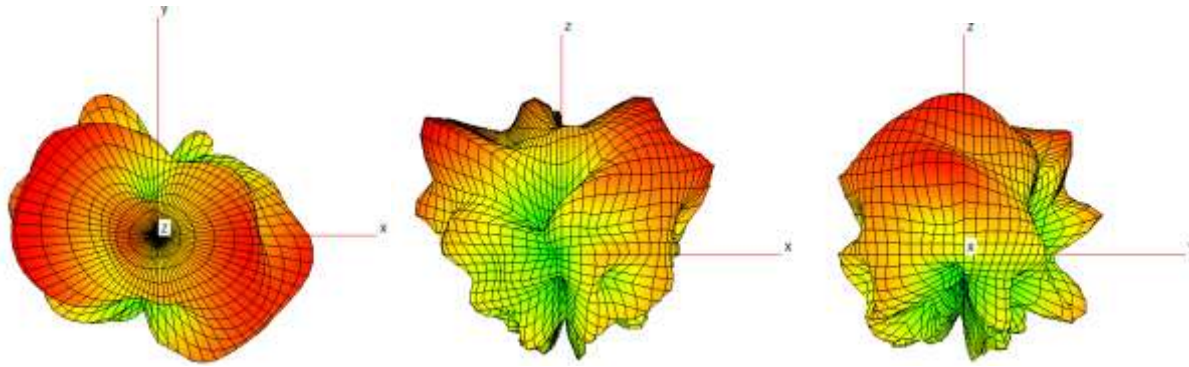

5500

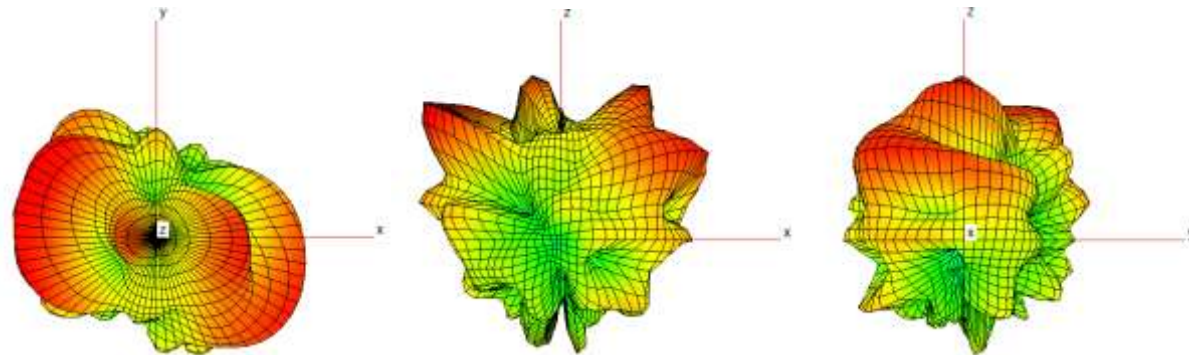

5600

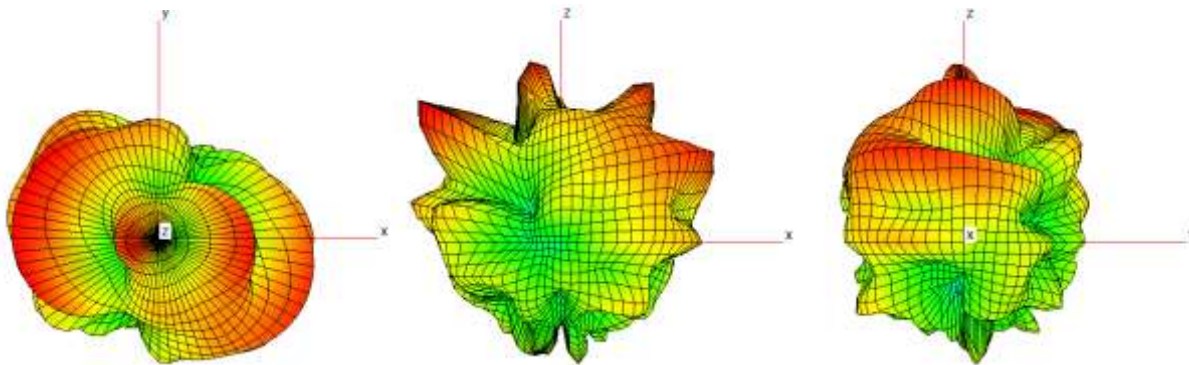

5720

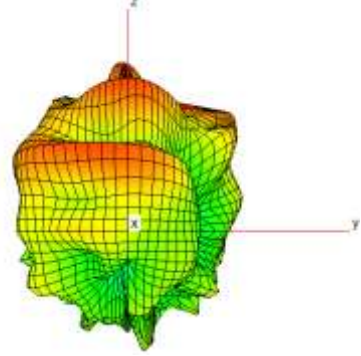
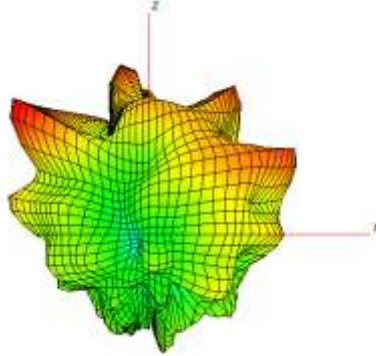
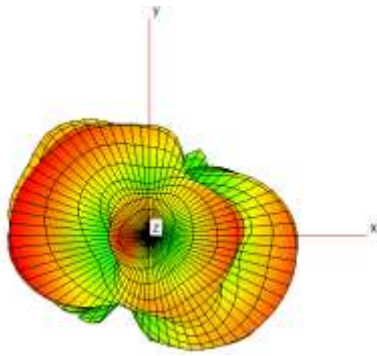

5745

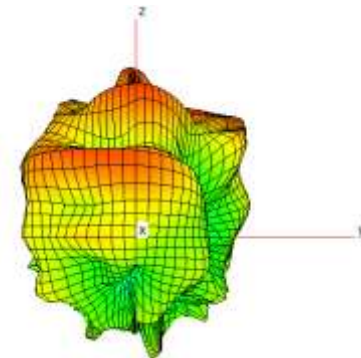
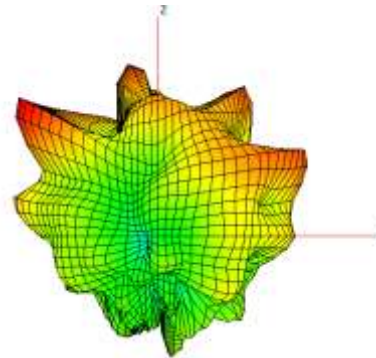
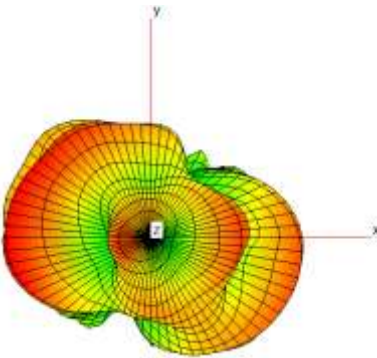

5775

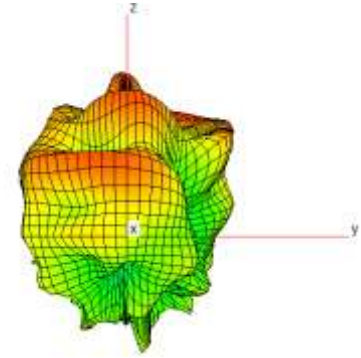
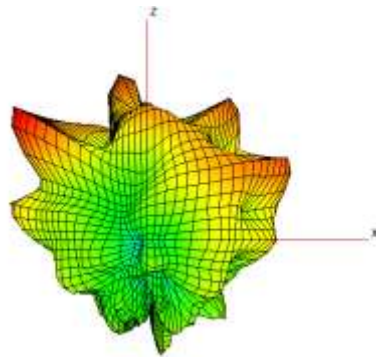
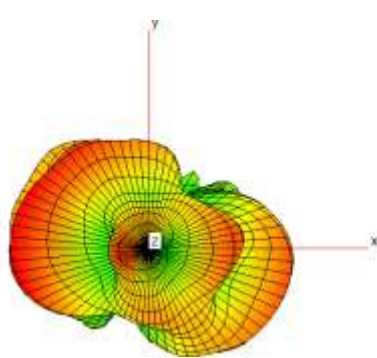

5825

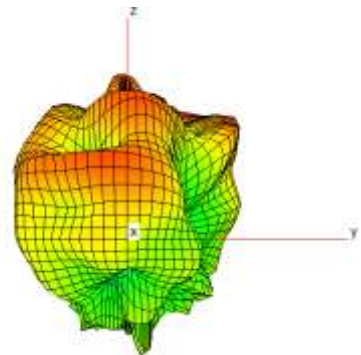
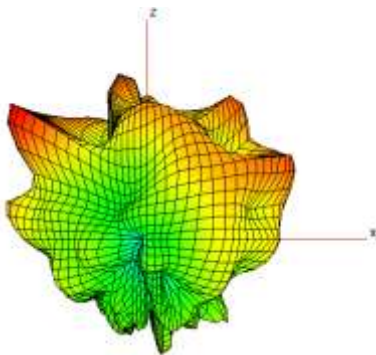
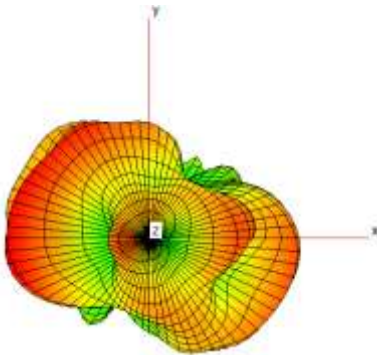

6115

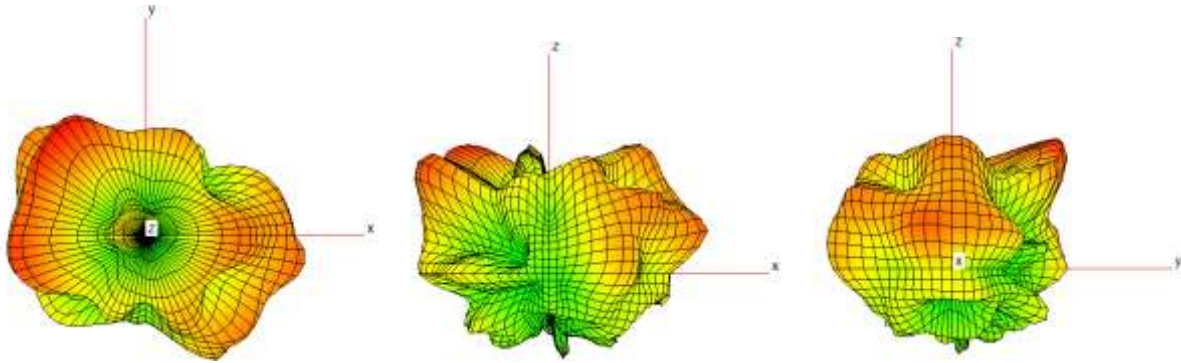

6275

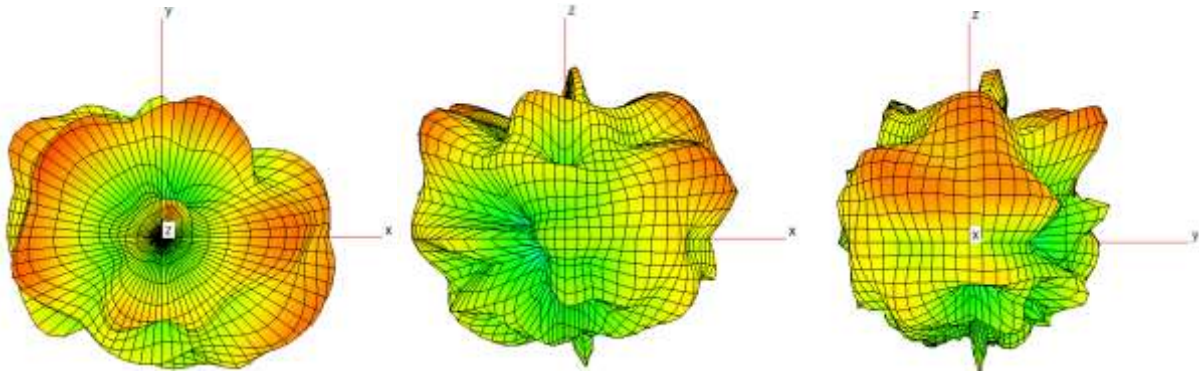

6415

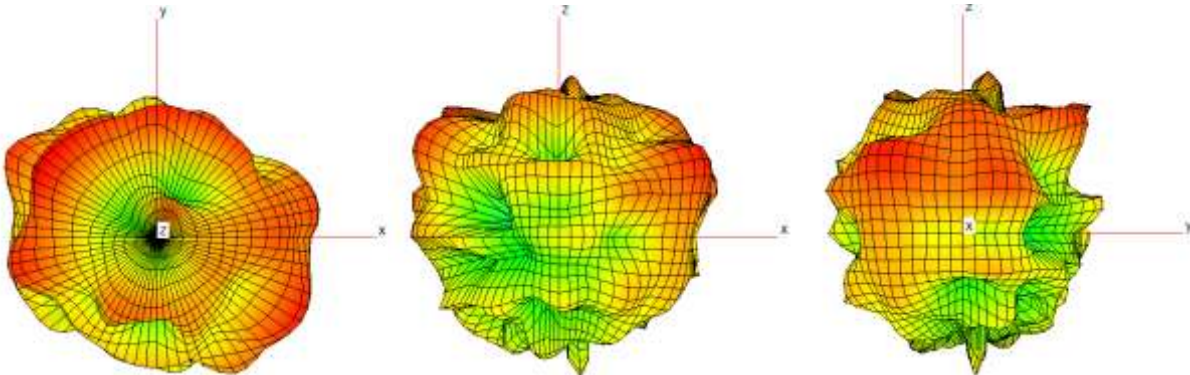

6435

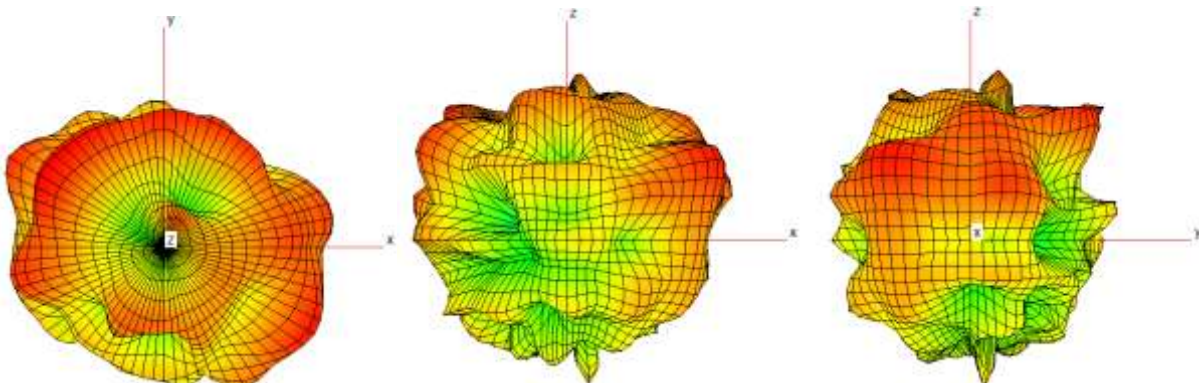

6475

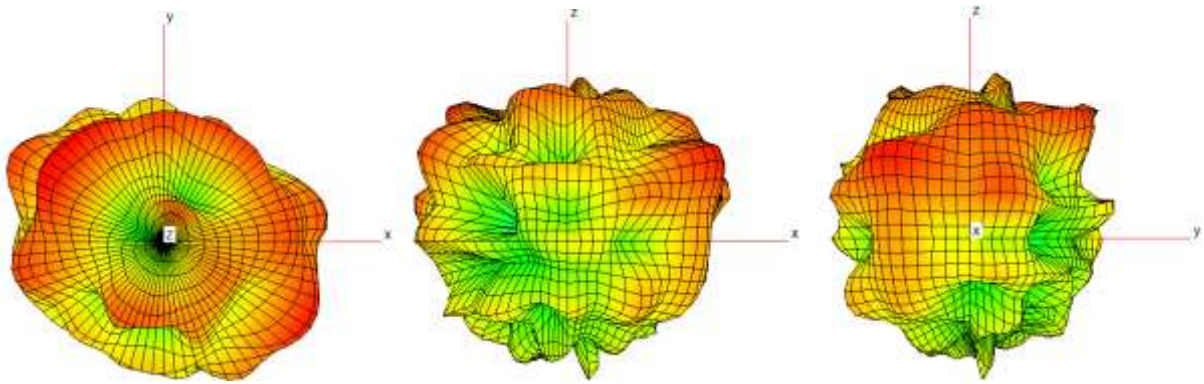

6515

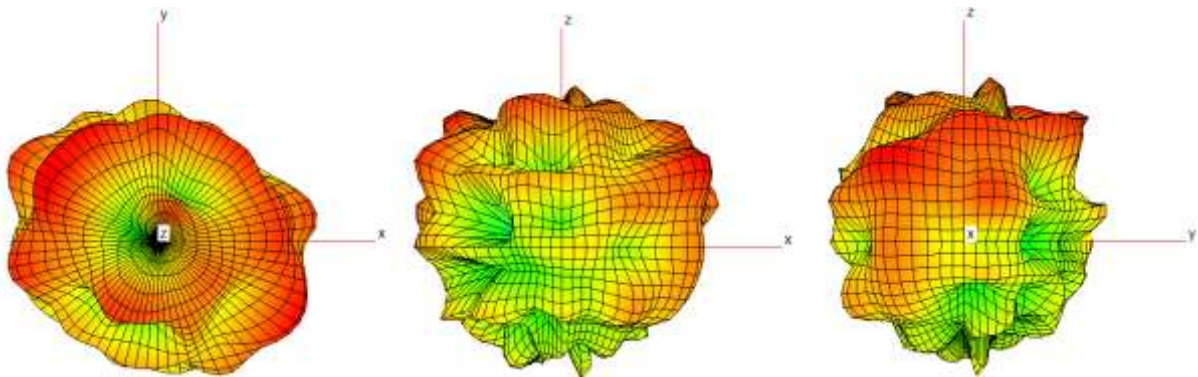

6535

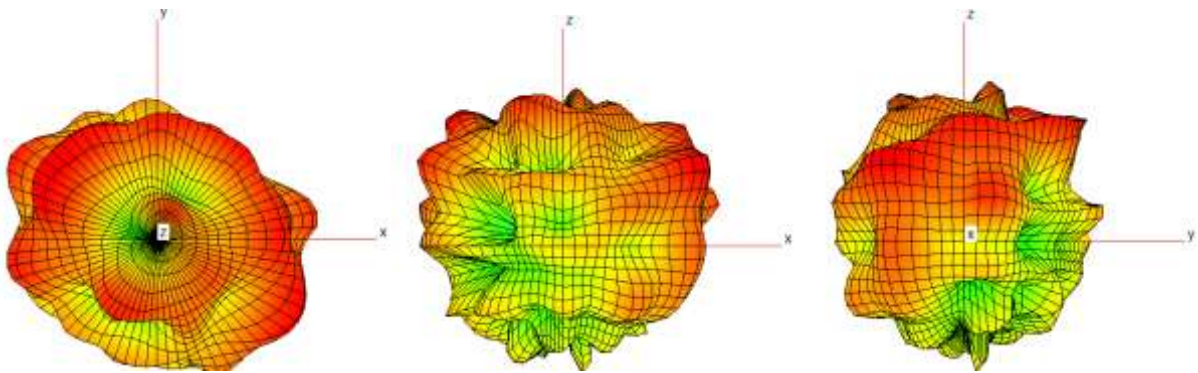

6695

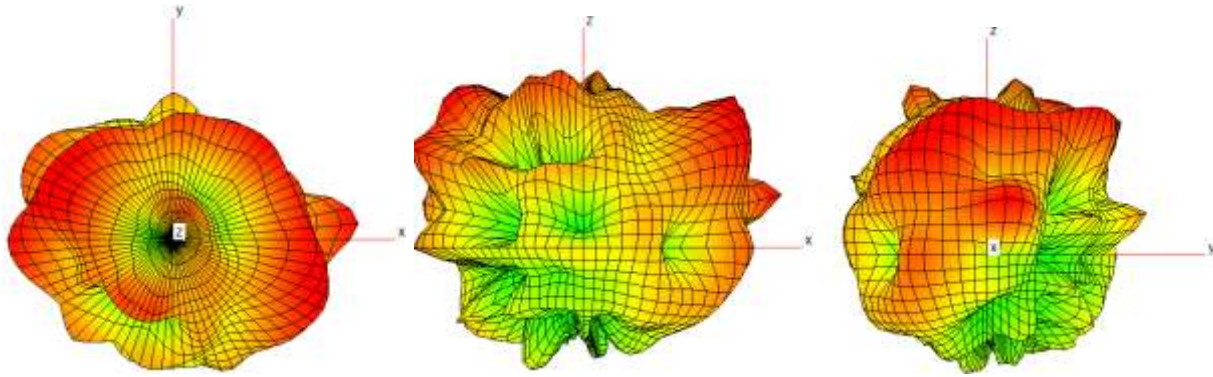

6855

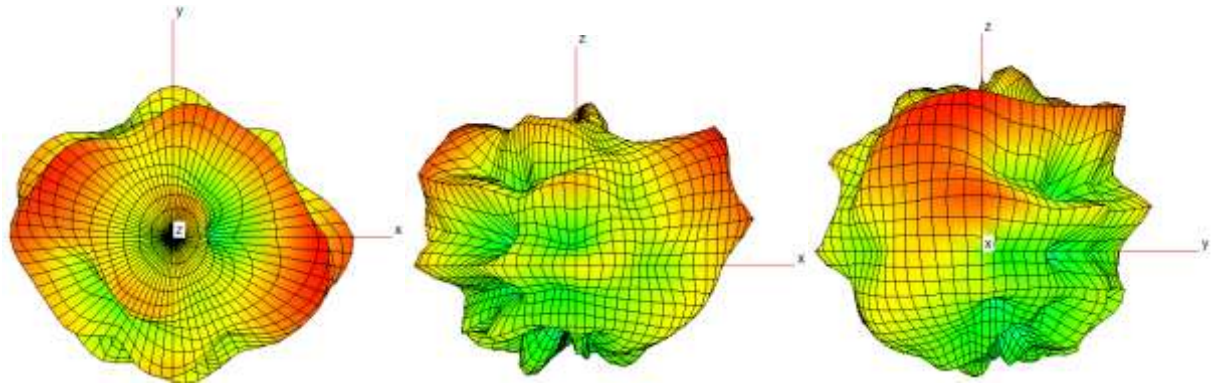

6895

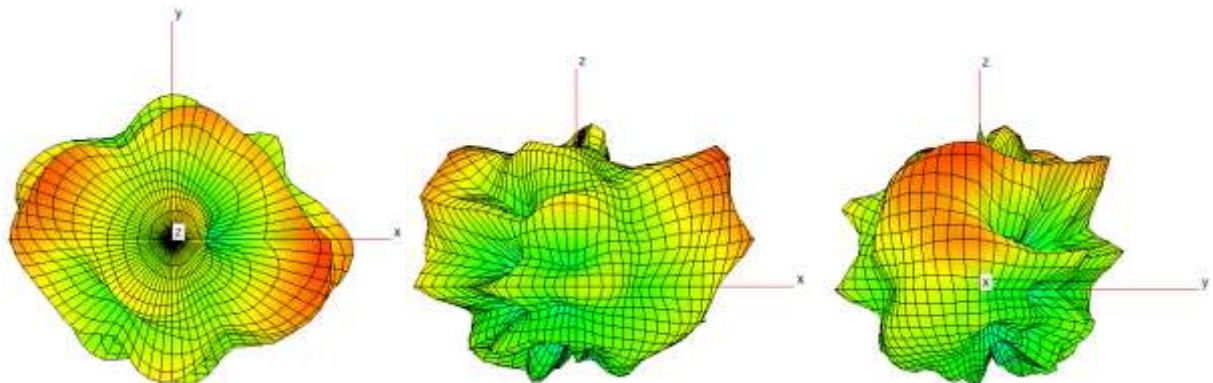

7015

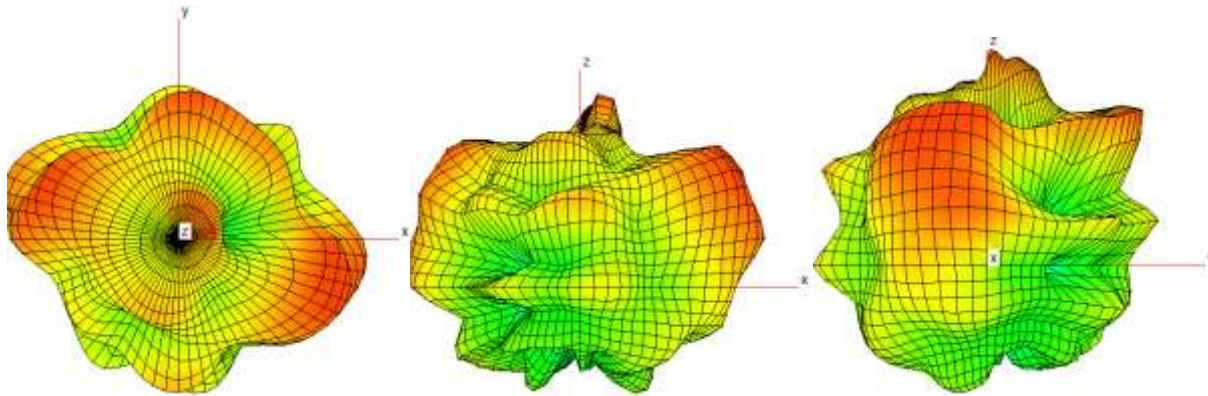

7095

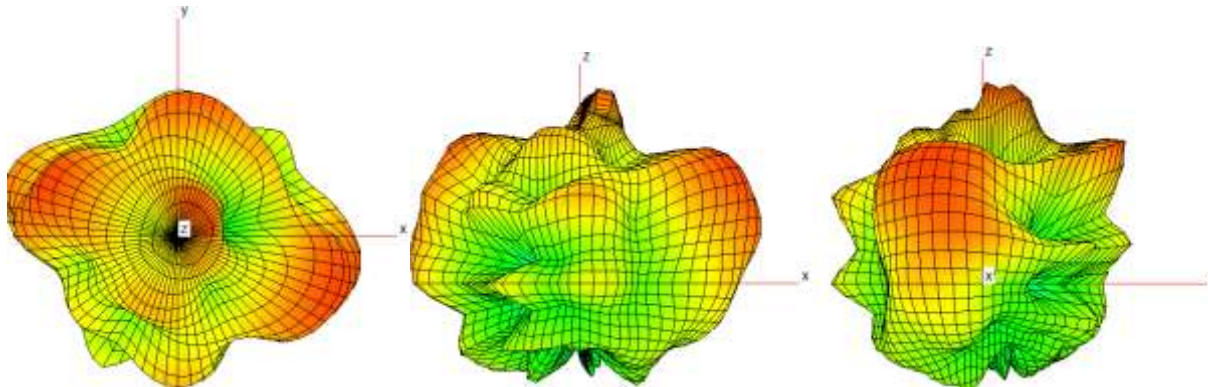

Antenna 1

Scale:



2412MHz: 1

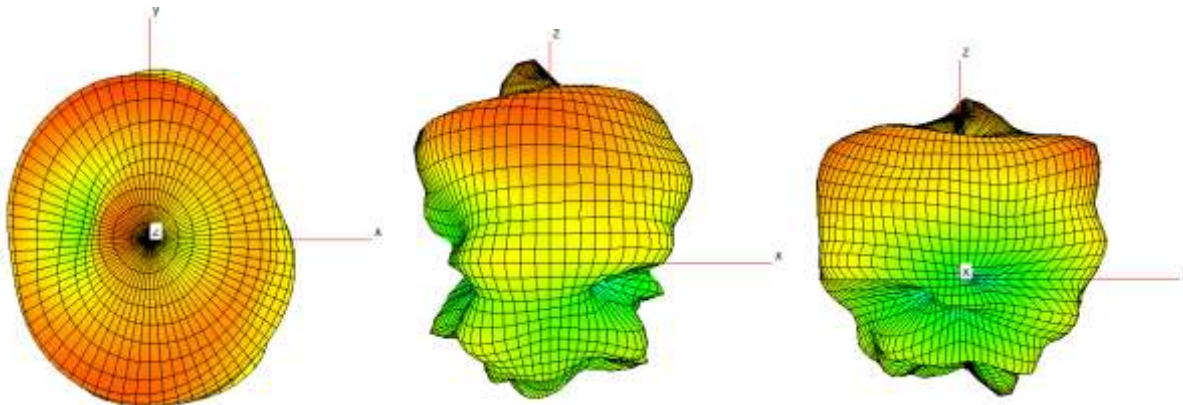

2437

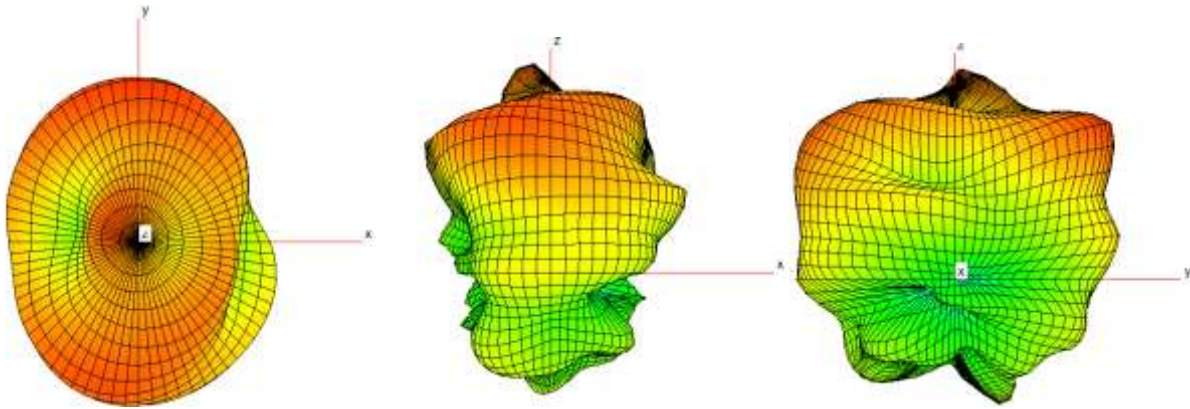

2462

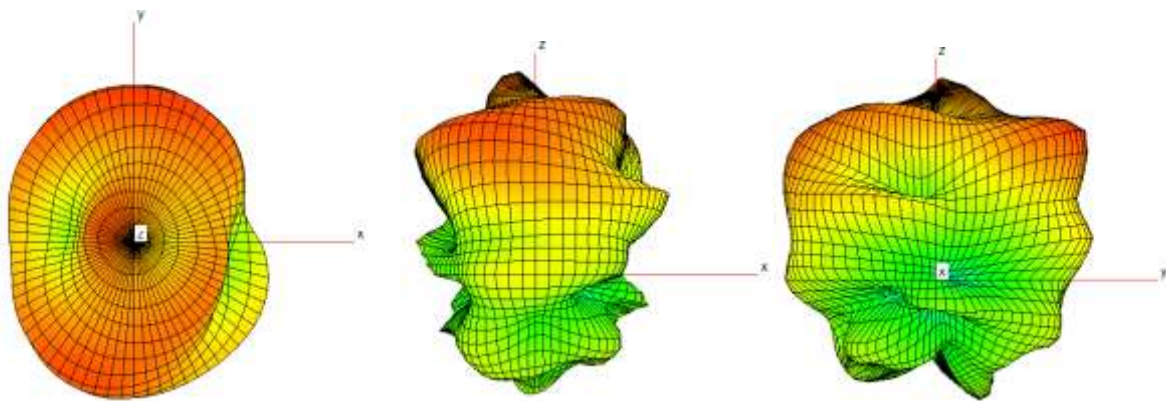

5180

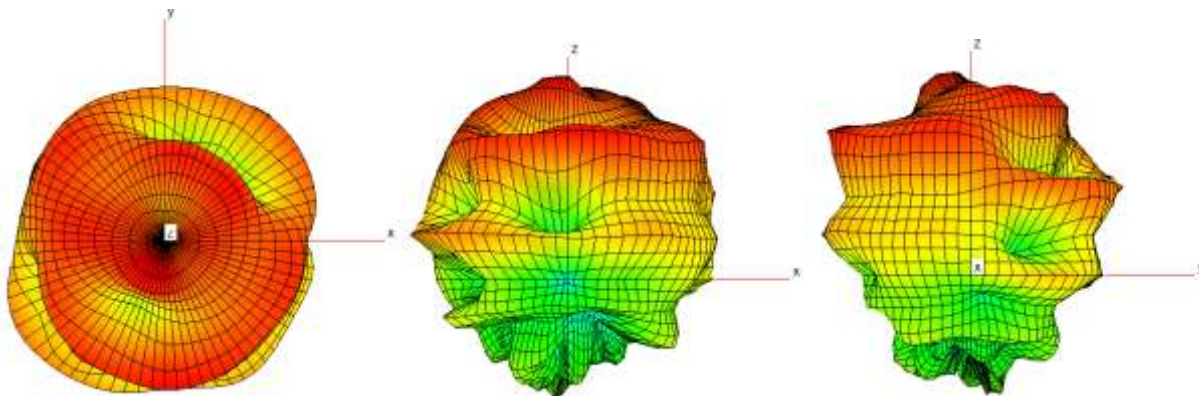

5210

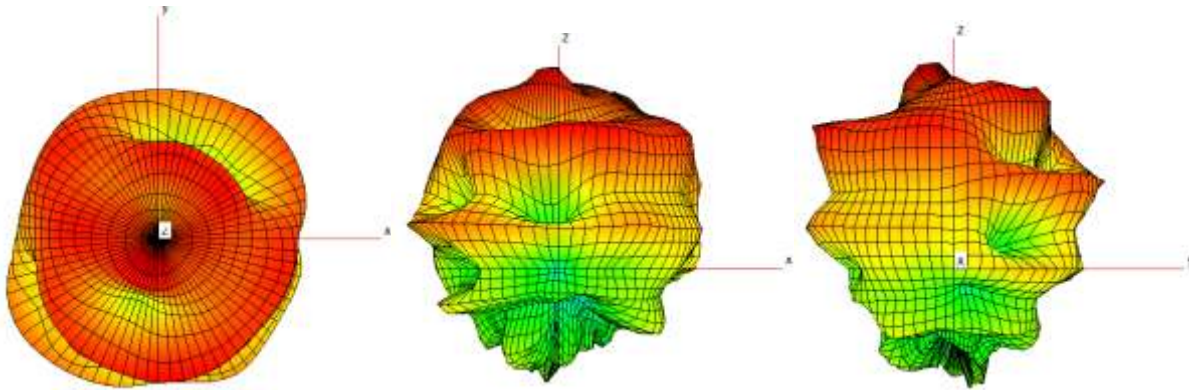

5240

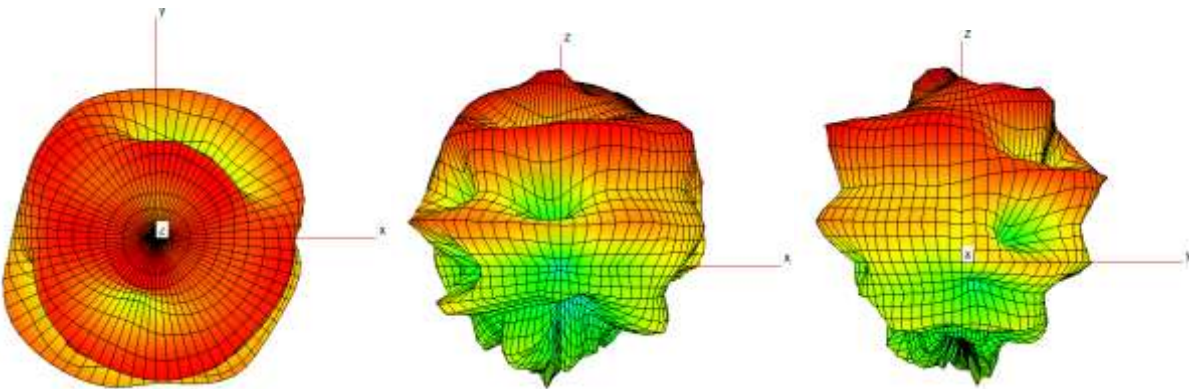

5250

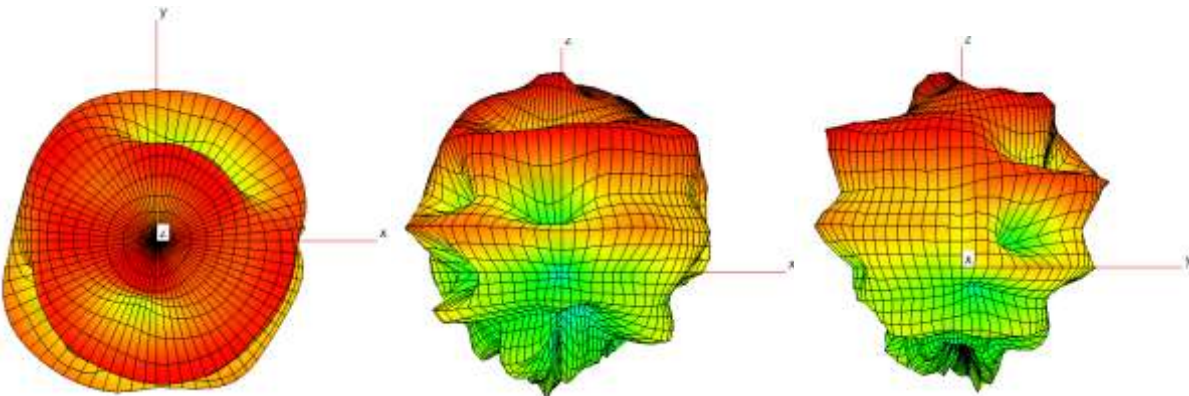

5290

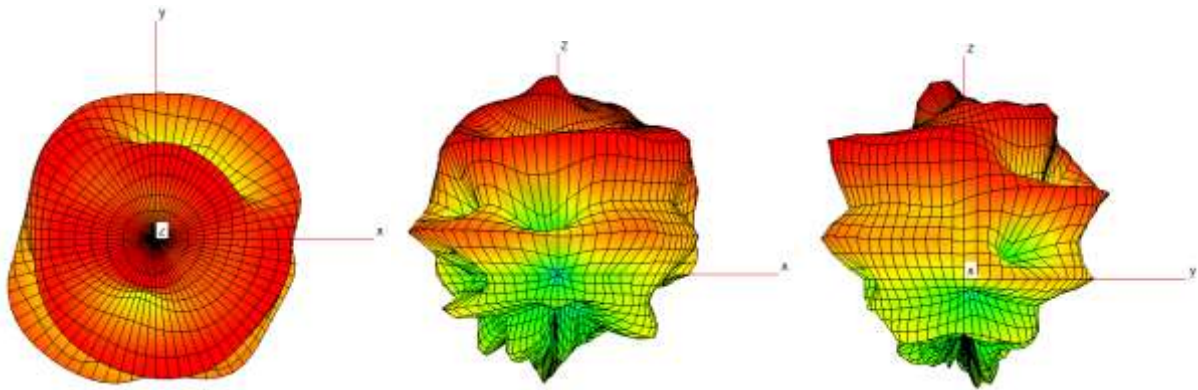

5320

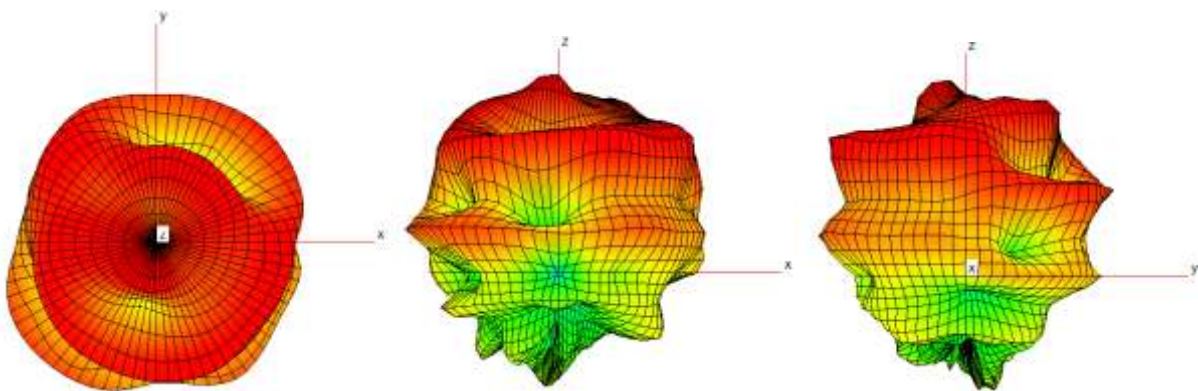

5500

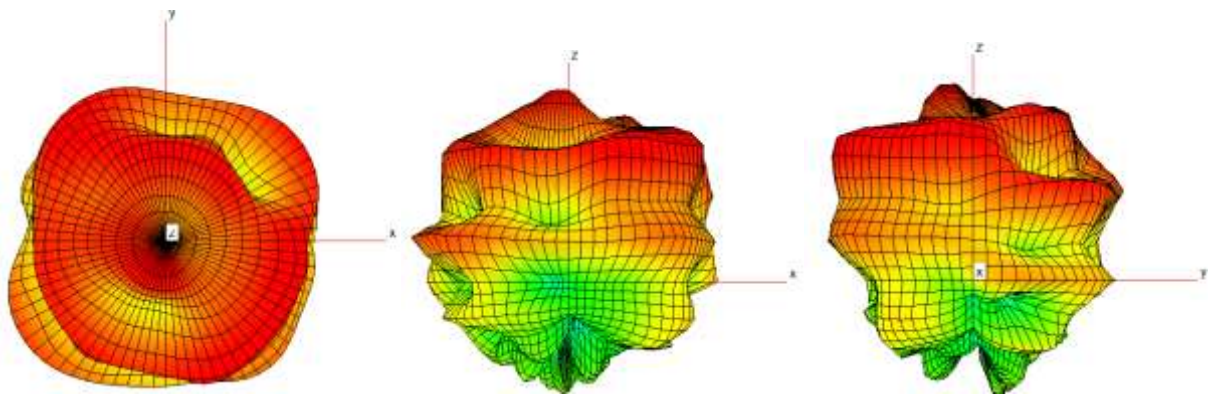

5600

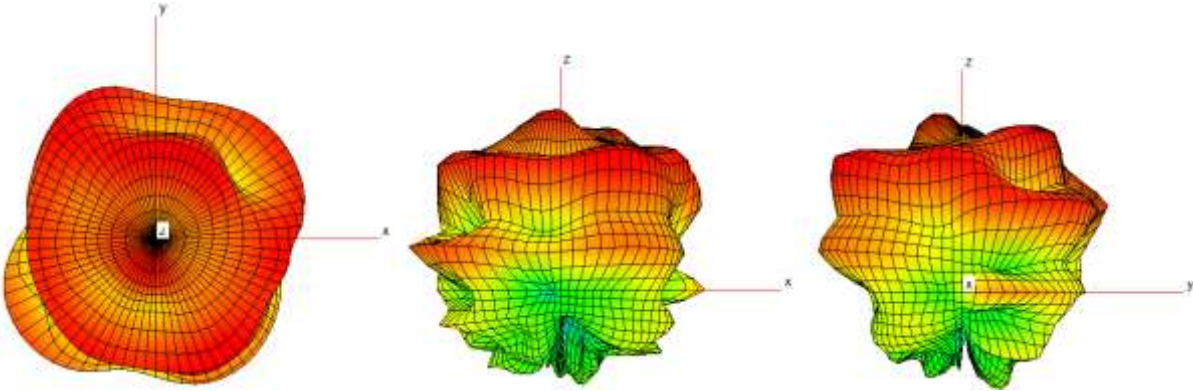

5720

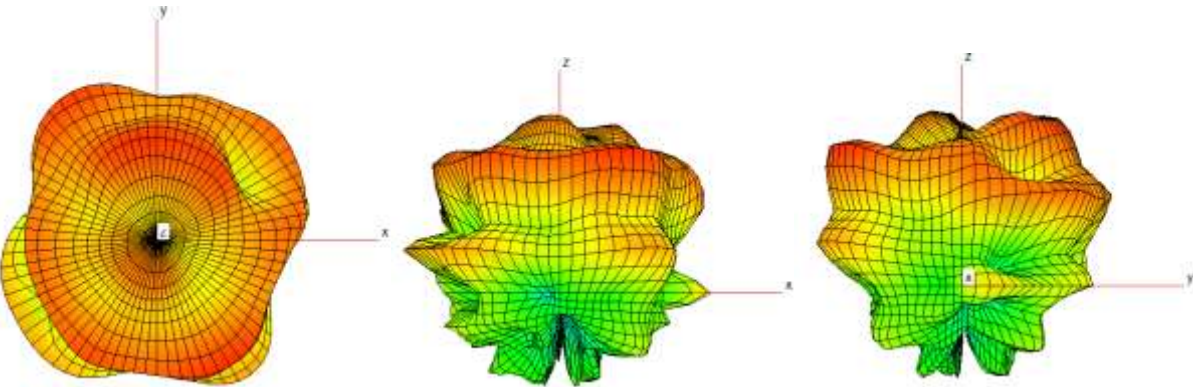

5745

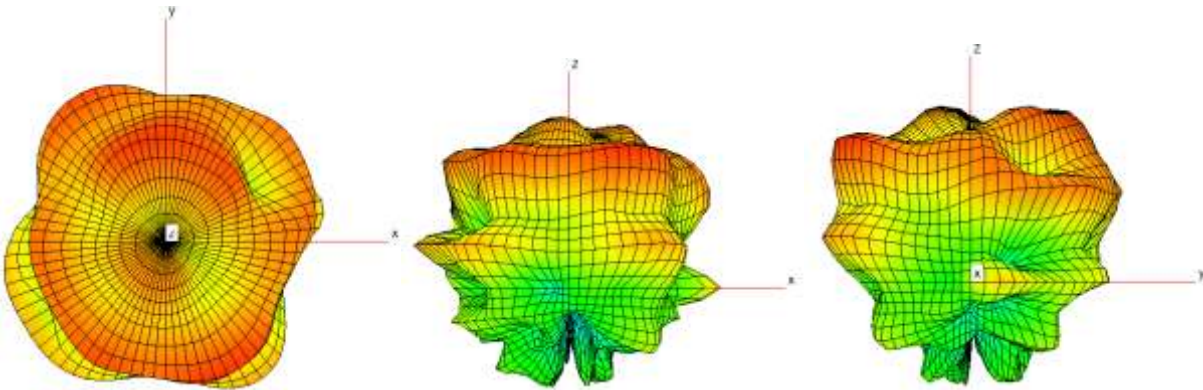

5775

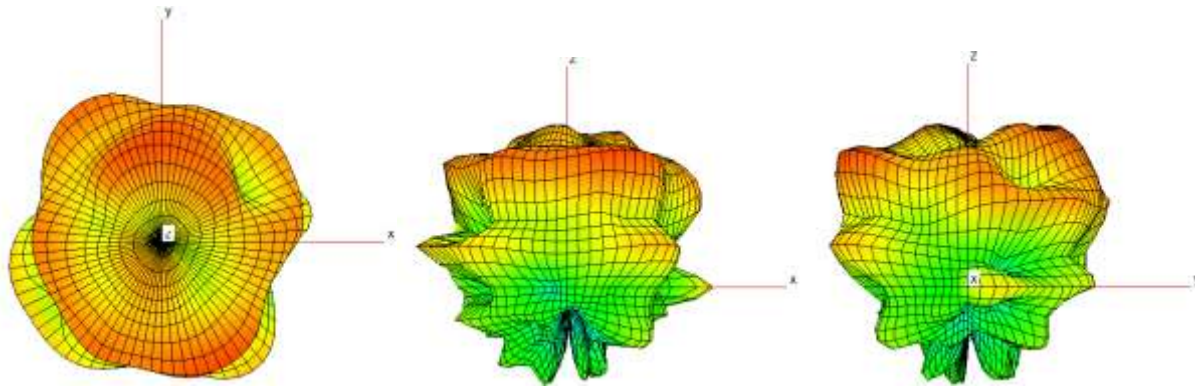

5825

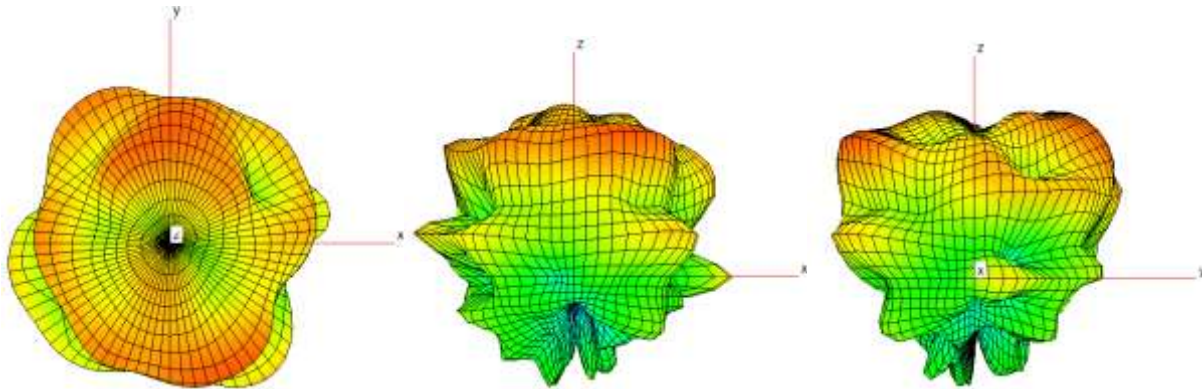

6115

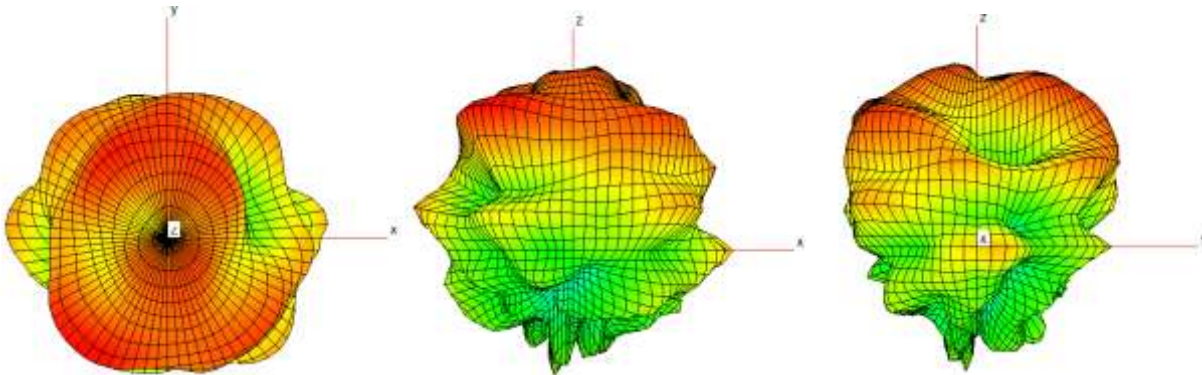

6275

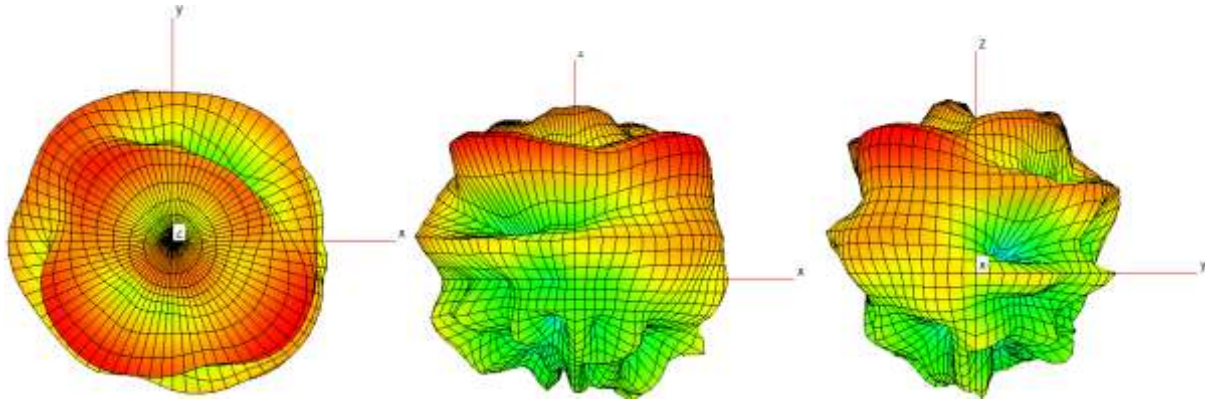

6415

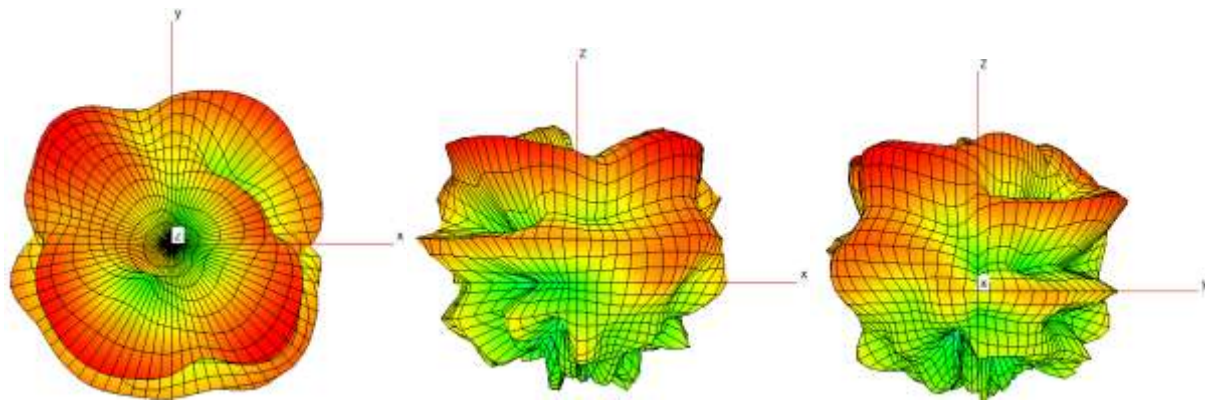

6475

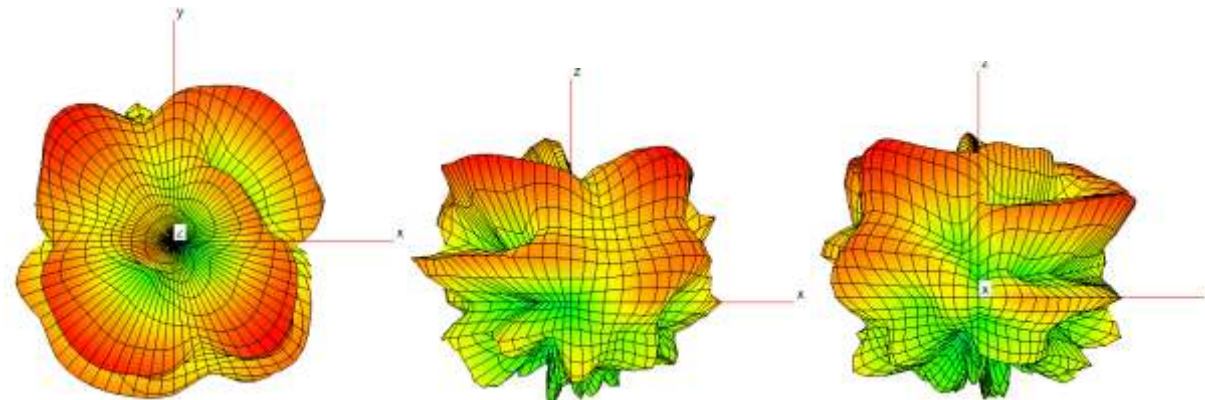

6515

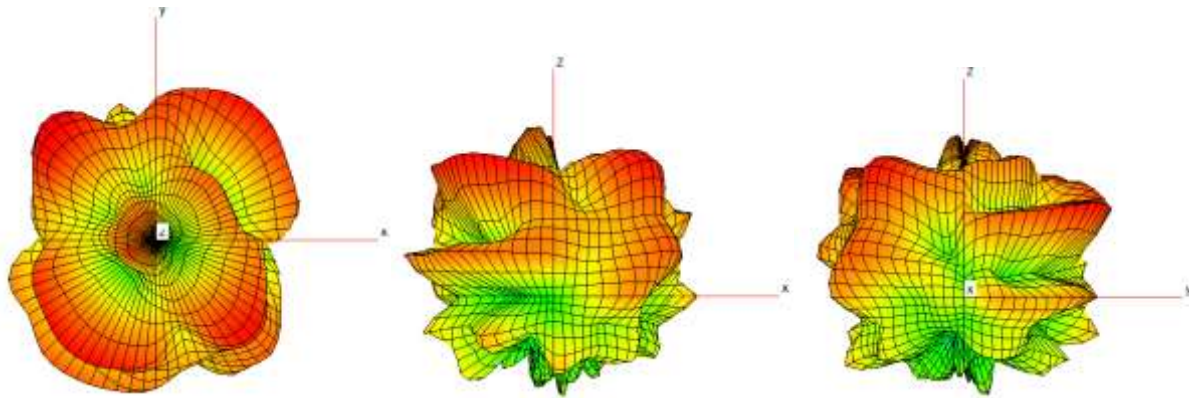

6695

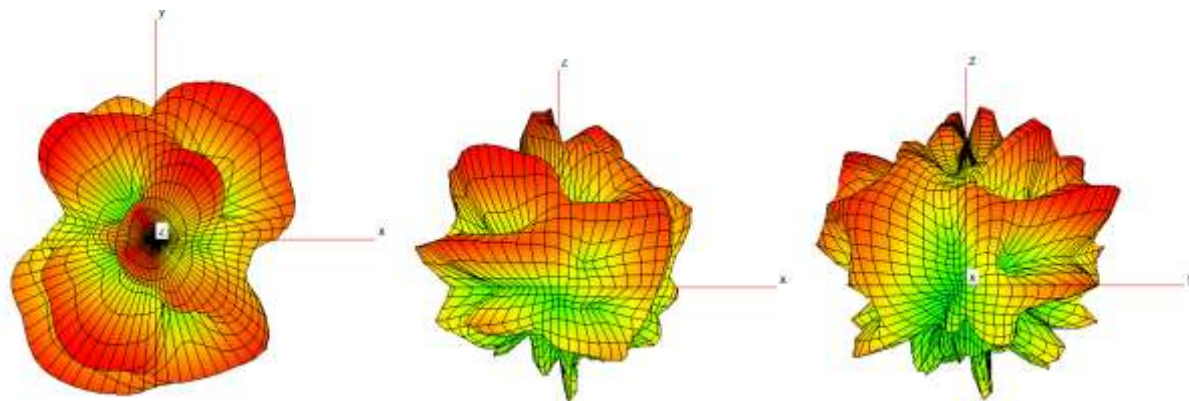

6855

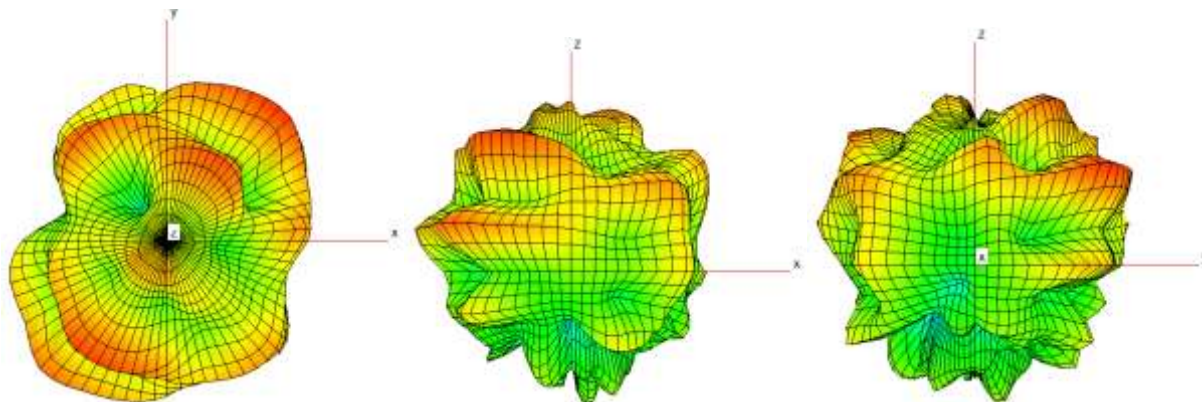

7015

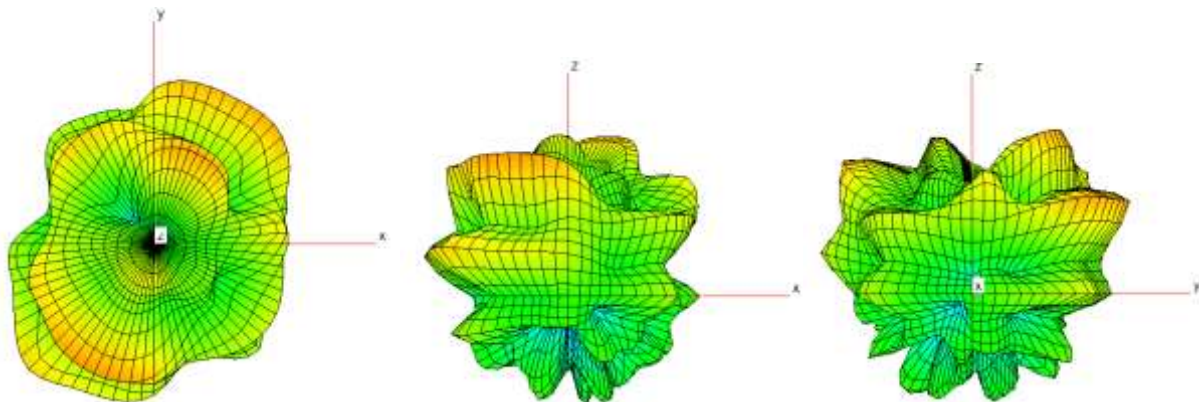

7095

