

Supplemental “Transmit Simultaneously” Test Report

Report No.: RFBDKG-WTW-P20110147-4

FCC ID: JNZVR0020

Test Model: VR0020

Received Date: Nov. 10, 2020

Test Date: Apr. 09 to 16, 2021

Issued Date: May 07, 2021

Applicant: Logitech Far East Ltd

Address: 7700 Gateway Boulevard Newark California United States

Issued By: Bureau Veritas Consumer Products Services (H.K.) Ltd., Taoyuan Branch
Hsin Chu Laboratory

Lab Address: E-2, No.1, Li Hsin 1st Road, Hsinchu Science Park, Hsinchu City 300,
Taiwa.

Test Location: E-2, No.1, Li Hsin 1st Road, Hsinchu Science Park, Hsinchu City 300,
Taiwan.

**FCC Registration /
Designation Number:** 723255 / TW2022



This report is for your exclusive use. Any copying or replication of this report to or for any other person or entity, or use of our name or trademark, is permitted only with our prior written permission. This report sets forth our findings solely with respect to the test samples identified herein. The results set forth in this report are not indicative or representative of the quality or characteristics of the lot from which a test sample was taken or any similar or identical product unless specifically and expressly noted. Our report includes all of the tests requested by you and the results thereof based upon the information that you provided to us. You have 60 days from date of issuance of this report to notify us of any material error or omission caused by our negligence, provided, however, that such notice shall be in writing and shall specifically address the issue you wish to raise. A failure to raise such issue within the prescribed time shall constitute your unqualified acceptance of the completeness of this report, the tests conducted and the correctness of the report contents. Unless specific mention, the uncertainty of measurement has been explicitly taken into account to declare the compliance or non-compliance to the specification.

Table of Contents

Release Control Record	3
1 Certificate of Conformity	4
2 Summary of Test Results	5
2.1 Measurement Uncertainty	5
2.2 Modification Record	5
3 General Information	6
3.1 General Description of EUT	6
3.1.1 Test Mode Applicability and Tested Channel Detail	8
3.2 Description of Support Units	11
3.2.1 Configuration of System under Test	11
4 Test Types and Results	12
4.1 Radiated Emission and Bandedge Measurement	13
4.1.1 Limits of Radiated Emission and Bandedge Measurement	13
4.1.2 Test Instruments	15
4.1.3 Test Procedures	17
4.1.4 Deviation from Test Standard	18
4.1.5 Test Setup	18
4.1.6 EUT Operating Conditions	19
4.1.7 Test Results (Mode 1)	20
4.1.8 Test Results (Mode 2)	23
4.1.9 Test Results (Mode 3)	26
4.2 Conducted Emission Measurement	29
4.2.1 Limits of Conducted Emission Measurement	29
4.2.2 Test Instruments	29
4.2.3 Test Procedures	30
4.2.4 Deviation from Test Standard	30
4.2.5 Test Setup	30
4.2.6 EUT Operating Conditions	30
4.2.7 Test Results (Mode 1)	31
4.2.8 Test Results (Mode 2)	33
4.2.9 Test Results (Mode 3)	35
4.3 Conducted Out of Band Emission Measurement	37
4.3.1 Limits of Conducted Out of Band Emission Measurement	37
4.3.2 Test Setup	37
4.3.3 Test Instruments	37
4.3.4 Test Procedures	37
4.3.5 Deviation from Test Standard	37
4.3.6 EUT Operating Conditions	37
4.3.7 Test Results	37
5 Pictures of Test Arrangements	39
Appendix – Information of the Testing Laboratories	40

Release Control Record

Issue No.	Description	Date Issued
RFBDKG-WTW-P20110147-4	Original release.	May 07, 2021

1 Certificate of Conformity

Product: Camera and Speakerphone

Brand: Logitech

Test Model: VR0020

Sample Status: Engineering sample

Applicant: Logitech Far East Ltd

Test Date: Apr. 09 to 16, 2021

Standards: 47 CFR FCC Part 15, Subpart C (Section 15.247)

47 CFR FCC Part 15, Subpart E (Section 15.407)

ANSI C63.10: 2013

The above equipment has been tested by **Bureau Veritas Consumer Products Services (H.K.) Ltd., Taoyuan Branch**, and found compliance with the requirement of the above standards. The test record, data evaluation & Equipment Under Test (EUT) configurations represented herein are true and accurate accounts of the measurements of the sample's EMC characteristics under the conditions specified in this report.

Prepared by : Cherry Chuo , **Date:** May 07, 2021
Cherry Chuo / Specialist

Approved by : Clark Lin , **Date:** May 07, 2021
Clark Lin / Technical Manager

2 Summary of Test Results

FCC Part 15, Subpart C, E (SECTION 15.247, 15.407)			
FCC Clause	Test Item	Result	Remarks
15.207 15.407(b)(6)	AC Power Conducted Emission	PASS	Meet the requirement of limit. Minimum passing margin is -5.01dB at 27.64844MHz.
15.205 / 15.209 / 15.247(d) 15.407(b) (1/2/3/4(i/ii)/6)	Radiated Emissions and Band Edge Measurement	PASS	Meet the requirement of limit. Minimum passing margin is -4.2dB at 32.93MHz, 34.16MHz.
15.247(d)	Antenna Port Emission	PASS	Meet the requirement of limit.

Note:

Determining compliance based on the results of the compliance measurement, not taking into account measurement instrumentation uncertainty.

2.1 Measurement Uncertainty

Where relevant, the following measurement uncertainty levels have been estimated for tests performed on the EUT as specified in CISPR 16-4-2:

Measurement	Frequency	Expanded Uncertainty (k=2) (\pm)
Conducted Emissions at mains ports	150kHz ~ 30MHz	1.9 dB
Radiated Emissions up to 1 GHz	9kHz ~ 30MHz	3.1 dB
	30MHz ~ 1GHz	5.4 dB
Radiated Emissions above 1 GHz	1GHz ~ 18GHz	5.0 dB
	18GHz ~ 40GHz	5.3 dB

2.2 Modification Record

There were no modifications required for compliance.

3 General Information

3.1 General Description of EUT

Product	Camera and Speakerphone
Brand	Logitech
Test Model	VR0020
Status of EUT	Engineering sample
Power Supply Rating	19 Vdc from power adapter
Modulation Type	WLAN: CCK, DQPSK, DBPSK for DSSS 64QAM, 16QAM, QPSK, BPSK for OFDM 256QAM for OFDM in 11ac mode only BT-LE: GFSK
Modulation Technology	WLAN: DSSS, OFDM BT-LE: DTS
Operating Frequency	WLAN: 2.4GHz: 2.412 ~ 2.462GHz 5GHz: 5.18 ~ 5.32GHz, 5.50GHz ~ 5.72GHz, 5.745 ~ 5.825GHz BT-LE: 2.402 ~ 2.480 GHz
Antenna Type	Refer to Note
Antenna Connector	Refer to Note
Accessory Device	Adapter x 1, Remote controller x 1 (Brand: Logitech / Model: RR0016)
Data Cable Supplied	USB Cable x 1 (2.2m, Unshielded), HDMI Cable x 1 (2m, Unshielded)

Note:

1. Simultaneously transmission condition.

Condition	Technology	
1	WLAN (2.4GHz)	WLAN (5GHz)
2	WLAN (2.4GHz)	Bluetooth
3	WLAN (5GHz)	Bluetooth

Note: The emission of the simultaneous operation has been evaluated and no non-compliance was found.

2. The EUT could be supplied with a power adapter as the following table:

Brand	Model No.	Spec.
Logi	DSA-90PFE-19 3 190474	Input: 100-240 Vac, 500 mA, 50-60 Hz, 1.5 A AC input cable: Unshielded, 1 m Output: 19 Vdc, 4.74 A DC output cable: Unshielded, 1.5 m, with one core

3. The antennas provided to the EUT, please refer to the following table:

Antenna No.	RF Chain No.	Brand	Model	Antenna Net Gain (dBi)	Frequency Range (GHz)	Antenna Type	Connector Type	Cable Length (mm)
ANT 0	Chain 0	FIH	PCB	7.35	2.4~2.4835	Monopole	i-pex(MHF)	85
				7.92	5.15~5.25			
				8.71	5.25~5.35			
				8.7	5.47~5.725			
				7.7	5.725~5.85			
ANT 1	Chain 1	FIH	PCB	5.06	2.4~2.4835	Monopole	i-pex(MHF)	100
				7.12	5.15~5.25			
				7.5	5.25~5.35			
				7.02	5.47~5.725			
				6.17	5.725~5.85			

Note: The Bluetooth technology will fix transmission on Chain (0).

4. The EUT incorporates a MIMO function:

2.4GHz Band		
MODULATION MODE	TX & RX CONFIGURATION	
802.11b	2TX	2RX
802.11g	2TX	2RX
802.11n (HT20)	2TX	2RX
802.11n (HT40)	2TX	2RX
5GHz Band		
MODULATION MODE	TX & RX CONFIGURATION	
802.11a	2TX	2RX
802.11n (HT20)	2TX	2RX
802.11n (HT40)	2TX	2RX
802.11ac (VHT20)	2TX	2RX
802.11ac (VHT40)	2TX	2RX
802.11ac (VHT80)	2TX	2RX

Note: The modulation and bandwidth are similar for 802.11n mode for 20MHz (40MHz) and 802.11ac mode for 20MHz (40MHz), therefore the manufacturer will control the power for 802.11n mode is the same as the 802.11ac or more lower than it and investigated worst case to representative mode in test report. (Final test mode refer to section 3.2.1)

5. The above EUT information is declared by manufacturer and for more detailed features description, please refers to the manufacturer's specifications or user's manual.

6. The above Antenna information is declared by manufacturer and for more detailed features description, please refer to the manufacturer's specifications, the laboratory shall not be held responsible.

3.1.1 Test Mode Applicability and Tested Channel Detail

EUT Configure Mode	Applicable To				Description
	RE \geq 1G	RE<1G	PLC	OB	
-	√	√	√	√	-

Where **RE \geq 1G**: Radiated Emission above 1GHz **RE<1G**: Radiated Emission below 1GHz
PLC: Power Line Conducted Emission **OB**: Conducted Out-Band Emission Measurement

Radiated Emission Test (Above 1GHz):

- The tested configurations represent the worst-case mode from all possible combinations by the maximum power.
- Following channel(s) was (were) selected for the final test as listed below.

Configure Mode	MODE	AVAILABLE CHANNEL	TESTED CHANNEL	MODULATION TECHNOLOGY	MODULATION TYPE
1	802.11b + 802.11a	1 to 11	11	DSSS	DBPSK
		36 to 64 100 to 144 149 to 165	149	OFDM	BPSK
2	802.11b + BT-LE	1 to 11	11	DSSS	DBPSK
		0 to 39	39	DTS	GFSK
3	802.11a + BT-LE	36 to 64 100 to 144 149 to 165	149	OFDM	BPSK
		0 to 39	39	DTS	GFSK

Radiated Emission Test (Below 1GHz):

The tested configurations represent the worst-case mode from all possible combinations by the maximum power.

Following channel(s) was (were) selected for the final test as listed below.

Configure Mode	MODE	AVAILABLE CHANNEL	TESTED CHANNEL	MODULATION TECHNOLOGY	MODULATION TYPE
1	802.11b + 802.11a	1 to 11	11	DSSS	DBPSK
		36 to 64 100 to 144 149 to 165	149	OFDM	BPSK
2	802.11b + BT-LE	1 to 11	11	DSSS	DBPSK
		0 to 39	39	DTS	GFSK
3	802.11a + BT-LE	36 to 64 100 to 144 149 to 165	149	OFDM	BPSK
		0 to 39	39	DTS	GFSK

Power Line Conducted Emission Test:

The tested configurations represent the worst-case mode from all possible combinations by the maximum power.

Following channel(s) was (were) selected for the final test as listed below.

Configure Mode	MODE	AVAILABLE CHANNEL	TESTED CHANNEL	MODULATION TECHNOLOGY	MODULATION TYPE
1	802.11b + 802.11a	1 to 11	11	DSSS	DBPSK
		36 to 64 100 to 144 149 to 165	149	OFDM	BPSK
2	802.11b + BT-LE	1 to 11	11	DSSS	DBPSK
		0 to 39	39	DTS	GFSK
3	802.11a + BT-LE	36 to 64 100 to 144 149 to 165	149	OFDM	BPSK
		0 to 39	39	DTS	GFSK

Conducted Out-Band Emission Measurement:

The tested configurations represent the worst-case mode from all possible combinations by the maximum power.

Following channel(s) was (were) selected for the final test as listed below.

Configure Mode	MODE	AVAILABLE CHANNEL	TESTED CHANNEL	MODULATION TECHNOLOGY	MODULATION TYPE
1	802.11b + 802.11a	1 to 11	11	DSSS	DBPSK
		36 to 64 100 to 144 149 to 165	149	OFDM	BPSK
2	802.11b + BT-LE	1 to 11	11	DSSS	DBPSK
		0 to 39	39	DTS	GFSK
3	802.11a + BT-LE	36 to 64 100 to 144 149 to 165	149	OFDM	BPSK
		0 to 39	39	DTS	GFSK

Test Condition:

Applicable To	Environmental Conditions	Input Power	Tested By
RE \geq 1G	25deg. C, 75%RH	120Vac, 60Hz	Carter Lin
RE<1G	22deg. C, 66%RH	120Vac, 60Hz	Sampson Chen
PLC	25deg. C, 75%RH	120Vac, 60Hz	Sampson Chen
OB	25deg. C, 60%RH	120Vac, 60Hz	Eric Peng

3.2 Description of Support Units

The EUT has been tested as an independent unit together with other necessary accessories or support units. The following support units or accessories were used to form a representative test configuration during the tests.

ID	Product	Brand	Model No.	Serial No.	FCC ID	Remarks
A.	MIC POD	Logitech	V-U0049	NA	NA	Supplied by client
B.	TAP Touch Controller	Logitech	V-U0053	NA	NA	Supplied by client
C.	Dongle	SanDisk	Ultra Flair USB 3.0	NA	NA	Provided by Lab
D.	Dongle	SanDisk	Ultra Flair USB 3.0	NA	NA	Provided by Lab
E.	Laptop	Lenovo	20U5S01X00 L14	PF-28LKK7	NA	Provided by Lab
F.	Monitor	DELL	P2415Q	CN-0J1P7F-QDC00-8 5L-13GB-A09	FCC DoC	Provided by Lab
G.	Monitor	NEOKA	NA	NA	NA	Provided by Lab
H.	Laptop	Lenovo	20U5S01X00 L14	PF-1ANPYA	NA	Provided by Lab

Note:

1. All power cords of the above support units are non-shielded (1.8m).

ID	Descriptions	Qty.	Length (m)	Shielding (Yes/No)	Cores (Qty.)	Remarks
1.	DC Cable	1	1.5	No	1	Supplied by client
2.	Micro USB Cable	1	3	No	0	Supplied by client
3.	USB A to Type C Cable	1	2.2	No	0	Supplied by client
4.	USB A to Type C Cable	1	2.2	No	0	Supplied by client
5.	HDMI Cable	1	1.8	No	0	Supplied by client
6.	HDMI Cable	1	1.8	No	0	Supplied by client
7.	HDMI Cable	1	1.8	No	0	Supplied by client
8.	RJ-45 Cable	1	10	No	0	Provided by Lab
9.	AC Cable	1	1	No	0	Supplied by client

Note: The core(s) is(are) originally attached to the cable(s).

3.2.1 Configuration of System under Test

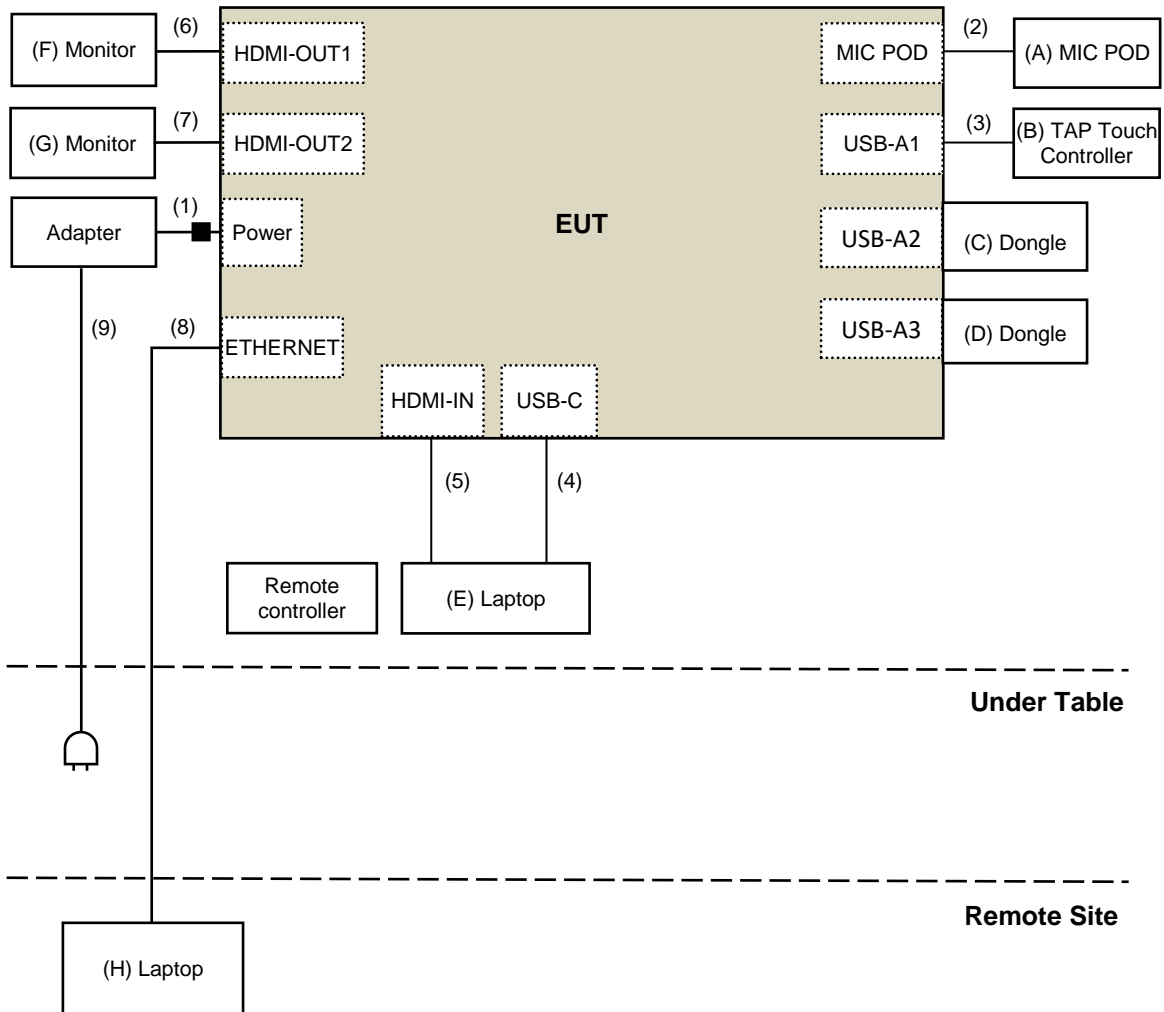

4 Test Types and Results

4.1 Radiated Emission and Bandedge Measurement

4.1.1 Limits of Radiated Emission and Bandedge Measurement

Radiated emissions which fall in the restricted bands must comply with the radiated emission limits specified as below table.

Frequencies (MHz)	Field Strength (microvolts/meter)	Measurement Distance (meters)
0.009 ~ 0.490	2400/F(kHz)	300
0.490 ~ 1.705	24000/F(kHz)	30
1.705 ~ 30.0	30	30
30 ~ 88	100	3
88 ~ 216	150	3
216 ~ 960	200	3
Above 960	500	3

Note:

1. The lower limit shall apply at the transition frequencies.
2. Emission level (dBuV/m) = 20 log Emission level (uV/m).
3. For frequencies above 1000MHz, the field strength limits are based on average detector, however, the peak field strength of any emission shall not exceed the maximum permitted average limits, specified above by more than 20dB under any condition of modulation.

Limits of unwanted emission out of the restricted bands

Applicable To		Limit	
789033 D02 General UNII Test Procedure New Rules v02r01		Field Strength at 3m	
		PK:74 (dBμV/m)	AV:54 (dBμV/m)
Frequency Band	Applicable To	EIRP Limit	Equivalent Field Strength at 3m
5150~5250 MHz	15.407(b)(1)	PK:-27 (dBm/MHz)	PK:68.2(dBμV/m)
5250~5350 MHz	15.407(b)(2)		
5470~5725 MHz	15.407(b)(3)		
5725~5850 MHz	15.407(b)(4)(i)	PK:-27 (dBm/MHz) ^{*1} PK:10 (dBm/MHz) ^{*2} PK:15.6 (dBm/MHz) ^{*3} PK:27 (dBm/MHz) ^{*4}	PK: 68.2(dBμV/m) ^{*1} PK:105.2 (dBμV/m) ^{*2} PK: 110.8(dBμV/m) ^{*3} PK:122.2 (dBμV/m) ^{*4}
	15.407(b)(4)(ii)	Emission limits in section 15.247(d)	
*1 beyond 75 MHz or more above of the band edge.		*2 below the band edge increasing linearly to 10 dBm/MHz at 25 MHz above.	
*3 below the band edge increasing linearly to a level of 15.6 dBm/MHz at 5 MHz above.		*4 from 5 MHz above or below the band edge increasing linearly to a level of 27 dBm/MHz at the band edge.	

Frequencies (MHz)	EIRP Limit	Equivalent Field Strength at 3m
5925MHz > F > 7125MHz	Peak:-7 (dBm/MHz)	88.2(dBμV/m)

Note:

The following formula is used to convert the equipment isotropic radiated power (eirp) to field strength:

$$E = \frac{1000000\sqrt{30P}}{3} \mu\text{V/m, where } P \text{ is the eirp (Watts).}$$

4.1.2 Test Instruments

For Radiated Emission Test:

DESCRIPTION & MANUFACTURER	MODEL NO.	SERIAL NO.	CALIBRATED DATE	CALIBRATED UNTIL
Test Receiver Keysight	N9038A	MY54450088	July 06, 2020	July 05, 2021
Pre-Amplifier EMCI	EMC001340	980142	May 25, 2020	May 24, 2021
Loop Antenna Electro-Metrics	EM-6879	264	Mar. 05, 2021	Mar. 04, 2022
RF Cable	5D-FB	LOOPCAB-001	Jan. 07, 2021	Jan. 06, 2022
RF Cable	5D-FB	LOOPCAB-002	Jan. 07, 2021	Jan. 06, 2022
Pre-Amplifier Mini-Circuits	ZFL-1000VH2	QA0838008	Oct. 20, 2020	Oct. 19, 2021
Trilog Broadband Antenna SCHWARZBECK	VULB 9168	9168-361	Nov. 05, 2020	Nov. 04, 2021
RF Cable	8D	966-3-1	Mar. 16, 2021	Mar. 15, 2022
RF Cable	8D	966-3-2	Mar. 16, 2021	Mar. 15, 2022
RF Cable	8D	966-3-3	Mar. 16, 2021	Mar. 15, 2022
Fixed attenuator Mini-Circuits	UNAT-5+	PAD-3m-3-01	Sep. 24, 2020	Sep. 23, 2021
Horn_Antenna SCHWARZBECK	BBHA9120-D	9120D-406	Nov. 22, 2020	Nov. 21, 2021
Pre-Amplifier EMCI	EMC12630SE	980384	Jan. 11, 2021	Jan. 10, 2022
RF Cable	EMC104-SM-SM-1500	180504	Apr. 29, 2020	Apr. 28, 2021
RF Cable	EMC104-SM-SM-2000	180601	June 09, 2020	June 08, 2021
RF Cable	EMC104-SM-SM-6000	180602	June 09, 2020	June 08, 2021
Spectrum Analyzer Keysight	N9030A	MY54490679	July 13, 2020	July 12, 2021
Pre-Amplifier EMCI	EMC184045SE	980387	Jan. 11, 2021	Jan. 10, 2022
Horn_Antenna SCHWARZBECK	BBHA 9170	BBHA9170519	Nov. 22, 2020	Nov. 21, 2021
RF Cable	EMC102-KM-KM-1200	160924	Jan. 11, 2021	Jan. 10, 2022
RF Cable	EMC-KM-KM-4000	200214	Mar. 10, 2021	Mar. 09, 2022
Software	ADT_Radiated_V8.7.08	NA	NA	NA
Antenna Tower & Turn Table Max-Full	MF-7802	MF780208406	NA	NA
Boresight Antenna Fixture	FBA-01	FBA-SIP01	NA	NA

Note:

1. The calibration interval of the above test instruments is 12 months and the calibrations are traceable to NML/ROC and NIST/USA.
2. The test was performed in 966 Chamber No. 3.
3. Tested Date: Apr. 09 to 16, 2021

For other test items:

DESCRIPTION & MANUFACTURER	MODEL NO.	SERIAL NO.	CALIBRATED DATE	CALIBRATED UNTIL
Spectrum Analyzer R&S	FSV40	100964	May 29, 2020	May 28, 2021
Fixed Attenuator Mini-Circuits	MDCS18N-10	MDCS18N-10-01	Apr. 14, 2020	Apr. 13, 2021
Software	ADT_RF Test Software V6.6.5.4	NA	NA	NA

- NOTE:**
1. The test was performed in Oven room 2.
 2. The calibration interval of the above test instruments is 12 months and the calibrations are traceable to NML/ROC and NIST/USA.
 3. Tested Date: Mar. 15, 2021

4.1.3 Test Procedures

For Radiated emission below 30MHz

- a. The EUT was placed on the top of a rotating table 0.8 meters above the ground at a 3 meter chamber room. The table was rotated 360 degrees to determine the position of the highest radiation.
- b. The EUT was set 3 meters away from the interference-receiving antenna, which was mounted on the top of a variable-height antenna tower.
- c. Parallel, perpendicular, and ground-parallel orientations of the antenna are set to make the measurement.
- d. For each suspected emission, the EUT was arranged to its worst case and the rotatable table was turned from 0 degrees to 360 degrees to find the maximum reading.
- e. The test-receiver system was set to Quasi-Peak Detect Function and Specified Bandwidth with Maximum Hold Mode.

NOTE:

1. The resolution bandwidth and video bandwidth of test receiver/spectrum analyzer is 9kHz at frequency below 30MHz.

For Radiated emission above 30MHz

- a. The EUT was placed on the top of a rotating table 0.8 meters (for 30MHz ~ 1GHz) / 1.5 meters (for above 1GHz) above the ground at 3 meter chamber room for test. The table was rotated 360 degrees to determine the position of the highest radiation.
- b. The EUT was set 3 meters away from the interference-receiving antenna, which was mounted on the top of a variable-height antenna tower.
- c. The height of antenna is varied from one meter to four meters above the ground to determine the maximum value of the field strength. Both horizontal and vertical polarizations of the antenna are set to make the measurement.
- d. For each suspected emission, the EUT was arranged to its worst case and then the antenna was tuned to heights from 1 meter to 4 meters and the rotatable table was turned from 0 degrees to 360 degrees to find the maximum reading.
- e. The test-receiver system was set to quasi-peak detect function and specified bandwidth with maximum hold mode when the test frequency is below 1 GHz.
- f. The test-receiver system was set to peak and average detects function and specified bandwidth with maximum hold mode when the test frequency is above 1 GHz. If the peak reading value also meets average limit, measurement with the average detector is unnecessary.

Note:

1. The resolution bandwidth and video bandwidth of test receiver/spectrum analyzer is 120kHz for Quasi-peak detection (QP) at frequency below 1GHz.
2. The resolution bandwidth of test receiver/spectrum analyzer is 1 MHz and the video bandwidth is 3 MHz for Peak detection (PK) at frequency above 1GHz.
3. The resolution bandwidth of test receiver/spectrum analyzer is 1MHz and the video bandwidth is $\geq 1/T$ (Duty cycle < 98%) or 10Hz (Duty cycle $\geq 98\%$) for Average detection (AV) at frequency above 1GHz.
4. All modes of operation were investigated and the worst-case emissions are reported.

4.1.4 Deviation from Test Standard

No deviation.

4.1.5 Test Setup

For Radiated emission below 30MHz

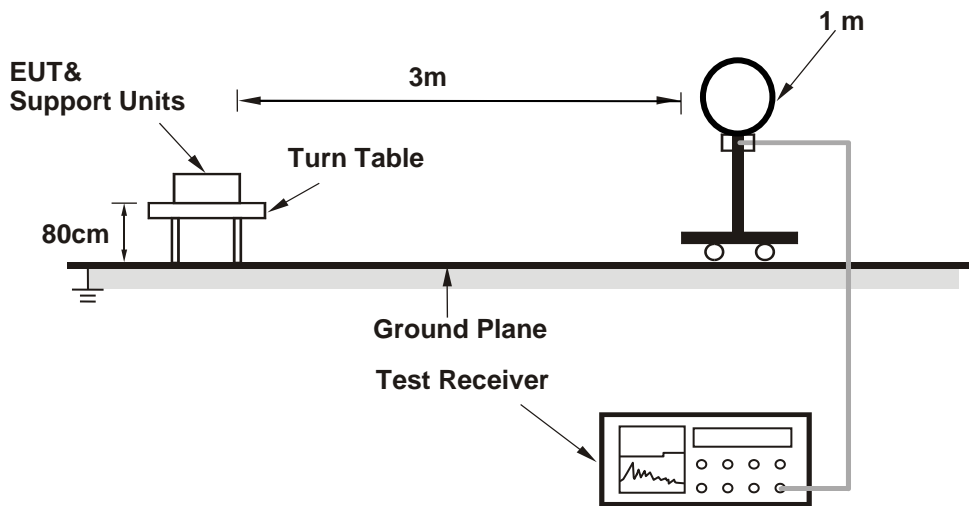

For Radiated emission 30MHz to 1GHz

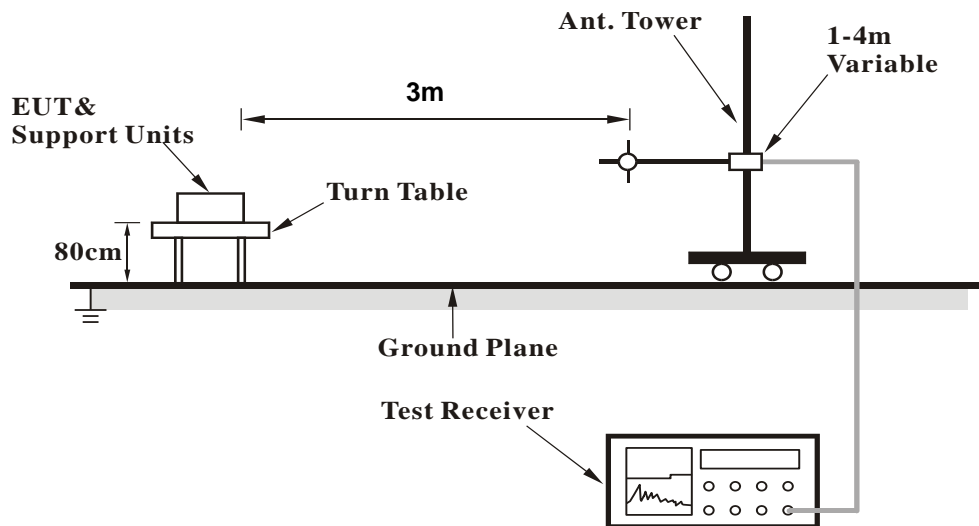

For Radiated emission above 1GHz

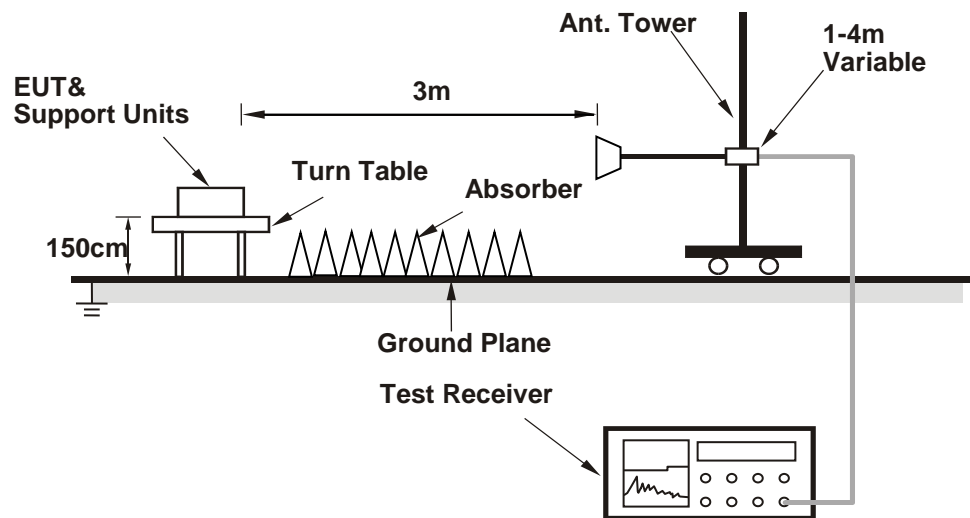

For the actual test configuration, please refer to the attached file (Test Setup Photo).

4.1.6 EUT Operating Conditions

- Placed the EUT on the testing table.
- Controlling software (QDART_Version 4.0.00156.0) has been activated to set the EUT under transmission condition continuously at specific channel frequency.

4.1.7 Test Results (Mode 1)

Above 1GHz Data:

FREQUENCY RANGE	1GHz ~ 40GHz	DETECTOR FUNCTION	Peak (PK) Average (AV)
------------------------	--------------	--------------------------	---------------------------

Antenna Polarity & Test Distance : Horizontal at 3 m								
No	Frequency (MHz)	Emission Level (dBuV/m)	Limit (dBuV/m)	Margin (dB)	Antenna Height (m)	Table Angle (Degree)	Raw Value (dBuV)	Correction Factor (dB/m)
1	4924.00	50.4 PK	74.0	-23.6	1.97 H	151	46.2	4.2
2	4924.00	49.6 AV	54.0	-4.4	1.97 H	151	45.4	4.2
3	7386.00	50.1 PK	74.0	-23.9	2.07 H	236	39.8	10.3
4	7386.00	46.2 AV	54.0	-7.8	2.07 H	236	35.9	10.3
5	11570.00	58.4 PK	74.0	-15.6	1.59 H	201	43.5	14.9
6	11570.00	48.3 AV	54.0	-5.7	1.59 H	201	33.4	14.9
7	#17355.00	52.8 PK	68.2	-15.4	1.75 H	198	33.9	18.9

Antenna Polarity & Test Distance : Vertical at 3 m								
No	Frequency (MHz)	Emission Level (dBuV/m)	Limit (dBuV/m)	Margin (dB)	Antenna Height (m)	Table Angle (Degree)	Raw Value (dBuV)	Correction Factor (dB/m)
1	4924.00	48.1 PK	74.0	-25.9	1.58 V	312	43.9	4.2
2	4924.00	46.0 AV	54.0	-8.0	1.58 V	312	41.8	4.2
3	7386.00	49.7 PK	74.0	-24.3	2.35 V	206	39.4	10.3
4	7386.00	44.6 AV	54.0	-9.4	2.35 V	206	34.3	10.3
5	11570.00	61.5 PK	74.0	-12.5	2.11 V	215	46.6	14.9
6	11570.00	49.5 AV	54.0	-4.5	2.11 V	215	34.6	14.9
7	#17355.00	54.9 PK	68.2	-13.3	2.10 V	242	36.0	18.9

Remarks:

1. Emission Level(dBuV/m) = Raw Value(dBuV) + Correction Factor(dB/m)
2. Correction Factor(dB/m) = Antenna Factor(dB/m) + Cable Factor(dB) – Pre-Amplifier Factor(dB)
3. Margin value = Emission Level – Limit value
4. The other emission levels were very low against the limit.
5. " # ": The radiated frequency is out of the restricted band.

Below 1GHz Data:

FREQUENCY RANGE	9kHz ~ 1GHz	DETECTOR FUNCTION	Quasi-Peak (QP)
------------------------	-------------	--------------------------	-----------------

Antenna Polarity & Test Distance : Horizontal at 3 m								
No	Frequency (MHz)	Emission Level (dBuV/m)	Limit (dBuV/m)	Margin (dB)	Antenna Height (m)	Table Angle (Degree)	Raw Value (dBuV)	Correction Factor (dB/m)
1	74.91	35.5 QP	40.0	-4.5	3.00 H	101	47.1	-11.6
2	145.19	39.1 QP	43.5	-4.4	2.00 H	159	46.8	-7.7
3	256.67	41.0 QP	46.0	-5.0	1.00 H	240	49.4	-8.4
4	493.17	41.2 QP	46.0	-4.8	2.00 H	311	42.4	-1.2
5	589.47	41.2 QP	46.0	-4.8	1.50 H	57	40.3	0.9
6	912.13	41.1 QP	46.0	-4.9	1.50 H	211	33.9	7.2

Remarks:

1. Emission Level(dBuV/m) = Raw Value(dBuV) + Correction Factor(dB/m)
2. Correction Factor(dB/m) = Antenna Factor(dB/m) + Cable Factor(dB) – Pre-Amplifier Factor(dB)
3. Margin value = Emission Level – Limit value
4. The other emission levels were very low against the limit of frequency range 30MHz~1000MHz.
5. The emission levels were very low against the limit of frequency range 9kHz~30MHz: the amplitude of spurious emissions attenuated more than 20 dB below the permissible value to be report.

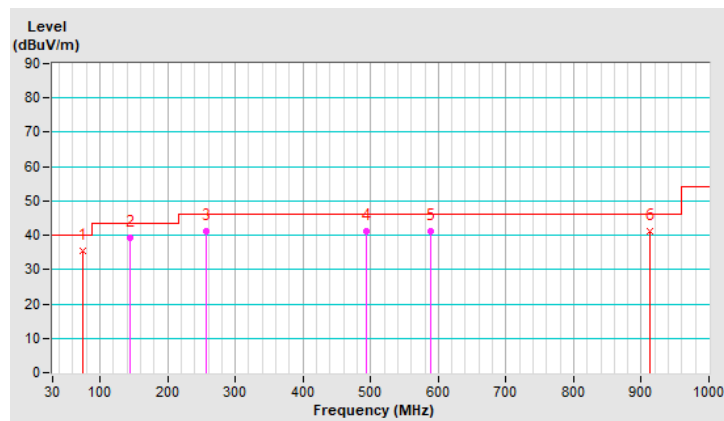

FREQUENCY RANGE	9kHz ~ 1GHz	DETECTOR FUNCTION	Quasi-Peak (QP)
------------------------	-------------	--------------------------	-----------------

Antenna Polarity & Test Distance : Vertical at 3 m								
No	Frequency (MHz)	Emission Level (dBuV/m)	Limit (dBuV/m)	Margin (dB)	Antenna Height (m)	Table Angle (Degree)	Raw Value (dBuV)	Correction Factor (dB/m)
1	32.93	35.8 QP	40.0	-4.2	1.00 V	317	45.2	-9.4
2	73.97	35.3 QP	40.0	-4.7	3.00 V	144	46.8	-11.5
3	258.31	39.5 QP	46.0	-6.5	2.00 V	15	47.8	-8.3
4	293.67	40.1 QP	46.0	-5.9	1.50 V	351	46.9	-6.8
5	490.08	40.0 QP	46.0	-6.0	1.00 V	147	41.3	-1.3
6	920.16	41.5 QP	46.0	-4.5	1.00 V	207	34.4	7.1

Remarks:

1. Emission Level(dBuV/m) = Raw Value(dBuV) + Correction Factor(dB/m)
2. Correction Factor(dB/m) = Antenna Factor(dB/m) + Cable Factor(dB) – Pre-Amplifier Factor(dB)
3. Margin value = Emission Level – Limit value
4. The other emission levels were very low against the limit of frequency range 30MHz~1000MHz.
5. The emission levels were very low against the limit of frequency range 9kHz~30MHz: the amplitude of spurious emissions attenuated more than 20 dB below the permissible value to be report.

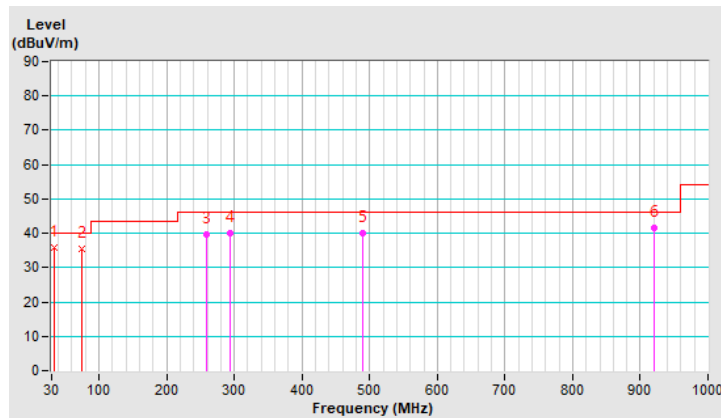

4.1.8 Test Results (Mode 2)

Above 1GHz Data:

FREQUENCY RANGE	1GHz ~ 25GHz	DETECTOR FUNCTION	Peak (PK) Average (AV)
------------------------	--------------	--------------------------	---------------------------

Antenna Polarity & Test Distance : Horizontal at 3 m								
No	Frequency (MHz)	Emission Level (dBuV/m)	Limit (dBuV/m)	Margin (dB)	Antenna Height (m)	Table Angle (Degree)	Raw Value (dBuV)	Correction Factor (dB/m)
1	4924.00	50.3 PK	74.0	-23.7	2.05 H	158	46.1	4.2
2	4924.00	49.4 AV	54.0	-4.6	2.05 H	158	45.2	4.2
3	4960.00	40.0 PK	74.0	-34.0	1.81 H	269	35.5	4.5
4	4960.00	27.3 AV	54.0	-26.7	1.81 H	269	22.8	4.5
5	7386.00	51.0 PK	74.0	-23.0	2.03 H	209	40.7	10.3
6	7386.00	47.5 AV	54.0	-6.5	2.03 H	209	37.2	10.3
7	7440.00	45.1 PK	74.0	-28.9	1.72 H	267	34.8	10.3
8	7440.00	32.8 AV	54.0	-21.2	1.72 H	267	22.5	10.3
Antenna Polarity & Test Distance : Vertical at 3 m								
No	Frequency (MHz)	Emission Level (dBuV/m)	Limit (dBuV/m)	Margin (dB)	Antenna Height (m)	Table Angle (Degree)	Raw Value (dBuV)	Correction Factor (dB/m)
1	4924.00	46.4 PK	74.0	-27.6	1.59 V	302	42.2	4.2
2	4924.00	44.7 AV	54.0	-9.3	1.59 V	302	40.5	4.2
3	4960.00	38.1 PK	74.0	-35.9	1.23 V	206	33.6	4.5
4	4960.00	27.9 AV	54.0	-26.1	1.23 V	206	23.4	4.5
5	7386.00	51.1 PK	74.0	-22.9	2.27 V	197	40.8	10.3
6	7386.00	45.8 AV	54.0	-8.2	2.27 V	197	35.5	10.3
7	7440.00	42.3 PK	74.0	-31.7	1.75 V	228	32.0	10.3
8	7440.00	30.9 AV	54.0	-23.1	1.75 V	228	20.6	10.3

Remarks:

1. Emission Level(dBuV/m) = Raw Value(dBuV) + Correction Factor(dB/m)
2. Correction Factor(dB/m) = Antenna Factor(dB/m) + Cable Factor(dB) – Pre-Amplifier Factor(dB)
3. Margin value = Emission Level – Limit value
4. The other emission levels were very low against the limit.

Below 1GHz Data:

FREQUENCY RANGE	9kHz ~ 1GHz	DETECTOR FUNCTION	Quasi-Peak (QP)
------------------------	-------------	--------------------------	-----------------

Antenna Polarity & Test Distance : Horizontal at 3 m								
No	Frequency (MHz)	Emission Level (dBuV/m)	Limit (dBuV/m)	Margin (dB)	Antenna Height (m)	Table Angle (Degree)	Raw Value (dBuV)	Correction Factor (dB/m)
1	76.50	35.4 QP	40.0	-4.6	3.00 H	105	47.5	-12.1
2	143.27	38.1 QP	43.5	-5.4	2.00 H	151	45.9	-7.8
3	258.87	39.7 QP	46.0	-6.3	1.00 H	241	48.0	-8.3
4	491.98	41.1 QP	46.0	-4.9	2.00 H	305	42.3	-1.2
5	590.27	40.3 QP	46.0	-5.7	1.50 H	57	39.3	1.0
6	912.05	41.0 QP	46.0	-5.0	1.50 H	211	33.8	7.2

Remarks:

1. Emission Level(dBuV/m) = Raw Value(dBuV) + Correction Factor(dB/m)
2. Correction Factor(dB/m) = Antenna Factor(dB/m) + Cable Factor(dB) – Pre-Amplifier Factor(dB)
3. Margin value = Emission Level – Limit value
4. The other emission levels were very low against the limit of frequency range 30MHz~1000MHz.
5. The emission levels were very low against the limit of frequency range 9kHz~30MHz: the amplitude of spurious emissions attenuated more than 20 dB below the permissible value to be report.

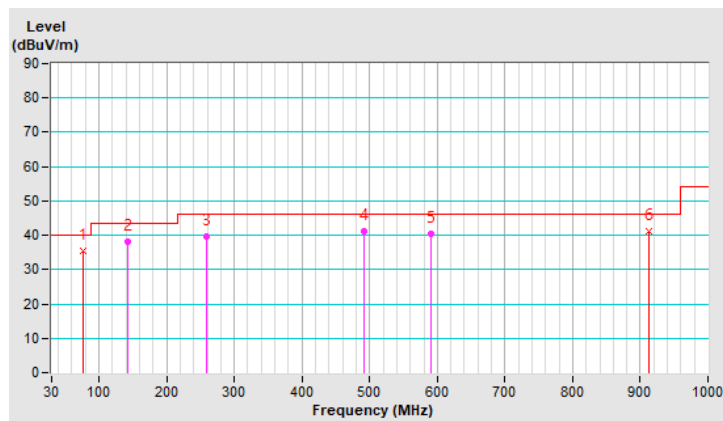

FREQUENCY RANGE	9kHz ~ 1GHz	DETECTOR FUNCTION	Quasi-Peak (QP)
------------------------	-------------	--------------------------	-----------------

Antenna Polarity & Test Distance : Vertical at 3 m								
No	Frequency (MHz)	Emission Level (dBuV/m)	Limit (dBuV/m)	Margin (dB)	Antenna Height (m)	Table Angle (Degree)	Raw Value (dBuV)	Correction Factor (dB/m)
1	33.49	35.3 QP	40.0	-4.7	1.00 V	315	44.5	-9.2
2	75.08	35.5 QP	40.0	-4.5	3.00 V	145	47.1	-11.6
3	258.29	39.9 QP	46.0	-6.1	2.00 V	33	48.2	-8.3
4	294.47	40.0 QP	46.0	-6.0	1.50 V	350	46.8	-6.8
5	491.11	40.5 QP	46.0	-5.5	1.00 V	164	41.8	-1.3
6	921.01	40.1 QP	46.0	-5.9	1.00 V	221	32.9	7.2

Remarks:

1. Emission Level(dBuV/m) = Raw Value(dBuV) + Correction Factor(dB/m)
2. Correction Factor(dB/m) = Antenna Factor(dB/m) + Cable Factor(dB) – Pre-Amplifier Factor(dB)
3. Margin value = Emission Level – Limit value
4. The other emission levels were very low against the limit of frequency range 30MHz~1000MHz.
5. The emission levels were very low against the limit of frequency range 9kHz~30MHz: the amplitude of spurious emissions attenuated more than 20 dB below the permissible value to be report.

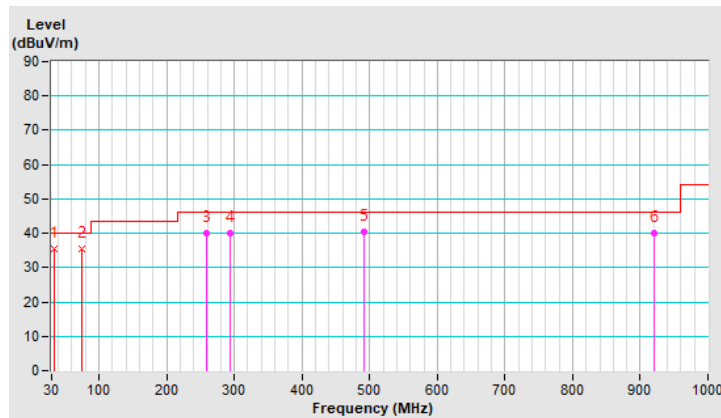

4.1.9 Test Results (Mode 3)

Above 1GHz Data:

FREQUENCY RANGE	1GHz ~ 25GHz	DETECTOR FUNCTION	Peak (PK) Average (AV)
------------------------	--------------	--------------------------	---------------------------

Antenna Polarity & Test Distance : Horizontal at 3 m								
No	Frequency (MHz)	Emission Level (dBuV/m)	Limit (dBuV/m)	Margin (dB)	Antenna Height (m)	Table Angle (Degree)	Raw Value (dBuV)	Correction Factor (dB/m)
1	4960.00	39.9 PK	74.0	-34.1	1.85 H	272	35.4	4.5
2	4960.00	26.9 AV	54.0	-27.1	1.85 H	272	22.4	4.5
3	7440.00	45.3 PK	74.0	-28.7	1.64 H	285	35.0	10.3
4	7440.00	32.5 AV	54.0	-21.5	1.64 H	285	22.2	10.3
5	11570.00	58.8 PK	74.0	-15.2	1.73 H	191	43.9	14.9
6	11570.00	49.2 AV	54.0	-4.8	1.73 H	191	34.3	14.9
7	#17355.00	51.9 PK	68.2	-16.3	1.84 H	238	33.0	18.9
Antenna Polarity & Test Distance : Vertical at 3 m								
No	Frequency (MHz)	Emission Level (dBuV/m)	Limit (dBuV/m)	Margin (dB)	Antenna Height (m)	Table Angle (Degree)	Raw Value (dBuV)	Correction Factor (dB/m)
1	4960.00	37.5 PK	74.0	-36.5	1.25 V	178	33.0	4.5
2	4960.00	27.2 AV	54.0	-26.8	1.25 V	178	22.7	4.5
3	7440.00	43.1 PK	74.0	-30.9	1.88 V	250	32.8	10.3
4	7440.00	31.5 AV	54.0	-22.5	1.88 V	250	21.2	10.3
5	11570.00	61.6 PK	74.0	-12.4	2.08 V	188	46.7	14.9
6	11570.00	49.4 AV	54.0	-4.6	2.08 V	188	34.5	14.9
7	#17355.00	55.1 PK	68.2	-13.1	2.19 V	222	36.2	18.9

Remarks:

1. Emission Level(dBuV/m) = Raw Value(dBuV) + Correction Factor(dB/m)
2. Correction Factor(dB/m) = Antenna Factor(dB/m) + Cable Factor(dB) – Pre-Amplifier Factor(dB)
3. Margin value = Emission Level – Limit value
4. The other emission levels were very low against the limit.
5. " # ": The radiated frequency is out of the restricted band.

Below 1GHz Data:

FREQUENCY RANGE	9kHz ~ 1GHz	DETECTOR FUNCTION	Quasi-Peak (QP)
------------------------	-------------	--------------------------	-----------------

Antenna Polarity & Test Distance : Horizontal at 3 m								
No	Frequency (MHz)	Emission Level (dBUV/m)	Limit (dBUV/m)	Margin (dB)	Antenna Height (m)	Table Angle (Degree)	Raw Value (dBUV)	Correction Factor (dB/m)
1	76.68	35.4 QP	40.0	-4.6	3.00 H	98	47.6	-12.2
2	142.21	38.2 QP	43.5	-5.3	2.00 H	147	46.1	-7.9
3	260.98	39.5 QP	46.0	-6.5	1.00 H	231	47.7	-8.2
4	492.17	41.4 QP	46.0	-4.6	2.00 H	310	42.6	-1.2
5	590.12	40.7 QP	46.0	-5.3	1.50 H	55	39.7	1.0
6	912.01	41.4 QP	46.0	-4.6	1.50 H	205	34.2	7.2

Remarks:

1. Emission Level(dBUV/m) = Raw Value(dBUV) + Correction Factor(dB/m)
2. Correction Factor(dB/m) = Antenna Factor(dB/m) + Cable Factor(dB) – Pre-Amplifier Factor(dB)
3. Margin value = Emission Level – Limit value
4. The other emission levels were very low against the limit of frequency range 30MHz~1000MHz.
5. The emission levels were very low against the limit of frequency range 9kHz~30MHz: the amplitude of spurious emissions attenuated more than 20 dB below the permissible value to be report.

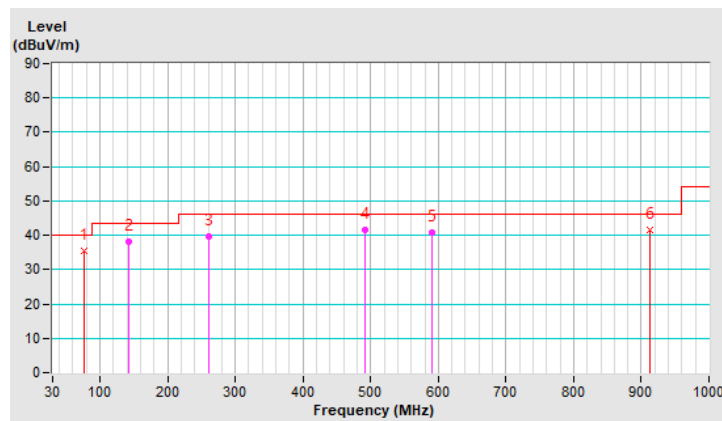

FREQUENCY RANGE	9kHz ~ 1GHz	DETECTOR FUNCTION	Quasi-Peak (QP)
------------------------	-------------	--------------------------	-----------------

Antenna Polarity & Test Distance : Vertical at 3 m								
No	Frequency (MHz)	Emission Level (dBUV/m)	Limit (dBUV/m)	Margin (dB)	Antenna Height (m)	Table Angle (Degree)	Raw Value (dBUV)	Correction Factor (dB/m)
1	34.16	35.8 QP	40.0	-4.2	1.00 V	319	44.9	-9.1
2	75.68	35.6 QP	40.0	-4.4	3.00 V	144	47.5	-11.9
3	257.78	40.1 QP	46.0	-5.9	2.00 V	46	48.4	-8.3
4	295.57	40.2 QP	46.0	-5.8	1.50 V	355	47.0	-6.8
5	492.07	40.8 QP	46.0	-5.2	1.00 V	167	42.0	-1.2
6	923.37	40.4 QP	46.0	-5.6	1.00 V	201	33.2	7.2

Remarks:

1. Emission Level(dBuV/m) = Raw Value(dBuV) + Correction Factor(dB/m)
2. Correction Factor(dB/m) = Antenna Factor(dB/m) + Cable Factor(dB) – Pre-Amplifier Factor(dB)
3. Margin value = Emission Level – Limit value
4. The other emission levels were very low against the limit of frequency range 30MHz~1000MHz.
5. The emission levels were very low against the limit of frequency range 9kHz~30MHz: the amplitude of spurious emissions attenuated more than 20 dB below the permissible value to be report.

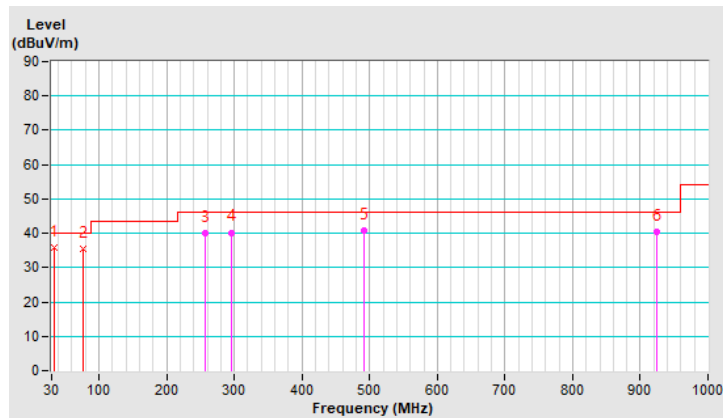

4.2 Conducted Emission Measurement

4.2.1 Limits of Conducted Emission Measurement

Frequency (MHz)	Conducted Limit (dBuV)	
	Quasi-peak	Average
0.15 - 0.5	66 - 56	56 - 46
0.50 - 5.0	56	46
5.0 - 30.0	60	50

Note: 1. The lower limit shall apply at the transition frequencies.

2. The limit decreases in line with the logarithm of the frequency in the range of 0.15 to 0.50MHz.

4.2.2 Test Instruments

DESCRIPTION & MANUFACTURER	MODEL NO.	SERIAL NO.	CALIBRATED DATE	CALIBRATED UNTIL
Test Receiver R&S	ESCS 30	847124/029	Oct. 20, 2020	Oct. 19, 2021
Line-Impedance Stabilization Network (for EUT) R&S	ESH3-Z5	848773/004	Oct. 27, 2020	Oct. 26, 2021
Line-Impedance Stabilization Network (for Peripheral) R&S	ESH3-Z5	835239/001	Mar. 26, 2021	Mar. 25, 2022
50 ohms Terminator	50	3	Oct. 26, 2020	Oct. 25, 2021
RF Cable	5D-FB	COCCAB-001	Sep. 26, 2020	Sep. 25, 2021
Fixed attenuator EMCI	STI02-2200-10	005	Aug. 29, 2020	Aug. 28, 2021
Software BVADT	BVADT_Cond_ V7.3.7.4	NA	NA	NA

Note:

1. The calibration interval of the above test instruments are 12 months and the calibrations are traceable to NML/ROC and NIST/USA.
2. The test was performed in Conduction 1.
3. Tested Date: Apr. 09, 2021

4.2.3 Test Procedures

- The EUT was placed 0.4 meters from the conducting wall of the shielded room with EUT being connected to the power mains through a line impedance stabilization network (LISN). Other support units were connected to the power mains through another LISN. The two LISNs provide 50 ohm/ 50uH of coupling impedance for the measuring instrument.
- Both lines of the power mains connected to the EUT were checked for maximum conducted interference.
- The frequency range from 150kHz to 30MHz was searched. Emission levels under (Limit - 20dB) was not recorded.

Note: The resolution bandwidth and video bandwidth of test receiver is 9kHz for quasi-peak detection (QP) and average detection (AV) at frequency 0.15MHz-30MHz.

4.2.4 Deviation from Test Standard

No deviation.

4.2.5 Test Setup

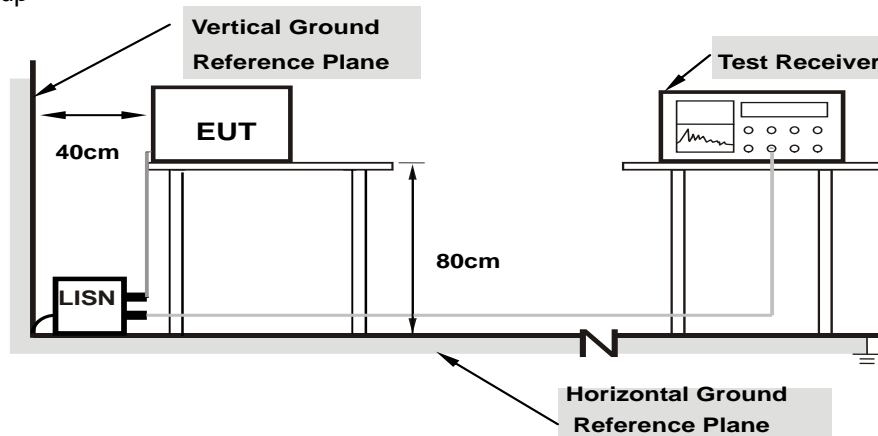

Note: 1.Support units were connected to second LISN.

For the actual test configuration, please refer to the attached file (Test Setup Photo).

4.2.6 EUT Operating Conditions

Same as 4.1.6.

4.2.7 Test Results (Mode 1)

Phase	Line (L)	Detector Function	Quasi-Peak (QP) / Average (AV)
-------	----------	-------------------	--------------------------------

Phase Of Power : Line (L)										
No	Frequency (MHz)	Correction Factor (dB)	Reading Value (dBuV)		Emission Level (dBuV)		Limit (dBuV)		Margin (dB)	
			Q.P.	AV.	Q.P.	AV.	Q.P.	AV.	Q.P.	AV.
1	0.16172	9.95	23.90	18.38	33.85	28.33	65.38	55.38	-31.53	-27.05
2	0.24375	9.97	22.88	13.27	32.85	23.24	61.97	51.97	-29.12	-28.73
3	0.37266	9.99	23.48	16.78	33.47	26.77	58.44	48.44	-24.97	-21.67
4	1.91016	10.07	15.58	3.11	25.65	13.18	56.00	46.00	-30.35	-32.82
5	2.64844	10.10	18.23	2.54	28.33	12.64	56.00	46.00	-27.67	-33.36
6	27.64844	11.27	34.48	33.58	45.75	44.85	60.00	50.00	-14.25	-5.15

Remarks:

1. Q.P. and AV. are abbreviations of quasi-peak and average individually.
2. The emission levels of other frequencies were very low against the limit.
3. Margin value = Emission level – Limit value
4. Correction factor = Insertion loss + Cable loss
5. Emission Level = Correction Factor + Reading Value

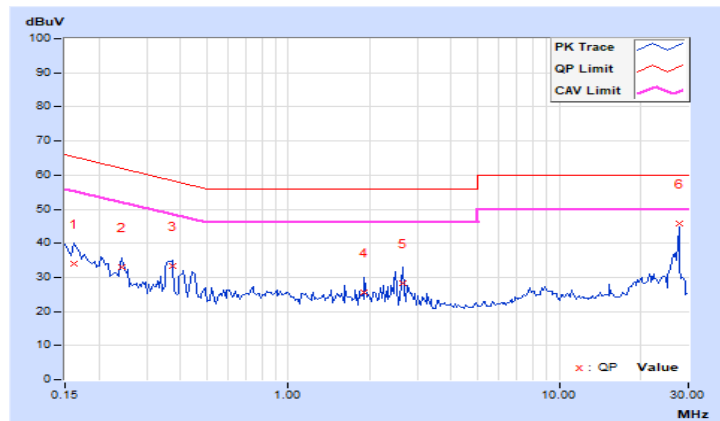

Phase	Neutral (N)	Detector Function	Quasi-Peak (QP) / Average (AV)
-------	-------------	-------------------	--------------------------------

Phase Of Power : Neutral (N)										
No	Frequency (MHz)	Correction Factor (dB)	Reading Value (dBuV)		Emission Level (dBuV)		Limit (dBuV)		Margin (dB)	
			Q.P.	AV.	Q.P.	AV.	Q.P.	AV.	Q.P.	AV.
1	0.16172	9.93	23.16	19.32	33.09	29.25	65.38	55.38	-32.29	-26.13
2	0.33359	9.96	17.69	8.18	27.65	18.14	59.36	49.36	-31.71	-31.22
3	0.41563	9.96	22.02	11.88	31.98	21.84	57.54	47.54	-25.56	-25.70
4	2.08203	10.04	10.79	-6.63	20.83	3.41	56.00	46.00	-35.17	-42.59
5	2.55859	10.06	19.43	1.17	29.49	11.23	56.00	46.00	-26.51	-34.77
6	27.64844	10.91	34.54	33.70	45.45	44.61	60.00	50.00	-14.55	-5.39

Remarks:

1. Q.P. and AV. are abbreviations of quasi-peak and average individually.
2. The emission levels of other frequencies were very low against the limit.
3. Margin value = Emission level – Limit value
4. Correction factor = Insertion loss + Cable loss
5. Emission Level = Correction Factor + Reading Value

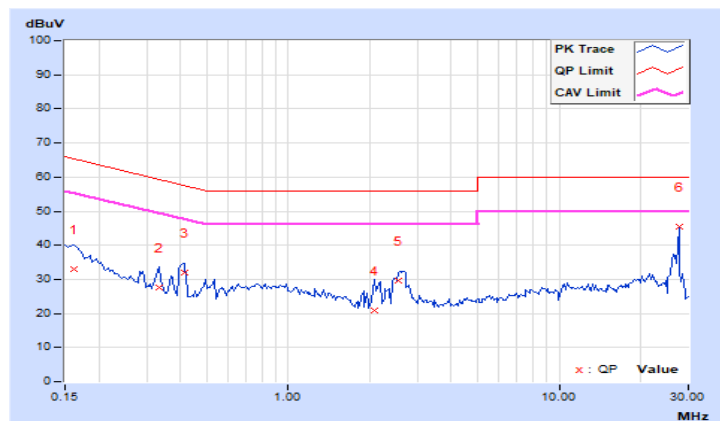

4.2.8 Test Results (Mode 2)

Phase	Line (L)	Detector Function	Quasi-Peak (QP) / Average (AV)
-------	----------	-------------------	--------------------------------

Phase Of Power : Line (L)										
No	Frequency (MHz)	Correction Factor (dB)	Reading Value (dBuV)		Emission Level (dBuV)		Limit (dBuV)		Margin (dB)	
			Q.P.	AV.	Q.P.	AV.	Q.P.	AV.	Q.P.	AV.
1	0.15000	9.95	19.99	3.31	29.94	13.26	66.00	56.00	-36.06	-42.74
2	0.24375	9.97	23.32	16.52	33.29	26.49	61.97	51.97	-28.68	-25.48
3	0.37266	9.99	23.40	14.89	33.39	24.88	58.44	48.44	-25.05	-23.56
4	1.90625	10.07	14.41	1.57	24.48	11.64	56.00	46.00	-31.52	-34.36
5	2.74219	10.11	16.01	-1.20	26.12	8.91	56.00	46.00	-29.88	-37.09
6	27.64844	11.27	33.80	33.66	45.07	44.93	60.00	50.00	-14.93	-5.07

Remarks:

1. Q.P. and AV. are abbreviations of quasi-peak and average individually.
2. The emission levels of other frequencies were very low against the limit.
3. Margin value = Emission level – Limit value
4. Correction factor = Insertion loss + Cable loss
5. Emission Level = Correction Factor + Reading Value

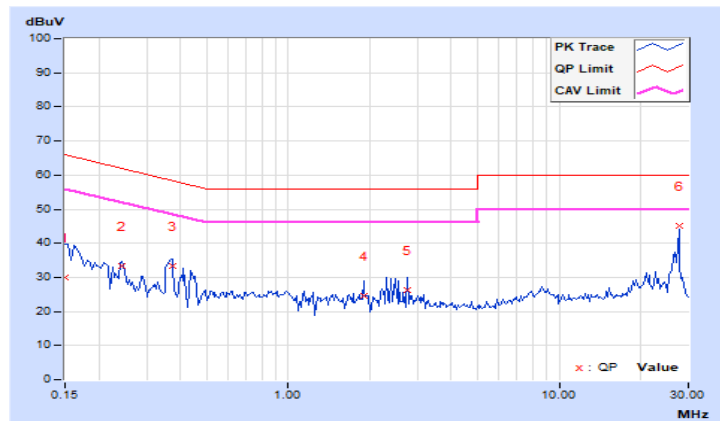

Phase	Neutral (N)	Detector Function	Quasi-Peak (QP) / Average (AV)
-------	-------------	-------------------	--------------------------------

Phase Of Power : Neutral (N)										
No	Frequency (MHz)	Correction Factor (dB)	Reading Value (dBuV)		Emission Level (dBuV)		Limit (dBuV)		Margin (dB)	
			Q.P.	AV.	Q.P.	AV.	Q.P.	AV.	Q.P.	AV.
1	0.16172	9.93	23.12	19.68	33.05	29.61	65.38	55.38	-32.33	-25.77
2	0.20469	9.95	16.53	8.96	26.48	18.91	63.42	53.42	-36.94	-34.51
3	0.40391	9.96	22.30	16.69	32.26	26.65	57.77	47.77	-25.51	-21.12
4	0.94297	10.00	15.18	8.46	25.18	18.46	56.00	46.00	-30.82	-27.54
5	2.72656	10.07	17.15	0.18	27.22	10.25	56.00	46.00	-28.78	-35.75
6	27.64844	10.91	34.66	33.64	45.57	44.55	60.00	50.00	-14.43	-5.45

Remarks:

1. Q.P. and AV. are abbreviations of quasi-peak and average individually.
2. The emission levels of other frequencies were very low against the limit.
3. Margin value = Emission level – Limit value
4. Correction factor = Insertion loss + Cable loss
5. Emission Level = Correction Factor + Reading Value

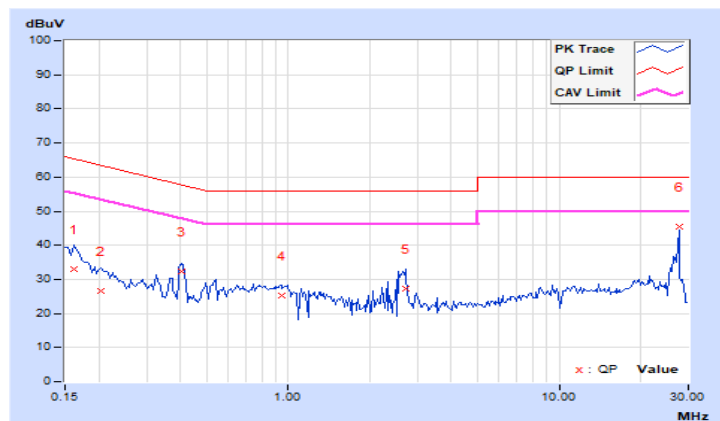

4.2.9 Test Results (Mode 3)

Phase	Line (L)	Detector Function	Quasi-Peak (QP) / Average (AV)
-------	----------	-------------------	--------------------------------

Phase Of Power : Line (L)										
No	Frequency (MHz)	Correction Factor (dB)	Reading Value (dBuV)		Emission Level (dBuV)		Limit (dBuV)		Margin (dB)	
			Q.P.	AV.	Q.P.	AV.	Q.P.	AV.	Q.P.	AV.
1	0.15781	9.95	22.86	14.31	32.81	24.26	65.58	55.58	-32.77	-31.32
2	0.24375	9.97	23.16	17.34	33.13	27.31	61.97	51.97	-28.84	-24.66
3	0.37266	9.99	23.62	16.70	33.61	26.69	58.44	48.44	-24.83	-21.75
4	0.43516	9.99	19.12	3.80	29.11	13.79	57.15	47.15	-28.04	-33.36
5	2.54297	10.10	15.52	1.69	25.62	11.79	56.00	46.00	-30.38	-34.21
6	27.64844	11.27	33.94	33.72	45.21	44.99	60.00	50.00	-14.79	-5.01

Remarks:

1. Q.P. and AV. are abbreviations of quasi-peak and average individually.
2. The emission levels of other frequencies were very low against the limit.
3. Margin value = Emission level – Limit value
4. Correction factor = Insertion loss + Cable loss
5. Emission Level = Correction Factor + Reading Value

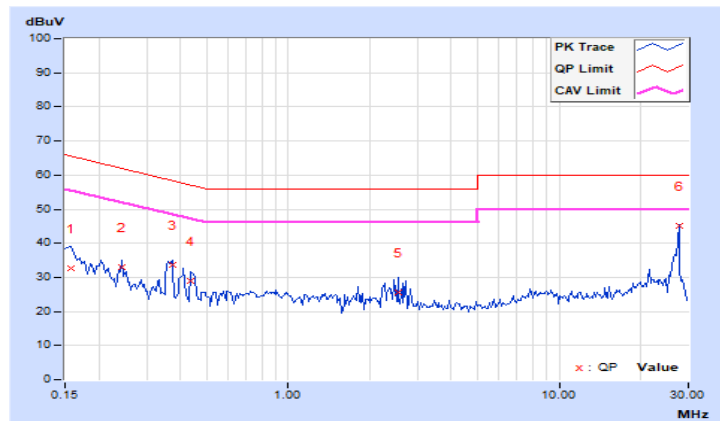

Phase	Neutral (N)	Detector Function	Quasi-Peak (QP) / Average (AV)
-------	-------------	-------------------	--------------------------------

Phase Of Power : Neutral (N)										
No	Frequency (MHz)	Correction Factor (dB)	Reading Value (dBuV)		Emission Level (dBuV)		Limit (dBuV)		Margin (dB)	
			Q.P.	AV.	Q.P.	AV.	Q.P.	AV.	Q.P.	AV.
1	0.15781	9.92	22.45	16.04	32.37	25.96	65.58	55.58	-33.21	-29.62
2	0.28672	9.95	18.01	13.18	27.96	23.13	60.62	50.62	-32.66	-27.49
3	0.41172	9.96	22.85	18.63	32.81	28.59	57.61	47.61	-24.80	-19.02
4	0.99375	10.00	15.34	4.91	25.34	14.91	56.00	46.00	-30.66	-31.09
5	2.60156	10.06	18.11	1.72	28.17	11.78	56.00	46.00	-27.83	-34.22
6	27.64844	10.91	33.88	33.70	44.79	44.61	60.00	50.00	-15.21	-5.39

Remarks:

1. Q.P. and AV. are abbreviations of quasi-peak and average individually.
2. The emission levels of other frequencies were very low against the limit.
3. Margin value = Emission level – Limit value
4. Correction factor = Insertion loss + Cable loss
5. Emission Level = Correction Factor + Reading Value

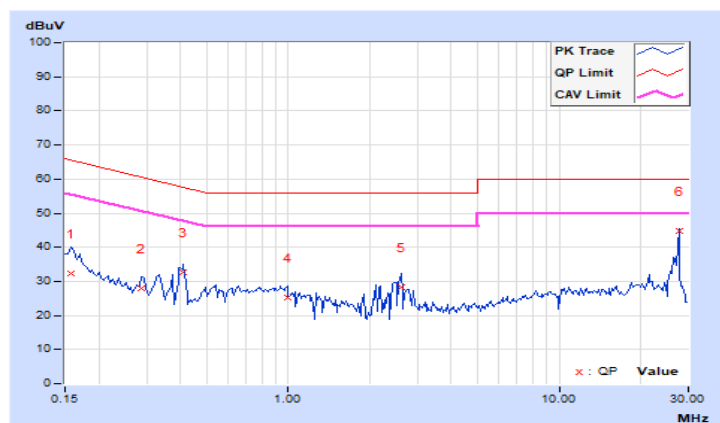

4.3 Conducted Out of Band Emission Measurement

4.3.1 Limits of Conducted Out of Band Emission Measurement

Below 20dB of the highest emission level of operating band (in 100kHz Resolution Bandwidth).

4.3.2 Test Setup

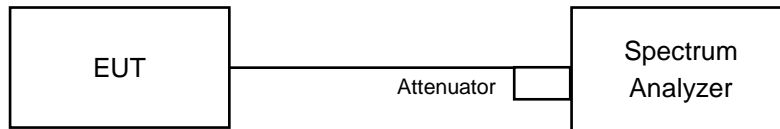

4.3.3 Test Instruments

Refer to section 4.1.2 to get information of above instrument.

4.3.4 Test Procedures

MEASUREMENT PROCEDURE REF

1. Set the RBW = 100 kHz.
2. Set the VBW \geq 300 kHz.
3. Detector = peak.
4. Sweep time = auto couple.
5. Trace mode = max hold.
6. Allow trace to fully stabilize.
7. Use the peak marker function to determine the maximum power level in any 100 kHz band segment within the fundamental EBW.

MEASUREMENT PROCEDURE OOBE

1. Set RBW = 100 kHz.
2. Set VBW \geq 300 kHz.
3. Detector = peak.
4. Sweep = auto couple.
5. Trace Mode = max hold.
6. Allow trace to fully stabilize.
7. Use the peak marker function to determine the maximum amplitude level.

4.3.5 Deviation from Test Standard

No deviation.

4.3.6 EUT Operating Conditions

The software provided by client to enable the EUT under transmission condition continuously at specific channel frequencies individually.

4.3.7 Test Results

The spectrum plots are attached on the following pages. D1 line indicates the highest level, and D2 line indicates the 20dB offset below D1. It shows compliance with the requirement.

2.4GHz_802.11b CH11 + 5GHz_802.11a CH149

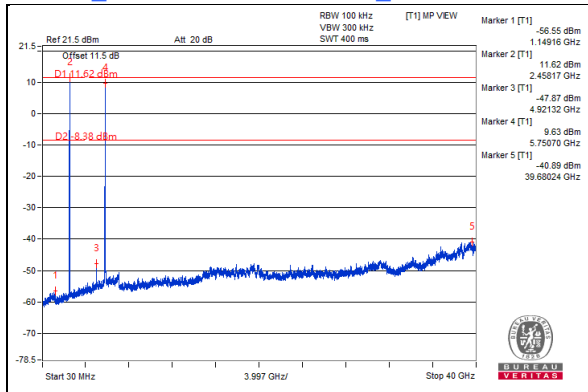

2.4GHz_802.11b CH11 + BT-LE 1M_CH39

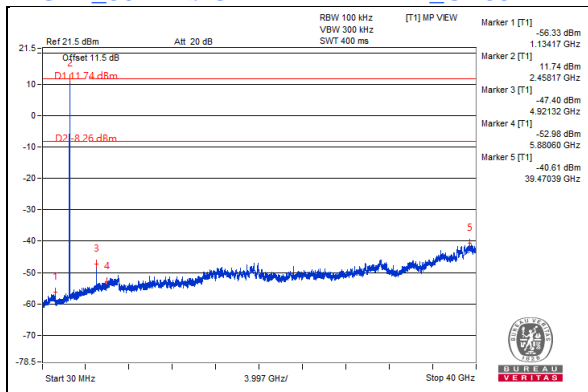

5GHz_802.11a CH149 + BT-LE 1M_CH39

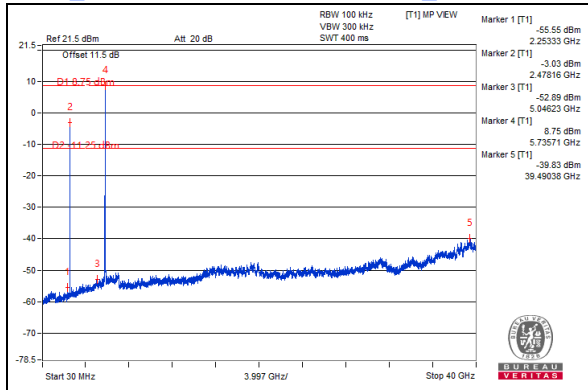

5 Pictures of Test Arrangements

Please refer to the attached file (Test Setup Photo).

Appendix – Information of the Testing Laboratories

We, Bureau Veritas Consumer Products Services (H.K.) Ltd., Taoyuan Branch, were founded in 1988 to provide our best service in EMC, Radio, Telecom and Safety consultation. Our laboratories are FCC recognized accredited test firms and accredited according to ISO/IEC 17025.

If you have any comments, please feel free to contact us at the following:

Lin Kou EMC/RF Lab

Tel: 886-2-26052180

Fax: 886-2-26051924

Hsin Chu EMC/RF/Telecom Lab

Tel: 886-3-6668565

Fax: 886-3-6668323

Hwa Ya EMC/RF/Safety Lab

Tel: 886-3-3183232

Fax: 886-3-3270892

Email: service.adt@tw.bureauveritas.com

Web Site: www.bureauveritas-adt.com

The address and road map of all our labs can be found in our web site also.

--- END ---