

## FCC Test Report (BT-EDR)

**Report No.:** RF180323E09

**FCC ID:** JNZS00170

**Test Model:** S-00170

**Received Date:** Mar. 23, 2018

**Test Date:** Mar. 27 to 29, 2018

**Issued Date:** Apr. 19, 2018

**Applicant:** LOGITECH FAR EAST LTD.

**Address:** #2 Creation Rd. 4, Science-Based Ind. Park Hsinchu Taiwan, R.O.C.

**Issued By:** Bureau Veritas Consumer Products Services (H.K.) Ltd., Taoyuan Branch  
Hsin Chu Laboratory

**Lab Address:** E-2, No.1, Li Hsin 1st Road, Hsinchu Science Park, Hsinchu City 300,  
Taiwan R.O.C.

**Test Location :** E-2, No.1, Li Hsin 1st Road, Hsinchu Science Park, Hsinchu City 300,  
Taiwan R.O.C.

**FCC Registration /  
Designation Number:** 723255 / TW2022



This report is for your exclusive use. Any copying or replication of this report to or for any other person or entity, or use of our name or trademark, is permitted only with our prior written permission. This report sets forth our findings solely with respect to the test samples identified herein. The results set forth in this report are not indicative or representative of the quality or characteristics of the lot from which a test sample was taken or any similar or identical product unless specifically and expressly noted. Our report includes all of the tests requested by you and the results thereof based upon the information that you provided to us. You have 60 days from date of issuance of this report to notify us of any material error or omission caused by our negligence, provided, however, that such notice shall be in writing and shall specifically address the issue you wish to raise. A failure to raise such issue within the prescribed time shall constitute your unqualified acceptance of the completeness of this report, the tests conducted and the correctness of the report contents. Unless specific mention, the uncertainty of measurement has been explicitly taken into account to declare the compliance or non-compliance to the specification. The report must not be used by the client to claim product certification, approval, or endorsement by TAF or any government agencies.

## Table of Contents

<b>Release Control Record</b> .....	<b>4</b>
<b>1 Certificate of Conformity</b> .....	<b>5</b>
<b>2 Summary of Test Results</b> .....	<b>6</b>
2.1 Measurement Uncertainty .....	6
2.2 Modification Record .....	6
<b>3 General Information</b> .....	<b>7</b>
3.1 General Description of EUT (BT-EDR) .....	7
3.2 Description of Test Modes .....	9
3.2.1 Test Mode Applicability and Tested Channel Detail .....	10
3.3 Description of Support Units .....	12
3.3.1 Configuration of System under Test .....	13
3.4 General Description of Applied Standards .....	15
<b>4 Test Types and Results</b> .....	<b>16</b>
4.1 Radiated Emission and Bandedge Measurement .....	16
4.1.1 Limits of Radiated Emission and Bandedge Measurement .....	16
4.1.2 Test Instruments .....	17
4.1.3 Test Procedures .....	19
4.1.4 Deviation from Test Standard .....	19
4.1.5 Test Setup .....	20
4.1.6 EUT Operating Conditions .....	21
4.1.7 Test Results .....	22
4.2 Conducted Emission Measurement .....	29
4.2.1 Limits of Conducted Emission Measurement .....	29
4.2.2 Test Instruments .....	29
4.2.3 Test Procedures .....	30
4.2.4 Deviation From Test Standard .....	30
4.2.5 Test Setup .....	30
4.2.6 EUT Operating Condition .....	30
4.2.7 Test Results (Mode 1) .....	31
4.2.8 Test Results (Mode 2) .....	33
4.2.9 Test Results (Mode 3) .....	35
4.3 Number of Hopping Frequency Used .....	37
4.3.1 Limits of Hopping Frequency Used Measurement .....	37
4.3.2 Test Setup .....	37
4.3.3 Test Instruments .....	37
4.3.4 Test Procedure .....	37
4.3.5 Deviation from Test Standard .....	37
4.3.6 Test Results .....	38
4.4 Dwell Time on Each Channel .....	39
4.4.1 Limits of Dwell Time on Each Channel Measurement .....	39
4.4.2 Test Setup .....	39
4.4.3 Test Instruments .....	39
4.4.4 Test Procedures .....	39
4.4.5 Deviation from Test Standard .....	39
4.4.6 Test Results .....	40
4.5 Channel Bandwidth .....	44
4.5.1 Limits of Channel Bandwidth Measurement .....	44
4.5.2 Test Setup .....	44
4.5.3 Test Instruments .....	44
4.5.4 Test Procedure .....	44
4.5.5 Deviation from Test Standard .....	44
4.5.6 EUT Operating Condition .....	44
4.5.7 Test Results .....	45

4.6	Hopping Channel Separation .....	46
4.6.1	Limits of Hopping Channel Separation Measurement.....	46
4.6.2	Test Setup.....	46
4.6.3	Test Instruments .....	46
4.6.4	Test Procedure .....	46
4.6.5	Deviation from Test Standard .....	46
4.6.6	Test Results .....	47
4.7	Maximum Output Power.....	48
4.7.1	Limits of Maximum Output Power Measurement .....	48
4.7.2	Test Setup.....	48
4.7.3	Test Instruments .....	48
4.7.4	Test Procedure .....	48
4.7.5	Deviation from Test Standard .....	48
4.7.6	EUT Operating Condition .....	48
4.7.7	Test Results .....	49
4.8	Conducted Out of Band Emission Measurement.....	50
4.8.1	Limits of Conducted Out of Band Emission Measurement.....	50
4.8.2	Test Instruments .....	50
4.8.3	Test Procedure .....	50
4.8.4	Deviation from Test Standard .....	50
4.8.5	EUT Operating Condition .....	50
4.8.6	Test Results .....	50
<b>5</b>	<b>Pictures of Test Arrangements.....</b>	<b>53</b>
	<b>Appendix – Information on the Testing Laboratories .....</b>	<b>54</b>

### Release Control Record

Issue No.	Description	Date Issued
RF180323E09	Original release.	Apr. 19, 2018

## 1 Certificate of Conformity

**Product:** Bluetooth speaker

**Brand:** ULTIMATE EARS

**Test Model:** S-00170

**Sample Status:** ENGINEERING SAMPLE

**Applicant:** LOGITECH FAR EAST LTD.

**Test Date:** Mar. 27 to 29, 2018

**Standards:** 47 CFR FCC Part 15, Subpart C (Section 15.247)  
ANSI C63.10: 2013

The above equipment has been tested by **Bureau Veritas Consumer Products Services (H.K.) Ltd., Taoyuan Branch**, and found compliance with the requirement of the above standards. The test record, data evaluation & Equipment Under Test (EUT) configurations represented herein are true and accurate accounts of the measurements of the sample's EMC characteristics under the conditions specified in this report.

**Prepared by :** Wendy Wu , **Date:** Apr. 19, 2018  
Wendy Wu / Specialist

**Approved by :** May Chen , **Date:** Apr. 19, 2018  
May Chen / Manager

## 2 Summary of Test Results

47 CFR FCC Part 15, Subpart C (SECTION 15.247)			
FCC Clause	Test Item	Result	Remarks
15.207	AC Power Conducted Emission	PASS	Meet the requirement of limit. Minimum passing margin is -9.57dB at 0.18516MHz.
15.247(a)(1)(iii)	Number of Hopping Frequency Used	PASS	Meet the requirement of limit.
15.247(a)(1)(iii)	Dwell Time on Each Channel	PASS	Meet the requirement of limit.
15.247(a)(1)	1. Hopping Channel Separation 2. Spectrum Bandwidth of a Frequency Hopping Sequence Spread Spectrum System	PASS	Meet the requirement of limit.
15.247(b)	Maximum Peak Output Power	PASS	Meet the requirement of limit.
15.205 & 209 & 15.247(d)	Radiated Emissions & Band Edge Measurement	PASS	Meet the requirement of limit. Minimum passing margin is -6.9dB at 40.5MHz.
15.247(d)	Antenna Port Emission	PASS	Meet the requirement of limit.
15.203	Antenna Requirement	PASS	No antenna connector is used.

**NOTE:** If The Frequency Hopping System operating in 2400-2483.5MHz band and the output power less than 125mW. The hopping channel carrier frequencies separated by a minimum of 25kHz or two-thirds of the 20dB bandwidth of hopping channel whichever is greater.

### 2.1 Measurement Uncertainty

Where relevant, the following measurement uncertainty levels have been estimated for tests performed on the EUT as specified in CISPR 16-4-2:

Measurement	Frequency	Expanded Uncertainty (k=2) ( $\pm$ )
Conducted Emissions at mains ports	150kHz ~ 30MHz	1.84 dB
Radiated Emissions up to 1 GHz	30MHz ~ 1GHz	5.33 dB
Radiated Emissions above 1 GHz	1GHz ~ 6GHz	5.10 dB
	6GHz ~ 18GHz	4.85 dB
	18GHz ~ 40GHz	5.24 dB

### 2.2 Modification Record

There were no modifications required for compliance.

### 3 General Information

#### 3.1 General Description of EUT (BT-EDR)

Product	Bluetooth speaker
PMN	BOOM 3
Brand	ULTIMATE EARS
Test Model	S-00170
Status of EUT	ENGINEERING SAMPLE
Power Supply Rating	DC 3.6V from battery DC 5V from USB interface
Modulation Type	GFSK, $\pi/4$ -DQPSK, 8DPSK
Modulation Technology	FHSS
Transfer Rate	Up to 3Mbps
Operating Frequency	2402MHz ~ 2480MHz
Number of Channel	79
Output Power	10.914mW
Antenna Type	Refer to Note
Antenna Connector	Refer to Note
Accessory Device	Charging Dock (option) x 1
Data Cable Supplied	USB to Micro USB cable (Unshielded, 1.2m) x 1

Note:

1. The EUT may have a lot of colors for marketing requirement.
2. The EUT could be supplied with battery, power adapter or charging dock as the following table:

Battery		
Brand Name	Model No.	Spec.
Logitech	533-000104 (1INR19/66)	3.6V 3200mAh, 11.52Wh
Adapter (only for test, not for sale)		
Brand Name	Model No.	Spec.
ULTIMATE EARS	AD2051M20	Input: 100-240Vac, 50/60Hz, 0.3A Output: 5.1Vdc, 2A USB cable (Unshielded, 1.2m)
Charging Dock (option)		
Brand Name	Model No.	Spec.
ULTIMATE EARS	S-00165	Input: 5.1V, 2A Output :5V, 2A

3. For radiated emissions, the EUT was pre-tested under the following modes:

Test Mode	Description
Mode A	Power from adapter
Mode B	Power from Laptop
Mode C	Power from Charging Dock
Mode D	Power from Battery

From the above modes, the worst case was found in **Mode A**. Therefore only the test data of the mode was recorded in this report.

4. The USB port of the EUT is only for charging the rechargeable battery. And the EUT has Bluetooth function under charging mode.

5. The antenna provided to the EUT, please refer to the following table:

Antenna Gain (dBi)	Frequency range (GHz)	Antenna Type	Connector Type
0.3	2.4~2.4835	Folded Monopole	None

6. The above EUT information is declared by manufacturer and for more detailed features description, please refer to the manufacturer's specifications or user's manual.



### 3.2 Description of Test Modes

79 channels are provided for BT-EDR mode:

Channel	Freq. (MHz)	Channel	Freq. (MHz)	Channel	Freq. (MHz)	Channel	Freq. (MHz)
0	2402	20	2422	40	2442	60	2462
1	2403	21	2423	41	2443	61	2463
2	2404	22	2424	42	2444	62	2464
3	2405	23	2425	43	2445	63	2465
4	2406	24	2426	44	2446	64	2466
5	2407	25	2427	45	2447	65	2467
6	2408	26	2428	46	2448	66	2468
7	2409	27	2429	47	2449	67	2469
8	2410	28	2430	48	2450	68	2470
9	2411	29	2431	49	2451	69	2471
10	2412	30	2432	50	2452	70	2472
11	2413	31	2433	51	2453	71	2473
12	2414	32	2434	52	2454	72	2474
13	2415	33	2435	53	2455	73	2475
14	2416	34	2436	54	2456	74	2476
15	2417	35	2437	55	2457	75	2477
16	2418	36	2438	56	2458	76	2478
17	2419	37	2439	57	2459	77	2479
18	2420	38	2440	58	2460	78	2480
19	2421	39	2441	59	2461		

### 3.2.1 Test Mode Applicability and Tested Channel Detail

EUT CONFIGURE MODE	APPLICABLE TO				DESCRIPTION
	RE $\geq$ 1G	RE $<$ 1G	PLC	APCM	
1	√	√	√	√	Powered from adapter
2	-	-	√	-	Powered from Laptop
3	-	-	√	-	Powered from charging dock

Where **RE $\geq$ 1G**: Radiated Emission above 1GHz      **RE $<$ 1G**: Radiated Emission below 1GHz  
**PLC**: Power Line Conducted Emission      **APCM**: Antenna Port Conducted Measurement

**NOTE:**

1. The EUT had been pre-tested on the positioned of each 3 axis. The worst case was found when positioned on **Y-plane**.
2. "-" means no effect.

#### **Radiated Emission Test (Above 1GHz):**

- Pre-Scan has been conducted to determine the worst-case mode from all possible combinations between available modulations, data rates and antenna ports (if EUT with antenna diversity architecture).
- Following channel(s) was (were) selected for the final test as listed below.

AVAILABLE CHANNEL	TESTED CHANNEL	MODULATION TECHNOLOGY	MODULATION TYPE	PACKET TYPE
0 to 78	0, 39, 78	FHSS	GFSK	DH5
0 to 78	0, 39, 78	FHSS	8DPSK	3DH5

#### **Radiated Emission Test (Below 1GHz):**

- Pre-Scan has been conducted to determine the worst-case mode from all possible combinations between available modulations, data rates and antenna ports (if EUT with antenna diversity architecture).
- Following channel(s) was (were) selected for the final test as listed below.

AVAILABLE CHANNEL	TESTED CHANNEL	MODULATION TECHNOLOGY	MODULATION TYPE	PACKET TYPE
0 to 78	78	FHSS	GFSK	DH5

#### **Power Line Conducted Emission Test:**

- Pre-Scan has been conducted to determine the worst-case mode from all possible combinations between available modulations, data rates and antenna ports (if EUT with antenna diversity architecture).
- Following channel(s) was (were) selected for the final test as listed below.

AVAILABLE CHANNEL	TESTED CHANNEL	MODULATION TECHNOLOGY	MODULATION TYPE	PACKET TYPE
0 to 78	78	FHSS	GFSK	DH5

### Antenna Port Conducted Measurement:

- This item includes all test value of each mode, but only includes spectrum plot of worst value of each mode.
- Pre-Scan has been conducted to determine the worst-case mode from all possible combinations between available modulations, data rates and antenna ports (if EUT with antenna diversity architecture).
- Following channel(s) was (were) selected for the final test as listed below.

AVAILABLE CHANNEL	TESTED CHANNEL	MODULATION TECHNOLOGY	MODULATION TYPE	PACKET TYPE
0 to 78	0, 39, 78	FHSS	GFSK	DH5
0 to 78	0, 39, 78	FHSS	8DPSK	3DH5

### Test Condition:

APPLICABLE TO	ENVIRONMENTAL CONDITIONS	INPUT POWER (SYSTEM)	TESTED BY
RE $\geq$ 1G	22deg. C, 68%RH	120Vac, 60Hz	Frank Chuang
RE<1G	23deg. C, 67%RH	120Vac, 60Hz	Frank Chuang
PLC	25deg. C, 68%RH	120Vac, 60Hz	Andy Ho
APCM	25deg. C, 60%RH	120Vac, 60Hz	Jyunchun Lin

### 3.3 Description of Support Units

The EUT has been tested as an independent unit together with other necessary accessories or support units. The following support units or accessories were used to form a representative test configuration during the tests.

ID	Product	Brand	Model No.	Serial No.	FCC ID	Remarks
A.	Laptop	DELL	E6420	B92T3R1	FCC DoC	Provided by Lab

Note:

1. All power cords of the above support units are non-shielded (1.8m).

ID	Descriptions	Qty.	Length (m)	Shielding (Yes/No)	Cores (Qty.)	Remarks
1.	USB Cable	1	1.2	No	0	Supplied by client

### 3.3.1 Configuration of System under Test

#### Power from adapter:

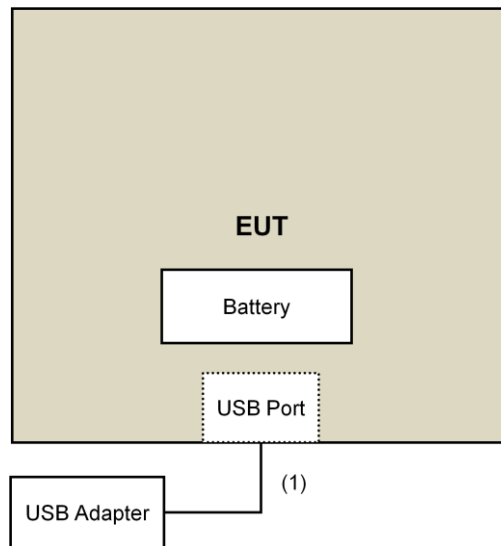

#### Power from Laptop:

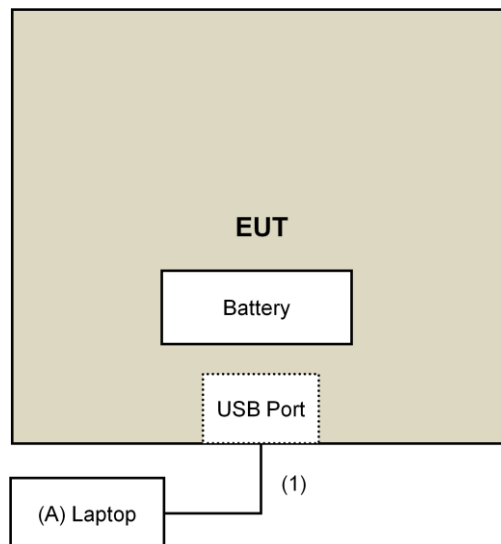

**Power from charging dock:**

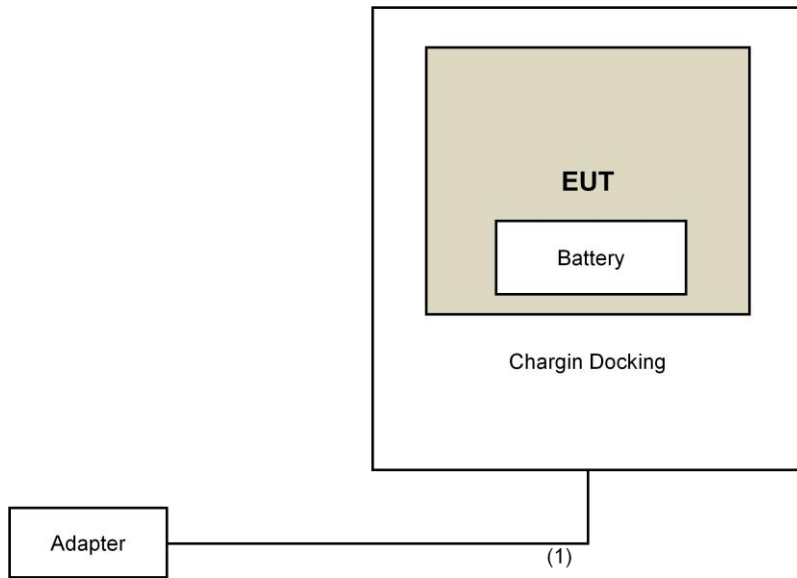

### 3.4 General Description of Applied Standards

The EUT is a RF Product. According to the specifications of the manufacturer, it must comply with the requirements of the following standards:

**FCC Part 15, Subpart C (15.247)**

ANSI C63.10-2013

All test items have been performed and recorded as per the above standards.

## 4 Test Types and Results

### 4.1 Radiated Emission and Bandedge Measurement

#### 4.1.1 Limits of Radiated Emission and Bandedge Measurement

Radiated emissions which fall in the restricted bands must comply with the radiated emission limits specified as below table. Other emissions shall be at least 20dB below the highest level of the desired power:

Frequencies (MHz)	Field Strength (microvolts/meter)	Measurement Distance (meters)
0.009 ~ 0.490	2400/F(kHz)	300
0.490 ~ 1.705	24000/F(kHz)	30
1.705 ~ 30.0	30	30
30 ~ 88	100	3
88 ~ 216	150	3
216 ~ 960	200	3
Above 960	500	3

**NOTE:**

1. The lower limit shall apply at the transition frequencies.
2. Emission level (dBuV/m) = 20 log Emission level (uV/m).
3. For frequencies above 1000MHz, the field strength limits are based on average detector, however, the peak field strength of any emission shall not exceed the maximum permitted average limits, specified above by more than 20dB under any condition of modulation.



## 4.1.2 Test Instruments

DESCRIPTION & MANUFACTURER	MODEL NO.	SERIAL NO.	CALIBRATED DATE	CALIBRATED UNTIL
Test Receiver Keysight	N9038A	MY54450088	July 08, 2017	July 07, 2018
Pre-Amplifier EMCI	EMC001340	980142	Feb. 09, 2018	Feb. 08, 2019
Loop Antenna <sup>(*)</sup> Electro-Metrics	EM-6879	264	Dec. 16, 2016	Dec. 15, 2018
RF Cable	NA	LOOPCAB-001 LOOPCAB-002	Jan. 15, 2018	Jan. 14, 2019
Pre-Amplifier Mini-Circuits	ZFL-1000VH2B	AMP-ZFL-01	Nov. 09, 2017	Nov. 08, 2018
Trilog Broadband Antenna SCHWARZBECK	VULB 9168	9168-406	Nov. 29, 2017	Nov. 28, 2018
RF Cable	8D	966-4-1 966-4-2 966-4-3	Apr. 01, 2017	Mar. 31, 2018
Fixed attenuator Mini-Circuits	UNAT-5+	PAD-3m-4-01	Oct. 03, 2017	Oct. 02, 2018
Horn_Antenna SCHWARZBECK	BBHA 9120D	9120D-783	Dec. 12, 2017	Dec. 11, 2018
Pre-Amplifier EMCI	EMC12630SE	980385	Jan. 29, 2018	Jan. 28, 2019
RF Cable	EMC104-SM-SM-1200 EMC104-SM-SM-2000 EMC104-SM-SM-5000	160923 150318 150321	Jan. 29, 2018	Jan. 28, 2019
Pre-Amplifier EMCI	EMC184045SE	980387	Jan. 29, 2018	Jan. 28, 2019
Horn_Antenna SCHWARZBECK	BBHA 9170	BBHA9170608	Dec. 14, 2017	Dec. 13, 2018
RF Cable	EMC102-KM-KM-1200	160925	Jan. 29, 2018	Jan. 28, 2019
Software	ADT_Radiated_V8.7.08	NA	NA	NA
Antenna Tower & Turn Table Max-Full	MF-7802	MF780208410	NA	NA
Boresight Antenna Fixture	FBA-01	FBA-SIP02	NA	NA
Spectrum Analyzer R&S	FSV40	100964	July 1, 2017	June 30, 2018
Power meter Anritsu	ML2495A	1014008	May 11, 2017	May 10, 2018
Power sensor Anritsu	MA2411B	0917122	May 11, 2017	May 10, 2018

**Note:**

1. The calibration interval of the above test instruments is 12 months and the calibrations are traceable to NML/ROC and NIST/USA.
2. \*The calibration interval of the above test instruments is 24 months and the calibrations are traceable to NML/ROC and NIST/USA.
3. The test was performed in 966 Chamber No. 4.
4. The CANADA Site Registration No. is 20331-2
5. Loop antenna was used for all emissions below 30 MHz.
6. Tested Date: Mar. 27 to 29, 2018

#### 4.1.3 Test Procedures

##### **For Radiated emission below 30MHz**

- a. The EUT was placed on the top of a rotating table 0.8 meters above the ground at a 3 meter chamber room. The table was rotated 360 degrees to determine the position of the highest radiation.
- b. The EUT was set 3 meters away from the interference-receiving antenna, which was mounted on the top of a variable-height antenna tower.
- c. Both Parallel, perpendicular, and ground-parallel orientations of the antenna are set to make the measurement.
- d. For each suspected emission, the EUT was arranged to its worst case and the rotatable table was turned from 0 degrees to 360 degrees to find the maximum reading.
- e. The test-receiver system was set to Quasi-Peak Detect Function and Specified Bandwidth with Maximum Hold Mode.

##### **NOTE:**

1. The resolution bandwidth and video bandwidth of test receiver/spectrum analyzer is 9kHz at frequency below 30MHz.

##### **For Radiated emission above 30MHz**

- a. The EUT was placed on the top of a rotating table 0.8 meters (for 30MHz ~ 1GHz) / 1.5 meters (for above 1GHz) above the ground at 3 meter chamber room for test. The table was rotated 360 degrees to determine the position of the highest radiation.
- b. The EUT was set 3 meters away from the interference-receiving antenna, which was mounted on the top of a variable-height antenna tower.
- c. The height of antenna is varied from one meter to four meters above the ground to determine the maximum value of the field strength. Both horizontal and vertical polarizations of the antenna are set to make the measurement.
- d. For each suspected emission, the EUT was arranged to its worst case and then the antenna was tuned to heights from 1 meter to 4 meters and the rotatable table was turned from 0 degrees to 360 degrees to find the maximum reading.
- e. The test-receiver system was set to quasi-peak detect function and specified bandwidth with maximum hold mode when the test frequency is below 1 GHz.
- f. The test-receiver system was set to peak and average detect function and specified bandwidth with maximum hold mode when the test frequency is above 1 GHz. If the peak reading value also meets average limit, measurement with the average detector is unnecessary.

##### **Note:**

1. The resolution bandwidth and video bandwidth of test receiver/spectrum analyzer is 120kHz for Quasi-peak detection (QP) at frequency below 1GHz.
2. The resolution bandwidth of test receiver/spectrum analyzer is 1 MHz and the video bandwidth is 3 MHz for Peak detection (PK) at frequency above 1GHz.
3. The resolution bandwidth of test receiver/spectrum analyzer is 1 MHz and the video bandwidth is 3 MHz for Average detection (AV) at frequency above 1GHz
4. All modes of operation were investigated and the worst-case emissions are reported.

#### 4.1.4 Deviation from Test Standard

No deviation.

4.1.5 Test Setup

For Radiated emission below 30MHz

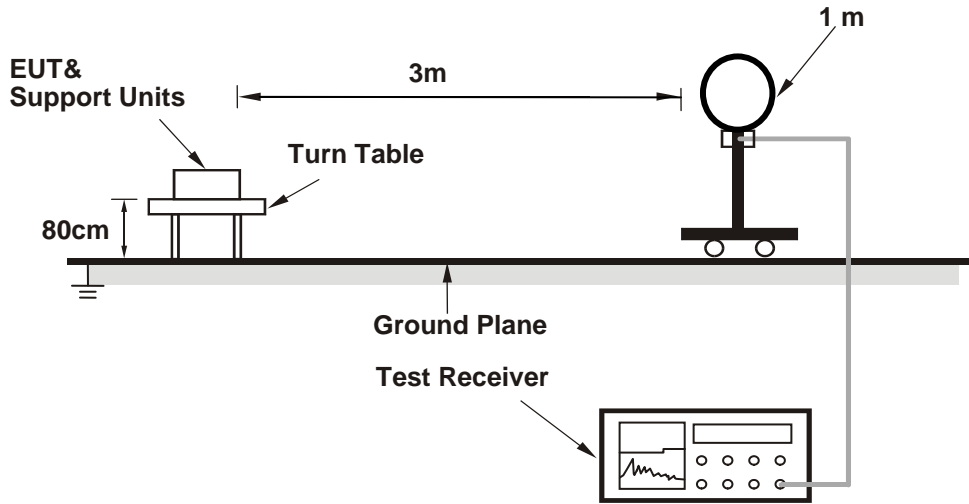

For Radiated emission 30MHz to 1GHz

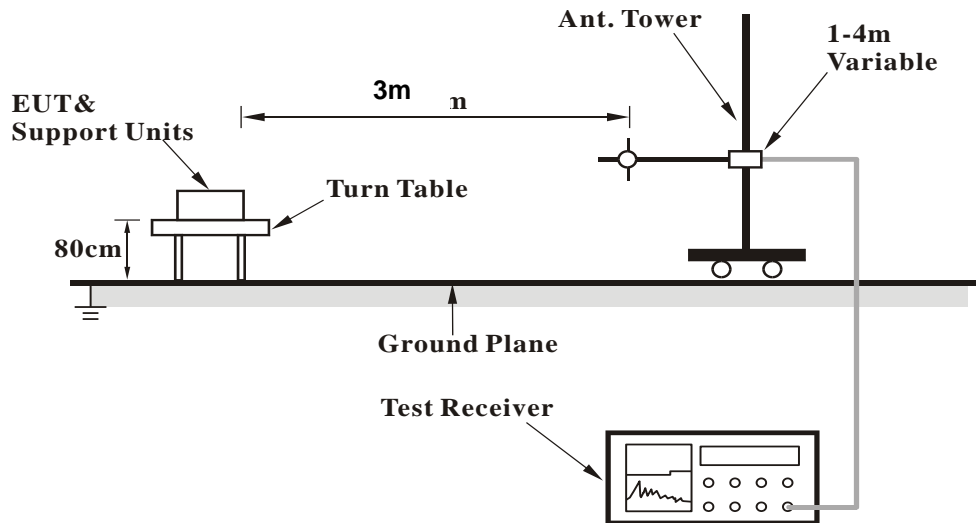

### For Radiated emission above 1GHz

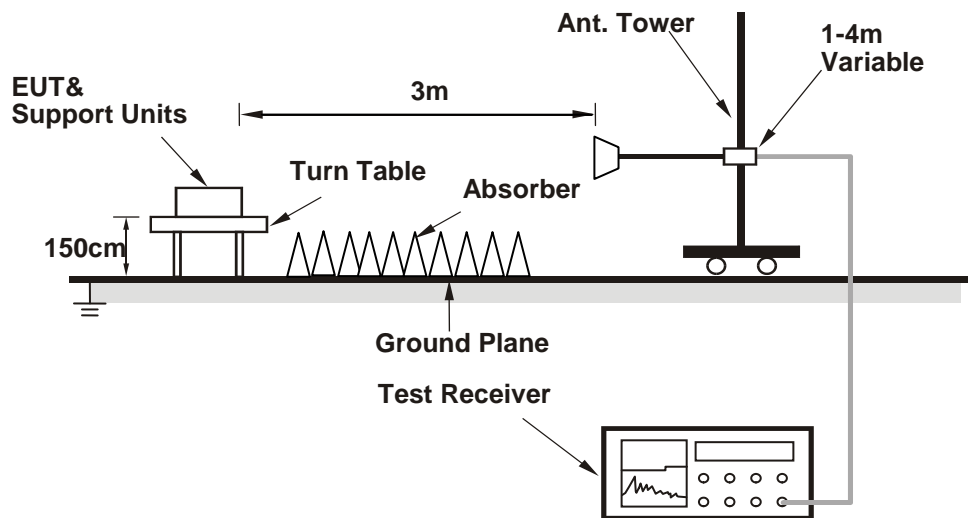

For the actual test configuration, please refer to the attached file (Test Setup Photo).

#### 4.1.6 EUT Operating Conditions

- a. Placed the EUT on the testing table.
- b. Controlling software (BlueTest3.exe Ver2.6.8.1467) has been activated to set the EUT on specific status.

#### 4.1.7 Test Results

#### Above 1GHz Data:

#### BT\_GFSK

<b>CHANNEL</b>	TX Channel 0	<b>DETECTOR FUNCTION</b>	Peak (PK) Average (AV)
<b>FREQUENCY RANGE</b>	1GHz ~ 25GHz		

#### ANTENNA POLARITY & TEST DISTANCE: HORIZONTAL AT 3 M

NO.	FREQ. (MHz)	EMISSION LEVEL (dBuV/m)	LIMIT (dBuV/m)	MARGIN (dB)	ANTENNA HEIGHT (m)	TABLE ANGLE (Degree)	RAW VALUE (dBuV)	CORRECTION FACTOR (dB/m)
1	2390.00	54.1 PK	74.0	-19.9	2.42 H	153	56.1	-2.0
2	2390.00	42.8 AV	54.0	-11.2	2.42 H	153	44.8	-2.0
3	*2402.00	102.3 PK			2.42 H	153	104.3	-2.0
4	*2402.00	72.2 AV			2.42 H	153	74.2	-2.0
5	4804.00	52.7 PK	74.0	-21.3	3.78 H	56	50.0	2.7
6	4804.00	22.6 AV	54.0	-31.4	3.78 H	56	19.9	2.7

#### ANTENNA POLARITY & TEST DISTANCE: VERTICAL AT 3 M

NO.	FREQ. (MHz)	EMISSION LEVEL (dBuV/m)	LIMIT (dBuV/m)	MARGIN (dB)	ANTENNA HEIGHT (m)	TABLE ANGLE (Degree)	RAW VALUE (dBuV)	CORRECTION FACTOR (dB/m)
1	2390.00	52.4 PK	74.0	-21.6	2.73 V	71	54.4	-2.0
2	2390.00	42.4 AV	54.0	-11.6	2.73 V	71	44.4	-2.0
3	*2402.00	100.3 PK			2.73 V	71	102.3	-2.0
4	*2402.00	70.2 AV			2.73 V	71	72.2	-2.0
5	4804.00	47.4 PK	74.0	-26.6	1.01 V	279	44.7	2.7
6	4804.00	17.3 AV	54.0	-36.7	1.01 V	279	14.6	2.7

#### REMARKS:

- Emission Level(dBuV/m) = Raw Value(dBuV) + Correction Factor(dB/m)
- Correction Factor(dB/m) = Antenna Factor(dB/m) + Cable Factor(dB) – Pre-Amplifier Factor(dB)
- The other emission levels were very low against the limit.
- Margin value = Emission Level – Limit value
- " \* ": Fundamental frequency.
- The DH5 packet was the worse case duty cycle for a transmit dwell time on a channel, based upon bluetooth theory the transmitter is on 0.625 \* 5 per 296.25 ms per channel. Therefore, the duty cycle correlation factor be equal to:  $20\log(3.125 / 100) = -30.1$  dB
- The average value of fundamental and harmonic frequency is: Average = Peak value + 20 log(Duty cycle)

<b>CHANNEL</b>	TX Channel 39	<b>DETECTOR FUNCTION</b>	Peak (PK)
<b>FREQUENCY RANGE</b>	1GHz ~ 25GHz		Average (AV)

**ANTENNA POLARITY & TEST DISTANCE: HORIZONTAL AT 3 M**

NO.	FREQ. (MHz)	EMISSION LEVEL (dBuV/m)	LIMIT (dBuV/m)	MARGIN (dB)	ANTENNA HEIGHT (m)	TABLE ANGLE (Degree)	RAW VALUE (dBuV)	CORRECTION FACTOR (dB/m)
1	2390.00	54.0 PK	74.0	-20.0	2.26 H	117	56.0	-2.0
2	2390.00	42.8 AV	54.0	-11.2	2.26 H	117	44.8	-2.0
3	*2441.00	102.4 PK			2.26 H	117	104.7	-2.3
4	*2441.00	72.3 AV			2.26 H	117	74.6	-2.3
5	2483.50	55.5 PK	74.0	-18.5	2.26 H	117	57.7	-2.2
6	2483.50	43.8 AV	54.0	-10.2	2.26 H	117	46.0	-2.2
7	4882.00	52.7 PK	74.0	-21.3	3.74 H	68	49.8	2.9
8	4882.00	22.6 AV	54.0	-31.4	3.74 H	68	19.7	2.9
9	7323.00	51.2 PK	74.0	-22.8	2.45 H	127	41.8	9.4
10	7323.00	21.1 AV	54.0	-32.9	2.45 H	127	11.7	9.4

**ANTENNA POLARITY & TEST DISTANCE: VERTICAL AT 3 M**

NO.	FREQ. (MHz)	EMISSION LEVEL (dBuV/m)	LIMIT (dBuV/m)	MARGIN (dB)	ANTENNA HEIGHT (m)	TABLE ANGLE (Degree)	RAW VALUE (dBuV)	CORRECTION FACTOR (dB/m)
1	2390.00	52.3 PK	74.0	-21.7	2.68 V	94	54.3	-2.0
2	2390.00	42.2 AV	54.0	-11.8	2.68 V	94	44.2	-2.0
3	*2441.00	100.2 PK			2.68 V	94	102.5	-2.3
4	*2441.00	70.1 AV			2.68 V	94	72.4	-2.3
5	2483.50	53.5 PK	74.0	-20.5	2.68 V	94	55.7	-2.2
6	2483.50	43.4 AV	54.0	-10.6	2.68 V	94	45.6	-2.2
7	4882.00	47.8 PK	74.0	-26.2	1.02 V	276	44.9	2.9
8	4882.00	17.7 AV	54.0	-36.3	1.02 V	276	14.8	2.9
9	7323.00	50.3 PK	74.0	-23.7	1.09 V	15	40.9	9.4
10	7323.00	20.2 AV	54.0	-33.8	1.09 V	15	10.8	9.4

**REMARKS:**

- Emission Level(dBuV/m) = Raw Value(dBuV) + Correction Factor(dB/m)
- Correction Factor(dB/m) = Antenna Factor(dB/m) + Cable Factor(dB) – Pre-Amplifier Factor(dB)
- The other emission levels were very low against the limit.
- Margin value = Emission Level – Limit value
- " \* ": Fundamental frequency.
- The DH5 packet was the worse case duty cycle for a transmit dwell time on a channel, based upon bluetooth theory the transmitter is on 0.625 \* 5 per 296.25 ms per channel. Therefore, the duty cycle correlation factor be equal to:  $20\log(3.125 / 100) = -30.1$  dB
- The average value of fundamental and harmonic frequency is: Average = Peak value +  $20 \log(\text{Duty cycle})$

<b>CHANNEL</b>	TX Channel 78	<b>DETECTOR FUNCTION</b>	Peak (PK)
<b>FREQUENCY RANGE</b>	1GHz ~ 25GHz		Average (AV)

**ANTENNA POLARITY & TEST DISTANCE: HORIZONTAL AT 3 M**

NO.	FREQ. (MHz)	EMISSION LEVEL (dBuV/m)	LIMIT (dBuV/m)	MARGIN (dB)	ANTENNA HEIGHT (m)	TABLE ANGLE (Degree)	RAW VALUE (dBuV)	CORRECTION FACTOR (dB/m)
1	*2480.00	102.8 PK			2.22 H	126	105.1	-2.3
2	*2480.00	72.7 AV			2.22 H	126	75.0	-2.3
3	2484.00	55.8 PK	74.0	-18.2	2.22 H	126	58.0	-2.2
4	2484.00	25.7 AV	54.0	-28.3	2.22 H	126	27.9	-2.2
5	4960.00	52.2 PK	74.0	-21.8	3.74 H	60	49.2	3.0
6	4960.00	22.1 AV	54.0	-31.9	3.74 H	60	19.1	3.0
7	7440.00	51.1 PK	74.0	-22.9	2.49 H	130	41.2	9.9
8	7440.00	21.0 AV	54.0	-33.0	2.49 H	130	11.1	9.9
9	12400.00	56.9 PK	74.0	-17.1	1.35 H	143	45.1	11.8
10	12400.00	26.8 AV	54.0	-27.2	1.35 H	143	15.0	11.8

**ANTENNA POLARITY & TEST DISTANCE: VERTICAL AT 3 M**

NO.	FREQ. (MHz)	EMISSION LEVEL (dBuV/m)	LIMIT (dBuV/m)	MARGIN (dB)	ANTENNA HEIGHT (m)	TABLE ANGLE (Degree)	RAW VALUE (dBuV)	CORRECTION FACTOR (dB/m)
1	*2480.00	100.1 PK			2.71 V	80	102.4	-2.3
2	*2480.00	70.0 AV			2.71 V	80	72.3	-2.3
3	2484.00	55.1 PK	74.0	-18.9	2.71 V	80	57.3	-2.2
4	2484.00	25.0 AV	54.0	-29.0	2.71 V	80	27.2	-2.2
5	4960.00	48.1 PK	74.0	-25.9	1.01 V	291	45.1	3.0
6	4960.00	18.0 AV	54.0	-36.0	1.01 V	291	15.0	3.0
7	7440.00	50.8 PK	74.0	-23.2	1.04 V	27	40.9	9.9
8	7440.00	20.7 AV	54.0	-33.3	1.04 V	27	10.8	9.9
9	12400.00	54.4 PK	74.0	-19.6	2.84 V	50	42.6	11.8
10	12400.00	24.3 AV	54.0	-29.7	2.84 V	50	12.5	11.8

**REMARKS:**

- Emission Level(dBuV/m) = Raw Value(dBuV) + Correction Factor(dB/m)
- Correction Factor(dB/m) = Antenna Factor(dB/m) + Cable Factor(dB) – Pre-Amplifier Factor(dB)
- The other emission levels were very low against the limit.
- Margin value = Emission Level – Limit value
- " \* ": Fundamental frequency.
- The DH5 packet was the worse case duty cycle for a transmit dwell time on a channel, based upon bluetooth theory the transmitter is on 0.625 \* 5 per 296.25 ms per channel. Therefore, the duty cycle correlation factor be equal to:  $20\log(3.125 / 100) = -30.1$  dB
- The average value of fundamental and harmonic frequency is: Average = Peak value + 20 log(Duty cycle)



**BT\_8DPSK**

<b>CHANNEL</b>	TX Channel 0	<b>DETECTOR FUNCTION</b>	Peak (PK)
<b>FREQUENCY RANGE</b>	1GHz ~ 25GHz		Average (AV)

**ANTENNA POLARITY & TEST DISTANCE: HORIZONTAL AT 3 M**

NO.	FREQ. (MHz)	EMISSION LEVEL (dBuV/m)	LIMIT (dBuV/m)	MARGIN (dB)	ANTENNA HEIGHT (m)	TABLE ANGLE (Degree)	RAW VALUE (dBuV)	CORRECTION FACTOR (dB/m)
1	2390.00	54.6 PK	74.0	-19.4	2.13 H	303	56.6	-2.0
2	2390.00	44.5 AV	54.0	-9.5	2.13 H	303	46.5	-2.0
3	*2402.00	101.8 PK			2.13 H	303	103.8	-2.0
4	*2402.00	71.7 AV			2.13 H	303	73.7	-2.0
5	4804.00	51.5 PK	74.0	-22.5	1.32 H	325	48.8	2.7
6	4804.00	21.4 AV	54.0	-32.6	1.32 H	325	18.7	2.7

**ANTENNA POLARITY & TEST DISTANCE: VERTICAL AT 3 M**

NO.	FREQ. (MHz)	EMISSION LEVEL (dBuV/m)	LIMIT (dBuV/m)	MARGIN (dB)	ANTENNA HEIGHT (m)	TABLE ANGLE (Degree)	RAW VALUE (dBuV)	CORRECTION FACTOR (dB/m)
1	2390.00	54.4 PK	74.0	-19.6	2.16 V	250	56.4	-2.0
2	2390.00	44.4 AV	54.0	-9.6	2.16 V	250	46.4	-2.0
3	*2402.00	99.0 PK			2.16 V	250	101.0	-2.0
4	*2402.00	68.9 AV			2.16 V	250	70.9	-2.0
5	4804.00	49.8 PK	74.0	-24.2	2.21 V	147	47.1	2.7
6	4804.00	19.7 AV	54.0	-34.3	2.21 V	147	17.0	2.7

**REMARKS:**

- Emission Level(dBuV/m) = Raw Value(dBuV) + Correction Factor(dB/m)
- Correction Factor(dB/m) = Antenna Factor(dB/m) + Cable Factor(dB) – Pre-Amplifier Factor(dB)
- The other emission levels were very low against the limit.
- Margin value = Emission Level – Limit value
- " \* ": Fundamental frequency.
- The DH5 packet was the worse case duty cycle for a transmit dwell time on a channel, based upon bluetooth theory the transmitter is on 0.625 \* 5 per 296.25 ms per channel. Therefore, the duty cycle correlation factor be equal to:  $20\log(3.125 / 100) = -30.1$  dB
- The average value of fundamental and harmonic frequency is: Average = Peak value + 20 log(Duty cycle)

<b>CHANNEL</b>	TX Channel 39	<b>DETECTOR FUNCTION</b>	Peak (PK)
<b>FREQUENCY RANGE</b>	1GHz ~ 25GHz		Average (AV)

**ANTENNA POLARITY & TEST DISTANCE: HORIZONTAL AT 3 M**

NO.	FREQ. (MHz)	EMISSION LEVEL (dBuV/m)	LIMIT (dBuV/m)	MARGIN (dB)	ANTENNA HEIGHT (m)	TABLE ANGLE (Degree)	RAW VALUE (dBuV)	CORRECTION FACTOR (dB/m)
1	2390.00	54.5 PK	74.0	-19.5	2.15 H	305	56.5	-2.0
2	2390.00	44.3 AV	54.0	-9.7	2.15 H	305	46.3	-2.0
3	*2441.00	102.2 PK			2.15 H	305	104.5	-2.3
4	*2441.00	72.1 AV			2.15 H	305	74.4	-2.3
5	2483.50	54.8 PK	74.0	-19.2	2.15 H	305	57.0	-2.2
6	2483.50	44.8 AV	54.0	-9.2	2.15 H	305	47.0	-2.2
7	4882.00	52.2 PK	74.0	-21.8	2.31 H	216	49.3	2.9
8	4882.00	22.1 AV	54.0	-31.9	2.31 H	216	19.2	2.9
9	7323.00	50.1 PK	74.0	-23.9	1.56 H	328	40.7	9.4
10	7323.00	20.0 AV	54.0	-34.0	1.56 H	328	10.6	9.4

**ANTENNA POLARITY & TEST DISTANCE: VERTICAL AT 3 M**

NO.	FREQ. (MHz)	EMISSION LEVEL (dBuV/m)	LIMIT (dBuV/m)	MARGIN (dB)	ANTENNA HEIGHT (m)	TABLE ANGLE (Degree)	RAW VALUE (dBuV)	CORRECTION FACTOR (dB/m)
1	2390.00	53.5 PK	74.0	-20.5	2.11 V	240	55.5	-2.0
2	2390.00	43.8 AV	54.0	-10.2	2.11 V	240	45.8	-2.0
3	*2441.00	99.8 PK			2.11 V	240	102.1	-2.3
4	*2441.00	69.7 AV			2.11 V	240	72.0	-2.3
5	2483.50	54.2 PK	74.0	-19.8	2.11 V	240	56.4	-2.2
6	2483.50	44.4 AV	54.0	-9.6	2.11 V	240	46.6	-2.2
7	4882.00	50.2 PK	74.0	-23.8	1.56 V	314	47.3	2.9
8	4882.00	20.1 AV	54.0	-33.9	1.56 V	314	17.2	2.9
9	7323.00	51.1 PK	74.0	-22.9	2.16 V	303	41.7	9.4
10	7323.00	21.0 AV	54.0	-33.0	2.16 V	303	11.6	9.4

**REMARKS:**

- Emission Level(dBuV/m) = Raw Value(dBuV) + Correction Factor(dB/m)
- Correction Factor(dB/m) = Antenna Factor(dB/m) + Cable Factor(dB) – Pre-Amplifier Factor(dB)
- The other emission levels were very low against the limit.
- Margin value = Emission Level – Limit value
- " \* ": Fundamental frequency.
- The DH5 packet was the worse case duty cycle for a transmit dwell time on a channel, based upon bluetooth theory the transmitter is on 0.625 \* 5 per 296.25 ms per channel. Therefore, the duty cycle correlation factor be equal to:  $20\log(3.125 / 100) = -30.1$  dB
- The average value of fundamental and harmonic frequency is: Average = Peak value +  $20 \log(\text{Duty cycle})$

<b>CHANNEL</b>	TX Channel 78	<b>DETECTOR FUNCTION</b>	Peak (PK)
<b>FREQUENCY RANGE</b>	1GHz ~ 25GHz		Average (AV)

**ANTENNA POLARITY & TEST DISTANCE: HORIZONTAL AT 3 M**

NO.	FREQ. (MHz)	EMISSION LEVEL (dBuV/m)	LIMIT (dBuV/m)	MARGIN (dB)	ANTENNA HEIGHT (m)	TABLE ANGLE (Degree)	RAW VALUE (dBuV)	CORRECTION FACTOR (dB/m)
1	*2480.00	102.3 PK			2.17 H	297	104.6	-2.3
2	*2480.00	72.2 AV			2.17 H	297	74.5	-2.3
3	2483.50	55.1 PK	74.0	-18.9	2.17 H	297	57.3	-2.2
4	2483.50	25.0 AV	54.0	-29.0	2.17 H	297	27.2	-2.2
5	4960.00	51.3 PK	74.0	-22.7	2.36 H	87	48.3	3.0
6	4960.00	21.2 AV	54.0	-32.8	2.36 H	87	18.2	3.0
7	7440.00	49.6 PK	74.0	-24.4	2.45 H	255	39.7	9.9
8	7440.00	19.5 AV	54.0	-34.5	2.45 H	255	9.6	9.9

**ANTENNA POLARITY & TEST DISTANCE: VERTICAL AT 3 M**

NO.	FREQ. (MHz)	EMISSION LEVEL (dBuV/m)	LIMIT (dBuV/m)	MARGIN (dB)	ANTENNA HEIGHT (m)	TABLE ANGLE (Degree)	RAW VALUE (dBuV)	CORRECTION FACTOR (dB/m)
1	*2480.00	99.8 PK			2.09 V	256	102.1	-2.3
2	*2480.00	69.7 AV			2.09 V	256	72.0	-2.3
3	2483.50	54.3 PK	74.0	-19.7	2.09 V	256	56.5	-2.2
4	2483.50	24.2 AV	54.0	-29.8	2.09 V	256	26.4	-2.2
5	4960.00	49.9 PK	74.0	-24.1	2.35 V	215	46.9	3.0
6	4960.00	19.8 AV	54.0	-34.2	2.35 V	215	16.8	3.0
7	7440.00	50.2 PK	74.0	-23.8	1.58 V	321	40.3	9.9
8	7440.00	20.1 AV	54.0	-33.9	1.58 V	321	10.2	9.9

**REMARKS:**

- Emission Level(dBuV/m) = Raw Value(dBuV) + Correction Factor(dB/m)
- Correction Factor(dB/m) = Antenna Factor(dB/m) + Cable Factor(dB) – Pre-Amplifier Factor(dB)
- The other emission levels were very low against the limit.
- Margin value = Emission Level – Limit value
- " \* ": Fundamental frequency.
- The DH5 packet was the worse case duty cycle for a transmit dwell time on a channel, based upon bluetooth theory the transmitter is on 0.625 \* 5 per 296.25 ms per channel. Therefore, the duty cycle correlation factor be equal to:  $20\log(3.125 / 100) = -30.1$  dB
- The average value of fundamental and harmonic frequency is: Average = Peak value + 20 log(Duty cycle)

Below 1GHz Data:

BT\_GFSK

<b>CHANNEL</b>	TX Channel 78	<b>DETECTOR FUNCTION</b>	Quasi-Peak (QP)
<b>FREQUENCY RANGE</b>	9kHz ~ 1GHz		

**ANTENNA POLARITY & TEST DISTANCE: HORIZONTAL AT 3 M**

NO.	FREQ. (MHz)	EMISSION LEVEL (dBuV/m)	LIMIT (dBuV/m)	MARGIN (dB)	ANTENNA HEIGHT (m)	TABLE ANGLE (Degree)	RAW VALUE (dBuV)	CORRECTION FACTOR (dB/m)
1	68.39	26.6 QP	40.0	-13.4	2.00 H	40	35.9	-9.3
2	179.99	28.0 QP	43.5	-15.5	1.50 H	306	37.4	-9.4
3	240.00	32.0 QP	46.0	-14.0	1.00 H	83	41.4	-9.4
4	355.97	28.7 QP	46.0	-17.3	1.00 H	360	34.5	-5.8
5	423.97	29.7 QP	46.0	-16.3	2.00 H	221	33.5	-3.8
6	611.95	30.5 QP	46.0	-15.5	1.50 H	171	30.0	0.5

**ANTENNA POLARITY & TEST DISTANCE: VERTICAL AT 3 M**

NO.	FREQ. (MHz)	EMISSION LEVEL (dBuV/m)	LIMIT (dBuV/m)	MARGIN (dB)	ANTENNA HEIGHT (m)	TABLE ANGLE (Degree)	RAW VALUE (dBuV)	CORRECTION FACTOR (dB/m)
1	40.50	33.1 QP	40.0	-6.9	1.00 V	160	41.3	-8.2
2	74.30	30.0 QP	40.0	-10.0	1.00 V	286	40.9	-10.9
3	179.50	24.3 QP	43.5	-19.2	1.00 V	276	33.6	-9.3
4	240.03	24.9 QP	46.0	-21.1	1.00 V	234	34.3	-9.4
5	488.03	29.8 QP	46.0	-16.2	1.00 V	360	32.3	-2.5
6	616.00	31.5 QP	46.0	-14.5	1.00 V	217	31.0	0.5

**REMARKS:**

1. Emission Level(dBuV/m) = Raw Value(dBuV) + Correction Factor(dB/m)
2. Correction Factor(dB/m) = Antenna Factor(dB/m) + Cable Factor(dB) – Pre-Amplifier Factor(dB)
3. The other emission levels were very low against the limit.
4. Margin value = Emission Level – Limit value

## 4.2 Conducted Emission Measurement

### 4.2.1 Limits of Conducted Emission Measurement

Frequency (MHz)	Conducted Limit (dBuV)	
	Quasi-peak	Average
0.15 - 0.5	66 - 56	56 - 46
0.50 - 5.0	56	46
5.0 - 30.0	60	50

Note: 1. The lower limit shall apply at the transition frequencies.

2. The limit decreases in line with the logarithm of the frequency in the range of 0.15 to 0.50MHz.

### 4.2.2 Test Instruments

DESCRIPTION & MANUFACTURER	MODEL NO.	SERIAL NO.	CALIBRATED DATE	CALIBRATED UNTIL
Test Receiver R&S	ESCS 30	847124/029	Nov. 01, 2017	Oct. 31, 2018
Line-Impedance Stabilization Network (for EUT) R&S	ESH3-Z5	848773/004	Nov. 15, 2017	Nov. 14, 2018
Line-Impedance Stabilization Network (for Peripheral) R&S	ENV216	100072	June 03, 2017	June 02, 2018
50 ohms Terminator	N/A	EMC-02	Sep. 22, 2017	Sep. 21, 2018
RF Cable	5D-FB	COCCAB-001	Sep. 29, 2017	Sep. 28, 2018
Fixed attenuator EMEC	STI02-2200-10	003	Mar. 16, 2018	Mar. 15, 2019
Software BVADT	BVADT_Cond_ V7.3.7.4	NA	NA	NA

**Note:**

1. The calibration interval of the above test instruments are 12 months and the calibrations are traceable to NML/ROC and NIST/USA.
2. The test was performed in Conduction 1.
- 3 Tested Date:Mar. 28, 2018

#### 4.2.3 Test Procedures

- The EUT was placed 0.4 meters from the conducting wall of the shielded room with EUT being connected to the power mains through a line impedance stabilization network (LISN). Other support units were connected to the power mains through another LISN. The two LISNs provide 50 ohm/ 50uH of coupling impedance for the measuring instrument.
- Both lines of the power mains connected to the EUT were checked for maximum conducted interference.
- The frequency range from 150kHz to 30MHz was searched. Emission levels under (Limit - 20dB) was not recorded.

**NOTE:** The resolution bandwidth and video bandwidth of test receiver is 9kHz for quasi-peak detection (QP) and average detection (AV) at frequency 0.15MHz-30MHz.

#### 4.2.4 Deviation From Test Standard

No deviation.

#### 4.2.5 Test Setup

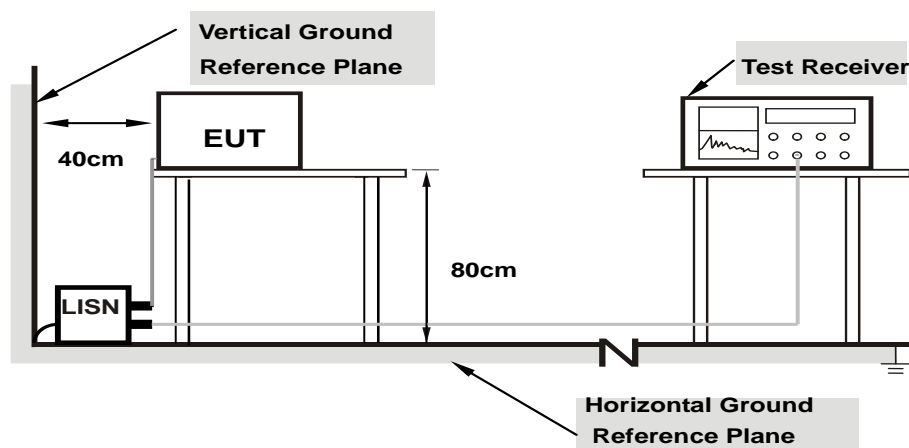

**Note: 1.Support units were connected to second LISN.**

For the actual test configuration, please refer to the attached file (Test Setup Photo).

#### 4.2.6 EUT Operating Condition

Same as 4.1.6.

#### 4.2.7 Test Results (Mode 1)

Phase	Line (L)	Detector Function	Quasi-Peak (QP) / Average (AV)
-------	----------	-------------------	--------------------------------

No	Freq. [MHz]	Corr.	Reading Value		Emission Level		Limit		Margin	
		Factor (dB)	[dB (uV)]		[dB (uV)]		[dB (uV)]		(dB)	
		Q.P.	AV.	Q.P.	AV.	Q.P.	AV.	Q.P.	AV.	
1	0.15781	10.05	26.71	8.16	36.76	18.21	65.58	55.58	-28.82	-37.37
2	0.21641	10.07	21.18	3.00	31.25	13.07	62.96	52.96	-31.71	-39.89
3	0.41172	10.12	33.26	21.37	43.38	31.49	57.61	47.61	-14.23	-16.12
4	0.81406	10.15	6.53	-2.63	16.68	7.52	56.00	46.00	-39.32	-38.48
5	6.60547	10.50	8.07	0.89	18.57	11.39	60.00	50.00	-41.43	-38.61
6	25.87109	11.50	16.30	12.41	27.80	23.91	60.00	50.00	-32.20	-26.09

#### REMARKS:

1. Q.P. and AV. are abbreviations of quasi-peak and average individually.
2. The emission levels of other frequencies were very low against the limit.
3. Margin value = Emission level - Limit value
4. Correction factor = Insertion loss + Cable loss
5. Emission Level = Correction Factor + Reading Value.

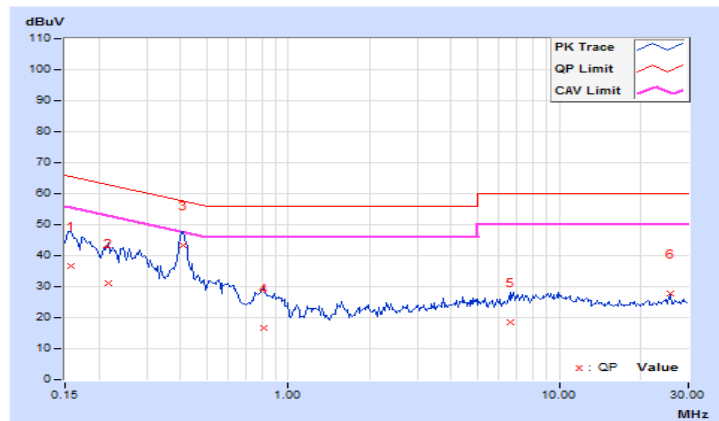

Phase	Neutral (N)	Detector Function	Quasi-Peak (QP) / Average (AV)
-------	-------------	-------------------	--------------------------------

No	Freq. [MHz]	Corr.	Reading Value		Emission Level		Limit		Margin	
		Factor	[dB (uV)]		[dB (uV)]		[dB (uV)]		(dB)	
		(dB)	Q.P.	AV.	Q.P.	AV.	Q.P.	AV.	Q.P.	AV.
1	0.15000	9.95	26.94	8.06	36.89	18.01	66.00	56.00	-29.11	-37.99
2	0.18516	9.97	23.76	5.87	33.73	15.84	64.25	54.25	-30.52	-38.41
3	0.40781	10.02	28.18	14.33	38.20	24.35	57.69	47.69	-19.49	-23.34
4	0.67734	10.03	10.67	-1.53	20.70	8.50	56.00	46.00	-35.30	-37.50
5	9.09375	10.49	13.28	0.10	23.77	10.59	60.00	50.00	-36.23	-39.41
6	25.87109	11.24	17.55	10.40	28.79	21.64	60.00	50.00	-31.21	-28.36

**REMARKS:**

1. Q.P. and AV. are abbreviations of quasi-peak and average individually.
2. The emission levels of other frequencies were very low against the limit.
3. Margin value = Emission level - Limit value
4. Correction factor = Insertion loss + Cable loss
5. Emission Level = Correction Factor + Reading Value.

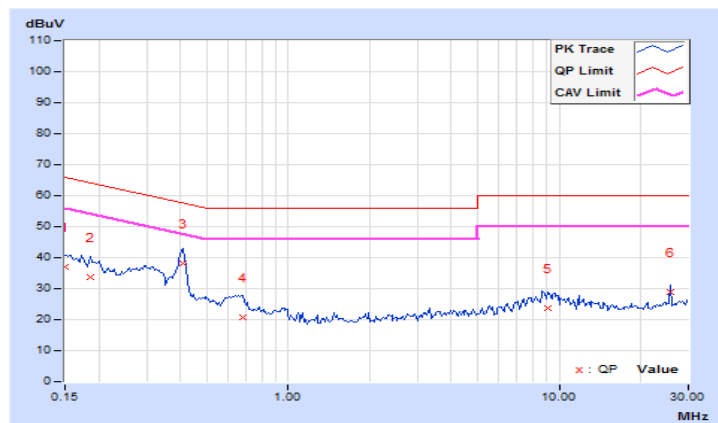



#### 4.2.8 Test Results (Mode 2)

Phase	Line (L)	Detector Function	Quasi-Peak (QP) / Average (AV)
-------	----------	-------------------	--------------------------------

No	Freq. [MHz]	Corr. Factor	Reading Value [dB (uV)]		Emission Level [dB (uV)]		Limit [dB (uV)]		Margin (dB)	
		(dB)	Q.P.	AV.	Q.P.	AV.	Q.P.	AV.	Q.P.	AV.
	<b>1</b>	<b>0.18516</b>	<b>10.05</b>	<b>44.63</b>	<b>22.83</b>	<b>54.68</b>	<b>32.88</b>	<b>64.25</b>	<b>54.25</b>	<b>-9.57</b>
2	0.20859	10.06	28.14	16.58	38.20	26.64	63.26	53.26	-25.06	-26.62
3	0.27109	10.08	31.27	11.58	41.35	21.66	61.08	51.08	-19.73	-29.42
4	0.80234	10.14	23.16	11.84	33.30	21.98	56.00	46.00	-22.70	-24.02
5	2.91016	10.23	16.18	11.07	26.41	21.30	56.00	46.00	-29.59	-24.70
6	18.58984	11.02	10.59	4.38	21.61	15.40	60.00	50.00	-38.39	-34.60

#### REMARKS:

1. Q.P. and AV. are abbreviations of quasi-peak and average individually.
2. The emission levels of other frequencies were very low against the limit.
3. Margin value = Emission level - Limit value
4. Correction factor = Insertion loss + Cable loss
5. Emission Level = Correction Factor + Reading Value.

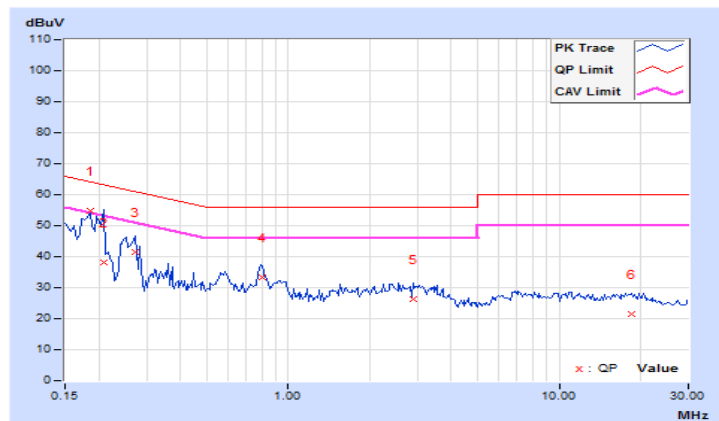

Phase	Neutral (N)	Detector Function	Quasi-Peak (QP) / Average (AV)
-------	-------------	-------------------	--------------------------------

No	Freq. [MHz]	Corr.	Reading Value		Emission Level		Limit		Margin	
		Factor	[dB (uV)]		[dB (uV)]		[dB (uV)]		(dB)	
		(dB)	Q.P.	AV.	Q.P.	AV.	Q.P.	AV.	Q.P.	AV.
1	0.15781	9.95	40.72	28.08	50.67	38.03	65.58	55.58	-14.91	-17.55
2	0.19687	9.96	23.82	10.38	33.78	20.34	63.74	53.74	-29.96	-33.40
3	0.27109	9.97	17.24	6.68	27.21	16.65	61.08	51.08	-33.87	-34.43
4	0.79063	10.02	21.45	9.92	31.47	19.94	56.00	46.00	-24.53	-26.06
5	2.69922	10.09	15.18	9.47	25.27	19.56	56.00	46.00	-30.73	-26.44
6	19.89453	10.89	8.51	1.67	19.40	12.56	60.00	50.00	-40.60	-37.44

**REMARKS:**

1. Q.P. and AV. are abbreviations of quasi-peak and average individually.
2. The emission levels of other frequencies were very low against the limit.
3. Margin value = Emission level - Limit value
4. Correction factor = Insertion loss + Cable loss
5. Emission Level = Correction Factor + Reading Value.

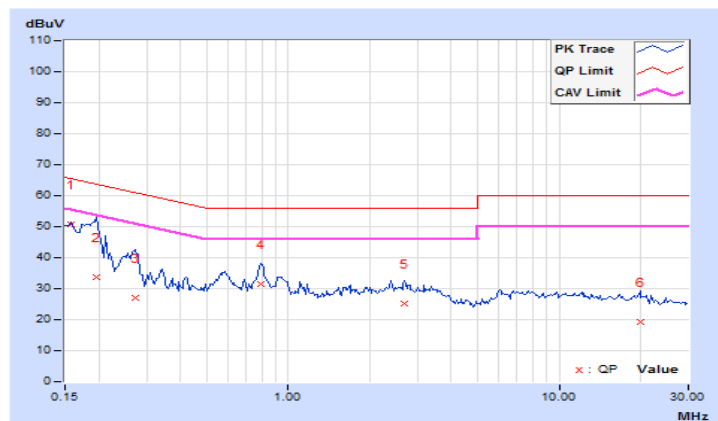

#### 4.2.9 Test Results (Mode 3)

Phase	Line (L)	Detector Function	Quasi-Peak (QP) / Average (AV)
-------	----------	-------------------	--------------------------------

No	Freq. [MHz]	Corr.	Reading Value		Emission Level		Limit		Margin	
		Factor	[dB (uV)]		[dB (uV)]		[dB (uV)]		(dB)	
	(dB)	Q.P.	AV.	Q.P.	AV.	Q.P.	AV.	Q.P.	AV.	
1	0.15000	10.05	36.59	20.11	46.64	30.16	66.00	56.00	-19.36	-25.84
2	0.16953	10.05	32.93	15.22	42.98	25.27	64.98	54.98	-22.00	-29.71
3	0.40356	10.12	35.44	21.94	45.56	32.06	57.78	47.78	-12.22	-15.72
4	1.15625	10.18	8.45	1.18	18.63	11.36	56.00	46.00	-37.37	-34.64
5	7.75391	10.57	13.07	4.82	23.64	15.39	60.00	50.00	-36.36	-34.61
6	25.87109	11.50	20.24	16.44	31.74	27.94	60.00	50.00	-28.26	-22.06

#### REMARKS:

1. Q.P. and AV. are abbreviations of quasi-peak and average individually.
2. The emission levels of other frequencies were very low against the limit.
3. Margin value = Emission level - Limit value
4. Correction factor = Insertion loss + Cable loss
5. Emission Level = Correction Factor + Reading Value.

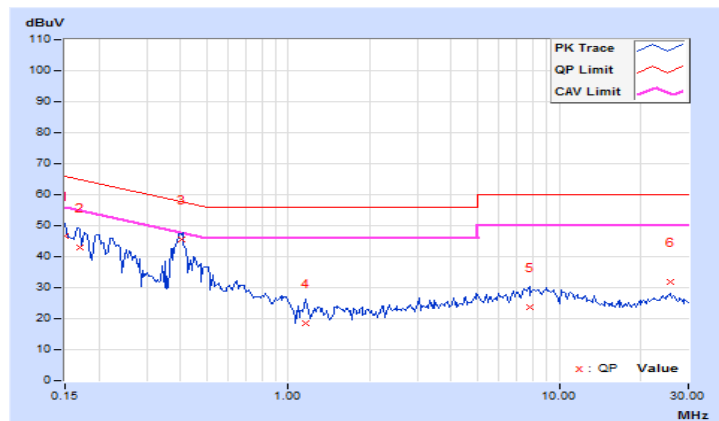

Phase	Neutral (N)	Detector Function	Quasi-Peak (QP) / Average (AV)
-------	-------------	-------------------	--------------------------------

No	Freq. [MHz]	Corr.	Reading Value		Emission Level		Limit		Margin	
		Factor	[dB (uV)]		[dB (uV)]		[dB (uV)]		(dB)	
		(dB)	Q.P.	AV.	Q.P.	AV.	Q.P.	AV.	Q.P.	AV.
1	0.15391	9.96	28.25	10.11	38.21	20.07	65.79	55.79	-27.58	-35.72
2	0.24375	9.98	21.92	2.01	31.90	11.99	61.97	51.97	-30.07	-39.98
3	0.40781	10.02	29.13	15.72	39.15	25.74	57.69	47.69	-18.54	-21.95
4	0.86484	10.04	3.07	-7.04	13.11	3.00	56.00	46.00	-42.89	-43.00
5	9.49219	10.51	13.84	0.83	24.35	11.34	60.00	50.00	-35.65	-38.66
6	25.87500	11.24	22.53	14.53	33.77	25.77	60.00	50.00	-26.23	-24.23

**REMARKS:**

1. Q.P. and AV. are abbreviations of quasi-peak and average individually.
2. The emission levels of other frequencies were very low against the limit.
3. Margin value = Emission level - Limit value
4. Correction factor = Insertion loss + Cable loss
5. Emission Level = Correction Factor + Reading Value.

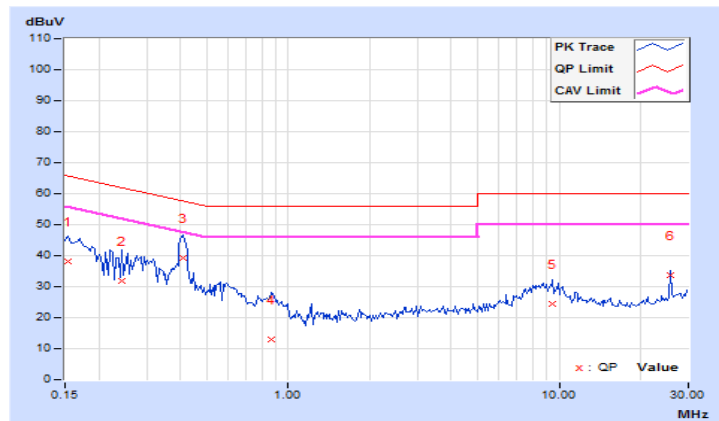

### 4.3 Number of Hopping Frequency Used

#### 4.3.1 Limits of Hopping Frequency Used Measurement

At least 15 channels frequencies, and should be equally spaced.

#### 4.3.2 Test Setup

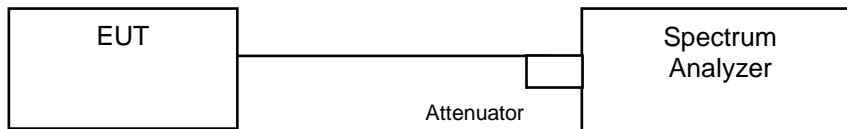

#### 4.3.3 Test Instruments

Refer to section 4.1.2 to get information of above instrument.

#### 4.3.4 Test Procedure

- a. Check the calibration of the measuring instrument (SA) using either an internal calibrator or a known signal from an external generator.
- b. Turn on the EUT and connect its antenna terminal to measurement via a low loss cable. Then set it to any one measured frequency within its operating range and make sure the instrument is operated in its linear range.
- c. Set the SA on MaxHold Mode, and then keep the EUT in hopping mode. Record all the signals from each channel until each one has been recorded.
- d. Set the SA on View mode and then plot the result on SA screen.
- e. Repeat above procedures until all frequencies measured were complete.

#### 4.3.5 Deviation from Test Standard

No deviation.

### 4.3.6 Test Results

There are 79 hopping frequencies in the hopping mode. Please refer to next page for the test result. On the plots, it shows that the hopping frequencies are equally spaced.

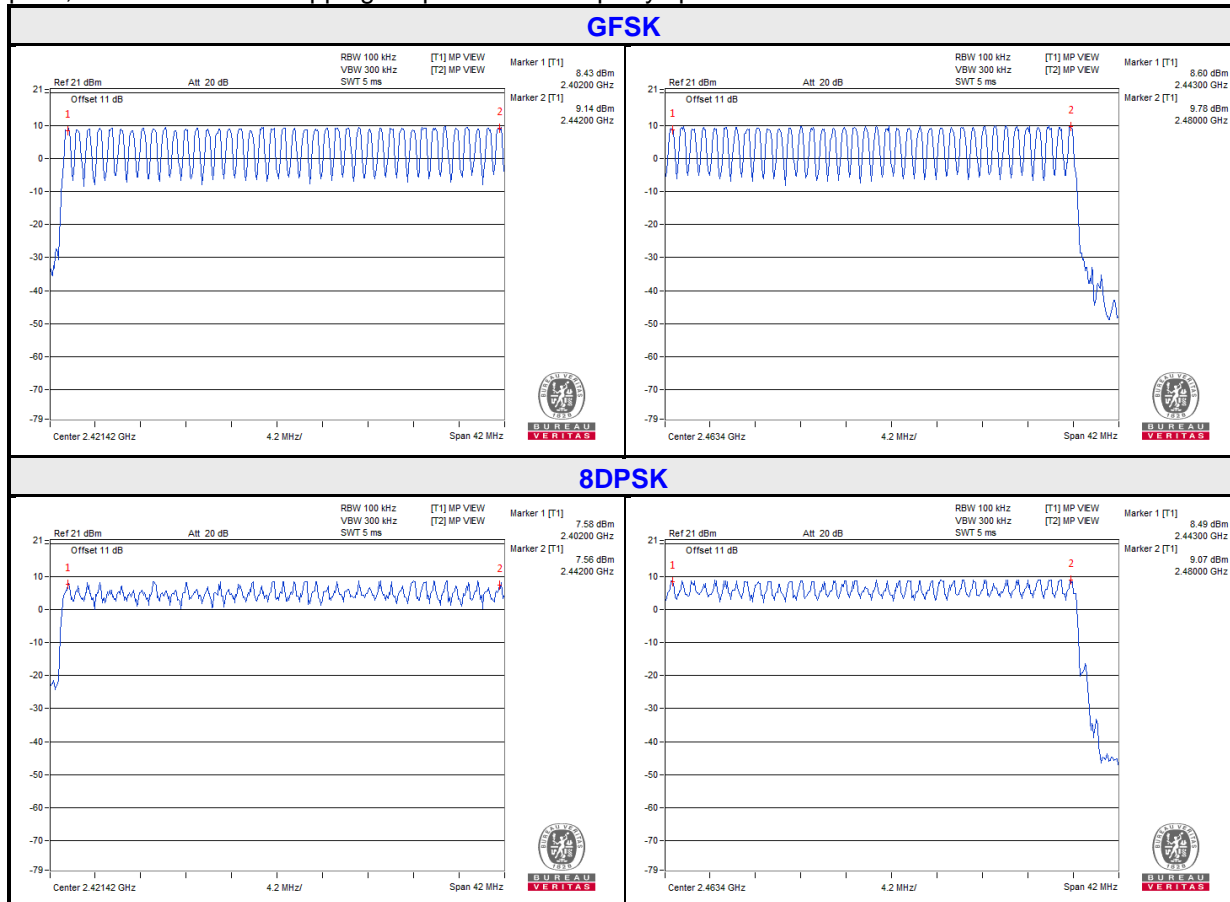

#### 4.4 Dwell Time on Each Channel

##### 4.4.1 Limits of Dwell Time on Each Channel Measurement

The average time of occupancy on any channel shall not be greater than 0.4 seconds within a period of 0.4 seconds multiplied by the number of hopping channels employed.

##### 4.4.2 Test Setup

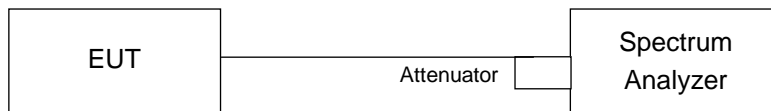

##### 4.4.3 Test Instruments

Refer to section 4.1.2 to get information of above instrument.

##### 4.4.4 Test Procedures

- a. Check the calibration of the measuring instrument (SA) using either an internal calibrator or a known signal from an external generator.
- b. Turn on the EUT and connect its antenna terminal to measurement via a low loss cable. Then set it to any one measured frequency within its operating range and make sure the instrument is operated in its linear range.
- c. Adjust the center frequency of SA on any frequency be measured and set SA to zero span mode. And then, set RBW and VBW of spectrum analyzer to proper value.
- d. Measure the time duration of one transmission on the measured frequency. And then plot the result with time difference of this time duration.
- e. Repeat above procedures until all different time-slot modes have been completed.

##### 4.4.5 Deviation from Test Standard

No deviation.

#### 4.4.6 Test Results

##### GFSK

Mode	Number of transmission in a 31.6 (79Hopping*0.4)	Length of transmission time (msec)	Result (msec)	Limit (msec)
DH1	50 (times / 5 sec) * 6.32 = 316 times	0.45	142.2	400
DH3	25 (times / 5 sec) * 6.32 = 158 times	1.78	281.24	400
DH5	17 (times / 5 sec) * 6.32 = 107.44 times	2.992	321.46	400

**NOTE:** Test plots of the transmitting time slot are shown on next page.



### DH1

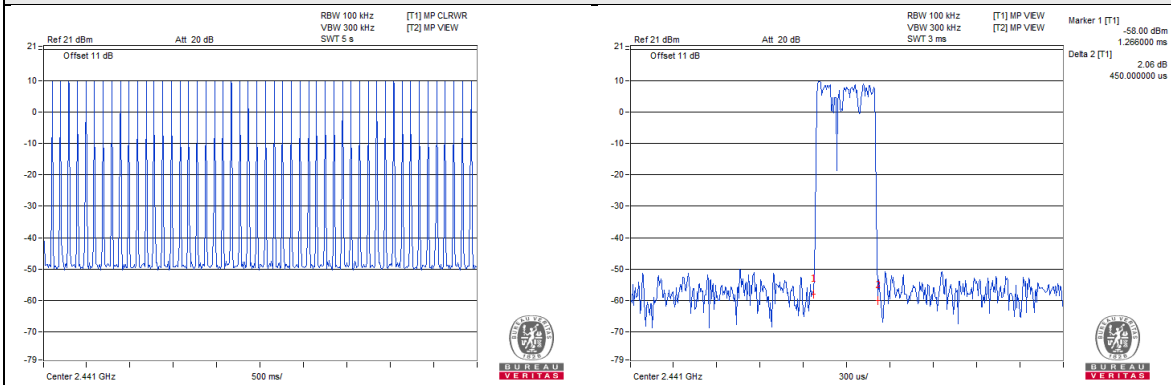

### DH3

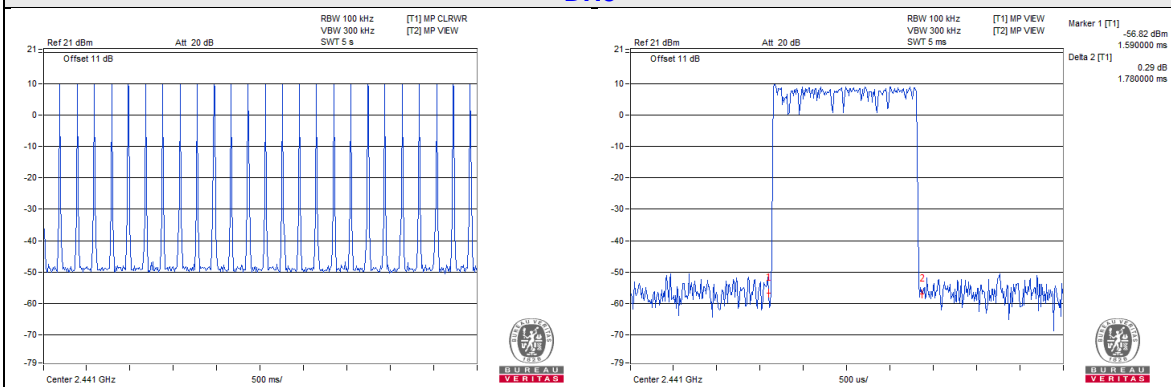

### DH5

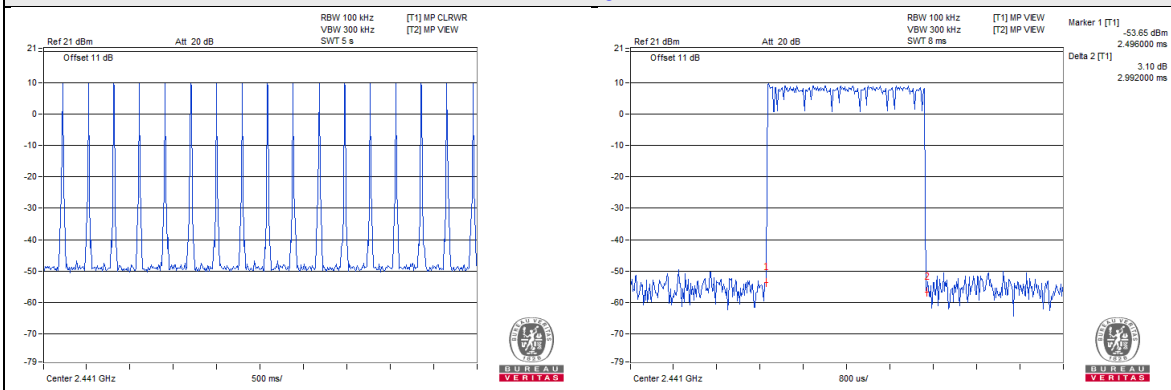

### 8DPSK

Mode	Number of transmission in a 31.6 (79Hopping*0.4)	Length of transmission time (msec)	Result (msec)	Limit (msec)
3DH1	51 (times / 5 sec) * 6.32 = 322.32 times	0.468	150.85	400
3DH3	25 (times / 5 sec) * 6.32 = 158 times	1.72	271.76	400
3DH5	17 (times / 5 sec) * 6.32 = 107.44 times	3.056	328.34	400

**NOTE:** Test plots of the transmitting time slot are shown on next page.

### 3DH1

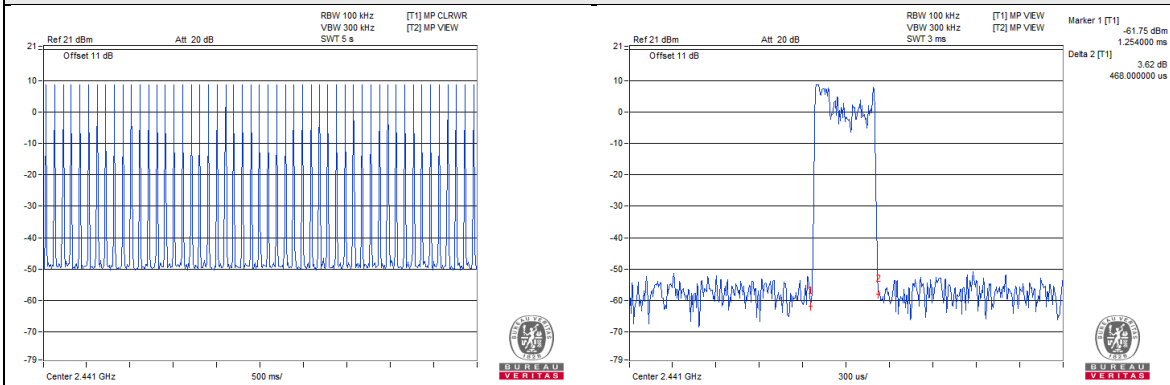

### 3DH3

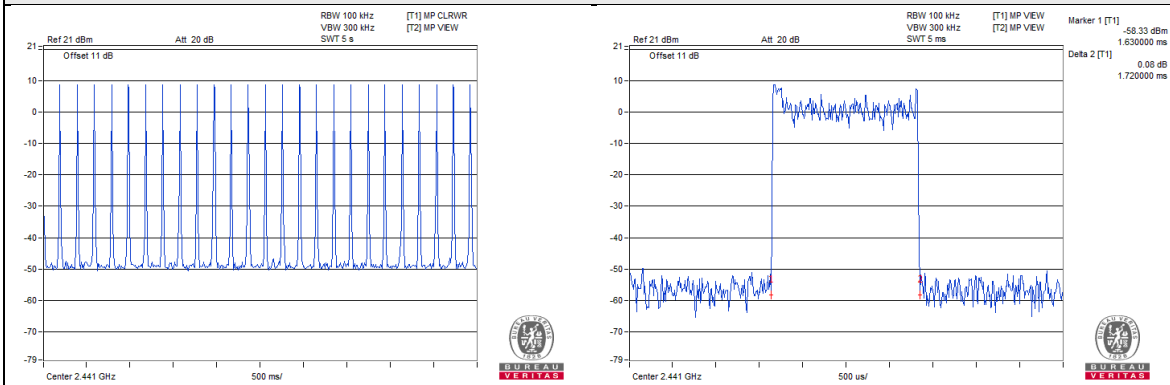

### 3DH5

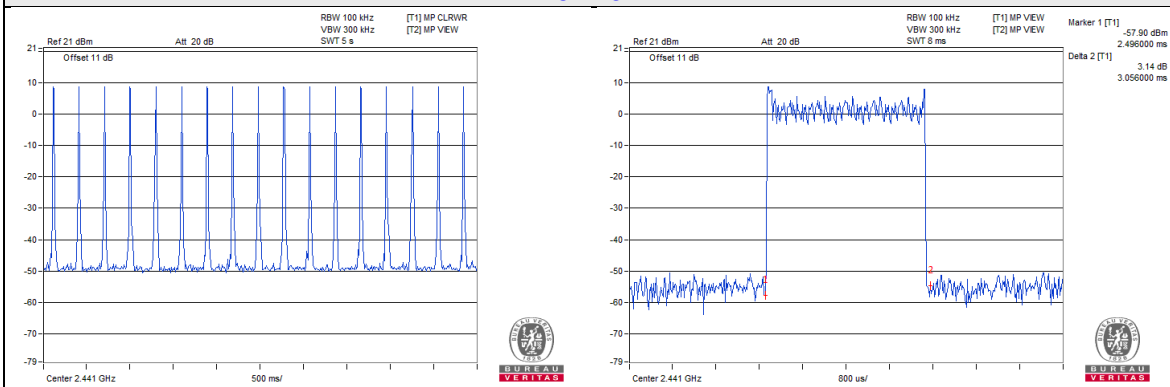

## 4.5 Channel Bandwidth

### 4.5.1 Limits of Channel Bandwidth Measurement

For frequency hopping system operating in the 2400-2483.5MHz, If the 20dB bandwidth of hopping channel is greater than 25kHz, two-thirds 20dB bandwidth of hopping channel shall be a minimum limit for the hopping channel separation.

### 4.5.2 Test Setup

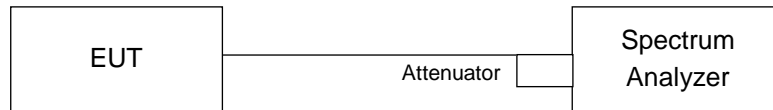

### 4.5.3 Test Instruments

Refer to section 4.1.2 to get information of above instrument.

### 4.5.4 Test Procedure

- Check the calibration of the measuring instrument using either an internal calibrator or a known signal from an external generator.
- Turn on the EUT and connect it to measurement instrument. Then set it to any one convenient frequency within its operating range. Set a reference level on the measuring instrument equal to the highest peak value.
- Measure the frequency difference of two frequencies that were attenuated 20dB from the reference level. Record the frequency difference as the emission bandwidth.
- Repeat above procedures until all frequencies measured were complete.

### 4.5.5 Deviation from Test Standard

No deviation.

### 4.5.6 EUT Operating Condition

The software provided by client enabled the EUT to transmit and receive data at lowest, middle and highest channel frequencies individually.

### 4.5.7 Test Results

Channel	Frequency (MHz)	20dB Bandwidth (MHz)	
		GFSK	8DPSK
0	2402	0.95	1.27
39	2441	0.94	1.27
78	2480	0.94	1.27

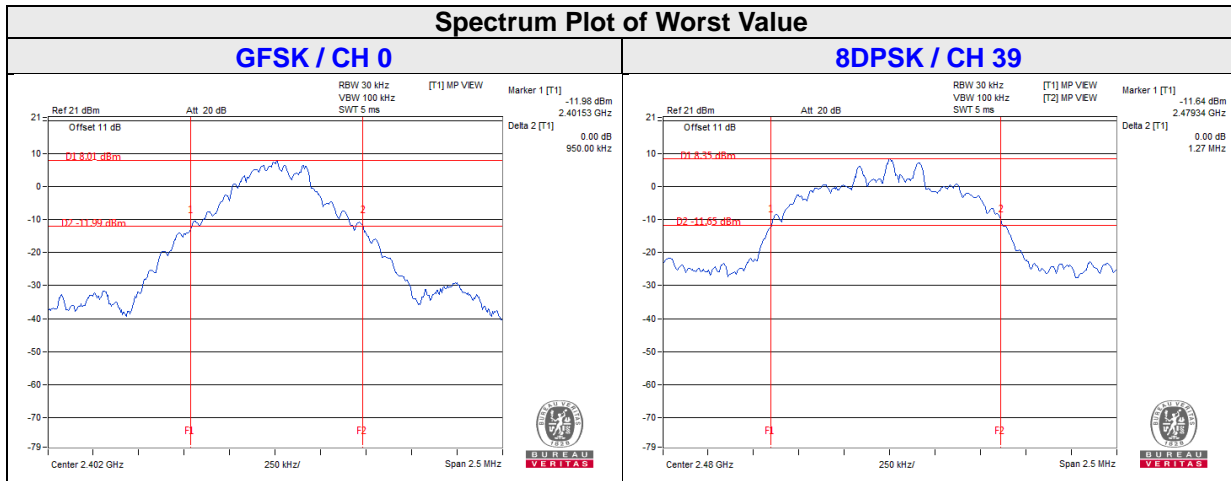

## 4.6 Hopping Channel Separation

### 4.6.1 Limits of Hopping Channel Separation Measurement

At least 25kHz or two-third of 20dB hopping channel bandwidth (whichever is greater).

### 4.6.2 Test Setup

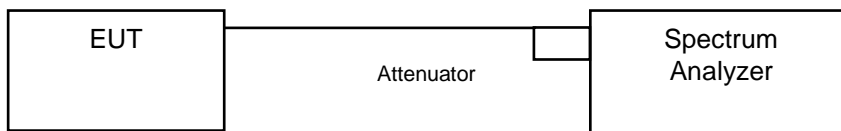

### 4.6.3 Test Instruments

Refer to section 4.1.2 to get information of above instrument.

### 4.6.4 Test Procedure

Measurement Procedure REF

- a. Check the calibration of the measuring instrument using either an internal calibrator or a known signal from an external generator.
- b. Turn on the EUT and connect it to measurement instrument. Then set it to any one convenient frequency within its operating range.
- c. By using the MaxHold function record the separation of two adjacent channels.
- d. Measure the frequency difference of these two adjacent channels by SA MARK function. And then plot the result on SA screen.
- e. Repeat above procedures until all frequencies measured were complete.

### 4.6.5 Deviation from Test Standard

No deviation.

#### 4.6.6 Test Results

Channel	Frequency (MHz)	Adjacent Channel Separation (MHz)		20dB Bandwidth (MHz)		Minimum Limit (MHz)		Pass / Fail
		GFSK	8DPSK	GFSK	8DPSK	GFSK	8DPSK	
0	2402	1.00	1.00	0.95	1.27	0.64	0.85	Pass
39	2441	1.00	1.00	0.94	1.27	0.63	0.85	Pass
78	2480	1.00	1.00	0.94	1.27	0.63	0.85	Pass

**NOTE:** The minimum limit is two-third 20dB bandwidth.

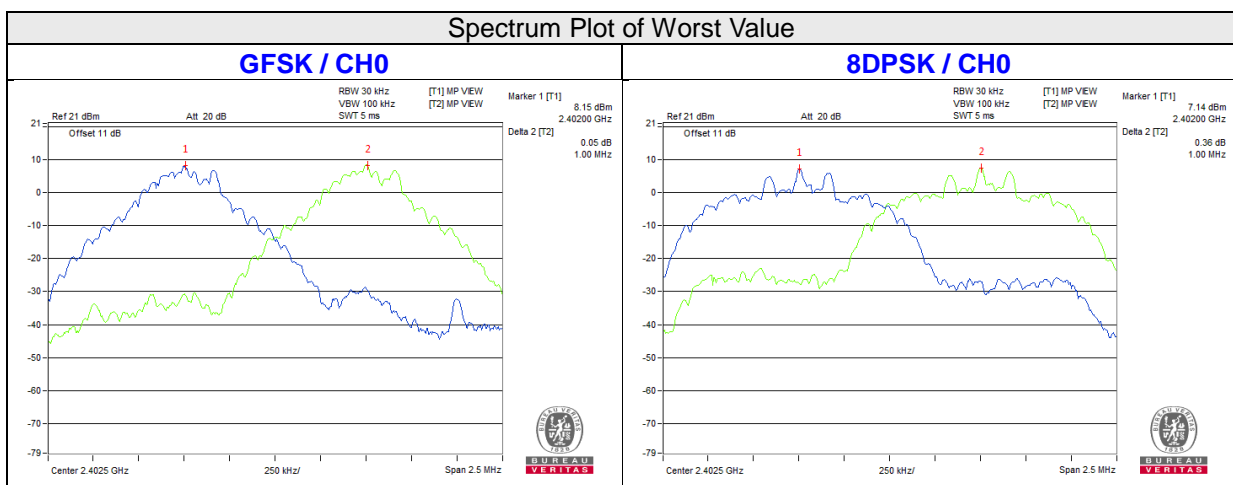

## 4.7 Maximum Output Power

### 4.7.1 Limits of Maximum Output Power Measurement

The Maximum Output Power Measurement is 125mW.

### 4.7.2 Test Setup

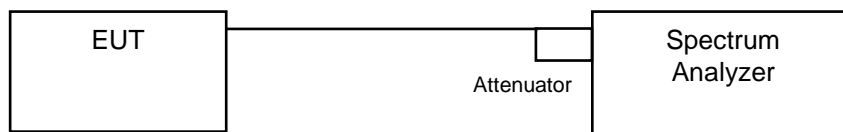

### 4.7.3 Test Instruments

Refer to section 4.1.2 to get information of above instrument.

### 4.7.4 Test Procedure

- a. Check the calibration of the measuring instrument using either an internal calibrator or a known signal from an external generator.
- b. Turn on the EUT and connect it to measurement instrument. Then set it to any one convenient frequency within its operating range. Set a reference level on the measuring instrument equal to the highest peak value.
- c. The center frequency of the spectrum analyzer is set to the fundamental frequency and using 3MHz RBW and 10 MHz VBW.
- d. Measure the captured power within the band and recording the plot.
- e. Repeat above procedures until all frequencies required were complete.

### 4.7.5 Deviation from Test Standard

No deviation.

### 4.7.6 EUT Operating Condition

The software provided by client enabled the EUT to transmit and receive data at lowest, middle and highest channel frequencies individually.



#### 4.7.7 Test Results

##### FOR PEAK POWER

Channel	Frequency (MHZ)	Peak Power (mW)		Peak Power (dBm)		Power Limit (mW)	Pass / Fail
		GFSK	8DPSK	GFSK	8DPSK		
0	2402	8.65	7.674	9.37	8.85	125	Pass
39	2441	10.046	8.77	10.02	9.43	125	Pass
78	2480	10.914	9.75	10.38	9.89	125	Pass

##### FOR AVERAGE POWER

Channel	Frequency (MHZ)	Avg. Power (mW)		Avg. Power (dBm)	
		GFSK	8DPSK	GFSK	8DPSK
0	2402	7.674	4.753	8.85	6.77
39	2441	8.872	5.902	9.48	7.71
78	2480	9.683	6.457	9.86	8.10

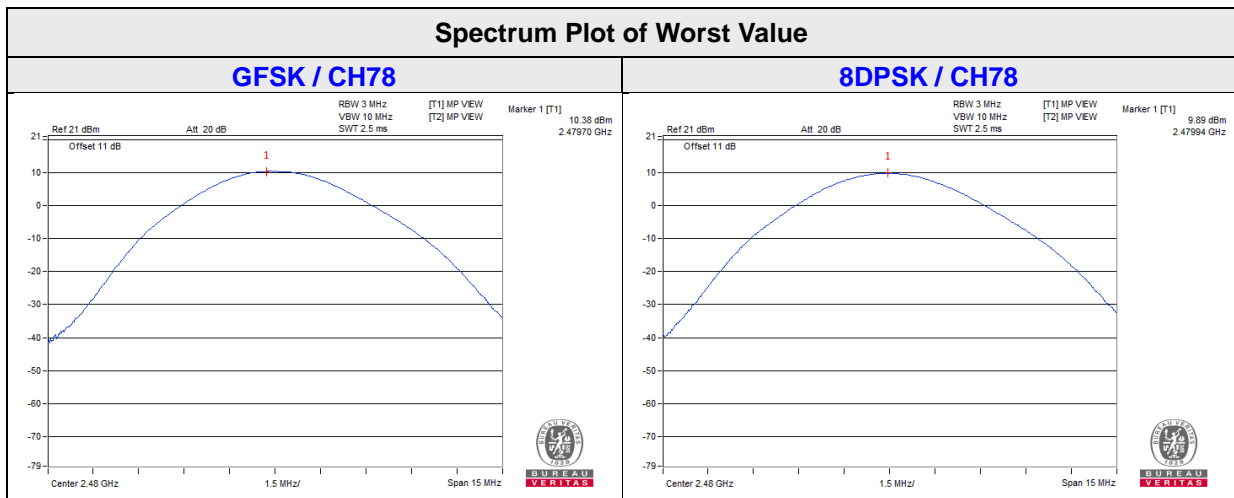

## 4.8 Conducted Out of Band Emission Measurement

### 4.8.1 Limits of Conducted Out of Band Emission Measurement

Below  $-20\text{dB}$  of the highest emission level of operating band (in 100kHz Resolution Bandwidth).

### 4.8.2 Test Instruments

Refer to section 4.1.2 to get information of above instrument.

### 4.8.3 Test Procedure

The transmitter output was connected to the spectrum analyzer via a low lose cable. Set both RBW and VBW of spectrum analyzer to 100 kHz and 300 kHz with suitable frequency span including 100 MHz bandwidth from band edge. The band edges was measured and recorded.

### 4.8.4 Deviation from Test Standard

No deviation.

### 4.8.5 EUT Operating Condition

The software provided by client enabled the EUT to transmit and receive data at lowest, middle and highest channel frequencies individually.

### 4.8.6 Test Results

The spectrum plots are attached on the following images. D1 line indicates the highest level, D2 line indicates the 20dB offset below D1. It shows compliance with the requirement.

GFSK

Hopping disabled\_Low Channel

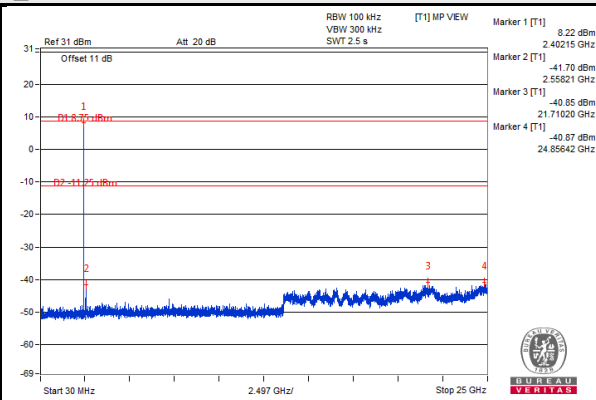
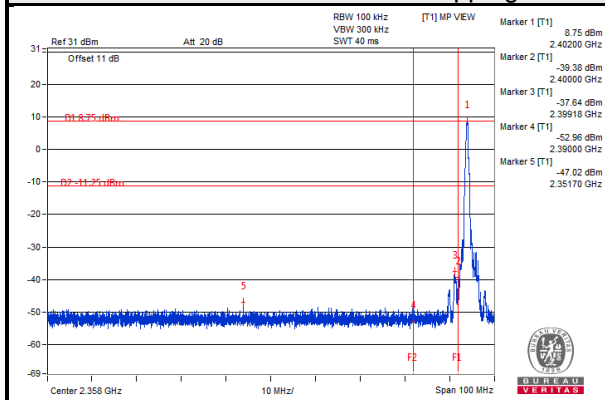

Hopping disabled\_High Channel

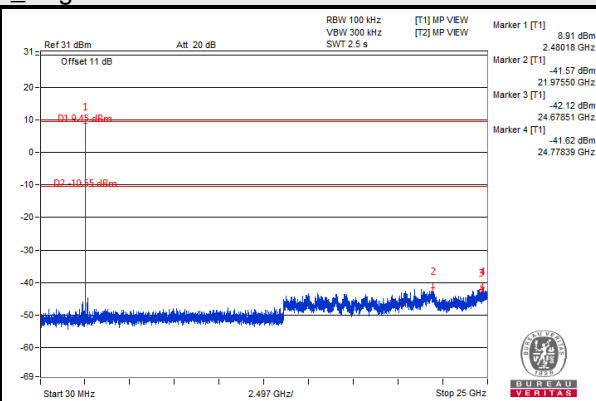
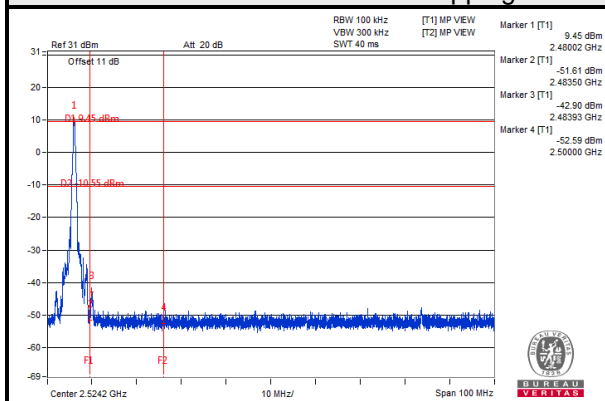

Hopping enabled\_Low Channel

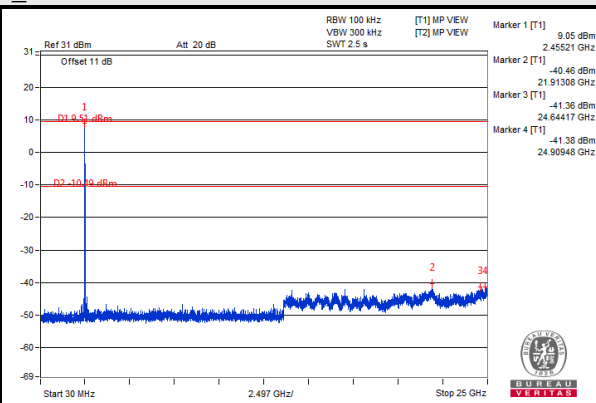
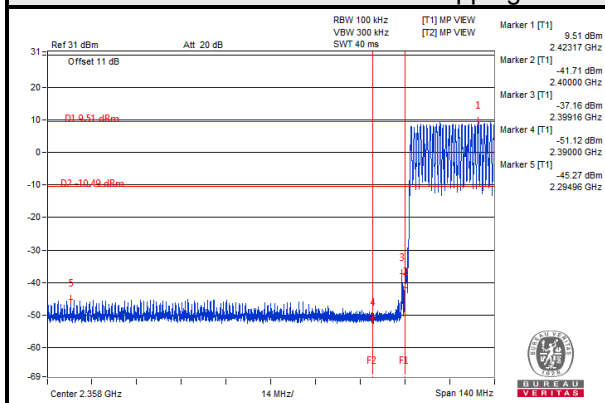

Hopping enabled\_High Channel

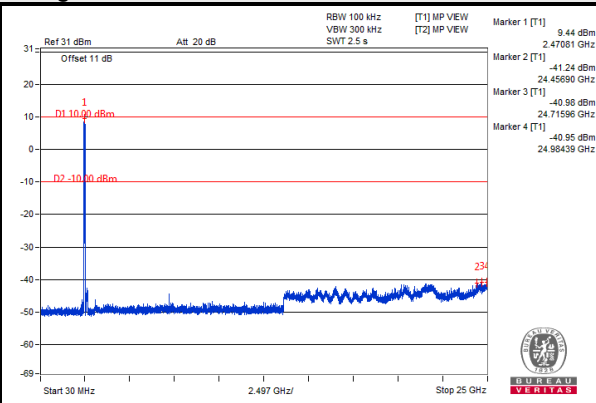
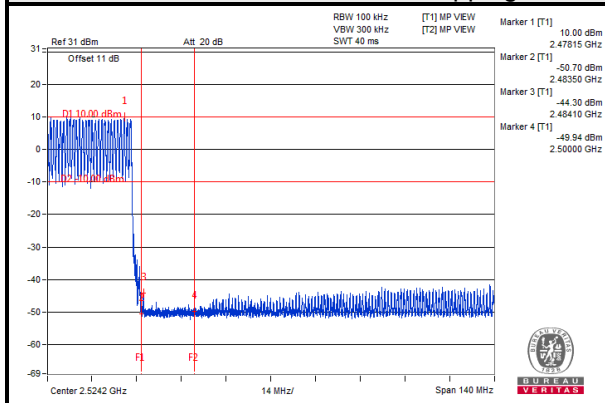

# 8DPSK

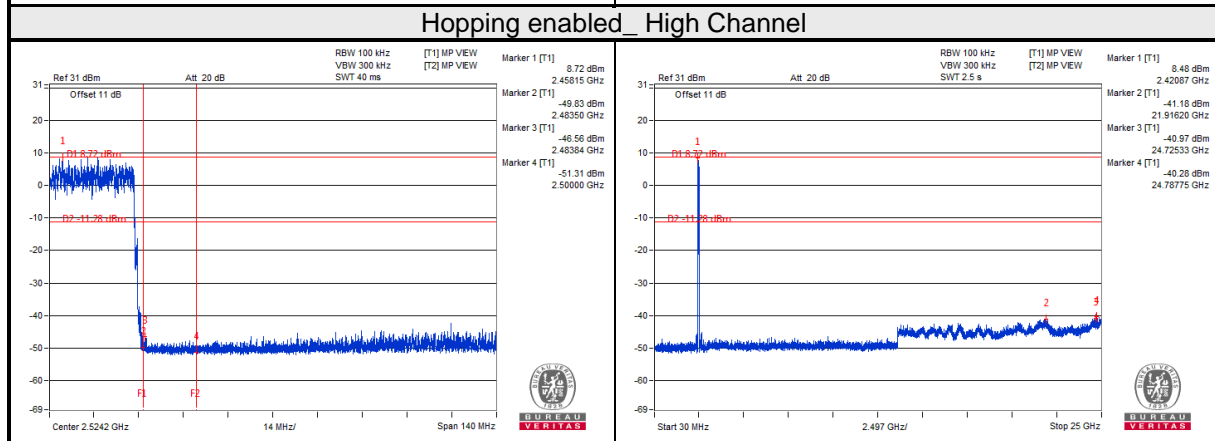
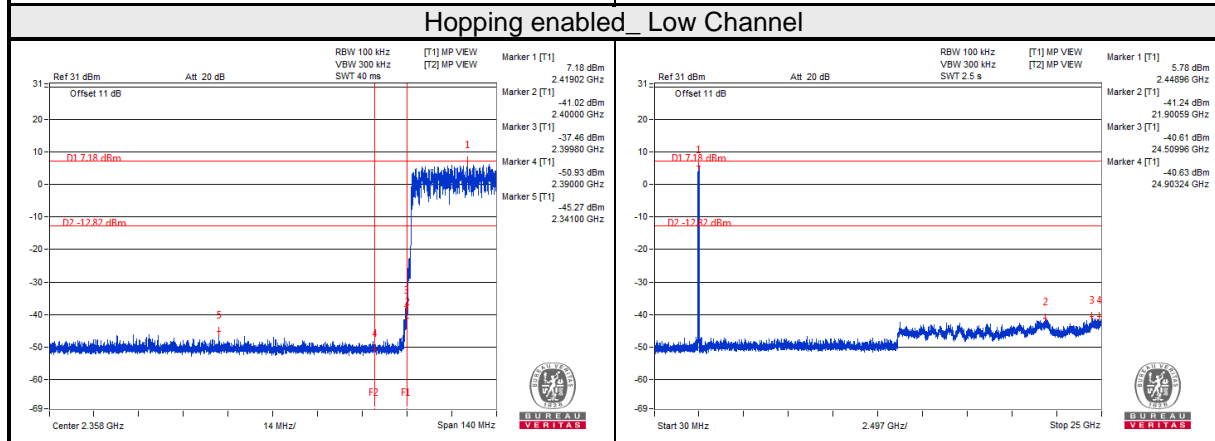
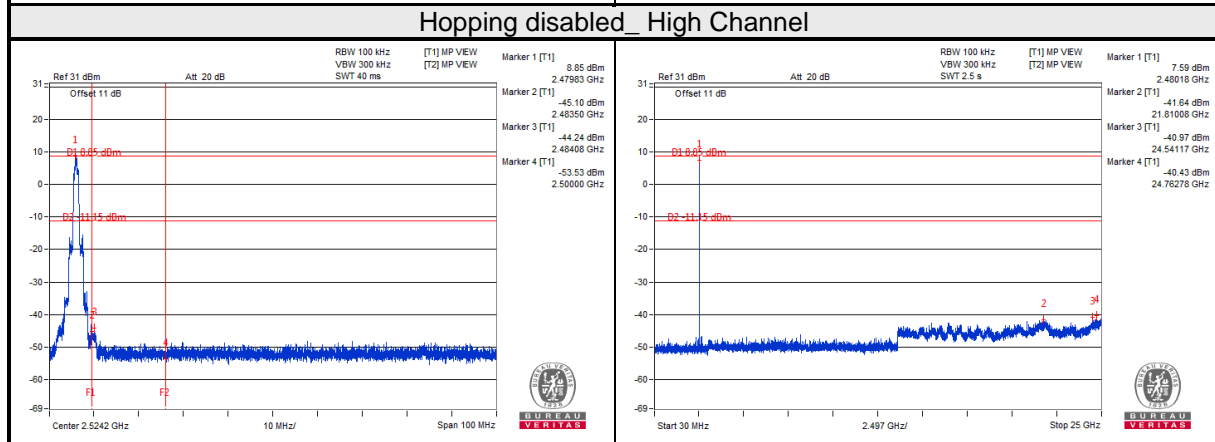
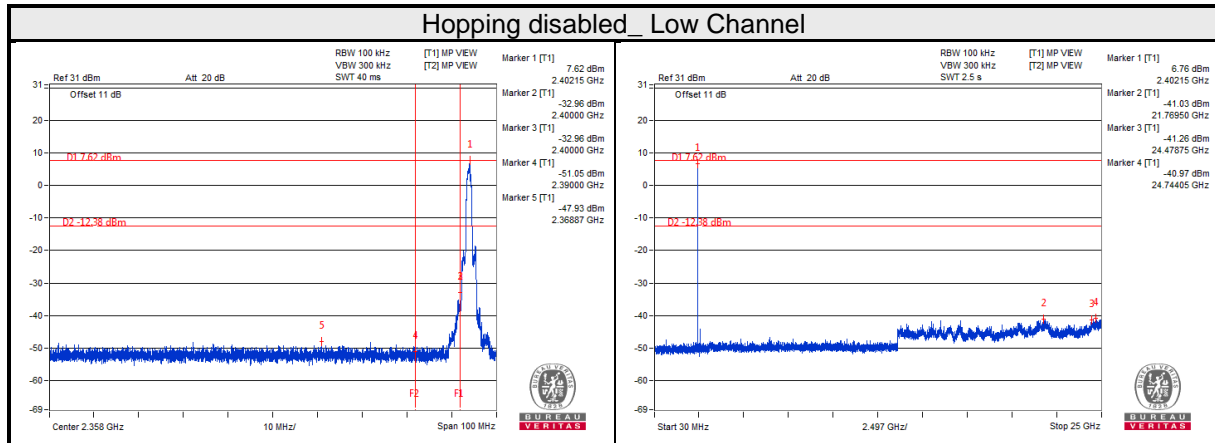

## 5 Pictures of Test Arrangements

Please refer to the attached file (Test Setup Photo).

## Appendix – Information on the Testing Laboratories

We, Bureau Veritas Consumer Products Services (H.K.) Ltd., Taoyuan Branch, were founded in 1988 to provide our best service in EMC, Radio, Telecom and Safety consultation. Our laboratories are FCC recognized accredited test firms and accredited according to ISO/IEC 17025.

If you have any comments, please feel free to contact us at the following:

**Linkou EMC/RF Lab**

Tel: 886-2-26052180

Fax: 886-2-26051924

**Hsin Chu EMC/RF/Telecom Lab**

Tel: 886-3-6668565

Fax: 886-3-6668323

**Hwa Ya EMC/RF/Safety Lab**

Tel: 886-3-3183232

Fax: 886-3-3270892

**Email:** [service.adt@tw.bureauveritas.com](mailto:service.adt@tw.bureauveritas.com)

**Web Site:** [www.bureauveritas-adt.com](http://www.bureauveritas-adt.com)

The address and road map of all our labs can be found in our web site also.

--- END ---