



# FCC TEST REPORT

**REPORT NO.:** RF130711E04

**MODEL NO.:** S-00127

**FCC ID:** JNZS00127

**RECEIVED:** July 11, 2013

**TESTED:** July 12 to 18, 2013

**ISSUED:** July 23, 2013

**APPLICANT:** LOGITECH FAR EAST LTD.

**ADDRESS:** #2 Creation Rd. 4, Science-Based Ind. Park Hsinchu  
Taiwan, R.O.C.

**ISSUED BY:** Bureau Veritas Consumer Products Services (H.K.)  
Ltd., Taoyuan Branch Hsin Chu Laboratory

**LAB ADDRESS:** No. 81-1, Lu Liao Keng, 9th Ling,Wu Lung Tsuen,  
Chiung Lin Hsiang, Hsin Chu Hsien 307, Taiwan,  
R.O.C.

**TEST LOCATION (1):** No. 81-1, Lu Liao Keng, 9th Ling,Wu Lung Tsuen,  
Chiung Lin Hsiang, Hsin Chu Hsien 307, Taiwan,  
Taiwan, R.O.C.

**TEST LOCATION (2):** No.49, Ln. 206, Wende Rd., Shangshan Tsuen,  
Chiung Lin Hsiang, Hsin Chu Hsien 307, Taiwan,  
Taiwan, R.O.C.

This report should not be used by the client to claim product certification, approval, or endorsement by TAF or any government agencies.



This report is for your exclusive use. Any copying or replication of this report to or for any other person or entity, or use of our name or trademark, is permitted only with our prior written permission. This report sets forth our findings solely with respect to the test samples identified herein. The results set forth in this report are not indicative or representative of the quality or characteristics of the lot from which a test sample was taken or any similar or identical product unless specifically and expressly noted. Our report includes all of the tests requested by you and the results thereof based upon the information that you provided to us. You have 60 days from date of issuance of this report to notify us of any material error or omission caused by our negligence, provided, however, that such notice shall be in writing and shall specifically address the issue you wish to raise. A failure to raise such issue within the prescribed time shall constitute your unqualified acceptance of the completeness of this report, the tests conducted and the correctness of the report contents. Unless specific mention, the uncertainty of measurement has been explicitly taken into account to declare the compliance or non-compliance to the specification

## TABLE OF CONTENTS

RELEASE CONTROL RECORD .....	4
1 CERTIFICATION .....	5
2 SUMMARY OF TEST RESULTS.....	6
2.1 MEASUREMENT UNCERTAINTY .....	7
3 GENERAL INFORMATION .....	8
3.1 GENERAL DESCRIPTION OF EUT.....	8
3.2 DESCRIPTION OF TEST MODES.....	9
3.3 TEST MODE APPLICABILITY AND TESTED CHANNEL DETAIL: .....	10
3.4 GENERAL DESCRIPTION OF APPLIED STANDARDS .....	12
3.5 DESCRIPTION OF SUPPORT UNITS .....	13
3.6 CONFIGURATION OF SYSTEM UNDER TEST.....	14
4 TEST PROCEDURES AND RESULTS .....	15
4.1 CONDUCTED EMISSION MEASUREMENT .....	15
4.1.1 LIMITS OF CONDUCTED EMISSION MEASUREMENT.....	15
4.1.2 TEST INSTRUMENTS.....	15
4.1.3 TEST PROCEDURES .....	16
4.1.4 DEVIATION FROM TEST STANDARD .....	16
4.1.5 TEST SETUP .....	17
4.1.6 EUT OPERATING CONDITIONS.....	17
4.1.7 TEST RESULTS.....	18
4.2 RADIATED EMISSION AND BANDEDGE MEASUREMENT.....	20
4.2.1 LIMITS OF RADIATED EMISSION AND BANDEDGE MEASUREMENT.....	20
4.2.2 TEST INSTRUMENTS.....	21
4.2.3 TEST PROCEDURES .....	23
4.2.4 DEVIATION FROM TEST STANDARD .....	23
4.2.5 TEST SETUP .....	24
4.2.6 EUT OPERATING CONDITIONS.....	24
4.2.7 TEST RESULTS.....	25
4.3 NUMBER OF HOPPING FREQUENCY USED .....	32
4.3.1 LIMIT OF HOPPING FREQUENCY USED.....	32
4.3.2 TEST INSTRUMENTS.....	32
4.3.3 TEST PROCEDURES .....	32
4.3.4 DEVIATION FROM TEST STANDARD .....	32
4.3.5 TEST SETUP .....	33
4.3.6 TEST RESULTS.....	33
4.4 DWELL TIME ON EACH CHANNEL .....	34
4.4.1 LIMIT OF DWELL TIME USED .....	34
4.4.2 TEST INSTRUMENTS.....	34
4.4.3 TEST PROCEDURES .....	34
4.4.4 DEVIATION FROM TEST STANDARD .....	35
4.4.5 TEST SETUP .....	35
4.4.6 TEST RESULTS.....	36
4.5 CHANNEL BANDWIDTH .....	40



4.5.1	LIMITS OF CHANNEL BANDWIDTH .....	40
4.5.2	TEST INSTRUMENTS.....	40
4.5.3	TEST PROCEDURE.....	40
4.5.4	DEVIATION FROM TEST STANDARD .....	40
4.5.5	TEST SETUP .....	41
4.5.6	EUT OPERATING CONDITION .....	41
4.5.7	TEST RESULTS .....	42
4.6	HOPPING CHANNEL SEPARATION .....	43
4.6.1	LIMIT OF HOPPING CHANNEL SEPARATION.....	43
4.6.2	TEST INSTRUMENTS.....	43
4.6.3	TEST PROCEDURES .....	43
4.6.4	DEVIATION FROM TEST STANDARD .....	43
4.6.5	TEST SETUP .....	43
4.6.6	TEST RESULTS .....	44
4.7	MAXIMUM PEAK OUTPUT POWER .....	45
4.7.1	LIMITS OF MAXIMUM PEAK OUTPUT POWER MEASUREMENT .....	45
4.7.2	INSTRUMENTS .....	45
4.7.3	TEST PROCEDURES .....	45
4.7.4	DEVIATION FROM TEST STANDARD .....	45
4.7.5	TEST SETUP .....	46
4.7.6	EUT OPERATING CONDITION .....	46
4.7.7	TEST RESULTS .....	47
4.8	CONDUCTED OUT-BAND EMISSION MEASUREMENT.....	48
4.8.1	LIMITS OF CONDUCTED OUT-BAND EMISSION MEASUREMENT.....	48
4.8.2	TEST INSTRUMENTS.....	48
4.8.3	TEST PROCEDURE.....	48
4.8.4	DEVIATION FROM TEST STANDARD .....	48
4.8.5	TEST SETUP .....	48
4.8.6	EUT OPERATING CONDITION .....	48
4.8.7	TEST RESULTS .....	49
5	PHOTOGRAPHS OF THE TEST CONFIGURATION .....	52
6	INFORMATION ON THE TESTING LABORATORIES.....	53
7	APPENDIX A - MODIFICATIONS RECORDERS FOR ENGINEERING CHANGES TO THE EUT BY THE LAB.....	54



A D T

## RELEASE CONTROL RECORD

ISSUE NO.	REASON FOR CHANGE	DATE ISSUED
RF130711E04	Original release	July 23, 2013



## 1 CERTIFICATION

**PRODUCT :** Bluetooth Speaker  
**BRAND NAME :** Logitech  
**MODEL NO. :** S-00127  
**TEST SAMPLE :** ENGINEERING SAMPLE  
**APPLICANT :** LOGITECH FAR EAST LTD.  
**TESTED DATE :** July 12 to 18, 2013  
**STANDARDS :** **FCC Part 15, Subpart C (Section 15.247)**  
ANSI C63.10-2009

The above equipment (Model: S-00127) has been tested by **Bureau Veritas Consumer Products Services (H.K.) Ltd., Taoyuan Branch**, and found compliance with the requirement of the above standards. The test record, data evaluation & Equipment Under Test (EUT) configurations represented herein are true and accurate accounts of the measurements of the sample's EMC characteristics under the conditions specified in this report.

**PREPARED BY :**  , **DATE:** July 23, 2013  
( Elsie Hsu, Specialist )

**APPROVED BY :**  , **DATE:** July 23, 2013  
( May Chen, Manager )

## 2 SUMMARY OF TEST RESULTS

The EUT has been tested according to the following specifications:

APPLIED STANDARD: FCC Part 15, Subpart C			
STANDARD SECTION	TEST TYPE AND LIMIT	RESULT	REMARK
15.207	AC Power Conducted Emission	PASS	Meet the requirement of limit. Minimum passing margin is -18.59dB at 1.78125MHz.
15.247(a)(1) (iii)	Number of Hopping Frequency Used	PASS	Meet the requirement of limit.
15.247(a)(1) (iii)	Dwell Time on Each Channel	PASS	Meet the requirement of limit.
15.247(a)(1)	1. Hopping Channel Separation 2. Spectrum Bandwidth of a Frequency Hopping Sequence Spread Spectrum System	PASS	Meet the requirement of limit.
15.247(b)	Maximum Peak Output Power	PASS	Meet the requirement of limit.
15.247(d)	Transmitter Radiated Emissions	PASS	Meet the requirement of limit. Minimum passing margin is -4.6dB at 45.33MHz.
15.247(d)	Band Edge Measurement	PASS	Meet the requirement of limit.
15.203	Antenna Requirement	PASS	No antenna connector is used.

NOTE: Frequency Hopping System operating in 2400-2483.5MHz band and the output power less than 125mW. The hopping channel carrier frequencies separated by a minimum of 25kHz or two-thirds of the 20dB bandwidth of hopping channel whichever is greater.

## 2.1 MEASUREMENT UNCERTAINTY

Where relevant, the following measurement uncertainty levels have been estimated for tests performed on the EUT as specified in CISPR 16-4-2:

This uncertainty represents an expanded uncertainty expressed at approximately the 95% confidence level using a coverage factor of  $k=2$ .

<b>Measurement</b>	<b>Value</b>
Conducted emissions	2.98 dB
Radiated emissions (30MHz-1GHz)	5.63 dB
Radiated emissions (1GHz -6GHz)	3.54 dB
Radiated emissions (6GHz -18GHz)	4.08 dB
Radiated emissions (18GHz -40GHz)	4.11 dB

### 3 GENERAL INFORMATION

#### 3.1 GENERAL DESCRIPTION OF EUT

<b>PRODUCT</b>	Bluetooth Speaker
<b>MODEL NO.</b>	S-00127
<b>POWER SUPPLY</b>	DC 3.7V from battery DC 5V from USB interface
<b>MODULATION TYPE</b>	GFSK, $\pi/4$ -DQPSK, 8DPSK
<b>MODULATION TECHNOLOGY</b>	FHSS
<b>DATE RATE</b>	Up to 3Mbps
<b>FREQUENCY RANGE</b>	2402MHz ~ 2480MHz
<b>NUMBER OF CHANNEL</b>	79
<b>MAX. OUTPUT POWER</b>	7.063 mW
<b>ANTENNA TYPE</b>	PCB printed antenna with 0.67dBi antenna gain
<b>DATA CABLE</b>	USB cable (Shielded, 0.7m)
<b>I/O PORTS</b>	Refer to user's manual
<b>ASSOCIATED DEVICES</b>	Adapter x 1

#### NOTE:

1. The EUT must be supplied with a Li-polymer battery or a power adapter, please refer to the following table:

Battery		
Brand	Model	Spec.
Logitech	533-000084-001	3.7 V~ 4.2V 1100mAh
Adapter		
Brand	Model	Spec.
Logitech	KSAS0060510100D5U	AC I/P : 100-240V, 50/60Hz, 0.18A DC O/P : 5.1V, 1.0A

2. There is one NFC tag be installed to this EUT, please refer to the following table:

Brand	Model	Function
NXP	NTAG203F	NFC -Tag



3. The EUT was pre-tested under the following modes:

Pre-test Mode	Description
<b>Mode A</b>	<b>Battery Mode</b>
Mode B	Adapter Mode

The worst spurious emission was found in **Mode A**. Therefore only the test data of the modes were recorded in this report.

4. The EUT has Bluetooth function under charging mode.

5. The above EUT information was declared by the manufacturer and for more detailed features description, please refer to the manufacturer's specifications or User's Manual.

### 3.2 DESCRIPTION OF TEST MODES

79 channels are provided for Bluetooth.

Channel	Freq. (MHz)	Channel	Freq. (MHz)	Channel	Freq. (MHz)	Channel	Freq. (MHz)
0	2402	20	2422	40	2442	60	2462
1	2403	21	2423	41	2443	61	2463
2	2404	22	2424	42	2444	62	2464
3	2405	23	2425	43	2445	63	2465
4	2406	24	2426	44	2446	64	2466
5	2407	25	2427	45	2447	65	2467
6	2408	26	2428	46	2448	66	2468
7	2409	27	2429	47	2449	67	2469
8	2410	28	2430	48	2450	68	2470
9	2411	29	2431	49	2451	69	2471
10	2412	30	2432	50	2452	70	2472
11	2413	31	2433	51	2453	71	2473
12	2414	32	2434	52	2454	72	2474
13	2415	33	2435	53	2455	73	2475
14	2416	34	2436	54	2456	74	2476
15	2417	35	2437	55	2457	75	2477
16	2418	36	2438	56	2458	76	2478
17	2419	37	2439	57	2459	77	2479
18	2420	38	2440	58	2460	78	2480
19	2421	39	2441	59	2461		



### 3.3 TEST MODE APPLICABILITY AND TESTED CHANNEL DETAIL:

EUT CONFIGURE MODE	APPLICABLE TO					DESCRIPTION
	PLC	RE < 1G	RE ≥ 1G	APCM	OB	
-	-	√	√	√	√	Battery Mode
-	√	-	-	-	-	Adapter Mode

Where **PLC**: Power Line Conducted Emission      **RE < 1G**: Radiated Emission below 1GHz  
**RE ≥ 1G**: Radiated Emission above 1GHz      **APCM**: Antenna Port Conducted Measurement  
**OB**: Conducted Out-Band Emission Measurement

#### **POWER LINE CONDUCTED EMISSION:**

- Pre-Scan has been conducted to determine the worst-case mode from all possible combinations between available modulations, data rates and antenna ports (if EUT with antenna diversity architecture).
- Following channel(s) was (were) selected for the final test as listed below.

Available Channel	Tested Channel	Modulation Technology	Modulation Type	Packet Type
0 to 78	0	FHSS	8DPSK	DH5

#### **RADIATED EMISSION TEST (BELOW 1 GHz):**

- Pre-Scan has been conducted to determine the worst-case mode from all possible combinations between available modulations, data rates and antenna ports (if EUT with antenna diversity architecture).
- Following channel(s) was (were) selected for the final test as listed below.

Available Channel	Tested Channel	Modulation Technology	Modulation Type	Packet Type
0 to 78	0	FHSS	8DPSK	DH5

#### **RADIATED EMISSION TEST (ABOVE 1 GHz):**

- Pre-Scan has been conducted to determine the worst-case mode from all possible combinations between available modulations, data rates and antenna ports (if EUT with antenna diversity architecture).
- Following channel(s) was (were) selected for the final test as listed below.

Available Channel	Tested Channel	Modulation Technology	Modulation Type	Packet Type
0 to 78	0, 39, 78	FHSS	GFSK	DH5
0 to 78	0, 39, 78	FHSS	8DPSK	DH5



A D T

#### **ANTENNA PORT CONDUCTED MEASUREMENT:**

- Pre-Scan has been conducted to determine the worst-case mode from all possible combinations between available modulations, data rates and antenna ports (if EUT with antenna diversity architecture).
- Following channel(s) was (were) selected for the final test as listed below.

Available Channel	Tested Channel	Modulation Technology	Modulation Type	Packet Type
0 to 78	0, 39, 78	FHSS	GFSK	DH5
0 to 78	0, 39, 78	FHSS	8DPSK	DH5

#### **CONDUCTED OUT-BAND EMISSION MEASUREMENT:**

- Pre-Scan has been conducted to determine the worst-case mode from all possible combinations between available modulations, data rates and antenna ports (if EUT with antenna diversity architecture).
- Following channel(s) was (were) selected for the final test as listed below.

Available Channel	Tested Channel	Modulation Technology	Modulation Type	Packet Type
0 to 78	0, 78	FHSS	GFSK	DH5
0 to 78	0, 78	FHSS	8DPSK	DH5

#### **TEST CONDITION:**

APPLICABLE TO	ENVIRONMENTAL CONDITIONS	INPUT POWER	TESTED BY
PLC	28deg. C, 69%RH	120Vac, 60Hz (SYSTEM)	Bear Lee
RE<1G	26deg. C, 68%RH	DC 3.7V	Chilin Lee
RE <sup>3</sup> 1G	30deg. C, 70%RH	DC 3.7V	Nelson Teng
APCM	25deg. C, 60%RH	DC 3.7V	Robert Cheng
OB	25deg. C, 60%RH	DC 3.7V	Robert Cheng



### 3.4 GENERAL DESCRIPTION OF APPLIED STANDARDS

The EUT is a RF product. According to the specifications of the manufacturer, it must comply with the requirements of the following standards:

**FCC Part 15, Subpart C. (15.247)**

ANSI C63.10-2009

All test items have been performed and recorded as per the above standards.

**Note:** The EUT has been verified to comply with the requirements of FCC Part 15, Subpart B, Class B (DoC). The test report has been issued separately.



A D T

### 3.5 DESCRIPTION OF SUPPORT UNITS

The EUT has been tested as an independent unit together with other necessary accessories or support units. The following support units or accessories were used to form a representative test configuration during the tests.

NO.	PRODUCT	BRAND	MODEL NO.	SERIAL NO.	FCC ID
1	Headset	Hawk	HKC920	H003	FCC DoC

NO.	SIGNAL CABLE DESCRIPTION OF THE ABOVE SUPPORT UNITS
1	Audio cable (2m)

**NOTE:** All power cords of the above support units are non shielded (1.8m).

### 3.6 CONFIGURATION OF SYSTEM UNDER TEST

#### For conducted emission test

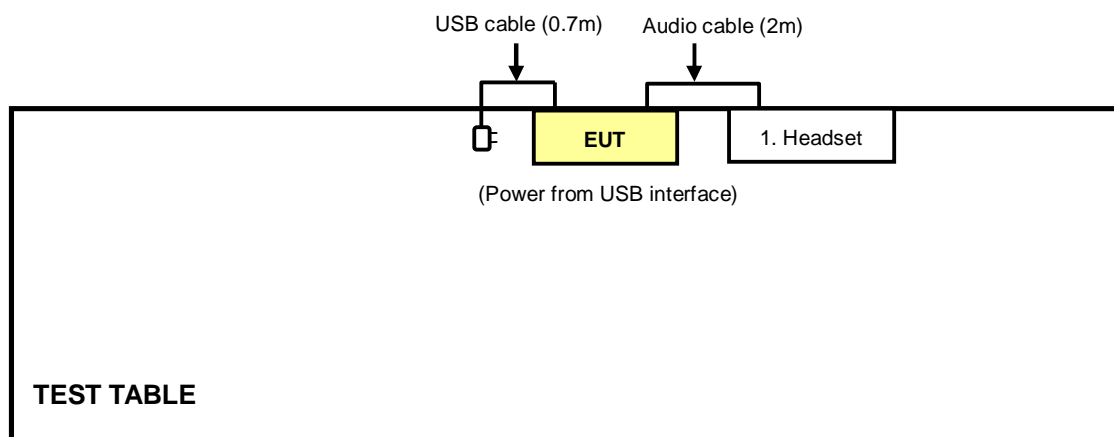

#### For other test items

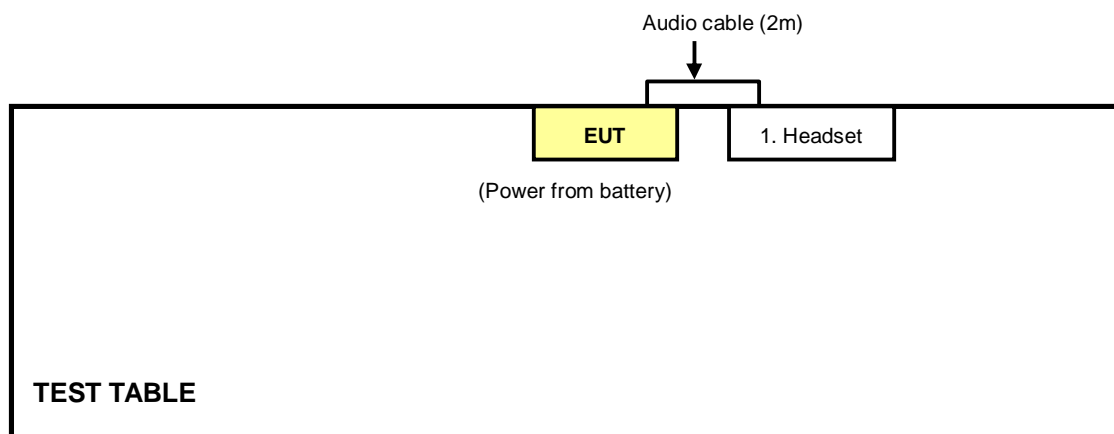

## 4 TEST PROCEDURES AND RESULTS

### 4.1 CONDUCTED EMISSION MEASUREMENT

#### 4.1.1 LIMITS OF CONDUCTED EMISSION MEASUREMENT

FREQUENCY OF EMISSION (MHz)	CONDUCTED LIMIT (dB $\mu$ V)	
	Quasi-peak	Average
0.15-0.5	66 to 56	56 to 46
0.5-5	56	46
5-30	60	50

- NOTE:**
1. The lower limit shall apply at the transition frequencies.
  2. The limit decreases in line with the logarithm of the frequency in the range of 0.15 to 0.50 MHz.

#### 4.1.2 TEST INSTRUMENTS

DESCRIPTION & MANUFACTURER	MODEL NO.	SERIAL NO.	CALIBRATED DATE	CALIBRATED UNTIL
Test Receiver	ESCS 30	100375	Mar. 08, 2013	Mar. 07, 2014
Line-Impedance Stabilization Network (for EUT) SCHWARZBECK	NSLK8127	8127-522	Sep. 06, 2012	Sep. 05, 2013
Line-Impedance Stabilization Network (for Peripheral)	ENV216	100072	June 07, 2013	June 06, 2014
RF Cable (JYEBAO)	5DFB	COCCAB-001	Mar. 11, 2013	Mar. 10, 2014
50 ohms Terminator	50	EMC-3	Sep. 25, 2012	Sep. 24, 2013
Software ADT	BV ADT_Cond_V7.3.7.3	NA	NA	NA

**Note:**

1. The calibration interval of the above test instruments is 12 months and the calibrations are traceable to NML/ROC and NIST/USA.
2. The test was performed in Shielded Room No. C.
3. The VCCI Con C Registration No. is C-3611.
4. Tested Date: July 16, 2013

#### 4.1.3 TEST PROCEDURES

- a. The EUT was placed 0.4 meters from the conducting wall of the shielded room with EUT being connected to the power mains through a line impedance stabilization network (LISN). Other support units were connected to the power mains through another LISN.
- b. The two LISNs provide 50 ohm/ 50uH of coupling impedance for the measuring instrument.
- c. Both lines of the power mains connected to the EUT were checked for maximum conducted interference.
- d. The frequency range from 150kHz to 30MHz was searched. Emission levels under (Limit – 20dB) were not recorded.

**NOTE:** The resolution bandwidth of test receiver is 9kHz for Quasi-peak detection (QP) & Average detection (AV).

#### 4.1.4 DEVIATION FROM TEST STANDARD

No deviation



#### 4.1.5 TEST SETUP

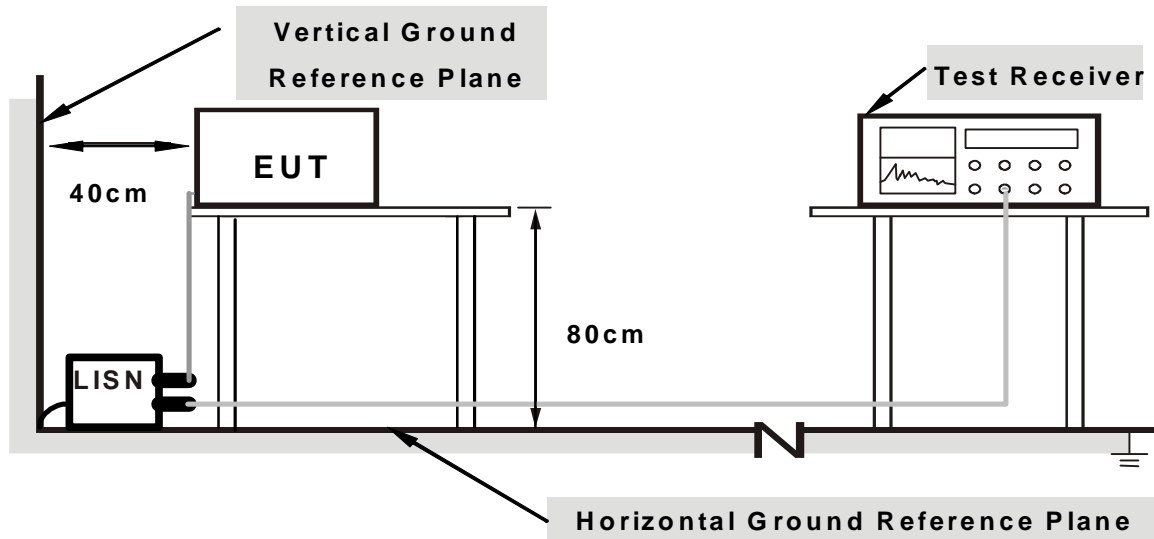

**Note: 1. Support units were connected to second LISN.**

For the actual test configuration, please refer to the related item – Photographs of the Test Configuration.

#### 4.1.6 EUT OPERATING CONDITIONS

1. Set the EUT under transmission / receiver condition continuously at specific channel frequency.
2. EUT plays music continuously from support unit 1 (Headset) via an audio cable.

#### 4.1.7 TEST RESULTS

PHASE	Line (L)	DETECTOR FUNCTION	Quasi-Peak (QP) / Average (AV)
-------	----------	-------------------	--------------------------------

No	Freq.	Corr. Factor	Reading Value		Emission Level		Limit		Margin	
	[MHz]		[dB (uV)]		[dB (uV)]		[dB (uV)]		(dB)	
			Q.P.	AV.	Q.P.	AV.	Q.P.	AV.	Q.P.	AV.
1	0.34922	0.19	38.38	29.96	38.57	30.15	58.98	48.98	-20.41	-18.83
2	0.72813	0.23	34.13	26.46	34.36	26.69	56.00	46.00	-21.64	-19.31
3	0.88438	0.24	34.21	26.28	34.45	26.52	56.00	46.00	-21.55	-19.48
<b>4</b>	<b>1.78125</b>	<b>0.32</b>	<b>35.30</b>	<b>27.09</b>	<b>35.62</b>	<b>27.41</b>	<b>56.00</b>	<b>46.00</b>	<b>-20.38</b>	<b>-18.59</b>
5	2.96094	0.40	30.19	21.53	30.59	21.93	56.00	46.00	-25.41	-24.07
6	24.72656	1.62	25.17	24.27	26.79	25.89	60.00	50.00	-33.21	-24.11

#### REMARKS:

1. Q.P. and AV. are abbreviations of quasi-peak and average individually.
2. The emission levels of other frequencies were very low against the limit.
3. Margin value = Emission Level – Limit value
4. Correction Factor = Insertion loss + Cable loss
5. Emission Level = Correction Factor + Reading Value

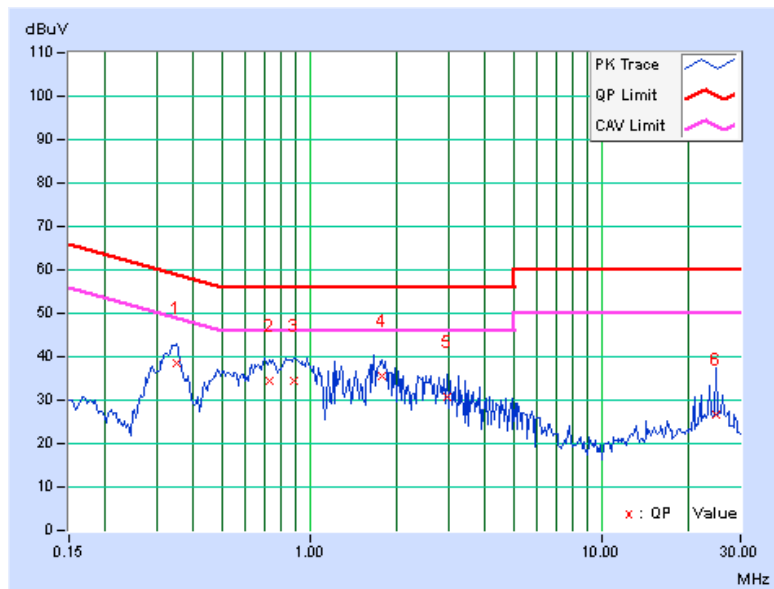



A D T

<b>PHASE</b>	Neutral (N)	<b>DETECTOR FUNCTION</b>	Quasi-Peak (QP) / Average (AV)
--------------	-------------	--------------------------	--------------------------------

No	Freq. [MHz]	Corr. Factor (dB)	Reading Value [dB (uV)]		Emission Level [dB (uV)]		Limit [dB (uV)]		Margin (dB)	
			Q.P.	AV.	Q.P.	AV.	Q.P.	AV.	Q.P.	AV.
			1	0.32578	0.17	33.54	24.93	33.71	25.10	59.56
2	0.66953	0.20	24.74	18.61	24.94	18.81	56.00	46.00	-31.06	-27.19
3	0.98984	0.22	25.66	17.91	25.88	18.13	56.00	46.00	-30.12	-27.87
4	1.71094	0.28	28.21	21.45	28.49	21.73	56.00	46.00	-27.51	-24.27
5	2.97656	0.36	23.38	17.04	23.74	17.40	56.00	46.00	-32.26	-28.60
6	22.12500	1.19	15.80	7.90	16.99	9.09	60.00	50.00	-43.01	-40.91

**REMARKS:**

1. Q.P. and AV. are abbreviations of quasi-peak and average individually.
2. The emission levels of other frequencies were very low against the limit.
3. Margin value = Emission Level – Limit value
4. Correction Factor = Insertion loss + Cable loss
5. Emission Level = Correction Factor + Reading Value

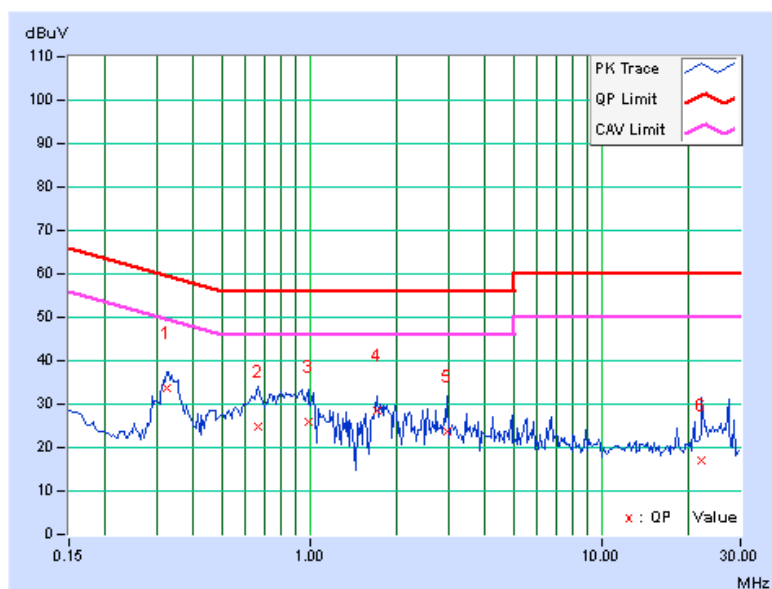

## 4.2 RADIATED EMISSION AND BANDEDGE MEASUREMENT

### 4.2.1 LIMITS OF RADIATED EMISSION AND BANDEDGE MEASUREMENT

Radiated emissions which fall in the restricted bands must comply with the radiated emission limits specified as below table. Other emissions shall be at least 20dB below the highest level of the desired power:

FREQUENCIES (MHz)	FIELD STRENGTH (microvolts/meter)	MEASUREMENT DISTANCE (meters)
0.009 ~ 0.490	2400/F(kHz)	300
0.490 ~ 1.705	24000/F(kHz)	30
1.705 ~ 30.0	30	30
30 ~ 88	100	3
88 ~ 216	150	3
216 ~ 960	200	3
Above 960	500	3

**NOTE:**

1. The lower limit shall apply at the transition frequencies.
2. Emission level (dBuV/m) = 20 log Emission level (uV/m).
3. For frequencies above 1000MHz, the field strength limits are based on average detector, however, the peak field strength of any emission shall not exceed the maximum permitted average limits, specified above by more than 20dB.



A D T

## 4.2.2 TEST INSTRUMENTS

### For below 1GHz

DESCRIPTION & MANUFACTURER	MODEL NO.	SERIAL NO.	CALIBRATED DATE	CALIBRATED UNTIL
Spectrum Analyzer Agilent	E4446A	MY48250253	Sep. 03, 2012	Sep. 02, 2013
MXE EMI Receiver Agilent	N9038A	MY51210105	Jan. 29,2013	Jan. 28,2014
Pre-Amplifier Mini-Circuits	ZFL-1000VH2 B	AMP-ZFL-03	Nov. 14, 2012	Nov. 13, 2013
Pre-Amplifier Agilent	8449B	3008A02578	June 25, 2013	June 24, 2014
Pre-Amplifier SPACEK LABS	SLKKa-48-6	9K16	Nov. 14, 2012	Nov. 13, 2013
Trilog Broadband Antenna SCHWARZBECK	VULB 9168	9168-360	Mar. 19, 2013	Mar. 18, 2014
Horn_Antenna AISi	AIH.8018	0000320091110	Nov. 19, 2012	Nov. 18, 2013
Horn_Antenna SCHWARZBECK	BBHA 9170	9170-424	Oct. 12, 2012	Oct. 11, 2013
RF Cable	NA	RF104-201 RF104-203 RF104-204	Dec. 25, 2012	Dec. 24, 2013
RF Cable	NA	CHGCAB_001	Oct. 06, 2012	Oct. 05, 2013
Software	ADT_Radiated _V8.7.07	NA	NA	NA
Antenna Tower & Turn Table CT	NA	NA	NA	NA

### Note:

1. The calibration interval of the above test instruments is 12 months and the calibrations are traceable to NML/ROC and NIST/USA.
2. The horn antenna, preamplifier (model: 8449B) are used only for the measurement of emission frequency above 1GHz if tested.
- 3 The test was performed in 966 Chamber No. G.
4. The FCC Site Registration No. is 966073.
- 5 The VCCI Site Registration No. is G-137.
- 6 The CANADA Site Registration No. is IC 7450H-2.
- 7 Tested Date: July 12, 2013



A D T

**For above 1GHz**

DESCRIPTION & MANUFACTURER	MODEL NO.	SERIAL NO.	CALIBRATED DATE	CALIBRATED UNTIL
Spectrum Analyzer Agilent	E4446A	MY48250253	Sep. 03, 2012	Sep. 02, 2013
MXE EMI Receiver Agilent	N9038A	MY50010156	Jan. 16, 2013	Jan. 15, 2014
Pre-Amplifier Mini-Circuits	ZFL-1000VH2 B	AMP-ZFL-04	Nov. 14, 2012	Nov. 13, 2013
Pre-Amplifier Agilent	8449B	3008A01923	Oct. 30, 2012	Oct. 29, 2013
Pre-Amplifier SPACEK LABS	SLKKa-48-6	9K16	Nov. 14, 2012	Nov. 13, 2013
Trilog Broadband Antenna SCHWARZBECK	VULB 9168	9168-361	Mar. 25, 2013	Mar. 24, 2014
Horn_Antenna AISL	AIH.8018	0000220091110	Nov. 27, 2012	Nov. 26, 2013
Horn_Antenna SCHWARZBECK	BBHA 9170	9170-424	Oct. 12, 2012	Oct. 11, 2013
RF Cable	NA	RF104-205 RF104-207 RF104-202	Dec. 26, 2012	Dec. 25, 2013
RF Cable	NA	CHHCAB_001	Oct. 07, 2012	Oct. 06, 2013
Software	ADT_Radiated _V8.7.05	NA	NA	NA
Antenna Tower & Turn Table CT	NA	NA	NA	NA

**Note:**

1. The calibration interval of the above test instruments is 12 months and the calibrations are traceable to NML/ROC and NIST/USA.
2. The horn antenna, preamplifier (model: 8449B) are used only for the measurement of emission frequency above 1GHz if tested.
3. The test was performed in 966 Chamber No. H.
4. The FCC Site Registration No. is 797305.
5. The CANADA Site Registration No. is IC 7450H-3.
6. Tested Date: July 18, 2013

### 4.2.3 TEST PROCEDURES

- a. The EUT was placed on the top of a rotating table 0.8 meters above the ground at a 3 meters chamber room. The table was rotated 360 degrees to determine the position of the highest radiation.
- b. The EUT was set 3 meters away from the interference-receiving antenna, which was mounted on the top of a variable-height antenna tower.
- c. The height of antenna is varied from one meter to four meters above the ground to determine the maximum value of the field strength. Both horizontal and vertical polarizations of the antenna are set to make the measurement.
- d. For each suspected emission, the EUT was arranged to its worst case and then the antenna was tuned to heights from 1 meter to 4 meters and the rotatable table was turned from 0 degrees to 360 degrees to find the maximum reading.
- e. The test-receiver system was set to quasi-peak detect function and specified bandwidth with maximum hold mode when the test frequency is below 1 GHz.
- f. The test-receiver system was set to peak detect function and specified bandwidth with maximum hold mode when the test frequency is above 1 GHz.

**NOTE:**

1. The resolution bandwidth and video bandwidth of test receiver/spectrum analyzer is 120kHz for Quasi-peak detection (QP) at frequency below 1GHz.
2. The resolution bandwidth of test receiver/spectrum analyzer is 1MHz and video bandwidth is 1MHz for Peak detection at frequency above 1GHz.
3. All modes of operation were investigated and the worst-case emissions are reported.

### 4.2.4 DEVIATION FROM TEST STANDARD

No deviation

#### 4.2.5 TEST SETUP

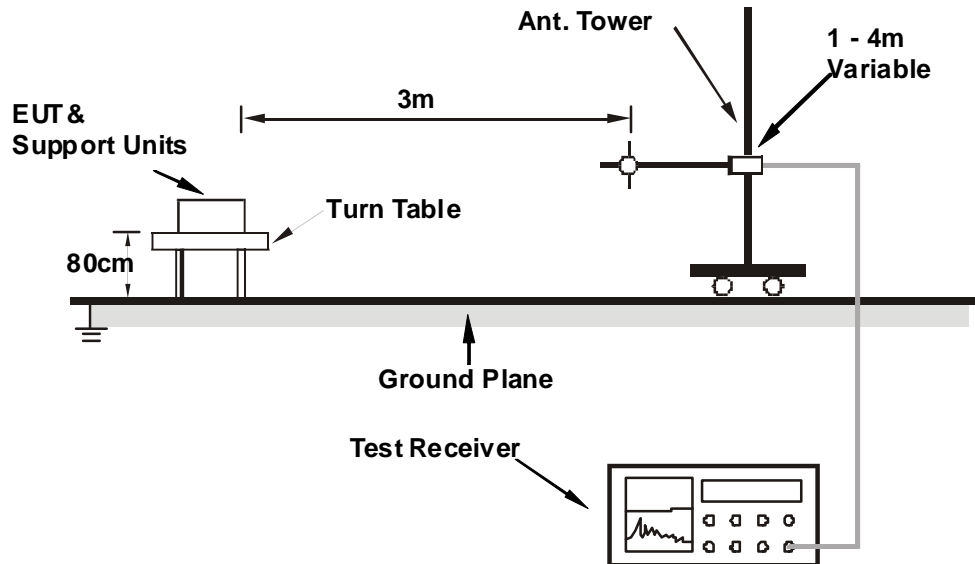

For the actual test configuration, please refer to the related item – Photographs of the Test Configuration.

#### 4.2.6 EUT OPERATING CONDITIONS

1. Turn on the power of all equipment.
2. Run test program “CSR BlueSuite 2.5.0\_BlueTest3” to enable EUT under transmission/receiving condition continuously at specific channel frequency.



## 4.2.7 TEST RESULTS

### BELOW 1GHz WORST-CASE DATA

#### BT\_GFSK

<b>CHANNEL</b>	TX Channel 0	<b>DETECTOR FUNCTION</b>	Quasi-Peak (QP)
<b>FREQUENCY RANGE</b>	Below 1GHz		

#### ANTENNA POLARITY & TEST DISTANCE: HORIZONTAL AT 3 M

NO.	FREQ. (MHz)	EMISSION LEVEL (dBuV/m)	LIMIT (dBuV/m)	MARGIN (dB)	ANTENNA HEIGHT (m)	TABLE ANGLE (Degree)	RAW VALUE (dBuV)	CORRECTION FACTOR (dB/m)
1	45.57	32.9 QP	40.0	-7.1	2.00 H	36	46.06	-13.15
2	81.70	31.8 QP	40.0	-8.2	2.00 H	41	50.36	-18.56
3	196.99	37.1 QP	43.5	-6.4	1.50 H	37	53.46	-16.39
4	299.27	35.3 QP	46.0	-10.7	1.00 H	54	48.05	-12.75
5	521.64	33.8 QP	46.0	-12.2	1.50 H	360	41.23	-7.44
6	696.39	34.3 QP	46.0	-11.7	1.50 H	235	38.31	-3.99

#### ANTENNA POLARITY & TEST DISTANCE: VERTICAL AT 3 M

NO.	FREQ. (MHz)	EMISSION LEVEL (dBuV/m)	LIMIT (dBuV/m)	MARGIN (dB)	ANTENNA HEIGHT (m)	TABLE ANGLE (Degree)	RAW VALUE (dBuV)	CORRECTION FACTOR (dB/m)
1	45.33	35.5 QP	40.0	-4.6	1.00 V	101	48.61	-13.16
2	166.28	37.3 QP	43.5	-6.2	1.00 V	252	51.32	-14.02
3	194.12	29.6 QP	43.5	-13.9	1.50 V	121	45.94	-16.38
4	365.81	26.6 QP	46.0	-19.4	1.00 V	360	37.66	-11.04
5	697.36	30.5 QP	46.0	-15.5	1.50 V	128	34.47	-3.99
6	897.52	32.8 QP	46.0	-13.2	1.50 V	219	33.23	-0.39

#### REMARKS:

1. Emission Level(dBuV/m) = Raw Value(dBuV) + Correction Factor(dB/m)
2. Correction Factor(dB/m) = Antenna Factor(dB/m) + Cable Factor(dB) – Pre-Amplifier Factor(dB)
3. The other emission levels were very low against the limit.
4. Margin value = Emission Level – Limit value

## ABOVE 1GHz DATA

### BT\_GFSK

<b>CHANNEL</b>	TX Channel 0	<b>DETECTOR FUNCTION</b>	Peak (PK)
<b>FREQUENCY RANGE</b>	1GHz ~ 25GHz		

ANTENNA POLARITY & TEST DISTANCE: HORIZONTAL AT 3 M								
NO.	FREQ. (MHz)	EMISSION LEVEL (dBuV/m)	LIMIT (dBuV/m)	MARGIN (dB)	ANTENNA HEIGHT (m)	TABLE ANGLE (Degree)	RAW VALUE (dBuV)	CORRECTION FACTOR (dB/m)
1	2390.00	58.6 PK	74.0	-15.4	1.36 H	123	25.82	32.78
2	2390.00	28.5 AV	54.0	-25.5	1.36 H	123	-4.28	32.78
3	*2402.00	104.3 PK			1.36 H	123	71.49	32.81
4	*2402.00	74.2 AV			1.36 H	123	41.39	32.81
5	4804.00	55.6 PK	74.0	-18.4	1.45 H	215	13.35	42.25
6	4804.00	25.5 AV	54.0	-28.5	1.45 H	215	-16.75	42.25

ANTENNA POLARITY & TEST DISTANCE: VERTICAL AT 3 M								
NO.	FREQ. (MHz)	EMISSION LEVEL (dBuV/m)	LIMIT (dBuV/m)	MARGIN (dB)	ANTENNA HEIGHT (m)	TABLE ANGLE (Degree)	RAW VALUE (dBuV)	CORRECTION FACTOR (dB/m)
1	2390.00	58.2 PK	74.0	-15.8	1.00 V	295	25.42	32.78
2	2390.00	28.1 AV	54.0	-25.9	1.00 V	295	-4.68	32.78
3	*2402.00	100.0 PK			1.00 V	295	67.19	32.81
4	*2402.00	69.9 AV			1.00 V	295	37.09	32.81
5	4804.00	55.4 PK	74.0	-18.6	1.53 V	172	13.15	42.25
6	4804.00	25.3 AV	54.0	-28.7	1.53 V	172	-16.95	42.25

#### REMARKS:

- Emission Level(dBuV/m) = Raw Value(dBuV) + Correction Factor(dB/m)
- Correction Factor(dB/m) = Antenna Factor(dB/m) + Cable Factor(dB) – Pre-Amplifier Factor(dB)
- The other emission levels were very low against the limit.
- Margin value = Emission Level – Limit value
- " \* ": Fundamental frequency.
- The DH5 packet was the worse case duty cycle for a transmit dwell time on a channel, based upon bluetooth theory the transmitter is on 0.625 \* 5 per 296.25 ms per channel. Therefore, the duty cycle correlation factor be equal to:  $20\log(3.125 / 100) = -30.1$  dB.
- Average value = peak reading +  $20\log(\text{duty cycle})$ .



A D T

<b>CHANNEL</b>	TX Channel 39	<b>DETECTOR FUNCTION</b>	Peak (PK)
<b>FREQUENCY RANGE</b>	1GHz ~ 25GHz		

ANTENNA POLARITY & TEST DISTANCE: HORIZONTAL AT 3 M								
NO.	FREQ. (MHz)	EMISSION LEVEL (dBuV/m)	LIMIT (dBuV/m)	MARGIN (dB)	ANTENNA HEIGHT (m)	TABLE ANGLE (Degree)	RAW VALUE (dBuV)	CORRECTION FACTOR (dB/m)
1	*2441.00	104.3 PK			1.29 H	128	71.39	32.91
2	*2441.00	74.2 AV			1.29 H	128	41.29	32.91
3	4882.00	56.4 PK	74.0	-17.6	1.41 H	218	14.08	42.32
4	4882.00	26.3 AV	54.0	-27.7	1.41 H	218	-16.02	42.32
5	7323.00	56.4 PK	74.0	-17.6	1.64 H	320	9.41	46.99
6	7323.00	26.3 AV	54.0	-27.7	1.64 H	320	-20.69	46.99

ANTENNA POLARITY & TEST DISTANCE: VERTICAL AT 3 M								
NO.	FREQ. (MHz)	EMISSION LEVEL (dBuV/m)	LIMIT (dBuV/m)	MARGIN (dB)	ANTENNA HEIGHT (m)	TABLE ANGLE (Degree)	RAW VALUE (dBuV)	CORRECTION FACTOR (dB/m)
1	*2441.00	99.5 PK			1.00 V	269	66.59	32.91
2	*2441.00	69.4 AV			1.00 V	269	36.49	32.91
3	4882.00	56.3 PK	74.0	-17.7	1.53 V	171	13.98	42.32
4	4882.00	26.2 AV	54.0	-27.8	1.53 V	171	-16.12	42.32
5	7323.00	56.0 PK	74.0	-18.0	1.49 V	96	9.01	46.99
6	7323.00	25.9 AV	54.0	-28.1	1.49 V	96	-21.09	46.99

**REMARKS:**

1. Emission Level(dBuV/m) = Raw Value(dBuV) + Correction Factor(dB/m)
2. Correction Factor(dB/m) = Antenna Factor(dB/m) + Cable Factor(dB) – Pre-Amplifier Factor(dB)
3. The other emission levels were very low against the limit.
4. Margin value = Emission Level – Limit value
5. " \* ": Fundamental frequency.
6. The DH5 packet was the worse case duty cycle for a transmit dwell time on a channel, based upon bluetooth theory the transmitter is on 0.625 \* 5 per 296.25 ms per channel. Therefore, the duty cycle correlation factor be equal to:  $20\log(3.125 / 100) = -30.1$  dB.
7. Average value = peak reading +  $20\log(\text{duty cycle})$ .



A D T

<b>CHANNEL</b>	TX Channel 78	<b>DETECTOR FUNCTION</b>	Peak (PK)
<b>FREQUENCY RANGE</b>	1GHz ~ 25GHz		

**ANTENNA POLARITY & TEST DISTANCE: HORIZONTAL AT 3 M**

NO.	FREQ. (MHz)	EMISSION LEVEL (dBuV/m)	LIMIT (dBuV/m)	MARGIN (dB)	ANTENNA HEIGHT (m)	TABLE ANGLE (Degree)	RAW VALUE (dBuV)	CORRECTION FACTOR (dB/m)
1	*2480.00	104.2 PK			1.30 H	125	71.18	33.02
2	*2480.00	74.1 AV			1.30 H	125	41.08	33.02
3	2483.50	58.2 PK	74.0	-15.8	1.30 H	125	25.17	33.03
4	2483.50	28.1 AV	54.0	-25.9	1.30 H	125	-4.93	33.03
5	4960.00	56.4 PK	74.0	-17.6	1.41 H	221	14.10	42.30
6	4960.00	26.3 AV	54.0	-27.7	1.41 H	221	-16.00	42.30
7	7440.00	56.2 PK	74.0	-17.8	1.60 H	310	8.91	47.29
8	7440.00	26.1 AV	54.0	-27.9	1.60 H	310	-21.19	47.29

**ANTENNA POLARITY & TEST DISTANCE: VERTICAL AT 3 M**

NO.	FREQ. (MHz)	EMISSION LEVEL (dBuV/m)	LIMIT (dBuV/m)	MARGIN (dB)	ANTENNA HEIGHT (m)	TABLE ANGLE (Degree)	RAW VALUE (dBuV)	CORRECTION FACTOR (dB/m)
1	*2480.00	100.1 PK			1.00 V	89	67.08	33.02
2	*2480.00	70.0 AV			1.00 V	89	36.98	33.02
3	2483.50	58.2 PK	74.0	-15.8	1.00 V	89	25.17	33.03
4	2483.50	28.1 AV	54.0	-25.9	1.00 V	89	-4.93	33.03
5	4960.00	56.4 PK	74.0	-17.6	1.55 V	161	14.10	42.30
6	4960.00	26.3 AV	54.0	-27.7	1.55 V	161	-16.00	42.30
7	7440.00	55.9 PK	74.0	-18.1	1.44 V	95	8.61	47.29
8	7440.00	25.8 AV	54.0	-28.2	1.44 V	95	-21.49	47.29

**REMARKS:**

- Emission Level(dBuV/m) = Raw Value(dBuV) + Correction Factor(dB/m)
- Correction Factor(dB/m) = Antenna Factor(dB/m) + Cable Factor(dB) – Pre-Amplifier Factor(dB)
- The other emission levels were very low against the limit.
- Margin value = Emission Level – Limit value
- " \* ": Fundamental frequency.
- The DH5 packet was the worse case duty cycle for a transmit dwell time on a channel, based upon bluetooth theory the transmitter is on 0.625 \* 5 per 296.25 ms per channel. Therefore, the duty cycle correlation factor be equal to:  $20\log(3.125 / 100) = -30.1$  dB.
- Average value = peak reading +  $20\log(\text{duty cycle})$ .



A D T

BT\_8DPSK

CHANNEL	TX Channel 0	DETECTOR FUNCTION	Peak (PK)
FREQUENCY RANGE	1GHz ~ 25GHz		

ANTENNA POLARITY & TEST DISTANCE: HORIZONTAL AT 3 M

NO.	FREQ. (MHz)	EMISSION LEVEL (dBuV/m)	LIMIT (dBuV/m)	MARGIN (dB)	ANTENNA HEIGHT (m)	TABLE ANGLE (Degree)	RAW VALUE (dBuV)	CORRECTION FACTOR (dB/m)
1	2390.00	57.2 PK	74.0	-16.8	1.35 H	126	24.42	32.78
2	2390.00	27.1 AV	54.0	-26.9	1.35 H	126	-5.68	32.78
3	*2402.00	103.9 PK			1.35 H	126	71.09	32.81
4	*2402.00	73.8 AV			1.35 H	126	40.99	32.81
5	4804.00	55.2 PK	74.0	-18.8	1.50 H	213	12.95	42.25
6	4804.00	25.1 AV	54.0	-28.9	1.50 H	213	-17.15	42.25

ANTENNA POLARITY & TEST DISTANCE: VERTICAL AT 3 M

NO.	FREQ. (MHz)	EMISSION LEVEL (dBuV/m)	LIMIT (dBuV/m)	MARGIN (dB)	ANTENNA HEIGHT (m)	TABLE ANGLE (Degree)	RAW VALUE (dBuV)	CORRECTION FACTOR (dB/m)
1	2390.00	57.5 PK	74.0	-16.5	1.00 V	297	24.72	32.78
2	2390.00	27.4 AV	54.0	-26.6	1.00 V	297	-5.38	32.78
3	*2402.00	99.7 PK			1.00 V	297	66.89	32.81
4	*2402.00	69.6 AV			1.00 V	297	36.79	32.81
5	4804.00	54.9 PK	74.0	-19.1	1.51 V	184	12.65	42.25
6	4804.00	24.8 AV	54.0	-29.2	1.51 V	184	-17.45	42.25

REMARKS:

1. Emission Level(dBuV/m) = Raw Value(dBuV) + Correction Factor(dB/m)
2. Correction Factor(dB/m) = Antenna Factor(dB/m) + Cable Factor(dB) – Pre-Amplifier Factor(dB)
3. The other emission levels were very low against the limit.
4. Margin value = Emission Level – Limit value
5. " \* ": Fundamental frequency.
6. The DH5 packet was the worse case duty cycle for a transmit dwell time on a channel, based upon bluetooth theory the transmitter is on 0.625 \* 5 per 296.25 ms per channel. Therefore, the duty cycle correlation factor be equal to:  $20\log(3.125 / 100) = -30.1$  dB.
7. Average value = peak reading +  $20\log(\text{duty cycle})$ .



A D T

<b>CHANNEL</b>	TX Channel 39	<b>DETECTOR FUNCTION</b>	Peak (PK)
<b>FREQUENCY RANGE</b>	1GHz ~ 25GHz		

ANTENNA POLARITY & TEST DISTANCE: HORIZONTAL AT 3 M								
NO.	FREQ. (MHz)	EMISSION LEVEL (dBuV/m)	LIMIT (dBuV/m)	MARGIN (dB)	ANTENNA HEIGHT (m)	TABLE ANGLE (Degree)	RAW VALUE (dBuV)	CORRECTION FACTOR (dB/m)
1	*2441.00	104.2 PK			1.33 H	120	71.29	32.91
2	*2441.00	74.1 AV			1.33 H	120	41.19	32.91
3	4882.00	55.7 PK	74.0	-18.3	1.40 H	233	13.38	42.32
4	4882.00	25.6 AV	54.0	-28.4	1.40 H	233	-16.72	42.32
5	7323.00	56.4 PK	74.0	-17.6	1.60 H	329	9.41	46.99
6	7323.00	26.3 AV	54.0	-27.7	1.60 H	329	-20.69	46.99

ANTENNA POLARITY & TEST DISTANCE: VERTICAL AT 3 M								
NO.	FREQ. (MHz)	EMISSION LEVEL (dBuV/m)	LIMIT (dBuV/m)	MARGIN (dB)	ANTENNA HEIGHT (m)	TABLE ANGLE (Degree)	RAW VALUE (dBuV)	CORRECTION FACTOR (dB/m)
1	*2441.00	99.0 PK			1.06 V	278	66.09	32.91
2	*2441.00	68.9 AV			1.06 V	278	35.99	32.91
3	4882.00	56.3 PK	74.0	-17.7	1.59 V	160	13.98	42.32
4	4882.00	26.2 AV	54.0	-27.8	1.59 V	160	-16.12	42.32
5	7323.00	56.2 PK	74.0	-17.8	1.46 V	92	9.21	46.99
6	7323.00	26.1 AV	54.0	-27.9	1.46 V	92	-20.89	46.99

**REMARKS:**

1. Emission Level(dBuV/m) = Raw Value(dBuV) + Correction Factor(dB/m)
2. Correction Factor(dB/m) = Antenna Factor(dB/m) + Cable Factor(dB) – Pre-Amplifier Factor(dB)
3. The other emission levels were very low against the limit.
4. Margin value = Emission Level – Limit value
5. " \* ": Fundamental frequency.
6. The DH5 packet was the worse case duty cycle for a transmit dwell time on a channel, based upon bluetooth theory the transmitter is on 0.625 \* 5 per 296.25 ms per channel. Therefore, the duty cycle correlation factor be equal to:  $20\log(3.125 / 100) = -30.1$  dB.
7. Average value = peak reading +  $20\log(\text{duty cycle})$ .



A D T

<b>CHANNEL</b>	TX Channel 78	<b>DETECTOR FUNCTION</b>	Peak (PK)
<b>FREQUENCY RANGE</b>	1GHz ~ 25GHz		

**ANTENNA POLARITY & TEST DISTANCE: HORIZONTAL AT 3 M**

NO.	FREQ. (MHz)	EMISSION LEVEL (dBuV/m)	LIMIT (dBuV/m)	MARGIN (dB)	ANTENNA HEIGHT (m)	TABLE ANGLE (Degree)	RAW VALUE (dBuV)	CORRECTION FACTOR (dB/m)
1	*2480.00	103.8 PK			1.26 H	130	70.78	33.02
2	*2480.00	73.7 AV			1.26 H	130	40.68	33.02
3	2483.50	57.6 PK	74.0	-16.4	1.28 H	120	24.57	33.03
4	2483.50	27.5 AV	54.0	-26.5	1.28 H	120	-5.53	33.03
5	4960.00	56.5 PK	74.0	-17.5	1.42 H	206	14.20	42.30
6	4960.00	26.4 AV	54.0	-27.6	1.42 H	206	-15.90	42.30
7	7440.00	55.9 PK	74.0	-18.1	1.57 H	302	8.61	47.29
8	7440.00	25.8 AV	54.0	-28.2	1.57 H	302	-21.49	47.29

**ANTENNA POLARITY & TEST DISTANCE: VERTICAL AT 3 M**

NO.	FREQ. (MHz)	EMISSION LEVEL (dBuV/m)	LIMIT (dBuV/m)	MARGIN (dB)	ANTENNA HEIGHT (m)	TABLE ANGLE (Degree)	RAW VALUE (dBuV)	CORRECTION FACTOR (dB/m)
1	*2480.00	99.5 PK			1.00 V	91	66.48	33.02
2	*2480.00	69.4 AV			1.00 V	91	36.38	33.02
3	2483.50	61.7 PK	74.0	-12.3	1.00 V	91	28.67	33.03
4	2483.50	31.6 AV	54.0	-22.4	1.00 V	91	-1.43	33.03
5	4960.00	56.2 PK	74.0	-17.8	1.63 V	171	13.90	42.30
6	4960.00	26.1 AV	54.0	-27.9	1.63 V	171	-16.20	42.30
7	7440.00	55.7 PK	74.0	-18.3	1.47 V	84	8.41	47.29
8	7440.00	25.6 AV	54.0	-28.4	1.47 V	84	-21.69	47.29

**REMARKS:**

- Emission Level(dBuV/m) = Raw Value(dBuV) + Correction Factor(dB/m)
- Correction Factor(dB/m) = Antenna Factor(dB/m) + Cable Factor(dB) – Pre-Amplifier Factor(dB)
- The other emission levels were very low against the limit.
- Margin value = Emission Level – Limit value
- " \* ": Fundamental frequency.
- The DH5 packet was the worse case duty cycle for a transmit dwell time on a channel, based upon bluetooth theory the transmitter is on 0.625 \* 5 per 296.25 ms per channel. Therefore, the duty cycle correlation factor be equal to:  $20\log(3.125 / 100) = -30.1$  dB.
- Average value = peak reading +  $20\log(\text{duty cycle})$ .

### 4.3 NUMBER OF HOPPING FREQUENCY USED

#### 4.3.1 LIMIT OF HOPPING FREQUENCY USED

At least 15 hopping frequencies, and should be equally spaced.

#### 4.3.2 TEST INSTRUMENTS

DESCRIPTION & MANUFACTURER	MODEL NO.	SERIAL NO.	CALIBRATED DATE	CALIBRATED UNTIL
R&S SPECTRUM ANALYZER	FSP40	100037	Nov. 01, 2012	Oct. 31, 2013

**Note:**

1. The calibration interval of the above test instruments is 12 months and the calibrations are traceable to NML/ROC and NIST/USA.
2. Tested date : July 18, 2013

#### 4.3.3 TEST PROCEDURES

- a. Check the calibration of the measuring instrument (SA) using either an internal calibrator or a known signal from an external generator.
- b. Turn on the EUT and connect its antenna terminal to measurement via a low loss cable. Then set it to any one measured frequency within its operating range and make sure the instrument is operated in its linear range.
- c. Set the SA on MaxHold Mode, and then keep the EUT in hopping mode. Record all the signals from each channel until each one has been recorded.
- d. Set the SA on View mode and then plot the result on SA screen.
- e. Repeat above procedures until all frequencies measured were complete.

#### 4.3.4 DEVIATION FROM TEST STANDARD

No deviation



### 4.3.5 TEST SETUP

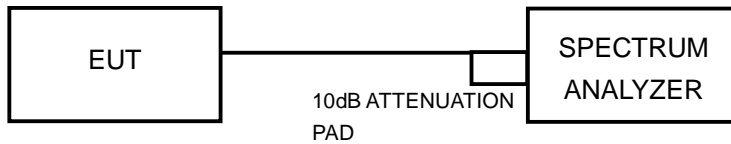

### 4.3.6 TEST RESULTS

There are 79 hopping frequencies in the hopping mode. Please refer the test result. On the plots, it shows that the hopping frequencies are equally spaced.

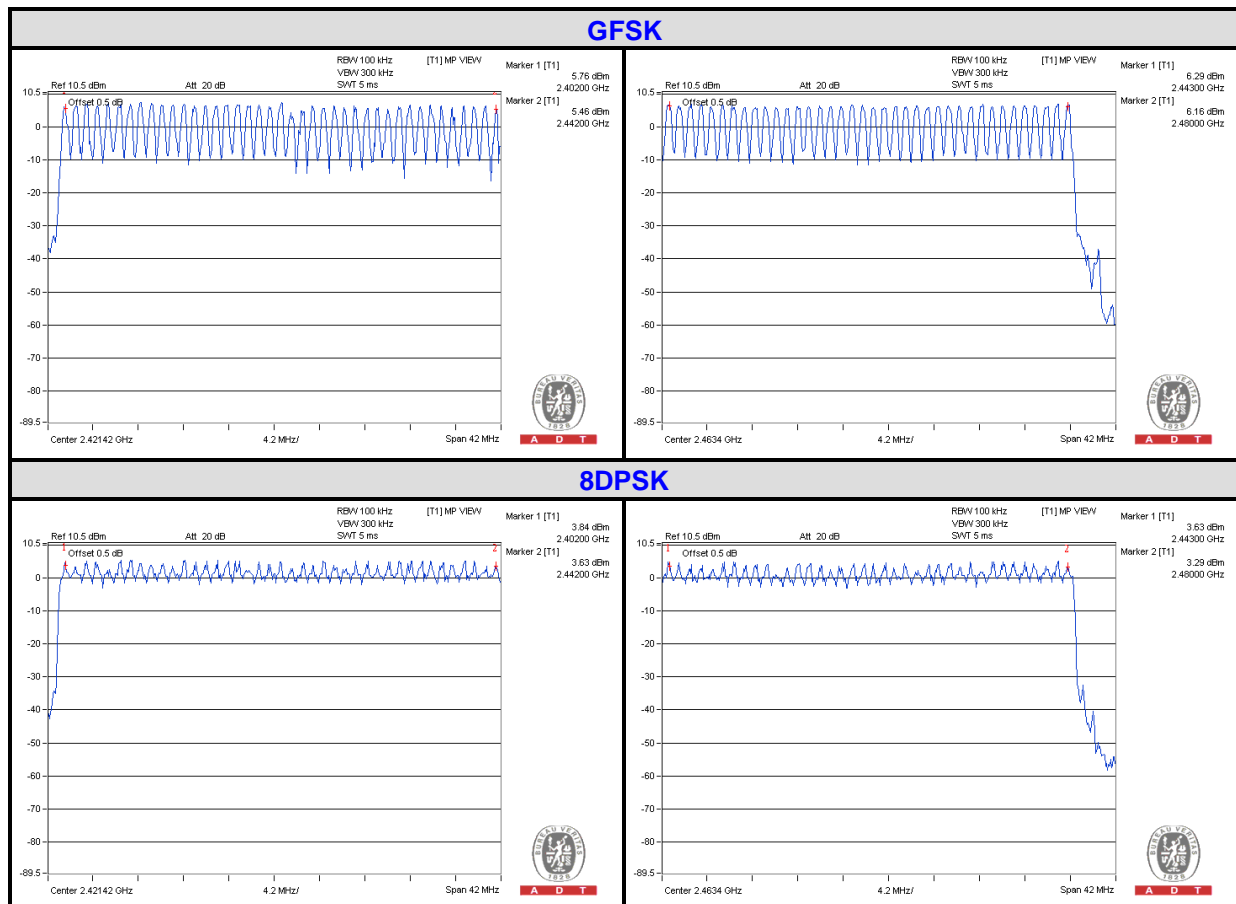

## 4.4 DWELL TIME ON EACH CHANNEL

### 4.4.1 LIMIT OF DWELL TIME USED

The average time of occupancy on any channel shall not be greater than 0.4 seconds within a period of 0.4 seconds multiplied by the number of hopping channels employed.

### 4.4.2 TEST INSTRUMENTS

DESCRIPTION & MANUFACTURER	MODEL NO.	SERIAL NO.	CALIBRATED DATE	CALIBRATED UNTIL
R&S Spectrum Analyzer	FSP40	100037	Nov. 01, 2012	Oct. 31, 2013

**Note:**

1. The calibration interval of the above test instruments is 12 months and the calibrations are traceable to NML/ROC and NIST/USA.
2. Tested date : July 18, 2013

### 4.4.3 TEST PROCEDURES

- a. Check the calibration of the measuring instrument (SA) using either an internal calibrator or a known signal from an external generator.
- b. Turn on the EUT and connect its antenna terminal to measurement via a low loss cable. Then set it to any one measured frequency within its operating range and make sure the instrument is operated in its linear range.
- c. Adjust the center frequency of SA on any frequency be measured and set SA to zero span mode. And then, set RBW and VBW of spectrum analyzer to proper value.
- d. Measure the time duration of one transmission on the measured frequency. And then plot the result with time difference of this time duration.
- e. Repeat above procedures until all different time-slot modes have been completed.

#### 4.4.4 DEVIATION FROM TEST STANDARD

No deviation

#### 4.4.5 TEST SETUP

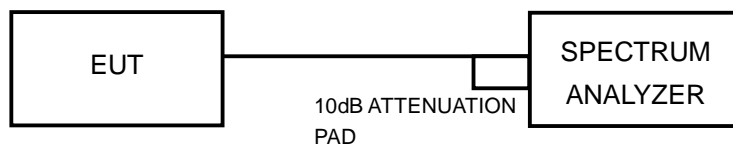

#### 4.4.6 TEST RESULTS

For GFSK:

Mode	Number of transmission in a 31.6 (79Hopping*0.4)	Length of transmission time (msec)	Result (msec)	Limit (msec)
DH1	51 (times / 5 sec) *6.32=322.32 times	0.468	150.85	400
DH3	25 (times / 5 sec) *6.32=158 times	1.75	276.5	400
DH5	17 (times / 5 sec) *6.32=107.44 times	3.024	324.9	400

**NOTE:** Test plots of the transmitting time slot are shown on next page.



A D T

### DH1

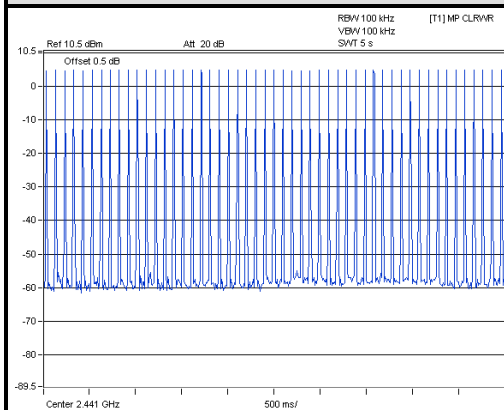

A D T

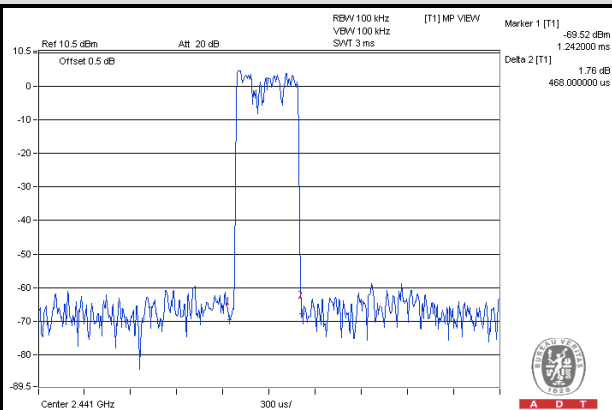

A D T

### DH3

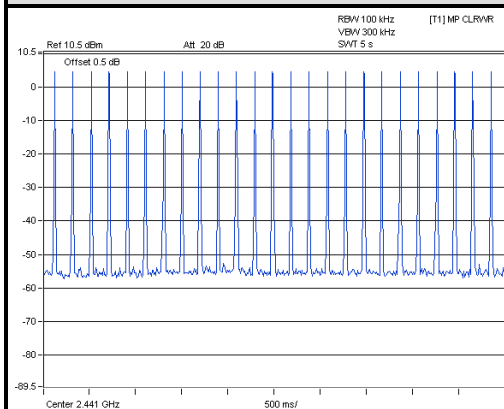

A D T

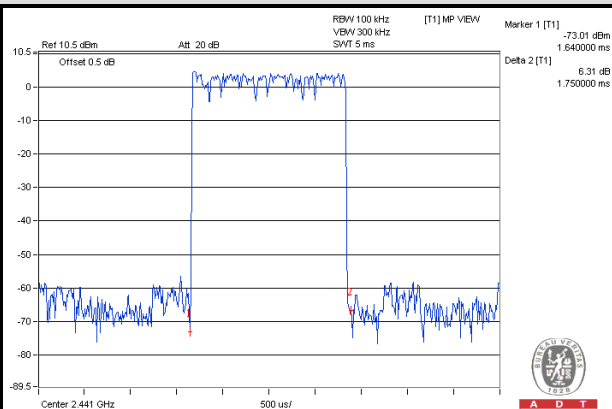

A D T

### DH5

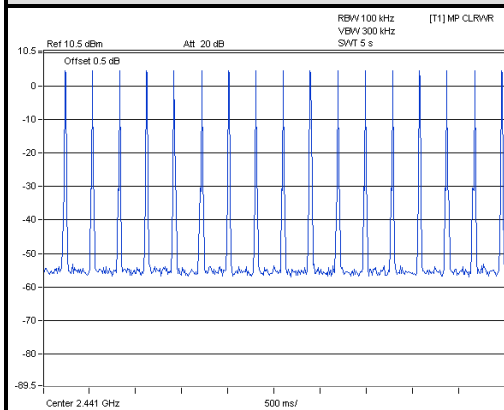

A D T

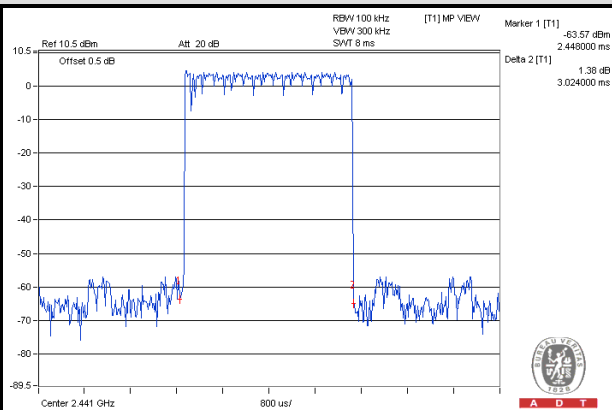

A D T



A D T

**For 8DPSK:**

Mode	Number of transmission in a 31.6 (79Hopping*0.4)	Length of transmission time (msec)	Result (msec)	Limit (msec)
DH1	50 (times / 5 sec) *6.32=322.32 times	0.48	154.71	400
DH3	25 (times / 5 sec) *6.32=158 times	1.73	273.34	400
DH5	17 (times / 5 sec) *6.32=107.44 times	3.072	330.06	400

**NOTE:** Test plots of the transmitting time slot are shown on next page.



A D T

### DH1

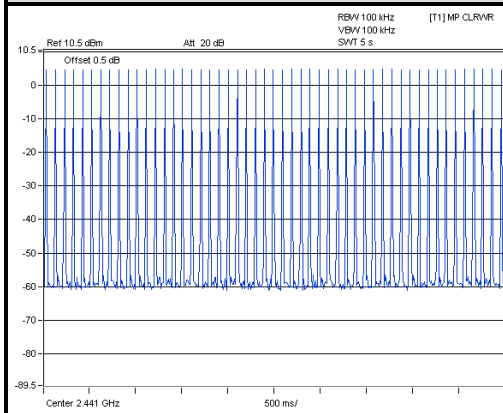

A D T

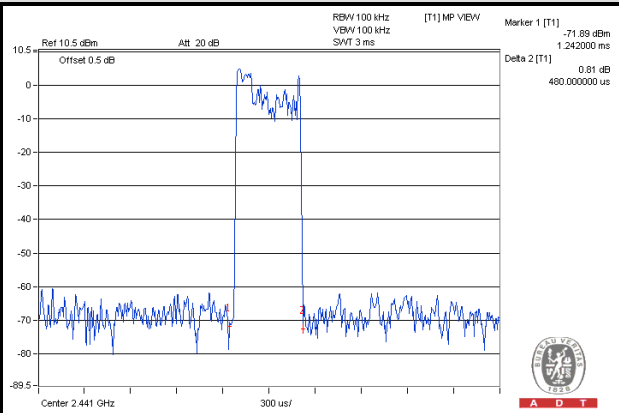

A D T

### DH3

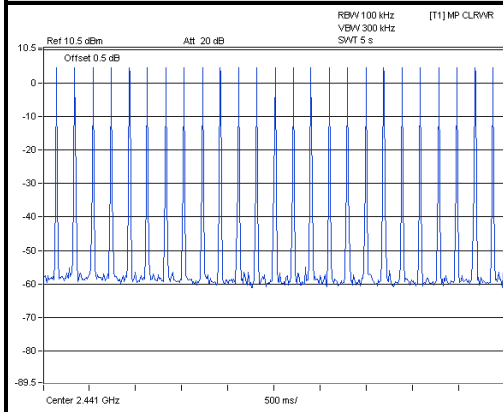

A D T

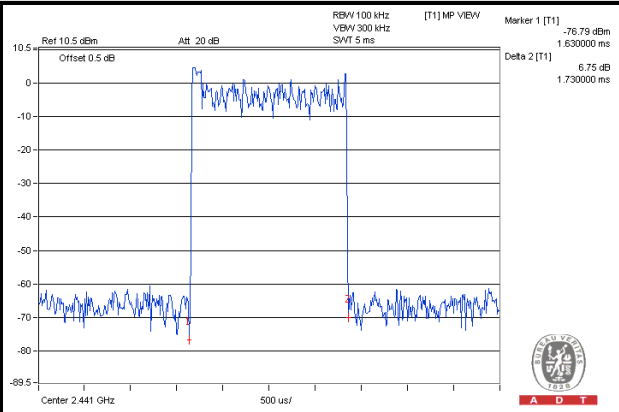

A D T

### DH5

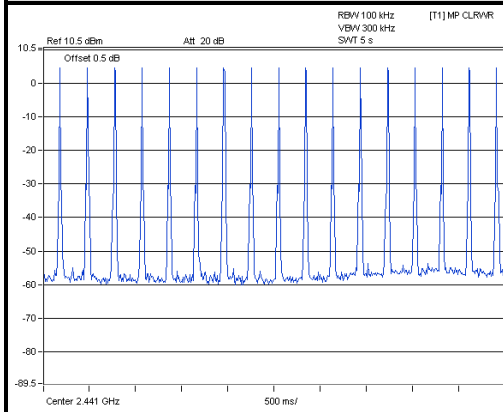

A D T

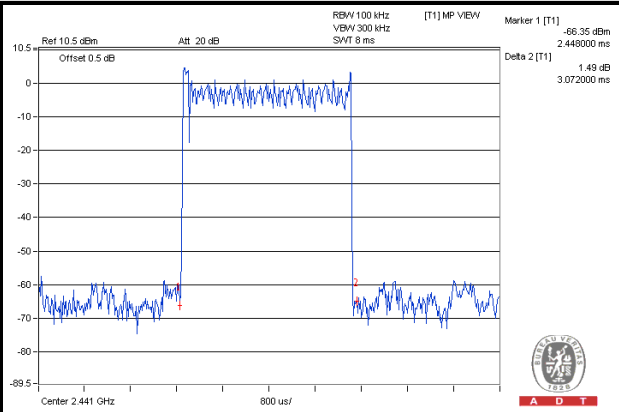

A D T

## 4.5 CHANNEL BANDWIDTH

### 4.5.1 LIMITS OF CHANNEL BANDWIDTH

For frequency hopping system operating in the 2400-2483.5MHz, If the 20dB bandwidth of hopping channel is greater than 25kHz, two-thirds 20dB bandwidth of hopping channel shall be a minimum limit for the hopping channel separation.

### 4.5.2 TEST INSTRUMENTS

DESCRIPTION & MANUFACTURER	MODEL NO.	SERIAL NO.	CALIBRATED DATE	CALIBRATED UNTIL
R&S Spectrum Analyzer	FSP40	100037	Nov. 01, 2012	Oct. 31, 2013

**Note:**

1. The calibration interval of the above test instruments is 12 months and the calibrations are traceable to NML/ROC and NIST/USA.
2. Tested date : July 18, 2013

### 4.5.3 TEST PROCEDURE

- a. Check the calibration of the measuring instrument using either an internal calibrator or a known signal from an external generator.
- b. Turn on the EUT and connect it to measurement instrument. Then set it to any one convenient frequency within its operating range. Set a reference level on the measuring instrument equal to the highest peak value.
- c. Measure the frequency difference of two frequencies that were attenuated 20dB from the reference level. Record the frequency difference as the emission bandwidth.
- d. Repeat above procedures until all frequencies measured were complete.

### 4.5.4 DEVIATION FROM TEST STANDARD

No deviation



#### 4.5.5 TEST SETUP

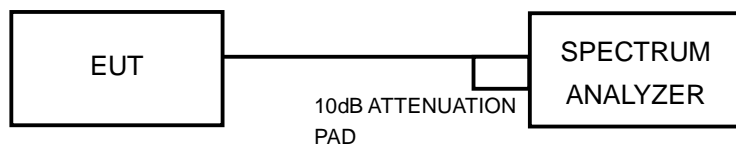

#### 4.5.6 EUT OPERATING CONDITION

The software provided by client enabled the EUT to transmit and receive data at lowest, middle and highest channel frequencies individually.



A D T

### 4.5.7 TEST RESULTS

CHANNEL	FREQUENCY (MHz)	20dB BANDWIDTH (MHz)	
		GFSK	8DPSK
0	2402	0.94	1.29
39	2441	0.94	1.27
78	2480	0.94	1.28

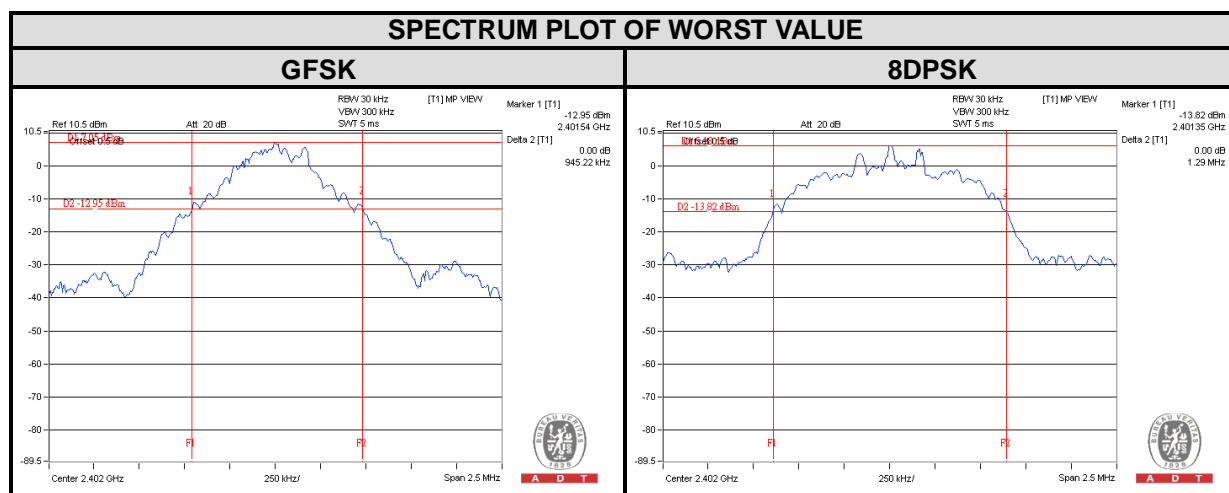

## 4.6 HOPPING CHANNEL SEPARATION

### 4.6.1 LIMIT OF HOPPING CHANNEL SEPARATION

At least 25 kHz or two-thirds of 20dB hopping channel bandwidth (whichever is greater).

### 4.6.2 TEST INSTRUMENTS

DESCRIPTION & MANUFACTURER	MODEL NO.	SERIAL NO.	CALIBRATED DATE	CALIBRATED UNTIL
R&S Spectrum Analyzer	FSP40	100037	Nov. 01, 2012	Oct. 31, 2013

**Note:**

1. The calibration interval of the above test instruments is 12 months and the calibrations are traceable to NML/ROC and NIST/USA.
2. Tested date : July 18, 2013

### 4.6.3 TEST PROCEDURES

- a. Check the calibration of the measuring instrument using either an internal calibrator or a known signal from an external generator.
- b. Turn on the EUT and connect it to measurement instrument. Then set it to any one convenient frequency within its operating range.
- c. By using the MaxHold function record the separation of two adjacent channels.
- d. Measure the frequency difference of these two adjacent channels by SA MARK function. And then plot the result on SA screen.
- e. Repeat above procedures until all frequencies measured were complete.

### 4.6.4 DEVIATION FROM TEST STANDARD

No deviation

### 4.6.5 TEST SETUP

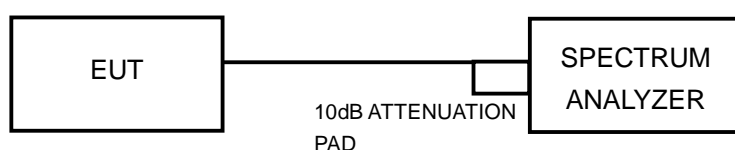



A D T

### 4.6.6 TEST RESULTS

CHANNEL	FREQUENCY (MHz)	ADJACENT CHANNEL SEPARATION (MHz)		20dB BANDWIDTH (MHz)		MINIMUM LIMIT (MHz)		PASS / FAIL
		GFSK	8DPSK	GFSK	8DPSK	GFSK	8DPSK	
0	2402	1.00	1.00	0.94	1.29	0.63	0.86	PASS
39	2441	1.00	1.00	0.94	1.27	0.63	0.85	PASS
78	2480	1.01	1.01	0.94	1.28	0.63	0.85	PASS

**NOTE:** The minimum limit is two-third 20dB bandwidth.

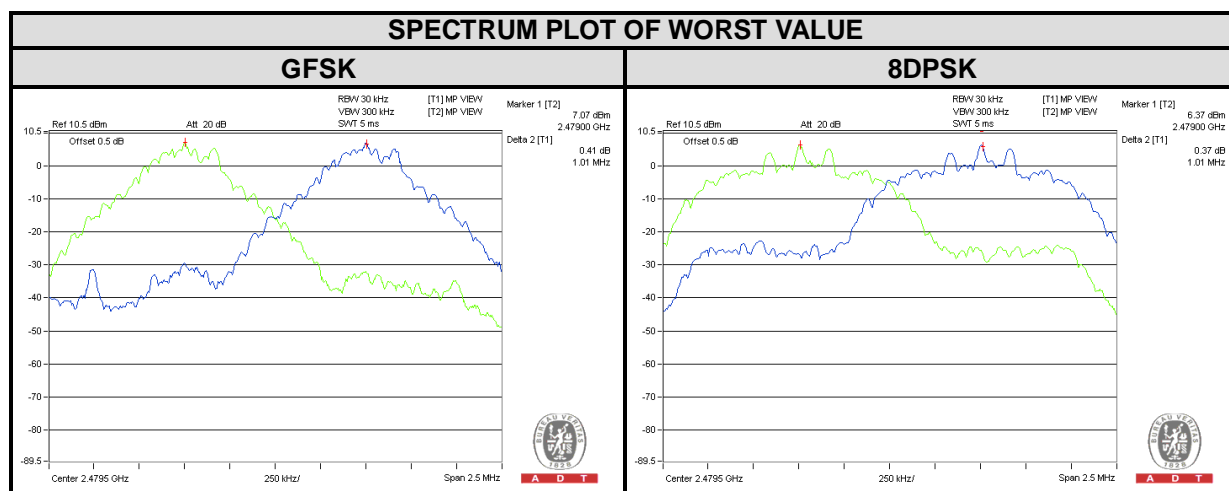

## 4.7 MAXIMUM PEAK OUTPUT POWER

### 4.7.1 LIMITS OF MAXIMUM PEAK OUTPUT POWER MEASUREMENT

The Maximum Peak Output Power Limit is 125mW.

### 4.7.2 INSTRUMENTS

DESCRIPTION & MANUFACTURER	MODEL NO.	SERIAL NO.	CALIBRATED DATE	CALIBRATED UNTIL
R&S Spectrum Analyzer	FSP40	100037	Nov. 01, 2012	Oct. 31, 2013

**Note:**

1. The calibration interval of the above test instruments is 12 months and the calibrations are traceable to NML/ROC and NIST/USA.
2. Tested date : July 18, 2013

### 4.7.3 TEST PROCEDURES

- a. Check the calibration of the measuring instrument using either an internal calibrator or a known signal from an external generator.
- b. Turn on the EUT and connect it to measurement instrument. Then set it to any one convenient frequency within its operating range. Set a reference level on the measuring instrument equal to the highest peak value.
- c. The center frequency of the spectrum analyzer is set to the fundamental frequency and using 3MHz RBW and 10 MHz VBW.
- d. Measure the captured power within the band and recording the plot.
- e. Repeat above procedures until all frequencies required were complete.

### 4.7.4 DEVIATION FROM TEST STANDARD

No deviation

#### 4.7.5 TEST SETUP

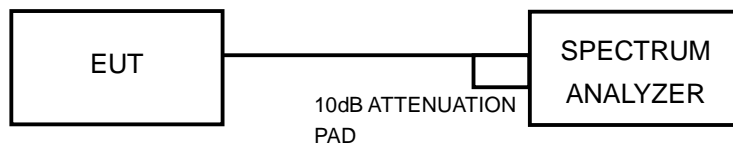

For the actual test configuration, please refer to the related Item – Photographs of the Test Configuration.

#### 4.7.6 EUT OPERATING CONDITION

The software provided by client enabled the EUT to transmit and receive data at lowest, middle and highest channel frequencies individually.



A D T

### 4.7.7 TEST RESULTS

CHANNEL	FREQUENCY (MHz)	OUTPUT POWER (mW)		OUTPUT POWER (dBm)		POWER LIMIT (mW)	PASS / FAIL
		GFSK	8DPSK	GFSK	8DPSK		
0	2402	7.063	6.180	8.49	7.91	125	PASS
39	2441	6.577	5.794	8.18	7.63	125	PASS
78	2480	6.397	5.834	8.06	7.66	125	PASS

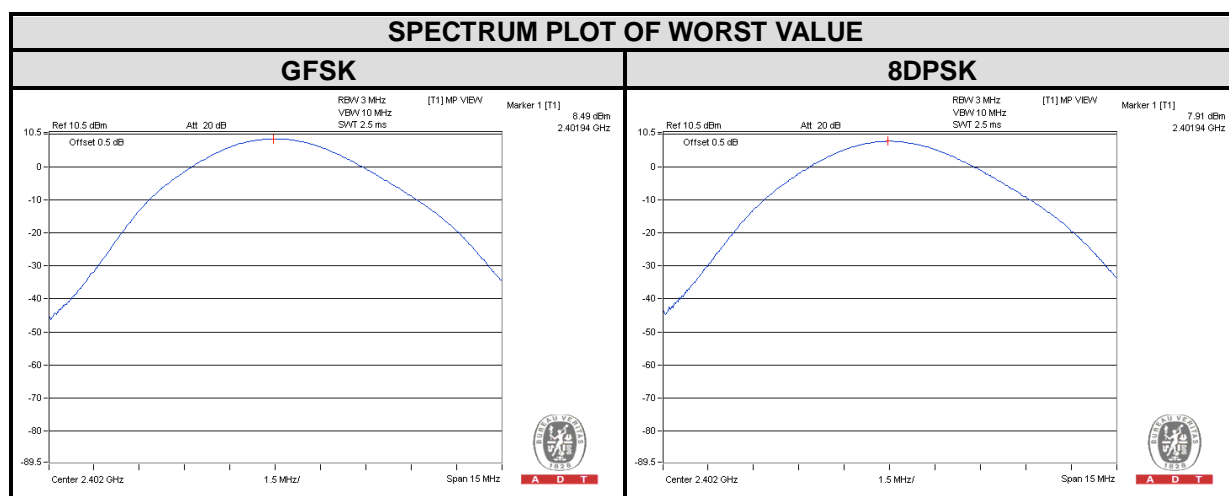

## 4.8 CONDUCTED OUT-BAND EMISSION MEASUREMENT

### 4.8.1 LIMITS OF CONDUCTED OUT-BAND EMISSION MEASUREMENT

Below 20dB of the highest emission level of operating band (in 100kHz Resolution Bandwidth).

### 4.8.2 TEST INSTRUMENTS

DESCRIPTION & MANUFACTURER	MODEL NO.	SERIAL NO.	CALIBRATED DATE	CALIBRATED UNTIL
R&S Spectrum Analyzer	FSP40	100037	Nov. 01, 2012	Oct. 31, 2013

**Note:**

1. The calibration interval of the above test instruments is 12 months and the calibrations are traceable to NML/ROC and NIST/USA.
2. Tested date : July 18, 2013

### 4.8.3 TEST PROCEDURE

The transmitter output was connected to the spectrum analyzer via a low lose cable. Set RBW a of spectrum analyzer to 100 kHz and VBW of spectrum analyzer to 300 kHz with suitable frequency span including 100 MHz bandwidth from band edge. The band edges was measured and recorded.

### 4.8.4 DEVIATION FROM TEST STANDARD

No deviation

### 4.8.5 TEST SETUP

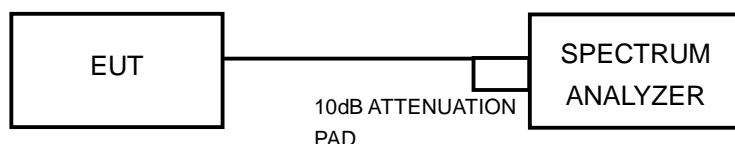

### 4.8.6 EUT OPERATING CONDITION

The software provided by client enabled the EUT to transmit and receive data at lowest, middle and highest channel frequencies individually.



#### 4.8.7 TEST RESULTS

The spectrum plots are attached on the following images. D1 line indicates the highest level, and D2 line indicates the 20dB offset below D1. It shows compliance with the requirement.



A D T

# GFSK

## Hopping disabled\_Low Channel

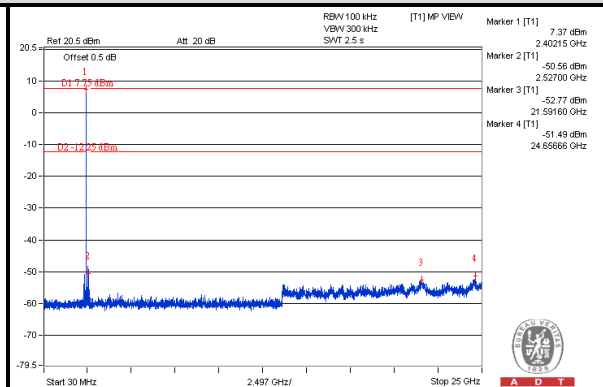
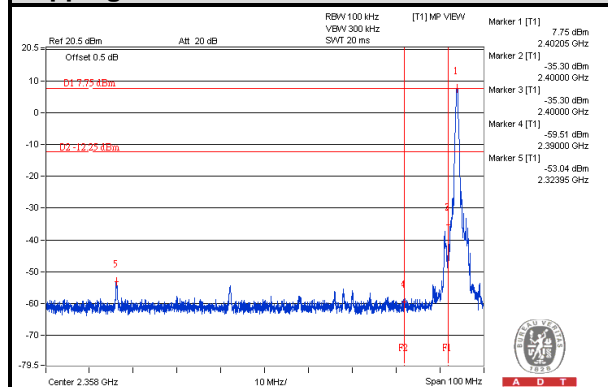

## Hopping disabled\_High Channel

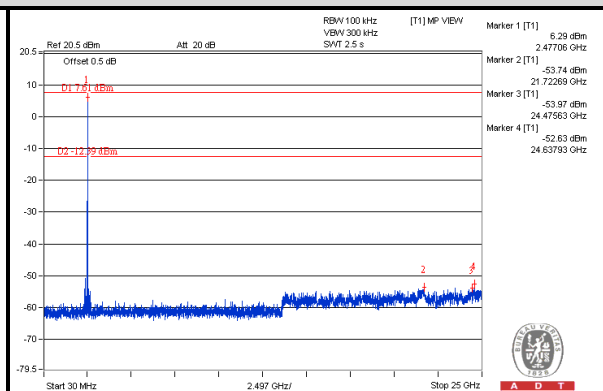
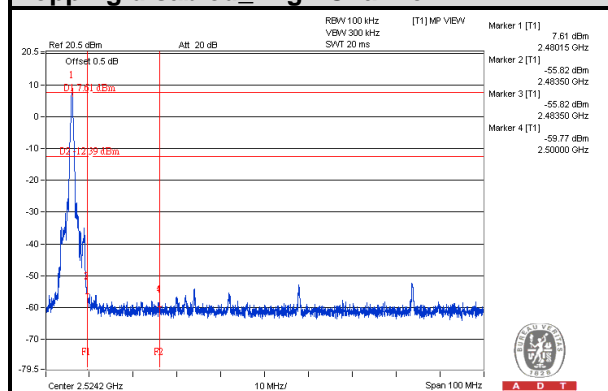

## Hopping enabled\_Low Channel

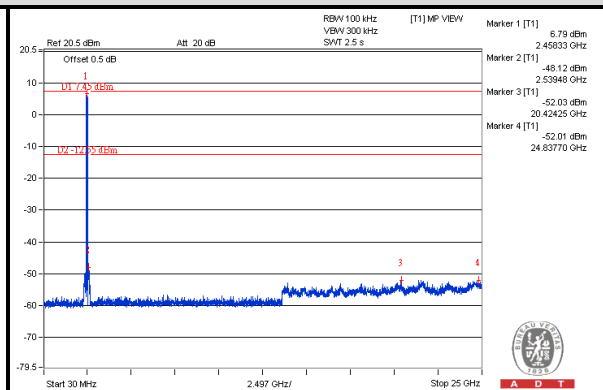
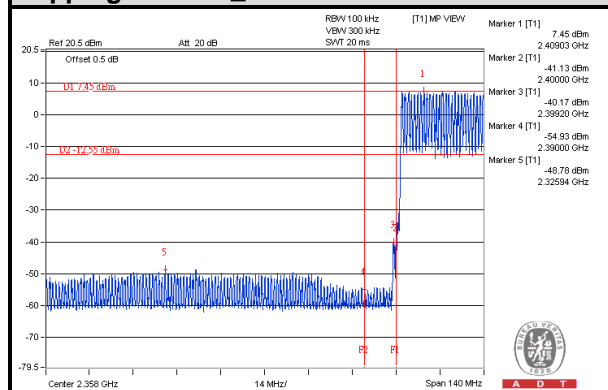

## Hopping enabled\_High Channel

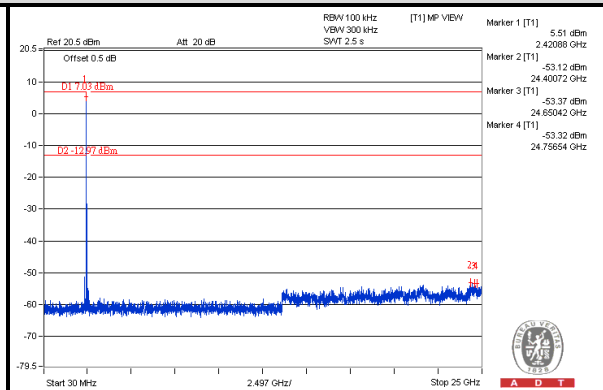
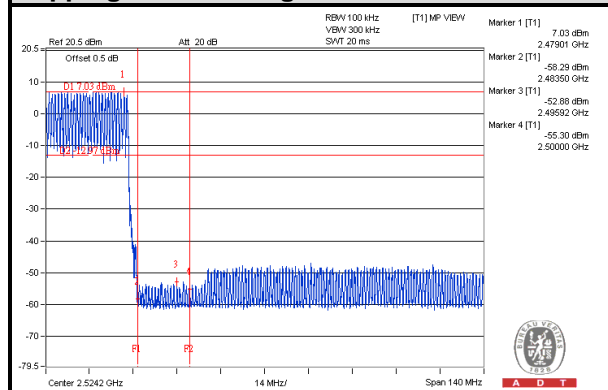



A D T

# 8DPSK

## Hopping disabled\_ Low Channel

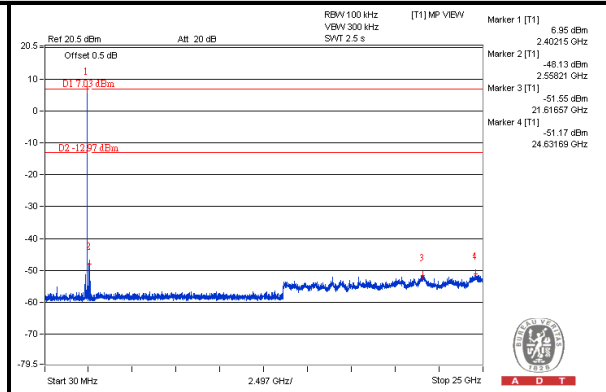
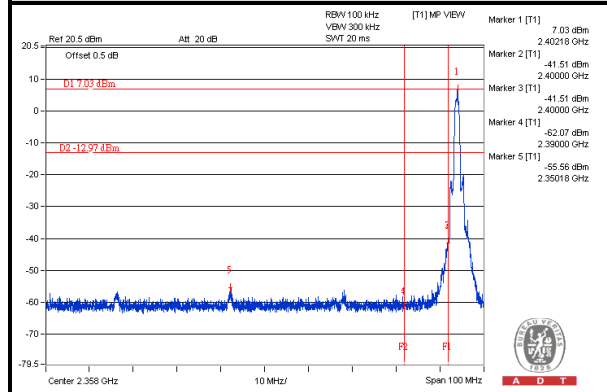

## Hopping disabled\_ High Channel

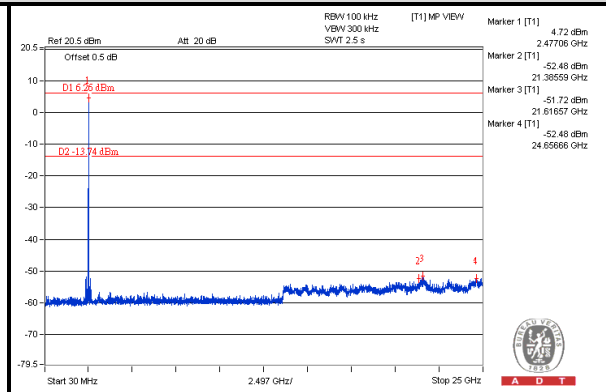
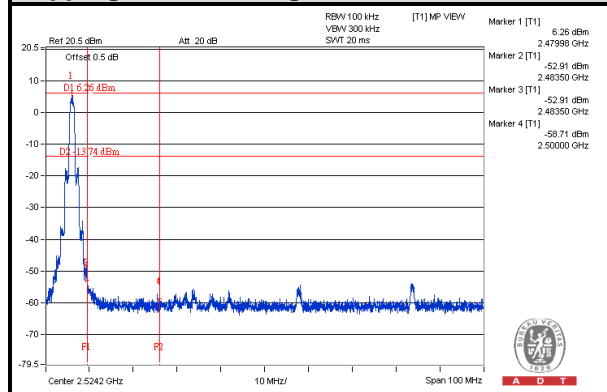

## Hopping enabled\_ Low Channel

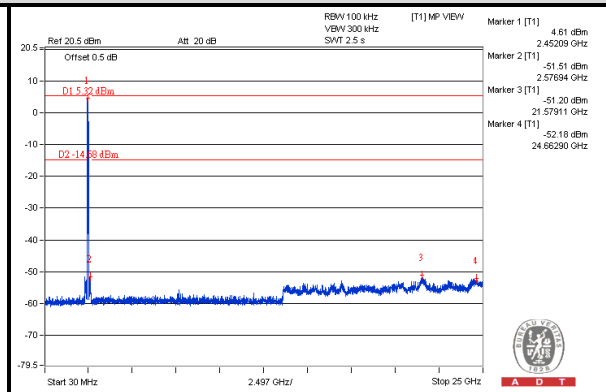
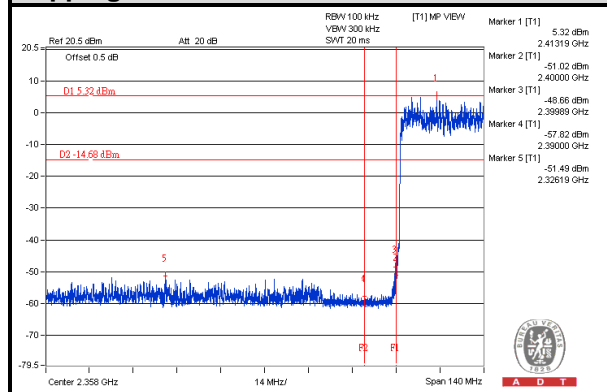

## Hopping enabled\_ High Channel

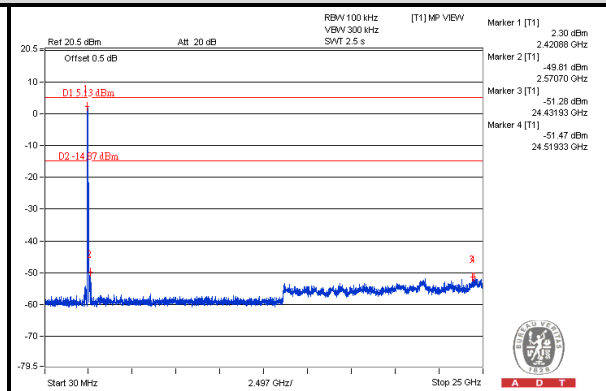
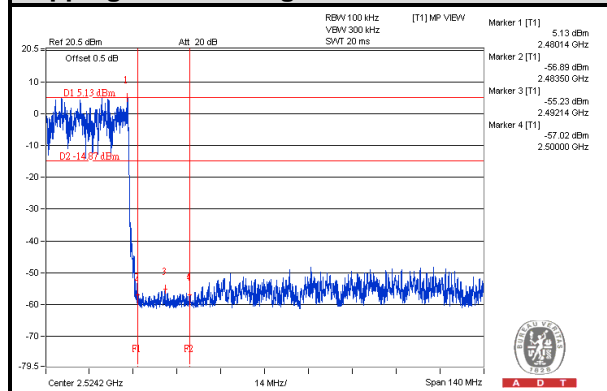



## 5 PHOTOGRAPHS OF THE TEST CONFIGURATION

Please refer to the attached file (Test Setup Photo).



## 6 INFORMATION ON THE TESTING LABORATORIES

We, Bureau Veritas Consumer Products Services (H.K.) Ltd., Taoyuan Branch, were founded in 1988 to provide our best service in EMC, Radio, Telecom and Safety consultation. Our laboratories are accredited and approved according to ISO/IEC 17025.

If you have any comments, please feel free to contact us at the following:

**Linko EMC/RF Lab:**

Tel: 886-2-26052180

Fax: 886-2-26052943

**Hsin Chu EMC/RF Lab:**

Tel: 886-3-5935343

Fax: 886-3-5935342

**Hwa Ya EMC/RF/Safety/Telecom Lab:**

Tel: 886-3-3183232

Fax: 886-3-3270892

**Email:** [service.adt@tw.bureauveritas.com](mailto:service.adt@tw.bureauveritas.com)

**Web Site:** [www.bureauveritas-adt.com](http://www.bureauveritas-adt.com)

The address and road map of all our labs can be found in our web site also.

## **7 APPENDIX A - MODIFICATIONS RECORDERS FOR ENGINEERING CHANGES TO THE EUT BY THE LAB**

No modifications were made to the EUT by the lab during the test.

**--- END ---**