

TEST REPORT

CERTIFICATE OF CONFORMITY

Standard: 47 CFR FCC Part 15, Subpart C (Section 15.247)
Report No.: RFBDKG-WTW-P22070088 R1
FCC ID: JNZPR0005
Model No.: PR0005
Received Date: 2022/5/21
Test Date: 2022/7/7 ~ 2022/7/13
Issued Date: 2023/2/8

Applicant: Logitech Far East Ltd.
Address: 3930 North First Street, San Jose, California 95134
Issued By: Bureau Veritas Consumer Products Services (H.K.) Ltd., Taoyuan Branch
Hsin Chu Laboratory
Lab Address: E-2, No.1, Li Hsin 1st Road, Hsinchu Science Park, Hsinchu City 300, Taiwan
Test Location: E-2, No.1, Li Hsin 1st Road, Hsinchu Science Park, Hsinchu City 300, Taiwan
FCC Registration / 723255 / TW2022
Designation Number:

Approved by: _____



May Chen / Manager

, Date: _____

2023/2/8

This test report consists of 73 pages in total. It may be duplicated completely for legal use with the approval of the applicant. It should not be reproduced except in full, without the written approval of our laboratory. The test results in the report only apply to the tested sample. The test results in this report are traceable to the national or international standards.

Prepared by : Vito Lung / Specialist



This report is governed by, and incorporates by reference, the Conditions of Testing as posted at the date of issuance of this report at <http://www.bureauveritas.com/home/about-us/our-business/cps/about-us/terms-conditions/> and is intended for your exclusive use. Any copying or replication of this report to or for any other person or entity, or use of our name or trademark, is permitted only with our prior written permission. This report sets forth our findings solely with respect to the test samples identified herein. The results set forth in this report are not indicative or representative of the quality or characteristics of the lot from which a test sample was taken or any similar or identical product unless specifically and expressly noted. Our report includes all of the tests requested by you and the results thereof based upon the information that you provided to us. Measurement uncertainty is only provided upon request for accredited tests. Statements of conformity are based on simple acceptance criteria without taking measurement uncertainty into account, unless otherwise requested in writing. You have 60 days from date of issuance of this report to notify us of any material error or omission caused by our negligence or if you require measurement uncertainty; provided, however, that such notice shall be in writing and shall specifically address the issue you wish to raise. A failure to raise such issue within the prescribed time shall constitute your unqualified acceptance of the completeness of this report, the tests conducted and the correctness of the report contents.

Table of Contents

Release Control Record	4
1 Certificate.....	5
2 Summary of Test Results	6
2.1 Measurement Uncertainty	6
2.2 Supplementary Information	6
3 General Information	7
3.1 General Description	7
3.2 Antenna Description of EUT	8
3.3 Channel List.....	9
3.4 Test Mode Applicability and Tested Channel Detail.....	10
3.5 Duty Cycle of Test Signal.....	11
3.6 Test Program Used and Operation Descriptions	12
3.7 Connection Diagram of EUT and Peripheral Devices	13
3.8 Configuration of Peripheral Devices and Cable Connections	14
4 Test Instruments	15
4.1 RF Output Power.....	15
4.2 Power Spectral Density	15
4.3 6 dB Bandwidth	15
4.4 Conducted Out of Band Emissions	15
4.5 AC Power Conducted Emissions	16
4.6 Unwanted Emissions below 1 GHz	16
4.7 Unwanted Emissions above 1 GHz.....	17
5 Limits of Test Items.....	18
5.1 RF Output Power.....	18
5.2 Power Spectral Density	18
5.3 6 dB Bandwidth	18
5.4 Conducted Out of Band Emissions	18
5.5 AC Power Conducted Emissions	18
5.6 Unwanted Emissions below 1 GHz	18
5.7 Unwanted Emissions above 1 GHz.....	19
6 Test Arrangements.....	20
6.1 RF Output Power.....	20
6.1.1 Test Setup	20
6.1.2 Test Procedure.....	20
6.2 Power Spectral Density	20
6.2.1 Test Setup	20
6.2.2 Test Procedure.....	20
6.3 6 dB Bandwidth	21
6.3.1 Test Setup	21
6.3.2 Test Procedure.....	21
6.4 Conducted Out of Band Emissions	21
6.4.1 Test Setup	21
6.4.2 Test Procedure.....	21
6.5 AC Power Conducted Emissions	22
6.5.1 Test Setup	22
6.5.2 Test Procedure.....	22
6.6 Unwanted Emissions below 1 GHz	23
6.6.1 Test Setup	23
6.6.2 Test Procedure.....	24
6.7 Unwanted Emissions above 1 GHz.....	25
6.7.1 Test Setup	25
6.7.2 Test Procedure.....	25
7 Test Results of Test Item	26



7.1	RF Output Power	26
7.2	Power Spectral Density	28
7.3	6 dB Bandwidth	30
7.4	Conducted Out of Band Emissions	32
7.5	AC Power Conducted Emissions	36
7.6	Unwanted Emissions below 1 GHz	40
7.7	Unwanted Emissions above 1 GHz	44
8	Pictures of Test Arrangements	72
9	Information of the Testing Laboratories	73



Release Control Record

Issue No.	Description	Date Issued
RFBDKG-WTW-P22070088	Original release.	2022/8/5
RFBDKG-WTW-P22070088 R1	Modified the section 3.2.(Antenna Type)	2023/2/8

1 Certificate

Product: Touchpad
Brand: Logitech
Test Model: PR0005
Sample Status: Engineering sample
Applicant: Logitech Far East Ltd.
Test Date: 2022/7/7 ~ 2022/7/13
Standard: 47 CFR FCC Part 15, Subpart C (Section 15.247)
Measurement procedure: ANSI C63.10-2013
KDB 558074 D01 15.247 Meas Guidance v05r02

The above equipment has been tested by **Bureau Veritas Consumer Products Services (H.K.) Ltd., Taoyuan Branch**, and found compliance with the requirement of the above standards. The test record, data evaluation & Equipment Under Test (EUT) configurations represented herein are true and accurate accounts of the measurements of the sample's RF characteristics under the conditions specified in this report.

2 Summary of Test Results

47 CFR FCC Part 15, Subpart C (Section 15.247)			
Standard / Clause	Test Item	Result	Remark
15.247(b)	RF Output Power	Pass	Meet the requirement of limit.
15.247(e)	Power Spectral Density	Pass	Meet the requirement of limit.
15.247(a)(2)	6 dB Bandwidth	Pass	Meet the requirement of limit.
15.247(d)	Conducted Out of Band Emissions	Pass	Meet the requirement of limit.
15.207	AC Power Conducted Emissions	Pass	Minimum passing margin is -14.60 dB at 0.48594 MHz
15.205 / 15.209 / 15.247(d)	Unwanted Emissions below 1 GHz	Pass	Minimum passing margin is -12.5 dB at 57.99 MHz
15.205 / 15.209 / 15.247(d)	Unwanted Emissions above 1 GHz	Pass	Minimum passing margin is -9.7 dB at 2390.00 MHz
15.203	Antenna Requirement	Pass	No antenna connector is used.

Note: Determining compliance based on the results of the compliance measurement, not taking into account measurement instrumentation uncertainty.

2.1 Measurement Uncertainty

Where relevant, the following measurement uncertainty levels have been estimated for tests performed on the EUT as specified in CISPR 16-4-2:

Parameter	Specification	Expanded Uncertainty (k=2) (±)
Conducted Out of Band Emissions	9 kHz ~ 40 GHz	2.5 dB
AC Power Conducted Emissions	150 kHz ~ 30 MHz	1.9 dB
Unwanted Emissions below 1 GHz	9 kHz ~ 30 MHz	3.1 dB
	30 MHz ~ 1 GHz	5.1 dB
Unwanted Emissions above 1 GHz	1 GHz ~ 18 GHz	5.1 dB
	18 GHz ~ 40 GHz	5.3 dB

The other instruments specified are routine verified to remain within the calibrated levels, no measurement uncertainty is required to be calculated.

2.2 Supplementary Information

There is not any deviation from the test standards for the test method, and no modifications required for compliance.

3 General Information

3.1 General Description

Product	Touchpad
Brand	Logitech
Test Model	PR0005
Status of EUT	Engineering sample
Power Supply Rating	DC 3.8V from battery or DC 5V from USB interface
Modulation Type	GFSK
Modulation Technology	DTS
Transfer Rate	Up to 2 Mbps (*Note 1)
Operating Frequency	2402 ~ 2480 MHz(*Note 1)
Number of Channel	40(*Note 1)
Output Power	BT-LE function: BT-LE 1M: 4.624 mW (6.65 dBm) BT-LE 2M: 4.634 mW (6.66 dBm) logi bolt function: logi bolt 1M: 4.613 mW (6.64 dBm) logi bolt 2M: 4.624 mW (6.65 dBm)
Cable Supplied	Type C cable x1 (Shielded, 1m)

Note:

1. BT-LE technique supports 1Mbps and 2Mbps data rates, both have been evaluated in this test report. Refer to “**section 3.3 Description of Test Modes**” for more detail specification.
2. The EUT may have a lot of colors for marketing requirement.
3. This device has BT-LE and logi bolt functions. logi bolt is the same technology as BT-LE then enhancement secure protocol.
4. The EUT must be supplied with a battery as following table:

Battery 1		
Brand	Model	Specification
SYNERGY	AHB303038HPJT or 533-000223	Rating : 3.8V,445mAh, 1.69Wh
Battery 2		
Brand	Model	Specification
Springpower Technology(ShenZhen) Co.,LTD.	303038 or 533-000222	Rating : 3.8V,435mAh, 1.65Wh

5. The above EUT information is declared by manufacturer and for more detailed features description, please refer to the manufacturer's specifications or User's Manual.

3.2 Antenna Description of EUT

1. The antenna information is listed as below.

Antenna Gain (dBi)	Frequency Range (GHz)	Antenna Type	Connector Type
1	2.4~2.4835	Reverted F	None

*Detail antenna specification please refer to antenna datasheet and/or antenna measurement report.



3.3 Channel List

BT-LE & logi bolt channels:

RF Channel	RF Center Frequency	Channel Index	Channels Type for BT 5.x		Channels Type for BT 4.x
			Maximum Data Rate 2Mbps	Maximum Data Rate 1Mbps	Maximum Data Rate 1Mbps
0	2402 MHz	37		●	●
1	2404 MHz	0	●		●
2	2406 MHz	1	●		●
3	2408 MHz	2	●		●
4	2410 MHz	3	●		●
5	2412 MHz	4	●		●
6	2414 MHz	5	●		●
7	2416 MHz	6	●		●
8	2418 MHz	7	●		●
9	2420 MHz	8	●		●
10	2422 MHz	9	●		●
11	2424 MHz	10	●		●
12	2426 MHz	38		●	●
13	2428 MHz	11	●		●
14	2430 MHz	12	●		●
15	2432 MHz	13	●		●
16	2434 MHz	14	●		●
17	2436 MHz	15	●		●
18	2438 MHz	16	●		●
19	2440 MHz	17	●		●
20	2442 MHz	18	●		●
21	2444 MHz	19	●		●
22	2446 MHz	20	●		●
23	2448 MHz	21	●		●
24	2450 MHz	22	●		●
25	2452 MHz	23	●		●
26	2454 MHz	24	●		●
27	2456 MHz	25	●		●
28	2458 MHz	26	●		●
29	2460 MHz	27	●		●
30	2462 MHz	28	●		●
31	2464 MHz	29	●		●
32	2466 MHz	30	●		●
33	2468 MHz	31	●		●
34	2470 MHz	32	●		●
35	2472 MHz	33	●		●
36	2474 MHz	34	●		●
37	2476 MHz	35	●		●
38	2478 MHz	36	●		●
39	2480 MHz	39		●	●

3.4 Test Mode Applicability and Tested Channel Detail

Pre-Scan:	<p>1. The Battery has the following models: AHB303038HPJT/ 303038. Pre-scan these models of batteries and find the worst case as a representative test condition.</p> <p>2. For Unwanted Emission below 1GHz items: Battery/ AC Adapter. Pre-scan these modes and find the worst case as a representative test condition.</p> <p>3. For AC Power Conducted Emission items: AC Adapter/ Laptop. Only these modes as a representative test condition.</p>
Worst Case:	<p>1. Battery Worst Condition: AHB303038HPJT</p> <p>2. Unwanted Emission below 1GHz Worst mode: AC Adapter</p> <p>3. AC Power Conducted Emission Worst mode: Laptop</p> <p>4. Pre-Scan has been conducted to determine the worst-case mode from all possible combinations between available modulations, data rates and antenna ports (if EUT with antenna diversity architecture).</p>

Following channel(s) was (were) selected for the final test as listed below:

Test Item	Mode	Tested Channel	Modulation	Data Rate Parameter
AC Power Conducted Emissions	BT-LE 2M	38	GFSK	2Mb/s
	logi bolt 2M	38	GFSK	2Mb/s
Unwanted Emissions below 1 GHz	BT-LE 2M	38	GFSK	2Mb/s
	logi bolt 2M	38	GFSK	2Mb/s
Unwanted Emissions above 1 GHz	BT-LE 1M	0, 19, 39	GFSK	1Mb/s
	logi bolt 1M	0, 19, 39	GFSK	1Mb/s
	BT-LE 2M	1, 19, 38	GFSK	2Mb/s
	logi bolt 2M	1, 19, 38	GFSK	2Mb/s
RF Output Power / Power Spectral Density	BT-LE 1M	0, 19, 39	GFSK	1Mb/s
	BT-LE 2M	1, 19, 38	GFSK	2Mb/s
	logi bolt 1M	0, 19, 39	GFSK	1Mb/s
	logi bolt 2M	1, 19, 38	GFSK	2Mb/s
6 dB Bandwidth / Conducted Out of Band Emissions	BT-LE 1M	0, 19, 39	GFSK	1Mb/s
	BT-LE 2M	1, 19, 38	GFSK	2Mb/s
	logi bolt 1M	0, 19, 39	GFSK	1Mb/s
	logi bolt 2M	1, 19, 38	GFSK	2Mb/s

3.5 Duty Cycle of Test Signal

BT-LE 1M: Duty cycle = 0.354 ms / 7.04 ms x 100% = 5.0%, duty factor = 10 * log (1/Duty cycle) = 12.99 dB

BT-LE 2M: Duty cycle = 0.184 ms / 7.046 ms x 100% = 2.6%, duty factor = 10 * log (1/Duty cycle) = 15.83 dB

logi bolt 1M: Duty cycle = 0.356 ms / 7.05 ms x 100% = 5%, duty factor = 10 * log (1/Duty cycle) = 12.97 dB

logi bolt 2M: Duty cycle = 0.185 ms / 7.056 ms x 100% = 2.6%, duty factor = 10 * log (1/Duty cycle) = 15.81 dB

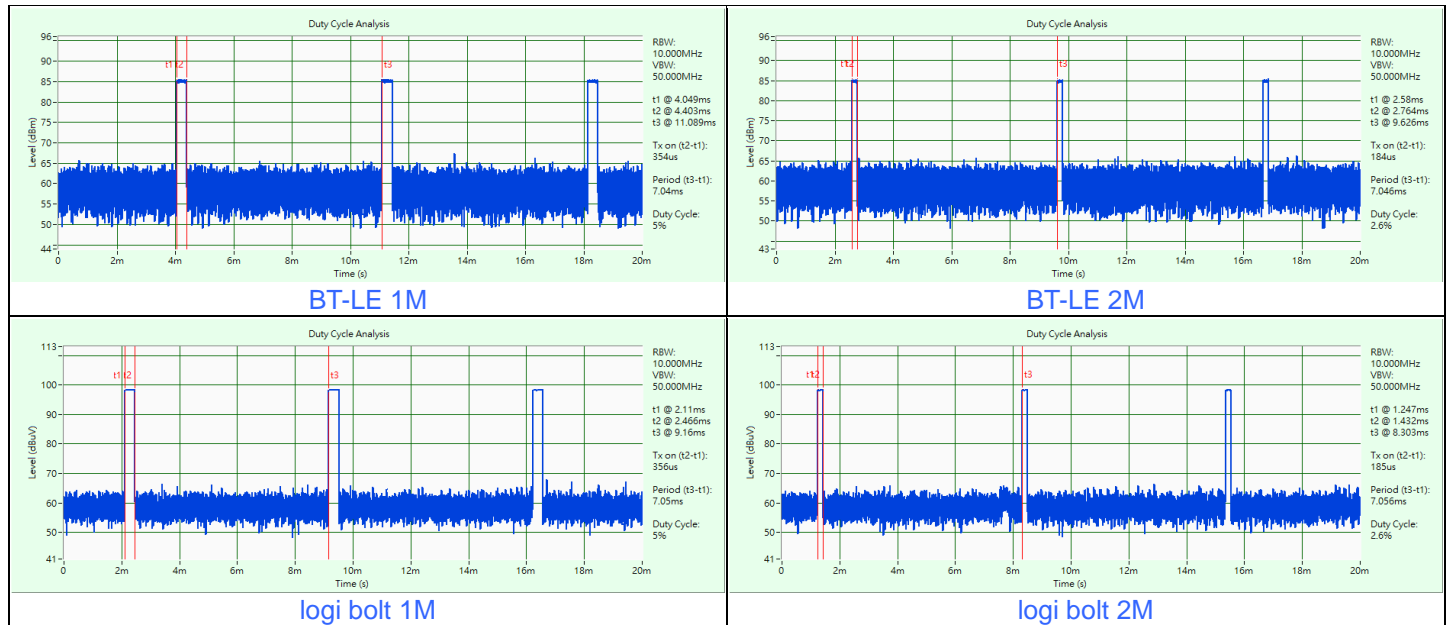

Note: This is the highest operational duty cycle of the device.

3.6 Test Program Used and Operation Descriptions

Controlling software (RF Sample with Receiver [Number Lock]) has been activated to set the EUT under transmission condition continuously at specific channel frequency.

Operation Description
◆ BLE1M TX Modulated on channel 2402MHz ◆ BLE1M TX Modulated on channel 2440MHz ◆ BLE1M TX Modulated on channel 2480MHz ◆ BLE2M TX Modulated on channel 2404MHz ◆ BLE2M TX Modulated on channel 2440MHz ◆ BLE2M TX Modulated on channel 2478MHz

3.7 Connection Diagram of EUT and Peripheral Devices

For AC Power Conducted Emission test

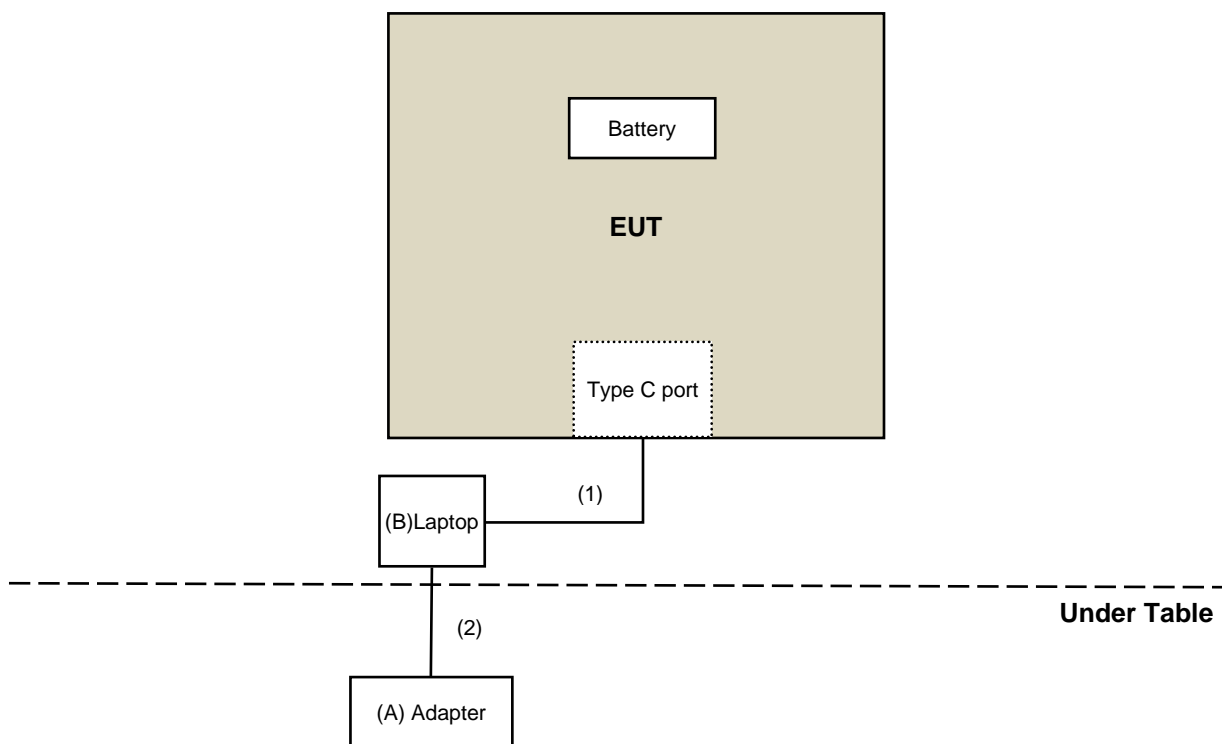

For Unwanted Emission test

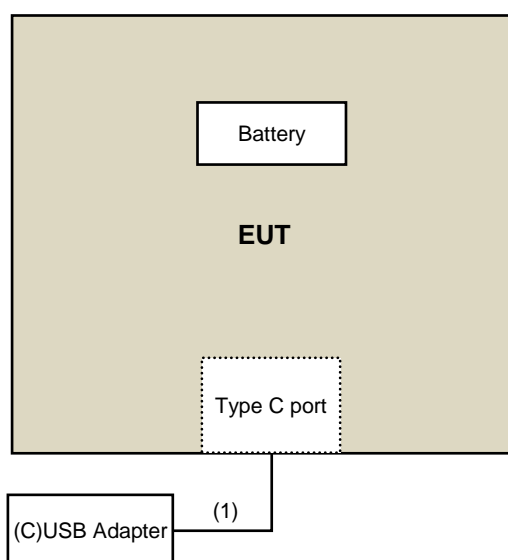

3.8 Configuration of Peripheral Devices and Cable Connections

ID	Product	Brand	Model No.	Serial No.	FCC ID	Remarks
A	Adapter	Lenovo	PA-1450-55LL	N/A	N/A	Provided by Lab
B	Laptop	Lenovo	81A4	YD02YN9H	PD93165NGU	Provided by Lab
C	USB Adapter	Xiaomi	AD332	N/A	N/A	Provided by Lab

ID	Cable Descriptions	Qty.	Length (m)	Shielding (Yes/No)	Cores (Qty.)	Remarks
1	Type C cable	1	1	Yes	0	Supplied by applicant
2	DC Cable	1	1.95	No	0	Provided by Lab

4 Test Instruments

The calibration interval of the all test instruments are 12 months and the calibrations are traceable to NML/ROC and NIST/USA.

4.1 RF Output Power

Description Manufacturer	Model No.	Serial No.	Calibrated Date	Calibrated Until
Attenuator WOKEN	MDCS18N-10	MDCS18N-10-01	2022/4/5	2023/4/4
Power Meter Anritsu	ML2495A	1529002	2022/6/22	2023/6/21
Pulse Power Sensor Anritsu	MA2411B	1726434	2022/6/22	2023/6/21
Software	ADT_RF Test Software V6.6.5.4	N/A	N/A	N/A
Spectrum Analyzer R&S	FSV40	101516	2022/3/7	2023/3/6

Notes:

1. The test was performed in Oven room 2.
2. Tested Date: 2022/7/7

4.2 Power Spectral Density

Description Manufacturer	Model No.	Serial No.	Calibrated Date	Calibrated Until
Attenuator WOKEN	MDCS18N-10	MDCS18N-10-01	2022/4/5	2023/4/4
Software	ADT_RF Test Software V6.6.5.4	N/A	N/A	N/A
Spectrum Analyzer R&S	FSV40	101516	2022/3/7	2023/3/6

Notes:

1. The test was performed in Oven room 2.
2. Tested Date: 2022/7/7

4.3 6 dB Bandwidth

Refer to section 4.2 to get information of the instruments.

4.4 Conducted Out of Band Emissions

Refer to section 4.2 to get information of the instruments.

4.5 AC Power Conducted Emissions

Description Manufacturer	Model No.	Serial No.	Calibrated Date	Calibrated Until
50 ohms Terminator	50	3	2021/10/27	2022/10/26
Fixed attenuator STI	STI02-2200-10	005	2021/8/27	2022/8/26
LISN R&S	ESH3-Z5	848773/004	2021/10/29	2022/10/28
RF Coaxial Cable JYEBO	5D-FB	COCCAB-001	2021/9/25	2022/9/24
Software BVADT	BVADT_Cond_V7.3.7.4	N/A	N/A	N/A
TEST RECEIVER R&S	ESCS 30	847124/029	2021/10/13	2022/10/12

Notes:

1. The test was performed in Conduction 1
2. Tested Date: 2022/7/13

4.6 Unwanted Emissions below 1 GHz

Description Manufacturer	Model No.	Serial No.	Calibrated Date	Calibrated Until
Bilog Antenna Schwarzbeck	VULB 9168	9168-0842	2021/10/26	2022/10/25
Boresight Antenna Tower & Turn Table Max-Full	MF-7802BS	MF780208530	N/A	N/A
Fixed attenuator Mini-Circuits	UNAT-5+	PAD-ATT5-02	2022/1/10	2023/1/9
LOOP ANTENNA Electro-Metrics	EM-6879	264	2022/3/18	2023/3/17
Pre_Amplifier Agilent	8447D	2944A10636	2022/3/19	2023/3/18
Pre_Amplifier EMCI	EMC330N	980538	2022/4/25	2023/4/24
RF Coaxial Cable JYEBO	5D-FB	LOOPCAB-001	2022/1/6	2023/1/5
		LOOPCAB-002	2022/1/6	2023/1/5
RF Coaxial Cable COMMATE/PEWC	8D	966-5-1	2022/4/25	2023/4/24
		966-5-2	2022/4/25	2023/4/24
		966-5-3	2022/4/25	2023/4/24
Software	ADT_Radiated_V8.7.08	N/A	N/A	N/A
Spectrum Analyzer Keysight	N9020B	MY60112410	2022/3/13	2023/3/12
Test Receiver R&S	ESR3	102528	2022/2/25	2023/2/24

Notes:

1. The test was performed in 966 Chamber No. 5.
2. Tested Date: 2022/7/12

4.7 Unwanted Emissions above 1 GHz

Description Manufacturer	Model No.	Serial No.	Calibrated Date	Calibrated Until
Boresight Antenna Tower & Turn Table Max-Full	MF-7802BS	MF780208530	N/A	N/A
Horn Antenna Schwarzbeck	BBHA 9120D	9120D-1819	2021/11/14	2022/11/13
	BBHA 9170	9170-739	2021/11/14	2022/11/13
Pre_Amplifier EMCI	EMC12630SE	980509	2022/4/25	2023/4/24
	EMC184045SE	980387	2022/1/10	2023/1/9
RF Cable-Frequency range: 1- 40GHz EMCI	EMC102-KM-KM-1200	160924	2022/1/10	2023/1/9
RF Coaxial Cable EMCI	EMC104-SM-SM-1500	180503	2022/4/25	2023/4/24
	EMC104-SM-SM-2000	180501	2022/4/25	2023/4/24
	EMC104-SM-SM-6000	180506	2022/4/25	2023/4/24
	EMC-KM-KM-4000	200214	2022/3/8	2023/3/7
Software	ADT_Radiated_V8.7.08	N/A	N/A	N/A
Spectrum Analyzer Keysight	N9020B	MY60112410	2022/3/13	2023/3/12
Test Receiver R&S	ESR3	102528	2022/2/25	2023/2/24

Notes:

1. The test was performed in 966 Chamber No. 5.
2. Tested Date: 2022/7/10 ~ 2022/7/13

5 Limits of Test Items

5.1 RF Output Power

For systems using digital modulation in the 2400–2483.5 MHz bands: 1 Watt (30 dBm)

5.2 Power Spectral Density

The Maximum of Power Spectral Density Measurement is 8 dBm in any 3 kHz.

5.3 6 dB Bandwidth

The minimum of 6 dB Bandwidth Measurement is 0.5 MHz.

5.4 Conducted Out of Band Emissions

Below 20 dB of the highest emission level of operating band (in 100 kHz Resolution Bandwidth).

5.5 AC Power Conducted Emissions

Frequency (MHz)	Conducted Limit (dBuV)	
	Quasi-peak	Average
0.15 - 0.5	66 - 56	56 - 46
0.50 - 5.0	56	46
5.0 - 30.0	60	50

Notes:

1. The lower limit shall apply at the transition frequencies.
2. The limit decreases in line with the logarithm of the frequency in the range of 0.15 to 0.50 MHz.

5.6 Unwanted Emissions below 1 GHz

Radiated emissions up to 1 GHz which fall in the restricted bands must comply with the radiated emission limits specified as below table. Other emissions shall be at least 20 dB below the highest level of the desired power:

Frequencies (MHz)	Field Strength (microvolts/meter)	Measurement Distance (meters)
0.009 ~ 0.490	2400/F(kHz)	300
0.490 ~ 1.705	24000/F(kHz)	30
1.705 ~ 30.0	30	30
30 ~ 88	100	3
88 ~ 216	150	3
216 ~ 960	200	3
Above 960	500	3

Notes:

1. The lower limit shall apply at the transition frequencies.
2. Emission level (dBuV/m) = 20 log Emission level (uV/m).

5.7 Unwanted Emissions above 1 GHz

Radiated emissions above 1 GHz which fall in the restricted bands must comply with the radiated emission limits specified as below table. Other emissions shall be at least 20 dB below the highest level of the desired power:

Frequencies (MHz)	Field Strength (microvolts/meter)	Measurement Distance (meters)
Above 960	500	3

Notes:

1. The lower limit shall apply at the transition frequencies.
2. Emission level (dBuV/m) = 20 log Emission level (uV/m).
3. For frequencies above 1000 MHz, the field strength limits are based on average detector, however, the peak field strength of any emission shall not exceed the maximum permitted average limits, specified above by more than 20 dB under any condition of modulation.

6 Test Arrangements

6.1 RF Output Power

6.1.1 Test Setup

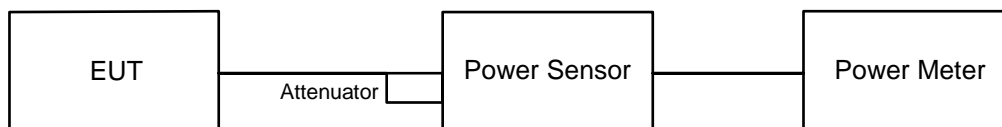

6.1.2 Test Procedure

Peak Power:

A peak power sensor was used on the output port of the EUT. A power meter was used to read the response of the peak power sensor. Record the power level.

Average Power:

Average power sensor was used to perform output power measurement, trigger and gating function of wide band power meter is enabled to measure max output power of TX on burst. Duty factor is not added to measured value.

6.2 Power Spectral Density

6.2.1 Test Setup

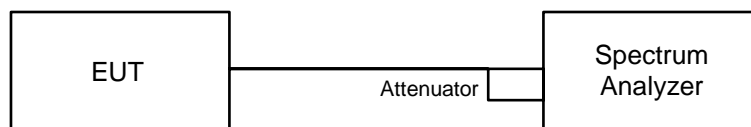

6.2.2 Test Procedure

- a. Set analyzer center frequency to DTS channel center frequency.
- b. Set the span to 1.5 times the DTS bandwidth.
- c. Set the RBW to: 3 kHz.
- d. Set the VBW $\geq 3 \times$ RBW.
- e. Detector = peak.
- f. Sweep time = auto couple.
- g. Trace mode = max hold.
- h. Allow trace to fully stabilize.
- i. Use the peak marker function to determine the maximum amplitude level within the RBW.

6.3 6 dB Bandwidth

6.3.1 Test Setup

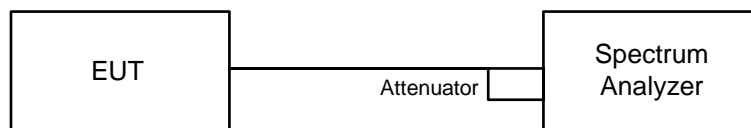

6.3.2 Test Procedure

- Set resolution bandwidth (RBW) = 100 kHz.
- Set the video bandwidth (VBW) $\geq 3 \times$ RBW, Detector = Peak.
- Trace mode = max hold.
- Sweep = auto couple.
- Measure the maximum width of the emission that is constrained by the frequencies associated with the two amplitude points (upper and lower) that are attenuated by 6 dB relative to the maximum level measured in the fundamental emission.

6.4 Conducted Out of Band Emissions

6.4.1 Test Setup

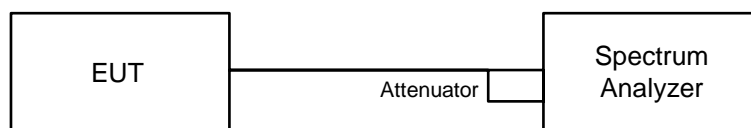

6.4.2 Test Procedure

MEASUREMENT PROCEDURE REF

- Set the RBW = 100 kHz.
- Set the VBW ≥ 300 kHz.
- Detector = peak.
- Sweep time = auto couple.
- Trace mode = max hold.
- Allow trace to fully stabilize.
- Use the peak marker function to determine the maximum power level in any 100 kHz band segment within the fundamental EBW.

MEASUREMENT PROCEDURE OOBE

- Set RBW = 100 kHz.
- Set VBW ≥ 300 kHz.
- Detector = peak.
- Sweep = auto couple.
- Trace Mode = max hold.
- Allow trace to fully stabilize.
- Use the peak marker function to determine the maximum amplitude level.

6.5 AC Power Conducted Emissions

6.5.1 Test Setup

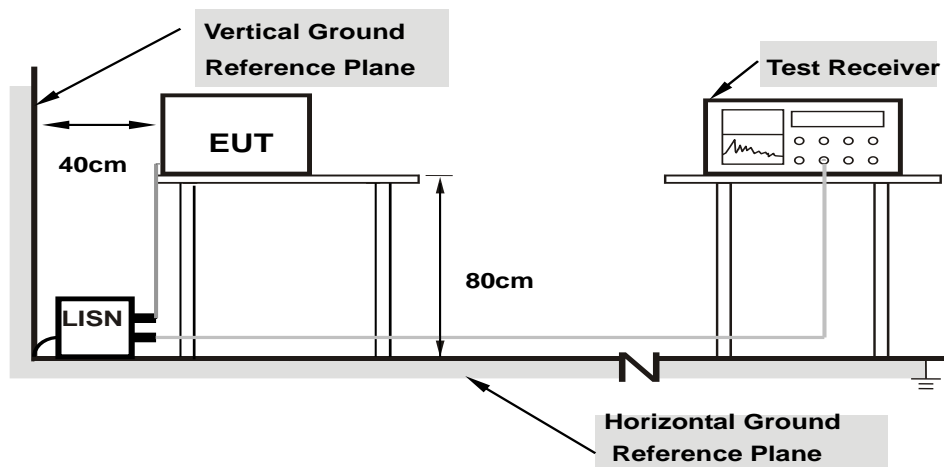

Note: 1.Support units were connected to second LISN.

For the actual test configuration, please refer to the attached file (Test Setup Photo).

6.5.2 Test Procedure

- The EUT was placed on a 0.8 meter to the top of table and placed 0.4 meters from the conducting wall of the shielded room with EUT being connected to the power mains through a line impedance stabilization network (LISN). Other support units were connected to the power mains through another LISN. The two LISNs provide 50 ohm/ 50 uH of coupling impedance for the measuring instrument.
- Both lines of the power mains connected to the EUT were checked for maximum conducted interference.
- The frequency range from 150 kHz to 30 MHz was searched. Emission levels under (Limit – 20 dB) was not recorded.

Note: The resolution bandwidth and video bandwidth of test receiver is 9 kHz for quasi-peak detection (QP) and average detection (AV) at frequency 0.15 MHz-30 MHz.

6.6 Unwanted Emissions below 1 GHz

6.6.1 Test Setup

For Radiated emission below 30 MHz

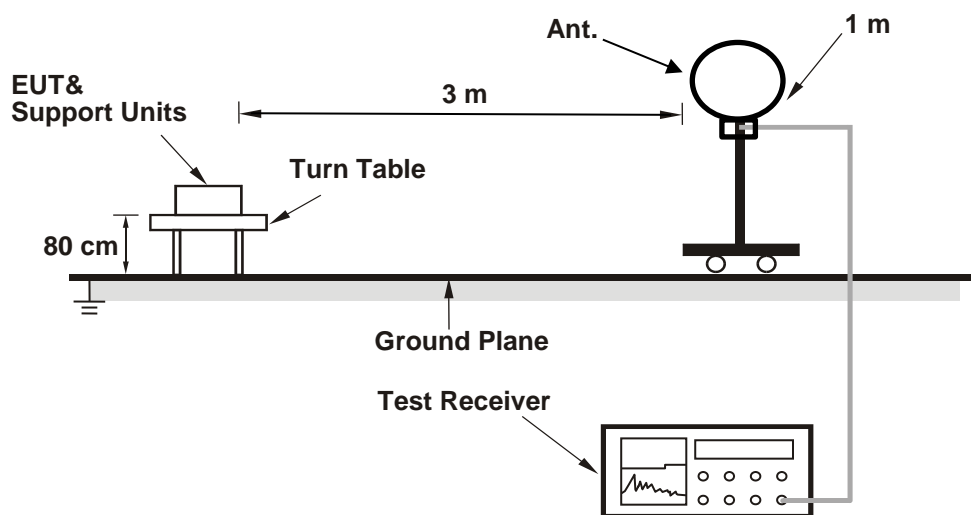

For Radiated emission above 30 MHz

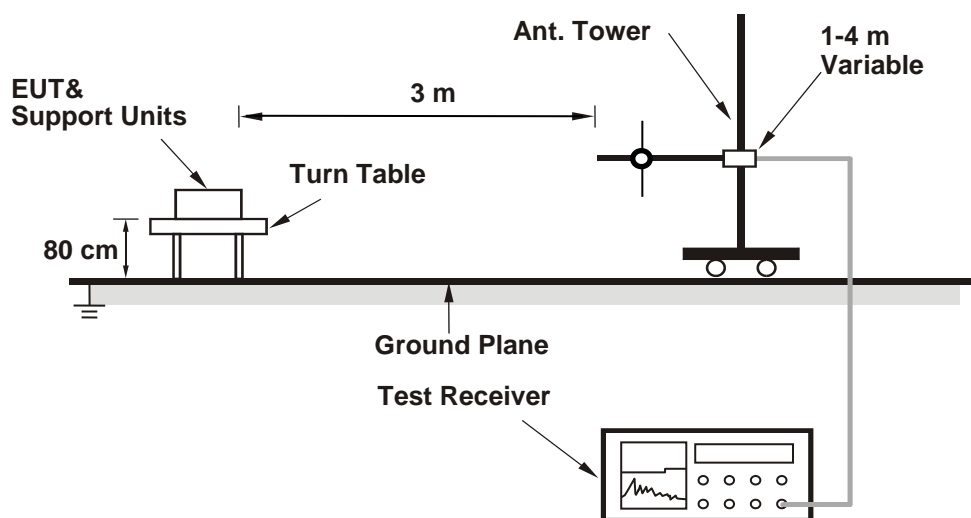

6.6.2 Test Procedure

For Radiated emission below 30 MHz

- a. The EUT was placed on the top of a rotating table 0.8 meters above the ground at 3 meter chamber room for test. The table was rotated 360 degrees to determine the position of the highest radiation.
- b. The EUT was set 3 meters away from the interference-receiving antenna, which was mounted on the top of a variable-height antenna tower.
- c. Parallel, perpendicular, and ground-parallel orientations of the antenna are set to make the measurement.
- d. For each suspected emission, the EUT was arranged to its worst case and the rotatable table was turned from 0 degrees to 360 degrees to find the maximum reading.
- e. The test-receiver system was set to Quasi-Peak Detect Function and Specified Bandwidth with Maximum Hold Mode, except for the frequency band (9 kHz to 90 kHz and 110 kHz to 490 kHz) set to average detect function and peak detect function.

Notes:

1. The resolution bandwidth and video bandwidth of test receiver/spectrum analyzer is 200 Hz at frequency below 150 kHz.
2. The resolution bandwidth and video bandwidth of test receiver/spectrum analyzer is 9 kHz or 10 kHz at frequency (150 kHz to 30 MHz).
3. All modes of operation were investigated and the worst-case emissions are reported.

For Radiated emission above 30 MHz

- a. The EUT was placed on the top of a rotating table 0.8 meters above the ground at 3 meter chamber room for test. The table was rotated 360 degrees to determine the position of the highest radiation.
- b. The EUT was set 3 meters away from the interference-receiving antenna, which was mounted on the top of a variable-height antenna tower.
- c. The height of antenna is varied from one meter to four meters above the ground to determine the maximum value of the field strength. Both horizontal and vertical polarizations of the antenna are set to make the measurement.
- d. For each suspected emission, the EUT was arranged to its worst case and then the antenna was tuned to heights from 1 meter to 4 meters and the rotatable table was turned from 0 degrees to 360 degrees to find the maximum reading.
- e. The test-receiver system was set to quasi-peak detect function and specified bandwidth with maximum hold mode when the test frequency is below 1 GHz.

Notes:

1. The resolution bandwidth and video bandwidth of test receiver/spectrum analyzer is 120 kHz for Quasi-peak detection (QP) at frequency below 1 GHz.
2. All modes of operation were investigated and the worst-case emissions are reported.

6.7 Unwanted Emissions above 1 GHz

6.7.1 Test Setup

For Radiated emission above 1 GHz

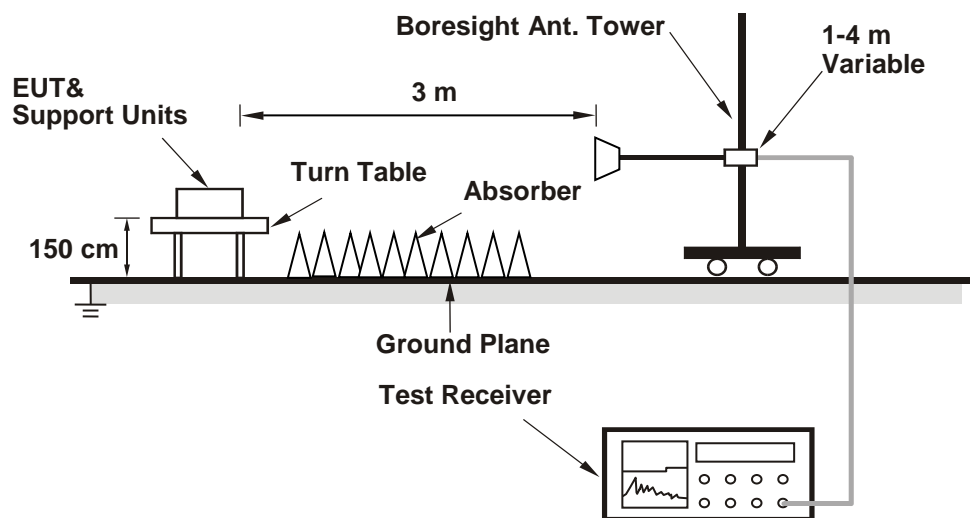

For the actual test configuration, please refer to the attached file (Test Setup Photo).

6.7.2 Test Procedure

- The EUT was placed on the top of a rotating table 1.5 meters above the ground at 3 meter chamber room for test. The table was rotated 360 degrees to determine the position of the highest radiation.
- The EUT was set 3 meters away from the interference-receiving antenna, which was mounted on the top of a variable-height antenna tower.
- The height of antenna is varied from one meter to four meters above the ground to determine the maximum value of the field strength. Both horizontal and vertical polarizations of the antenna are set to make the measurement.
- For each suspected emission, the EUT was arranged to its worst case and then the antenna was tuned to heights from 1 meter to 4 meters and the rotatable table was turned from 0 degrees to 360 degrees to find the maximum reading.
- The test-receiver system was set to peak and average detects function and specified bandwidth with maximum hold mode when the test frequency is above 1 GHz. If the peak reading value also meets average limit, measurement with the average detector is unnecessary.

Notes:

- The resolution bandwidth of test receiver/spectrum analyzer is 1 MHz and the video bandwidth is 3 MHz for Peak detection (PK) and Average detection (AV) at frequency above 1 GHz.
- According to ANSI C63.10 section 6.6.4 and 4.1.4.2.2. For fundamental and harmonic signal measurement, according to ANSI C63.10 section 7.5, the average value = peak value + duty cycle correction factor. For duty cycle correction factor values, see the Test Signal Duty Cycle section in this report.
- All modes of operation were investigated and the worst-case emissions are reported.

7 Test Results of Test Item

7.1 RF Output Power

Input Power:	3.8 Vdc	Environmental Conditions:	25°C, 76% RH	Tested By:	Waydi Tuan
--------------	---------	---------------------------	--------------	------------	------------

For Peak Power

BT-LE 1M

Chan.	Chan. Freq. (MHz)	Peak Power (mW)	Peak Power (dBm)	Power Limit (dBm)	Test Result
0	2402	4.477	6.51	30	Pass
19	2440	4.56	6.59	30	Pass
39	2480	4.624	6.65	30	Pass

Note: The antenna gain is 1 dBi < 6 dBi, so the output power limit shall not be reduced.

BT-LE 2M

Chan.	Chan. Freq. (MHz)	Peak Power (mW)	Peak Power (dBm)	Power Limit (dBm)	Test Result
1	2404	4.477	6.51	30	Pass
19	2440	4.581	6.61	30	Pass
38	2478	4.634	6.66	30	Pass

Note: The antenna gain is 1 dBi < 6 dBi, so the output power limit shall not be reduced.

logi bolt 1M

Chan.	Chan. Freq. (MHz)	Peak Power (mW)	Peak Power (dBm)	Power Limit (dBm)	Test Result
0	2402	4.467	6.50	30	Pass
19	2440	4.56	6.59	30	Pass
39	2480	4.613	6.64	30	Pass

Note: The antenna gain is 1 dBi < 6 dBi, so the output power limit shall not be reduced.

logi bolt 2M

Chan.	Chan. Freq. (MHz)	Peak Power (mW)	Peak Power (dBm)	Power Limit (dBm)	Test Result
1	2404	4.467	6.50	30	Pass
19	2440	4.571	6.60	30	Pass
38	2478	4.624	6.65	30	Pass

Note: The antenna gain is 1 dBi < 6 dBi, so the output power limit shall not be reduced.

For Average Power

BT-LE 1M

Chan.	Chan. Freq. (MHz)	Average Power (mW)	Average Power (dBm)
0	2402	4.395	6.43
19	2440	4.487	6.52
39	2480	4.539	6.57

BT-LE 2M

Chan.	Chan. Freq. (MHz)	Average Power (mW)	Average Power (dBm)
1	2404	4.406	6.44
19	2440	4.498	6.53
38	2478	4.55	6.58

logi bolt 1M

Chan.	Chan. Freq. (MHz)	Average Power (mW)	Average Power (dBm)
0	2402	4.385	6.42
19	2440	4.477	6.51
39	2480	4.529	6.56

logi bolt 2M

Chan.	Chan. Freq. (MHz)	Average Power (mW)	Average Power (dBm)
1	2404	4.395	6.43
19	2440	4.498	6.53
38	2478	4.539	6.57

7.2 Power Spectral Density

Input Power:	3.8 Vdc	Environmental Conditions:	25°C, 76% RH	Tested By:	Waydi Tuan
--------------	---------	---------------------------	--------------	------------	------------

BT-LE 1M

Chan.	Chan. Freq. (MHz)	PSD (dBm/3kHz)	PSD Limit (dBm/3kHz)	Test Result
0	2402	3.86	8.00	Pass
19	2440	3.92	8.00	Pass
39	2480	3.88	8.00	Pass

Note: The antenna gain is 1 dBi < 6 dBi, so the power density limit shall not be reduced.

BT-LE 2M

Chan.	Chan. Freq. (MHz)	PSD (dBm/3kHz)	PSD Limit (dBm/3kHz)	Test Result
1	2404	-0.67	8.00	Pass
19	2440	-0.26	8.00	Pass
38	2478	-0.53	8.00	Pass

Note: The antenna gain is 1 dBi < 6 dBi, so the power density limit shall not be reduced.

Spectrum Plot of Maximum Value

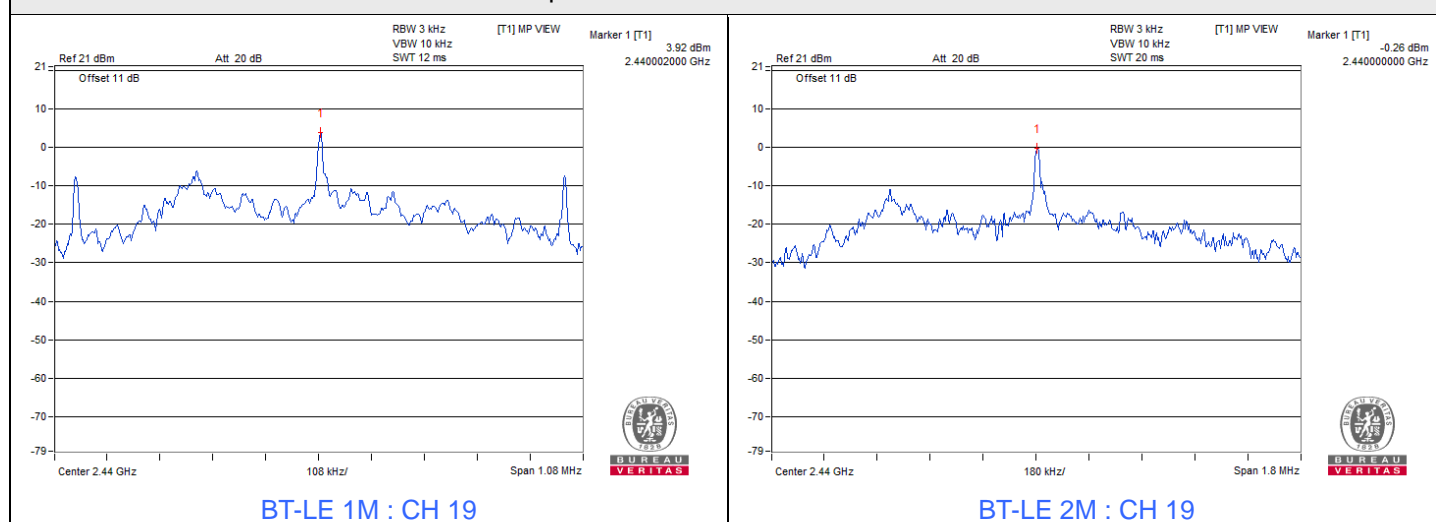



logi bolt 1M

Chan.	Chan. Freq. (MHz)	PSD (dBm/3kHz)	PSD Limit (dBm/3kHz)	Test Result
0	2402	3.76	8.00	Pass
19	2440	4.04	8.00	Pass
39	2480	3.87	8.00	Pass

Note: The antenna gain is 1 dBi < 6 dBi, so the power density limit shall not be reduced.

logi bolt 2M

Chan.	Chan. Freq. (MHz)	PSD (dBm/3kHz)	PSD Limit (dBm/3kHz)	Test Result
1	2404	-0.78	8.00	Pass
19	2440	-0.44	8.00	Pass
38	2478	-0.47	8.00	Pass

Note: The antenna gain is 1 dBi < 6 dBi, so the power density limit shall not be reduced.

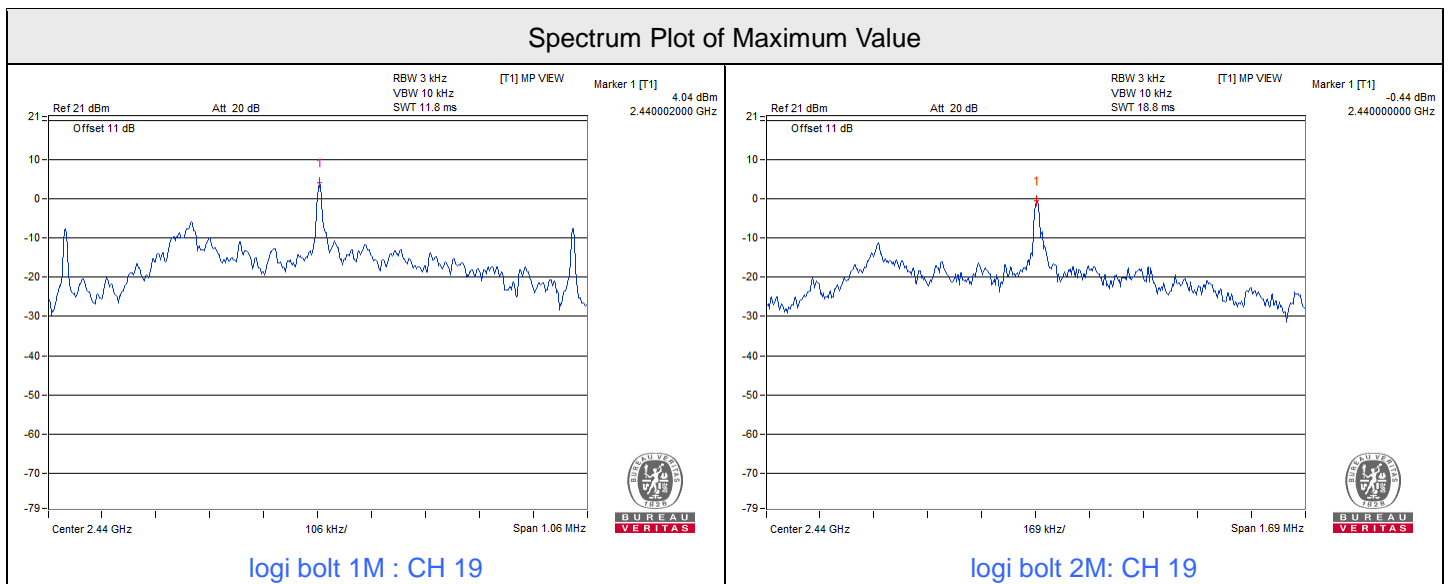

7.3 6 dB Bandwidth

Input Power:	3.8 Vdc	Environmental Conditions:	25°C, 76% RH	Tested By:	Waydi Tuan
--------------	---------	---------------------------	--------------	------------	------------

BT-LE 1M

Channel	Frequency (MHz)	6dB Bandwidth (MHz)	Minimum Limit (MHz)	Test Result
0	2402	0.7	0.5	Pass
19	2440	0.72	0.5	Pass
39	2480	0.72	0.5	Pass

BT-LE 2M

Channel	Frequency (MHz)	6dB Bandwidth (MHz)	Minimum Limit (MHz)	Test Result
1	2404	1.14	0.5	Pass
19	2440	1.2	0.5	Pass
38	2478	1.18	0.5	Pass

Spectrum Plot of Minimum Value

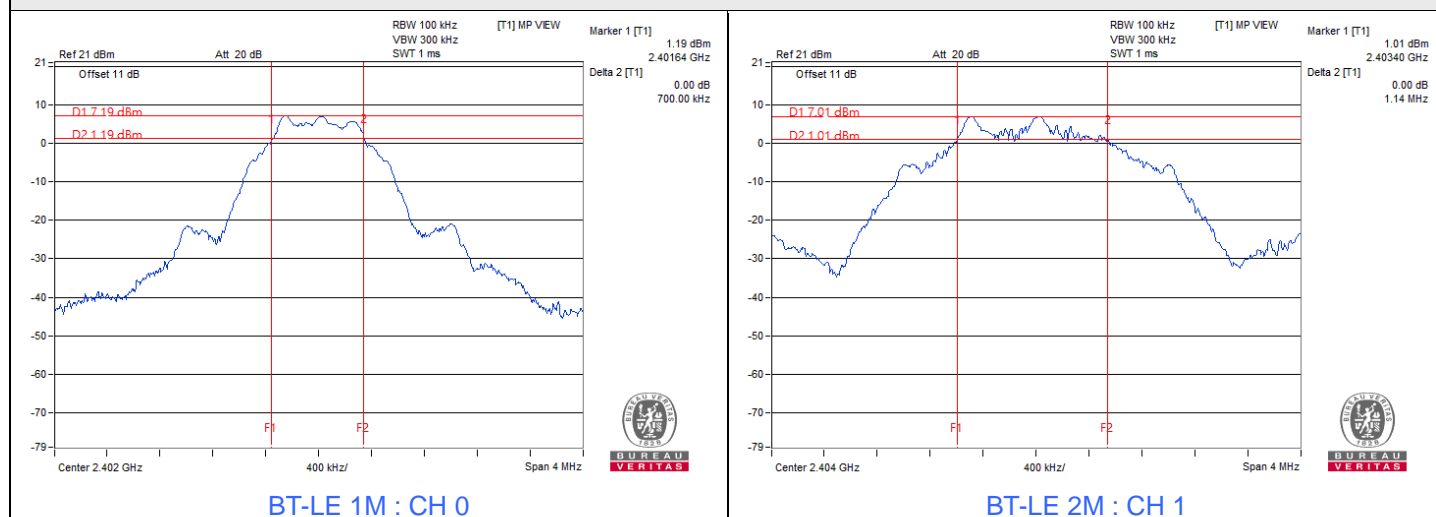



logi bolt 1M

Channel	Frequency (MHz)	6dB Bandwidth (MHz)	Minimum Limit (MHz)	Test Result
0	2402	0.7	0.5	Pass
19	2440	0.71	0.5	Pass
39	2480	0.7	0.5	Pass

logi bolt 2M

Channel	Frequency (MHz)	6dB Bandwidth (MHz)	Minimum Limit (MHz)	Test Result
1	2404	1.17	0.5	Pass
19	2440	1.13	0.5	Pass
38	2478	1.15	0.5	Pass

Spectrum Plot of Minimum Value

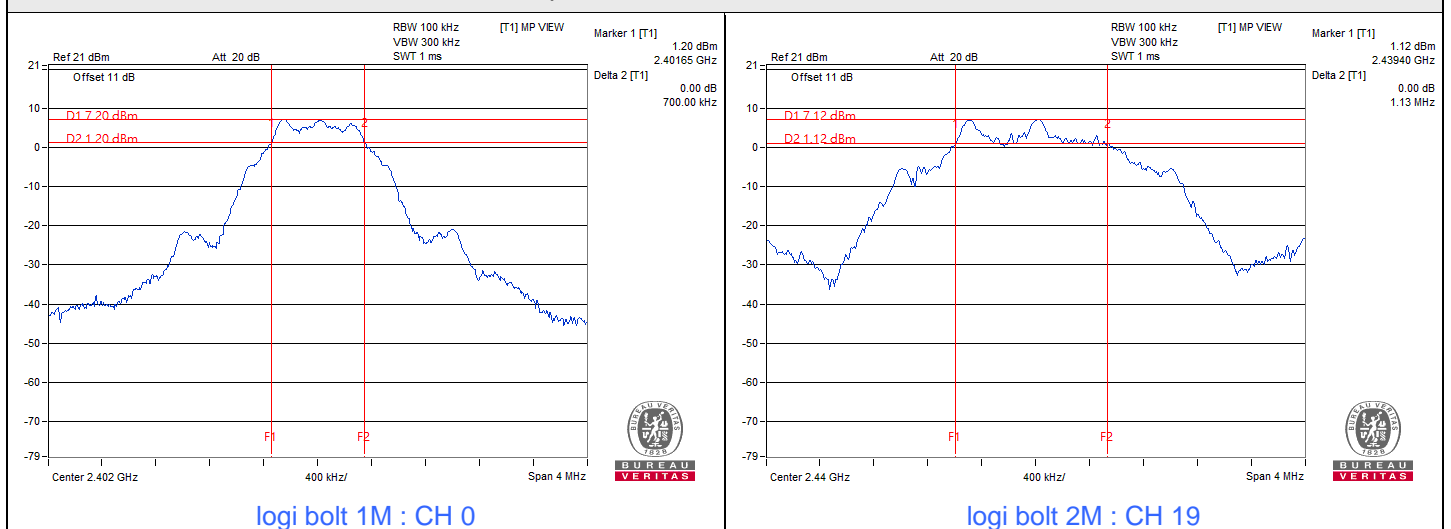



7.4 Conducted Out of Band Emissions

Input Power:	3.8 Vdc	Environmental Conditions:	25°C, 76% RH	Tested By:	Waydi Tuan
--------------	---------	---------------------------	--------------	------------	------------

BT-L1 1M

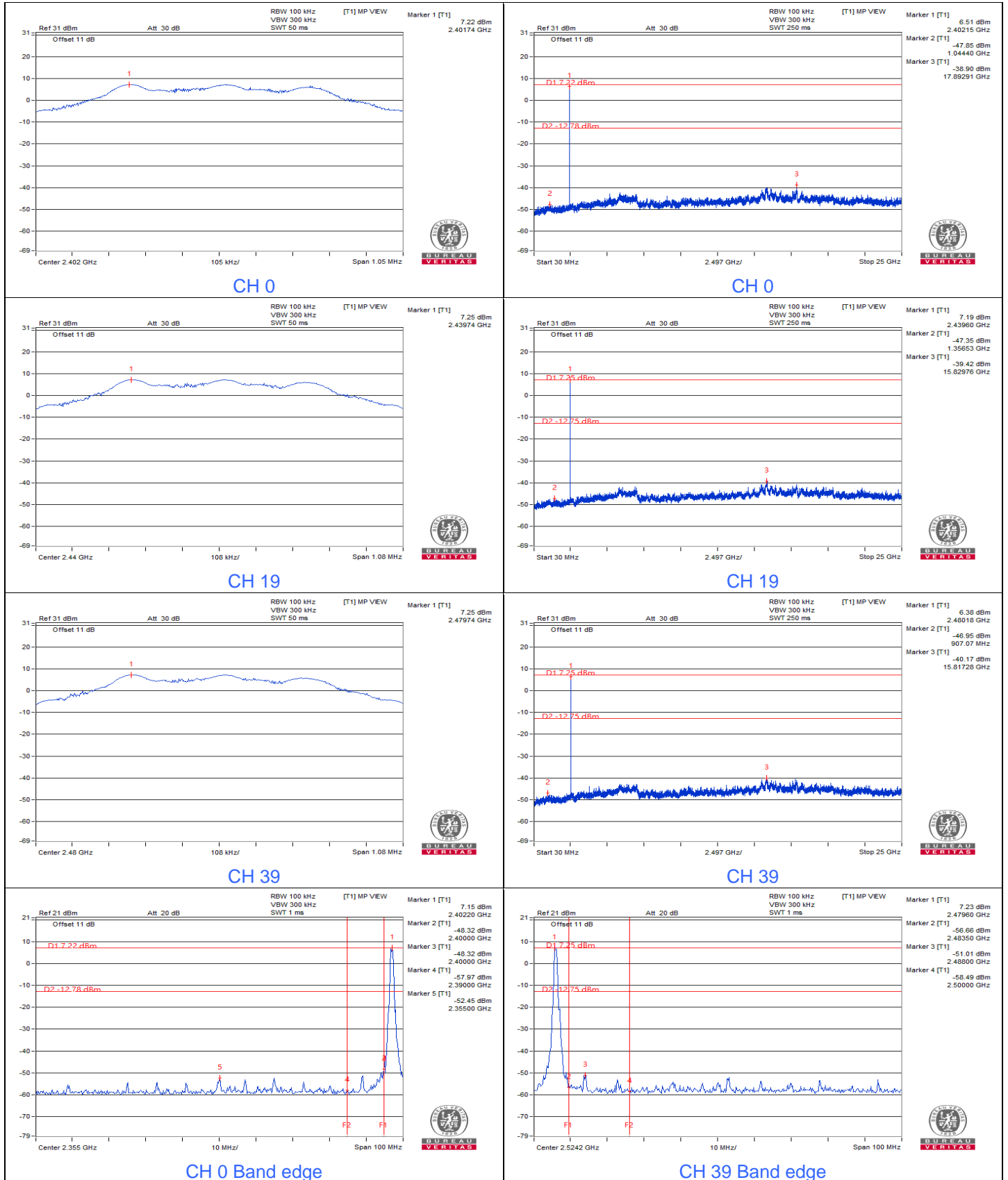



BT-LE 2M

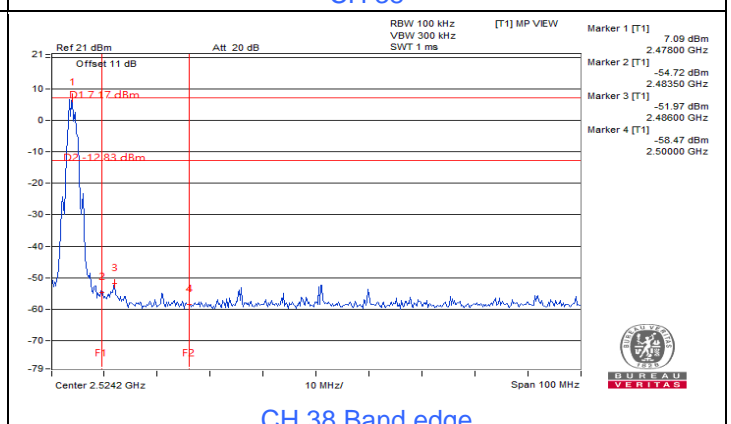
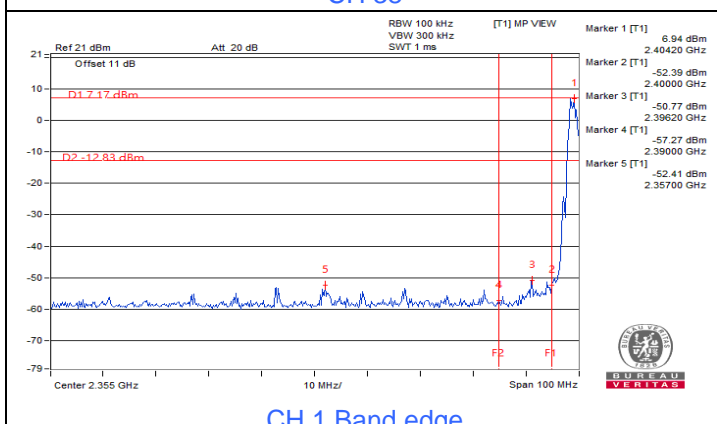
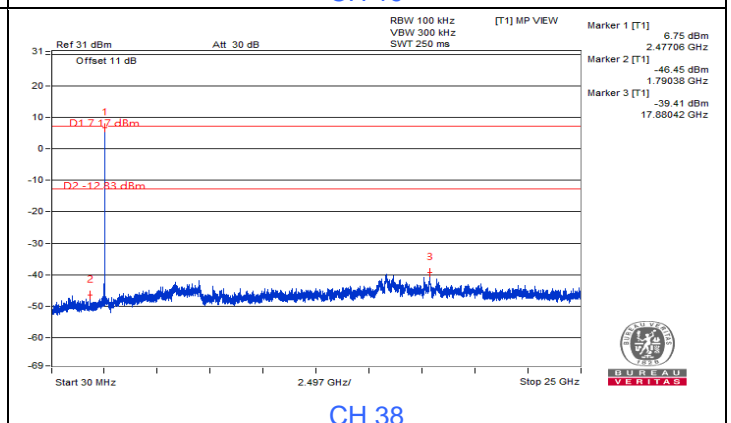
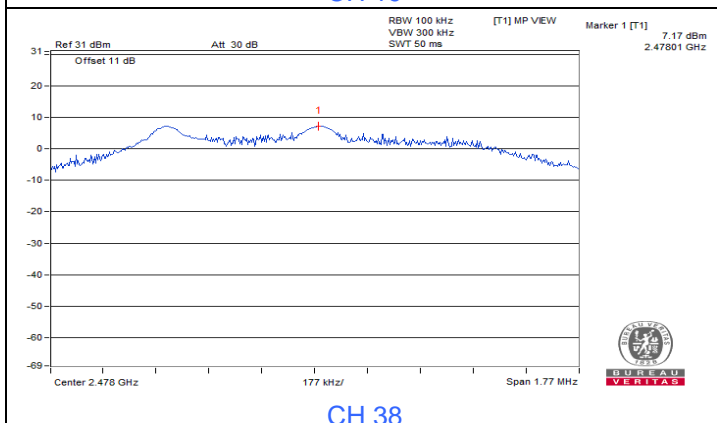
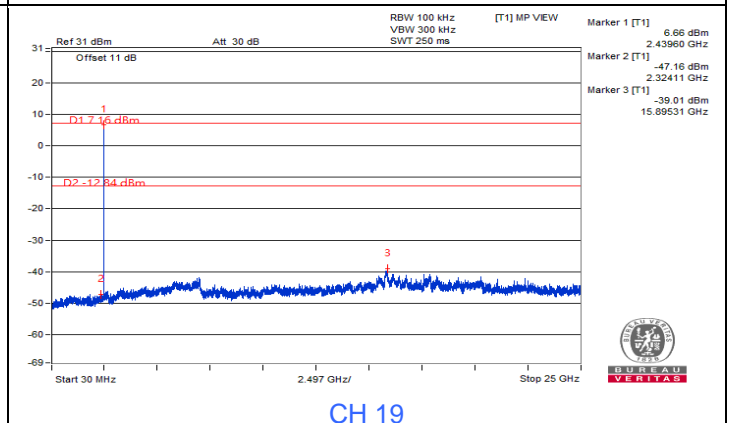
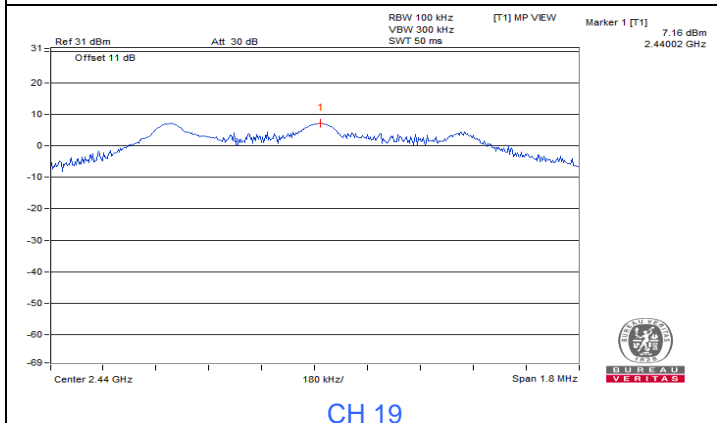
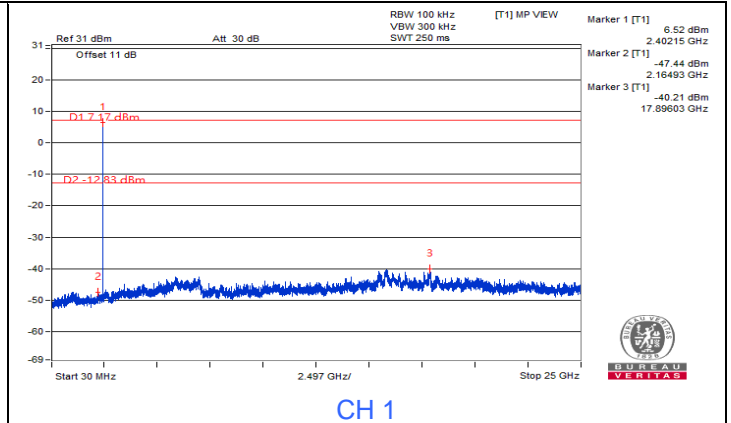
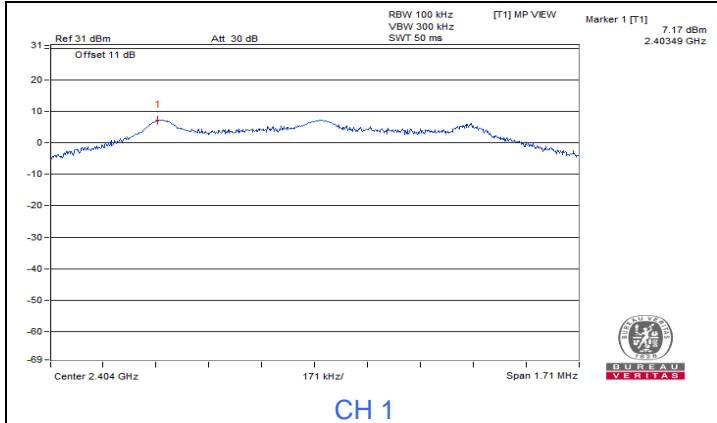



BUREAU VERITAS

logi bolt 1M

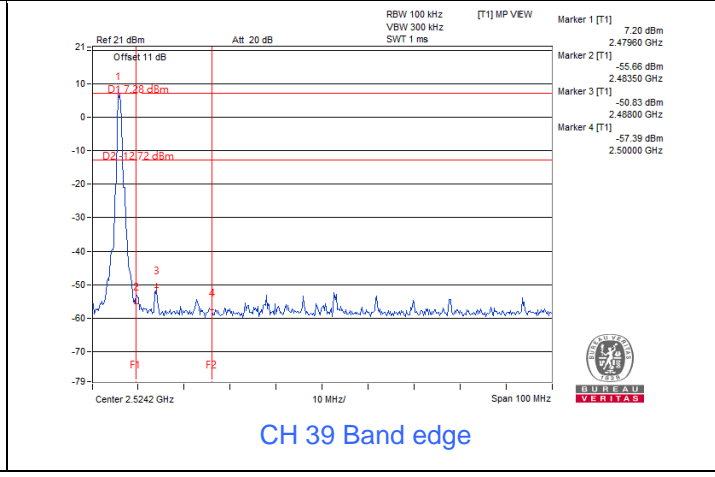
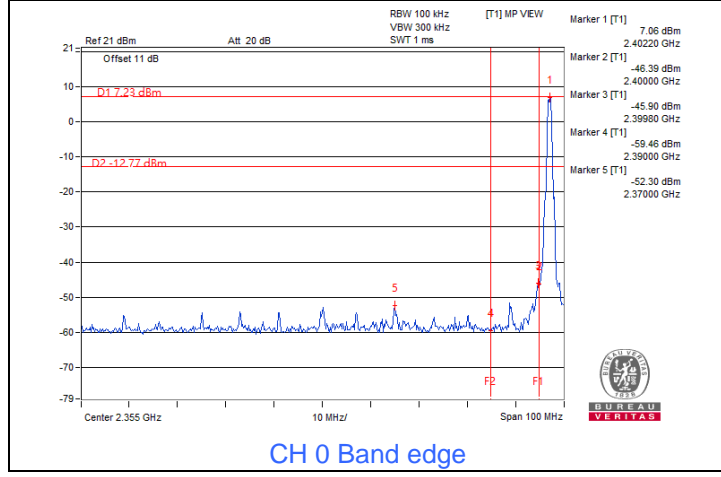
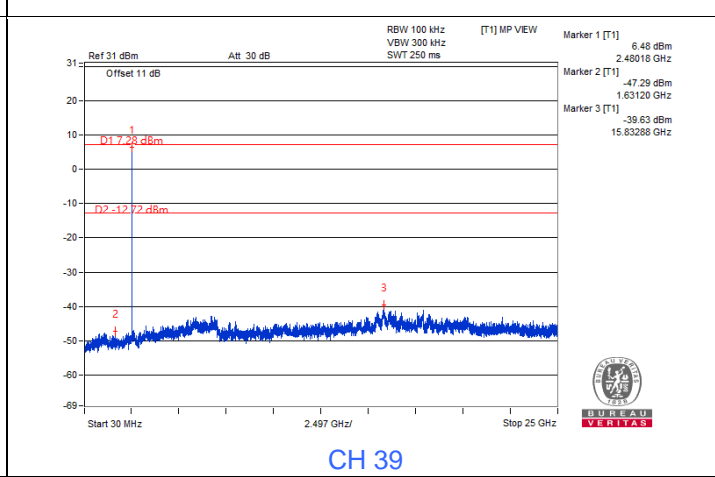
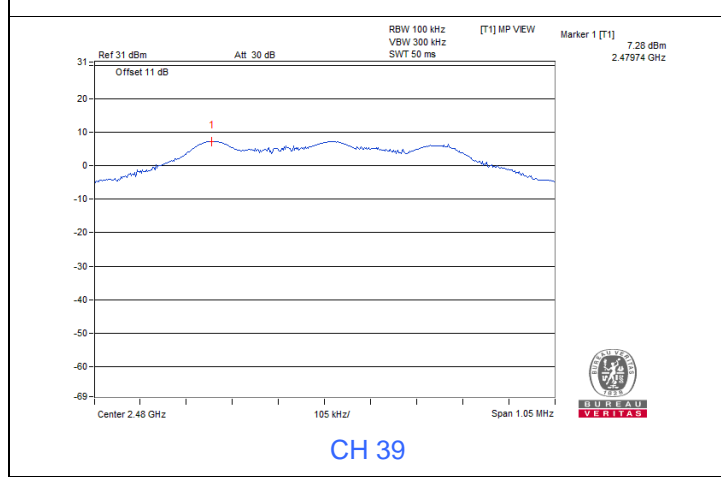
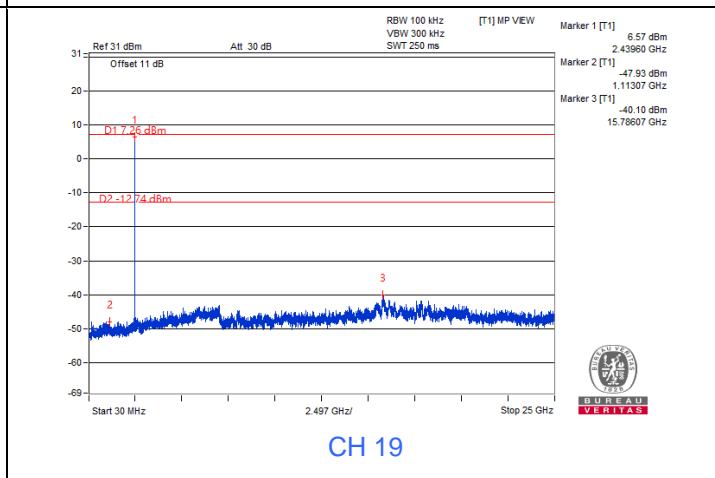
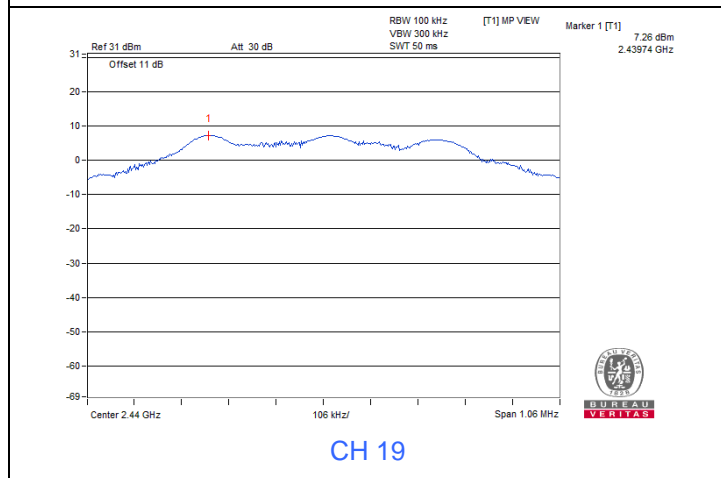
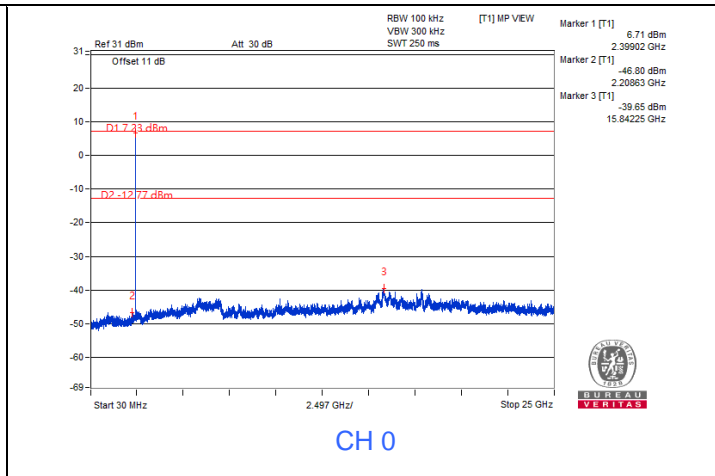
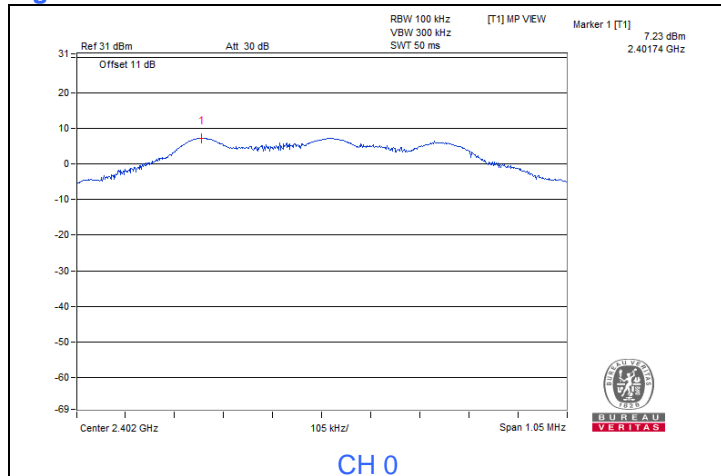

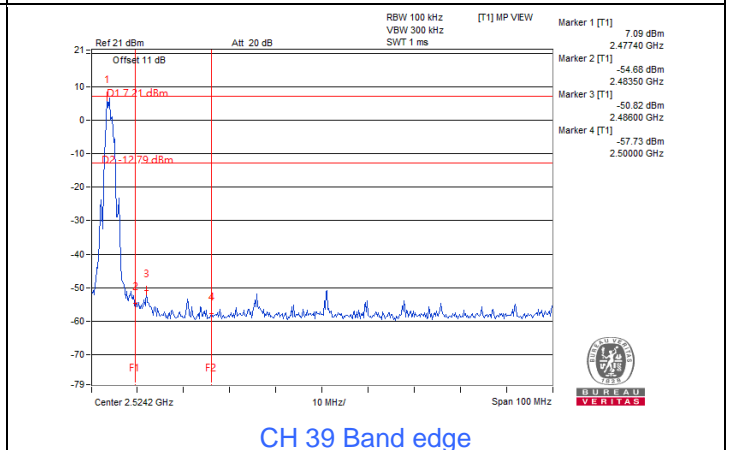
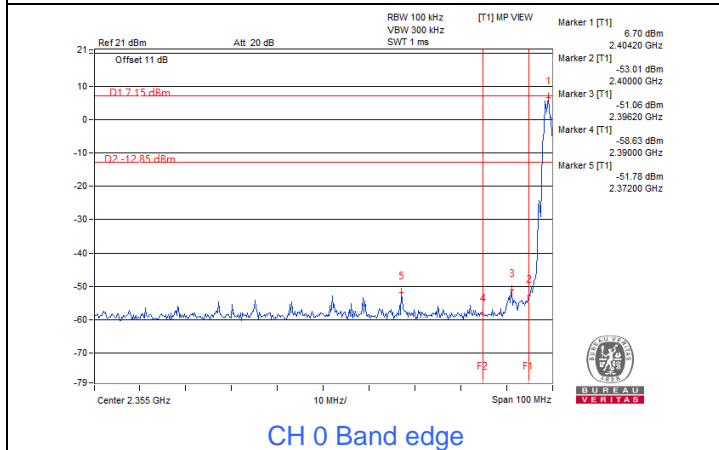
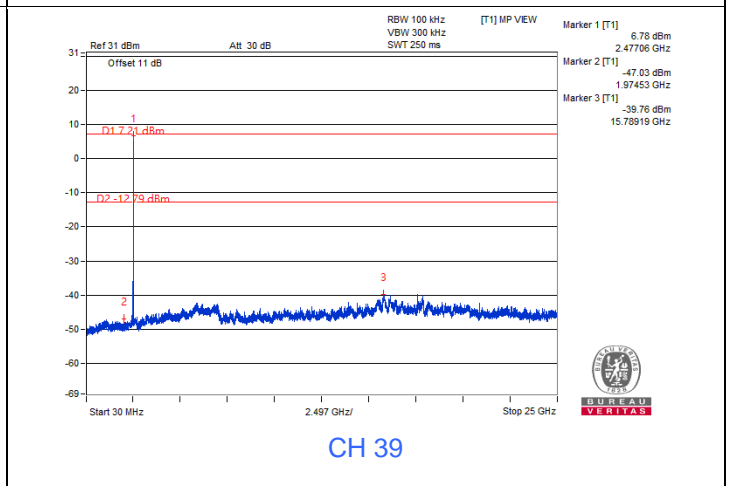
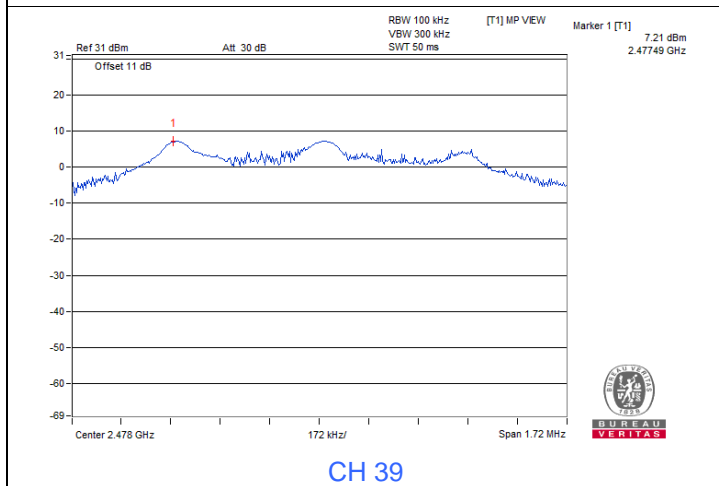
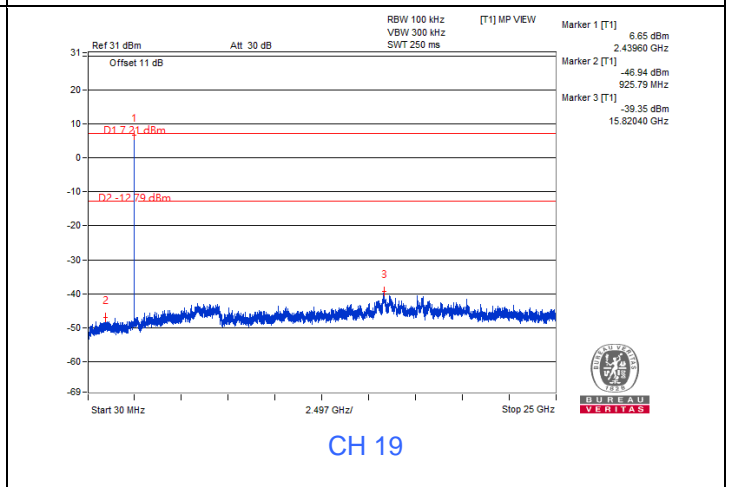
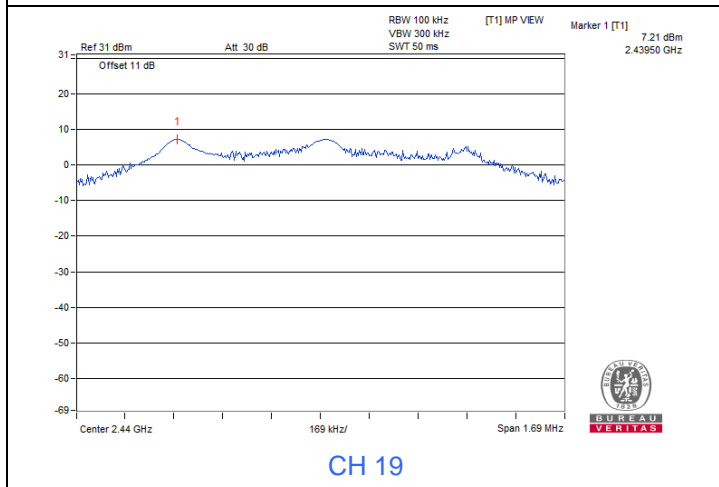
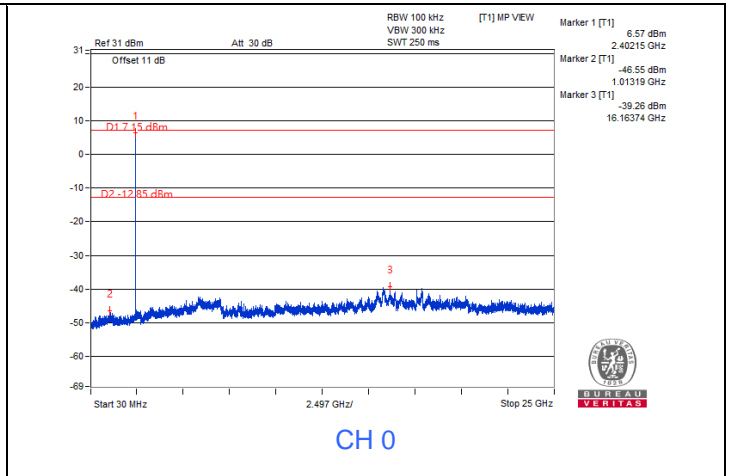
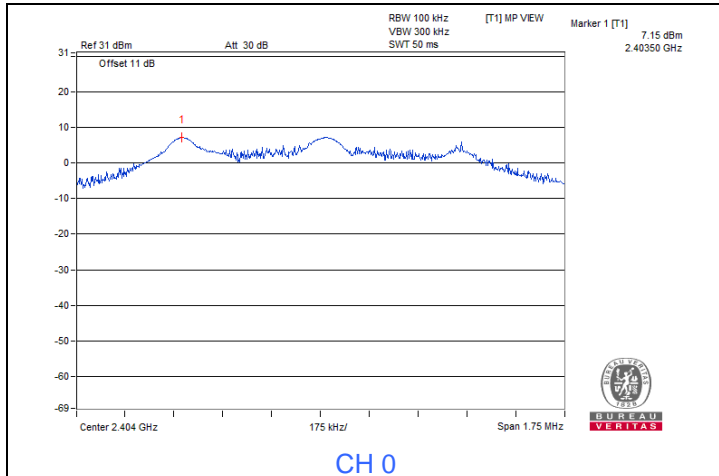

7.5 AC Power Conducted Emissions

RF Mode	TX BT-LE 2M	Channel	CH 38 : 2478 MHz
Frequency Range	150 kHz ~ 30 MHz	Detector Function & Resolution Bandwidth	Quasi-Peak (QP) / Average (AV), 9 kHz
Input Power (System)	120Vac, 60Hz	Environmental Conditions	27°C, 66% RH
Tested By	Sampson Chen		

Phase Of Power : Line (L)										
No	Frequency (MHz)	Correction Factor (dB)	Reading Value (dBuV)		Emission Level (dBuV)		Limit (dBuV)		Margin (dB)	
			Q.P.	AV.	Q.P.	AV.	Q.P.	AV.	Q.P.	AV.
1	0.20078	10.05	35.95	20.17	46.00	30.22	63.58	53.58	-17.58	-23.36
2	0.24375	10.05	35.78	22.81	45.83	32.86	61.97	51.97	-16.14	-19.11
3	0.48203	10.06	28.73	17.12	38.79	27.18	56.30	46.30	-17.51	-19.12
4	2.74219	10.23	29.18	17.45	39.41	27.68	56.00	46.00	-16.59	-18.32
5	4.51563	10.35	27.61	17.03	37.96	27.38	56.00	46.00	-18.04	-18.62
6	7.45703	10.55	26.73	17.74	37.28	28.29	60.00	50.00	-22.72	-21.71

Remarks:

1. Q.P. and AV. are abbreviations of quasi-peak and average individually.
2. The emission levels of other frequencies were very low against the limit.
3. Margin value = Emission level – Limit value
4. Correction factor = Insertion loss + Cable loss
5. Emission Level = Correction Factor + Reading Value

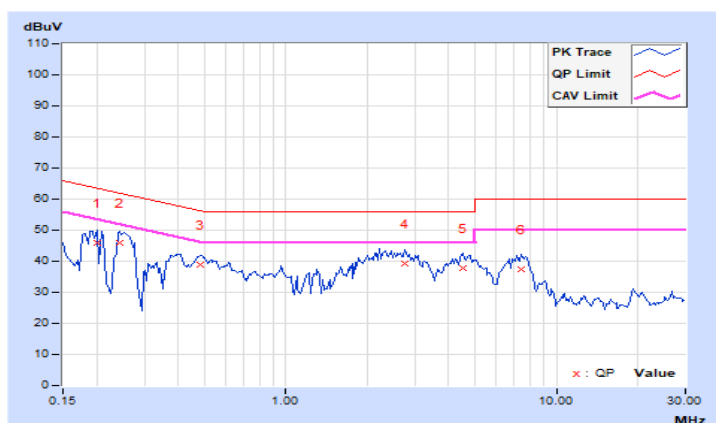

RF Mode	TX BT-LE 2M	Channel	CH 38 : 2478 MHz
Frequency Range	150 kHz ~ 30 MHz	Detector Function & Resolution Bandwidth	Quasi-Peak (QP) / Average (AV), 9 kHz
Input Power (System)	120Vac, 60Hz	Environmental Conditions	27°C, 66% RH
Tested By	Sampson Chen		

Phase Of Power : Neutral (N)										
No	Frequency (MHz)	Correction Factor (dB)	Reading Value (dBuV)		Emission Level (dBuV)		Limit (dBuV)		Margin (dB)	
			Q.P.	AV.	Q.P.	AV.	Q.P.	AV.	Q.P.	AV.
1	0.19687	10.05	35.60	24.59	45.65	34.64	63.74	53.74	-18.09	-19.10
2	0.25156	10.05	34.37	22.83	44.42	32.88	61.71	51.71	-17.29	-18.83
3	0.48594	10.06	31.58	18.36	41.64	28.42	56.24	46.24	-14.60	-17.82
4	0.61875	10.08	30.41	18.22	40.49	28.30	56.00	46.00	-15.51	-17.70
5	2.58203	10.20	29.45	16.42	39.65	26.62	56.00	46.00	-16.35	-19.38
6	19.39453	11.07	25.64	19.42	36.71	30.49	60.00	50.00	-23.29	-19.51

Remarks:

1. Q.P. and AV. are abbreviations of quasi-peak and average individually.
2. The emission levels of other frequencies were very low against the limit.
3. Margin value = Emission level – Limit value
4. Correction factor = Insertion loss + Cable loss
5. Emission Level = Correction Factor + Reading Value

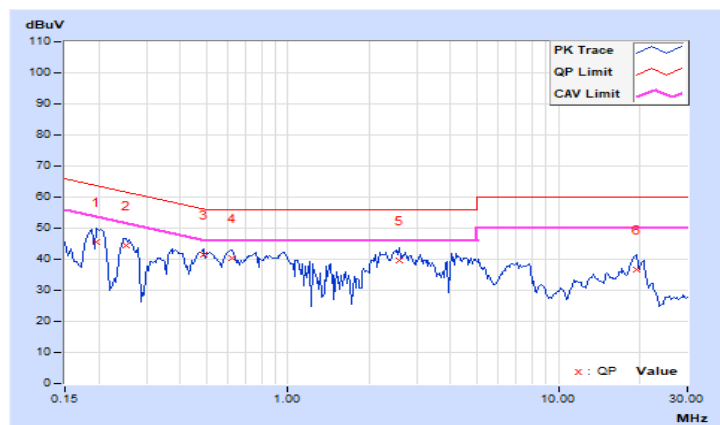

RF Mode	TX logi bolt 2M	Channel	CH 38 : 2478 MHz
Frequency Range	150 kHz ~ 30 MHz	Detector Function & Resolution Bandwidth	Quasi-Peak (QP) / Average (AV), 9 kHz
Input Power (System)	120Vac, 60Hz	Environmental Conditions	27°C, 66% RH
Tested By	Sampson Chen		

Phase Of Power : Line (L)										
No	Frequency (MHz)	Correction Factor (dB)	Reading Value (dBuV)		Emission Level (dBuV)		Limit (dBuV)		Margin (dB)	
			Q.P.	AV.	Q.P.	AV.	Q.P.	AV.	Q.P.	AV.
1	0.19297	10.05	35.73	21.53	45.78	31.58	63.91	53.91	-18.13	-22.33
2	0.23984	10.05	35.72	21.57	45.77	31.62	62.10	52.10	-16.33	-20.48
3	0.40781	10.06	29.22	14.93	39.28	24.99	57.69	47.69	-18.41	-22.70
4	2.47266	10.21	29.68	17.92	39.89	28.13	56.00	46.00	-16.11	-17.87
5	4.62891	10.35	27.41	17.03	37.76	27.38	56.00	46.00	-18.24	-18.62
6	7.35156	10.54	26.21	17.40	36.75	27.94	60.00	50.00	-23.25	-22.06

Remarks:

1. Q.P. and AV. are abbreviations of quasi-peak and average individually.
2. The emission levels of other frequencies were very low against the limit.
3. Margin value = Emission level – Limit value
4. Correction factor = Insertion loss + Cable loss
5. Emission Level = Correction Factor + Reading Value

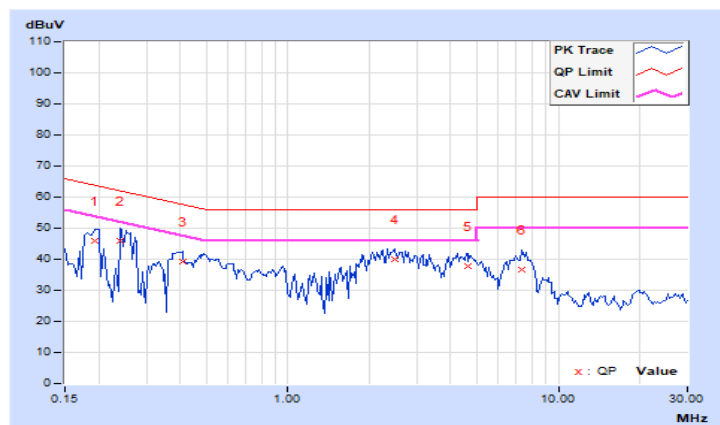

RF Mode	TX logi bolt 2M	Channel	CH 38 : 2478 MHz
Frequency Range	150 kHz ~ 30 MHz	Detector Function & Resolution Bandwidth	Quasi-Peak (QP) / Average (AV), 9 kHz
Input Power (System)	120Vac, 60Hz	Environmental Conditions	27°C, 66% RH
Tested By	Sampson Chen		

Phase Of Power : Neutral (N)										
No	Frequency (MHz)	Correction Factor (dB)	Reading Value (dBuV)		Emission Level (dBuV)		Limit (dBuV)		Margin (dB)	
			Q.P.	AV.	Q.P.	AV.	Q.P.	AV.	Q.P.	AV.
1	0.19297	10.05	35.98	24.55	46.03	34.60	63.91	53.91	-17.88	-19.31
2	0.24375	10.05	34.23	17.82	44.28	27.87	61.97	51.97	-17.69	-24.10
3	0.47422	10.06	29.80	16.47	39.86	26.53	56.44	46.44	-16.58	-19.91
4	0.61484	10.08	30.47	19.13	40.55	29.21	56.00	46.00	-15.45	-16.79
5	2.54297	10.20	29.31	16.58	39.51	26.78	56.00	46.00	-16.49	-19.22
6	19.14844	11.06	25.89	20.34	36.95	31.40	60.00	50.00	-23.05	-18.60

Remarks:

1. Q.P. and AV. are abbreviations of quasi-peak and average individually.
2. The emission levels of other frequencies were very low against the limit.
3. Margin value = Emission level – Limit value
4. Correction factor = Insertion loss + Cable loss
5. Emission Level = Correction Factor + Reading Value

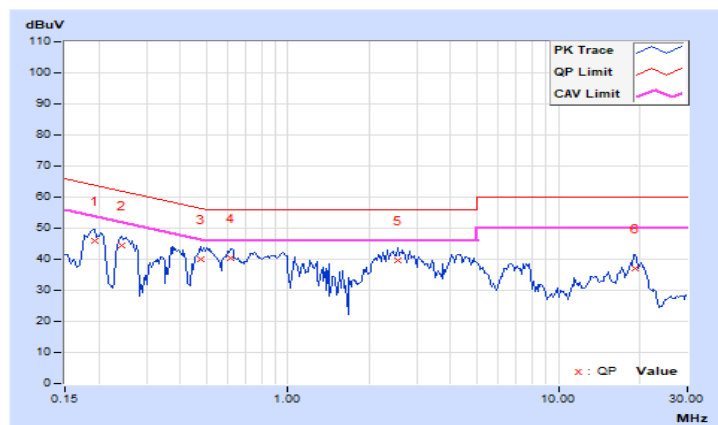

7.6 Unwanted Emissions below 1 GHz

RF Mode	TX BT-LE 2M	Channel	CH 38 : 2478 MHz
Frequency Range	9 kHz ~ 1 GHz	Detector Function & Bandwidth	(QP) RB = 120kHz
Input Power (System)	120Vac, 60Hz	Environmental Conditions	27°C, 73% RH
Tested By	Sampson Chen		

Antenna Polarity & Test Distance : Horizontal at 3 m

No	Frequency (MHz)	Emission Level (dBuV/m)	Limit (dBuV/m)	Margin (dB)	Antenna Height (m)	Table Angle (Degree)	Raw Value (dBuV)	Correction Factor (dB/m)
1	32.62	18.5 QP	40.0	-21.5	1.00 H	360	32.4	-13.9
2	75.06	19.5 QP	40.0	-20.5	3.00 H	297	35.6	-16.1
3	193.02	24.5 QP	43.5	-19.0	1.50 H	81	40.5	-16.0
4	217.12	20.5 QP	46.0	-25.5	1.00 H	70	36.4	-15.9
5	289.49	24.4 QP	46.0	-21.6	1.00 H	273	36.9	-12.5
6	736.73	28.4 QP	46.0	-17.6	3.00 H	360	31.6	-3.2

Remarks:

1. Emission Level(dBuV/m) = Raw Value(dBuV) + Correction Factor(dB/m)
2. Correction Factor(dB/m) = Antenna Factor(dB/m) + Cable Factor(dB) – Pre-Amplifier Factor(dB)
3. Margin value = Emission Level – Limit value
4. The other emission levels were very low against the limit of frequency range 30 MHz ~ 1 GHz.
5. The emission levels were very low against the limit of frequency range 9 kHz ~ 30 MHz: the amplitude of spurious emissions attenuated more than 20 dB below the permissible value to be report.

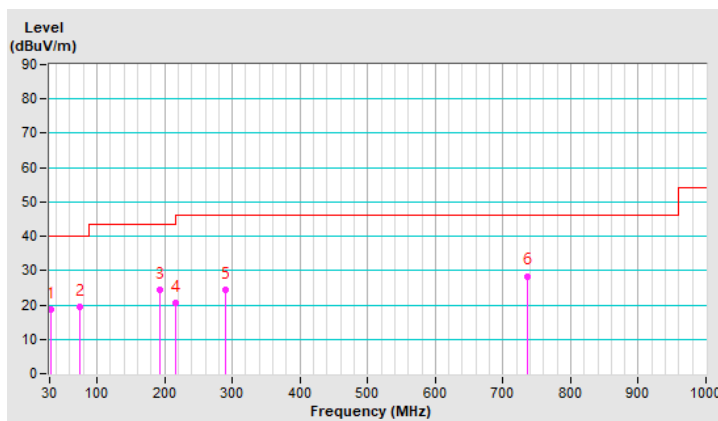

RF Mode	TX BT-LE 2M	Channel	CH 38 : 2478 MHz
Frequency Range	9 kHz ~ 1 GHz	Detector Function & Bandwidth	(QP) RB = 120kHz
Input Power (System)	120Vac, 60Hz	Environmental Conditions	27°C, 73% RH
Tested By	Sampson Chen		

Antenna Polarity & Test Distance : Vertical at 3 m								
No	Frequency (MHz)	Emission Level (dBuV/m)	Limit (dBuV/m)	Margin (dB)	Antenna Height (m)	Table Angle (Degree)	Raw Value (dBuV)	Correction Factor (dB/m)
1	40.86	22.4 QP	40.0	-17.6	1.00 V	333	35.4	-13.0
2	57.99	27.5 QP	40.0	-12.5	1.00 V	360	40.8	-13.3
3	84.42	19.6 QP	40.0	-20.4	1.00 V	115	37.9	-18.3
4	193.02	19.0 QP	43.5	-24.5	2.00 V	360	35.0	-16.0
5	289.54	20.8 QP	46.0	-25.2	1.50 V	360	33.3	-12.5
6	733.24	30.3 QP	46.0	-15.7	1.00 V	232	33.6	-3.3

Remarks:

1. Emission Level(dBuV/m) = Raw Value(dBuV) + Correction Factor(dB/m)
2. Correction Factor(dB/m) = Antenna Factor(dB/m) + Cable Factor(dB) – Pre-Amplifier Factor(dB)
3. Margin value = Emission Level – Limit value
4. The other emission levels were very low against the limit of frequency range 30 MHz ~ 1 GHz.
5. The emission levels were very low against the limit of frequency range 9 kHz ~ 30 MHz: the amplitude of spurious emissions attenuated more than 20 dB below the permissible value to be report.

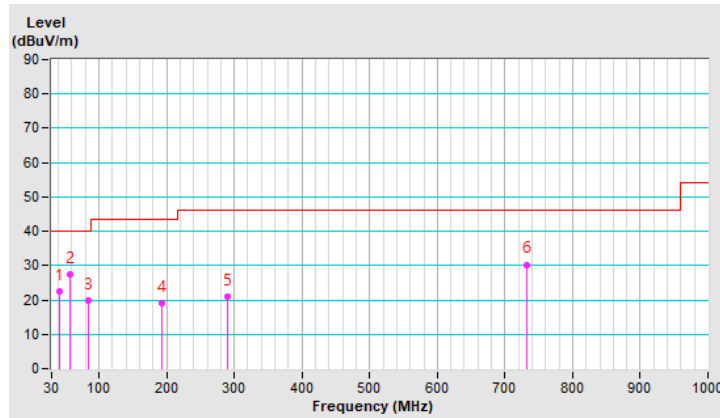

RF Mode	TX logi bolt 2M	Channel	CH 38 : 2478 MHz
Frequency Range	9 kHz ~ 1 GHz	Detector Function & Bandwidth	(QP) RB = 120kHz
Input Power (System)	120Vac, 60Hz	Environmental Conditions	27°C, 73% RH
Tested By	Sampson Chen		

Antenna Polarity & Test Distance : Horizontal at 3 m								
No	Frequency (MHz)	Emission Level (dBuV/m)	Limit (dBuV/m)	Margin (dB)	Antenna Height (m)	Table Angle (Degree)	Raw Value (dBuV)	Correction Factor (dB/m)
1	53.23	17.0 QP	40.0	-23.0	3.00 H	171	29.8	-12.8
2	109.01	14.3 QP	43.5	-29.2	3.00 H	208	30.2	-15.9
3	181.23	22.8 QP	43.5	-20.7	1.50 H	64	37.4	-14.6
4	265.38	18.8 QP	46.0	-27.2	1.50 H	268	32.2	-13.4
5	331.30	19.5 QP	46.0	-26.5	1.50 H	360	30.8	-11.3
6	711.46	26.3 QP	46.0	-19.7	3.00 H	44	29.9	-3.6

Remarks:

1. Emission Level(dBuV/m) = Raw Value(dBuV) + Correction Factor(dB/m)
2. Correction Factor(dB/m) = Antenna Factor(dB/m) + Cable Factor(dB) – Pre-Amplifier Factor(dB)
3. Margin value = Emission Level – Limit value
4. The other emission levels were very low against the limit of frequency range 30 MHz ~ 1 GHz.
5. The emission levels were very low against the limit of frequency range 9 kHz ~ 30 MHz: the amplitude of spurious emissions attenuated more than 20 dB below the permissible value to be report.

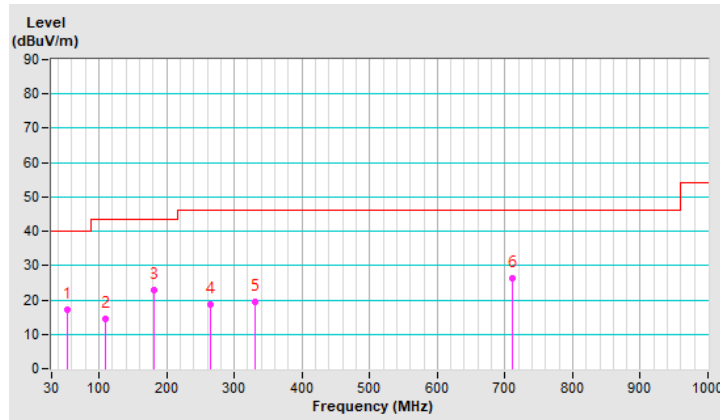

RF Mode	TX logi bolt 2M	Channel	CH 38 : 2478 MHz
Frequency Range	9 kHz ~ 1 GHz	Detector Function & Bandwidth	(QP) RB = 120kHz
Input Power (System)	120Vac, 60Hz	Environmental Conditions	27°C, 73% RH
Tested By	Sampson Chen		

Antenna Polarity & Test Distance : Vertical at 3 m								
No	Frequency (MHz)	Emission Level (dBuV/m)	Limit (dBuV/m)	Margin (dB)	Antenna Height (m)	Table Angle (Degree)	Raw Value (dBuV)	Correction Factor (dB/m)
1	57.99	27.5 QP	40.0	-12.5	1.00 V	360	40.8	-13.3
2	72.39	22.9 QP	40.0	-17.1	1.00 V	111	38.4	-15.5
3	108.53	14.4 QP	43.5	-29.1	3.00 V	17	30.4	-16.0
4	193.02	19.0 QP	43.5	-24.5	2.00 V	360	35.0	-16.0
5	417.58	21.4 QP	46.0	-24.6	1.50 V	48	30.7	-9.3
6	614.60	25.2 QP	46.0	-20.8	1.00 V	189	30.1	-4.9

Remarks:

1. Emission Level(dBuV/m) = Raw Value(dBuV) + Correction Factor(dB/m)
2. Correction Factor(dB/m) = Antenna Factor(dB/m) + Cable Factor(dB) – Pre-Amplifier Factor(dB)
3. Margin value = Emission Level – Limit value
4. The other emission levels were very low against the limit of frequency range 30 MHz ~ 1 GHz.
5. The emission levels were very low against the limit of frequency range 9 kHz ~ 30 MHz: the amplitude of spurious emissions attenuated more than 20 dB below the permissible value to be report.

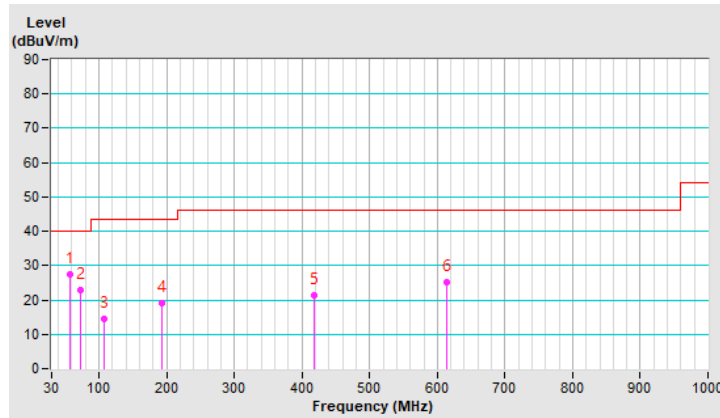

7.7 Unwanted Emissions above 1 GHz

RF Mode	TX BT-LE 1M	Channel	CH 0 : 2402 MHz
Frequency Range	1 GHz ~ 25 GHz	Detector Function & Bandwidth	(PK) RB = 1 MHz, VB = 3 MHz (AV) RB = 1 MHz, VB = 3 MHz
Input Power (System)	120Vac, 60Hz	Environmental Conditions	26°C, 73% RH
Tested By	Sampson Chen		

Antenna Polarity & Test Distance : Horizontal at 3 m								
No	Frequency (MHz)	Emission Level (dBuV/m)	Limit (dBuV/m)	Margin (dB)	Antenna Height (m)	Table Angle (Degree)	Raw Value (dBuV)	Correction Factor (dB/m)
1	2390.00	54.4 PK	74.0	-19.6	1.20 H	100	57.1	-2.7
2	2390.00	43.7 AV	54.0	-10.3	1.20 H	100	46.4	-2.7
3	*2402.00	103.7 PK			1.20 H	100	106.4	-2.7
4	*2402.00	77.7 AV			1.20 H	100	80.4	-2.7
5	4804.00	43.3 PK	74.0	-30.7	1.16 H	360	41.8	1.5
6	4804.00	17.3 AV	54.0	-36.7	1.16 H	360	15.8	1.5

Remarks:

- Emission Level(dBuV/m) = Raw Value(dBuV) + Correction Factor(dB/m)
- Correction Factor(dB/m) = Antenna Factor(dB/m) + Cable Factor(dB) – Pre-Amplifier Factor(dB)
- Margin value = Emission Level – Limit value
- The other emission levels were very low against the limit.
- " * " : Fundamental frequency, the limit was restricted at the RF Output Power.
- The average value of fundamental and harmonic frequency is: Average = Peak value + 20 log(Duty cycle) Where the duty cycle correction factor is calculated from following formula:
 $20 \log(\text{Duty cycle}) = 20 \log(0.354 \text{ ms} / 7.04 \text{ ms}) = -26.0 \text{ dB}$

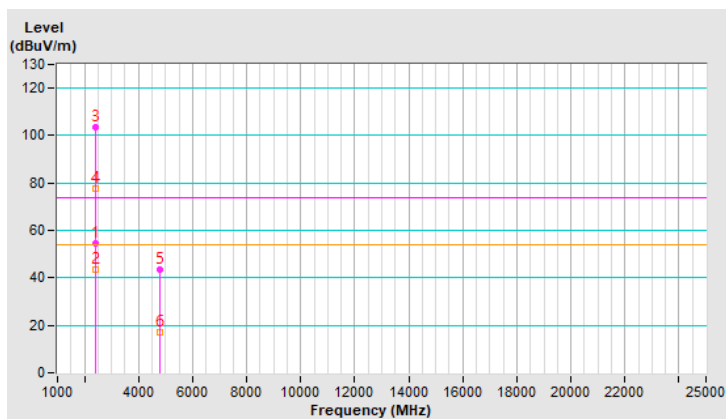

RF Mode	TX BT-LE 1M	Channel	CH 0 : 2402 MHz
Frequency Range	1 GHz ~ 25 GHz	Detector Function & Bandwidth	(PK) RB = 1 MHz, VB = 3 MHz (AV) RB = 1 MHz, VB = 3 MHz
Input Power (System)	120Vac, 60Hz	Environmental Conditions	26°C, 73% RH
Tested By	Sampson Chen		

Antenna Polarity & Test Distance : Vertical at 3 m								
No	Frequency (MHz)	Emission Level (dBuV/m)	Limit (dBuV/m)	Margin (dB)	Antenna Height (m)	Table Angle (Degree)	Raw Value (dBuV)	Correction Factor (dB/m)
1	2390.00	55.6 PK	74.0	-18.4	1.00 V	327	58.3	-2.7
2	2390.00	43.7 AV	54.0	-10.3	1.00 V	327	46.4	-2.7
3	*2402.00	94.4 PK			1.00 V	327	97.1	-2.7
4	*2402.00	68.4 AV			1.00 V	327	71.1	-2.7
5	4804.00	43.0 PK	74.0	-31.0	1.32 V	185	41.5	1.5
6	4804.00	17.0 AV	54.0	-37.0	1.32 V	185	15.5	1.5

Remarks:

1. Emission Level(dBuV/m) = Raw Value(dBuV) + Correction Factor(dB/m)
2. Correction Factor(dB/m) = Antenna Factor(dB/m) + Cable Factor(dB) – Pre-Amplifier Factor(dB)
3. Margin value = Emission Level – Limit value
4. The other emission levels were very low against the limit.
5. " * " : Fundamental frequency, the limit was restricted at the RF Output Power.
6. The average value of fundamental and harmonic frequency is: Average = Peak value + 20 log(Duty cycle) Where the duty cycle correction factor is calculated from following formula:
 $20 \log(\text{Duty cycle}) = 20 \log(0.354 \text{ ms} / 7.04 \text{ ms}) = -26.0 \text{ dB}$

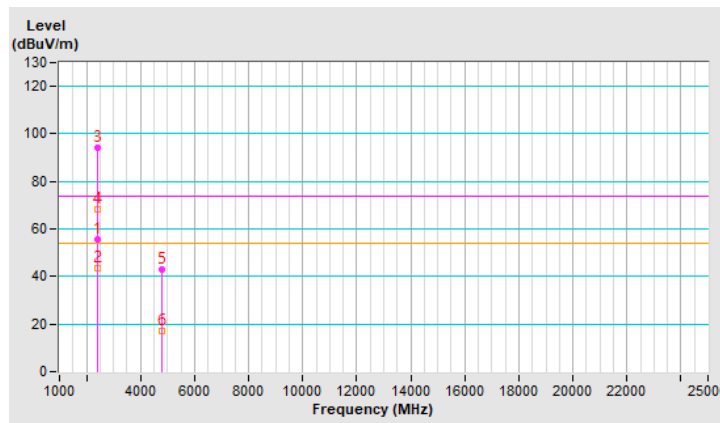

RF Mode	TX BT-LE 1M	Channel	CH 19 : 2440 MHz
Frequency Range	1 GHz ~ 25 GHz	Detector Function & Bandwidth	(PK) RB = 1 MHz, VB = 3 MHz (AV) RB = 1 MHz, VB = 3 MHz
Input Power (System)	120Vac, 60Hz	Environmental Conditions	26°C, 73% RH
Tested By	Sampson Chen		

Antenna Polarity & Test Distance : Horizontal at 3 m								
No	Frequency (MHz)	Emission Level (dBuV/m)	Limit (dBuV/m)	Margin (dB)	Antenna Height (m)	Table Angle (Degree)	Raw Value (dBuV)	Correction Factor (dB/m)
1	*2440.00	103.4 PK			1.22 H	90	106.2	-2.8
2	*2440.00	77.4 AV			1.22 H	90	80.2	-2.8
3	4880.00	43.6 PK	74.0	-30.4	1.19 H	348	42.1	1.5
4	4880.00	17.6 AV	54.0	-36.4	1.19 H	348	16.1	1.5
5	7320.00	48.8 PK	74.0	-25.2	1.06 H	356	41.6	7.2
6	7320.00	22.8 AV	54.0	-31.2	1.06 H	356	15.6	7.2

Remarks:

1. Emission Level(dBuV/m) = Raw Value(dBuV) + Correction Factor(dB/m)
2. Correction Factor(dB/m) = Antenna Factor(dB/m) + Cable Factor(dB) – Pre-Amplifier Factor(dB)
3. Margin value = Emission Level – Limit value
4. The other emission levels were very low against the limit.
5. " * " : Fundamental frequency, the limit was restricted at the RF Output Power.
6. The average value of fundamental and harmonic frequency is: Average = Peak value + 20 log(Duty cycle) Where the duty cycle correction factor is calculated from following formula:
 $20 \log(\text{Duty cycle}) = 20 \log(0.354 \text{ ms} / 7.04 \text{ ms}) = -26.0 \text{ dB}$

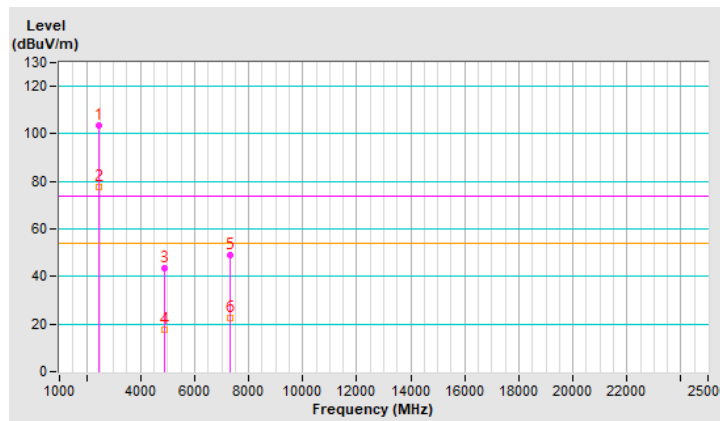

RF Mode	TX BT-LE 1M	Channel	CH 19 : 2440 MHz
Frequency Range	1 GHz ~ 25 GHz	Detector Function & Bandwidth	(PK) RB = 1 MHz, VB = 3 MHz (AV) RB = 1 MHz, VB = 3 MHz
Input Power (System)	120Vac, 60Hz	Environmental Conditions	26°C, 73% RH
Tested By	Sampson Chen		

Antenna Polarity & Test Distance : Vertical at 3 m								
No	Frequency (MHz)	Emission Level (dBuV/m)	Limit (dBuV/m)	Margin (dB)	Antenna Height (m)	Table Angle (Degree)	Raw Value (dBuV)	Correction Factor (dB/m)
1	*2440.00	94.8 PK			1.05 V	338	97.6	-2.8
2	*2440.00	68.8 AV			1.05 V	338	71.6	-2.8
3	4880.00	42.7 PK	74.0	-31.3	1.22 V	170	41.2	1.5
4	4880.00	16.7 AV	54.0	-37.3	1.22 V	170	15.2	1.5
5	7320.00	51.3 PK	74.0	-22.7	1.50 V	323	44.1	7.2
6	7320.00	25.3 AV	54.0	-28.7	1.50 V	323	18.1	7.2

Remarks:

1. Emission Level(dBuV/m) = Raw Value(dBuV) + Correction Factor(dB/m)
2. Correction Factor(dB/m) = Antenna Factor(dB/m) + Cable Factor(dB) – Pre-Amplifier Factor(dB)
3. Margin value = Emission Level – Limit value
4. The other emission levels were very low against the limit.
5. " * " : Fundamental frequency, the limit was restricted at the RF Output Power.
6. The average value of fundamental and harmonic frequency is: Average = Peak value + 20 log(Duty cycle) Where the duty cycle correction factor is calculated from following formula:
 $20 \log(\text{Duty cycle}) = 20 \log(0.354 \text{ ms} / 7.04 \text{ ms}) = -26.0 \text{ dB}$

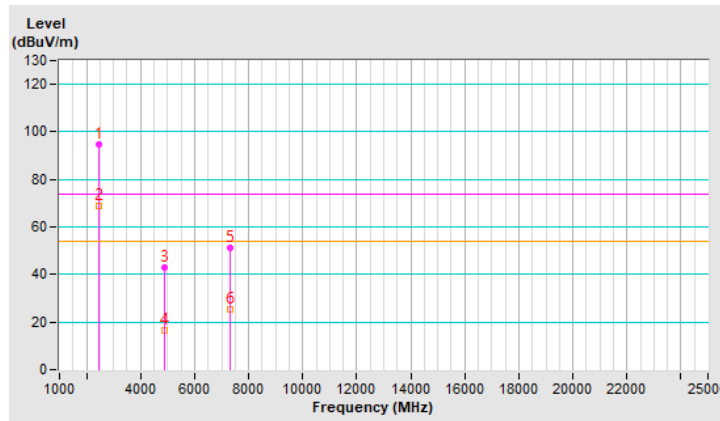

RF Mode	TX BT-LE 1M	Channel	CH 39 : 2480 MHz
Frequency Range	1 GHz ~ 25 GHz	Detector Function & Bandwidth	(PK) RB = 1 MHz, VB = 3 MHz (AV) RB = 1 MHz, VB = 3 MHz
Input Power (System)	120Vac, 60Hz	Environmental Conditions	26°C, 73% RH
Tested By	Sampson Chen		

Antenna Polarity & Test Distance : Horizontal at 3 m								
No	Frequency (MHz)	Emission Level (dBuV/m)	Limit (dBuV/m)	Margin (dB)	Antenna Height (m)	Table Angle (Degree)	Raw Value (dBuV)	Correction Factor (dB/m)
1	*2480.00	103.1 PK			1.23 H	96	106.0	-2.9
2	*2480.00	77.1 AV			1.23 H	96	80.0	-2.9
3	2483.50	54.3 PK	74.0	-19.7	1.23 H	96	57.2	-2.9
4	2483.50	43.8 AV	54.0	-10.2	1.23 H	96	46.7	-2.9
5	4960.00	44.0 PK	74.0	-30.0	1.21 H	344	42.3	1.7
6	4960.00	18.0 AV	54.0	-36.0	1.21 H	344	16.3	1.7
7	7440.00	49.2 PK	74.0	-24.8	1.07 H	351	41.6	7.6
8	7440.00	23.2 AV	54.0	-30.8	1.07 H	351	15.6	7.6

Remarks:

- Emission Level(dBuV/m) = Raw Value(dBuV) + Correction Factor(dB/m)
- Correction Factor(dB/m) = Antenna Factor(dB/m) + Cable Factor(dB) – Pre-Amplifier Factor(dB)
- Margin value = Emission Level – Limit value
- The other emission levels were very low against the limit.
- " * ": Fundamental frequency, the limit was restricted at the RF Output Power.
- The average value of fundamental and harmonic frequency is: Average = Peak value + 20 log(Duty cycle) Where the duty cycle correction factor is calculated from following formula:
 $20 \log(\text{Duty cycle}) = 20 \log(0.354 \text{ ms} / 7.04 \text{ ms}) = -26.0 \text{ dB}$

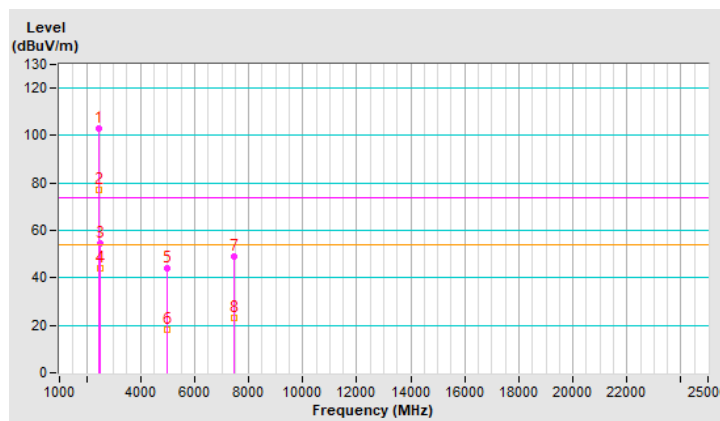

RF Mode	TX BT-LE 1M	Channel	CH 39 : 2480 MHz
Frequency Range	1 GHz ~ 25 GHz	Detector Function & Bandwidth	(PK) RB = 1 MHz, VB = 3 MHz (AV) RB = 1 MHz, VB = 3 MHz
Input Power (System)	120Vac, 60Hz	Environmental Conditions	26°C, 73% RH
Tested By	Sampson Chen		

Antenna Polarity & Test Distance : Vertical at 3 m								
No	Frequency (MHz)	Emission Level (dBuV/m)	Limit (dBuV/m)	Margin (dB)	Antenna Height (m)	Table Angle (Degree)	Raw Value (dBuV)	Correction Factor (dB/m)
1	*2480.00	95.1 PK			1.05 V	330	98.0	-2.9
2	*2480.00	69.1 AV			1.05 V	330	72.0	-2.9
3	2483.50	55.0 PK	74.0	-19.0	1.05 V	330	57.9	-2.9
4	2483.50	43.8 AV	54.0	-10.2	1.05 V	330	46.7	-2.9
5	4960.00	42.5 PK	74.0	-31.5	1.19 V	176	40.8	1.7
6	4960.00	16.5 AV	54.0	-37.5	1.19 V	176	14.8	1.7
7	7440.00	50.9 PK	74.0	-23.1	1.43 V	319	43.3	7.6
8	7440.00	24.9 AV	54.0	-29.1	1.43 V	319	17.3	7.6

Remarks:

1. Emission Level(dBuV/m) = Raw Value(dBuV) + Correction Factor(dB/m)
2. Correction Factor(dB/m) = Antenna Factor(dB/m) + Cable Factor(dB) – Pre-Amplifier Factor(dB)
3. Margin value = Emission Level – Limit value
4. The other emission levels were very low against the limit.
5. " * ": Fundamental frequency, the limit was restricted at the RF Output Power.
6. The average value of fundamental and harmonic frequency is: Average = Peak value + 20 log(Duty cycle) Where the duty cycle correction factor is calculated from following formula:
 $20 \log(\text{Duty cycle}) = 20 \log(0.354 \text{ ms} / 7.04 \text{ ms}) = -26.0 \text{ dB}$

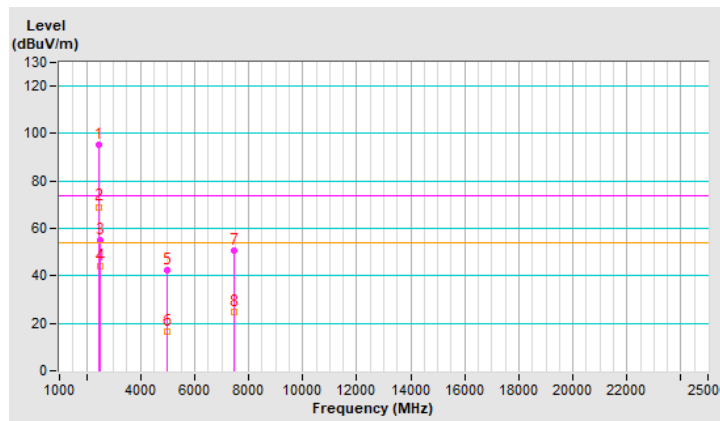

RF Mode	TX logi bolt 1M	Channel	CH 0 : 2402 MHz
Frequency Range	1 GHz ~ 25 GHz	Detector Function & Bandwidth	(PK) RB = 1 MHz, VB = 3 MHz (AV) RB = 1 MHz, VB = 3 MHz
Input Power (System)	120Vac, 60Hz	Environmental Conditions	26°C, 73% RH
Tested By	Sampson Chen		

Antenna Polarity & Test Distance : Horizontal at 3 m								
No	Frequency (MHz)	Emission Level (dBuV/m)	Limit (dBuV/m)	Margin (dB)	Antenna Height (m)	Table Angle (Degree)	Raw Value (dBuV)	Correction Factor (dB/m)
1	2390.00	54.6 PK	74.0	-19.4	1.21 H	102	57.3	-2.7
2	2390.00	43.9 AV	54.0	-10.1	1.21 H	102	46.6	-2.7
3	*2402.00	103.5 PK			1.21 H	102	106.2	-2.7
4	*2402.00	77.6 AV			1.21 H	102	80.3	-2.7
5	4804.00	42.9 PK	74.0	-31.1	1.19 H	349	41.4	1.5
6	4804.00	17.0 AV	54.0	-37.0	1.19 H	349	15.5	1.5

Remarks:

1. Emission Level(dBuV/m) = Raw Value(dBuV) + Correction Factor(dB/m)
2. Correction Factor(dB/m) = Antenna Factor(dB/m) + Cable Factor(dB) – Pre-Amplifier Factor(dB)
3. Margin value = Emission Level – Limit value
4. The other emission levels were very low against the limit.
5. " * " : Fundamental frequency, the limit was restricted at the RF Output Power.
6. The average value of fundamental and harmonic frequency is: Average = Peak value + 20 log(Duty cycle) Where the duty cycle correction factor is calculated from following formula:
 $20 \log(\text{Duty cycle}) = 20 \log(0.356 \text{ ms} / 7.05 \text{ ms}) = -25.9 \text{ dB}$

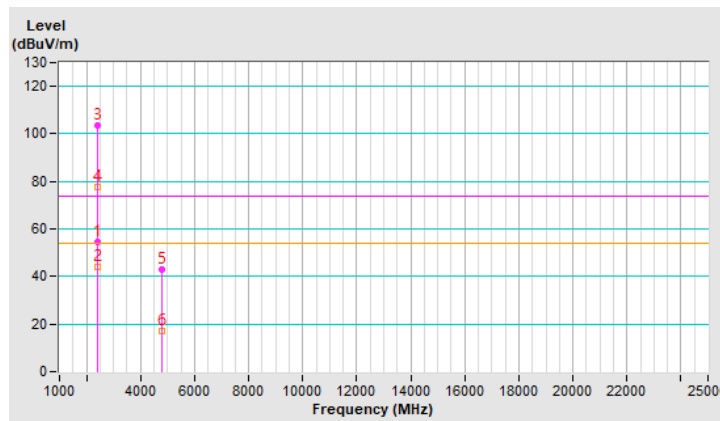

RF Mode	TX logi bolt 1M	Channel	CH 0 : 2402 MHz
Frequency Range	1 GHz ~ 25 GHz	Detector Function & Bandwidth	(PK) RB = 1 MHz, VB = 3 MHz (AV) RB = 1 MHz, VB = 3 MHz
Input Power (System)	120Vac, 60Hz	Environmental Conditions	26°C, 73% RH
Tested By	Sampson Chen		

Antenna Polarity & Test Distance : Vertical at 3 m								
No	Frequency (MHz)	Emission Level (dBuV/m)	Limit (dBuV/m)	Margin (dB)	Antenna Height (m)	Table Angle (Degree)	Raw Value (dBuV)	Correction Factor (dB/m)
1	2390.00	55.0 PK	74.0	-19.0	1.04 V	339	57.7	-2.7
2	2390.00	43.5 AV	54.0	-10.5	1.04 V	339	46.2	-2.7
3	*2402.00	94.1 PK			1.04 V	339	96.8	-2.7
4	*2402.00	68.2 AV			1.04 V	339	70.9	-2.7
5	4804.00	44.3 PK	74.0	-29.7	1.27 V	182	42.8	1.5
6	4804.00	18.4 AV	54.0	-35.6	1.27 V	182	16.9	1.5

Remarks:

1. Emission Level(dBuV/m) = Raw Value(dBuV) + Correction Factor(dB/m)
2. Correction Factor(dB/m) = Antenna Factor(dB/m) + Cable Factor(dB) – Pre-Amplifier Factor(dB)
3. Margin value = Emission Level – Limit value
4. The other emission levels were very low against the limit.
5. " * " : Fundamental frequency, the limit was restricted at the RF Output Power.
6. The average value of fundamental and harmonic frequency is: Average = Peak value + 20 log(Duty cycle) Where the duty cycle correction factor is calculated from following formula:
 $20 \log(\text{Duty cycle}) = 20 \log(0.356 \text{ ms} / 7.05 \text{ ms}) = -25.9 \text{ dB}$

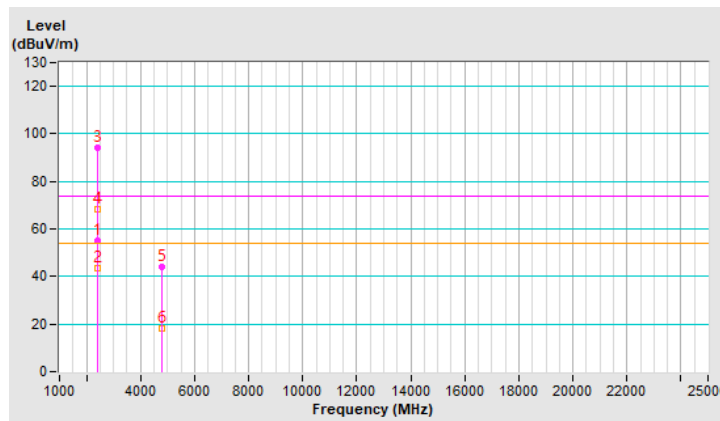

RF Mode	TX logi bolt 1M	Channel	CH 19 : 2440 MHz
Frequency Range	1 GHz ~ 25 GHz	Detector Function & Bandwidth	(PK) RB = 1 MHz, VB = 3 MHz (AV) RB = 1 MHz, VB = 3 MHz
Input Power (System)	120Vac, 60Hz	Environmental Conditions	26°C, 73% RH
Tested By	Sampson Chen		

Antenna Polarity & Test Distance : Horizontal at 3 m								
No	Frequency (MHz)	Emission Level (dBuV/m)	Limit (dBuV/m)	Margin (dB)	Antenna Height (m)	Table Angle (Degree)	Raw Value (dBuV)	Correction Factor (dB/m)
1	*2440.00	102.7 PK			1.19 H	96	105.5	-2.8
2	*2440.00	76.8 AV			1.19 H	96	79.6	-2.8
3	4880.00	43.4 PK	74.0	-30.6	1.23 H	348	41.9	1.5
4	4880.00	17.5 AV	54.0	-36.5	1.23 H	348	16.0	1.5
5	7320.00	48.6 PK	74.0	-25.4	1.10 H	360	41.4	7.2
6	7320.00	22.7 AV	54.0	-31.3	1.10 H	360	15.5	7.2

Remarks:

1. Emission Level(dBuV/m) = Raw Value(dBuV) + Correction Factor(dB/m)
2. Correction Factor(dB/m) = Antenna Factor(dB/m) + Cable Factor(dB) – Pre-Amplifier Factor(dB)
3. Margin value = Emission Level – Limit value
4. The other emission levels were very low against the limit.
5. " * " : Fundamental frequency, the limit was restricted at the RF Output Power.
6. The average value of fundamental and harmonic frequency is: Average = Peak value + 20 log(Duty cycle) Where the duty cycle correction factor is calculated from following formula:
 $20 \log(\text{Duty cycle}) = 20 \log(0.356 \text{ ms} / 7.05 \text{ ms}) = -25.9 \text{ dB}$

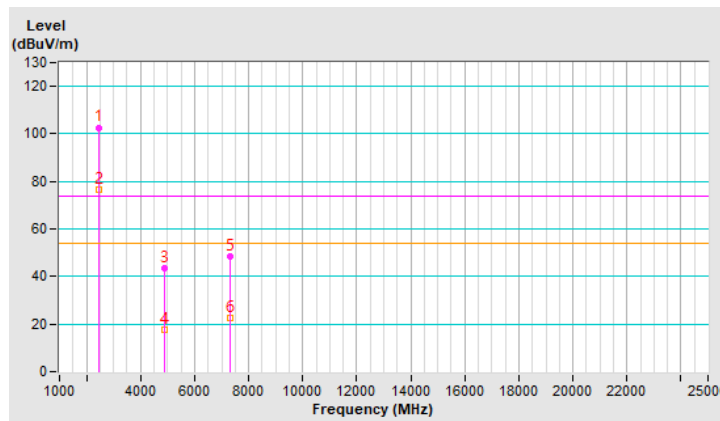

RF Mode	TX logi bolt 1M	Channel	CH 19 : 2440 MHz
Frequency Range	1 GHz ~ 25 GHz	Detector Function & Bandwidth	(PK) RB = 1 MHz, VB = 3 MHz (AV) RB = 1 MHz, VB = 3 MHz
Input Power (System)	120Vac, 60Hz	Environmental Conditions	26°C, 73% RH
Tested By	Sampson Chen		

Antenna Polarity & Test Distance : Vertical at 3 m								
No	Frequency (MHz)	Emission Level (dBuV/m)	Limit (dBuV/m)	Margin (dB)	Antenna Height (m)	Table Angle (Degree)	Raw Value (dBuV)	Correction Factor (dB/m)
1	*2440.00	92.9 PK			1.06 V	315	95.7	-2.8
2	*2440.00	67.0 AV			1.06 V	315	69.8	-2.8
3	4880.00	44.7 PK	74.0	-29.3	1.27 V	159	43.2	1.5
4	4880.00	18.8 AV	54.0	-35.2	1.27 V	159	17.3	1.5
5	7320.00	50.9 PK	74.0	-23.1	1.45 V	327	43.7	7.2
6	7320.00	25.0 AV	54.0	-29.0	1.45 V	327	17.8	7.2

Remarks:

1. Emission Level(dBuV/m) = Raw Value(dBuV) + Correction Factor(dB/m)
2. Correction Factor(dB/m) = Antenna Factor(dB/m) + Cable Factor(dB) – Pre-Amplifier Factor(dB)
3. Margin value = Emission Level – Limit value
4. The other emission levels were very low against the limit.
5. " * " : Fundamental frequency, the limit was restricted at the RF Output Power.
6. The average value of fundamental and harmonic frequency is: Average = Peak value + 20 log(Duty cycle) Where the duty cycle correction factor is calculated from following formula:
 $20 \log(\text{Duty cycle}) = 20 \log(0.356 \text{ ms} / 7.05 \text{ ms}) = -25.9 \text{ dB}$

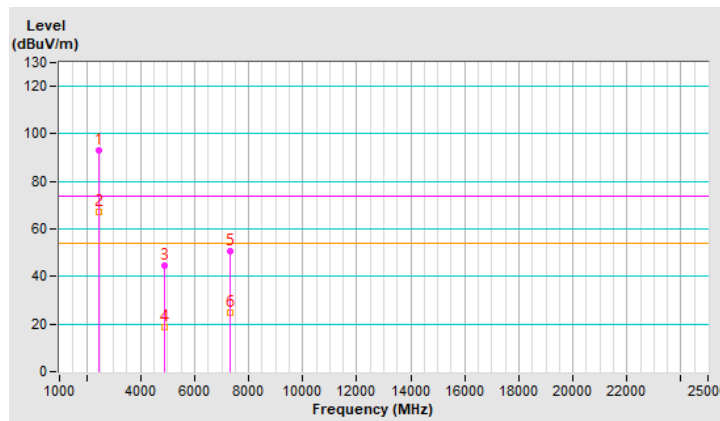

RF Mode	TX logi bolt 1M	Channel	CH 39 : 2480 MHz
Frequency Range	1 GHz ~ 25 GHz	Detector Function & Bandwidth	(PK) RB = 1 MHz, VB = 3 MHz (AV) RB = 1 MHz, VB = 3 MHz
Input Power (System)	120Vac, 60Hz	Environmental Conditions	26°C, 73% RH
Tested By	Sampson Chen		

Antenna Polarity & Test Distance : Horizontal at 3 m								
No	Frequency (MHz)	Emission Level (dBuV/m)	Limit (dBuV/m)	Margin (dB)	Antenna Height (m)	Table Angle (Degree)	Raw Value (dBuV)	Correction Factor (dB/m)
1	*2480.00	102.9 PK			1.19 H	116	105.8	-2.9
2	*2480.00	77.0 AV			1.19 H	116	79.9	-2.9
3	2483.50	57.3 PK	74.0	-16.7	1.19 H	116	60.2	-2.9
4	2483.50	43.6 AV	54.0	-10.4	1.19 H	116	46.5	-2.9
5	4960.00	44.2 PK	74.0	-29.8	1.23 H	343	42.5	1.7
6	4960.00	18.3 AV	54.0	-35.7	1.23 H	343	16.6	1.7
7	7440.00	48.9 PK	74.0	-25.1	1.02 H	342	41.3	7.6
8	7440.00	23.0 AV	54.0	-31.0	1.02 H	342	15.4	7.6

Remarks:

1. Emission Level(dBuV/m) = Raw Value(dBuV) + Correction Factor(dB/m)
2. Correction Factor(dB/m) = Antenna Factor(dB/m) + Cable Factor(dB) – Pre-Amplifier Factor(dB)
3. Margin value = Emission Level – Limit value
4. The other emission levels were very low against the limit.
5. " * ": Fundamental frequency, the limit was restricted at the RF Output Power.
6. The average value of fundamental and harmonic frequency is: Average = Peak value + 20 log(Duty cycle) Where the duty cycle correction factor is calculated from following formula:
 $20 \log(\text{Duty cycle}) = 20 \log(0.356 \text{ ms} / 7.05 \text{ ms}) = -25.9 \text{ dB}$

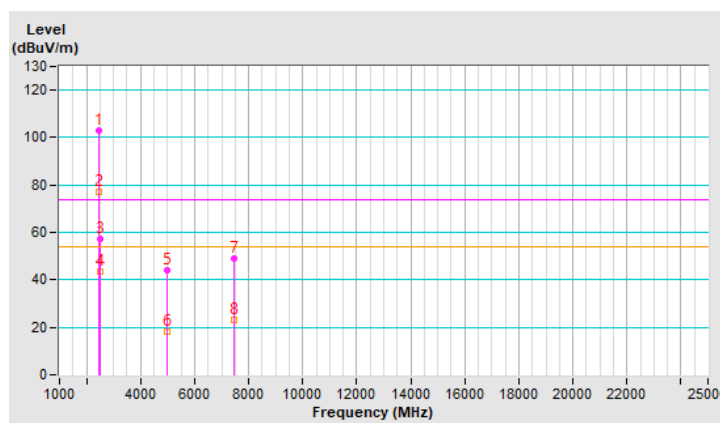

RF Mode	TX logi bolt 1M	Channel	CH 39 : 2480 MHz
Frequency Range	1 GHz ~ 25 GHz	Detector Function & Bandwidth	(PK) RB = 1 MHz, VB = 3 MHz (AV) RB = 1 MHz, VB = 3 MHz
Input Power (System)	120Vac, 60Hz	Environmental Conditions	26°C, 73% RH
Tested By	Sampson Chen		

Antenna Polarity & Test Distance : Vertical at 3 m								
No	Frequency (MHz)	Emission Level (dBuV/m)	Limit (dBuV/m)	Margin (dB)	Antenna Height (m)	Table Angle (Degree)	Raw Value (dBuV)	Correction Factor (dB/m)
1	*2480.00	94.8 PK			1.06 V	328	97.7	-2.9
2	*2480.00	68.9 AV			1.06 V	328	71.8	-2.9
3	2483.50	54.6 PK	74.0	-19.4	1.06 V	328	57.5	-2.9
4	2483.50	43.7 AV	54.0	-10.3	1.06 V	328	46.6	-2.9
5	4960.00	44.0 PK	74.0	-30.0	1.25 V	177	42.3	1.7
6	4960.00	18.1 AV	54.0	-35.9	1.25 V	177	16.4	1.7
7	7440.00	50.7 PK	74.0	-23.3	1.43 V	317	43.1	7.6
8	7440.00	24.8 AV	54.0	-29.2	1.43 V	317	17.2	7.6

Remarks:

1. Emission Level(dBuV/m) = Raw Value(dBuV) + Correction Factor(dB/m)
2. Correction Factor(dB/m) = Antenna Factor(dB/m) + Cable Factor(dB) – Pre-Amplifier Factor(dB)
3. Margin value = Emission Level – Limit value
4. The other emission levels were very low against the limit.
5. " * ": Fundamental frequency, the limit was restricted at the RF Output Power.
6. The average value of fundamental and harmonic frequency is: Average = Peak value + 20 log(Duty cycle) Where the duty cycle correction factor is calculated from following formula:
 $20 \log(\text{Duty cycle}) = 20 \log(0.356 \text{ ms} / 7.05 \text{ ms}) = -25.9 \text{ dB}$

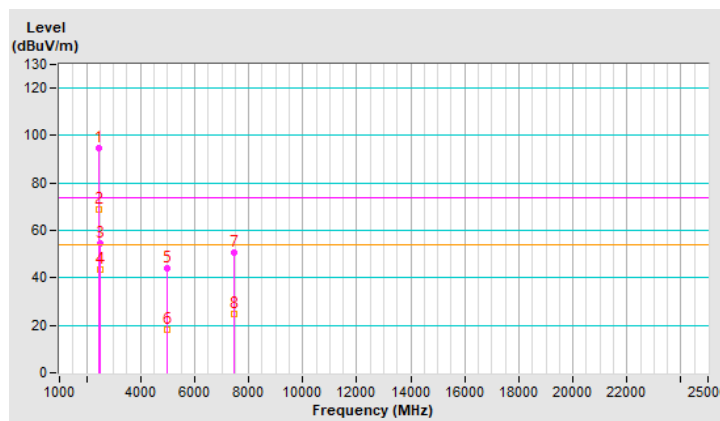

RF Mode	TX BT-LE 2M	Channel	CH 1 : 2404 MHz
Frequency Range	1 GHz ~ 25 GHz	Detector Function & Bandwidth	(PK) RB = 1 MHz, VB = 3 MHz (AV) RB = 1 MHz, VB = 3 MHz
Input Power (System)	120Vac, 60Hz	Environmental Conditions	26°C, 73% RH
Tested By	Sampson Chen		

Antenna Polarity & Test Distance : Horizontal at 3 m								
No	Frequency (MHz)	Emission Level (dBuV/m)	Limit (dBuV/m)	Margin (dB)	Antenna Height (m)	Table Angle (Degree)	Raw Value (dBuV)	Correction Factor (dB/m)
1	2390.00	54.5 PK	74.0	-19.5	1.26 H	92	57.2	-2.7
2	2390.00	44.3 AV	54.0	-9.7	1.26 H	92	47.0	-2.7
3	*2404.00	104.0 PK			1.26 H	92	106.7	-2.7
4	*2404.00	72.3 AV			1.26 H	92	75.0	-2.7
5	4808.00	43.0 PK	74.0	-31.0	1.15 H	342	41.5	1.5
6	4808.00	11.3 AV	54.0	-42.7	1.15 H	342	9.8	1.5

Remarks:

1. Emission Level(dBuV/m) = Raw Value(dBuV) + Correction Factor(dB/m)
2. Correction Factor(dB/m) = Antenna Factor(dB/m) + Cable Factor(dB) – Pre-Amplifier Factor(dB)
3. Margin value = Emission Level – Limit value
4. The other emission levels were very low against the limit.
5. " * " : Fundamental frequency, the limit was restricted at the RF Output Power.
6. The average value of fundamental and harmonic frequency is: Average = Peak value + 20 log(Duty cycle) Where the duty cycle correction factor is calculated from following formula:
 $20 \log(\text{Duty cycle}) = 20 \log(0.184 \text{ ms} / 7.046 \text{ ms}) = -31.7 \text{ dB}$

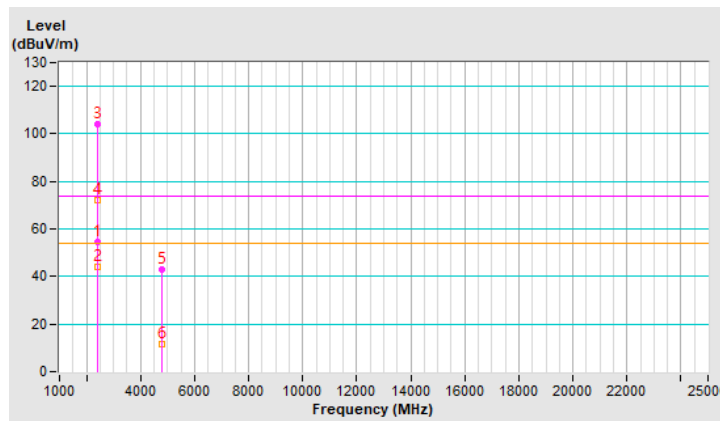

RF Mode	TX BT-LE 2M	Channel	CH 1 : 2404 MHz
Frequency Range	1 GHz ~ 25 GHz	Detector Function & Bandwidth	(PK) RB = 1 MHz, VB = 3 MHz (AV) RB = 1 MHz, VB = 3 MHz
Input Power (System)	120Vac, 60Hz	Environmental Conditions	26°C, 73% RH
Tested By	Sampson Chen		

Antenna Polarity & Test Distance : Vertical at 3 m								
No	Frequency (MHz)	Emission Level (dBuV/m)	Limit (dBuV/m)	Margin (dB)	Antenna Height (m)	Table Angle (Degree)	Raw Value (dBuV)	Correction Factor (dB/m)
1	2390.00	53.8 PK	74.0	-20.2	1.10 V	321	56.5	-2.7
2	2390.00	43.9 AV	54.0	-10.1	1.10 V	321	46.6	-2.7
3	*2404.00	94.5 PK			1.10 V	321	97.2	-2.7
4	*2404.00	62.8 AV			1.10 V	321	65.5	-2.7
5	4808.00	42.2 PK	74.0	-31.8	1.29 V	179	40.7	1.5
6	4808.00	10.5 AV	54.0	-43.5	1.29 V	179	9.0	1.5

Remarks:

1. Emission Level(dBuV/m) = Raw Value(dBuV) + Correction Factor(dB/m)
2. Correction Factor(dB/m) = Antenna Factor(dB/m) + Cable Factor(dB) – Pre-Amplifier Factor(dB)
3. Margin value = Emission Level – Limit value
4. The other emission levels were very low against the limit.
5. " * " : Fundamental frequency, the limit was restricted at the RF Output Power.
6. The average value of fundamental and harmonic frequency is: Average = Peak value + 20 log(Duty cycle) Where the duty cycle correction factor is calculated from following formula:
 $20 \log(\text{Duty cycle}) = 20 \log(0.184 \text{ ms} / 7.046 \text{ ms}) = -31.7 \text{ dB}$

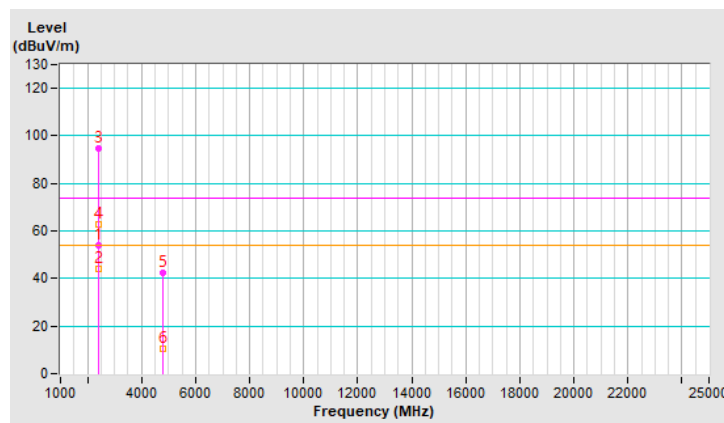

RF Mode	TX BT-LE 2M	Channel	CH 19 : 2440 MHz
Frequency Range	1 GHz ~ 25 GHz	Detector Function & Bandwidth	(PK) RB = 1 MHz, VB = 3 MHz (AV) RB = 1 MHz, VB = 3 MHz
Input Power (System)	120Vac, 60Hz	Environmental Conditions	26°C, 73% RH
Tested By	Sampson Chen		

Antenna Polarity & Test Distance : Horizontal at 3 m								
No	Frequency (MHz)	Emission Level (dBuV/m)	Limit (dBuV/m)	Margin (dB)	Antenna Height (m)	Table Angle (Degree)	Raw Value (dBuV)	Correction Factor (dB/m)
1	*2440.00	103.7 PK			1.19 H	111	106.5	-2.8
2	*2440.00	72.0 AV			1.19 H	111	74.8	-2.8
3	4880.00	42.9 PK	74.0	-31.1	1.15 H	348	41.4	1.5
4	4880.00	11.2 AV	54.0	-42.8	1.15 H	348	9.7	1.5
5	7320.00	48.2 PK	74.0	-25.8	1.06 H	351	41.0	7.2
6	7320.00	16.5 AV	54.0	-37.5	1.06 H	351	9.3	7.2

Remarks:

1. Emission Level(dBuV/m) = Raw Value(dBuV) + Correction Factor(dB/m)
2. Correction Factor(dB/m) = Antenna Factor(dB/m) + Cable Factor(dB) – Pre-Amplifier Factor(dB)
3. Margin value = Emission Level – Limit value
4. The other emission levels were very low against the limit.
5. " * " : Fundamental frequency, the limit was restricted at the RF Output Power.
6. The average value of fundamental and harmonic frequency is: Average = Peak value + 20 log(Duty cycle) Where the duty cycle correction factor is calculated from following formula:
 $20 \log(\text{Duty cycle}) = 20 \log(0.184 \text{ ms} / 7.046 \text{ ms}) = -31.7 \text{ dB}$

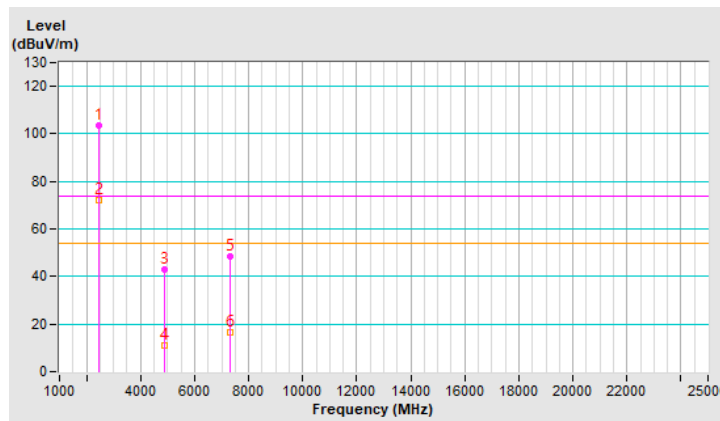

RF Mode	TX BT-LE 2M	Channel	CH 19 : 2440 MHz
Frequency Range	1 GHz ~ 25 GHz	Detector Function & Bandwidth	(PK) RB = 1 MHz, VB = 3 MHz (AV) RB = 1 MHz, VB = 3 MHz
Input Power (System)	120Vac, 60Hz	Environmental Conditions	26°C, 73% RH
Tested By	Sampson Chen		

Antenna Polarity & Test Distance : Vertical at 3 m								
No	Frequency (MHz)	Emission Level (dBuV/m)	Limit (dBuV/m)	Margin (dB)	Antenna Height (m)	Table Angle (Degree)	Raw Value (dBuV)	Correction Factor (dB/m)
1	*2440.00	95.2 PK			1.17 V	341	98.0	-2.8
2	*2440.00	63.5 AV			1.17 V	341	66.3	-2.8
3	4880.00	42.8 PK	74.0	-31.2	1.21 V	170	41.3	1.5
4	4880.00	11.1 AV	54.0	-42.9	1.21 V	170	9.6	1.5
5	7320.00	50.9 PK	74.0	-23.1	1.51 V	323	43.7	7.2
6	7320.00	19.2 AV	54.0	-34.8	1.51 V	323	12.0	7.2

Remarks:

- Emission Level(dBuV/m) = Raw Value(dBuV) + Correction Factor(dB/m)
- Correction Factor(dB/m) = Antenna Factor(dB/m) + Cable Factor(dB) – Pre-Amplifier Factor(dB)
- Margin value = Emission Level – Limit value
- The other emission levels were very low against the limit.
- " * " : Fundamental frequency, the limit was restricted at the RF Output Power.
- The average value of fundamental and harmonic frequency is: Average = Peak value + 20 log(Duty cycle) Where the duty cycle correction factor is calculated from following formula:
 $20 \log(\text{Duty cycle}) = 20 \log(0.184 \text{ ms} / 7.046 \text{ ms}) = -31.7 \text{ dB}$

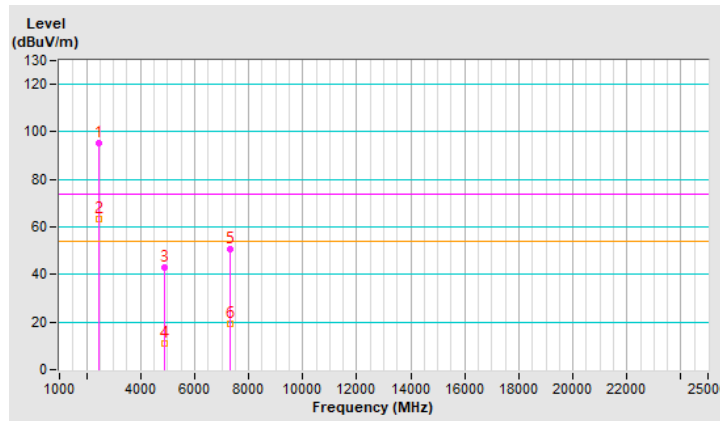

RF Mode	TX BT-LE 2M	Channel	CH 38 : 2478 MHz
Frequency Range	1 GHz ~ 25 GHz	Detector Function & Bandwidth	(PK) RB = 1 MHz, VB = 3 MHz (AV) RB = 1 MHz, VB = 3 MHz
Input Power (System)	120Vac, 60Hz	Environmental Conditions	26°C, 73% RH
Tested By	Sampson Chen		

Antenna Polarity & Test Distance : Horizontal at 3 m								
No	Frequency (MHz)	Emission Level (dBuV/m)	Limit (dBuV/m)	Margin (dB)	Antenna Height (m)	Table Angle (Degree)	Raw Value (dBuV)	Correction Factor (dB/m)
1	*2478.00	103.0 PK			1.28 H	90	105.9	-2.9
2	*2478.00	71.3 AV			1.28 H	90	74.2	-2.9
3	2483.50	54.5 PK	74.0	-19.5	1.28 H	90	57.4	-2.9
4	2483.50	43.3 AV	54.0	-10.7	1.28 H	90	46.2	-2.9
5	4956.00	43.3 PK	74.0	-30.7	1.21 H	336	41.6	1.7
6	4956.00	11.6 AV	54.0	-42.4	1.21 H	336	9.9	1.7
7	7434.00	47.9 PK	74.0	-26.1	1.12 H	338	40.4	7.5
8	7434.00	16.2 AV	54.0	-37.8	1.12 H	338	8.7	7.5

Remarks:

1. Emission Level(dBuV/m) = Raw Value(dBuV) + Correction Factor(dB/m)
2. Correction Factor(dB/m) = Antenna Factor(dB/m) + Cable Factor(dB) – Pre-Amplifier Factor(dB)
3. Margin value = Emission Level – Limit value
4. The other emission levels were very low against the limit.
5. " * ": Fundamental frequency, the limit was restricted at the RF Output Power.
6. The average value of fundamental and harmonic frequency is: Average = Peak value + 20 log(Duty cycle) Where the duty cycle correction factor is calculated from following formula:
 $20 \log(\text{Duty cycle}) = 20 \log(0.184 \text{ ms} / 7.046 \text{ ms}) = -31.7 \text{ dB}$

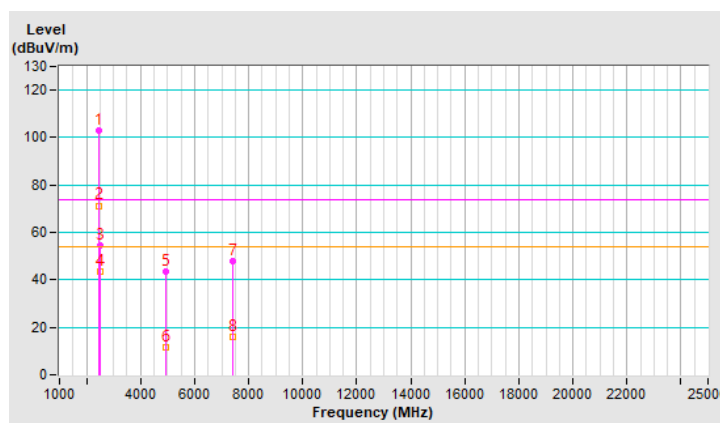

RF Mode	TX BT-LE 2M	Channel	CH 38 : 2478 MHz
Frequency Range	1 GHz ~ 25 GHz	Detector Function & Bandwidth	(PK) RB = 1 MHz, VB = 3 MHz (AV) RB = 1 MHz, VB = 3 MHz
Input Power (System)	120Vac, 60Hz	Environmental Conditions	26°C, 73% RH
Tested By	Sampson Chen		

Antenna Polarity & Test Distance : Vertical at 3 m								
No	Frequency (MHz)	Emission Level (dBuV/m)	Limit (dBuV/m)	Margin (dB)	Antenna Height (m)	Table Angle (Degree)	Raw Value (dBuV)	Correction Factor (dB/m)
1	*2478.00	95.0 PK			1.12 V	329	97.9	-2.9
2	*2478.00	63.3 AV			1.12 V	329	66.2	-2.9
3	2483.50	54.2 PK	74.0	-19.8	1.12 V	329	57.1	-2.9
4	2483.50	43.8 AV	54.0	-10.2	1.12 V	329	46.7	-2.9
5	4956.00	42.6 PK	74.0	-31.4	1.24 V	165	40.9	1.7
6	4956.00	10.9 AV	54.0	-43.1	1.24 V	165	9.2	1.7
7	7434.00	50.3 PK	74.0	-23.7	1.55 V	318	42.8	7.5
8	7434.00	18.6 AV	54.0	-35.4	1.55 V	318	11.1	7.5

Remarks:

1. Emission Level(dBuV/m) = Raw Value(dBuV) + Correction Factor(dB/m)
2. Correction Factor(dB/m) = Antenna Factor(dB/m) + Cable Factor(dB) – Pre-Amplifier Factor(dB)
3. Margin value = Emission Level – Limit value
4. The other emission levels were very low against the limit.
5. " * ": Fundamental frequency, the limit was restricted at the RF Output Power.
6. The average value of fundamental and harmonic frequency is: Average = Peak value + 20 log(Duty cycle) Where the duty cycle correction factor is calculated from following formula:
 $20 \log(\text{Duty cycle}) = 20 \log(0.184 \text{ ms} / 7.046 \text{ ms}) = -31.7 \text{ dB}$

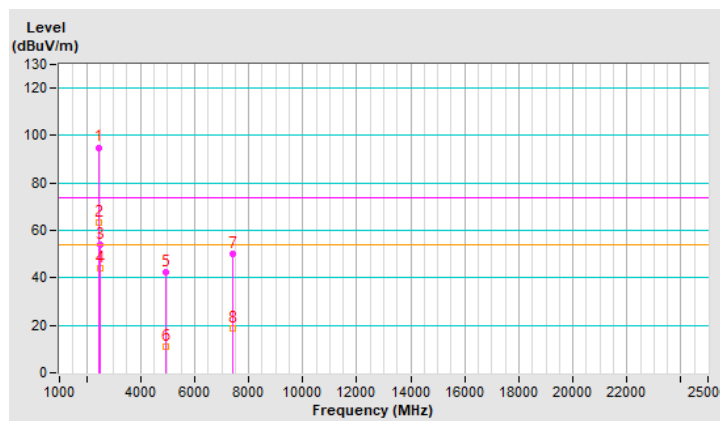

RF Mode	TX logi bolt 2M	Channel	CH 1 : 2404 MHz
Frequency Range	1 GHz ~ 25 GHz	Detector Function & Bandwidth	(PK) RB = 1 MHz, VB = 3 MHz (AV) RB = 1 MHz, VB = 3 MHz
Input Power (System)	120Vac, 60Hz	Environmental Conditions	26°C, 73% RH
Tested By	Sampson Chen		

Antenna Polarity & Test Distance : Horizontal at 3 m								
No	Frequency (MHz)	Emission Level (dBuV/m)	Limit (dBuV/m)	Margin (dB)	Antenna Height (m)	Table Angle (Degree)	Raw Value (dBuV)	Correction Factor (dB/m)
1	2390.00	54.7 PK	74.0	-19.3	1.23 H	88	57.4	-2.7
2	2390.00	44.1 AV	54.0	-9.9	1.23 H	88	46.8	-2.7
3	*2404.00	103.8 PK			1.23 H	88	106.5	-2.7
4	*2404.00	72.2 AV			1.23 H	88	74.9	-2.7
5	4808.00	42.6 PK	74.0	-31.4	1.21 H	339	41.1	1.5
6	4808.00	11.0 AV	54.0	-43.0	1.21 H	339	9.5	1.5

Remarks:

1. Emission Level(dBuV/m) = Raw Value(dBuV) + Correction Factor(dB/m)
2. Correction Factor(dB/m) = Antenna Factor(dB/m) + Cable Factor(dB) – Pre-Amplifier Factor(dB)
3. Margin value = Emission Level – Limit value
4. The other emission levels were very low against the limit.
5. " * " : Fundamental frequency, the limit was restricted at the RF Output Power.
6. The average value of fundamental and harmonic frequency is: Average = Peak value + 20 log(Duty cycle) Where the duty cycle correction factor is calculated from following formula:
 $20 \log(\text{Duty cycle}) = 20 \log(0.185 \text{ ms} / 7.056 \text{ ms}) = -31.6 \text{ dB}$

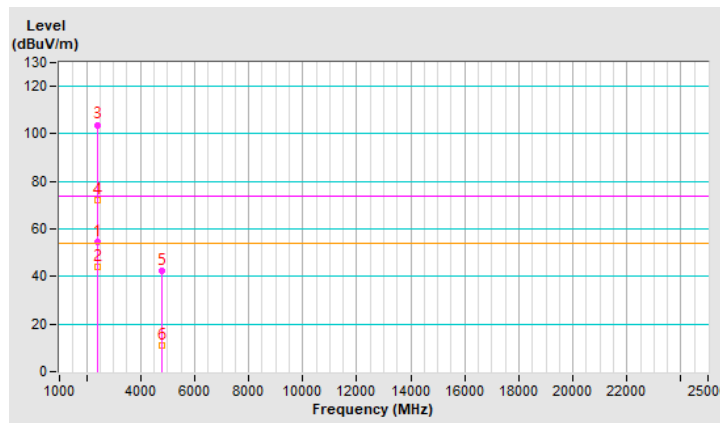

RF Mode	TX logi bolt 2M	Channel	CH 1 : 2404 MHz
Frequency Range	1 GHz ~ 25 GHz	Detector Function & Bandwidth	(PK) RB = 1 MHz, VB = 3 MHz (AV) RB = 1 MHz, VB = 3 MHz
Input Power (System)	120Vac, 60Hz	Environmental Conditions	26°C, 73% RH
Tested By	Sampson Chen		

Antenna Polarity & Test Distance : Vertical at 3 m								
No	Frequency (MHz)	Emission Level (dBuV/m)	Limit (dBuV/m)	Margin (dB)	Antenna Height (m)	Table Angle (Degree)	Raw Value (dBuV)	Correction Factor (dB/m)
1	2390.00	53.9 PK	74.0	-20.1	1.03 V	315	56.6	-2.7
2	2390.00	44.1 AV	54.0	-9.9	1.03 V	315	46.8	-2.7
3	*2404.00	94.3 PK			1.03 V	315	97.0	-2.7
4	*2404.00	62.7 AV			1.03 V	315	65.4	-2.7
5	4808.00	42.3 PK	74.0	-31.7	1.26 V	184	40.8	1.5
6	4808.00	10.7 AV	54.0	-43.3	1.26 V	184	9.2	1.5

Remarks:

- Emission Level(dBuV/m) = Raw Value(dBuV) + Correction Factor(dB/m)
- Correction Factor(dB/m) = Antenna Factor(dB/m) + Cable Factor(dB) – Pre-Amplifier Factor(dB)
- Margin value = Emission Level – Limit value
- The other emission levels were very low against the limit.
- " * " : Fundamental frequency, the limit was restricted at the RF Output Power.
- The average value of fundamental and harmonic frequency is: Average = Peak value + 20 log(Duty cycle) Where the duty cycle correction factor is calculated from following formula:
 $20 \log(\text{Duty cycle}) = 20 \log(0.185 \text{ ms} / 7.056 \text{ ms}) = -31.6 \text{ dB}$

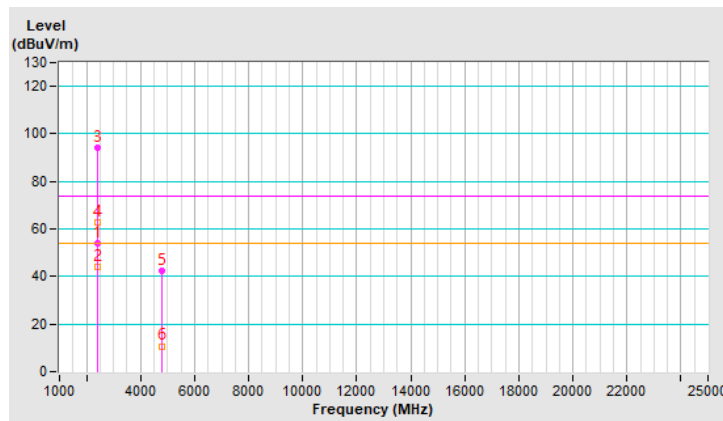

RF Mode	TX logi bolt 2M	Channel	CH 19 : 2440 MHz
Frequency Range	1 GHz ~ 25 GHz	Detector Function & Bandwidth	(PK) RB = 1 MHz, VB = 3 MHz (AV) RB = 1 MHz, VB = 3 MHz
Input Power (System)	120Vac, 60Hz	Environmental Conditions	26°C, 73% RH
Tested By	Sampson Chen		

Antenna Polarity & Test Distance : Horizontal at 3 m								
No	Frequency (MHz)	Emission Level (dBUV/m)	Limit (dBUV/m)	Margin (dB)	Antenna Height (m)	Table Angle (Degree)	Raw Value (dBUV)	Correction Factor (dB/m)
1	*2440.00	102.4 PK			1.21 H	101	105.2	-2.8
2	*2440.00	70.8 AV			1.21 H	101	73.6	-2.8
3	4880.00	42.8 PK	74.0	-31.2	1.21 H	348	41.3	1.5
4	4880.00	11.2 AV	54.0	-42.8	1.21 H	348	9.7	1.5
5	7320.00	47.9 PK	74.0	-26.1	1.11 H	343	40.7	7.2
6	7320.00	16.3 AV	54.0	-37.7	1.11 H	343	9.1	7.2

Remarks:

1. Emission Level(dBUV/m) = Raw Value(dBUV) + Correction Factor(dB/m)
2. Correction Factor(dB/m) = Antenna Factor(dB/m) + Cable Factor(dB) – Pre-Amplifier Factor(dB)
3. Margin value = Emission Level – Limit value
4. The other emission levels were very low against the limit.
5. " * " : Fundamental frequency, the limit was restricted at the RF Output Power.
6. The average value of fundamental and harmonic frequency is: Average = Peak value + 20 log(Duty cycle) Where the duty cycle correction factor is calculated from following formula:
 $20 \log(\text{Duty cycle}) = 20 \log(0.185 \text{ ms} / 7.056 \text{ ms}) = -31.6 \text{ dB}$

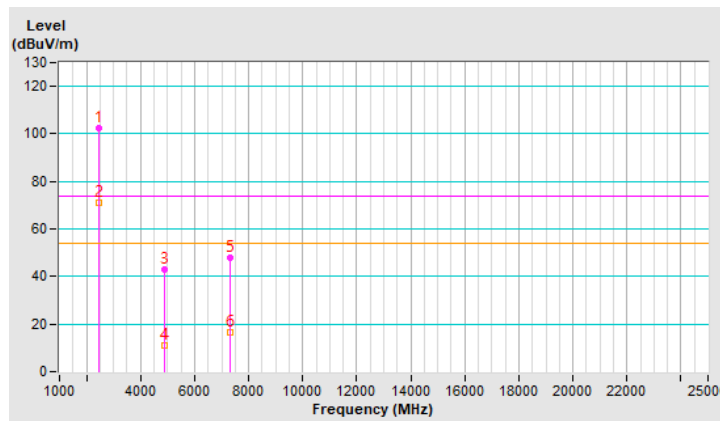

RF Mode	TX logi bolt 2M	Channel	CH 19 : 2440 MHz
Frequency Range	1 GHz ~ 25 GHz	Detector Function & Bandwidth	(PK) RB = 1 MHz, VB = 3 MHz (AV) RB = 1 MHz, VB = 3 MHz
Input Power (System)	120Vac, 60Hz	Environmental Conditions	26°C, 73% RH
Tested By	Sampson Chen		

Antenna Polarity & Test Distance : Vertical at 3 m								
No	Frequency (MHz)	Emission Level (dBuV/m)	Limit (dBuV/m)	Margin (dB)	Antenna Height (m)	Table Angle (Degree)	Raw Value (dBuV)	Correction Factor (dB/m)
1	*2440.00	93.7 PK			1.09 V	332	96.5	-2.8
2	*2440.00	62.1 AV			1.09 V	332	64.9	-2.8
3	4880.00	43.3 PK	74.0	-30.7	1.16 V	162	41.8	1.5
4	4880.00	11.4 AV	54.0	-42.6	1.16 V	162	9.9	1.5
5	7320.00	50.6 PK	74.0	-23.4	1.52 V	327	43.4	7.2
6	7320.00	19.0 AV	54.0	-35.0	1.52 V	327	11.8	7.2

Remarks:

1. Emission Level(dBuV/m) = Raw Value(dBuV) + Correction Factor(dB/m)
2. Correction Factor(dB/m) = Antenna Factor(dB/m) + Cable Factor(dB) – Pre-Amplifier Factor(dB)
3. Margin value = Emission Level – Limit value
4. The other emission levels were very low against the limit.
5. " * " : Fundamental frequency, the limit was restricted at the RF Output Power.
6. The average value of fundamental and harmonic frequency is: Average = Peak value + 20 log(Duty cycle) Where the duty cycle correction factor is calculated from following formula:
 $20 \log(\text{Duty cycle}) = 20 \log(0.185 \text{ ms} / 7.056 \text{ ms}) = -31.6 \text{ dB}$

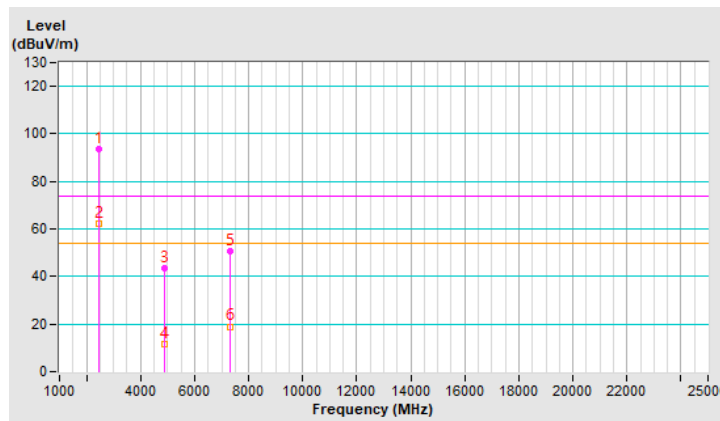

RF Mode	TX logi bolt 2M	Channel	CH 38 : 2478 MHz
Frequency Range	1 GHz ~ 25 GHz	Detector Function & Bandwidth	(PK) RB = 1 MHz, VB = 3 MHz (AV) RB = 1 MHz, VB = 3 MHz
Input Power (System)	120Vac, 60Hz	Environmental Conditions	26°C, 73% RH
Tested By	Sampson Chen		

Antenna Polarity & Test Distance : Horizontal at 3 m								
No	Frequency (MHz)	Emission Level (dBuV/m)	Limit (dBuV/m)	Margin (dB)	Antenna Height (m)	Table Angle (Degree)	Raw Value (dBuV)	Correction Factor (dB/m)
1	*2478.00	102.8 PK			1.18 H	85	105.7	-2.9
2	*2478.00	71.2 AV			1.18 H	85	74.1	-2.9
3	2483.50	55.0 PK	74.0	-19.0	1.18 H	85	57.9	-2.9
4	2483.50	44.1 AV	54.0	-9.9	1.18 H	85	47.0	-2.9
5	4956.00	43.5 PK	74.0	-30.5	1.17 H	328	41.8	1.7
6	4956.00	11.9 AV	54.0	-42.1	1.17 H	328	10.2	1.7
7	7434.00	47.7 PK	74.0	-26.3	1.07 H	329	40.2	7.5
8	7434.00	16.1 AV	54.0	-37.9	1.07 H	329	8.6	7.5

Remarks:

1. Emission Level(dBuV/m) = Raw Value(dBuV) + Correction Factor(dB/m)
2. Correction Factor(dB/m) = Antenna Factor(dB/m) + Cable Factor(dB) – Pre-Amplifier Factor(dB)
3. Margin value = Emission Level – Limit value
4. The other emission levels were very low against the limit.
5. " * ": Fundamental frequency, the limit was restricted at the RF Output Power.
6. The average value of fundamental and harmonic frequency is: Average = Peak value + 20 log(Duty cycle) Where the duty cycle correction factor is calculated from following formula:
 $20 \log(\text{Duty cycle}) = 20 \log(0.185 \text{ ms} / 7.056 \text{ ms}) = -31.6 \text{ dB}$

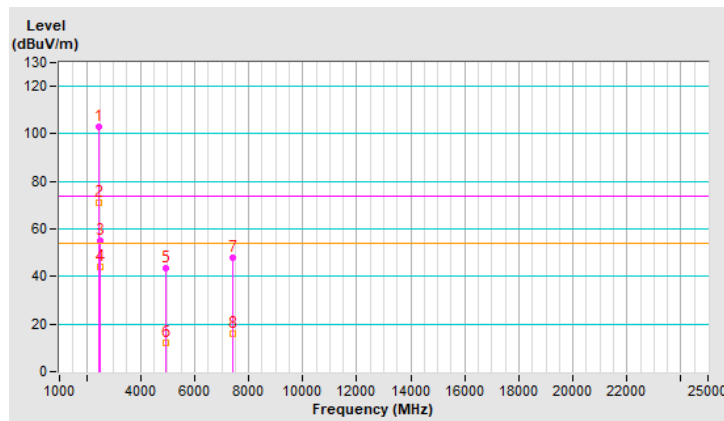

RF Mode	TX logi bolt 2M	Channel	CH 38 : 2478 MHz
Frequency Range	1 GHz ~ 25 GHz	Detector Function & Bandwidth	(PK) RB = 1 MHz, VB = 3 MHz (AV) RB = 1 MHz, VB = 3 MHz
Input Power (System)	120Vac, 60Hz	Environmental Conditions	26°C, 73% RH
Tested By	Sampson Chen		

Antenna Polarity & Test Distance : Vertical at 3 m								
No	Frequency (MHz)	Emission Level (dBuV/m)	Limit (dBuV/m)	Margin (dB)	Antenna Height (m)	Table Angle (Degree)	Raw Value (dBuV)	Correction Factor (dB/m)
1	*2478.00	94.9 PK			1.02 V	313	97.8	-2.9
2	*2478.00	63.3 AV			1.02 V	313	66.2	-2.9
3	2483.50	54.4 PK	74.0	-19.6	1.02 V	313	57.3	-2.9
4	2483.50	43.5 AV	54.0	-10.5	1.02 V	313	46.4	-2.9
5	4956.00	43.0 PK	74.0	-31.0	1.22 V	178	41.3	1.7
6	4956.00	11.3 AV	54.0	-42.7	1.22 V	178	9.6	1.7
7	7434.00	50.7 PK	74.0	-23.3	1.52 V	328	43.2	7.5
8	7434.00	18.9 AV	54.0	-35.1	1.52 V	328	11.4	7.5

Remarks:

1. Emission Level(dBuV/m) = Raw Value(dBuV) + Correction Factor(dB/m)
2. Correction Factor(dB/m) = Antenna Factor(dB/m) + Cable Factor(dB) – Pre-Amplifier Factor(dB)
3. Margin value = Emission Level – Limit value
4. The other emission levels were very low against the limit.
5. " * ": Fundamental frequency, the limit was restricted at the RF Output Power.
6. The average value of fundamental and harmonic frequency is: Average = Peak value + 20 log(Duty cycle) Where the duty cycle correction factor is calculated from following formula:
 $20 \log(\text{Duty cycle}) = 20 \log(0.185 \text{ ms} / 7.056 \text{ ms}) = -31.6 \text{ dB}$

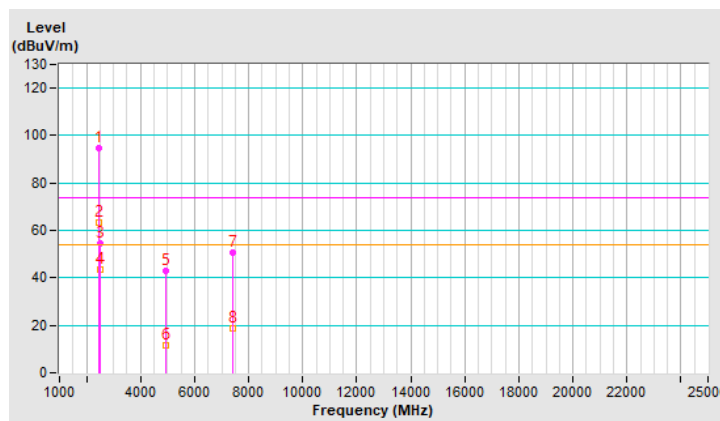

Plot of Band Edge

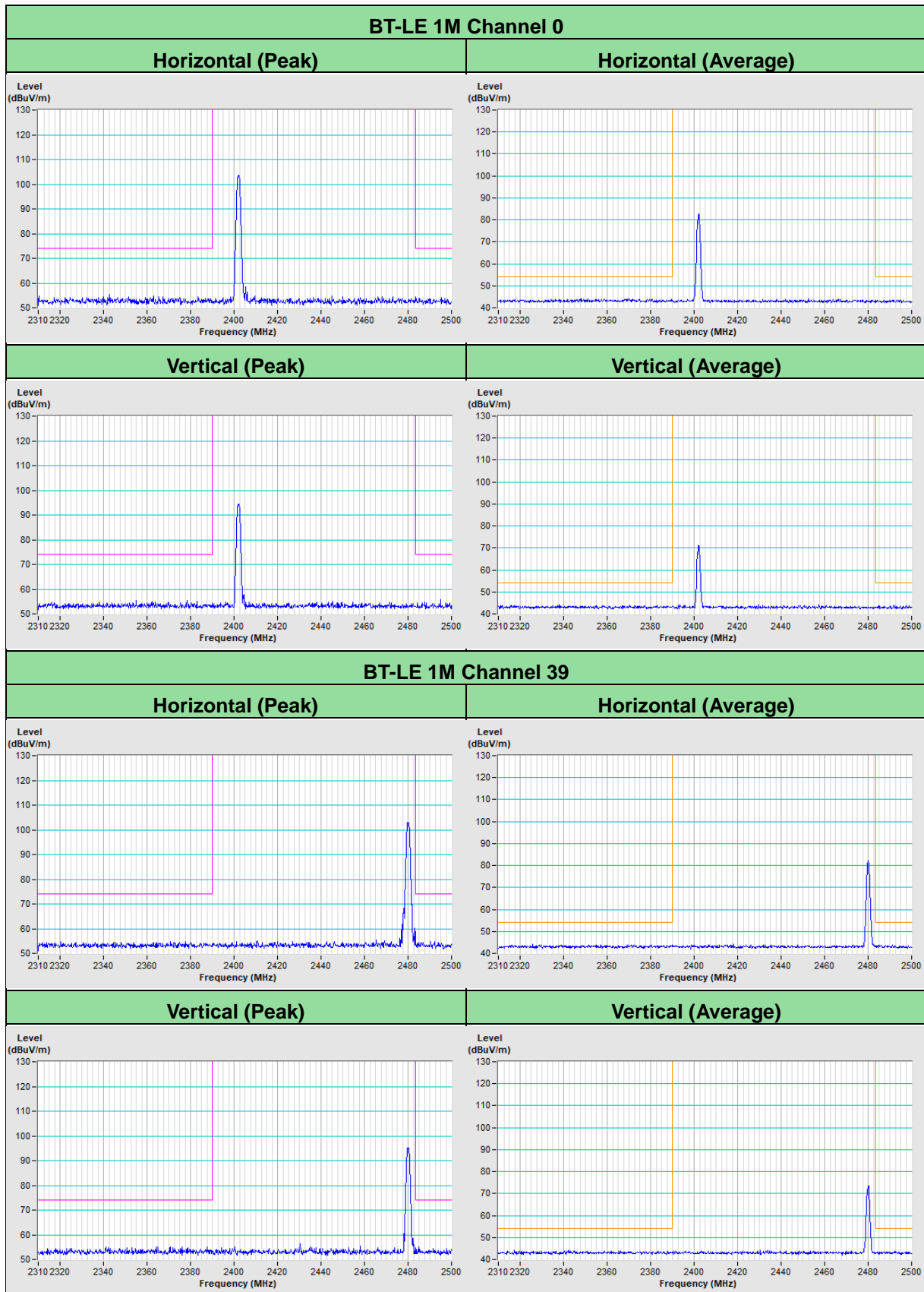

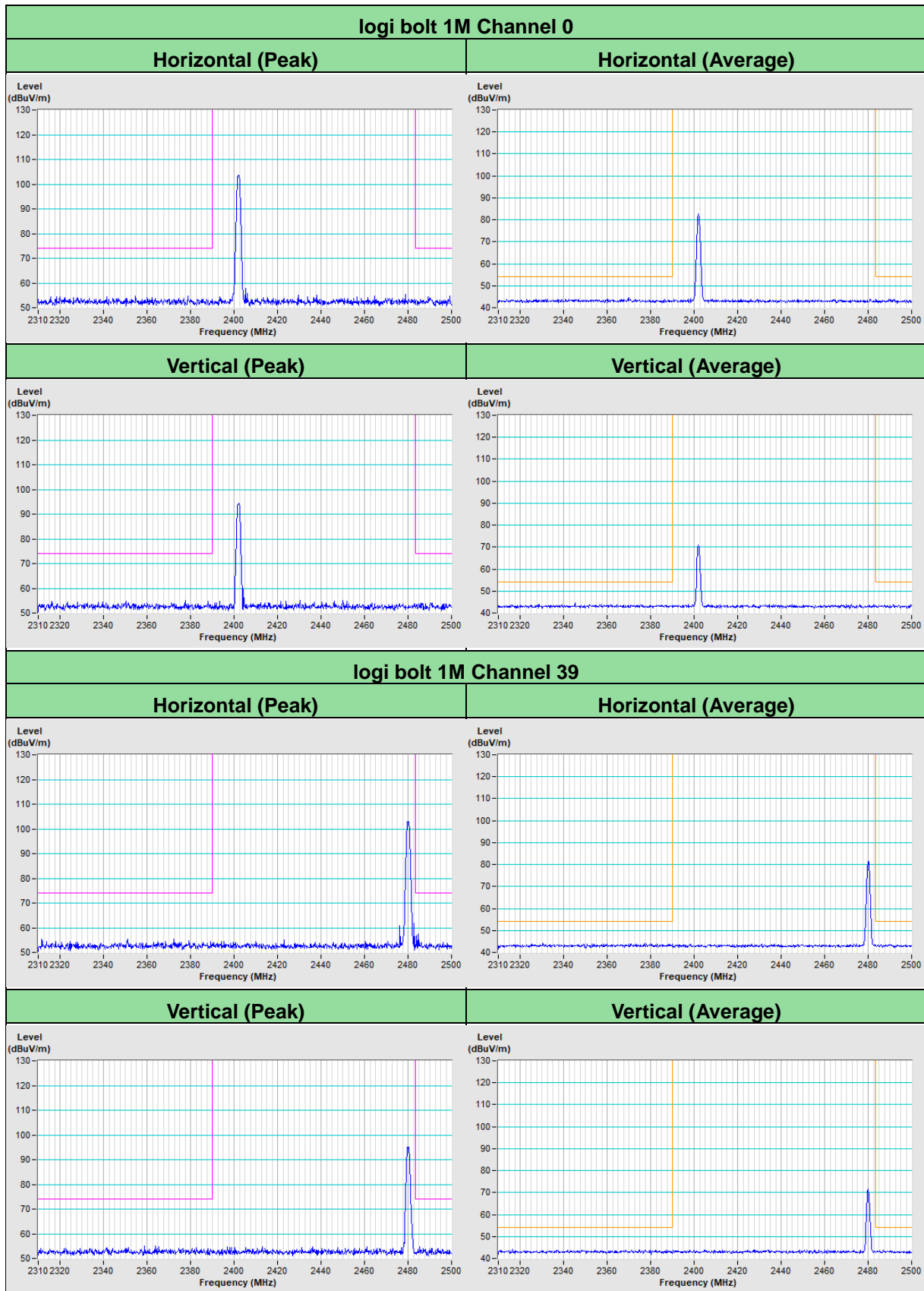

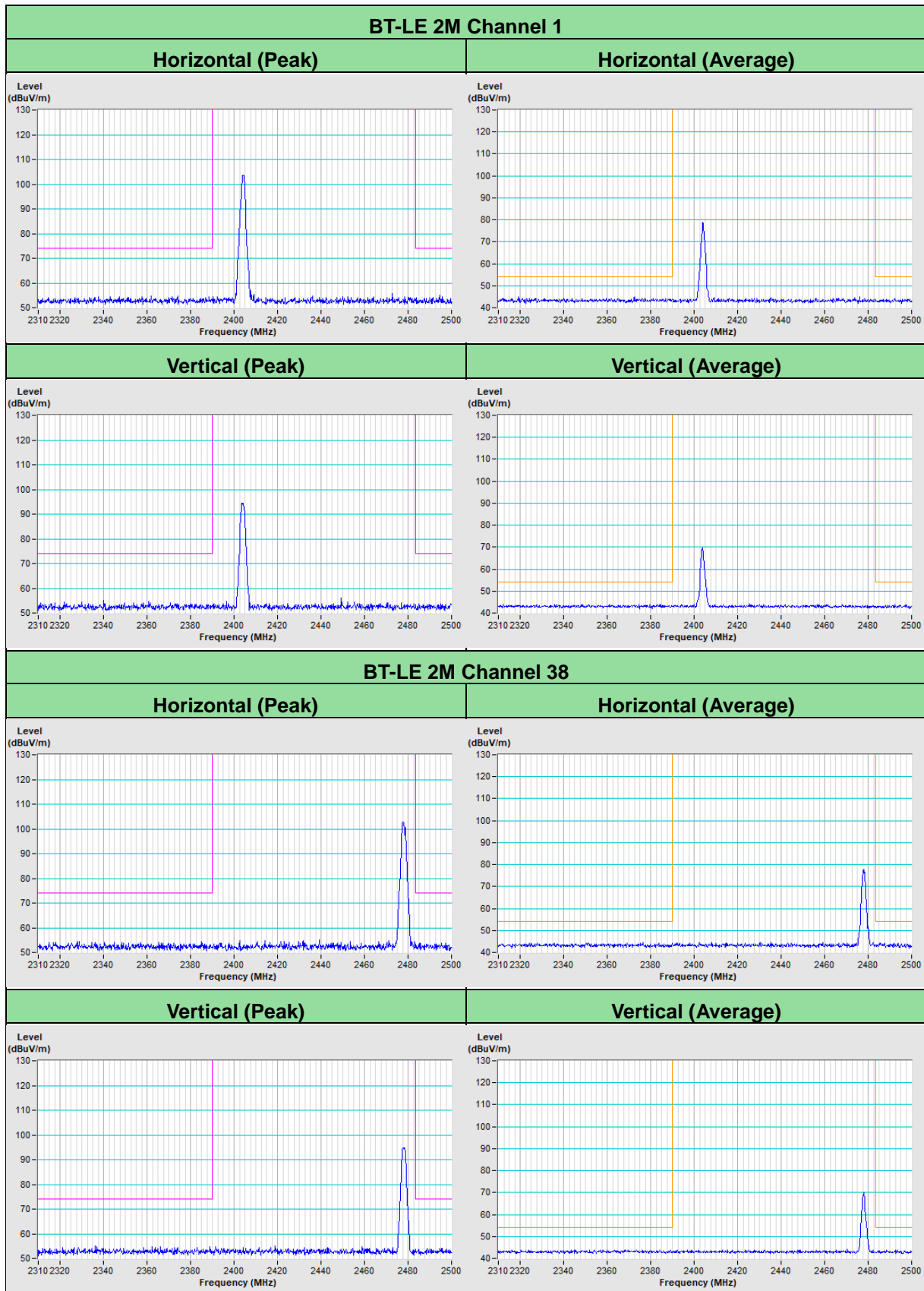

logi bolt 2M Channel 1

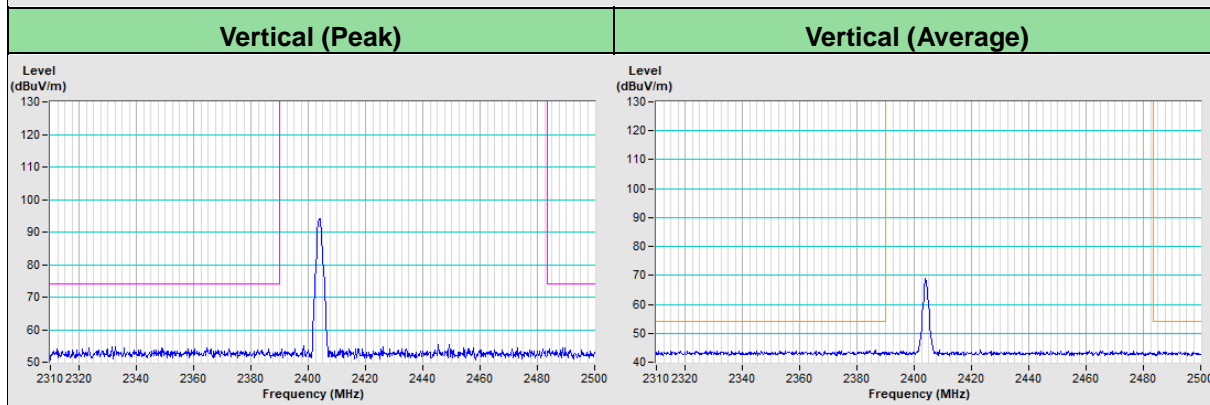
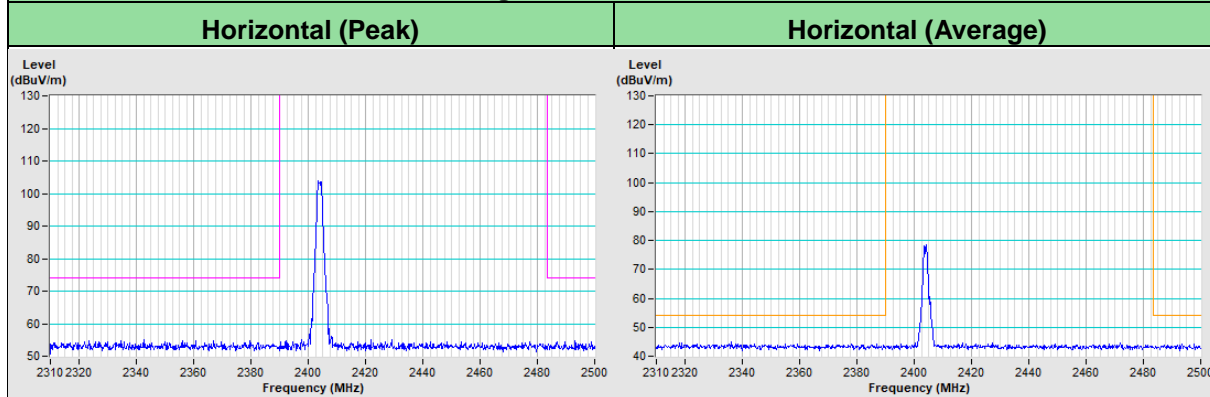

logi bolt 2M Channel 38

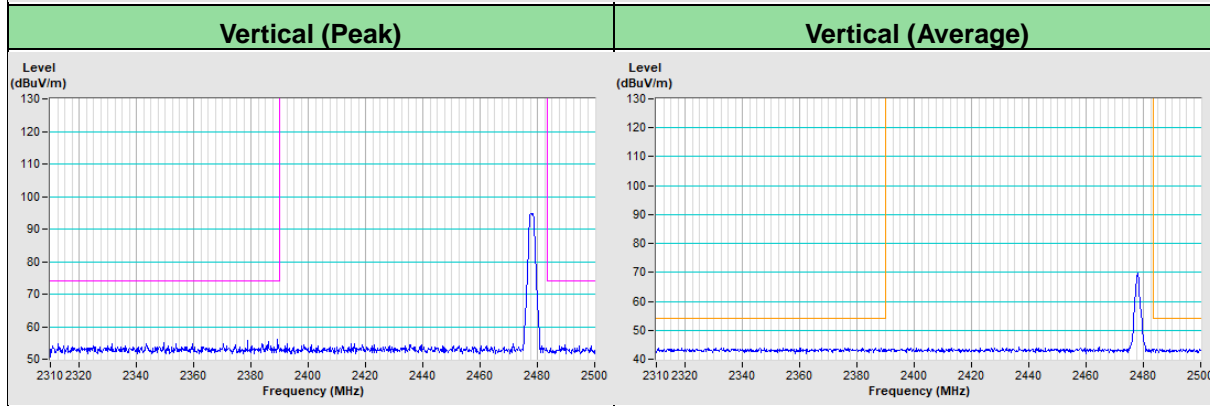
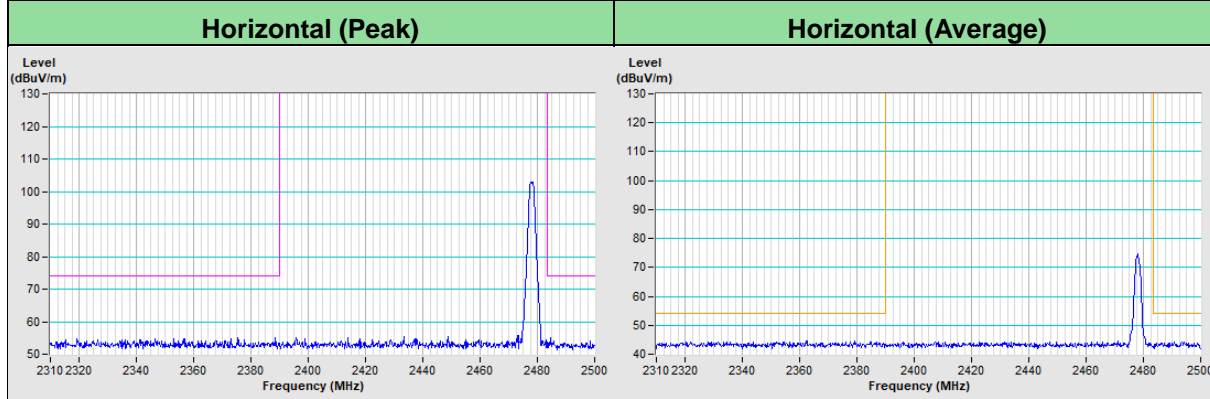

8 Pictures of Test Arrangements

Please refer to the attached file (Test Setup Photo)

9 Information of the Testing Laboratories

We, Bureau Veritas Consumer Products Services (H.K.) Ltd., Taoyuan Branch, were founded in 1988 to provide our best service in EMC, Radio, Telecom and Safety consultation. Our laboratories are FCC recognized accredited test firms and accredited according to ISO/IEC 17025.

If you have any comments, please feel free to contact us at the following:

Lin Kou EMC/RF Lab

Tel: 886-2-26052180

Fax: 886-2-26051924

Hsin Chu EMC/RF/Telecom Lab

Tel: 886-3-6668565

Fax: 886-3-6668323

Hwa Ya EMC/RF/Safety Lab

Tel: 886-3-3183232

Fax: 886-3-3270892

Email: service.adt@bureauveritas.com

Web Site: <http://ee.bureauveritas.com.tw>

The address and road map of all our labs can be found in our web site also.

--- END ---