

HARMONY EXPRESS

Setup Guide



logitech®

Languages

English.	3
Français	13
Español	23
Português	33

FPO

What's in the box

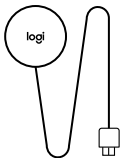
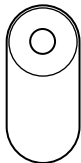

1. Harmony Express remote
2. Blaster
Controls devices via IR (infrared),
Bluetooth, and Wi-Fi
3. Power adapter
Powers your blaster
4. IR mini-blaster
Extends coverage of your blaster
5. USB cable
Charges your Harmony Express

Congratulations on purchasing Harmony Express

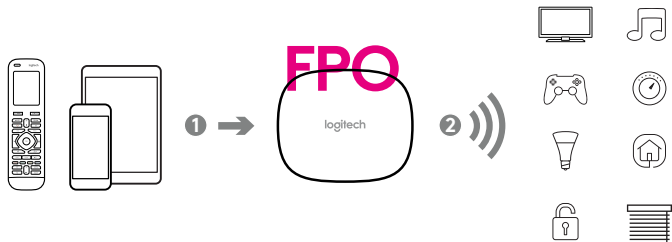

NOTE : Image showing that the blaster is the center of the Harmony system (Family Shot)

LET'S GET STARTED



NOTE : Image to show a mobile phone screen, Apple App store and Google Play store



Install the Harmony Express App

Visit the Apple App store or Google Play store and install the Harmony Express app. The HARMONY app does not support Harmony Express. Make sure you have downloaded the correct app for Harmony Express.

Launch the app and follow the instructions in-app for guided set-up.

Supported OS versions:

iOS : 10.0+

Android : 4.4+

Position the Harmony Express blaster and mini-blaster

The blaster receives commands from the remote and then sends the commands to your entertainment devices in the form of Bluetooth, Wi-Fi, and IR (infrared) signals*

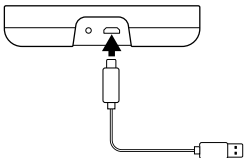

*Harmony Express needs the blaster to send and receive IR commands.
The Harmony Express remote cannot be used without the blaster set-up.

Once plugged in, the blaster takes approx. 30 seconds to power up. The LED will glow red when plugged in.

Use your mini-blaster to extend the range of the blaster. The mini-blaster can be placed where the blaster can't reach (for example, inside of a closed cabinet).

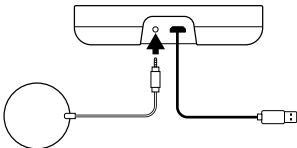

Connect your mini-blaster to the jack behind the blaster.



The blaster should be placed in an area where nothing is blocking its line of sight to your entertainment devices. If placed behind a closed cabinet door, you can use the mini-blaster to extend the blaster's coverage as shown in the example image.

Charge your remote



Plug in the USB cable to a wall adapter or any USB port and connect the other end to the remote's charging port. Keep the remote in charging mode until the setup is complete. The remote should be in the same room as your blaster to optimize communication between the remote and the blaster.

When the remote is in charging mode, the LED will turn white and pulse slowly.

HARMONY EXPRESS SETUP INSTRUCTIONS IN APP

You will be guided through the following steps within the mobile app:

NOTE : Illustrations similar to mobile app screens

Connecting the blaster to Wi-Fi

- Using your mobile device's Bluetooth

Creating or linking your Harmony account

- If you're a new user, you'll be automatically asked to login via your Amazon account.
- For more details on creating an Amazon account or choosing one, please see the following link:
<https://support.myharmony.com/en-us/accountcreation>

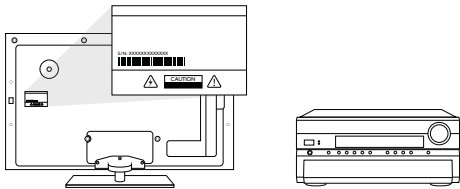

If you're an existing Harmony user, you can login with your Harmony account.

Creating or linking your Amazon Alexa account

Selecting your room

- Harmony Express allows you to control one entertainment stack in a room

Adding your TV

- Guidance on linking your main entertainment source

Adding other devices such as:

- Set top box

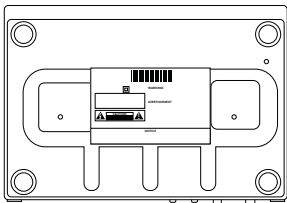

- For an AVR
- For a BlueRay/DVD player

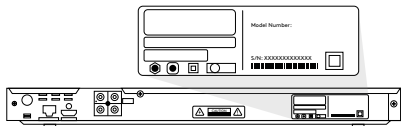

- For all other devices and wall-mounted TVs, please follow the below link for more information:
<https://support.myharmony.com/en-us/finding-your-devices-model-number>

Dragging and dropping devices to your inputs

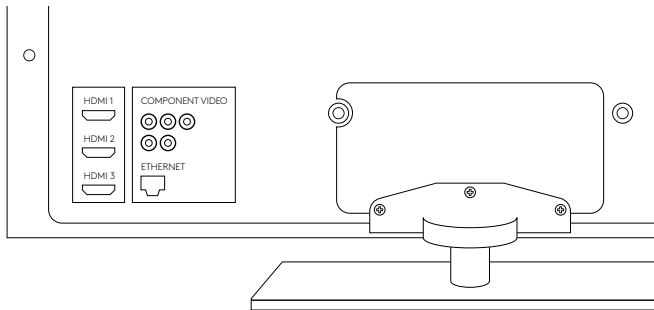

- How to check what devices are connected to what inputs

Validating your setup

HOW TO USE YOUR REMOTE?

NOTE : Image pressing Voice Button and saying "Turn on my TV"

Image explaining during STB and Streaming boxes

STB : Back, SB : Back

STB : Guide, SB : Home

STB : Menu, SB : Menu

Image for buttons and associations

LED states of remote and blaster

Harmony Express Remote

State	LED Color
System error	Orange continually blinking
Listening	Cyan
Stop listening	
Thinking	Cyan and blue alternating slow blink
Speaking	Cyan slow blink
Charging	White slow blink
Wi-Fi Connection lost	White
Internet Connection lost	Orange continually blinking
Remote-blaster out of range	Orange continually blinking
Firmware update	White rapid pulse, solid white upon completion
Find my remote	White blinking
Low battery	Red blinking
Critical battery	Red continually flashing when any button is pressed
Fully charged	White
Initial wake up	White fade-out
Initial setup	White fade-up
Attempt push to talk during critical or closed function	Orange from any current state
Remote looking for blaster	White slow pulse

For more details, please visit <link>

VOICE COMMANDS

“Turn on TV”

“**Turn on TV**” will start your TV (including Apple TV, Roku, etc..). Harmony will power on your AVR and set-top box then set their inputs.

“Launch Netflix”

Turn everything off by saying “**Turn off the TV.**”

“**Launch Netflix**” (or other apps, Hulu, etc.)

You can directly launch Netflix, just by saying this or “**Launch Netflix**”

Harmony Express takes care of turning on necessary devices such as TV, AVR, Streaming box, changes to the right inputs and launches the required app.

Supported Devices:

- Apple TV
- Fire TV
- Roku, Android TV
- Samsung TV
- LG
- Sony Android TV

For all other devices, please visit <link>

“Go to HBO”

You can change to any channel with the **“Go to”** command.

Harmony Express takes care of tuning to the right channel on cable and/or satellite TV.

For other voice commands, please visit <link>

OTHER AMAZON ALEXA FUNCTIONS



In addition to the entertainment control you get with Harmony Express, you get all the benefits of Amazon Alexa built-in.

You can ask Amazon Alexa via Harmony Express:

- “What’s the weather now?”
- “Tell me a joke”
- “How far is New York from San Francisco?”

You can also use the Amazon Alexa app to set up your smart home controls, like Sonos.

Once you have completed set up in the Amazon Alexa app, you can turn on or off any of your smart control devices that Amazon Alexa supports. Hold the center button and say:

- “Turn on my lights”

- "Set my temperature to 70 degrees"
- "Order pizza"

NOTE: Harmony Express doesn't support streaming music on remote and making calls.

BEST PRACTICES

The blaster is the center of your Harmony setup – **always keep it powered on.** Charge your remote when you see the low battery warning.

To stop Harmony Express from going out of sync with your devices:

- Do not use old remotes for your devices.
- Do not manually power on or off your devices.

TIPS AND TROUBLESHOOTING

Tips:

- Always keep the blaster powered on using your ac adapter.
- If the light around the voice button is blinking red charge your remote.
- Using original remotes and or manually turning devices on and off can cause the Harmony Express to be out of sync. We recommend to only use the Harmony Express for everyday use.
- As the blasters and mini blasters can shift out of place, it is important to make sure they are put back in the original position.

Troubleshooting:

6. Devices are not turning or setting to the correct input when I press the Voice button and give the remote instructions.

Just say "Start Harmony Help" and you will be guided with voice assistance to resolve your issue.

7. I need to make a change to device(s) or the way the cables were setup.
Open your Harmony Express App
Go to Edit Setup
8. I am getting an error message on the Harmony Express app while I am in Setup. Check for the following:

blaster is plugged in

remote is plugged in and being charged

unplug and replug in the blaster try again after 30 seconds

force close the Harmony Express app and re-launch the app

verify if your mobile device is connected to Wifi and Internet

9. My remote is not working

Check for the following:

if the light ring is blinking red, the remote needs to be charged until it turns solid white, however while plugged in the remote can be operational.

If the blaster is displaying red, go to the Harmony Express App.....

unplug and replug in the blaster try again after 30 seconds

10. Voice commands are not working or I am getting an error message from the remote.

Use the Harmony Express Insert Card to see for voice commands that should work

Unplug and plug in the blaster and try again after 30 seconds

????

CONTACT US

NEED HELP? Please check the contact details from the below link.

www.logitech.com/support/harmony-express

© 2017 Logitech. Logitech, Logi and other Logitech marks are owned by Logitech and may be registered. All other trademarks are the property of their respective owners. All other trademarks are the property of their respective owners. Logitech assumes no responsibility for any errors that may appear in this manual. Information contained herein is subject to change without notice.

620-008536.00A