

FCC Test Report (WLAN)

Report No.: RF180928E04-1

FCC ID: JNZNR0017

Test Model: N-R0017

Received Date: Sep. 28, 2018

Test Date: Oct. 06 to 20, 2018

Issued Date: Jan. 14, 2019

Applicant: LOGITECH FAR EAST LTD.

Address: #2 Creation Rd. 4, Science-Based Ind. Park Hsinchu Taiwan, R.O.C.

Issued By: Bureau Veritas Consumer Products Services (H.K.) Ltd., Taoyuan Branch
Hsin Chu Laboratory

Lab Address: E-2, No.1, Li Hsin 1st Road, Hsinchu Science Park, Hsinchu City 300,
Taiwan R.O.C.

Test Location: E-2, No.1, Li Hsin 1st Road, Hsinchu Science Park, Hsinchu City 300,
Taiwan R.O.C.

**FCC Registration /
Designation Number:** 723255 / TW2022



This report is for your exclusive use. Any copying or replication of this report to or for any other person or entity, or use of our name or trademark, is permitted only with our prior written permission. This report sets forth our findings solely with respect to the test samples identified herein. The results set forth in this report are not indicative or representative of the quality or characteristics of the lot from which a test sample was taken or any similar or identical product unless specifically and expressly noted. Our report includes all of the tests requested by you and the results thereof based upon the information that you provided to us. You have 60 days from date of issuance of this report to notify us of any material error or omission caused by our negligence, provided, however, that such notice shall be in writing and shall specifically address the issue you wish to raise. A failure to raise such issue within the prescribed time shall constitute your unqualified acceptance of the completeness of this report, the tests conducted and the correctness of the report contents. Unless specific mention, the uncertainty of measurement has been explicitly taken into account to declare the compliance or non-compliance to the specification. The report must not be used by the client to claim product certification, approval, or endorsement by TAF or any government agencies.

Table of Contents

Release Control Record	4
1 Certificate of Conformity	5
2 Summary of Test Results	6
2.1 Measurement Uncertainty.....	6
2.2 Modification Record.....	6
3 General Information	7
3.1 General Description of EUT (WLAN).....	7
3.2 Description of Test Modes.....	9
3.2.1 Test Mode Applicability and Tested Channel Detail.....	11
3.3 Duty Cycle of Test Signal.....	13
3.4 Description of Support Units.....	14
3.4.1 Configuration of System under Test.....	14
3.5 General Description of Applied Standard.....	15
4 Test Types and Results	16
4.1 Radiated Emission and Bandedge Measurement.....	16
4.1.1 Limits of Radiated Emission and Bandedge Measurement.....	16
4.1.2 Test Instruments.....	17
4.1.3 Test Procedure.....	18
4.1.4 Deviation from Test Standard.....	18
4.1.5 Test Setup.....	19
4.1.6 EUT Operating Condition.....	20
4.1.7 Test Results.....	21
4.2 Conducted Emission Measurement.....	61
4.2.1 Limits of Conducted Emission Measurement.....	61
4.2.2 Test Instruments.....	61
4.2.3 Test Procedure.....	62
4.2.4 Deviation from Test Standard.....	62
4.2.5 Test Setup.....	62
4.2.6 EUT Operating Condition.....	62
4.2.7 Test Results.....	63
4.3 Transmit Power Measurement.....	65
4.3.1 Limits of Transmit Power Measurement.....	65
4.3.2 Test Setup.....	65
4.3.3 Test Instruments.....	65
4.3.4 Test Procedure.....	66
4.3.5 Deviation from Test Standard.....	66
4.3.6 EUT Operating Condition.....	66
4.3.7 Test Results.....	67
4.4 Occupied Bandwidth Measurement.....	72
4.4.1 Test Setup.....	72
4.4.2 Test Instruments.....	72
4.4.3 Test Procedure.....	72
4.4.4 Test Results.....	73
4.5 Peak Power Spectral Density Measurement.....	78
4.5.1 Limits of Peak Power Spectral Density Measurement.....	78
4.5.2 Test Setup.....	78
4.5.3 Test Instruments.....	78
4.5.4 Test Procedure.....	78
4.5.5 Deviation from Test Standard.....	79
4.5.6 EUT Operating Condition.....	79
4.5.7 Test Results.....	80
4.6 Frequency Stability Measurement.....	85
4.6.1 Limits of Frequency Stability Measurement.....	85

4.6.2	Test Setup.....	85
4.6.3	Test Instruments	85
4.6.4	Test Procedure	85
4.6.5	Deviation from Test Standard	85
4.6.6	EUT Operating Condition	85
4.6.7	Test Results	86
4.7	6dB Bandwidth Measurement.....	87
4.7.1	Limits of 6dB Bandwidth Measurement.....	87
4.7.2	Test Setup.....	87
4.7.3	Test Instruments	87
4.7.4	Test Procedure	87
4.7.5	Deviation from Test Standard	87
4.7.6	EUT Operating Condition	87
4.7.7	Test Results	88
5	Pictures of Test Arrangements.....	90
	Annex A- Radiated Out of Band Emission (OOBE) Measurement (For U-NII-3 band).....	91
	Appendix – Information on the Testing Laboratories	94

Release Control Record

Issue No.	Description	Date Issued
RF180928E04-1	Original release.	Jan. 14, 2019

1 Certificate of Conformity

Product: Universal hub
Brand: Logitech
Test Model: N-R0017
Sample Status: ENGINEERING SAMPLE
Applicant: LOGITECH FAR EAST LTD.
Test Date: Oct. 06 to 20, 2018
Standard: 47 CFR FCC Part 15, Subpart E (Section 15.407)
ANSI C63.10: 2013

The above equipment has been tested by **Bureau Veritas Consumer Products Services (H.K.) Ltd., Taoyuan Branch**, and found compliance with the requirement of the above standards. The test record, data evaluation & Equipment Under Test (EUT) configurations represented herein are true and accurate accounts of the measurements of the sample's EMC characteristics under the conditions specified in this report.

Prepared by : Phoenix Huang, **Date:** Jan. 14, 2019
Phoenix Huang / Specialist

Approved by : May Chen, **Date:** Jan. 14, 2019
May Chen / Manager

2 Summary of Test Results

47 CFR FCC Part 15, Subpart E (Section 15.407)			
FCC Clause	Test Item	Result	Remarks
15.407(b)(6)	AC Power Conducted Emissions	Pass	Meet the requirement of limit. Minimum passing margin is -4.22dB at 0.56647MHz.
15.407(b) (1/2/3/4(i/ii)/6)	Radiated Emissions & Band Edge Measurement*	Pass	Meet the requirement of limit. Minimum passing margin is -3.1dB at 5150.00MHz, 5470.00MHz and 5725.00MHz.
15.407(a)(1/2/3)	Max Average Transmit Power	Pass	Meet the requirement of limit.
---	Occupied Bandwidth Measurement	-	Reference only.
15.407(a)(1/2/3)	Peak Power Spectral Density	Pass	Meet the requirement of limit.
15.407(e)	6dB bandwidth	Pass	Meet the requirement of limit. (U-NII-3 Band only)
15.407(g)	Frequency Stability	Pass	Meet the requirement of limit.
15.203	Antenna Requirement	Pass	No antenna connector is used.

*For U-NII-3 band compliance with rule part 15.407(b)(4)(i), the OOB test plots were recorded in Annex A.

2.1 Measurement Uncertainty

Where relevant, the following measurement uncertainty levels have been estimated for tests performed on the EUT as specified in CISPR 16-4-2:

Measurement	Frequency	Expanded Uncertainty (k=2) (\pm)
Conducted Emissions at mains ports	150kHz ~ 30MHz	1.84 dB
Radiated Emissions up to 1 GHz	30MHz ~ 1GHz	5.53 dB
Radiated Emissions above 1 GHz	1GHz ~ 6GHz	5.08 dB
	6GHz ~ 18GHz	4.98 dB
	18GHz ~ 40GHz	5.19 dB

2.2 Modification Record

There were no modifications required for compliance.

3 General Information

3.1 General Description of EUT (WLAN)

Product	Universal hub
PMN	Harmony Express
Brand	Logitech
Test Model	N-R0017
Status of EUT	ENGINEERING SAMPLE
Power Supply Rating	5Vdc from power adapter
Modulation Type	CCK, DQPSK, DBPSK for DSSS 64QAM, 16QAM, QPSK, BPSK for OFDM 256QAM for OFDM in 11ac mode only
Modulation Technology	DSSS, OFDM
Transfer Rate	802.11b: up to 11Mbps 802.11a/g: up to 54Mbps 802.11n: up to 150Mbps 802.11ac: up to 433.3Mbps
Operating Frequency	2.4GHz: 2.412 ~ 2.462GHz 5GHz: 5.18 ~ 5.24GHz, 5.26 ~ 5.32GHz, 5.5 ~ 5.7GHz, 5.745 ~ 5.825GHz
Number of Channel	2.4GHz: 802.11b, 802.11g, 802.11n (HT20): 11 802.11n (HT40): 7 5GHz: 802.11a, 802.11n (HT20), 802.11ac (VHT20): 24 802.11n (HT40), 802.11ac (VHT40): 11 802.11ac (VHT80): 5
Output Power	2.412 ~ 2.462GHz: 242.103mW 5.18 ~ 5.24GHz: 30.409mW 5.26 ~ 5.32GHz: 29.107mW 5.5 ~ 5.7GHz: 37.931mW 5.745 ~ 5.825GHz: 36.392mW
Antenna Type	Refer to Note
Antenna Connector	Refer to Note
Accessory Device	Adapter x1 IR x1
Data Cable Supplied	IR Cable x1 (Unshielded, 2m)

Note:

1. The EUT may have a lot of colors for marketing requirement.
2. Simultaneously transmission condition. (2.4G/5G WLAN can't transmission simultaneously)

Condition	Technology	
1	WLAN(2.4GHz)	Bluetooth
2	WLAN(5GHz)	Bluetooth

Note: The emission of the simultaneous operation has been evaluated and no non-compliance was found.

3. The EUT must be supplied with a power adapter as following table:

Brand	Model No.	Spec.
Blue Iron Holdings Limited	BI12T-050150-BdU	Input: 100-240Vac, 0.5A, 50/60Hz Output: 5Vdc, 1.5A DC output cable: Unshielded, 2m

4. The antennas provided to the EUT, please refer to the following table:

Transmitter Circuit	Antenna Gain with cable loss (dBi)	Frequency range (GHz)	Antenna Type	Antenna Connector
Chain 0	3.5	2.4~2.4835	Monopole (PCB)	NA
	3.8	5.15~5.35		
	4	5.5~5.85		
Chain 1	2.9	2.4~2.4835	Monopole (PCB)	NA
	3	5.15~5.35		
	4.5	5.5~5.85		

Note: Max. gain was selected for the final test.

5. The EUT incorporates a SISO function:

2.4GHz Band			
MODULATION MODE	DATA RATE (MCS)	TX & RX CONFIGURATION	
802.11b	1 ~ 11Mbps	1TX (Diversity)	1RX
802.11g	6 ~ 54Mbps	1TX (Diversity)	1RX
802.11n (HT20)	MCS 0~7	1TX (Diversity)	1RX
802.11n (HT40)	MCS 0~7	1TX (Diversity)	1RX
5GHz Band			
MODULATION MODE	DATA RATE (MCS)	TX & RX CONFIGURATION	
802.11a	6 ~ 54Mbps	1TX (Diversity)	1RX
802.11n (HT20)	MCS 0~7	1TX (Diversity)	1RX
802.11n (HT40)	MCS 0~7	1TX (Diversity)	1RX
802.11ac (VHT20)	MCS0~8 Nss=1	1TX (Diversity)	1RX
802.11ac (VHT40)	MCS0~9 Nss=1	1TX (Diversity)	1RX
802.11ac (VHT80)	MCS0~9 Nss=1	1TX (Diversity)	1RX

Note: The modulation and bandwidth are similar for 802.11n mode for 20MHz (40MHz) and 802.11ac mode for 20MHz (40MHz), therefore investigated worst case to representative mode in test report. (Final test mode refer section 3.2.1)

6. The above EUT information is declared by manufacturer and for more detailed features description, please refers to the manufacturer's specifications or user's manual.

3.2 Description of Test Modes

FOR 5180 ~ 5240MHz

4 channels are provided for 802.11a, 802.11n (HT20), 802.11ac (VHT20):

Channel	Frequency	Channel	Frequency
36	5180 MHz	44	5220 MHz
40	5200 MHz	48	5240 MHz

2 channels are provided for 802.11n (HT40), 802.11ac (VHT40):

Channel	Frequency	Channel	Frequency
38	5190 MHz	46	5230 MHz

1 channel is provided for 802.11ac (VHT80):

Channel	Frequency
42	5210 MHz

FOR 5260 ~ 5320MHz

4 channels are provided for 802.11a, 802.11n (HT20), 802.11ac (VHT20):

Channel	Frequency	Channel	Frequency
52	5260 MHz	60	5300 MHz
56	5280 MHz	64	5320 MHz

2 channels are provided for 802.11n (HT40), 802.11ac (VHT40):

Channel	Frequency	Channel	Frequency
54	5270 MHz	62	5310 MHz

1 channel is provided for 802.11ac (VHT80):

Channel	Frequency
58	5290 MHz

FOR 5500 ~ 5700MHz

11 channels are provided for 802.11a, 802.11n (HT20), 802.11ac (VHT20):

Channel	Frequency	Channel	Frequency
100	5500 MHz	124	5620 MHz
104	5520 MHz	128	5640 MHz
108	5540 MHz	132	5660 MHz
112	5560 MHz	136	5680 MHz
116	5580 MHz	140	5700 MHz
120	5600 MHz		

5 channels are provided for 802.11n (HT40), 802.11ac (VHT40):

Channel	Frequency	Channel	Frequency
102	5510 MHz	126	5630 MHz
110	5550 MHz	134	5670 MHz
118	5590 MHz		

2 channels are provided for 802.11ac (VHT80):

Channel	Frequency	Channel	Frequency
106	5530 MHz	122	5610 MHz

FOR 5745 ~ 5825MHz:

5 channels are provided for 802.11a, 802.11n (HT20), 802.11ac (VHT20):

Channel	Frequency	Channel	Frequency
149	5745 MHz	161	5805 MHz
153	5765 MHz	165	5825 MHz
157	5785 MHz		

2 channels are provided for 802.11n (HT40), 802.11ac (VHT40):

Channel	Frequency	Channel	Frequency
151	5755 MHz	159	5795 MHz

1 channel is provided for 802.11ac (VHT80):

Channel	Frequency
155	5775 MHz

3.2.1 Test Mode Applicability and Tested Channel Detail

EUT Configure Mode	Applicable To				Description
	RE \geq 1G	RE<1G	PLC	APCM	
-	√	√	√	√	-

Where **RE \geq 1G**: Radiated Emission above 1GHz **RE<1G**: Radiated Emission below 1GHz
PLC: Power Line Conducted Emission **APCM**: Antenna Port Conducted Measurement

Radiated Emission Test (Above 1GHz):

- Pre-Scan has been conducted to determine the worst-case mode from all possible combinations between available modulations, data rates and antenna ports (if EUT with antenna diversity architecture).
- Following channel(s) was (were) selected for the final test as listed below.

Mode	FREQ. Band (MHz)	Available Channel	Tested Channel	Modulation Technology	Modulation Type	Data Rate (Mbps)
802.11a	5180-5240	36 to 48	36, 40, 48	OFDM	BPSK	6
802.11ac (VHT20)		36 to 48	36, 40, 48	OFDM	BPSK	6.5
802.11ac (VHT40)		38 to 46	38, 46	OFDM	BPSK	13.5
802.11ac (VHT80)		42	42	OFDM	BPSK	29.3
802.11a	5260-5320	52 to 64	52, 60, 64	OFDM	BPSK	6
802.11ac (VHT20)		52 to 64	52, 60, 64	OFDM	BPSK	6.5
802.11ac (VHT40)		54 to 62	54, 62	OFDM	BPSK	13.5
802.11ac (VHT80)		58	58	OFDM	BPSK	29.3
802.11a	5500-5700	100 to 140	100, 116, 140	OFDM	BPSK	6
802.11ac (VHT20)		100 to 140	100, 116, 140	OFDM	BPSK	6.5
802.11ac (VHT40)		102 to 134	102, 110, 134	OFDM	BPSK	13.5
802.11ac (VHT80)		106, 122	106, 122	OFDM	BPSK	29.3
802.11a	5745-5825	149 to 165	149, 157, 165	OFDM	BPSK	6
802.11ac (VHT20)		149 to 165	149, 157, 165	OFDM	BPSK	6.5
802.11ac (VHT40)		151 to 159	151, 159	OFDM	BPSK	13.5
802.11ac (VHT80)		155	155	OFDM	BPSK	29.3

Radiated Emission Test (Below 1GHz):

- Pre-Scan has been conducted to determine the worst-case mode from all possible combinations between available modulations, data rates and antenna ports (if EUT with antenna diversity architecture).
- Following channel(s) was (were) selected for the final test as listed below.

Mode	FREQ. Band (MHz)	Available Channel	Tested Channel	Modulation Technology	Modulation Type	Data Rate (Mbps)
802.11a	5180-5320, 5500-5700, 5745-5825	36 to 64, 100 to 140, 149 to 165	116	OFDM	BPSK	6

Power Line Conducted Emission Test:

- Pre-Scan has been conducted to determine the worst-case mode from all possible combinations between available modulations, data rates and antenna ports (if EUT with antenna diversity architecture).
- Following channel(s) was (were) selected for the final test as listed below.

Mode	FREQ. Band (MHz)	Available Channel	Tested Channel	Modulation Technology	Modulation Type	Data Rate (Mbps)
802.11a	5180-5320, 5500-5700, 5745-5825	36 to 64, 100 to 140, 149 to 165	116	OFDM	BPSK	6

Antenna Port Conducted Measurement:

- This item includes all test value of each mode, but only includes spectrum plot of worst value of each mode.
- Pre-Scan has been conducted to determine the worst-case mode from all possible combinations between available modulations, data rates and antenna ports (if EUT with antenna diversity architecture).
- Following channel(s) was (were) selected for the final test as listed below.

Mode	FREQ. Band (MHz)	Available Channel	Tested Channel	Modulation Technology	Modulation Type	Data Rate (Mbps)
802.11a	5180-5240	36 to 48	36, 40, 48	OFDM	BPSK	6
802.11ac (VHT20)		36 to 48	36, 40, 48	OFDM	BPSK	6.5
802.11ac (VHT40)		38 to 46	38, 46	OFDM	BPSK	13.5
802.11ac (VHT80)		42	42	OFDM	BPSK	29.3
802.11a	5260-5320	52 to 64	52, 60, 64	OFDM	BPSK	6
802.11ac (VHT20)		52 to 64	52, 60, 64	OFDM	BPSK	6.5
802.11ac (VHT40)		54 to 62	54, 62	OFDM	BPSK	13.5
802.11ac (VHT80)		58	58	OFDM	BPSK	29.3
802.11a	5500-5700	100 to 140	100, 116, 140	OFDM	BPSK	6
802.11ac (VHT20)		100 to 140	100, 116, 140	OFDM	BPSK	6.5
802.11ac (VHT40)		102 to 134	102, 110, 134	OFDM	BPSK	13.5
802.11ac (VHT80)		106, 122	106, 122	OFDM	BPSK	29.3
802.11a	5745-5825	149 to 165	149, 157, 165	OFDM	BPSK	6
802.11ac (VHT20)		149 to 165	149, 157, 165	OFDM	BPSK	6.5
802.11ac (VHT40)		151 to 159	151, 159	OFDM	BPSK	13.5
802.11ac (VHT80)		155	155	OFDM	BPSK	29.3

Test Condition:

Applicable To	Environmental Conditions	Input Power	Tested By
RE _≥ 1G	22deg. C, 65%RH	120Vac, 60Hz	Rey Chen
	23deg. C, 67%RH	120Vac, 60Hz	Andy Ho
RE _{<} 1G	23deg. C, 66%RH	120Vac, 60Hz	Frank Chuang
PLC	24deg. C, 76%RH	120Vac, 60Hz	Andy Ho
APCM	25deg. C, 60%RH	120Vac, 60Hz	Jyunchun Lin

3.3 Duty Cycle of Test Signal

If duty cycle of test signal is $\geq 98\%$, duty factor is not required.
 If duty cycle of test signal is $< 98\%$, duty factor shall be considered.

802.11a: Duty cycle = $2.062 \text{ ms} / 2.085 \text{ ms} = 0.989$

802.11ac (VHT20): Duty cycle = $1.93 \text{ ms} / 1.954 \text{ ms} = 0.988$

802.11ac (VHT40): Duty cycle = $0.953 \text{ ms} / 0.974 \text{ ms} = 0.978$, Duty factor = $10 * \log(1/\text{Duty cycle}) = 0.09$

802.11ac (VHT80): Duty cycle = $0.46 \text{ ms} / 0.482 \text{ ms} = 0.954$, Duty factor = $10 * \log(1/\text{Duty cycle}) = 0.2$

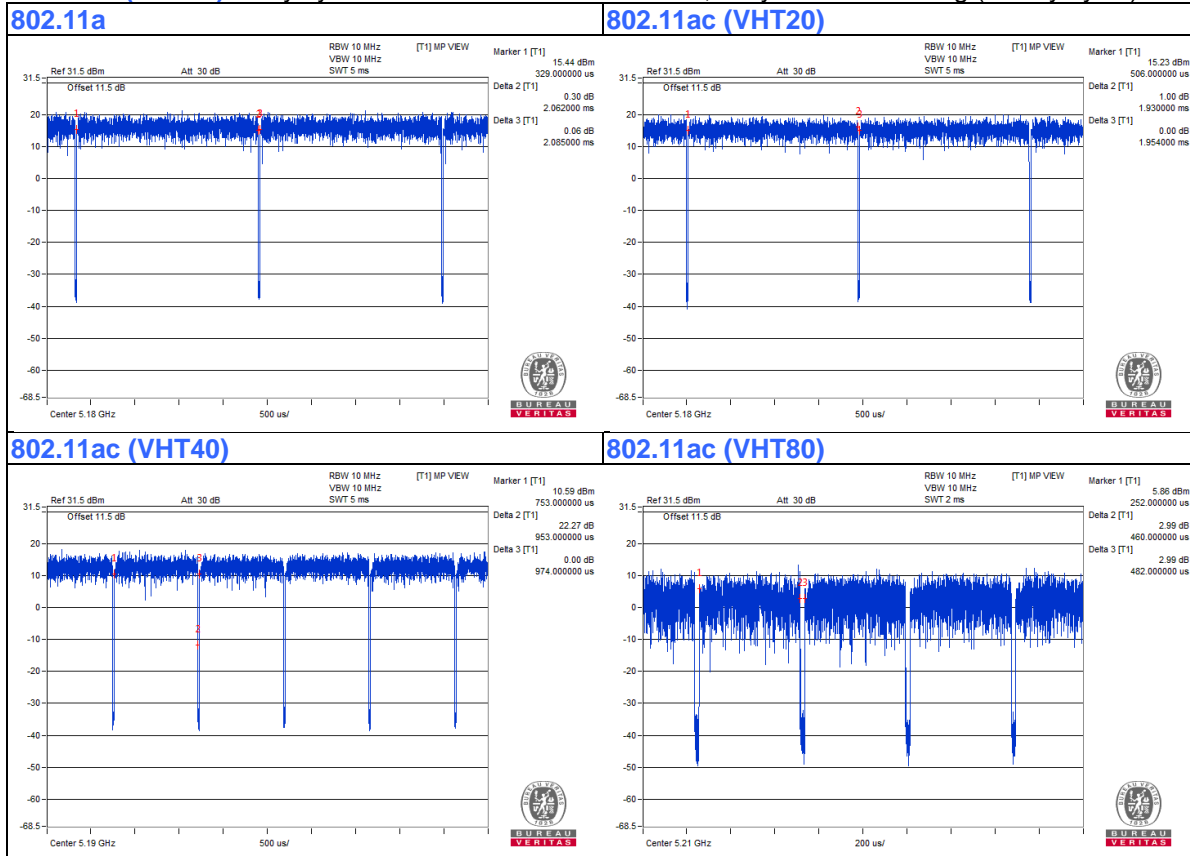

3.4 Description of Support Units

The EUT has been tested as an independent unit together with other necessary accessories or support units. The following support units or accessories were used to form a representative test configuration during the tests.

ID	Descriptions	Qty.	Length (m)	Shielding (Yes/No)	Cores (Qty.)	Remarks
1.	DC Cable	1	2	No	0	Supplied by client
2.	IR Cable	1	2	No	0	Supplied by client

3.4.1 Configuration of System under Test

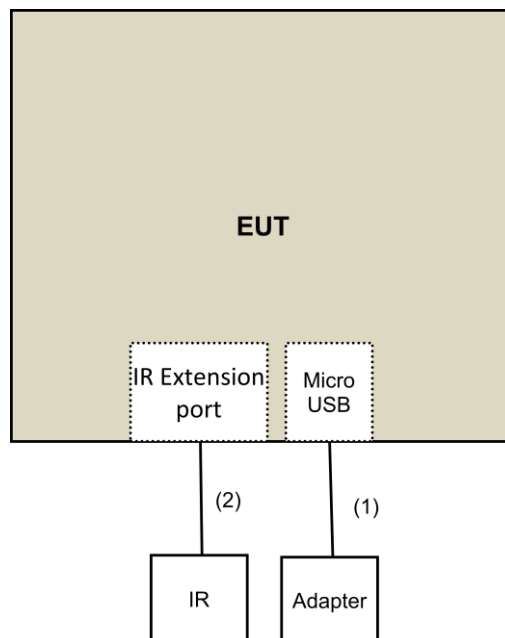

3.5 General Description of Applied Standard

The EUT is a RF Product. According to the specifications of the manufacturer, it must comply with the requirements of the following standards:

FCC Part 15, Subpart E (15.407)

KDB 789033 D02 General UNII Test Procedure New Rules v02r01

ANSI C63.10-2013

All test items have been performed and recorded as per the above standards.

4 Test Types and Results

4.1 Radiated Emission and Bandedge Measurement

4.1.1 Limits of Radiated Emission and Bandedge Measurement

Radiated emissions which fall in the restricted bands must comply with the radiated emission limits specified as below table.

Frequencies (MHz)	Field Strength (microvolts/meter)	Measurement Distance (meters)
0.009 ~ 0.490	2400/F(kHz)	300
0.490 ~ 1.705	24000/F(kHz)	30
1.705 ~ 30.0	30	30
30 ~ 88	100	3
88 ~ 216	150	3
216 ~ 960	200	3
Above 960	500	3

NOTE:

1. The lower limit shall apply at the transition frequencies.
2. Emission level (dBuV/m) = 20 log Emission level (uV/m).
3. For frequencies above 1000MHz, the field strength limits are based on average detector, however, the peak field strength of any emission shall not exceed the maximum permitted average limits, specified above by more than 20dB under any condition of modulation.

Limits of unwanted emission out of the restricted bands

Applicable To		Limit	
789033 D02 General UNII Test Procedure New Rules v02r01		Field Strength at 3m	
		PK:74 (dBuV/m)	AV:54 (dBuV/m)
Frequency Band	Applicable To	EIRP Limit	Equivalent Field Strength at 3m
5150~5250 MHz	15.407(b)(1)	PK:-27 (dBm/MHz)	PK:68.2(dBuV/m)
5250~5350 MHz	15.407(b)(2)		
5470~5725 MHz	15.407(b)(3)		
5725~5850 MHz	<input checked="" type="checkbox"/> 15.407(b)(4)(i)	PK:-27 (dBm/MHz) ^{*1} PK:10 (dBm/MHz) ^{*2} PK:15.6 (dBm/MHz) ^{*3} PK:27 (dBm/MHz) ^{*4}	PK: 68.2(dBuV/m) ^{*1} PK:105.2 (dBuV/m) ^{*2} PK: 110.8(dBuV/m) ^{*3} PK:122.2 (dBuV/m) ^{*4}
	<input type="checkbox"/> 15.407(b)(4)(ii)	Emission limits in section 15.247(d)	
^{*1} beyond 75 MHz or more above of the band edge. ^{*3} below the band edge increasing linearly to a level of 15.6 dBm/MHz at 5 MHz above.		^{*2} below the band edge increasing linearly to 10 dBm/MHz at 25 MHz above. ^{*4} from 5 MHz above or below the band edge increasing linearly to a level of 27 dBm/MHz at the band edge.	

Note:

The following formula is used to convert the equipment isotropic radiated power (eirp) to field strength:

$$E = \frac{1000000\sqrt{30P}}{3} \mu\text{V/m, where } P \text{ is the eirp (Watts).}$$

4.1.2 Test Instruments

DESCRIPTION & MANUFACTURER	MODEL NO.	SERIAL NO.	CALIBRATED DATE	CALIBRATED UNTIL
Test Receiver Agilent	N9038A	MY50010156	July 12, 2018	July 11, 2019
Pre-Amplifier EMCI	EMC001340	980142	Feb. 09, 2018	Feb. 08, 2019
Loop Antenna(*) Electro-Metrics	EM-6879	264	Dec. 16, 2016	Dec. 15, 2018
RF Cable	NA	LOOPCAB-001	Jan. 15, 2018	Jan. 14, 2019
RF Cable	NA	LOOPCAB-002	Jan. 15, 2018	Jan. 14, 2019
Pre-Amplifier Mini-Circuits	ZFL-1000VH2B	AMP-ZFL-05	May 05, 2018	May 04, 2019
Trilog Broadband Antenna SCHWARZBECK	VULB 9168	9168-361	Nov. 29, 2017	Nov. 28, 2018
RF Cable	8D	966-3-1	Mar. 20, 2018	Mar. 19, 2019
RF Cable	8D	966-3-2	Mar. 20, 2018	Mar. 19, 2019
RF Cable	8D	966-3-3	Mar. 20, 2018	Mar. 19, 2019
Fixed attenuator Mini-Circuits	UNAT-5+	PAD-3m-3-01	Sep. 27, 2018	Sep. 26, 2019
Horn_Antenna SCHWARZBECK	BBHA9120-D	9120D-406	Dec. 12, 2017	Dec. 11, 2018
Pre-Amplifier EMCI	EMC12630SE	980384	Jan. 29, 2018	Jan. 28, 2019
RF Cable	EMC104-SM-SM-1200	160922	Jan. 29, 2018	Jan. 28, 2019
RF Cable	EMC104-SM-SM-2000	150317	Jan. 29, 2018	Jan. 28, 2019
RF Cable	EMC104-SM-SM-5000	150322	Jan. 29, 2018	Jan. 28, 2019
Spectrum Analyzer Keysight	N9030A	MY54490679	July 23, 2018	July 22, 2019
Pre-Amplifier EMCI	EMC184045SE	980386	Jan. 29, 2018	Jan. 28, 2019
Horn_Antenna SCHWARZBECK	BBHA 9170	BBHA9170608	Dec. 14, 2017	Dec. 13, 2018
RF Cable	EMC102-KM-KM-1200	160924	Jan. 29, 2018	Jan. 28, 2019
Software	ADT_Radiated_V8.7.08	NA	NA	NA
Antenna Tower & Turn Table Max-Full	MF-7802	MF780208406	NA	NA
Boresight Antenna Fixture	FBA-01	FBA-SIP01	NA	NA
Spectrum Analyzer R&S	FSV40	100964	June 20, 2018	June 19, 2019
Power meter Anritsu	ML2495A	1014008	May 09, 2018	May 08, 2019
Power sensor Anritsu	MA2411B	0917122	May 09, 2018	May 08, 2019
AC Power Source Extech Electronics	6205	1440452	NA	NA
Temperature & Humidity Chamber Giant Force	GTH-150-40-SP-AR	MAA0812-008	Jan. 10, 2018	Jan. 09, 2019
True RMS Clamp Meter FLUKE	325	31130711WS	May 22, 2018	May 21, 2019

Note:

1. The calibration interval of the above test instruments is 12 months and the calibrations are traceable to NML/ROC and NIST/USA.
2. *The calibration interval of the above test instruments is 24 months and the calibrations are traceable to NML/ROC and NIST/USA.
3. The test was performed in 966 Chamber No. 3.
4. The CANADA Site Registration No. is 20331-1
5. Loop antenna was used for all emissions below 30 MHz.
6. Tested Date: Oct. 06 to 20, 2018

4.1.3 Test Procedure

For Radiated emission below 30MHz

- a. The EUT was placed on the top of a rotating table 0.8 meters above the ground at a 3 meter chamber room. The table was rotated 360 degrees to determine the position of the highest radiation.
- b. The EUT was set 3 meters away from the interference-receiving antenna, which was mounted on the top of a variable-height antenna tower.
- c. Parallel, perpendicular, and ground-parallel orientations of the antenna are set to make the measurement.
- d. For each suspected emission, the EUT was arranged to its worst case and the rotatable table was turned from 0 degrees to 360 degrees to find the maximum reading.
- e. The test-receiver system was set to Quasi-Peak Detect Function and Specified Bandwidth with Maximum Hold Mode.

Note:

1. The resolution bandwidth and video bandwidth of test receiver/spectrum analyzer is 9kHz at frequency below 30MHz.

For Radiated emission above 30MHz

- a. The EUT was placed on the top of a rotating table 0.8 meters (for 30MHz ~ 1GHz) / 1.5 meters (for above 1GHz) above the ground at 3 meter chamber room for test. The table was rotated 360 degrees to determine the position of the highest radiation.
- b. The EUT was set 3 meters away from the interference-receiving antenna, which was mounted on the top of a variable-height antenna tower.
- c. The height of antenna is varied from one meter to four meters above the ground to determine the maximum value of the field strength. Both horizontal and vertical polarizations of the antenna are set to make the measurement.
- d. For each suspected emission, the EUT was arranged to its worst case and then the antenna was tuned to heights from 1 meter to 4 meters and the rotatable table was turned from 0 degrees to 360 degrees to find the maximum reading.
- e. The test-receiver system was set to quasi-peak detect function and specified bandwidth with maximum hold mode when the test frequency is below 1 GHz.
- f. The test-receiver system was set to peak and average detects function and specified bandwidth with maximum hold mode when the test frequency is above 1 GHz. If the peak reading value also meets average limit, measurement with the average detector is unnecessary.

Note:

1. The resolution bandwidth and video bandwidth of test receiver/spectrum analyzer is 120kHz for Quasi-peak detection (QP) at frequency below 1GHz.
2. The resolution bandwidth of test receiver/spectrum analyzer is 1 MHz and the video bandwidth is 3 MHz for Peak detection (PK) at frequency above 1GHz.
3. The resolution bandwidth of test receiver/spectrum analyzer is 1MHz and the video bandwidth is $\geq 1/T$ (Duty cycle $< 98\%$) or 10Hz (Duty cycle $\geq 98\%$) for Average detection (AV) at frequency above 1GHz.
4. All modes of operation were investigated and the worst-case emissions are reported.

4.1.4 Deviation from Test Standard

No deviation.

4.1.5 Test Setup

For Radiated emission below 30MHz

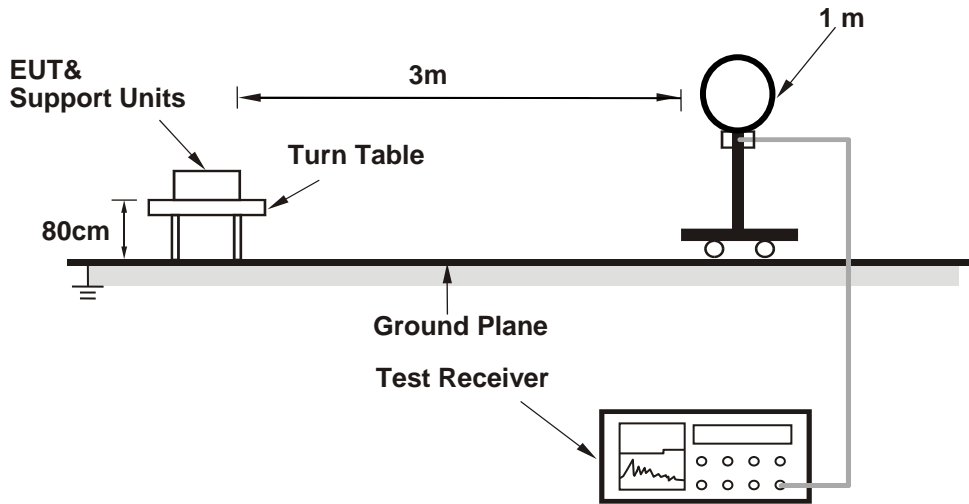

For Radiated emission 30MHz to 1GHz

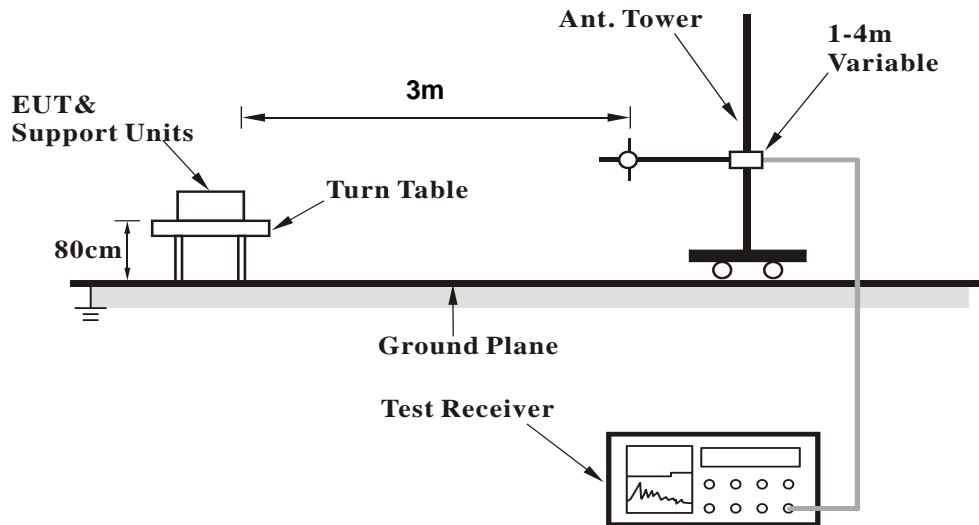

For Radiated emission above 1GHz

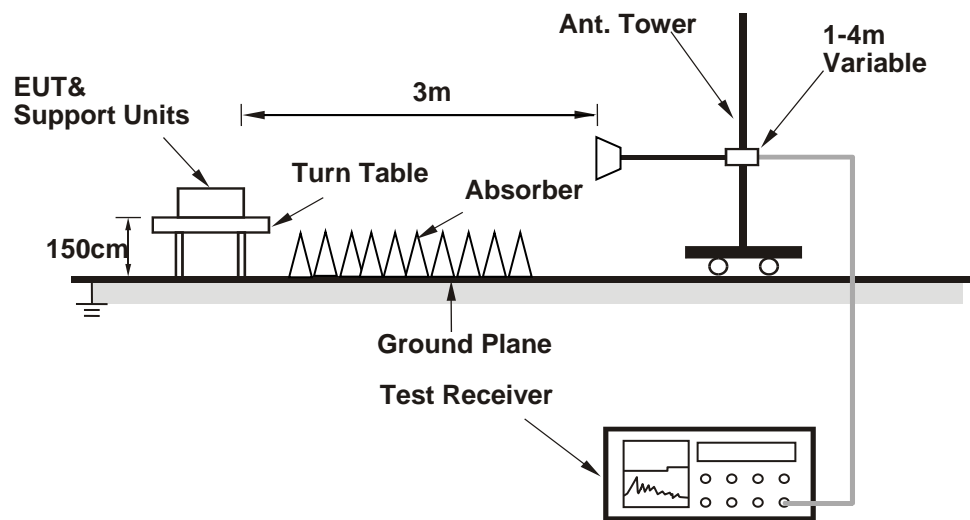

For the actual test configuration, please refer to the attached file (Test Setup Photo).

4.1.6 EUT Operating Condition

- a. Placed the EUT on the testing table.
- b. Controlling software (Pavarotti_HUB_Eng_Tool_1.9.exe) has been activated to set the EUT under transmission/receiving condition continuously.

4.1.7 Test Results

Above 1GHz Data:

802.11a

CHANNEL	TX Channel 36	DETECTOR FUNCTION	Peak (PK)
FREQUENCY RANGE	1GHz ~ 40GHz		Average (AV)

ANTENNA POLARITY & TEST DISTANCE: HORIZONTAL AT 3 M

NO.	FREQ. (MHz)	EMISSION LEVEL (dBuV/m)	LIMIT (dBuV/m)	MARGIN (dB)	ANTENNA HEIGHT (m)	TABLE ANGLE (Degree)	RAW VALUE (dBuV)	CORRECTION FACTOR (dB/m)
1	5150.00	66.2 PK	74.0	-7.8	1.04 H	219	63.6	2.6
2	5150.00	47.4 AV	54.0	-6.6	1.04 H	219	44.8	2.6
3	*5180.00	105.8 PK			1.04 H	219	103.3	2.5
4	*5180.00	96.1 AV			1.04 H	219	93.6	2.5
5	#10360.00	45.6 PK	68.2	-22.6	1.00 H	151	33.7	11.9
6	15540.00	46.5 PK	74.0	-27.5	1.00 H	143	34.1	12.4
7	15540.00	34.8 AV	54.0	-19.2	1.00 H	143	22.4	12.4

ANTENNA POLARITY & TEST DISTANCE: VERTICAL AT 3 M

NO.	FREQ. (MHz)	EMISSION LEVEL (dBuV/m)	LIMIT (dBuV/m)	MARGIN (dB)	ANTENNA HEIGHT (m)	TABLE ANGLE (Degree)	RAW VALUE (dBuV)	CORRECTION FACTOR (dB/m)
1	5150.00	60.5 PK	74.0	-13.5	1.33 V	51	57.9	2.6
2	5150.00	45.6 AV	54.0	-8.4	1.33 V	51	43.0	2.6
3	*5180.00	100.7 PK			1.33 V	51	98.2	2.5
4	*5180.00	90.9 AV			1.33 V	51	88.4	2.5
5	#10360.00	45.3 PK	68.2	-22.9	1.41 V	136	33.4	11.9
6	15540.00	47.0 PK	74.0	-27.0	1.55 V	257	34.6	12.4
7	15540.00	35.6 AV	54.0	-18.4	1.55 V	257	23.2	12.4

REMARKS:

1. Emission Level(dBuV/m) = Raw Value(dBuV) + Correction Factor(dB/m)
2. Correction Factor(dB/m) = Antenna Factor(dB/m) + Cable Factor(dB) – Pre-Amplifier Factor(dB)
3. The other emission levels were very low against the limit.
4. Margin value = Emission Level – Limit value
5. " * ": Fundamental frequency.
6. " # ": The radiated frequency is out of the restricted band.

CHANNEL	TX Channel 40	DETECTOR FUNCTION	Peak (PK)
FREQUENCY RANGE	1GHz ~ 40GHz		Average (AV)

ANTENNA POLARITY & TEST DISTANCE: HORIZONTAL AT 3 M

NO.	FREQ. (MHz)	EMISSION LEVEL (dBuV/m)	LIMIT (dBuV/m)	MARGIN (dB)	ANTENNA HEIGHT (m)	TABLE ANGLE (Degree)	RAW VALUE (dBuV)	CORRECTION FACTOR (dB/m)
1	5150.00	53.4 PK	74.0	-20.6	1.05 H	214	50.8	2.6
2	5150.00	40.2 AV	54.0	-13.8	1.05 H	214	37.6	2.6
3	*5200.00	107.4 PK			1.05 H	214	105.0	2.4
4	*5200.00	97.6 AV			1.05 H	214	95.2	2.4
5	#10400.00	44.9 PK	68.2	-23.3	1.00 H	165	32.7	12.2
6	15600.00	47.0 PK	74.0	-27.0	1.00 H	151	34.1	12.9
7	15600.00	35.3 AV	54.0	-18.7	1.00 H	151	22.4	12.9

ANTENNA POLARITY & TEST DISTANCE: VERTICAL AT 3 M

NO.	FREQ. (MHz)	EMISSION LEVEL (dBuV/m)	LIMIT (dBuV/m)	MARGIN (dB)	ANTENNA HEIGHT (m)	TABLE ANGLE (Degree)	RAW VALUE (dBuV)	CORRECTION FACTOR (dB/m)
1	5150.00	53.2 PK	74.0	-20.8	1.38 V	64	50.6	2.6
2	5150.00	40.1 AV	54.0	-13.9	1.38 V	64	37.5	2.6
3	*5200.00	101.1 PK			1.38 V	64	98.7	2.4
4	*5200.00	91.2 AV			1.38 V	64	88.8	2.4
5	#10400.00	45.2 PK	68.2	-23.0	1.43 V	142	33.0	12.2
6	15600.00	47.1 PK	74.0	-26.9	1.57 V	243	34.2	12.9
7	15600.00	35.5 AV	54.0	-18.5	1.57 V	243	22.6	12.9

REMARKS:

1. Emission Level(dBuV/m) = Raw Value(dBuV) + Correction Factor(dB/m)
2. Correction Factor(dB/m) = Antenna Factor(dB/m) + Cable Factor(dB) – Pre-Amplifier Factor(dB)
3. The other emission levels were very low against the limit.
4. Margin value = Emission Level – Limit value
5. " * ": Fundamental frequency.
6. " # ": The radiated frequency is out of the restricted band.

CHANNEL	TX Channel 48	DETECTOR FUNCTION	Peak (PK)
FREQUENCY RANGE	1GHz ~ 40GHz		Average (AV)

ANTENNA POLARITY & TEST DISTANCE: HORIZONTAL AT 3 M

NO.	FREQ. (MHz)	EMISSION LEVEL (dBuV/m)	LIMIT (dBuV/m)	MARGIN (dB)	ANTENNA HEIGHT (m)	TABLE ANGLE (Degree)	RAW VALUE (dBuV)	CORRECTION FACTOR (dB/m)
1	*5240.00	106.7 PK			1.18 H	185	104.5	2.2
2	*5240.00	97.2 AV			1.18 H	185	95.0	2.2
3	5350.00	49.2 PK	74.0	-24.8	1.18 H	185	46.9	2.3
4	5350.00	37.5 AV	54.0	-16.5	1.18 H	185	35.2	2.3
5	#10480.00	45.5 PK	68.2	-22.7	1.00 H	166	33.1	12.4
6	15720.00	47.1 PK	74.0	-26.9	1.00 H	129	35.1	12.0
7	15720.00	35.3 AV	54.0	-18.7	1.00 H	129	23.3	12.0

ANTENNA POLARITY & TEST DISTANCE: VERTICAL AT 3 M

NO.	FREQ. (MHz)	EMISSION LEVEL (dBuV/m)	LIMIT (dBuV/m)	MARGIN (dB)	ANTENNA HEIGHT (m)	TABLE ANGLE (Degree)	RAW VALUE (dBuV)	CORRECTION FACTOR (dB/m)
1	*5240.00	100.6 PK			1.37 V	50	98.4	2.2
2	*5240.00	91.1 AV			1.37 V	50	88.9	2.2
3	5350.00	49.1 PK	74.0	-24.9	1.37 V	50	46.8	2.3
4	5350.00	37.4 AV	54.0	-16.6	1.37 V	50	35.1	2.3
5	#10480.00	44.9 PK	68.2	-23.3	1.39 V	145	32.5	12.4
6	15720.00	47.7 PK	74.0	-26.3	1.54 V	267	35.7	12.0
7	15720.00	36.1 AV	54.0	-17.9	1.54 V	267	24.1	12.0

REMARKS:

1. Emission Level(dBuV/m) = Raw Value(dBuV) + Correction Factor(dB/m)
2. Correction Factor(dB/m) = Antenna Factor(dB/m) + Cable Factor(dB) – Pre-Amplifier Factor(dB)
3. The other emission levels were very low against the limit.
4. Margin value = Emission Level – Limit value
5. " * ": Fundamental frequency.
6. " # ": The radiated frequency is out of the restricted band.

CHANNEL	TX Channel 52	DETECTOR FUNCTION	Peak (PK)
FREQUENCY RANGE	1GHz ~ 40GHz		Average (AV)

ANTENNA POLARITY & TEST DISTANCE: HORIZONTAL AT 3 M

NO.	FREQ. (MHz)	EMISSION LEVEL (dBuV/m)	LIMIT (dBuV/m)	MARGIN (dB)	ANTENNA HEIGHT (m)	TABLE ANGLE (Degree)	RAW VALUE (dBuV)	CORRECTION FACTOR (dB/m)
1	5150.00	49.0 PK	74.0	-25.0	1.34 H	200	46.4	2.6
2	5150.00	36.5 AV	54.0	-17.5	1.34 H	200	33.9	2.6
3	*5260.00	106.9 PK			1.34 H	200	104.8	2.1
4	*5260.00	97.2 AV			1.34 H	200	95.1	2.1
5	#10520.00	45.6 PK	68.2	-22.6	1.00 H	167	33.2	12.4
6	15780.00	46.9 PK	74.0	-27.1	1.00 H	155	35.4	11.5
7	15780.00	35.2 AV	54.0	-18.8	1.00 H	155	23.7	11.5

ANTENNA POLARITY & TEST DISTANCE: VERTICAL AT 3 M

NO.	FREQ. (MHz)	EMISSION LEVEL (dBuV/m)	LIMIT (dBuV/m)	MARGIN (dB)	ANTENNA HEIGHT (m)	TABLE ANGLE (Degree)	RAW VALUE (dBuV)	CORRECTION FACTOR (dB/m)
1	5150.00	49.0 PK	74.0	-25.0	1.33 V	48	46.4	2.6
2	5150.00	36.4 AV	54.0	-17.6	1.33 V	48	33.8	2.6
3	*5260.00	100.5 PK			1.33 V	48	98.4	2.1
4	*5260.00	90.8 AV			1.33 V	48	88.7	2.1
5	#10520.00	45.3 PK	68.2	-22.9	1.36 V	122	32.9	12.4
6	15780.00	47.4 PK	74.0	-26.6	1.57 V	260	35.9	11.5
7	15780.00	36.0 AV	54.0	-18.0	1.57 V	260	24.5	11.5

REMARKS:

1. Emission Level(dBuV/m) = Raw Value(dBuV) + Correction Factor(dB/m)
2. Correction Factor(dB/m) = Antenna Factor(dB/m) + Cable Factor(dB) – Pre-Amplifier Factor(dB)
3. The other emission levels were very low against the limit.
4. Margin value = Emission Level – Limit value
5. " * ": Fundamental frequency.
6. " # ": The radiated frequency is out of the restricted band.

CHANNEL	TX Channel 60	DETECTOR FUNCTION	Peak (PK)
FREQUENCY RANGE	1GHz ~ 40GHz		Average (AV)

ANTENNA POLARITY & TEST DISTANCE: HORIZONTAL AT 3 M

NO.	FREQ. (MHz)	EMISSION LEVEL (dBuV/m)	LIMIT (dBuV/m)	MARGIN (dB)	ANTENNA HEIGHT (m)	TABLE ANGLE (Degree)	RAW VALUE (dBuV)	CORRECTION FACTOR (dB/m)
1	*5300.00	106.9 PK			1.02 H	210	104.7	2.2
2	*5300.00	97.2 AV			1.02 H	210	95.0	2.2
3	5350.00	60.2 PK	74.0	-13.8	1.02 H	210	57.9	2.3
4	5350.00	43.2 AV	54.0	-10.8	1.02 H	210	40.9	2.3
5	10600.00	45.6 PK	74.0	-28.4	1.50 H	146	33.9	11.7
6	10600.00	34.1 AV	54.0	-19.9	1.50 H	146	22.4	11.7
7	15900.00	47.3 PK	74.0	-26.7	1.33 H	252	36.1	11.2
8	15900.00	35.8 AV	54.0	-18.2	1.33 H	252	24.6	11.2

ANTENNA POLARITY & TEST DISTANCE: VERTICAL AT 3 M

NO.	FREQ. (MHz)	EMISSION LEVEL (dBuV/m)	LIMIT (dBuV/m)	MARGIN (dB)	ANTENNA HEIGHT (m)	TABLE ANGLE (Degree)	RAW VALUE (dBuV)	CORRECTION FACTOR (dB/m)
1	*5300.00	100.6 PK			1.27 V	53	98.4	2.2
2	*5300.00	90.7 AV			1.27 V	53	88.5	2.2
3	5350.00	58.8 PK	74.0	-15.2	1.27 V	53	56.5	2.3
4	5350.00	42.2 AV	54.0	-11.8	1.27 V	53	39.9	2.3
5	10600.00	45.4 PK	74.0	-28.6	1.42 V	142	33.7	11.7
6	10600.00	33.7 AV	54.0	-20.3	1.42 V	142	22.0	11.7
7	15900.00	46.5 PK	74.0	-27.5	1.56 V	255	35.3	11.2
8	15900.00	35.4 AV	54.0	-18.6	1.56 V	255	24.2	11.2

REMARKS:

1. Emission Level(dBuV/m) = Raw Value(dBuV) + Correction Factor(dB/m)
2. Correction Factor(dB/m) = Antenna Factor(dB/m) + Cable Factor(dB) – Pre-Amplifier Factor(dB)
3. The other emission levels were very low against the limit.
4. Margin value = Emission Level – Limit value
5. " * ": Fundamental frequency.

CHANNEL	TX Channel 64	DETECTOR FUNCTION	Peak (PK)
FREQUENCY RANGE	1GHz ~ 40GHz		Average (AV)

ANTENNA POLARITY & TEST DISTANCE: HORIZONTAL AT 3 M

NO.	FREQ. (MHz)	EMISSION LEVEL (dBuV/m)	LIMIT (dBuV/m)	MARGIN (dB)	ANTENNA HEIGHT (m)	TABLE ANGLE (Degree)	RAW VALUE (dBuV)	CORRECTION FACTOR (dB/m)
1	*5320.00	107.0 PK			1.38 H	177	104.7	2.3
2	*5320.00	97.1 AV			1.38 H	177	94.8	2.3
3	5350.00	63.8 PK	74.0	-10.2	1.38 H	177	61.5	2.3
4	5350.00	46.7 AV	54.0	-7.3	1.38 H	177	44.4	2.3
5	10640.00	45.9 PK	74.0	-28.1	1.46 H	142	34.2	11.7
6	10640.00	34.5 AV	54.0	-19.5	1.46 H	142	22.8	11.7
7	15960.00	46.5 PK	74.0	-27.5	1.37 H	242	35.1	11.4
8	15960.00	35.3 AV	54.0	-18.7	1.37 H	242	23.9	11.4

ANTENNA POLARITY & TEST DISTANCE: VERTICAL AT 3 M

NO.	FREQ. (MHz)	EMISSION LEVEL (dBuV/m)	LIMIT (dBuV/m)	MARGIN (dB)	ANTENNA HEIGHT (m)	TABLE ANGLE (Degree)	RAW VALUE (dBuV)	CORRECTION FACTOR (dB/m)
1	*5320.00	100.8 PK			1.33 V	51	98.5	2.3
2	*5320.00	91.1 AV			1.33 V	51	88.8	2.3
3	5350.00	60.2 PK	74.0	-13.8	1.33 V	51	57.9	2.3
4	5350.00	44.2 AV	54.0	-9.8	1.33 V	51	41.9	2.3
5	10640.00	45.8 PK	74.0	-28.2	1.45 V	138	34.1	11.7
6	10640.00	34.8 AV	54.0	-19.2	1.45 V	138	23.1	11.7
7	15960.00	47.3 PK	74.0	-26.7	1.50 V	241	35.9	11.4
8	15960.00	35.4 AV	54.0	-18.6	1.50 V	241	24.0	11.4

REMARKS:

1. Emission Level(dBuV/m) = Raw Value(dBuV) + Correction Factor(dB/m)
2. Correction Factor(dB/m) = Antenna Factor(dB/m) + Cable Factor(dB) – Pre-Amplifier Factor(dB)
3. The other emission levels were very low against the limit.
4. Margin value = Emission Level – Limit value
5. " * ": Fundamental frequency.

CHANNEL	TX Channel 100	DETECTOR FUNCTION	Peak (PK)
FREQUENCY RANGE	1GHz ~ 40GHz		Average (AV)

ANTENNA POLARITY & TEST DISTANCE: HORIZONTAL AT 3 M

NO.	FREQ. (MHz)	EMISSION LEVEL (dBuV/m)	LIMIT (dBuV/m)	MARGIN (dB)	ANTENNA HEIGHT (m)	TABLE ANGLE (Degree)	RAW VALUE (dBuV)	CORRECTION FACTOR (dB/m)
1	5460.00	58.4 PK	74.0	-15.6	1.11 H	48	55.8	2.6
2	5460.00	45.6 AV	54.0	-8.4	1.11 H	48	43.0	2.6
3	#5470.00	64.9 PK	68.2	-3.3	1.11 H	48	62.3	2.6
4	*5500.00	107.4 PK			1.11 H	48	104.9	2.5
5	*5500.00	99.4 AV			1.11 H	48	96.9	2.5
6	11000.00	48.2 PK	74.0	-25.8	1.46 H	162	36.0	12.2
7	11000.00	37.3 AV	54.0	-16.7	1.46 H	162	25.1	12.2
8	#16500.00	51.0 PK	68.2	-17.2	1.31 H	223	37.3	13.7

ANTENNA POLARITY & TEST DISTANCE: VERTICAL AT 3 M

NO.	FREQ. (MHz)	EMISSION LEVEL (dBuV/m)	LIMIT (dBuV/m)	MARGIN (dB)	ANTENNA HEIGHT (m)	TABLE ANGLE (Degree)	RAW VALUE (dBuV)	CORRECTION FACTOR (dB/m)
1	5460.00	57.6 PK	74.0	-16.4	2.94 V	360	55.0	2.6
2	5460.00	44.5 AV	54.0	-9.5	2.94 V	360	41.9	2.6
3	#5470.00	61.5 PK	68.2	-6.7	2.94 V	360	58.9	2.6
4	*5500.00	99.6 PK			2.94 V	360	97.1	2.5
5	*5500.00	89.8 AV			2.94 V	360	87.3	2.5
6	11000.00	48.5 PK	74.0	-25.5	1.62 V	163	36.3	12.2
7	11000.00	36.8 AV	54.0	-17.2	1.62 V	163	24.6	12.2
8	#16500.00	52.7 PK	68.2	-15.5	1.54 V	206	39.0	13.7

REMARKS:

1. Emission Level(dBuV/m) = Raw Value(dBuV) + Correction Factor(dB/m)
2. Correction Factor(dB/m) = Antenna Factor(dB/m) + Cable Factor(dB) – Pre-Amplifier Factor(dB)
3. The other emission levels were very low against the limit.
4. Margin value = Emission Level – Limit value
5. " * ": Fundamental frequency.
6. " # ": The radiated frequency is out of the restricted band.

CHANNEL	TX Channel 116	DETECTOR FUNCTION	Peak (PK)
FREQUENCY RANGE	1GHz ~ 40GHz		Average (AV)

ANTENNA POLARITY & TEST DISTANCE: HORIZONTAL AT 3 M

NO.	FREQ. (MHz)	EMISSION LEVEL (dBuV/m)	LIMIT (dBuV/m)	MARGIN (dB)	ANTENNA HEIGHT (m)	TABLE ANGLE (Degree)	RAW VALUE (dBuV)	CORRECTION FACTOR (dB/m)
1	*5580.00	109.1 PK			1.15 H	64	106.3	2.8
2	*5580.00	100.9 AV			1.15 H	64	98.1	2.8
3	11160.00	47.7 PK	74.0	-26.3	1.46 H	180	35.7	12.0
4	11160.00	36.7 AV	54.0	-17.3	1.46 H	180	24.7	12.0
5	#16740.00	50.6 PK	68.2	-17.6	1.28 H	227	36.4	14.2

ANTENNA POLARITY & TEST DISTANCE: VERTICAL AT 3 M

NO.	FREQ. (MHz)	EMISSION LEVEL (dBuV/m)	LIMIT (dBuV/m)	MARGIN (dB)	ANTENNA HEIGHT (m)	TABLE ANGLE (Degree)	RAW VALUE (dBuV)	CORRECTION FACTOR (dB/m)
1	*5580.00	100.7 PK			2.97 V	360	97.9	2.8
2	*5580.00	91.0 AV			2.97 V	360	88.2	2.8
3	11160.00	48.8 PK	74.0	-25.2	1.63 V	158	36.8	12.0
4	11160.00	37.2 AV	54.0	-16.8	1.63 V	158	25.2	12.0
5	#16740.00	52.4 PK	68.2	-15.8	1.54 V	193	38.2	14.2

REMARKS:

1. Emission Level(dBuV/m) = Raw Value(dBuV) + Correction Factor(dB/m)
2. Correction Factor(dB/m) = Antenna Factor(dB/m) + Cable Factor(dB) – Pre-Amplifier Factor(dB)
3. The other emission levels were very low against the limit.
4. Margin value = Emission Level – Limit value
5. " * ": Fundamental frequency.
6. " # ": The radiated frequency is out of the restricted band.

CHANNEL	TX Channel 140	DETECTOR FUNCTION	Peak (PK)
FREQUENCY RANGE	1GHz ~ 40GHz		Average (AV)

ANTENNA POLARITY & TEST DISTANCE: HORIZONTAL AT 3 M

NO.	FREQ. (MHz)	EMISSION LEVEL (dBuV/m)	LIMIT (dBuV/m)	MARGIN (dB)	ANTENNA HEIGHT (m)	TABLE ANGLE (Degree)	RAW VALUE (dBuV)	CORRECTION FACTOR (dB/m)
1	*5700.00	107.4 PK			1.13 H	43	104.5	2.9
2	*5700.00	99.4 AV			1.13 H	43	96.5	2.9
3	#5725.00	65.0 PK	68.2	-3.2	1.13 H	43	62.1	2.9
4	11400.00	47.6 PK	74.0	-26.4	1.49 H	184	34.6	13.0
5	11400.00	36.8 AV	54.0	-17.2	1.49 H	184	23.8	13.0
6	#17100.00	50.5 PK	68.2	-17.7	1.32 H	225	34.4	16.1

ANTENNA POLARITY & TEST DISTANCE: VERTICAL AT 3 M

NO.	FREQ. (MHz)	EMISSION LEVEL (dBuV/m)	LIMIT (dBuV/m)	MARGIN (dB)	ANTENNA HEIGHT (m)	TABLE ANGLE (Degree)	RAW VALUE (dBuV)	CORRECTION FACTOR (dB/m)
1	*5700.00	99.5 PK			2.94 V	352	96.6	2.9
2	*5700.00	90.1 AV			2.94 V	352	87.2	2.9
3	#5725.00	62.3 PK	68.2	-5.9	2.94 V	352	59.4	2.9
4	11400.00	48.4 PK	74.0	-25.6	1.62 V	163	35.4	13.0
5	11400.00	36.3 AV	54.0	-17.7	1.62 V	163	23.3	13.0
6	#17100.00	51.8 PK	68.2	-16.4	1.55 V	207	35.7	16.1

REMARKS:

1. Emission Level(dBuV/m) = Raw Value(dBuV) + Correction Factor(dB/m)
2. Correction Factor(dB/m) = Antenna Factor(dB/m) + Cable Factor(dB) – Pre-Amplifier Factor(dB)
3. The other emission levels were very low against the limit.
4. Margin value = Emission Level – Limit value
5. " * ": Fundamental frequency.
6. " # ": The radiated frequency is out of the restricted band.

CHANNEL	TX Channel 149	DETECTOR FUNCTION	Peak (PK)
FREQUENCY RANGE	1GHz ~ 40GHz		Average (AV)

ANTENNA POLARITY & TEST DISTANCE: HORIZONTAL AT 3 M

NO.	FREQ. (MHz)	EMISSION LEVEL (dBuV/m)	LIMIT (dBuV/m)	MARGIN (dB)	ANTENNA HEIGHT (m)	TABLE ANGLE (Degree)	RAW VALUE (dBuV)	CORRECTION FACTOR (dB/m)
1	3830.00	52.0 PK	74.0	-22.0	1.50 H	52	52.2	-0.2
2	3830.00	46.4 AV	54.0	-7.6	1.50 H	52	46.6	-0.2
3	#5559.35	51.3 PK	68.2	-16.9	1.03 H	34	48.5	2.8
4	*5745.00	109.7 PK			1.03 H	34	106.8	2.9
5	*5745.00	99.8 AV			1.03 H	34	96.9	2.9
6	#5997.71	50.9 PK	68.2	-17.3	1.03 H	34	47.7	3.2
7	11490.00	48.1 PK	74.0	-25.9	1.47 H	168	35.8	12.3
8	11490.00	37.1 AV	54.0	-16.9	1.47 H	168	24.8	12.3
9	#17235.00	50.9 PK	68.2	-17.3	1.31 H	227	35.6	15.3

ANTENNA POLARITY & TEST DISTANCE: VERTICAL AT 3 M

NO.	FREQ. (MHz)	EMISSION LEVEL (dBuV/m)	LIMIT (dBuV/m)	MARGIN (dB)	ANTENNA HEIGHT (m)	TABLE ANGLE (Degree)	RAW VALUE (dBuV)	CORRECTION FACTOR (dB/m)
1	3830.00	49.0 PK	74.0	-25.0	3.58 V	190	49.2	-0.2
2	3830.00	43.1 AV	54.0	-10.9	3.58 V	190	43.3	-0.2
3	#5559.23	49.8 PK	68.2	-18.4	2.95 V	354	47.0	2.8
4	*5745.00	101.3 PK			2.95 V	354	98.4	2.9
5	*5745.00	91.4 AV			2.95 V	354	88.5	2.9
6	#5988.70	50.3 PK	68.2	-17.9	2.95 V	354	47.1	3.2
7	11490.00	48.6 PK	74.0	-25.4	1.63 V	163	36.3	12.3
8	11490.00	36.8 AV	54.0	-17.2	1.63 V	163	24.5	12.3
9	#17235.00	52.2 PK	68.2	-16.0	1.55 V	200	36.9	15.3

REMARKS:

1. Emission Level(dBuV/m) = Raw Value(dBuV) + Correction Factor(dB/m)
2. Correction Factor(dB/m) = Antenna Factor(dB/m) + Cable Factor(dB) – Pre-Amplifier Factor(dB)
3. The other emission levels were very low against the limit.
4. Margin value = Emission Level – Limit value
5. " * ": Fundamental frequency.
6. " # ": The radiated frequency is out of the restricted band.

CHANNEL	TX Channel 157	DETECTOR FUNCTION	Peak (PK)
FREQUENCY RANGE	1GHz ~ 40GHz		Average (AV)

ANTENNA POLARITY & TEST DISTANCE: HORIZONTAL AT 3 M

NO.	FREQ. (MHz)	EMISSION LEVEL (dBuV/m)	LIMIT (dBuV/m)	MARGIN (dB)	ANTENNA HEIGHT (m)	TABLE ANGLE (Degree)	RAW VALUE (dBuV)	CORRECTION FACTOR (dB/m)
1	#5567.84	52.0 PK	68.2	-16.2	1.08 H	223	49.2	2.8
2	*5785.00	109.7 PK			1.08 H	223	106.6	3.1
3	*5785.00	99.7 AV			1.08 H	223	96.6	3.1
4	#5943.32	52.7 PK	68.2	-15.5	1.08 H	223	49.4	3.3
5	11570.00	47.6 PK	74.0	-26.4	1.42 H	182	35.2	12.4
6	11570.00	36.9 AV	54.0	-17.1	1.42 H	182	24.5	12.4
7	#17355.00	50.6 PK	68.2	-17.6	1.30 H	214	34.6	16.0

ANTENNA POLARITY & TEST DISTANCE: VERTICAL AT 3 M

NO.	FREQ. (MHz)	EMISSION LEVEL (dBuV/m)	LIMIT (dBuV/m)	MARGIN (dB)	ANTENNA HEIGHT (m)	TABLE ANGLE (Degree)	RAW VALUE (dBuV)	CORRECTION FACTOR (dB/m)
1	#5643.77	50.9 PK	68.2	-17.3	3.89 V	135	51.7	-0.8
2	*5785.00	101.3 PK			3.89 V	135	98.2	3.1
3	*5785.00	91.5 AV			3.89 V	135	88.4	3.1
4	#5941.47	51.1 PK	68.2	-17.1	3.89 V	135	51.3	-0.2
5	11570.00	48.6 PK	74.0	-25.4	1.60 V	172	36.2	12.4
6	11570.00	36.5 AV	54.0	-17.5	1.60 V	172	24.1	12.4
7	#17355.00	52.1 PK	68.2	-16.1	1.61 V	211	36.1	16.0

REMARKS:

1. Emission Level(dBuV/m) = Raw Value(dBuV) + Correction Factor(dB/m)
2. Correction Factor(dB/m) = Antenna Factor(dB/m) + Cable Factor(dB) – Pre-Amplifier Factor(dB)
3. The other emission levels were very low against the limit.
4. Margin value = Emission Level – Limit value
5. " * ": Fundamental frequency.
6. " # ": The radiated frequency is out of the restricted band.

CHANNEL	TX Channel 165	DETECTOR FUNCTION	Peak (PK)
FREQUENCY RANGE	1GHz ~ 40GHz		Average (AV)

ANTENNA POLARITY & TEST DISTANCE: HORIZONTAL AT 3 M

NO.	FREQ. (MHz)	EMISSION LEVEL (dBuV/m)	LIMIT (dBuV/m)	MARGIN (dB)	ANTENNA HEIGHT (m)	TABLE ANGLE (Degree)	RAW VALUE (dBuV)	CORRECTION FACTOR (dB/m)
1	#5614.84	52.2 PK	68.2	-16.0	1.09 H	221	53.0	-0.8
2	*5825.00	109.8 PK			1.09 H	221	106.6	3.2
3	*5825.00	99.7 AV			1.09 H	221	96.5	3.2
4	#6016.83	52.9 PK	68.2	-15.3	1.09 H	221	53.1	-0.2
5	11650.00	47.9 PK	74.0	-26.1	1.49 H	167	35.5	12.4
6	11650.00	37.1 AV	54.0	-16.9	1.49 H	167	24.7	12.4
7	#17475.00	50.8 PK	68.2	-17.4	1.31 H	211	33.4	17.4

ANTENNA POLARITY & TEST DISTANCE: VERTICAL AT 3 M

NO.	FREQ. (MHz)	EMISSION LEVEL (dBuV/m)	LIMIT (dBuV/m)	MARGIN (dB)	ANTENNA HEIGHT (m)	TABLE ANGLE (Degree)	RAW VALUE (dBuV)	CORRECTION FACTOR (dB/m)
1	#5640.86	50.3 PK	68.2	-17.9	3.89 V	123	51.1	-0.8
2	*5825.00	101.7 PK			3.89 V	123	98.5	3.2
3	*5825.00	91.6 AV			3.89 V	123	88.4	3.2
4	#5943.35	50.6 PK	68.2	-17.6	3.89 V	123	50.8	-0.2
5	11650.00	49.1 PK	74.0	-24.9	1.65 V	168	36.7	12.4
6	11650.00	37.2 AV	54.0	-16.8	1.65 V	168	24.8	12.4
7	#17475.00	51.9 PK	68.2	-16.3	1.54 V	201	34.5	17.4

REMARKS:

1. Emission Level(dBuV/m) = Raw Value(dBuV) + Correction Factor(dB/m)
2. Correction Factor(dB/m) = Antenna Factor(dB/m) + Cable Factor(dB) – Pre-Amplifier Factor(dB)
3. The other emission levels were very low against the limit.
4. Margin value = Emission Level – Limit value
5. " * ": Fundamental frequency.
6. " # ": The radiated frequency is out of the restricted band.

802.11ac (VHT20)

CHANNEL	TX Channel 36	DETECTOR FUNCTION	Peak (PK)
FREQUENCY RANGE	1GHz ~ 40GHz		Average (AV)

ANTENNA POLARITY & TEST DISTANCE: HORIZONTAL AT 3 M								
NO.	FREQ. (MHz)	EMISSION LEVEL (dBuV/m)	LIMIT (dBuV/m)	MARGIN (dB)	ANTENNA HEIGHT (m)	TABLE ANGLE (Degree)	RAW VALUE (dBuV)	CORRECTION FACTOR (dB/m)
1	5150.00	57.9 PK	74.0	-16.1	1.18 H	253	55.3	2.6
2	5150.00	47.7 AV	54.0	-6.3	1.18 H	253	45.1	2.6
3	*5180.00	103.6 PK			1.18 H	253	101.1	2.5
4	*5180.00	95.7 AV			1.18 H	253	93.2	2.5
5	#10360.00	45.9 PK	68.2	-22.3	1.47 H	130	34.0	11.9
6	15540.00	46.7 PK	74.0	-27.3	1.31 H	242	34.3	12.4
7	15540.00	35.5 AV	54.0	-18.5	1.31 H	242	23.1	12.4

ANTENNA POLARITY & TEST DISTANCE: VERTICAL AT 3 M								
NO.	FREQ. (MHz)	EMISSION LEVEL (dBuV/m)	LIMIT (dBuV/m)	MARGIN (dB)	ANTENNA HEIGHT (m)	TABLE ANGLE (Degree)	RAW VALUE (dBuV)	CORRECTION FACTOR (dB/m)
1	5150.00	54.2 PK	74.0	-19.8	1.28 V	63	51.6	2.6
2	5150.00	46.1 AV	54.0	-7.9	1.28 V	63	43.5	2.6
3	*5180.00	98.5 PK			1.28 V	63	96.0	2.5
4	*5180.00	90.5 AV			1.28 V	63	88.0	2.5
5	#10360.00	45.2 PK	68.2	-23.0	1.42 V	127	33.3	11.9
6	15540.00	47.9 PK	74.0	-26.1	1.48 V	253	35.5	12.4
7	15540.00	35.8 AV	54.0	-18.2	1.48 V	253	23.4	12.4

REMARKS:

1. Emission Level(dBuV/m) = Raw Value(dBuV) + Correction Factor(dB/m)
2. Correction Factor(dB/m) = Antenna Factor(dB/m) + Cable Factor(dB) – Pre-Amplifier Factor(dB)
3. The other emission levels were very low against the limit.
4. Margin value = Emission Level – Limit value
5. " * ": Fundamental frequency.
6. " # ": The radiated frequency is out of the restricted band.

CHANNEL	TX Channel 40	DETECTOR FUNCTION	Peak (PK)
FREQUENCY RANGE	1GHz ~ 40GHz		Average (AV)

ANTENNA POLARITY & TEST DISTANCE: HORIZONTAL AT 3 M

NO.	FREQ. (MHz)	EMISSION LEVEL (dBuV/m)	LIMIT (dBuV/m)	MARGIN (dB)	ANTENNA HEIGHT (m)	TABLE ANGLE (Degree)	RAW VALUE (dBuV)	CORRECTION FACTOR (dB/m)
1	*5200.00	104.5 PK			1.18 H	237	102.1	2.4
2	*5200.00	96.5 AV			1.18 H	237	94.1	2.4
3	#10400.00	45.8 PK	68.2	-22.4	1.47 H	142	33.6	12.2
4	15600.00	46.2 PK	74.0	-27.8	1.33 H	231	33.3	12.9
5	15600.00	34.9 AV	54.0	-19.1	1.33 H	231	22.0	12.9

ANTENNA POLARITY & TEST DISTANCE: VERTICAL AT 3 M

NO.	FREQ. (MHz)	EMISSION LEVEL (dBuV/m)	LIMIT (dBuV/m)	MARGIN (dB)	ANTENNA HEIGHT (m)	TABLE ANGLE (Degree)	RAW VALUE (dBuV)	CORRECTION FACTOR (dB/m)
1	*5200.00	99.4 PK			1.33 V	54	97.0	2.4
2	*5200.00	91.3 AV			1.33 V	54	88.9	2.4
3	#10400.00	45.5 PK	68.2	-22.7	1.47 V	139	33.3	12.2
4	15600.00	47.4 PK	74.0	-26.6	1.49 V	243	34.5	12.9
5	15600.00	35.6 AV	54.0	-18.4	1.49 V	243	22.7	12.9

REMARKS:

1. Emission Level(dBuV/m) = Raw Value(dBuV) + Correction Factor(dB/m)
2. Correction Factor(dB/m) = Antenna Factor(dB/m) + Cable Factor(dB) – Pre-Amplifier Factor(dB)
3. The other emission levels were very low against the limit.
4. Margin value = Emission Level – Limit value
5. " * ": Fundamental frequency.
6. " # ": The radiated frequency is out of the restricted band.

CHANNEL	TX Channel 48	DETECTOR FUNCTION	Peak (PK)
FREQUENCY RANGE	1GHz ~ 40GHz		Average (AV)

ANTENNA POLARITY & TEST DISTANCE: HORIZONTAL AT 3 M

NO.	FREQ. (MHz)	EMISSION LEVEL (dBuV/m)	LIMIT (dBuV/m)	MARGIN (dB)	ANTENNA HEIGHT (m)	TABLE ANGLE (Degree)	RAW VALUE (dBuV)	CORRECTION FACTOR (dB/m)
1	*5240.00	103.6 PK			1.16 H	254	101.4	2.2
2	*5240.00	95.7 AV			1.16 H	254	93.5	2.2
3	5350.00	48.8 PK	74.0	-25.2	1.16 H	254	46.5	2.3
4	5350.00	38.7 AV	54.0	-15.3	1.16 H	254	36.4	2.3
5	#10480.00	45.9 PK	68.2	-22.3	1.49 H	129	33.5	12.4
6	15720.00	46.4 PK	74.0	-27.6	1.34 H	255	34.4	12.0
7	15720.00	35.4 AV	54.0	-18.6	1.34 H	255	23.4	12.0

ANTENNA POLARITY & TEST DISTANCE: VERTICAL AT 3 M

NO.	FREQ. (MHz)	EMISSION LEVEL (dBuV/m)	LIMIT (dBuV/m)	MARGIN (dB)	ANTENNA HEIGHT (m)	TABLE ANGLE (Degree)	RAW VALUE (dBuV)	CORRECTION FACTOR (dB/m)
1	*5240.00	98.5 PK			1.37 V	36	96.3	2.2
2	*5240.00	90.5 AV			1.37 V	36	88.3	2.2
3	5350.00	47.6 PK	74.0	-26.4	1.37 V	36	45.3	2.3
4	5350.00	37.7 AV	54.0	-16.3	1.37 V	36	35.4	2.3
5	#10480.00	45.9 PK	68.2	-22.3	1.41 V	149	33.5	12.4
6	15720.00	47.7 PK	74.0	-26.3	1.50 V	235	35.7	12.0
7	15720.00	35.9 AV	54.0	-18.1	1.50 V	235	23.9	12.0

REMARKS:

1. Emission Level(dBuV/m) = Raw Value(dBuV) + Correction Factor(dB/m)
2. Correction Factor(dB/m) = Antenna Factor(dB/m) + Cable Factor(dB) – Pre-Amplifier Factor(dB)
3. The other emission levels were very low against the limit.
4. Margin value = Emission Level – Limit value
5. " * ": Fundamental frequency.
6. " # ": The radiated frequency is out of the restricted band.

CHANNEL	TX Channel 52	DETECTOR FUNCTION	Peak (PK)
FREQUENCY RANGE	1GHz ~ 40GHz		Average (AV)

ANTENNA POLARITY & TEST DISTANCE: HORIZONTAL AT 3 M

NO.	FREQ. (MHz)	EMISSION LEVEL (dBuV/m)	LIMIT (dBuV/m)	MARGIN (dB)	ANTENNA HEIGHT (m)	TABLE ANGLE (Degree)	RAW VALUE (dBuV)	CORRECTION FACTOR (dB/m)
1	5150.00	48.6 PK	74.0	-25.4	1.17 H	235	46.0	2.6
2	5150.00	38.6 AV	54.0	-15.4	1.17 H	235	36.0	2.6
3	*5260.00	107.2 PK			1.17 H	235	105.1	2.1
4	*5260.00	98.3 AV			1.17 H	235	96.2	2.1
5	#10520.00	46.6 PK	68.2	-21.6	1.48 H	154	34.2	12.4
6	15780.00	46.2 PK	74.0	-27.8	1.34 H	243	34.7	11.5
7	15780.00	34.9 AV	54.0	-19.1	1.34 H	243	23.4	11.5

ANTENNA POLARITY & TEST DISTANCE: VERTICAL AT 3 M

NO.	FREQ. (MHz)	EMISSION LEVEL (dBuV/m)	LIMIT (dBuV/m)	MARGIN (dB)	ANTENNA HEIGHT (m)	TABLE ANGLE (Degree)	RAW VALUE (dBuV)	CORRECTION FACTOR (dB/m)
1	5150.00	44.9 PK	74.0	-29.1	1.29 V	60	42.3	2.6
2	5150.00	37.0 AV	54.0	-17.0	1.29 V	60	34.4	2.6
3	*5260.00	102.1 PK			1.29 V	60	100.0	2.1
4	*5260.00	93.1 AV			1.29 V	60	91.0	2.1
5	#10520.00	45.6 PK	68.2	-22.6	1.47 V	146	33.2	12.4
6	15780.00	47.2 PK	74.0	-26.8	1.51 V	254	35.7	11.5
7	15780.00	35.4 AV	54.0	-18.6	1.51 V	254	23.9	11.5

REMARKS:

1. Emission Level(dBuV/m) = Raw Value(dBuV) + Correction Factor(dB/m)
2. Correction Factor(dB/m) = Antenna Factor(dB/m) + Cable Factor(dB) – Pre-Amplifier Factor(dB)
3. The other emission levels were very low against the limit.
4. Margin value = Emission Level – Limit value
5. " * ": Fundamental frequency.
6. " # ": The radiated frequency is out of the restricted band.

CHANNEL	TX Channel 60	DETECTOR FUNCTION	Peak (PK)
FREQUENCY RANGE	1GHz ~ 40GHz		Average (AV)

ANTENNA POLARITY & TEST DISTANCE: HORIZONTAL AT 3 M

NO.	FREQ. (MHz)	EMISSION LEVEL (dBuV/m)	LIMIT (dBuV/m)	MARGIN (dB)	ANTENNA HEIGHT (m)	TABLE ANGLE (Degree)	RAW VALUE (dBuV)	CORRECTION FACTOR (dB/m)
1	*5300.00	106.7 PK			1.19 H	251	104.5	2.2
2	*5300.00	98.2 AV			1.19 H	251	96.0	2.2
3	10600.00	46.2 PK	74.0	-27.8	1.52 H	147	34.5	11.7
4	10600.00	34.7 AV	54.0	-19.3	1.52 H	147	23.0	11.7
5	15900.00	46.7 PK	74.0	-27.3	1.42 H	248	35.5	11.2
6	15900.00	35.5 AV	54.0	-18.5	1.42 H	248	24.3	11.2

ANTENNA POLARITY & TEST DISTANCE: VERTICAL AT 3 M

NO.	FREQ. (MHz)	EMISSION LEVEL (dBuV/m)	LIMIT (dBuV/m)	MARGIN (dB)	ANTENNA HEIGHT (m)	TABLE ANGLE (Degree)	RAW VALUE (dBuV)	CORRECTION FACTOR (dB/m)
1	*5300.00	101.6 PK			1.36 V	65	99.4	2.2
2	*5300.00	93.0 AV			1.36 V	65	90.8	2.2
3	10600.00	45.5 PK	74.0	-28.5	1.45 V	137	33.8	11.7
4	10600.00	34.4 AV	54.0	-19.6	1.45 V	137	22.7	11.7
5	15900.00	47.0 PK	74.0	-27.0	1.53 V	253	35.8	11.2
6	15900.00	34.9 AV	54.0	-19.1	1.53 V	253	23.7	11.2

REMARKS:

1. Emission Level(dBuV/m) = Raw Value(dBuV) + Correction Factor(dB/m)
2. Correction Factor(dB/m) = Antenna Factor(dB/m) + Cable Factor(dB) – Pre-Amplifier Factor(dB)
3. The other emission levels were very low against the limit.
4. Margin value = Emission Level – Limit value
5. " * ": Fundamental frequency.

CHANNEL	TX Channel 64	DETECTOR FUNCTION	Peak (PK)
FREQUENCY RANGE	1GHz ~ 40GHz		Average (AV)

ANTENNA POLARITY & TEST DISTANCE: HORIZONTAL AT 3 M

NO.	FREQ. (MHz)	EMISSION LEVEL (dBuV/m)	LIMIT (dBuV/m)	MARGIN (dB)	ANTENNA HEIGHT (m)	TABLE ANGLE (Degree)	RAW VALUE (dBuV)	CORRECTION FACTOR (dB/m)
1	*5320.00	106.7 PK			1.15 H	261	104.4	2.3
2	*5320.00	98.4 AV			1.15 H	261	96.1	2.3
3	5350.00	52.9 PK	74.0	-21.1	1.15 H	261	50.6	2.3
4	5350.00	41.5 AV	54.0	-12.5	1.15 H	261	39.2	2.3
5	10640.00	45.2 PK	74.0	-28.8	1.48 H	134	33.5	11.7
6	10640.00	34.0 AV	54.0	-20.0	1.48 H	134	22.3	11.7
7	15960.00	46.6 PK	74.0	-27.4	1.39 H	227	35.2	11.4
8	15960.00	35.7 AV	54.0	-18.3	1.39 H	227	24.3	11.4

ANTENNA POLARITY & TEST DISTANCE: VERTICAL AT 3 M

NO.	FREQ. (MHz)	EMISSION LEVEL (dBuV/m)	LIMIT (dBuV/m)	MARGIN (dB)	ANTENNA HEIGHT (m)	TABLE ANGLE (Degree)	RAW VALUE (dBuV)	CORRECTION FACTOR (dB/m)
1	*5320.00	101.6 PK			1.36 V	37	99.3	2.3
2	*5320.00	93.2 AV			1.36 V	37	90.9	2.3
3	5350.00	51.7 PK	74.0	-22.3	1.36 V	37	49.4	2.3
4	5350.00	40.5 AV	54.0	-13.5	1.36 V	37	38.2	2.3
5	10640.00	45.1 PK	74.0	-28.9	1.45 V	136	33.4	11.7
6	10640.00	34.4 AV	54.0	-19.6	1.45 V	136	22.7	11.7
7	15960.00	47.4 PK	74.0	-26.6	1.50 V	252	36.0	11.4
8	15960.00	35.5 AV	54.0	-18.5	1.50 V	252	24.1	11.4

REMARKS:

1. Emission Level(dBuV/m) = Raw Value(dBuV) + Correction Factor(dB/m)
2. Correction Factor(dB/m) = Antenna Factor(dB/m) + Cable Factor(dB) – Pre-Amplifier Factor(dB)
3. The other emission levels were very low against the limit.
4. Margin value = Emission Level – Limit value
5. " * ": Fundamental frequency.

CHANNEL	TX Channel 100	DETECTOR FUNCTION	Peak (PK)
FREQUENCY RANGE	1GHz ~ 40GHz		Average (AV)

ANTENNA POLARITY & TEST DISTANCE: HORIZONTAL AT 3 M

NO.	FREQ. (MHz)	EMISSION LEVEL (dBuV/m)	LIMIT (dBuV/m)	MARGIN (dB)	ANTENNA HEIGHT (m)	TABLE ANGLE (Degree)	RAW VALUE (dBuV)	CORRECTION FACTOR (dB/m)
1	5460.00	58.2 PK	74.0	-15.8	1.09 H	182	55.6	2.6
2	5460.00	45.3 AV	54.0	-8.7	1.09 H	182	42.7	2.6
3	#5470.00	65.0 PK	68.2	-3.2	1.09 H	182	62.4	2.6
4	*5500.00	107.6 PK			1.09 H	182	105.1	2.5
5	*5500.00	99.0 AV			1.09 H	182	96.5	2.5
6	11000.00	45.5 PK	74.0	-28.5	1.40 H	127	33.3	12.2
7	11000.00	34.4 AV	54.0	-19.6	1.40 H	127	22.2	12.2
8	#16500.00	46.7 PK	68.2	-21.5	1.41 H	256	33.0	13.7

ANTENNA POLARITY & TEST DISTANCE: VERTICAL AT 3 M

NO.	FREQ. (MHz)	EMISSION LEVEL (dBuV/m)	LIMIT (dBuV/m)	MARGIN (dB)	ANTENNA HEIGHT (m)	TABLE ANGLE (Degree)	RAW VALUE (dBuV)	CORRECTION FACTOR (dB/m)
1	5460.00	57.4 PK	74.0	-16.6	3.00 V	360	54.8	2.6
2	5460.00	44.2 AV	54.0	-9.8	3.00 V	360	41.6	2.6
3	#5470.00	61.6 PK	68.2	-6.6	3.00 V	360	59.0	2.6
4	*5500.00	99.2 PK			3.00 V	360	96.7	2.5
5	*5500.00	89.1 AV			3.00 V	360	86.6	2.5
6	11000.00	46.2 PK	74.0	-27.8	1.45 V	123	34.0	12.2
7	11000.00	35.1 AV	54.0	-18.9	1.45 V	123	22.9	12.2
8	#16500.00	47.1 PK	68.2	-21.1	1.47 V	248	33.4	13.7

REMARKS:

1. Emission Level(dBuV/m) = Raw Value(dBuV) + Correction Factor(dB/m)
2. Correction Factor(dB/m) = Antenna Factor(dB/m) + Cable Factor(dB) – Pre-Amplifier Factor(dB)
3. The other emission levels were very low against the limit.
4. Margin value = Emission Level – Limit value
5. " * ": Fundamental frequency.
6. " # ": The radiated frequency is out of the restricted band.

CHANNEL	TX Channel 116	DETECTOR FUNCTION	Peak (PK)
FREQUENCY RANGE	1GHz ~ 40GHz		Average (AV)

ANTENNA POLARITY & TEST DISTANCE: HORIZONTAL AT 3 M

NO.	FREQ. (MHz)	EMISSION LEVEL (dBuV/m)	LIMIT (dBuV/m)	MARGIN (dB)	ANTENNA HEIGHT (m)	TABLE ANGLE (Degree)	RAW VALUE (dBuV)	CORRECTION FACTOR (dB/m)
1	*5580.00	109.3 PK			1.13 H	195	106.5	2.8
2	*5580.00	100.6 AV			1.13 H	195	97.8	2.8
3	11160.00	46.0 PK	74.0	-28.0	1.51 H	141	34.0	12.0
4	11160.00	34.4 AV	54.0	-19.6	1.51 H	141	22.4	12.0
5	#16740.00	46.0 PK	68.2	-22.2	1.36 H	250	31.8	14.2

ANTENNA POLARITY & TEST DISTANCE: VERTICAL AT 3 M

NO.	FREQ. (MHz)	EMISSION LEVEL (dBuV/m)	LIMIT (dBuV/m)	MARGIN (dB)	ANTENNA HEIGHT (m)	TABLE ANGLE (Degree)	RAW VALUE (dBuV)	CORRECTION FACTOR (dB/m)
1	*5580.00	100.9 PK			2.93 V	346	98.1	2.8
2	*5580.00	90.7 AV			2.93 V	346	87.9	2.8
3	11160.00	46.0 PK	74.0	-28.0	1.43 V	144	34.0	12.0
4	11160.00	35.2 AV	54.0	-18.8	1.43 V	144	23.2	12.0
5	#16740.00	47.8 PK	68.2	-20.4	1.53 V	229	33.6	14.2

REMARKS:

1. Emission Level(dBuV/m) = Raw Value(dBuV) + Correction Factor(dB/m)
2. Correction Factor(dB/m) = Antenna Factor(dB/m) + Cable Factor(dB) – Pre-Amplifier Factor(dB)
3. The other emission levels were very low against the limit.
4. Margin value = Emission Level – Limit value
5. " * ": Fundamental frequency.
6. " # ": The radiated frequency is out of the restricted band.

CHANNEL	TX Channel 140	DETECTOR FUNCTION	Peak (PK)
FREQUENCY RANGE	1GHz ~ 40GHz		Average (AV)

ANTENNA POLARITY & TEST DISTANCE: HORIZONTAL AT 3 M

NO.	FREQ. (MHz)	EMISSION LEVEL (dBuV/m)	LIMIT (dBuV/m)	MARGIN (dB)	ANTENNA HEIGHT (m)	TABLE ANGLE (Degree)	RAW VALUE (dBuV)	CORRECTION FACTOR (dB/m)
1	*5700.00	107.2 PK			1.05 H	205	104.3	2.9
2	*5700.00	99.7 AV			1.05 H	205	96.8	2.9
3	#5725.00	65.1 PK	68.2	-3.1	1.05 H	205	62.2	2.9
4	11400.00	46.2 PK	74.0	-27.8	1.51 H	142	33.2	13.0
5	11400.00	34.5 AV	54.0	-19.5	1.51 H	142	21.5	13.0
6	#17100.00	46.8 PK	68.2	-21.4	1.37 H	257	30.7	16.1

ANTENNA POLARITY & TEST DISTANCE: VERTICAL AT 3 M

NO.	FREQ. (MHz)	EMISSION LEVEL (dBuV/m)	LIMIT (dBuV/m)	MARGIN (dB)	ANTENNA HEIGHT (m)	TABLE ANGLE (Degree)	RAW VALUE (dBuV)	CORRECTION FACTOR (dB/m)
1	*5700.00	98.8 PK			2.91 V	360	95.9	2.9
2	*5700.00	89.8 AV			2.91 V	360	86.9	2.9
3	#5725.00	62.4 PK	68.2	-5.8	2.91 V	360	59.5	2.9
4	11400.00	45.7 PK	74.0	-28.3	1.47 V	132	32.7	13.0
5	11400.00	34.4 AV	54.0	-19.6	1.47 V	132	21.4	13.0
6	#17100.00	47.5 PK	68.2	-20.7	1.55 V	235	31.4	16.1

REMARKS:

1. Emission Level(dBuV/m) = Raw Value(dBuV) + Correction Factor(dB/m)
2. Correction Factor(dB/m) = Antenna Factor(dB/m) + Cable Factor(dB) – Pre-Amplifier Factor(dB)
3. The other emission levels were very low against the limit.
4. Margin value = Emission Level – Limit value
5. " * ": Fundamental frequency.
6. " # ": The radiated frequency is out of the restricted band.

CHANNEL	TX Channel 149	DETECTOR FUNCTION	Peak (PK)
FREQUENCY RANGE	1GHz ~ 40GHz		Average (AV)

ANTENNA POLARITY & TEST DISTANCE: HORIZONTAL AT 3 M

NO.	FREQ. (MHz)	EMISSION LEVEL (dBuV/m)	LIMIT (dBuV/m)	MARGIN (dB)	ANTENNA HEIGHT (m)	TABLE ANGLE (Degree)	RAW VALUE (dBuV)	CORRECTION FACTOR (dB/m)
1	#5645.12	51.2 PK	68.2	-17.0	1.05 H	221	48.5	2.7
2	*5745.00	110.1 PK			1.05 H	221	107.2	2.9
3	*5745.00	101.7 AV			1.05 H	221	98.8	2.9
4	#6015.99	52.4 PK	68.2	-15.8	1.05 H	221	49.2	3.2
5	11490.00	45.5 PK	74.0	-28.5	1.44 H	137	33.2	12.3
6	11490.00	34.4 AV	54.0	-19.6	1.44 H	137	22.1	12.3
7	#17235.00	46.2 PK	68.2	-22.0	1.39 H	254	30.9	15.3

ANTENNA POLARITY & TEST DISTANCE: VERTICAL AT 3 M

NO.	FREQ. (MHz)	EMISSION LEVEL (dBuV/m)	LIMIT (dBuV/m)	MARGIN (dB)	ANTENNA HEIGHT (m)	TABLE ANGLE (Degree)	RAW VALUE (dBuV)	CORRECTION FACTOR (dB/m)
1	#5566.28	50.4 PK	68.2	-17.8	3.50 V	205	51.4	-1.0
2	*5745.00	104.9 PK			3.50 V	205	102.0	2.9
3	*5745.00	96.4 AV			3.50 V	205	93.5	2.9
4	#5988.88	51.1 PK	68.2	-17.1	3.50 V	205	51.3	-0.2
5	11490.00	45.6 PK	74.0	-28.4	1.45 V	140	33.3	12.3
6	11490.00	34.5 AV	54.0	-19.5	1.45 V	140	22.2	12.3
7	#17235.00	46.7 PK	68.2	-21.5	1.50 V	256	31.4	15.3

REMARKS:

1. Emission Level(dBuV/m) = Raw Value(dBuV) + Correction Factor(dB/m)
2. Correction Factor(dB/m) = Antenna Factor(dB/m) + Cable Factor(dB) – Pre-Amplifier Factor(dB)
3. The other emission levels were very low against the limit.
4. Margin value = Emission Level – Limit value
5. " * ": Fundamental frequency.
6. " # ": The radiated frequency is out of the restricted band.

CHANNEL	TX Channel 157	DETECTOR FUNCTION	Peak (PK)
FREQUENCY RANGE	1GHz ~ 40GHz		Average (AV)

ANTENNA POLARITY & TEST DISTANCE: HORIZONTAL AT 3 M

NO.	FREQ. (MHz)	EMISSION LEVEL (dBuV/m)	LIMIT (dBuV/m)	MARGIN (dB)	ANTENNA HEIGHT (m)	TABLE ANGLE (Degree)	RAW VALUE (dBuV)	CORRECTION FACTOR (dB/m)
1	#5572.78	51.0 PK	68.2	-17.2	1.16 H	234	48.2	2.8
2	*5785.00	109.6 PK			1.16 H	234	106.5	3.1
3	*5785.00	101.5 AV			1.16 H	234	98.4	3.1
4	#6008.77	51.4 PK	68.2	-16.8	1.16 H	234	48.2	3.2
5	11570.00	45.6 PK	74.0	-28.4	1.44 H	143	33.2	12.4
6	11570.00	34.2 AV	54.0	-19.8	1.44 H	143	21.8	12.4
7	#17355.00	46.8 PK	68.2	-21.4	1.37 H	229	30.8	16.0

ANTENNA POLARITY & TEST DISTANCE: VERTICAL AT 3 M

NO.	FREQ. (MHz)	EMISSION LEVEL (dBuV/m)	LIMIT (dBuV/m)	MARGIN (dB)	ANTENNA HEIGHT (m)	TABLE ANGLE (Degree)	RAW VALUE (dBuV)	CORRECTION FACTOR (dB/m)
1	#5578.67	49.9 PK	68.2	-18.3	3.44 V	200	50.8	-0.9
2	*5785.00	104.6 PK			3.44 V	200	101.5	3.1
3	*5785.00	96.5 AV			3.44 V	200	93.4	3.1
4	#5932.91	51.6 PK	68.2	-16.6	3.44 V	200	51.7	-0.1
5	11570.00	45.5 PK	74.0	-28.5	1.43 V	130	33.1	12.4
6	11570.00	34.8 AV	54.0	-19.2	1.43 V	130	22.4	12.4
7	#17355.00	46.6 PK	68.2	-21.6	1.46 V	248	30.6	16.0

REMARKS:

1. Emission Level(dBuV/m) = Raw Value(dBuV) + Correction Factor(dB/m)
2. Correction Factor(dB/m) = Antenna Factor(dB/m) + Cable Factor(dB) – Pre-Amplifier Factor(dB)
3. The other emission levels were very low against the limit.
4. Margin value = Emission Level – Limit value
5. " * ": Fundamental frequency.
6. " # ": The radiated frequency is out of the restricted band.

CHANNEL	TX Channel 165	DETECTOR FUNCTION	Peak (PK)
FREQUENCY RANGE	1GHz ~ 40GHz		Average (AV)

ANTENNA POLARITY & TEST DISTANCE: HORIZONTAL AT 3 M

NO.	FREQ. (MHz)	EMISSION LEVEL (dBuV/m)	LIMIT (dBuV/m)	MARGIN (dB)	ANTENNA HEIGHT (m)	TABLE ANGLE (Degree)	RAW VALUE (dBuV)	CORRECTION FACTOR (dB/m)
1	#5635.38	50.9 PK	68.2	-17.3	1.09 H	213	48.1	2.8
2	*5825.00	109.9 PK			1.09 H	213	106.7	3.2
3	*5825.00	101.5 AV			1.09 H	213	98.3	3.2
4	#6010.62	51.6 PK	68.2	-16.6	1.09 H	213	48.4	3.2
5	11650.00	45.8 PK	74.0	-28.2	1.47 H	149	33.4	12.4
6	11650.00	34.2 AV	54.0	-19.8	1.47 H	149	21.8	12.4
7	#17475.00	46.4 PK	68.2	-21.8	1.32 H	248	29.0	17.4

ANTENNA POLARITY & TEST DISTANCE: VERTICAL AT 3 M

NO.	FREQ. (MHz)	EMISSION LEVEL (dBuV/m)	LIMIT (dBuV/m)	MARGIN (dB)	ANTENNA HEIGHT (m)	TABLE ANGLE (Degree)	RAW VALUE (dBuV)	CORRECTION FACTOR (dB/m)
1	#5611.57	50.5 PK	68.2	-17.7	3.44 V	220	51.3	-0.8
2	*5825.00	105.0 PK			3.44 V	220	101.8	3.2
3	*5825.00	96.6 AV			3.44 V	220	93.4	3.2
4	#6017.99	51.8 PK	68.2	-16.4	3.44 V	220	52.0	-0.2
5	11650.00	45.7 PK	74.0	-28.3	1.43 V	132	33.3	12.4
6	11650.00	34.4 AV	54.0	-19.6	1.43 V	132	22.0	12.4
7	#17475.00	47.2 PK	68.2	-21.0	1.49 V	253	29.8	17.4

REMARKS:

1. Emission Level(dBuV/m) = Raw Value(dBuV) + Correction Factor(dB/m)
2. Correction Factor(dB/m) = Antenna Factor(dB/m) + Cable Factor(dB) – Pre-Amplifier Factor(dB)
3. The other emission levels were very low against the limit.
4. Margin value = Emission Level – Limit value
5. " * ": Fundamental frequency.
6. " # ": The radiated frequency is out of the restricted band.

802.11ac (VHT40)

CHANNEL	TX Channel 38	DETECTOR FUNCTION	Peak (PK)
FREQUENCY RANGE	1GHz ~ 40GHz		Average (AV)

ANTENNA POLARITY & TEST DISTANCE: HORIZONTAL AT 3 M

NO.	FREQ. (MHz)	EMISSION LEVEL (dBuV/m)	LIMIT (dBuV/m)	MARGIN (dB)	ANTENNA HEIGHT (m)	TABLE ANGLE (Degree)	RAW VALUE (dBuV)	CORRECTION FACTOR (dB/m)
1	5150.00	61.9 PK	74.0	-12.1	1.21 H	61	59.3	2.6
2	5150.00	50.2 AV	54.0	-3.8	1.21 H	61	47.6	2.6
3	*5190.00	108.8 PK			1.21 H	61	106.3	2.5
4	*5190.00	100.5 AV			1.21 H	61	98.0	2.5
5	5350.00	49.7 PK	74.0	-24.3	1.21 H	61	47.4	2.3
6	5350.00	40.2 AV	54.0	-13.8	1.21 H	61	37.9	2.3
7	#10380.00	46.2 PK	68.2	-22.0	1.48 H	139	34.2	12.0
8	15570.00	46.6 PK	74.0	-27.4	1.43 H	237	34.0	12.6
9	15570.00	35.4 AV	54.0	-18.6	1.43 H	237	22.8	12.6

ANTENNA POLARITY & TEST DISTANCE: VERTICAL AT 3 M

NO.	FREQ. (MHz)	EMISSION LEVEL (dBuV/m)	LIMIT (dBuV/m)	MARGIN (dB)	ANTENNA HEIGHT (m)	TABLE ANGLE (Degree)	RAW VALUE (dBuV)	CORRECTION FACTOR (dB/m)
1	5150.00	58.2 PK	74.0	-15.8	1.27 V	74	55.6	2.6
2	5150.00	48.6 AV	54.0	-5.4	1.27 V	74	46.0	2.6
3	*5190.00	103.7 PK			1.27 V	74	101.2	2.5
4	*5190.00	95.3 AV			1.27 V	74	92.8	2.5
5	5350.00	48.5 PK	74.0	-25.5	1.27 V	74	46.2	2.3
6	5350.00	39.2 AV	54.0	-14.8	1.27 V	74	36.9	2.3
7	#10380.00	45.7 PK	68.2	-22.5	1.47 V	151	33.7	12.0
8	15570.00	47.6 PK	74.0	-26.4	1.51 V	250	35.0	12.6
9	15570.00	35.8 AV	54.0	-18.2	1.51 V	250	23.2	12.6

REMARKS:

- Emission Level(dBuV/m) = Raw Value(dBuV) + Correction Factor(dB/m)
- Correction Factor(dB/m) = Antenna Factor(dB/m) + Cable Factor(dB) – Pre-Amplifier Factor(dB)
- The other emission levels were very low against the limit.
- Margin value = Emission Level – Limit value
- " * ": Fundamental frequency.
- " # ": The radiated frequency is out of the restricted band.

CHANNEL	TX Channel 46	DETECTOR FUNCTION	Peak (PK)
FREQUENCY RANGE	1GHz ~ 40GHz		Average (AV)

ANTENNA POLARITY & TEST DISTANCE: HORIZONTAL AT 3 M

NO.	FREQ. (MHz)	EMISSION LEVEL (dBuV/m)	LIMIT (dBuV/m)	MARGIN (dB)	ANTENNA HEIGHT (m)	TABLE ANGLE (Degree)	RAW VALUE (dBuV)	CORRECTION FACTOR (dB/m)
1	*5230.00	103.5 PK			1.02 H	212	101.3	2.2
2	*5230.00	95.0 AV			1.02 H	212	92.8	2.2
3	5350.00	50.8 PK	74.0	-23.2	1.02 H	212	48.5	2.3
4	5350.00	41.5 AV	54.0	-12.5	1.02 H	212	39.2	2.3
5	#10460.00	45.6 PK	68.2	-22.6	1.47 H	147	33.2	12.4
6	15690.00	46.6 PK	74.0	-27.4	1.42 H	237	34.4	12.2
7	15690.00	35.2 AV	54.0	-18.8	1.42 H	237	23.0	12.2

ANTENNA POLARITY & TEST DISTANCE: VERTICAL AT 3 M

NO.	FREQ. (MHz)	EMISSION LEVEL (dBuV/m)	LIMIT (dBuV/m)	MARGIN (dB)	ANTENNA HEIGHT (m)	TABLE ANGLE (Degree)	RAW VALUE (dBuV)	CORRECTION FACTOR (dB/m)
1	*5230.00	98.4 PK			1.25 V	72	96.2	2.2
2	*5230.00	89.8 AV			1.25 V	72	87.6	2.2
3	5350.00	49.6 PK	74.0	-24.4	1.25 V	72	47.3	2.3
4	5350.00	40.5 AV	54.0	-13.5	1.25 V	72	38.2	2.3
5	#10460.00	46.2 PK	68.2	-22.0	1.48 V	149	33.8	12.4
6	15690.00	47.0 PK	74.0	-27.0	1.51 V	232	34.8	12.2
7	15690.00	35.4 AV	54.0	-18.6	1.51 V	232	23.2	12.2

REMARKS:

1. Emission Level(dBuV/m) = Raw Value(dBuV) + Correction Factor(dB/m)
2. Correction Factor(dB/m) = Antenna Factor(dB/m) + Cable Factor(dB) – Pre-Amplifier Factor(dB)
3. The other emission levels were very low against the limit.
4. Margin value = Emission Level – Limit value
5. " * ": Fundamental frequency.
6. " # ": The radiated frequency is out of the restricted band.

CHANNEL	TX Channel 54	DETECTOR FUNCTION	Peak (PK)
FREQUENCY RANGE	1GHz ~ 40GHz		Average (AV)

ANTENNA POLARITY & TEST DISTANCE: HORIZONTAL AT 3 M

NO.	FREQ. (MHz)	EMISSION LEVEL (dBuV/m)	LIMIT (dBuV/m)	MARGIN (dB)	ANTENNA HEIGHT (m)	TABLE ANGLE (Degree)	RAW VALUE (dBuV)	CORRECTION FACTOR (dB/m)
1	5150.00	48.8 PK	74.0	-25.2	1.07 H	258	46.2	2.6
2	5150.00	40.8 AV	54.0	-13.2	1.07 H	258	38.2	2.6
3	*5270.00	104.4 PK			1.07 H	258	102.3	2.1
4	*5270.00	96.4 AV			1.07 H	258	94.3	2.1
5	5350.00	54.4 PK	74.0	-19.6	1.07 H	258	52.1	2.3
6	5350.00	44.1 AV	54.0	-9.9	1.07 H	258	41.8	2.3
7	#10540.00	45.8 PK	68.2	-22.4	1.43 H	131	33.6	12.2
8	15810.00	47.0 PK	74.0	-27.0	1.33 H	244	35.7	11.3
9	15810.00	35.7 AV	54.0	-18.3	1.33 H	244	24.4	11.3

ANTENNA POLARITY & TEST DISTANCE: VERTICAL AT 3 M

NO.	FREQ. (MHz)	EMISSION LEVEL (dBuV/m)	LIMIT (dBuV/m)	MARGIN (dB)	ANTENNA HEIGHT (m)	TABLE ANGLE (Degree)	RAW VALUE (dBuV)	CORRECTION FACTOR (dB/m)
1	5150.00	45.1 PK	74.0	-28.9	1.23 V	72	42.5	2.6
2	5150.00	39.2 AV	54.0	-14.8	1.23 V	72	36.6	2.6
3	*5270.00	99.3 PK			1.23 V	72	97.2	2.1
4	*5270.00	91.2 AV			1.23 V	72	89.1	2.1
5	5350.00	53.2 PK	74.0	-20.8	1.23 V	72	50.9	2.3
6	5350.00	43.1 AV	54.0	-10.9	1.23 V	72	40.8	2.3
7	#10540.00	45.9 PK	68.2	-22.3	1.47 V	129	33.7	12.2
8	15810.00	46.8 PK	74.0	-27.2	1.52 V	253	35.5	11.3
9	15810.00	35.1 AV	54.0	-18.9	1.52 V	253	23.8	11.3

REMARKS:

1. Emission Level(dBuV/m) = Raw Value(dBuV) + Correction Factor(dB/m)
2. Correction Factor(dB/m) = Antenna Factor(dB/m) + Cable Factor(dB) – Pre-Amplifier Factor(dB)
3. The other emission levels were very low against the limit.
4. Margin value = Emission Level – Limit value
5. " * ": Fundamental frequency.
6. " # ": The radiated frequency is out of the restricted band.

CHANNEL	TX Channel 62	DETECTOR FUNCTION	Peak (PK)
FREQUENCY RANGE	1GHz ~ 40GHz		Average (AV)

ANTENNA POLARITY & TEST DISTANCE: HORIZONTAL AT 3 M

NO.	FREQ. (MHz)	EMISSION LEVEL (dBuV/m)	LIMIT (dBuV/m)	MARGIN (dB)	ANTENNA HEIGHT (m)	TABLE ANGLE (Degree)	RAW VALUE (dBuV)	CORRECTION FACTOR (dB/m)
1	*5310.00	103.3 PK			1.06 H	207	101.1	2.2
2	*5310.00	95.7 AV			1.06 H	207	93.5	2.2
3	5350.00	62.1 PK	74.0	-11.9	1.06 H	207	59.8	2.3
4	5350.00	50.1 AV	54.0	-3.9	1.06 H	207	47.8	2.3
5	10620.00	46.5 PK	74.0	-27.5	1.46 H	140	34.8	11.7
6	10620.00	34.9 AV	54.0	-19.1	1.46 H	140	23.2	11.7
7	15930.00	46.1 PK	74.0	-27.9	1.40 H	246	34.9	11.2
8	15930.00	35.1 AV	54.0	-18.9	1.40 H	246	23.9	11.2

ANTENNA POLARITY & TEST DISTANCE: VERTICAL AT 3 M

NO.	FREQ. (MHz)	EMISSION LEVEL (dBuV/m)	LIMIT (dBuV/m)	MARGIN (dB)	ANTENNA HEIGHT (m)	TABLE ANGLE (Degree)	RAW VALUE (dBuV)	CORRECTION FACTOR (dB/m)
1	*5310.00	98.2 PK			1.32 V	67	96.0	2.2
2	*5310.00	90.5 AV			1.32 V	67	88.3	2.2
3	5350.00	60.9 PK	74.0	-13.1	1.32 V	67	58.6	2.3
4	5350.00	49.1 AV	54.0	-4.9	1.32 V	67	46.8	2.3
5	10620.00	46.2 PK	74.0	-27.8	1.48 V	145	34.5	11.7
6	10620.00	35.2 AV	54.0	-18.8	1.48 V	145	23.5	11.7
7	15930.00	46.6 PK	74.0	-27.4	1.46 V	237	35.4	11.2
8	15930.00	35.0 AV	54.0	-19.0	1.46 V	237	23.8	11.2

REMARKS:

1. Emission Level(dBuV/m) = Raw Value(dBuV) + Correction Factor(dB/m)
2. Correction Factor(dB/m) = Antenna Factor(dB/m) + Cable Factor(dB) – Pre-Amplifier Factor(dB)
3. The other emission levels were very low against the limit.
4. Margin value = Emission Level – Limit value
5. " * ": Fundamental frequency.

CHANNEL	TX Channel 102	DETECTOR FUNCTION	Peak (PK)
FREQUENCY RANGE	1GHz ~ 40GHz		Average (AV)

ANTENNA POLARITY & TEST DISTANCE: HORIZONTAL AT 3 M

NO.	FREQ. (MHz)	EMISSION LEVEL (dBuV/m)	LIMIT (dBuV/m)	MARGIN (dB)	ANTENNA HEIGHT (m)	TABLE ANGLE (Degree)	RAW VALUE (dBuV)	CORRECTION FACTOR (dB/m)
1	5460.00	56.2 PK	74.0	-17.8	1.09 H	225	53.6	2.6
2	5460.00	45.8 AV	54.0	-8.2	1.09 H	225	43.2	2.6
3	#5470.00	65.0 PK	68.2	-3.2	1.09 H	225	62.4	2.6
4	*5510.00	104.1 PK			1.09 H	225	101.6	2.5
5	*5510.00	96.4 AV			1.09 H	225	93.9	2.5
6	11020.00	46.1 PK	74.0	-27.9	1.48 H	130	33.8	12.3
7	11020.00	34.6 AV	54.0	-19.4	1.48 H	130	22.3	12.3
8	#16530.00	46.6 PK	68.2	-21.6	1.37 H	238	32.7	13.9

ANTENNA POLARITY & TEST DISTANCE: VERTICAL AT 3 M

NO.	FREQ. (MHz)	EMISSION LEVEL (dBuV/m)	LIMIT (dBuV/m)	MARGIN (dB)	ANTENNA HEIGHT (m)	TABLE ANGLE (Degree)	RAW VALUE (dBuV)	CORRECTION FACTOR (dB/m)
1	5460.00	55.4 PK	74.0	-18.6	2.97 V	357	52.8	2.6
2	5460.00	44.7 AV	54.0	-9.3	2.97 V	357	42.1	2.6
3	#5470.00	61.6 PK	68.2	-6.6	2.97 V	357	59.0	2.6
4	*5510.00	95.7 PK			2.97 V	357	93.2	2.5
5	*5510.00	86.5 AV			2.97 V	357	84.0	2.5
6	11020.00	45.7 PK	74.0	-28.3	1.44 V	125	33.4	12.3
7	11020.00	34.7 AV	54.0	-19.3	1.44 V	125	22.4	12.3
8	#16530.00	46.8 PK	68.2	-21.4	1.52 V	250	32.9	13.9

REMARKS:

1. Emission Level(dBuV/m) = Raw Value(dBuV) + Correction Factor(dB/m)
2. Correction Factor(dB/m) = Antenna Factor(dB/m) + Cable Factor(dB) – Pre-Amplifier Factor(dB)
3. The other emission levels were very low against the limit.
4. Margin value = Emission Level – Limit value
5. " * ": Fundamental frequency.
6. " # ": The radiated frequency is out of the restricted band.

CHANNEL	TX Channel 110	DETECTOR FUNCTION	Peak (PK)
FREQUENCY RANGE	1GHz ~ 40GHz		Average (AV)

ANTENNA POLARITY & TEST DISTANCE: HORIZONTAL AT 3 M

NO.	FREQ. (MHz)	EMISSION LEVEL (dBuV/m)	LIMIT (dBuV/m)	MARGIN (dB)	ANTENNA HEIGHT (m)	TABLE ANGLE (Degree)	RAW VALUE (dBuV)	CORRECTION FACTOR (dB/m)
1	*5550.00	105.3 PK			1.08 H	209	102.6	2.7
2	*5550.00	97.5 AV			1.08 H	209	94.8	2.7
3	11100.00	45.2 PK	74.0	-28.8	1.51 H	155	33.1	12.1
4	11100.00	34.0 AV	54.0	-20.0	1.51 H	155	21.9	12.1
5	#16650.00	46.0 PK	68.2	-22.2	1.31 H	233	31.8	14.2

ANTENNA POLARITY & TEST DISTANCE: VERTICAL AT 3 M

NO.	FREQ. (MHz)	EMISSION LEVEL (dBuV/m)	LIMIT (dBuV/m)	MARGIN (dB)	ANTENNA HEIGHT (m)	TABLE ANGLE (Degree)	RAW VALUE (dBuV)	CORRECTION FACTOR (dB/m)
1	*5550.00	96.9 PK			2.91 V	357	94.2	2.7
2	*5550.00	87.6 AV			2.91 V	357	84.9	2.7
3	11100.00	45.7 PK	74.0	-28.3	1.44 V	129	33.6	12.1
4	11100.00	34.8 AV	54.0	-19.2	1.44 V	129	22.7	12.1
5	#16650.00	47.4 PK	68.2	-20.8	1.49 V	238	33.2	14.2

REMARKS:

1. Emission Level(dBuV/m) = Raw Value(dBuV) + Correction Factor(dB/m)
2. Correction Factor(dB/m) = Antenna Factor(dB/m) + Cable Factor(dB) – Pre-Amplifier Factor(dB)
3. The other emission levels were very low against the limit.
4. Margin value = Emission Level – Limit value
5. " * ": Fundamental frequency.
6. " # ": The radiated frequency is out of the restricted band.

CHANNEL	TX Channel 134	DETECTOR FUNCTION	Peak (PK)
FREQUENCY RANGE	1GHz ~ 40GHz		Average (AV)

ANTENNA POLARITY & TEST DISTANCE: HORIZONTAL AT 3 M

NO.	FREQ. (MHz)	EMISSION LEVEL (dBuV/m)	LIMIT (dBuV/m)	MARGIN (dB)	ANTENNA HEIGHT (m)	TABLE ANGLE (Degree)	RAW VALUE (dBuV)	CORRECTION FACTOR (dB/m)
1	*5670.00	104.0 PK			1.13 H	217	101.1	2.9
2	*5670.00	96.2 AV			1.13 H	217	93.3	2.9
3	#5725.00	65.1 PK	68.2	-3.1	1.13 H	217	62.2	2.9
4	11340.00	46.2 PK	74.0	-27.8	1.46 H	153	33.3	12.9
5	11340.00	34.7 AV	54.0	-19.3	1.46 H	153	21.8	12.9
6	#17010.00	46.3 PK	68.2	-21.9	1.34 H	242	30.5	15.8

ANTENNA POLARITY & TEST DISTANCE: VERTICAL AT 3 M

NO.	FREQ. (MHz)	EMISSION LEVEL (dBuV/m)	LIMIT (dBuV/m)	MARGIN (dB)	ANTENNA HEIGHT (m)	TABLE ANGLE (Degree)	RAW VALUE (dBuV)	CORRECTION FACTOR (dB/m)
1	*5670.00	102.1 PK			2.90 V	358	99.2	2.9
2	*5670.00	94.2 AV			2.90 V	358	91.3	2.9
3	#5725.00	62.4 PK	68.2	-5.8	2.90 V	358	59.5	2.9
4	11340.00	45.9 PK	74.0	-28.1	1.45 V	143	33.0	12.9
5	11340.00	34.9 AV	54.0	-19.1	1.45 V	143	22.0	12.9
6	#17010.00	47.3 PK	68.2	-20.9	1.55 V	243	31.5	15.8

REMARKS:

1. Emission Level(dBuV/m) = Raw Value(dBuV) + Correction Factor(dB/m)
2. Correction Factor(dB/m) = Antenna Factor(dB/m) + Cable Factor(dB) – Pre-Amplifier Factor(dB)
3. The other emission levels were very low against the limit.
4. Margin value = Emission Level – Limit value
5. " * ": Fundamental frequency.
6. " # ": The radiated frequency is out of the restricted band.

CHANNEL	TX Channel 151	DETECTOR FUNCTION	Peak (PK)
FREQUENCY RANGE	1GHz ~ 40GHz		Average (AV)

ANTENNA POLARITY & TEST DISTANCE: HORIZONTAL AT 3 M

NO.	FREQ. (MHz)	EMISSION LEVEL (dBuV/m)	LIMIT (dBuV/m)	MARGIN (dB)	ANTENNA HEIGHT (m)	TABLE ANGLE (Degree)	RAW VALUE (dBuV)	CORRECTION FACTOR (dB/m)
1	#5648.10	52.6 PK	68.2	-15.6	1.06 H	223	49.9	2.7
2	*5755.00	106.8 PK			1.06 H	223	103.8	3.0
3	*5755.00	98.7 AV			1.06 H	223	95.7	3.0
4	#5991.14	51.9 PK	68.2	-16.3	1.06 H	223	48.7	3.2
5	11510.00	47.9 PK	74.0	-26.1	1.42 H	181	35.6	12.3
6	11510.00	36.7 AV	54.0	-17.3	1.42 H	181	24.4	12.3
7	#17265.00	51.0 PK	68.2	-17.2	1.35 H	230	35.6	15.4

ANTENNA POLARITY & TEST DISTANCE: VERTICAL AT 3 M

NO.	FREQ. (MHz)	EMISSION LEVEL (dBuV/m)	LIMIT (dBuV/m)	MARGIN (dB)	ANTENNA HEIGHT (m)	TABLE ANGLE (Degree)	RAW VALUE (dBuV)	CORRECTION FACTOR (dB/m)
1	#5620.11	51.0 PK	68.2	-17.2	3.70 V	178	51.8	-0.8
2	*5755.00	102.1 PK			3.70 V	178	99.1	3.0
3	*5755.00	94.0 AV			3.70 V	178	91.0	3.0
4	#5967.55	52.1 PK	68.2	-16.1	3.70 V	178	52.3	-0.2
5	11510.00	45.2 PK	74.0	-28.8	1.44 V	150	32.9	12.3
6	11510.00	34.3 AV	54.0	-19.7	1.44 V	150	22.0	12.3
7	#17265.00	47.6 PK	68.2	-20.6	1.47 V	246	32.2	15.4

REMARKS:

1. Emission Level(dBuV/m) = Raw Value(dBuV) + Correction Factor(dB/m)
2. Correction Factor(dB/m) = Antenna Factor(dB/m) + Cable Factor(dB) – Pre-Amplifier Factor(dB)
3. The other emission levels were very low against the limit.
4. Margin value = Emission Level – Limit value
5. " * ": Fundamental frequency.
6. " # ": The radiated frequency is out of the restricted band.

CHANNEL	TX Channel 159	DETECTOR FUNCTION	Peak (PK)
FREQUENCY RANGE	1GHz ~ 40GHz		Average (AV)

ANTENNA POLARITY & TEST DISTANCE: HORIZONTAL AT 3 M

NO.	FREQ. (MHz)	EMISSION LEVEL (dBuV/m)	LIMIT (dBuV/m)	MARGIN (dB)	ANTENNA HEIGHT (m)	TABLE ANGLE (Degree)	RAW VALUE (dBuV)	CORRECTION FACTOR (dB/m)
1	#5644.92	51.8 PK	68.2	-16.4	1.09 H	219	49.1	2.7
2	*5795.00	105.4 PK			1.09 H	219	102.4	3.0
3	*5795.00	97.8 AV			1.09 H	219	94.8	3.0
4	#5956.99	50.9 PK	68.2	-17.3	1.09 H	216	47.7	3.2
5	11590.00	46.4 PK	74.0	-27.6	1.46 H	155	34.0	12.4
6	11590.00	34.9 AV	54.0	-19.1	1.46 H	155	22.5	12.4
7	#17385.00	46.4 PK	68.2	-21.8	1.34 H	243	30.2	16.2

ANTENNA POLARITY & TEST DISTANCE: VERTICAL AT 3 M

NO.	FREQ. (MHz)	EMISSION LEVEL (dBuV/m)	LIMIT (dBuV/m)	MARGIN (dB)	ANTENNA HEIGHT (m)	TABLE ANGLE (Degree)	RAW VALUE (dBuV)	CORRECTION FACTOR (dB/m)
1	#5644.36	49.6 PK	68.2	-18.6	3.72 V	107	50.4	-0.8
2	*5795.00	100.6 PK			3.72 V	107	97.6	3.0
3	*5795.00	92.9 AV			3.72 V	107	89.9	3.0
4	#5951.28	51.5 PK	68.2	-16.7	3.72 V	107	51.7	-0.2
5	11590.00	46.4 PK	74.0	-27.6	1.46 V	139	34.0	12.4
6	11590.00	35.2 AV	54.0	-18.8	1.46 V	139	22.8	12.4
7	#17385.00	47.8 PK	68.2	-20.4	1.44 V	242	31.6	16.2

REMARKS:

- Emission Level(dBuV/m) = Raw Value(dBuV) + Correction Factor(dB/m)
- Correction Factor(dB/m) = Antenna Factor(dB/m) + Cable Factor(dB) – Pre-Amplifier Factor(dB)
- The other emission levels were very low against the limit.
- Margin value = Emission Level – Limit value
- " * ": Fundamental frequency.
- " # ": The radiated frequency is out of the restricted band.

802.11ac (VHT80)

CHANNEL	TX Channel 42	DETECTOR FUNCTION	Peak (PK)
FREQUENCY RANGE	1GHz ~ 40GHz		Average (AV)

ANTENNA POLARITY & TEST DISTANCE: HORIZONTAL AT 3 M								
NO.	FREQ. (MHz)	EMISSION LEVEL (dBuV/m)	LIMIT (dBuV/m)	MARGIN (dB)	ANTENNA HEIGHT (m)	TABLE ANGLE (Degree)	RAW VALUE (dBuV)	CORRECTION FACTOR (dB/m)
1	5150.00	62.0 PK	74.0	-12.0	1.55 H	290	59.4	2.6
2	5150.00	50.9 AV	54.0	-3.1	1.55 H	290	48.3	2.6
3	*5210.00	97.8 PK			1.51 H	266	95.4	2.4
4	*5210.00	91.1 AV			1.51 H	266	88.7	2.4
5	5350.00	53.2 PK	74.0	-20.8	1.47 H	283	50.9	2.3
6	5350.00	42.3 AV	54.0	-11.7	1.47 H	283	40.0	2.3
7	#10420.00	46.1 PK	68.2	-22.1	1.41 H	134	33.9	12.2
8	15630.00	46.8 PK	74.0	-27.2	1.37 H	227	34.1	12.7
9	15630.00	35.7 AV	54.0	-18.3	1.37 H	227	23.0	12.7

ANTENNA POLARITY & TEST DISTANCE: VERTICAL AT 3 M								
NO.	FREQ. (MHz)	EMISSION LEVEL (dBuV/m)	LIMIT (dBuV/m)	MARGIN (dB)	ANTENNA HEIGHT (m)	TABLE ANGLE (Degree)	RAW VALUE (dBuV)	CORRECTION FACTOR (dB/m)
1	5150.00	58.3 PK	74.0	-15.7	1.30 V	48	55.7	2.6
2	5150.00	49.3 AV	54.0	-4.7	1.30 V	48	46.7	2.6
3	*5210.00	92.7 PK			1.30 V	48	90.3	2.4
4	*5210.00	85.9 AV			1.30 V	48	83.5	2.4
5	5350.00	52.0 PK	74.0	-22.0	1.30 V	48	49.7	2.3
6	5350.00	41.3 AV	54.0	-12.7	1.30 V	48	39.0	2.3
7	#10420.00	46.2 PK	68.2	-22.0	1.41 V	131	34.0	12.2
8	15630.00	47.1 PK	74.0	-26.9	1.45 V	257	34.4	12.7
9	15630.00	35.0 AV	54.0	-19.0	1.45 V	257	22.3	12.7

REMARKS:

1. Emission Level(dBuV/m) = Raw Value(dBuV) + Correction Factor(dB/m)
2. Correction Factor(dB/m) = Antenna Factor(dB/m) + Cable Factor(dB) – Pre-Amplifier Factor(dB)
3. The other emission levels were very low against the limit.
4. Margin value = Emission Level – Limit value
5. " * ": Fundamental frequency.
6. " # ": The radiated frequency is out of the restricted band.

CHANNEL	TX Channel 58	DETECTOR FUNCTION	Peak (PK)
FREQUENCY RANGE	1GHz ~ 40GHz		Average (AV)

ANTENNA POLARITY & TEST DISTANCE: HORIZONTAL AT 3 M

NO.	FREQ. (MHz)	EMISSION LEVEL (dBuV/m)	LIMIT (dBuV/m)	MARGIN (dB)	ANTENNA HEIGHT (m)	TABLE ANGLE (Degree)	RAW VALUE (dBuV)	CORRECTION FACTOR (dB/m)
1	5150.00	50.4 PK	74.0	-23.6	1.05 H	227	47.8	2.6
2	5150.00	41.9 AV	54.0	-12.1	1.05 H	227	39.3	2.6
3	*5290.00	99.2 PK			1.11 H	227	97.1	2.1
4	*5290.00	91.5 AV			1.11 H	227	89.4	2.1
5	5350.00	62.2 PK	74.0	-11.8	1.10 H	222	59.9	2.3
6	5350.00	50.3 AV	54.0	-3.7	1.10 H	222	48.0	2.3
7	#10580.00	45.1 PK	68.2	-23.1	1.61 H	166	33.3	11.8
8	15870.00	47.5 PK	74.0	-26.5	1.35 H	217	36.3	11.2
9	15870.00	37.4 AV	54.0	-16.6	1.35 H	217	26.2	11.2

ANTENNA POLARITY & TEST DISTANCE: VERTICAL AT 3 M

NO.	FREQ. (MHz)	EMISSION LEVEL (dBuV/m)	LIMIT (dBuV/m)	MARGIN (dB)	ANTENNA HEIGHT (m)	TABLE ANGLE (Degree)	RAW VALUE (dBuV)	CORRECTION FACTOR (dB/m)
1	5150.00	46.7 PK	74.0	-27.3	1.24 V	77	44.1	2.6
2	5150.00	40.3 AV	54.0	-13.7	1.24 V	77	37.7	2.6
3	*5290.00	94.1 PK			1.24 V	77	92.0	2.1
4	*5290.00	86.3 AV			1.24 V	77	84.2	2.1
5	5350.00	61.0 PK	74.0	-13.0	1.24 V	77	58.7	2.3
6	5350.00	49.3 AV	54.0	-4.7	1.24 V	77	47.0	2.3
7	#10580.00	45.8 PK	68.2	-22.4	1.44 V	147	34.0	11.8
8	15870.00	47.7 PK	74.0	-26.3	1.51 V	236	36.5	11.2
9	15870.00	35.7 AV	54.0	-18.3	1.51 V	236	24.5	11.2

REMARKS:

1. Emission Level(dBuV/m) = Raw Value(dBuV) + Correction Factor(dB/m)
2. Correction Factor(dB/m) = Antenna Factor(dB/m) + Cable Factor(dB) – Pre-Amplifier Factor(dB)
3. The other emission levels were very low against the limit.
4. Margin value = Emission Level – Limit value
5. " * ": Fundamental frequency.
6. " # ": The radiated frequency is out of the restricted band.

CHANNEL	TX Channel 106	DETECTOR FUNCTION	Peak (PK)
FREQUENCY RANGE	1GHz ~ 40GHz		Average (AV)

ANTENNA POLARITY & TEST DISTANCE: HORIZONTAL AT 3 M

NO.	FREQ. (MHz)	EMISSION LEVEL (dBuV/m)	LIMIT (dBuV/m)	MARGIN (dB)	ANTENNA HEIGHT (m)	TABLE ANGLE (Degree)	RAW VALUE (dBuV)	CORRECTION FACTOR (dB/m)
1	5460.00	51.1 PK	74.0	-22.9	1.04 H	43	48.5	2.6
2	5460.00	41.2 AV	54.0	-12.8	1.04 H	43	38.6	2.6
3	#5470.00	65.1 PK	68.2	-3.1	1.04 H	43	62.5	2.6
4	*5530.00	101.1 PK			1.04 H	43	98.5	2.6
5	*5530.00	92.7 AV			1.04 H	43	90.1	2.6
6	#5725.00	50.0 PK	68.2	-18.2	1.04 H	43	47.1	2.9
7	11060.00	45.7 PK	74.0	-28.3	1.48 H	126	33.6	12.1
8	11060.00	34.5 AV	54.0	-19.5	1.48 H	126	22.4	12.1
9	#16590.00	46.6 PK	68.2	-21.6	1.37 H	251	32.4	14.2

ANTENNA POLARITY & TEST DISTANCE: VERTICAL AT 3 M

NO.	FREQ. (MHz)	EMISSION LEVEL (dBuV/m)	LIMIT (dBuV/m)	MARGIN (dB)	ANTENNA HEIGHT (m)	TABLE ANGLE (Degree)	RAW VALUE (dBuV)	CORRECTION FACTOR (dB/m)
1	5460.00	50.3 PK	74.0	-23.7	2.97 V	355	47.7	2.6
2	5460.00	40.1 AV	54.0	-13.9	2.97 V	355	37.5	2.6
3	#5470.00	61.7 PK	68.2	-6.5	2.97 V	355	59.1	2.6
4	*5530.00	92.7 PK			2.97 V	355	90.1	2.6
5	*5530.00	82.8 AV			2.97 V	355	80.2	2.6
6	#5725.00	46.6 PK	68.2	-21.6	2.97 V	355	43.7	2.9
7	11060.00	46.2 PK	74.0	-27.8	1.45 V	142	34.1	12.1
8	11060.00	35.1 AV	54.0	-18.9	1.45 V	142	23.0	12.1
9	#16590.00	47.5 PK	68.2	-20.7	1.52 V	253	33.3	14.2

REMARKS:

1. Emission Level(dBuV/m) = Raw Value(dBuV) + Correction Factor(dB/m)
2. Correction Factor(dB/m) = Antenna Factor(dB/m) + Cable Factor(dB) – Pre-Amplifier Factor(dB)
3. The other emission levels were very low against the limit.
4. Margin value = Emission Level – Limit value
5. " * ": Fundamental frequency.
6. " # ": The radiated frequency is out of the restricted band.

CHANNEL	TX Channel 122	DETECTOR FUNCTION	Peak (PK)
FREQUENCY RANGE	1GHz ~ 40GHz		Average (AV)

ANTENNA POLARITY & TEST DISTANCE: HORIZONTAL AT 3 M

NO.	FREQ. (MHz)	EMISSION LEVEL (dBuV/m)	LIMIT (dBuV/m)	MARGIN (dB)	ANTENNA HEIGHT (m)	TABLE ANGLE (Degree)	RAW VALUE (dBuV)	CORRECTION FACTOR (dB/m)
1	*5610.00	100.9 PK			1.06 H	66	98.1	2.8
2	*5610.00	92.6 AV			1.06 H	66	89.8	2.8
3	#5725.00	65.0 PK	68.2	-3.2	1.06 H	66	62.1	2.9
4	11220.00	46.2 PK	74.0	-27.8	1.45 H	154	33.9	12.3
5	11220.00	34.8 AV	54.0	-19.2	1.45 H	154	22.5	12.3
6	#16830.00	47.1 PK	68.2	-21.1	1.37 H	242	32.5	14.6

ANTENNA POLARITY & TEST DISTANCE: VERTICAL AT 3 M

NO.	FREQ. (MHz)	EMISSION LEVEL (dBuV/m)	LIMIT (dBuV/m)	MARGIN (dB)	ANTENNA HEIGHT (m)	TABLE ANGLE (Degree)	RAW VALUE (dBuV)	CORRECTION FACTOR (dB/m)
1	*5610.00	92.5 PK			2.96 V	335	89.7	2.8
2	*5610.00	82.7 AV			2.96 V	335	79.9	2.8
3	#5725.00	62.3 PK	68.2	-5.9	2.96 V	335	59.4	2.9
4	11220.00	45.7 PK	74.0	-28.3	1.49 V	147	33.4	12.3
5	11220.00	34.5 AV	54.0	-19.5	1.49 V	147	22.2	12.3
6	#16830.00	47.2 PK	68.2	-21.0	1.55 V	235	32.6	14.6

REMARKS:

1. Emission Level(dBuV/m) = Raw Value(dBuV) + Correction Factor(dB/m)
2. Correction Factor(dB/m) = Antenna Factor(dB/m) + Cable Factor(dB) – Pre-Amplifier Factor(dB)
3. The other emission levels were very low against the limit.
4. Margin value = Emission Level – Limit value
5. " * ": Fundamental frequency.
6. " # ": The radiated frequency is out of the restricted band.

CHANNEL	TX Channel 155	DETECTOR FUNCTION	Peak (PK)
FREQUENCY RANGE	1GHz ~ 40GHz		Average (AV)

ANTENNA POLARITY & TEST DISTANCE: HORIZONTAL AT 3 M

NO.	FREQ. (MHz)	EMISSION LEVEL (dBuV/m)	LIMIT (dBuV/m)	MARGIN (dB)	ANTENNA HEIGHT (m)	TABLE ANGLE (Degree)	RAW VALUE (dBuV)	CORRECTION FACTOR (dB/m)
1	#5635.84	53.8 PK	68.2	-14.4	1.17 H	224	54.6	-0.8
2	*5775.00	102.1 PK			1.17 H	224	99.1	3.0
3	*5775.00	93.0 AV			1.17 H	224	90.0	3.0
4	#5934.36	51.3 PK	68.2	-16.9	1.17 H	224	51.4	-0.1
5	11550.00	45.5 PK	74.0	-28.5	1.47 H	130	33.1	12.4
6	11550.00	34.0 AV	54.0	-20.0	1.47 H	130	21.6	12.4
7	#17325.00	45.8 PK	68.2	-22.4	1.40 H	254	30.1	15.7

ANTENNA POLARITY & TEST DISTANCE: VERTICAL AT 3 M

NO.	FREQ. (MHz)	EMISSION LEVEL (dBuV/m)	LIMIT (dBuV/m)	MARGIN (dB)	ANTENNA HEIGHT (m)	TABLE ANGLE (Degree)	RAW VALUE (dBuV)	CORRECTION FACTOR (dB/m)
1	#5580.55	51.7 PK	68.2	-16.5	3.92 V	135	52.6	-0.9
2	*5775.00	95.6 PK			3.92 V	135	92.6	3.0
3	*5775.00	88.5 AV			3.92 V	135	85.5	3.0
4	#6006.78	52.3 PK	68.2	-15.9	3.92 V	135	52.5	-0.2
5	11550.00	46.0 PK	74.0	-28.0	1.42 V	131	33.6	12.4
6	11550.00	35.2 AV	54.0	-18.8	1.42 V	131	22.8	12.4
7	#17325.00	46.8 PK	68.2	-21.4	1.52 V	238	31.1	15.7

REMARKS:

1. Emission Level(dBuV/m) = Raw Value(dBuV) + Correction Factor(dB/m)
2. Correction Factor(dB/m) = Antenna Factor(dB/m) + Cable Factor(dB) – Pre-Amplifier Factor(dB)
3. The other emission levels were very low against the limit.
4. Margin value = Emission Level – Limit value
5. " * ": Fundamental frequency.
6. " # ": The radiated frequency is out of the restricted band.

Below 1GHz Data:

802.11a

CHANNEL	TX Channel 116	DETECTOR FUNCTION	Quasi-Peak (QP)
FREQUENCY RANGE	9kHz ~ 1GHz		

ANTENNA POLARITY & TEST DISTANCE: HORIZONTAL AT 3 M

NO.	FREQ. (MHz)	EMISSION LEVEL (dBuV/m)	LIMIT (dBuV/m)	MARGIN (dB)	ANTENNA HEIGHT (m)	TABLE ANGLE (Degree)	RAW VALUE (dBuV)	CORRECTION FACTOR (dB/m)
1	38.37	25.9 QP	40.0	-14.1	2.00 H	360	34.4	-8.5
2	132.02	26.6 QP	43.5	-16.9	1.50 H	291	35.4	-8.8
3	193.81	23.0 QP	43.5	-20.5	1.50 H	0	33.6	-10.6
4	220.02	24.6 QP	46.0	-21.4	1.00 H	270	35.4	-10.8
5	307.98	26.0 QP	46.0	-20.0	1.00 H	319	32.6	-6.6
6	440.02	28.3 QP	46.0	-17.7	1.00 H	352	31.4	-3.1

REMARKS:

1. Emission Level(dBuV/m) = Raw Value(dBuV) + Correction Factor(dB/m)
2. Correction Factor(dB/m) = Antenna Factor(dB/m) + Cable Factor(dB) – Pre-Amplifier Factor(dB)
3. Margin value = Emission Level – Limit value
4. The emission levels were very low against the limit of frequency range 9kHz~30MHz: the amplitude of spurious emissions attenuated more than 20 dB below the permissible value to be report.

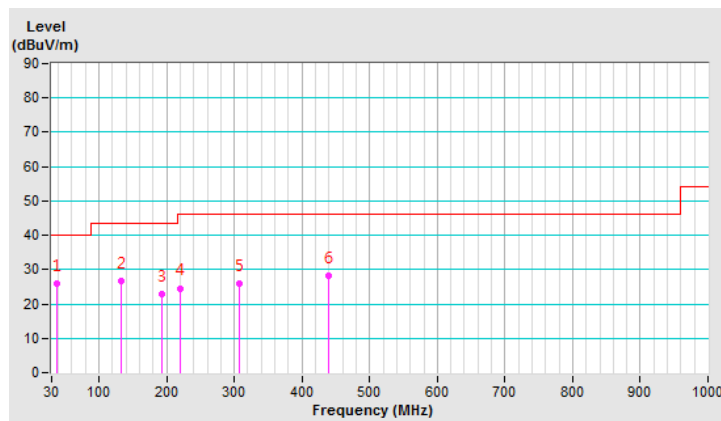

CHANNEL	TX Channel 116	DETECTOR FUNCTION	Quasi-Peak (QP)
FREQUENCY RANGE	9kHz ~ 1GHz		

ANTENNA POLARITY & TEST DISTANCE: VERTICAL AT 3 M

NO.	FREQ. (MHz)	EMISSION LEVEL (dBUV/m)	LIMIT (dBUV/m)	MARGIN (dB)	ANTENNA HEIGHT (m)	TABLE ANGLE (Degree)	RAW VALUE (dBUV)	CORRECTION FACTOR (dB/m)
1	44.09	32.2 QP	40.0	-7.8	1.00 V	292	40.3	-8.1
2	94.41	26.4 QP	43.5	-17.1	1.50 V	145	39.6	-13.2
3	220.00	24.2 QP	46.0	-21.8	1.00 V	360	35.0	-10.8
4	308.00	24.5 QP	46.0	-21.5	2.00 V	11	31.1	-6.6
5	406.04	25.7 QP	46.0	-20.3	1.00 V	261	30.0	-4.3
6	558.43	29.4 QP	46.0	-16.6	1.00 V	0	30.3	-0.9

REMARKS:

1. Emission Level(dBUV/m) = Raw Value(dBuV) + Correction Factor(dB/m)
2. Correction Factor(dB/m) = Antenna Factor(dB/m) + Cable Factor(dB) – Pre-Amplifier Factor(dB)
3. Margin value = Emission Level – Limit value
4. The emission levels were very low against the limit of frequency range 9kHz~30MHz: the amplitude of spurious emissions attenuated more than 20 dB below the permissible value to be report.

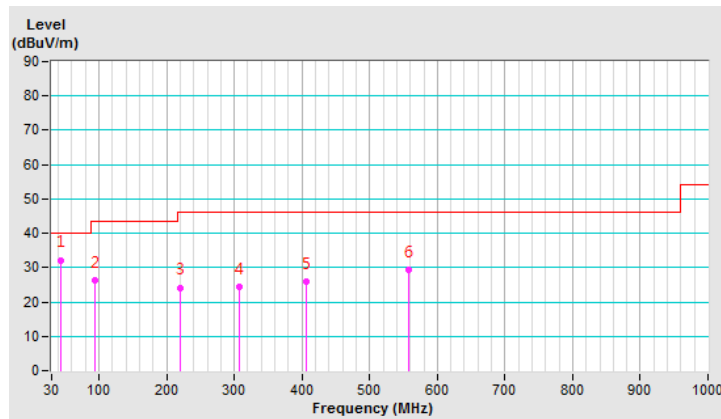

4.2 Conducted Emission Measurement

4.2.1 Limits of Conducted Emission Measurement

Frequency (MHz)	Conducted Limit (dBuV)	
	Quasi-peak	Average
0.15 - 0.5	66 - 56	56 - 46
0.50 - 5.0	56	46
5.0 - 30.0	60	50

Note: 1. The lower limit shall apply at the transition frequencies.

2. The limit decreases in line with the logarithm of the frequency in the range of 0.15 to 0.50MHz.

4.2.2 Test Instruments

DESCRIPTION & MANUFACTURER	MODEL NO.	SERIAL NO.	CALIBRATED DATE	CALIBRATED UNTIL
Test Receiver R&S	ESCS 30	847124/029	Nov. 01, 2017	Oct. 31, 2018
Line-Impedance Stabilization Network (for EUT) R&S	ESH3-Z5	848773/004	Nov. 15, 2017	Nov. 14, 2018
Line-Impedance Stabilization Network (for Peripheral) R&S	ENV216	100072	June 04, 2018	June 03, 2019
50 ohms Terminator	N/A	EMC-04	Nov. 01, 2017	Oct. 31, 2018
RF Cable	5D-FB	COCCAB-001	Sep. 28, 2018	Sep. 27, 2019
Fixed attenuator EMCI	STI02-2200-10	003	Mar. 16, 2018	Mar. 15, 2019
Software BVADT	BVADT_Cond_ V7.3.7.4	NA	NA	NA

Note:

1. The calibration interval of the above test instruments are 12 months and the calibrations are traceable to NML/ROC and NIST/USA.
2. The test was performed in Conduction 1.
3. Tested Date: Oct. 18, 2018

4.2.3 Test Procedure

- The EUT was placed 0.4 meters from the conducting wall of the shielded room with EUT being connected to the power mains through a line impedance stabilization network (LISN). Other support units were connected to the power mains through another LISN. The two LISNs provide 50 ohm/ 50uH of coupling impedance for the measuring instrument.
- Both lines of the power mains connected to the EUT were checked for maximum conducted interference.
- The frequency range from 150kHz to 30MHz was searched. Emission levels under (Limit - 20dB) was not recorded.

Note: All modes of operation were investigated and the worst-case emissions are reported.

4.2.4 Deviation from Test Standard

No deviation.

4.2.5 Test Setup

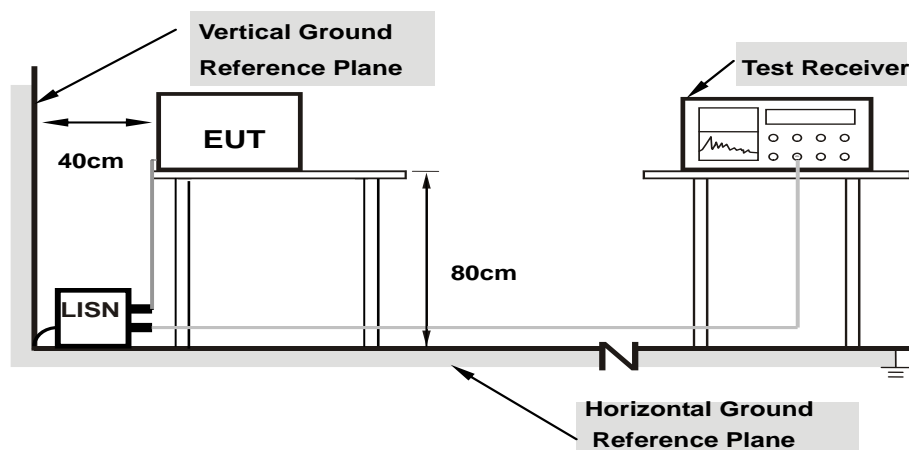

Note: 1.Support units were connected to second LISN.

For the actual test configuration, please refer to the attached file (Test Setup Photo).

4.2.6 EUT Operating Condition

Same as 4.1.6.

4.2.7 Test Results

Phase	Line (L)	Detector Function	Quasi-Peak (QP) / Average (AV)
-------	----------	-------------------	--------------------------------

No	Freq. [MHz]	Corr.	Reading Value		Emission Level		Limit		Margin	
		Factor (dB)	[dB (uV)]		[dB (uV)]		[dB (uV)]		(dB)	
			Q.P.	AV.	Q.P.	AV.	Q.P.	AV.	Q.P.	AV.
1	0.53672	10.09	26.62	24.98	36.71	35.07	56.00	46.00	-19.29	-10.93
2	0.56647	10.09	38.81	31.69	48.90	41.78	56.00	46.00	-7.10	-4.22
3	1.53516	10.16	22.71	17.47	32.87	27.63	56.00	46.00	-23.13	-18.37
4	3.03125	10.26	17.72	3.91	27.98	14.17	56.00	46.00	-28.02	-31.83
5	5.01172	10.38	22.88	11.24	33.26	21.62	60.00	50.00	-26.74	-28.38
6	18.55078	11.26	25.73	15.56	36.99	26.82	60.00	50.00	-23.01	-23.18

Remarks:

1. Q.P. and AV. are abbreviations of quasi-peak and average individually.
2. The emission levels of other frequencies were very low against the limit.
3. Margin value = Emission level – Limit value
4. Correction factor = Insertion loss + Cable loss
5. Emission Level = Correction Factor + Reading Value

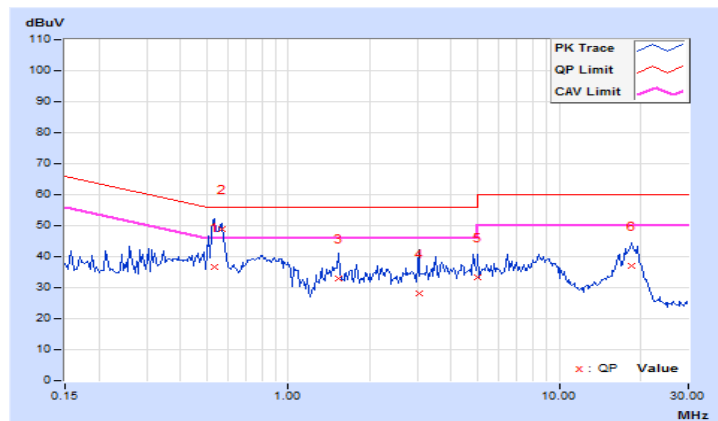

Phase	Neutral (N)	Detector Function	Quasi-Peak (QP) / Average (AV)
-------	-------------	-------------------	--------------------------------

No	Freq. [MHz]	Corr. Factor	Reading Value [dB (uV)]		Emission Level [dB (uV)]		Limit [dB (uV)]		Margin (dB)	
		(dB)	Q.P.	AV.	Q.P.	AV.	Q.P.	AV.	Q.P.	AV.
	1	0.54063	9.98	28.83	23.28	38.81	33.26	56.00	46.00	-17.19
2	0.56406	9.99	32.42	29.61	42.41	39.60	56.00	46.00	-13.59	-6.40
3	0.60313	9.99	16.33	8.69	26.32	18.68	56.00	46.00	-29.68	-27.32
4	0.73594	9.99	16.91	12.51	26.90	22.50	56.00	46.00	-29.10	-23.50
5	7.79688	10.40	16.20	6.65	26.60	17.05	60.00	50.00	-33.40	-32.95
6	18.47266	11.05	24.25	6.93	35.30	17.98	60.00	50.00	-24.70	-32.02

Remarks:

1. Q.P. and AV. are abbreviations of quasi-peak and average individually.
2. The emission levels of other frequencies were very low against the limit.
3. Margin value = Emission level – Limit value
4. Correction factor = Insertion loss + Cable loss
5. Emission Level = Correction Factor + Reading Value

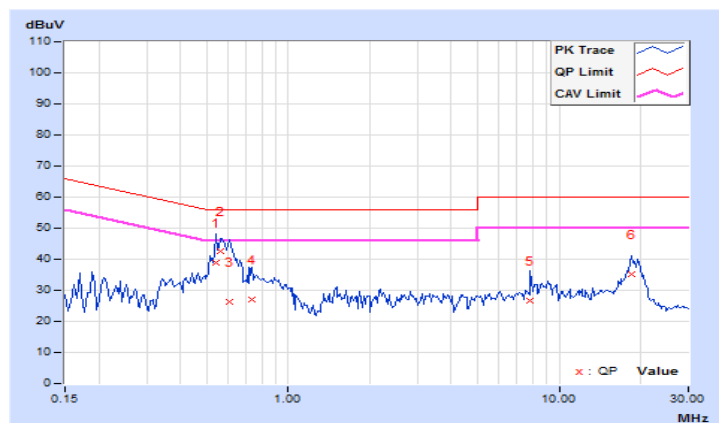

4.3 Transmit Power Measurement

4.3.1 Limits of Transmit Power Measurement

Operation Band	EUT Category		Limit
U-NII-1		Outdoor Access Point	1 Watt (30 dBm) (Max. e.i.r.p \leq 125mW(21 dBm) at any elevation angle above 30 degrees as measured from the horizon)
		Fixed point-to-point Access Point	1 Watt (30 dBm)
		Indoor Access Point	1 Watt (30 dBm)
	√	Client device	250mW (24 dBm)
U-NII-2A		√	250mW (24 dBm) or 11 dBm+10 log B*
U-NII-2C		√	250mW (24 dBm) or 11 dBm+10 log B*
U-NII-3		√	1 Watt (30 dBm)

*B is the 26 dB emission bandwidth in megahertz

4.3.2 Test Setup

FOR POWER OUTPUT MEASUREMENT

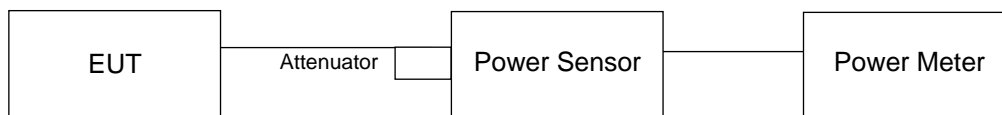

FOR 26dB OCCUPIED BANDWIDTH

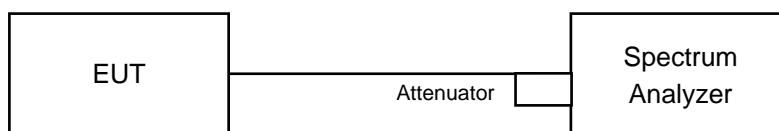

4.3.3 Test Instruments

Refer to section 4.1.2 to get information of above instrument.

4.3.4 Test Procedure

FOR POWER OUTPUT MEASUREMENT

Method PM is used to perform output power measurement, trigger and gating function of wide band power meter is enabled to measure max output power of TX on burst. Duty factor is not added to measured value.

FOR 26dB OCCUPIED BANDWIDTH

1. Set RBW = approximately 1% of the emission bandwidth.
2. Set the VBW > RBW.
3. Detector = Peak.
4. Trace mode = max hold.
5. Measure the maximum width of the emission that is 26 dB down from the peak of the emission. Compare this with the RBW setting of the analyzer. Readjust RBW and repeat measurement as needed until the RBW/EBW ratio is approximately 1%.

4.3.5 Deviation from Test Standard

No deviation.

4.3.6 EUT Operating Condition

The software provided by client to enable the EUT under transmission condition continuously at lowest, middle and highest channel frequencies individually.

4.3.7 Test Results

802.11a

POWER OUTPUT

Chan.	Chan. Freq. (MHz)	Maximum Conducted Power (mW)	Maximum Conducted Power (dBm)	Limit (dBm)	Pass / Fail
36	5180	30.409	14.83	24	Pass
40	5200	29.174	14.65	24	Pass
48	5240	29.309	14.67	24	Pass
52	5260	28.184	14.50	24	Pass
60	5300	29.107	14.64	24	Pass
64	5320	28.184	14.50	24	Pass
100	5500	24.774	13.94	24	Pass
116	5580	37.931	15.79	24	Pass
140	5700	23.933	13.79	24	Pass
149	5745	36.224	15.59	30	Pass
157	5785	35.318	15.48	30	Pass
165	5825	35.645	15.52	30	Pass

26dB OCCUPIED BANDWIDTH

Channel	Frequency (MHz)	26dBc Bandwidth (MHz)
36	5180	22.48
40	5200	24.08
48	5240	21.73
52	5260	21.65
60	5300	21.72
64	5320	21.65
100	5500	21.50
116	5580	21.66
140	5700	21.23

Note: For U-NII-2A, U-NII-2C Band output power limitation is determined based on 26dBc bandwidth

Power Limit = 11dBm + 10logB < U-NII-2A, U-NII-2C >			
Channel Number	Freq.(MHz)	Min. B(MHz)	Determined Conducted Limit (dBm)
52	5260	21.65	24.35 > 24
60	5300	21.72	24.36 > 24
64	5320	21.65	24.35 > 24
100	5500	21.50	24.32 > 24
116	5580	21.66	24.35 > 24
140	5700	21.23	24.26 > 24

802.11ac (VHT20)
POWER OUTPUT

Chan.	Chan. Freq. (MHz)	Maximum Conducted Power (mW)	Maximum Conducted Power (dBm)	Limit (dBm)	Pass / Fail
36	5180	28.249	14.51	24	Pass
40	5200	26.853	14.29	24	Pass
48	5240	26.424	14.22	24	Pass
52	5260	25.823	14.12	24	Pass
60	5300	26.73	14.27	24	Pass
64	5320	26.485	14.23	24	Pass
100	5500	22.856	13.59	24	Pass
116	5580	34.119	15.33	24	Pass
140	5700	21.777	13.38	24	Pass
149	5745	33.574	15.26	30	Pass
157	5785	32.063	15.06	30	Pass
165	5825	32.137	15.07	30	Pass

26dB OCCUPIED BANDWIDTH

Channel	Frequency (MHz)	26dBc Bandwidth (MHz)
36	5180	21.81
40	5200	28.88
48	5240	22.72
52	5260	24.00
60	5300	22.06
64	5320	21.90
100	5500	21.86
116	5580	21.94
140	5700	21.91

Note: For U-NII-2A, U-NII-2C Band output power limitation is determined based on 26dBc bandwidth

Power Limit = 11dBm + 10logB < U-NII-2A, U-NII-2C >			
Channel Number	Freq.(MHz)	Min. B(MHz)	Determined Conducted Limit (dBm)
52	5260	24.00	24.8 > 24
60	5300	22.06	24.43 > 24
64	5320	21.90	24.4 > 24
100	5500	21.86	24.39 > 24
116	5580	21.94	24.41 > 24
140	5700	21.91	24.4 > 24

802.11ac (VHT40)
POWER OUTPUT

Chan.	Chan. Freq. (MHz)	Maximum Conducted Power (mW)	Maximum Conducted Power (dBm)	Limit (dBm)	Pass / Fail
38	5190	26.669	14.26	24	Pass
46	5230	26.792	14.28	24	Pass
54	5270	26.424	14.22	24	Pass
62	5310	27.164	14.34	24	Pass
102	5510	23.335	13.68	24	Pass
110	5550	34.754	15.41	24	Pass
134	5670	24.774	13.94	24	Pass
151	5755	36.392	15.61	30	Pass
159	5795	35.156	15.46	30	Pass

26dB OCCUPIED BANDWIDTH

Channel	Frequency (MHz)	26dBc Bandwidth (MHz)
38	5190	57.06
46	5230	47.05
54	5270	49.49
62	5310	54.11
102	5510	41.46
110	5550	41.75
134	5670	41.48

Note: For U-NII-2A, U-NII-2C Band output power limitation is determined based on 26dBc bandwidth

Power Limit = 11dBm + 10logB < U-NII-2A, U-NII-2C >			
Channel Number	Freq.(MHz)	Min. B(MHz)	Determined Conducted Limit (dBm)
54	5270	49.49	27.94 > 24
62	5310	54.11	28.33 > 24
102	5510	41.46	27.17 > 24
110	5550	41.75	27.2 > 24
134	5670	41.48	27.17 > 24

802.11ac (VHT80)
POWER OUTPUT

Chan.	Chan. Freq. (MHz)	Maximum Conducted Power (mW)	Maximum Conducted Power (dBm)	Limit (dBm)	Pass / Fail
42	5210	16.52	12.18	24	Pass
58	5290	15.311	11.85	24	Pass
106	5530	19.364	12.87	24	Pass
122	5610	19.409	12.88	24	Pass
155	5775	19.231	12.84	30	Pass

26dB OCCUPIED BANDWIDTH

Channel	Frequency (MHz)	26dBc Bandwidth (MHz)
42	5210	82.30
58	5290	82.14
106	5530	82.20
122	5610	82.20

Note: For U-NII-2A, U-NII-2C Band output power limitation is determined based on 26dBc bandwidth

Power Limit = 11dBm + 10logB < U-NII-2A, U-NII-2C >			
Channel Number	Freq.(MHz)	Min. B(MHz)	Determined Conducted Limit (dBm)
58	5290	82.30	30.14 > 24
106	5530	82.20	30.14 > 24
122	5610	82.20	30.14 > 24

Spectrum Plot of Worst Value

802.11a / CH140

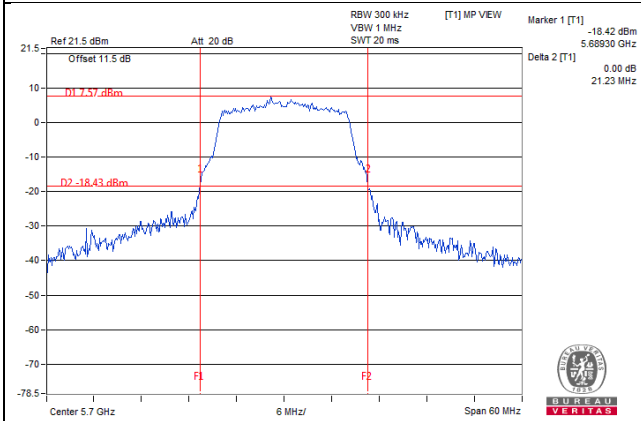

802.11ac (VHT20) / CH36

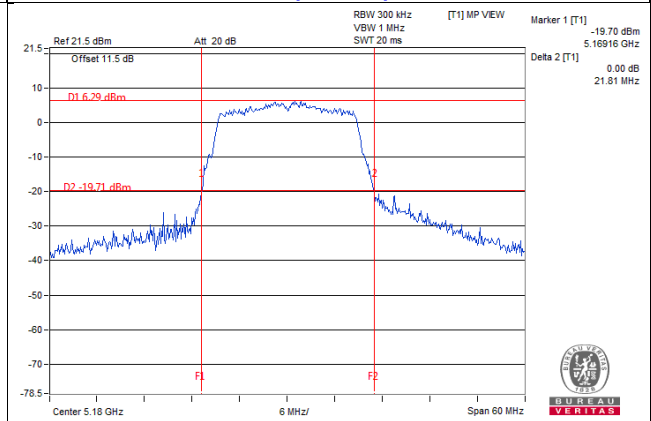

802.11ac (VHT40) / CH102

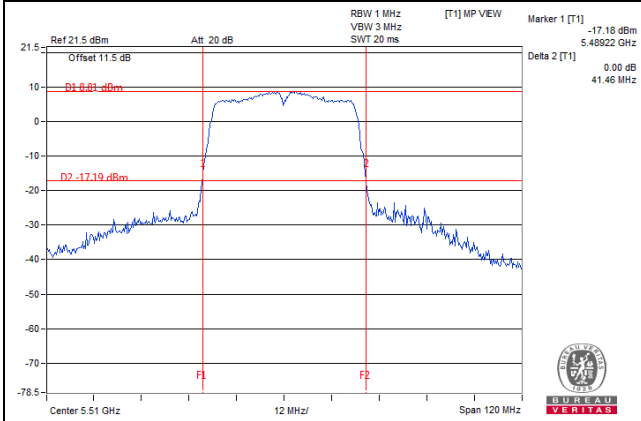

802.11ac (VHT80) / CH58

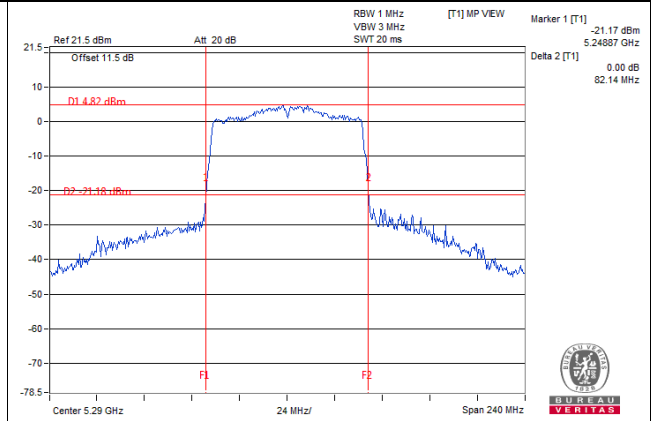

4.4 Occupied Bandwidth Measurement

4.4.1 Test Setup

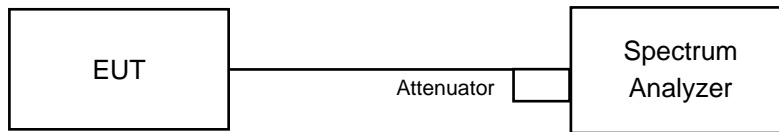

4.4.2 Test Instruments

Refer to section 4.1.2 to get information of above instrument.

4.4.3 Test Procedure

The transmitter output was connected to the spectrum analyzer through an attenuator. The bandwidth of the fundamental frequency was measured by spectrum analyzer with resolution bandwidth in the range of 1% to 5% of the anticipated emission bandwidth, and a video bandwidth at least 3x the resolution bandwidth and set the detector to SAMPLE. The width of a frequency band such that, below the lower and above the upper frequency limits, the mean powers emitted are each equal to a specified percentage 0.5 %of the total mean power of a given emission.

4.4.4 Test Results

802.11a

Channel	Channel Frequency (MHz)	Occupied Bandwidth (MHz)
36	5180	16.92
40	5200	17.16
48	5240	16.92
52	5260	16.92
60	5300	16.80
64	5320	16.92
100	5500	16.68
116	5580	16.92
140	5700	16.80
149	5745	17.04
157	5785	17.04
165	5825	16.92

802.11ac (VHT20)

Channel	Channel Frequency (MHz)	Occupied Bandwidth (MHz)
36	5180	18.00
40	5200	18.24
48	5240	17.88
52	5260	18.12
60	5300	17.88
64	5320	17.88
100	5500	17.88
116	5580	17.88
140	5700	18.00
149	5745	18.00
157	5785	18.00
165	5825	18.00

802.11ac (VHT40)

Channel	Channel Frequency (MHz)	Occupied Bandwidth (MHz)
38	5190	36.96
46	5230	36.48
54	5270	36.72
62	5310	36.72
102	5510	36.48
110	5550	36.48
134	5670	36.72
151	5755	36.72
159	5795	36.72

802.11ac (VHT80)

Channel	Channel Frequency (MHz)	Occupied Bandwidth (MHz)
42	5210	75.84
58	5290	75.36
106	5530	75.84
122	5610	75.36
155	5775	75.36

Spectrum Plot of Max. Value

802.11a / CH40

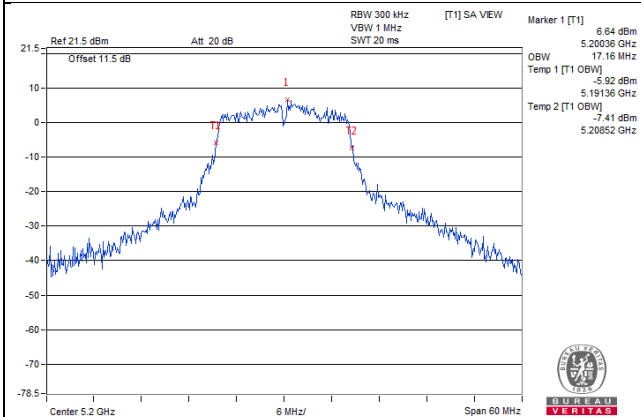

802.11ac (VHT20) / CH40

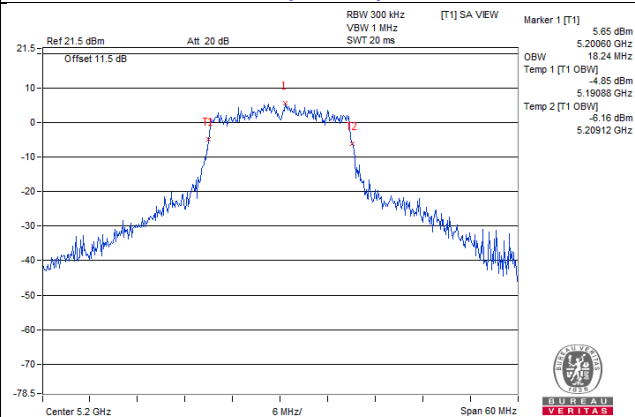

802.11ac (VHT40) / CH38

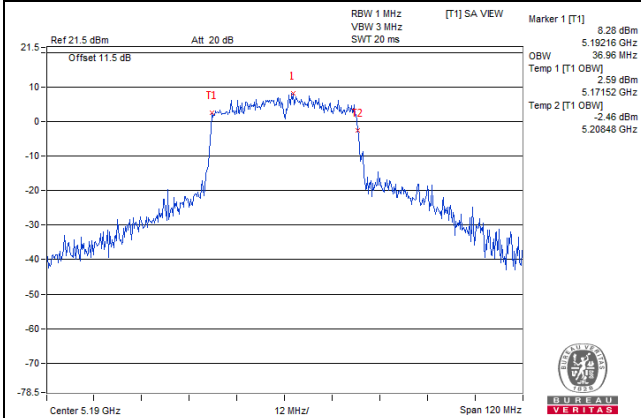

802.11ac (VHT80) / CH42

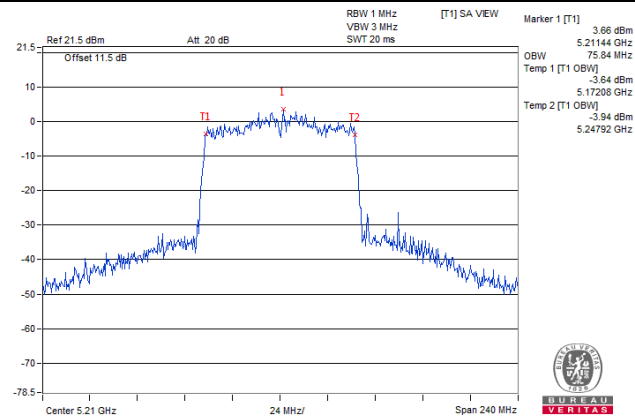

**Spectrum Plot for near by DFS band
(DFS is required, if 99% OCP straddle into U-NII-2A band)**

802.11a_Chain 0 / CH48

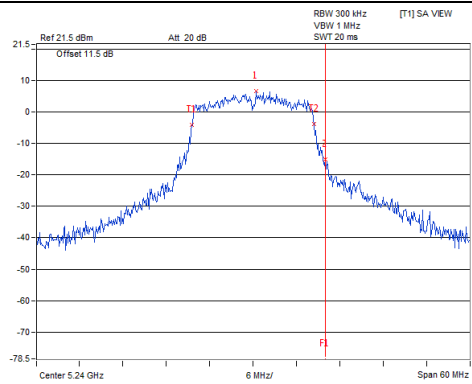

802.11ac (VHT20)_Chain 0 / CH48

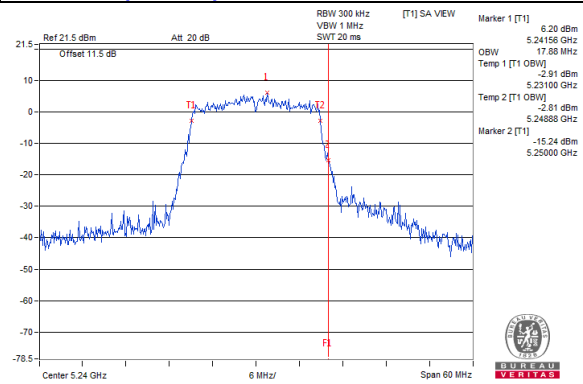

802.11ac (VHT40)_Chain 0 / CH46

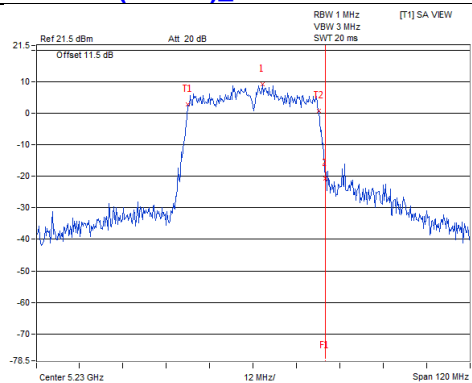

802.11ac (VHT80)_Chain 0 / CH42

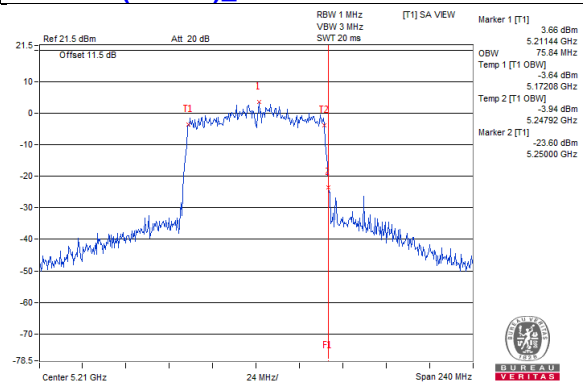

**Spectrum Plot for near by DFS band
(DFS is required, if 99% OCP straddle into U-NII-2C band)**

802.11a_Chain 0 / CH149

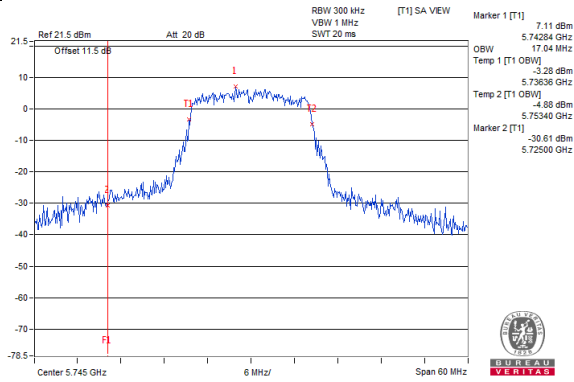

802.11ac (VHT20)_Chain 0 / CH149

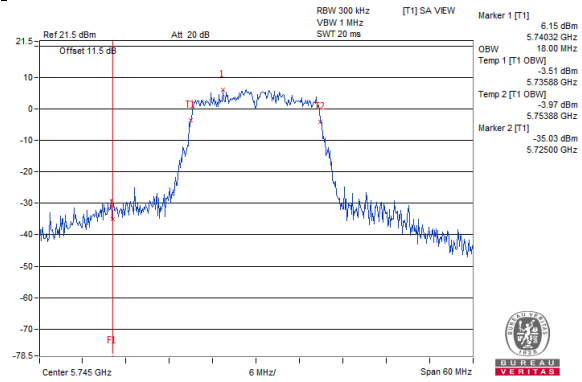

802.11ac (VHT40)_Chain 0 / CH151

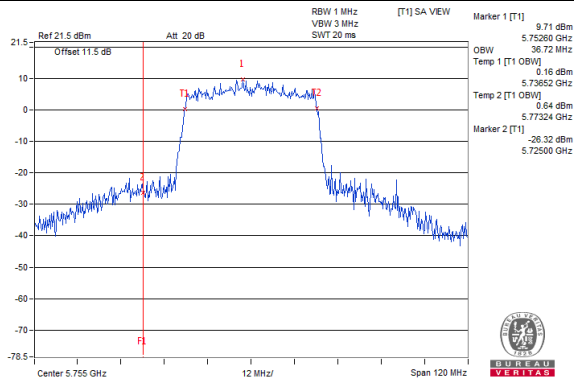

802.11ac (VHT80)_Chain 0 / CH155

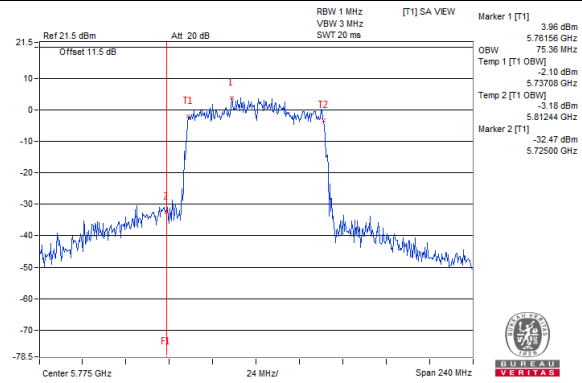

4.5 Peak Power Spectral Density Measurement

4.5.1 Limits of Peak Power Spectral Density Measurement

Operation Band	EUT Category		Limit
U-NII-1		Outdoor Access Point	17dBm/ MHz
		Fixed point-to-point Access Point	
		Indoor Access Point	
	√	Client device	11dBm/ MHz
U-NII-2A		√	11dBm/ MHz
U-NII-2C		√	11dBm/ MHz
U-NII-3		√	30dBm/ 500kHz

4.5.2 Test Setup

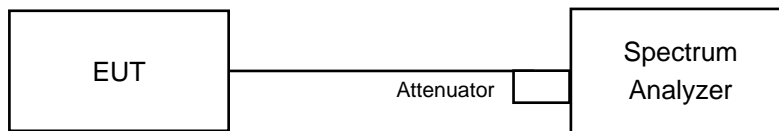

4.5.3 Test Instruments

Refer to section 4.1.2 to get information of above instrument.

4.5.4 Test Procedure

For U-NII-1, U-NII-2A, U-NII-2C band:

802.11a, 802.11ac (VHT20)

Using method SA-1

1. Set span to encompass the entire emission bandwidth (EBW) of the signal.
2. Set RBW = 1 MHz, Set VBW ≥ 3 MHz, Detector = RMS
3. Sweep time = auto, trigger set to "free run".
4. Trace average at least 100 traces in power averaging mode.
5. Record the max value

802.11ac (VHT40), 802.11ac (VHT80)

Using method SA-2

1. Set span to encompass the entire emission bandwidth (EBW) of the signal.
2. Set RBW = 1 MHz, Set VBW ≥ 3 MHz, Detector = RMS
3. Sweep time = auto, trigger set to "free run".
4. Trace average at least 100 traces in power averaging mode.
5. Record the max value and add 10 log (1/duty cycle)

For U-NII-3:

802.11a, 802.11ac (VHT20)

1. Set span to encompass the entire emission bandwidth (EBW) of the signal.
2. Set RBW = 300 kHz, Set VBW \geq 1 MHz, Detector = RMS
3. Use the peak marker function to determine the maximum power level in any 300 kHz band segment within the fundamental EBW.
4. Scale the observed power level to an equivalent value in 500 kHz by adjusting (reducing) the measured power by a bandwidth correction factor (BWCF) where $BWCF = 10\log(500\text{kHz}/300\text{kHz})$
5. Sweep time = auto, trigger set to "free run".
6. Trace average at least 100 traces in power averaging mode.
7. Record the max value

802.11ac (VHT40), 802.11ac (VHT80)

1. Set span to encompass the entire emission bandwidth (EBW) of the signal.
2. Set RBW = 300 kHz, Set VBW \geq 1 MHz, Detector = RMS
3. Use the peak marker function to determine the maximum power level in any 300 kHz band segment within the fundamental EBW.
4. Scale the observed power level to an equivalent value in 500 kHz by adjusting (reducing) the measured power by a bandwidth correction factor (BWCF) where $BWCF = 10\log(500\text{kHz}/300\text{kHz})$
5. Sweep time = auto, trigger set to "free run".
6. Trace average at least 100 traces in power averaging mode.
7. Record the max value and add $10 \log (1/\text{duty cycle})$

4.5.5 Deviation from Test Standard

No deviation.

4.5.6 EUT Operating Condition

Same as Item 4.3.6.

4.5.7 Test Results

For U-NII-1, U-NII-2A, U-NII-2C:

802.11a

Chan.	Chan. Freq. (MHz)	PSD (dBm/MHz)	Max. Limit (dBm/MHz)	Pass / Fail
36	5180	2.31	11	Pass
40	5200	2.57	11	Pass
48	5240	2.64	11	Pass
52	5260	2.71	11	Pass
60	5300	2.81	11	Pass
64	5320	2.95	11	Pass
100	5500	1.59	11	Pass
116	5580	3.86	11	Pass
140	5700	1.79	11	Pass

802.11ac (VHT20)

Chan.	Chan. Freq. (MHz)	PSD (dBm/MHz)	Max. Limit (dBm/MHz)	Pass / Fail
36	5180	1.48	11	Pass
40	5200	1.78	11	Pass
48	5240	2.09	11	Pass
52	5260	1.91	11	Pass
60	5300	2.22	11	Pass
64	5320	2.46	11	Pass
100	5500	1.01	11	Pass
116	5580	3.20	11	Pass
140	5700	1.22	11	Pass

802.11ac (VHT40)

Chan.	Chan. Freq. (MHz)	PSD W/O Duty Factor (dBm/MHz)	Duty Factor (dB)	PSD With Duty Factor (dBm/MHz)	Max. Limit (dBm/MHz)	Pass / Fail
38	5190	-1.42	0.09	-1.33	11	Pass
46	5230	-1.02	0.09	-0.93	11	Pass
54	5270	-0.96	0.09	-0.87	11	Pass
62	5310	-0.63	0.09	-0.54	11	Pass
102	5510	-1.93	0.09	-1.84	11	Pass
110	5550	0.41	0.09	0.50	11	Pass
134	5670	-2.13	0.09	-2.04	11	Pass

Note: Refer to section 3.3 for duty cycle spectrum plot.

802.11ac (VHT80)

Chan.	Chan. Freq. (MHz)	PSD W/O Duty Factor (dBm/MHz)	Duty Factor (dB)	PSD With Duty Factor (dBm/MHz)	Max. Limit (dBm/MHz)	Pass / Fail
42	5210	-6.31	0.20	-6.11	11	Pass
58	5290	-6.40	0.20	-6.20	11	Pass
106	5530	-4.90	0.20	-4.70	11	Pass
122	5610	-5.55	0.20	-5.35	11	Pass

Note: Refer to section 3.3 for duty cycle spectrum plot.

Spectrum Plot of Worst Value

802.11a / CH116

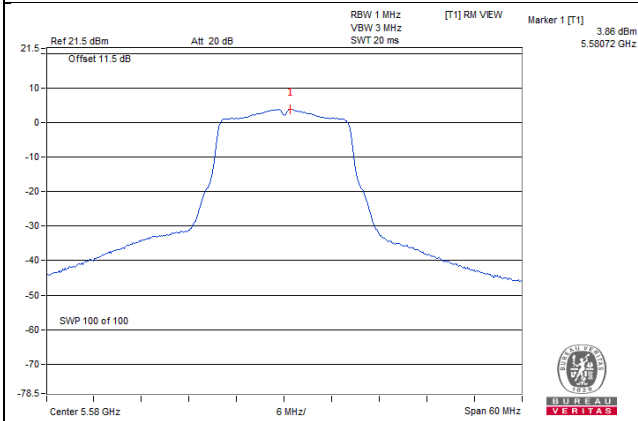

802.11ac (VHT20) / CH116

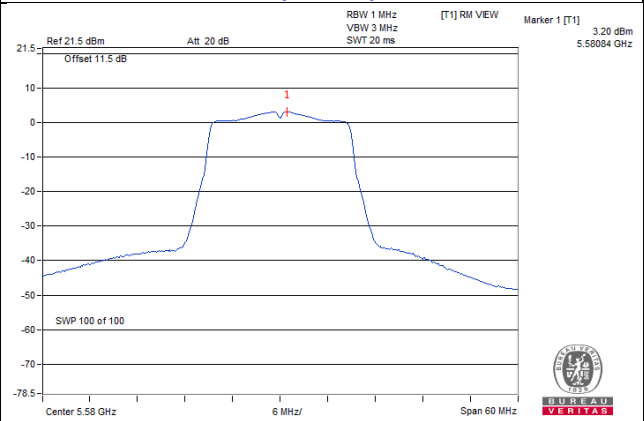

802.11ac (VHT40) / CH110

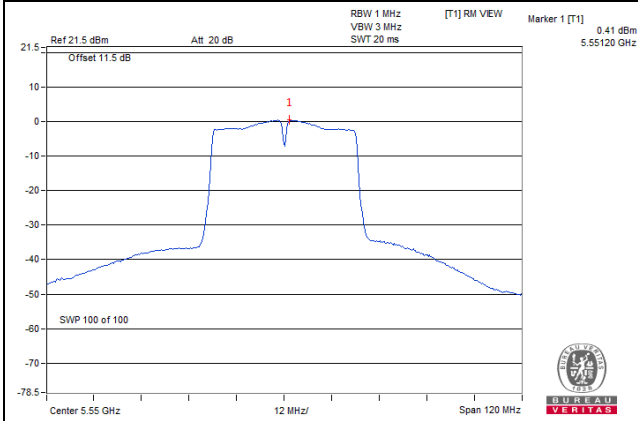

802.11ac (VHT80) / CH106

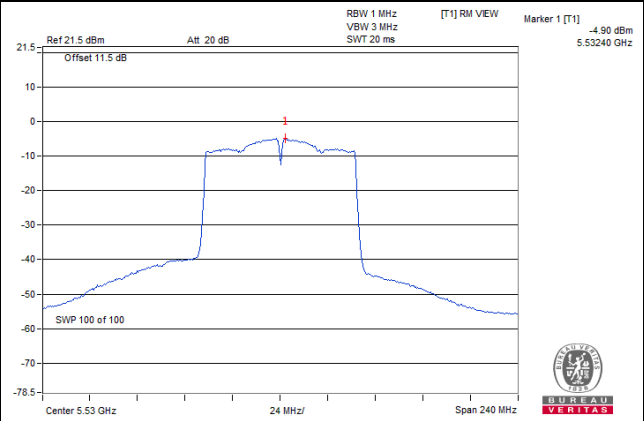

For U-NII-3:

802.11a

Chan.	Chan. Freq. (MHz)	Power Density (dBm/300kHz)	Power Density (dBm/500kHz)	Limit (dBm/500kHz)	Pass /Fail
149	5745	-4.34	-2.12	30	Pass
157	5785	-4.48	-2.26	30	Pass
165	5825	-4.51	-2.29	30	Pass

802.11ac (VHT20)

Chan.	Chan. Freq. (MHz)	Power Density (dBm/300kHz)	Power Density (dBm/500kHz)	Limit (dBm/500kHz)	Pass /Fail
149	5745	-5.19	-2.97	30	Pass
157	5785	-4.99	-2.77	30	Pass
165	5825	-4.86	-2.64	30	Pass

802.11ac (VHT40)

Chan.	Chan. Freq. (MHz)	PSD W/O Duty Factor (dBm/300kHz)	Duty Factor (dB)	PSD With Duty Factor (dBm/300kHz)	PSD With Duty Factor (dBm/500kHz)	Limit (dBm/500kHz)	Pass /Fail
151	5755	-8.69	0.09	-8.59	-6.37	30	Pass
159	5795	-8.58	0.09	-8.49	-6.27	30	Pass

Note: Refer to section 3.3 for duty cycle spectrum plot.

802.11ac (VHT80)

Chan.	Chan. Freq. (MHz)	PSD W/O Duty Factor (dBm/300kHz)	Duty Factor (dB)	PSD With Duty Factor (dBm/300kHz)	PSD With Duty Factor (dBm/500kHz)	Limit (dBm/500kHz)	Pass /Fail
155	5775	-14.51	0.20	-14.31	-12.09	30	Pass

Note: Refer to section 3.3 for duty cycle spectrum plot.

Spectrum Plot of Worst Value

802.11a / CH149

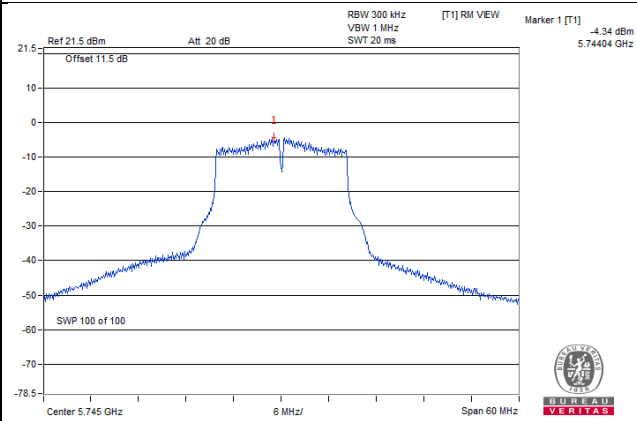

802.11ac (VHT20) / CH165

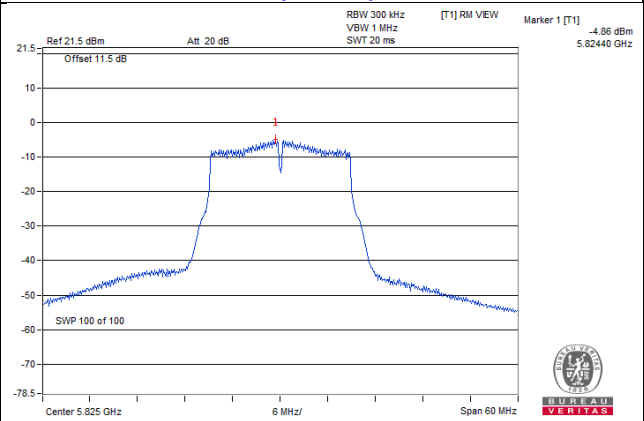

802.11ac (VHT40) / CH159

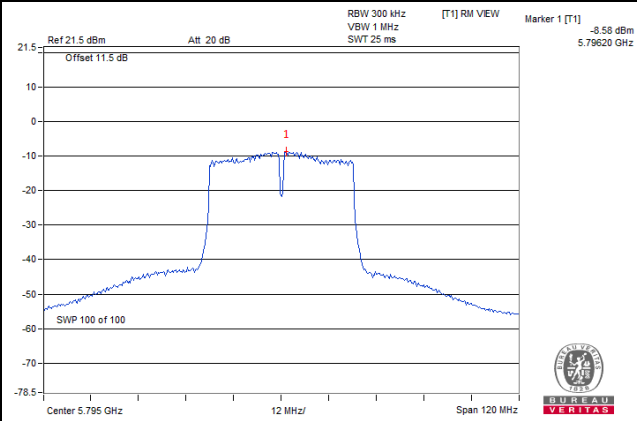

802.11ac (VHT80) / CH155

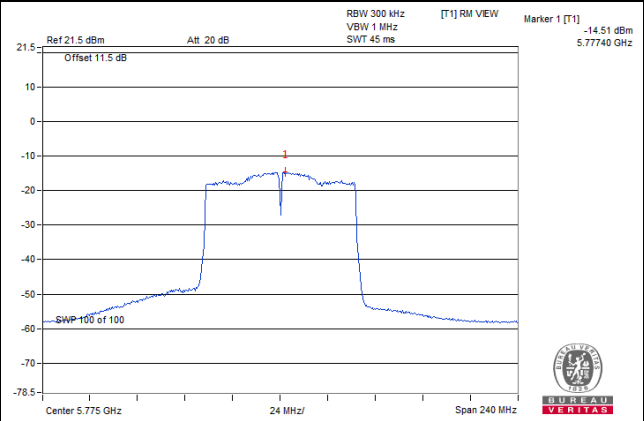

4.6 Frequency Stability Measurement

4.6.1 Limits of Frequency Stability Measurement

The frequency of the carrier signal shall be maintained within band of operation

4.6.2 Test Setup

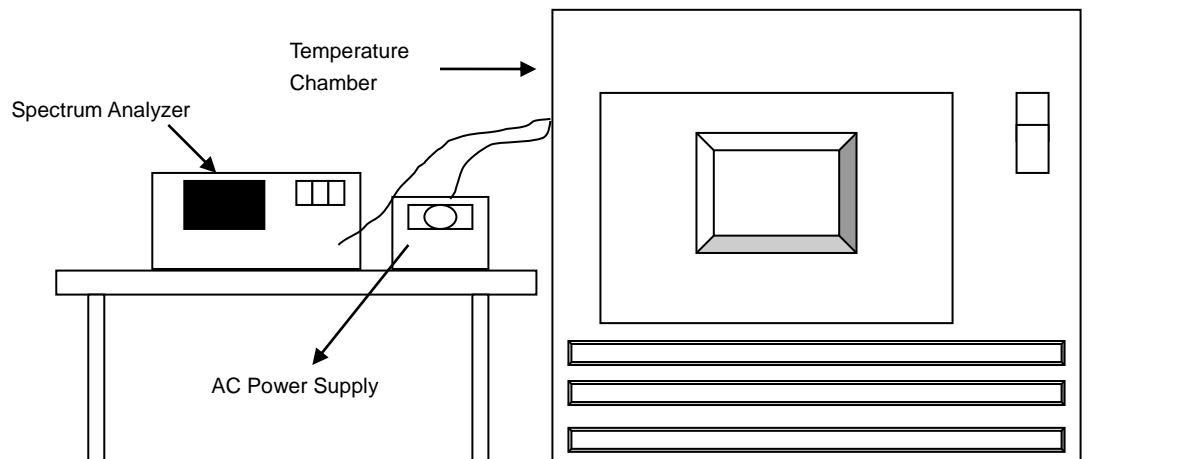

4.6.3 Test Instruments

Refer to section 4.1.2 to get information of above instrument.

4.6.4 Test Procedure

- The EUT was placed inside the environmental test chamber and powered by nominal AC voltage.
- Turn the EUT on and couple its output to a spectrum analyzer.
- Turn the EUT off and set the chamber to the highest temperature specified.
- Allow sufficient time (approximately 30 min) for the temperature of the chamber to stabilize, turn the EUT on and measure the operating frequency after 2, 5, and 10 Minutes.
- Repeat step (d) with the temperature chamber set to the next desired temperature until measurements down to the lowest specified temperature have been completed.
- The test chamber was allowed to stabilize at +20 degree C for a minimum of 30 Minutes. The supply voltage was then adjusted on the EUT from 85% to 115% and the frequency record.

4.6.5 Deviation from Test Standard

No deviation.

4.6.6 EUT Operating Condition

Set the EUT transmit at un-modulation mode to test frequency stability.

4.6.7 Test Results

Frequency Stability Versus Temp.									
Operating Frequency: 5180 MHz					Limit: within 5150 ~ 5250 MHz				
TEMP. (°C)	Power Supply (Vac)	0 Minute		2 Minutes		5 Minutes		10 Minutes	
		Measured Frequency (MHz)	Pass/Fail	Measured Frequency (MHz)	Pass/Fail	Measured Frequency (MHz)	Pass/Fail	Measured Frequency (MHz)	Pass/Fail
50	120	5180.0239	Pass	5180.0247	Pass	5180.0211	Pass	5180.0233	Pass
40	120	5179.9836	Pass	5179.9847	Pass	5179.9839	Pass	5179.9836	Pass
30	120	5179.9963	Pass	5180.0008	Pass	5179.9963	Pass	5179.9997	Pass
20	120	5179.9796	Pass	5179.9775	Pass	5179.9792	Pass	5179.9794	Pass
10	120	5179.9947	Pass	5179.9984	Pass	5179.9943	Pass	5179.9945	Pass
0	120	5180.0211	Pass	5180.0195	Pass	5180.0185	Pass	5180.0177	Pass
-10	120	5179.9761	Pass	5179.9761	Pass	5179.9767	Pass	5179.979	Pass
-20	120	5180.005	Pass	5180.0086	Pass	5180.007	Pass	5180.0067	Pass
-30	120	5179.99	Pass	5179.9868	Pass	5179.9876	Pass	5179.9892	Pass

Frequency Stability Versus Voltage									
Operating Frequency: 5180 MHz					Limit: within 5150 ~ 5250 MHz				
TEMP. (°C)	Power Supply (Vac)	0 Minute		2 Minutes		5 Minutes		10 Minutes	
		Measured Frequency (MHz)	Pass/Fail	Measured Frequency (MHz)	Pass/Fail	Measured Frequency (MHz)	Pass/Fail	Measured Frequency (MHz)	Pass/Fail
20	138	5179.9794	Pass	5179.9782	Pass	5179.9784	Pass	5179.9798	Pass
	120	5179.9796	Pass	5179.9775	Pass	5179.9792	Pass	5179.9794	Pass
	102	5179.9796	Pass	5179.9776	Pass	5179.9796	Pass	5179.9784	Pass

4.7 6dB Bandwidth Measurement

4.7.1 Limits of 6dB Bandwidth Measurement

The minimum of 6dB Bandwidth Measurement is 0.5MHz.

4.7.2 Test Setup

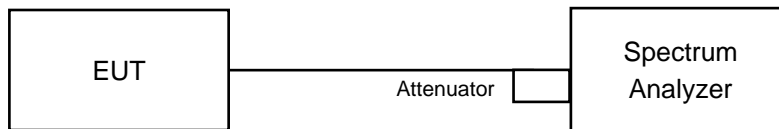

4.7.3 Test Instruments

Refer to section 4.1.2 to get information of above instrument.

4.7.4 Test Procedure

MEASUREMENT PROCEDURE REF

- Set resolution bandwidth (RBW) = 100kHz
- Set the video bandwidth (VBW) $\geq 3 \times$ RBW, Detector = Peak.
- Trace mode = max hold.
- Sweep = auto couple.
- Measure the maximum width of the emission that is constrained by the frequencies associated with the two amplitude points (upper and lower) that are attenuated by 6 dB relative to the maximum level measured in the fundamental emission

4.7.5 Deviation from Test Standard

No deviation.

4.7.6 EUT Operating Condition

The software provided by client to enable the EUT under transmission condition continuously at lowest, middle and highest channel frequencies individually.

4.7.7 Test Results

802.11a

Channel	Frequency (MHz)	6dB Bandwidth (MHz)	Minimum Limit (MHz)	Pass / Fail
149	5745	16.39	0.5	Pass
157	5785	16.38	0.5	Pass
165	5825	16.39	0.5	Pass

802.11ac (VHT20)

Channel	Frequency (MHz)	6dB Bandwidth (MHz)	Minimum Limit (MHz)	Pass / Fail
149	5745	17.62	0.5	Pass
157	5785	17.36	0.5	Pass
165	5825	17.56	0.5	Pass

802.11ac (VHT40)

Channel	Frequency (MHz)	6dB Bandwidth (MHz)	Minimum Limit (MHz)	Pass / Fail
151	5755	36.07	0.5	Pass
159	5795	35.74	0.5	Pass

802.11ac (VHT80)

Channel	Frequency (MHz)	6dB Bandwidth (MHz)	Minimum Limit (MHz)	Pass / Fail
155	5775	75.55	0.5	Pass

Spectrum Plot of Worst Value

802.11a / CH157

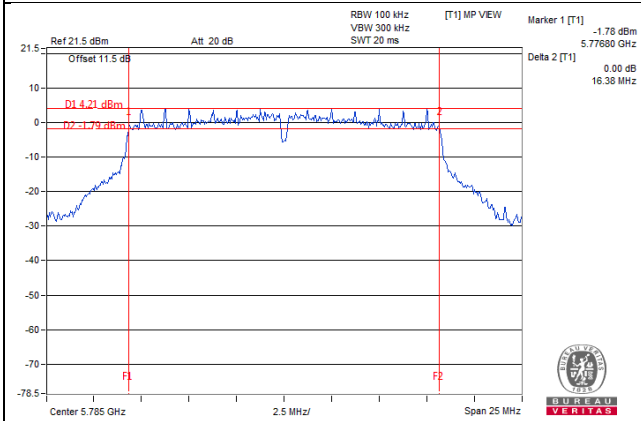

802.11ac (VHT20) / CH157

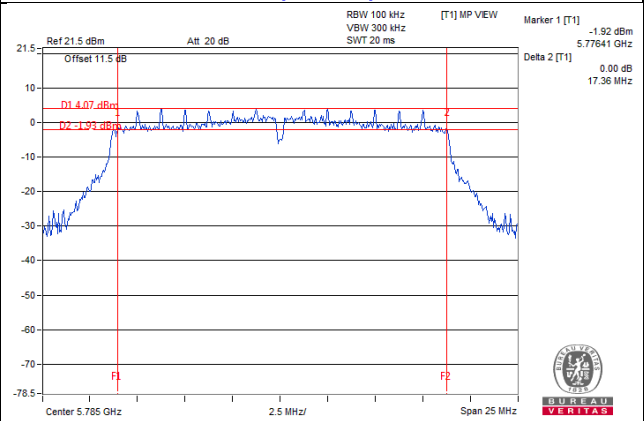

802.11ac (VHT40) / CH159

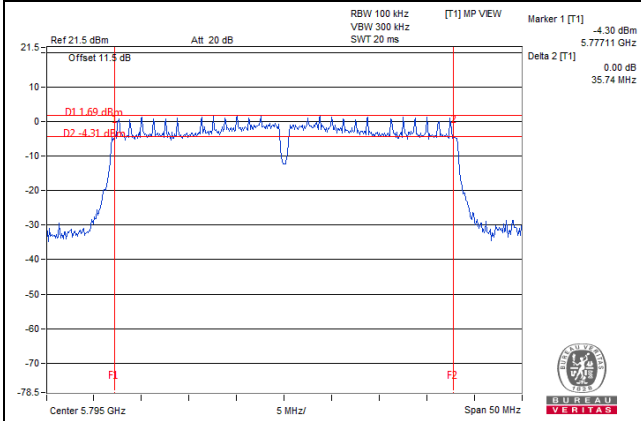

802.11ac (VHT80) / CH155

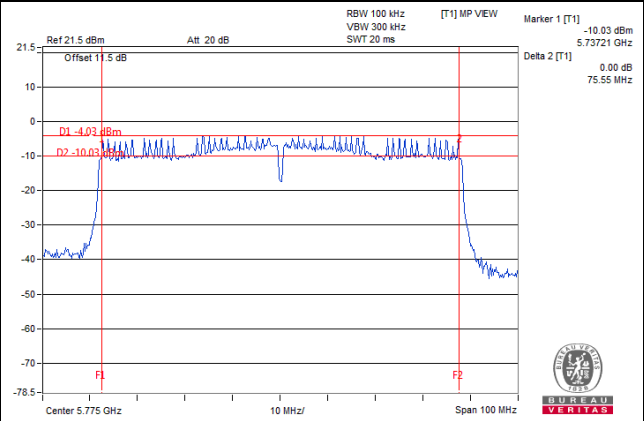

5 Pictures of Test Arrangements

Please refer to the attached file (Test Setup Photo).

Annex A- Radiated Out of Band Emission (OOBE) Measurement (For U-NII-3 band)

802.11a

CH 149 5745 MHz

Horizontal

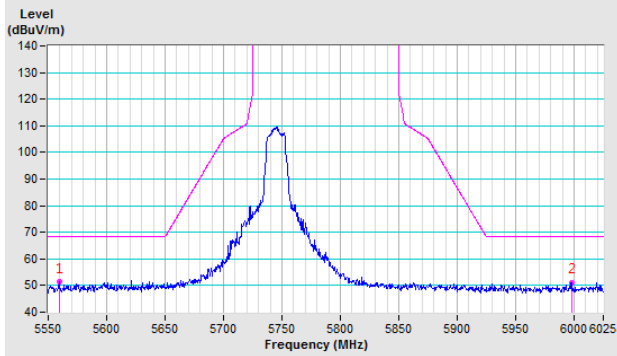

Vertical

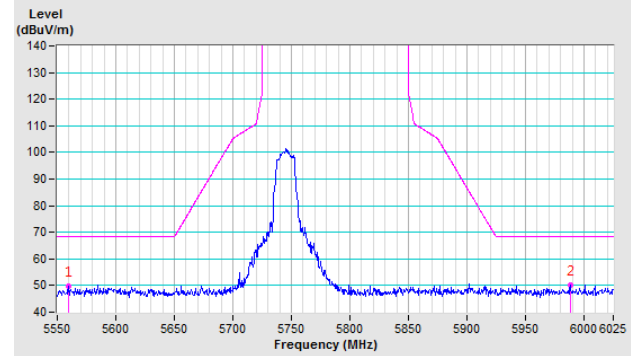

CH 157 5785 MHz

Horizontal

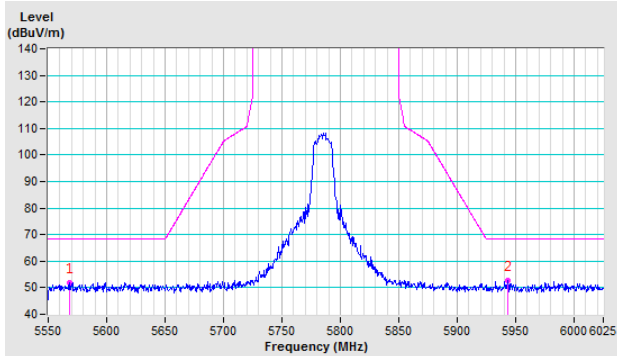

Vertical

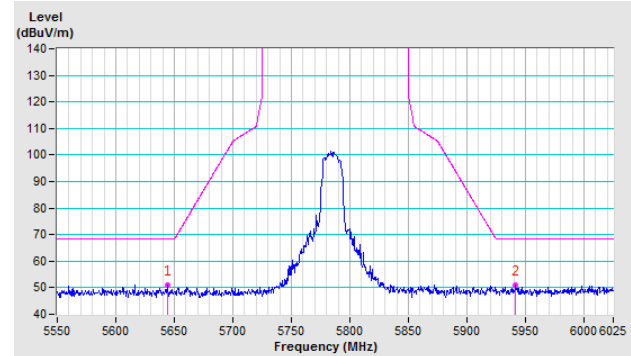

CH 165 5825 MHz

Horizontal

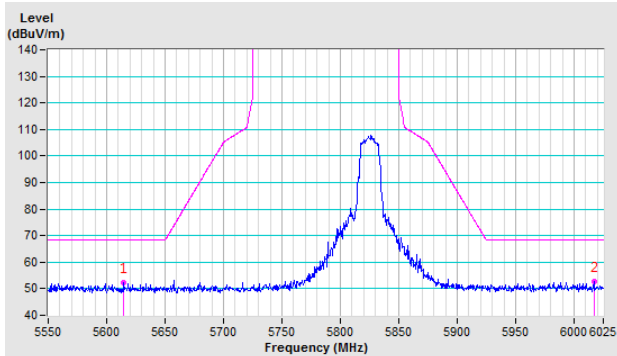

Vertical

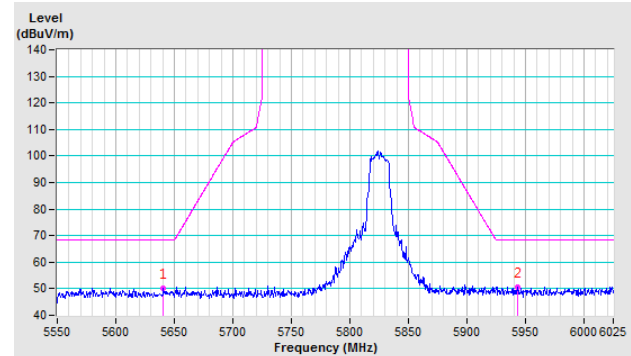

802.11ac (VHT20)

CH 149 5745 MHz

Horizontal

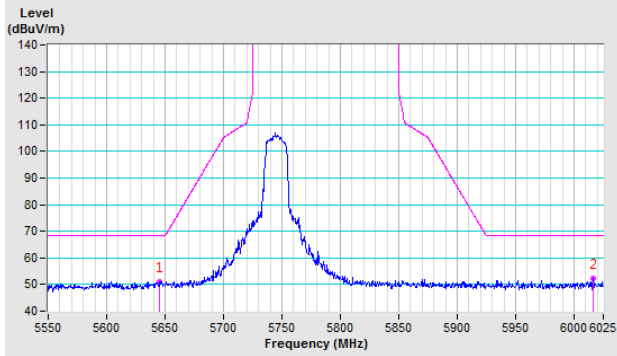

Vertical

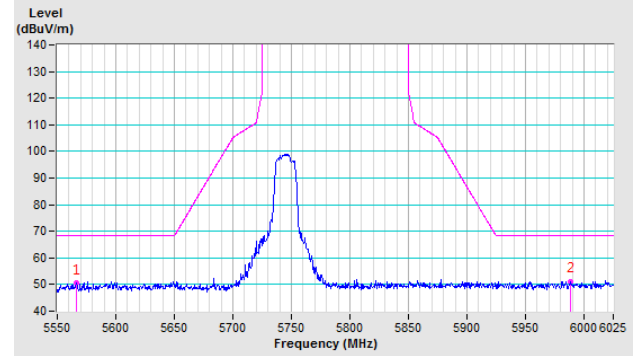

CH 157 5785 MHz

Horizontal

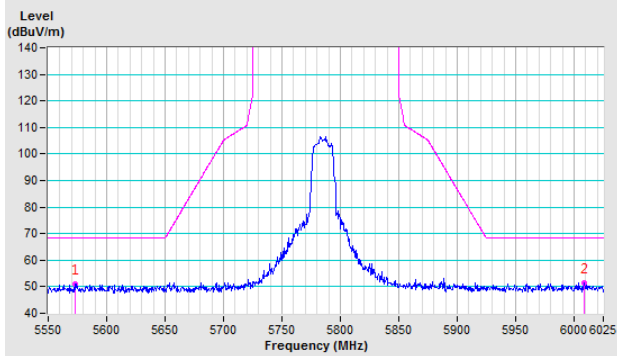

Vertical

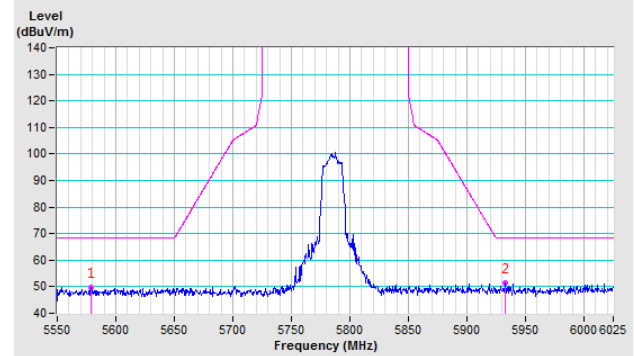

CH 165 5825 MHz

Horizontal

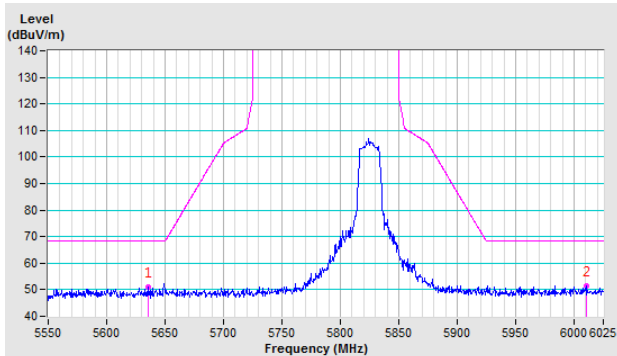

Vertical

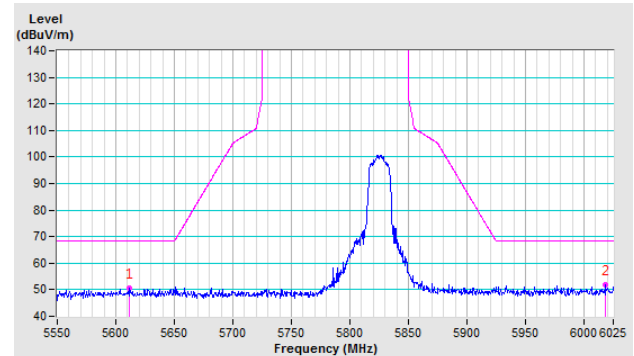

802.11ac (VHT40)

CH 151 5755 MHz

Horizontal

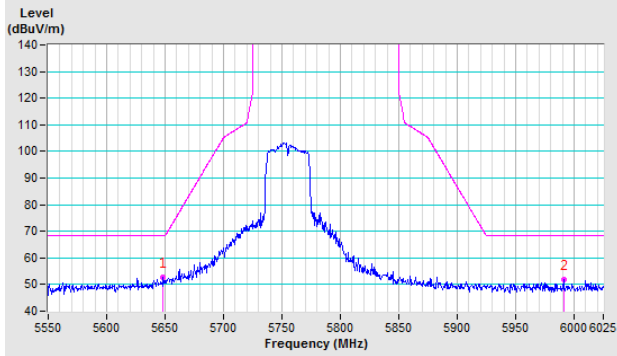

Vertical

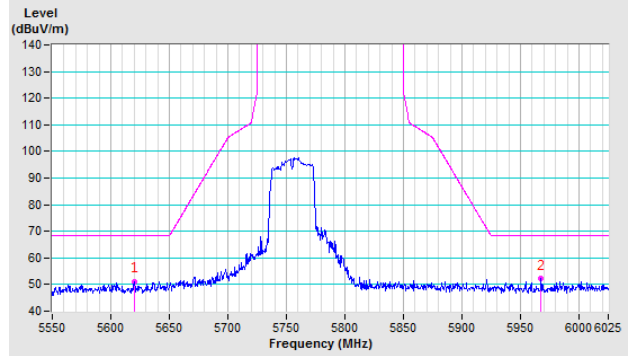

CH 159 5795 MHz

Horizontal

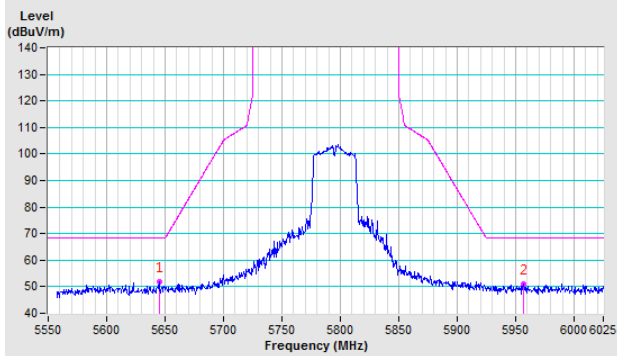

Vertical

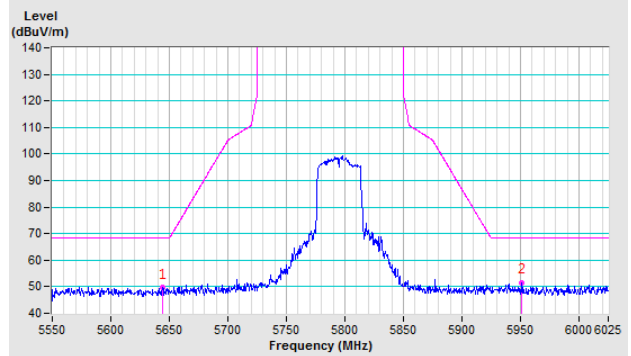

802.11ac (VHT80)

CH 155 5775 MHz

Horizontal

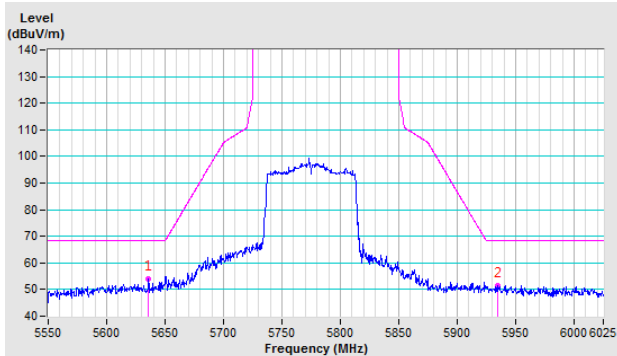

Vertical

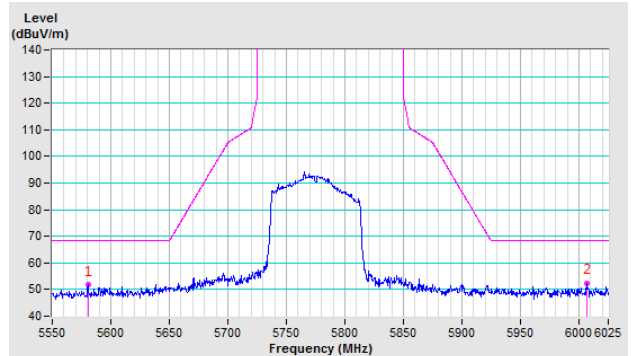

Appendix – Information on the Testing Laboratories

We, Bureau Veritas Consumer Products Services (H.K.) Ltd., Taoyuan Branch, were founded in 1988 to provide our best service in EMC, Radio, Telecom and Safety consultation. Our laboratories are FCC recognized accredited test firms and accredited according to ISO/IEC 17025.

If you have any comments, please feel free to contact us at the following:

Linkou EMC/RF Lab

Tel: 886-2-26052180

Fax: 886-2-26051924

Hsin Chu EMC/RF/Telecom Lab

Tel: 886-3-6668565

Fax: 886-3-6668323

Hwa Ya EMC/RF/Safety Lab

Tel: 886-3-3183232

Fax: 886-3-3270892

Email: service.adt@tw.bureauveritas.com

Web Site: www.bureauveritas-adt.com

The address and road map of all our labs can be found in our web site also.

--- END ---