

## FCC Test Report

**Report No.:** RF160511E07

**FCC ID:** JNZNR0012

**Test Model:** N-R0012

**Received Date:** May 11, 2016

**Test Date:** May 17 to 18, 2016

**Issued Date:** May 25, 2016

**Applicant:** LOGITECH FAR EAST LTD.

**Address:** #2 Creation Rd. 4, Science-Based Ind. Park Hsinchu Taiwan, R.O.C.

**Issued By:** Bureau Veritas Consumer Products Services (H.K.) Ltd., Taoyuan Branch  
Hsin Chu Laboratory

**Lab Address:** E-2, No.1, Li Hsin 1st Road, Hsinchu Science Park, Hsinchu City 300,  
Taiwan R.O.C.

**Test Location:** E-2, No.1, Li Hsin 1st Road, Hsinchu Science Park, Hsinchu City 300,  
Taiwan R.O.C.



This report is for your exclusive use. Any copying or replication of this report to or for any other person or entity, or use of our name or trademark, is permitted only with our prior written permission. This report sets forth our findings solely with respect to the test samples identified herein. The results set forth in this report are not indicative or representative of the quality or characteristics of the lot from which a test sample was taken or any similar or identical product unless specifically and expressly noted. Our report includes all of the tests requested by you and the results thereof based upon the information that you provided to us. You have 60 days from date of issuance of this report to notify us of any material error or omission caused by our negligence, provided, however, that such notice shall be in writing and shall specifically address the issue you wish to raise. A failure to raise such issue within the prescribed time shall constitute your unqualified acceptance of the completeness of this report, the tests conducted and the correctness of the report contents. Unless specific mention, the uncertainty of measurement has been explicitly taken into account to declare the compliance or non-compliance to the specification. The report must not be used by the client to claim product certification, approval, or endorsement by TAF or any government agencies.

## Table of Contents

<b>Release Control Record</b> .....	<b>4</b>
<b>1 Certificate of Conformity</b> .....	<b>5</b>
<b>2 Summary of Test Results</b> .....	<b>6</b>
2.1 Measurement Uncertainty .....	6
2.2 Modification Record .....	6
<b>3 General Information</b> .....	<b>7</b>
3.1 General Description of EUT .....	7
3.2 Description of Test Modes .....	8
3.2.1 Test Mode Applicability and Tested Channel Detail .....	9
3.3 Duty Cycle of Test Signal .....	10
3.4 Description of Support Units .....	11
3.4.1 Configuration of System under Test .....	11
3.5 General Description of Applied Standards .....	12
<b>4 Test Types and Results</b> .....	<b>13</b>
4.1 Radiated Emission and Bandedge Measurement .....	13
4.1.1 Limits of Radiated Emission and Bandedge Measurement .....	13
4.1.2 Test Instruments .....	14
4.1.3 Test Procedures .....	15
4.1.4 Deviation from Test Standard .....	15
4.1.5 Test Set Up .....	16
4.1.6 EUT Operating Conditions .....	16
4.1.7 Test Results .....	17
4.2 6dB Bandwidth Measurement .....	21
4.2.1 Limits of 6dB Bandwidth Measurement .....	21
4.2.2 Test Setup .....	21
4.2.3 Test Instruments .....	21
4.2.4 Test Procedure .....	21
4.2.5 Deviation from Test Standard .....	21
4.2.6 EUT Operating Conditions .....	21
4.2.7 Test Result .....	22
4.3 Conducted Output Power Measurement .....	23
4.3.1 Limits OF Conducted Output Power Measurement .....	23
4.3.2 Test Setup .....	23
4.3.3 Test Instruments .....	23
4.3.4 Test Procedures .....	23
4.3.5 Deviation from Test Standard .....	23
4.3.6 EUT Operating Conditions .....	23
4.3.7 Test Results .....	24
4.4 Power Spectral Density Measurement .....	25
4.4.1 Limits of Power Spectral Density Measurement .....	25
4.4.2 Test Setup .....	25
4.4.3 Test Instruments .....	25
4.4.4 Test Procedure .....	25
4.4.5 Deviation from Test Standard .....	25
4.4.6 EUT Operating Condition .....	25
4.4.7 Test Results .....	26
4.5 Conducted Out of Band Emission Measurement .....	27
4.5.1 Limits of Conducted Out of Band Emission Measurement .....	27
4.5.2 Test Setup .....	27
4.5.3 Test Instruments .....	27
4.5.4 Test Procedure .....	27
4.5.5 Deviation from Test Standard .....	27
4.5.6 EUT Operating Condition .....	27

4.5.7 Test results .....	28
<b>5 Pictures of Test Arrangements.....</b>	<b>29</b>
<b>Appendix – Information on the Testing Laboratories .....</b>	<b>30</b>

### Release Control Record

Issue No.	Description	Date Issued
RF160511E07	Original release.	May 25, 2016

## 1 Certificate of Conformity

**Product:** Button

**Brand:** Logitech

**Test Model:** N-R0012

**Sample Status:** ENGINEERING SAMPLE

**Applicant:** LOGITECH FAR EAST LTD.

**Test Date:** May 17 to 18, 2016

**Standards:** 47 CFR FCC Part 15, Subpart C (Section 15.247)  
ANSI C63.10: 2013

The above equipment has been tested by **Bureau Veritas Consumer Products Services (H.K.) Ltd., Taoyuan Branch**, and found compliance with the requirement of the above standards. The test record, data evaluation & Equipment Under Test (EUT) configurations represented herein are true and accurate accounts of the measurements of the sample's EMC characteristics under the conditions specified in this report.

**Prepared by :** Wendy Wu. , **Date:** May 25, 2016  
Wendy Wu / Specialist

**Approved by :** May Chen , **Date:** May 25, 2016  
May Chen / Manager

## 2 Summary of Test Results

47 CFR FCC Part 15, Subpart C (SECTION 15.247)			
FCC Clause	Test Item	Result	Remarks
15.207	AC Power Conducted Emission	NA	Power supply is 3Vdc from battery
15.205 & 209 & 15.247(d)	Radiated Emissions & Band Edge Measurement	PASS	Meet the requirement of limit. Minimum passing margin is -3.5dB at 118.49MHz.
15.247(d)	Antenna Port Emission	PASS	Meet the requirement of limit.
15.247(a)(2)	6dB bandwidth	PASS	Meet the requirement of limit.
15.247(b)	Conducted power	PASS	Meet the requirement of limit.
15.247(e)	Power Spectral Density	PASS	Meet the requirement of limit.
15.203	Antenna Requirement	PASS	No antenna connector is used.

### 2.1 Measurement Uncertainty

Where relevant, the following measurement uncertainty levels have been estimated for tests performed on the EUT as specified in CISPR 16-4-2:

Measurement	Frequency	Expanded Uncertainty (k=2) ( $\pm$ )
Radiated Emissions up to 1 GHz	30MHz ~ 1GHz	5.19 dB
Radiated Emissions above 1 GHz	1GHz ~ 6GHz	3.43 dB
	6GHz ~ 18GHz	3.49 dB
	18GHz ~ 40GHz	4.11 dB

### 2.2 Modification Record

There were no modifications required for compliance.

### 3 General Information

#### 3.1 General Description of EUT

Product	Button
Brand	Logitech
Test Model	N-R0012
Status of EUT	ENGINEERING SAMPLE
Power Supply Rating	DC 3V from battery
Modulation Type	GFSK
Modulation Technology	DTS
Transfer Rate	Up to 1Mbps
Operating Frequency	2402MHz ~ 2480MHz
Number of Channel	40
Output Power	4.159mW
Antenna Type	Refer to Note
Antenna Connector	NA
Accessory Device	NA
Data Cable Supplied	NA

Note:

1. The EUT may have a lot of colors for marketing requirement.
2. The antennas provided to the EUT, please refer to the following table:

Antenna Gain (dBi)	Frequency range (GHz to GHz)	Antenna Type	Connector Type
3.8	2.4-2.4835	PCB printed Antenna	NA

3. The above EUT information is declared by manufacturer and for more detailed features description, please refer to the manufacturer's specifications or user's manual.

### 3.2 Description of Test Modes

40 channels are provided to this EUT:

CHANNEL	FREQ. (MHz)	CHANNEL	FREQ. (MHz)	CHANNEL	FREQ. (MHz)	CHANNEL	FREQ. (MHz)
0	2402	10	2422	20	2442	30	2462
1	2404	11	2424	21	2444	31	2464
2	2406	12	2426	22	2446	32	2466
3	2408	13	2428	23	2448	33	2468
4	2410	14	2430	24	2450	34	2470
5	2412	15	2432	25	2452	35	2472
6	2414	16	2434	26	2454	36	2474
7	2416	17	2436	27	2456	37	2476
8	2418	18	2438	28	2458	38	2478
9	2420	19	2440	29	2460	39	2480



### 3.2.1 Test Mode Applicability and Tested Channel Detail

EUT CONFIGURE MODE	APPLICABLE TO				DESCRIPTION
	RE $\geq$ 1G	RE<1G	PLC	APCM	
-	√	√	-	√	-

Where **RE $\geq$ 1G**: Radiated Emission above 1GHz      **RE<1G**: Radiated Emission below 1GHz  
**PLC**: Power Line Conducted Emission      **APCM**: Antenna Port Conducted Measurement

**NOTE:** 1. The EUT had been pre-tested on the positioned of each 3 axis. The worst case was found when positioned on **Y-plane (below 1GHz)** and **X-plane (above 1GHz)**.

2. No need to concern of Conducted Emission due to the EUT is powered by battery.

#### **Radiated Emission Test (Above 1GHz):**

- Pre-Scan has been conducted to determine the worst-case mode from all possible combinations between available modulations, data rates and antenna ports (if EUT with antenna diversity architecture).
- Following channel(s) was (were) selected for the final test as listed below.

AVAILABLE CHANNEL	TESTED CHANNEL	MODULATION TYPE
0 to 39	0, 19, 39	GFSK

#### **Radiated Emission Test (Below 1GHz):**

- Pre-Scan has been conducted to determine the worst-case mode from all possible combinations between available modulations, data rates and antenna ports (if EUT with antenna diversity architecture).
- Following channel(s) was (were) selected for the final test as listed below.

AVAILABLE CHANNEL	TESTED CHANNEL	MODULATION TYPE
0 to 39	0	GFSK

#### **Antenna Port Conducted Measurement:**

- This item includes all test value of each mode, but only includes spectrum plot of worst value of each mode.
- Pre-Scan has been conducted to determine the worst-case mode from all possible combinations between available modulations, data rates and antenna ports (if EUT with antenna diversity architecture).
- Following channel(s) was (were) selected for the final test as listed below.

AVAILABLE CHANNEL	TESTED CHANNEL	MODULATION TYPE
0 to 39	0, 19, 39	GFSK

#### **Test Condition:**

APPLICABLE TO	ENVIRONMENTAL CONDITIONS	INPUT POWER	TESTED BY
RE $\geq$ 1G	25deg. C, 79%RH	120Vac, 60Hz	Andy Ho
RE<1G	26deg. C, 69%RH	120Vac, 60Hz	Andy Ho
APCM	24deg. C, 66%RH	120Vac, 60Hz	Anderson Chen

Note: The fresh battery was used during testing.

### 3.3 Duty Cycle of Test Signal

Duty cycle of test signal is 100 %, duty factor is not required

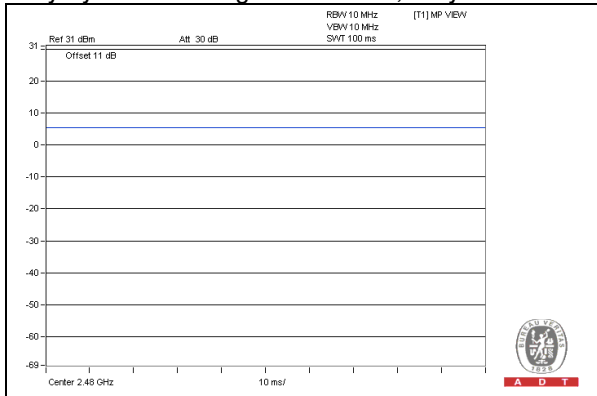

### 3.4 Description of Support Units

The EUT has been tested as an independent unit together with other necessary accessories or support units. The following support units or accessories were used to form a representative test configuration during the tests.

ID	Product	Brand	Model No.	Serial No.	FCC ID	Remarks
A.	Notebook Computer	DELL	PP32LA	DSL32S	FCC DoC	Provided by Lab
B.	Test tool	NA	NA	NA	NA	Supplied by client
C.	iPod shuffle	Apple	MC749TA/A	CC4DMFKUDFDM	NA	Provided by Lab

Note:

1. All power cords of the above support units are non-shielded (1.8m).

ID	Descriptions	Qty.	Length (m)	Shielding (Yes/No)	Cores (Qty.)	Remarks
1.	Micro USB cable	1	0.5	Yes	0	Supplied by client
2.	Console cable	1	0.4	No	0	Supplied by client
3.	USB cable	1	0.1	Yes	0	Provided by Lab

#### 3.4.1 Configuration of System under Test

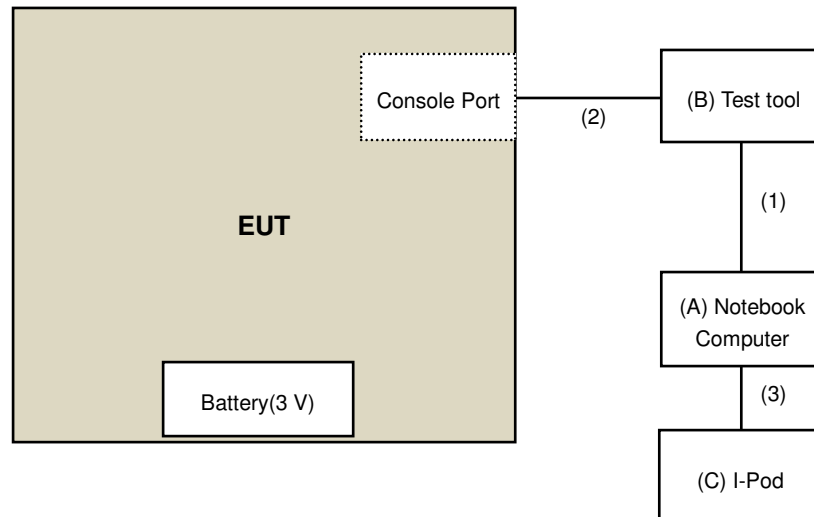

### 3.5 General Description of Applied Standards

The EUT is a RF Product. According to the specifications of the manufacturer, it must comply with the requirements of the following standards:

**FCC Part 15, Subpart C (15.247)**  
**KDB 558074 D01 DTS Meas Guidance v03r05**  
ANSI C63.10-2013

All test items have been performed and recorded as per the above standards.

## 4 Test Types and Results

### 4.1 Radiated Emission and Bandedge Measurement

#### 4.1.1 Limits of Radiated Emission and Bandedge Measurement

Radiated emissions which fall in the restricted bands must comply with the radiated emission limits specified as below table. Other emissions shall be at least 20dB below the highest level of the desired power:

Frequencies (MHz)	Field Strength (microvolts/meter)	Measurement Distance (meters)
0.009 ~ 0.490	2400/F(kHz)	300
0.490 ~ 1.705	24000/F(kHz)	30
1.705 ~ 30.0	30	30
30 ~ 88	100	3
88 ~ 216	150	3
216 ~ 960	200	3
Above 960	500	3

#### NOTE:

1. The lower limit shall apply at the transition frequencies.
2. Emission level (dBuV/m) = 20 log Emission level (uV/m).
3. For frequencies above 1000MHz, the field strength limits are based on average detector, however, the peak field strength of any emission shall not exceed the maximum permitted average limits, specified above by more than 20dB under any condition of modulation.

## 4.1.2 Test Instruments

DESCRIPTION & MANUFACTURER	MODEL NO.	SERIAL NO.	CALIBRATED DATE	CALIBRATED UNTIL
Test Receiver Agilent	N9038A	MY54450088	July 24, 2015	July 23, 2016
Pre-Amplifier <sup>(*)</sup> EMCI	EMC001340	980142	Jan. 20, 2016	Jan. 19, 2018
Loop Antenna <sup>(*)</sup> Electro-Metrics	EM-6879	264	Dec. 16, 2014	Dec. 15, 2016
RF Cable	NA	LOOPCAB-001 LOOPCAB-002	Jan. 18, 2016	Jan. 17, 2017
Pre-Amplifier Mini-Circuits	ZFL-1000VH2B	AMP-ZFL-01	Nov. 11, 2015	Nov. 10, 2016
Trilog Broadband Antenna SCHWARZBECK	VULB 9168	9168-406	Jan. 04, 2016	Jan. 03, 2017
RF Cable	8D	966-4-1 966-4-2 966-4-3	Apr. 02, 2016	Apr. 01, 2017
Horn Antenna SCHWARZBECK	BBHA 9120D	9120D-783	Jan. 19, 2016	Jan. 18, 2017
Pre-Amplifier Agilent	8449B	3008A01922	Sep. 19, 2015	Sep. 18, 2016
RF Cable	EMC104-SM-SM-2000 EMC104-SM-SM-5000 EMC104-SM-SM-5000	150318 150323 150324	Mar. 30, 2016	Mar. 29, 2017
Pre-Amplifier EMCI	EMC184045	980143	Jan. 15, 2016	Jan. 14, 2017
Horn Antenna SCHWARZBECK	BBHA 9170	BBHA9170608	Jan. 08, 2016	Jan. 07, 2017
RF Cable	SUCOFLEX 102	36432/2 36441/2	Jan. 16, 2016	Jan. 15, 2017
Software	ADT_Radiated_V8.7.07	NA	NA	NA
Antenna Tower & Turn Table CT	NA	NA	NA	NA
Boresight Antenna Fixture	NA	NA	NA	NA
Spectrum Analyzer R&S	FSP40	100060	May 11, 2016	May 10, 2017
Power meter Anritsu	ML2495A	1014008	May 5, 2016	May 4, 2017
Power sensor Anritsu	MA2411B	0917122	May 5, 2016	May 4, 2017

**Note:**

1. The calibration interval of the above test instruments is 12 months and the calibrations are traceable to NML/ROC and NIST/USA.
2. \*The calibration interval of the above test instruments is 24 months and the calibrations are traceable to NML/ROC and NIST/USA.
3. Loop antenna was used for all emissions below 30 MHz.
4. The test was performed in 966 Chamber No. 4.
5. The FCC Site Registration No. is 292998
6. The CANADA Site Registration No. is 20331-2
7. Tested Date: May 17 to 18, 2016

#### 4.1.3 Test Procedures

- a. The EUT was placed on the top of a rotating table 0.8 meters (for below 1GHz) / 1.5 meters (for above 1GHz) above the ground at 3 meter chamber room for test. The table was rotated 360 degrees to determine the position of the highest radiation.
- b. The EUT was set 3 meters away from the interference-receiving antenna, which was mounted on the top of a variable-height antenna tower.
- c. The height of antenna is varied from one meter to four meters above the ground to determine the maximum value of the field strength. Both horizontal and vertical polarizations of the antenna are set to make the measurement.
- d. For each suspected emission, the EUT was arranged to its worst case and then the antenna was tuned to heights from 1 meter to 4 meters and the rotatable table was turned from 0 degrees to 360 degrees to find the maximum reading.
- e. The test-receiver system was set to quasi-peak detect function and specified bandwidth with maximum hold mode when the test frequency is below 1 GHz.
- f. The test-receiver system was set to peak and average detect function and specified bandwidth with maximum hold mode when the test frequency is above 1 GHz. If the peak reading value also meets average limit, measurement with the average detector is unnecessary.

#### Note:

1. The resolution bandwidth and video bandwidth of test receiver/spectrum analyzer is 120kHz for Quasi-peak detection (QP) at frequency below 1GHz.
2. The resolution bandwidth of test receiver/spectrum analyzer is 1 MHz and the video bandwidth is 3 MHz for Peak detection (PK) at frequency above 1GHz.
3. The resolution bandwidth of test receiver/spectrum analyzer is 1MHz and the video bandwidth is 3MHz for RMS Average (Duty cycle < 98%) for Average detection (AV) at frequency above 1GHz, then the measurement results was added to a correction factor ( $10 \log(1/\text{duty cycle})$ ).
4. The resolution bandwidth of test receiver/spectrum analyzer is 1MHz and the video bandwidth is 10Hz (Duty cycle  $\geq 98\%$ ) for Average detection (AV) at frequency above 1GHz.
5. All modes of operation were investigated and the worst-case emissions are reported.

#### 4.1.4 Deviation from Test Standard

No deviation.

#### 4.1.5 Test Set Up

##### <Frequency Range below 1GHz>

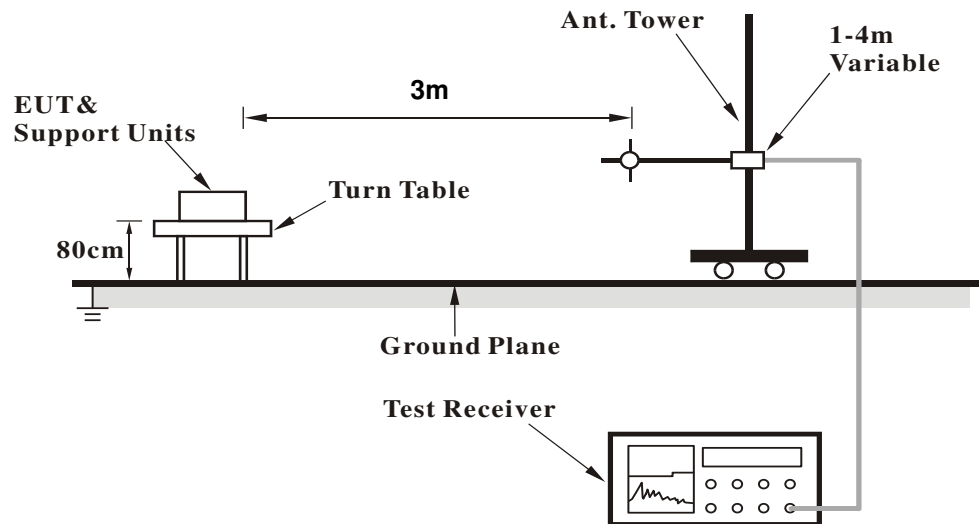

##### <Frequency Range above 1GHz>

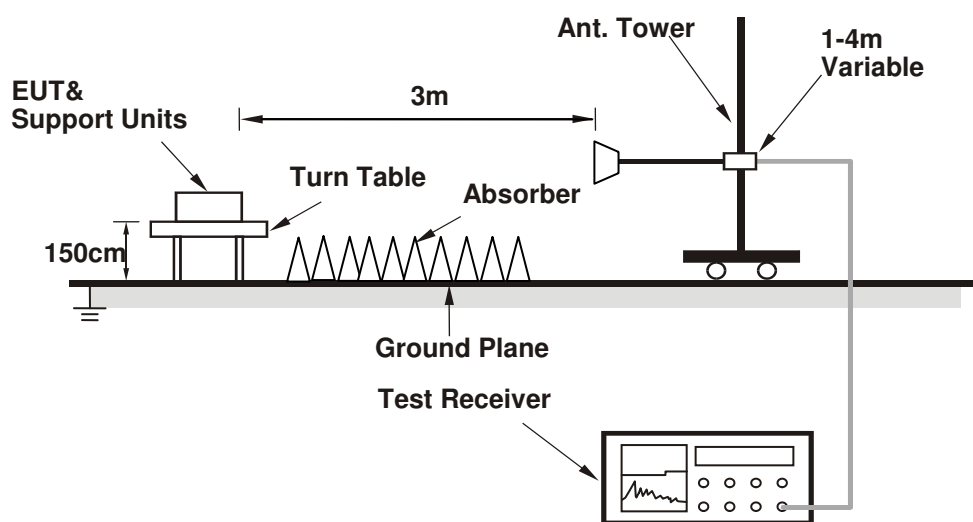

For the actual test configuration, please refer to the attached file (Test Setup Photo).

#### 4.1.6 EUT Operating Conditions

- a. Placed the EUT on the testing table.
- b. Set the EUT under transmission condition continuously at specific channel frequency.



4.1.7 Test Results

Above 1GHz Data

BT\_LE-GFSK

<b>CHANNEL</b>	TX Channel 0	<b>DETECTOR FUNCTION</b>	Peak (PK)
<b>FREQUENCY RANGE</b>	1GHz ~ 25GHz		Average (AV)

**ANTENNA POLARITY & TEST DISTANCE: HORIZONTAL AT 3 M**

NO.	FREQ. (MHz)	EMISSION LEVEL (dBuV/m)	LIMIT (dBuV/m)	MARGIN (dB)	ANTENNA HEIGHT (m)	TABLE ANGLE (Degree)	RAW VALUE (dBuV)	CORRECTION FACTOR (dB/m)
1	2390.00	47.7 PK	74.0	-26.3	1.70 H	7	53.30	-5.60
2	2390.00	35.9 AV	54.0	-18.1	1.70 H	7	41.50	-5.60
3	*2402.00	105.1 PK			1.70 H	7	110.70	-5.60
4	*2402.00	104.1 AV			1.70 H	7	109.70	-5.60
5	4804.00	47.4 PK	74.0	-26.6	1.00 H	294	46.50	0.90
6	4804.00	40.7 AV	54.0	-13.3	1.00 H	294	39.80	0.90

**ANTENNA POLARITY & TEST DISTANCE: VERTICAL AT 3 M**

NO.	FREQ. (MHz)	EMISSION LEVEL (dBuV/m)	LIMIT (dBuV/m)	MARGIN (dB)	ANTENNA HEIGHT (m)	TABLE ANGLE (Degree)	RAW VALUE (dBuV)	CORRECTION FACTOR (dB/m)
1	2390.00	48.7 PK	74.0	-25.3	3.60 V	283	54.30	-5.60
2	2390.00	33.1 AV	54.0	-20.9	3.60 V	283	38.70	-5.60
3	*2402.00	99.3 PK			3.60 V	283	104.90	-5.60
4	*2402.00	98.0 AV			3.60 V	283	103.60	-5.60
5	4804.00	48.7 PK	74.0	-25.3	2.42 V	30	47.80	0.90
6	4804.00	41.2 AV	54.0	-12.8	2.42 V	30	40.30	0.90

**REMARKS:**

1. Emission Level(dBuV/m) = Raw Value(dBuV) + Correction Factor(dB/m)
2. Correction Factor(dB/m) = Antenna Factor(dB/m) + Cable Factor(dB) – Pre-Amplifier Factor(dB)
3. The other emission levels were very low against the limit.
4. Margin value = Emission Level – Limit value
5. " \* ": Fundamental frequency.

<b>CHANNEL</b>	TX Channel 19	<b>DETECTOR FUNCTION</b>	Peak (PK)
<b>FREQUENCY RANGE</b>	1GHz ~ 25GHz		Average (AV)

**ANTENNA POLARITY & TEST DISTANCE: HORIZONTAL AT 3 M**

NO.	FREQ. (MHz)	EMISSION LEVEL (dBuV/m)	LIMIT (dBuV/m)	MARGIN (dB)	ANTENNA HEIGHT (m)	TABLE ANGLE (Degree)	RAW VALUE (dBuV)	CORRECTION FACTOR (dB/m)
1	*2440.00	104.0 PK			2.04 H	356	109.40	-5.40
2	*2440.00	102.9 AV			2.04 H	356	108.30	-5.40
3	4880.00	47.6 PK	74.0	-26.4	1.01 H	295	46.60	1.00
4	4880.00	40.8 AV	54.0	-13.2	1.01 H	295	39.80	1.00
5	7320.00	51.4 PK	74.0	-22.6	1.12 H	287	43.80	7.60
6	7320.00	41.4 AV	54.0	-12.6	1.12 H	287	33.80	7.60

**ANTENNA POLARITY & TEST DISTANCE: VERTICAL AT 3 M**

NO.	FREQ. (MHz)	EMISSION LEVEL (dBuV/m)	LIMIT (dBuV/m)	MARGIN (dB)	ANTENNA HEIGHT (m)	TABLE ANGLE (Degree)	RAW VALUE (dBuV)	CORRECTION FACTOR (dB/m)
1	*2440.00	98.1 PK			3.55 V	280	103.50	-5.40
2	*2440.00	96.7 AV			3.55 V	280	102.10	-5.40
3	4880.00	48.7 PK	74.0	-25.3	2.42 V	39	47.70	1.00
4	4880.00	41.5 AV	54.0	-12.5	2.42 V	39	40.50	1.00
5	7320.00	54.2 PK	74.0	-19.8	1.00 V	281	46.60	7.60
6	7320.00	43.7 AV	54.0	-10.3	1.00 V	281	36.10	7.60

**REMARKS:**

1. Emission Level(dBuV/m) = Raw Value(dBuV) + Correction Factor(dB/m)
2. Correction Factor(dB/m) = Antenna Factor(dB/m) + Cable Factor(dB) – Pre-Amplifier Factor(dB)
3. The other emission levels were very low against the limit.
4. Margin value = Emission Level – Limit value
5. " \* ": Fundamental frequency.

<b>CHANNEL</b>	TX Channel 39	<b>DETECTOR FUNCTION</b>	Peak (PK)
<b>FREQUENCY RANGE</b>	1GHz ~ 25GHz		Average (AV)

**ANTENNA POLARITY & TEST DISTANCE: HORIZONTAL AT 3 M**

NO.	FREQ. (MHz)	EMISSION LEVEL (dBuV/m)	LIMIT (dBuV/m)	MARGIN (dB)	ANTENNA HEIGHT (m)	TABLE ANGLE (Degree)	RAW VALUE (dBuV)	CORRECTION FACTOR (dB/m)
1	*2480.00	104.5 PK			2.08 H	354	109.80	-5.30
2	*2480.00	102.3 AV			2.08 H	354	107.60	-5.30
3	2483.50	51.5 PK	74.0	-22.5	2.08 H	354	56.80	-5.30
4	2483.50	39.3 AV	54.0	-14.7	2.08 H	354	44.60	-5.30
5	4960.00	47.8 PK	74.0	-26.2	1.01 H	304	46.40	1.40
6	4960.00	40.7 AV	54.0	-13.3	1.01 H	304	39.30	1.40
7	7440.00	51.5 PK	74.0	-22.5	1.12 H	303	43.60	7.90
8	7440.00	41.7 AV	54.0	-12.3	1.12 H	303	33.80	7.90

**ANTENNA POLARITY & TEST DISTANCE: VERTICAL AT 3 M**

NO.	FREQ. (MHz)	EMISSION LEVEL (dBuV/m)	LIMIT (dBuV/m)	MARGIN (dB)	ANTENNA HEIGHT (m)	TABLE ANGLE (Degree)	RAW VALUE (dBuV)	CORRECTION FACTOR (dB/m)
1	*2480.00	98.0 PK			3.51 V	272	103.30	-5.30
2	*2480.00	96.6 AV			3.51 V	272	101.90	-5.30
3	2483.50	50.0 PK	74.0	-24.0	3.51 V	272	55.30	-5.30
4	2483.50	36.5 AV	54.0	-17.5	3.51 V	272	41.80	-5.30
5	4960.00	49.0 PK	74.0	-25.0	2.39 V	30	47.60	1.40
6	4960.00	41.9 AV	54.0	-12.1	2.39 V	30	40.50	1.40
7	7440.00	54.0 PK	74.0	-20.0	1.00 V	297	46.10	7.90
8	7440.00	43.5 AV	54.0	-10.5	1.00 V	297	35.60	7.90

**REMARKS:**

1. Emission Level(dBuV/m) = Raw Value(dBuV) + Correction Factor(dB/m)
2. Correction Factor(dB/m) = Antenna Factor(dB/m) + Cable Factor(dB) – Pre-Amplifier Factor(dB)
3. The other emission levels were very low against the limit.
4. Margin value = Emission Level – Limit value
5. " \* ": Fundamental frequency.

Below 1GHz Data

BT\_LE-GFSK

<b>CHANNEL</b>	TX Channel 0	<b>DETECTOR FUNCTION</b>	Quasi-Peak (QP)
<b>FREQUENCY RANGE</b>	Below 1GHz		

ANTENNA POLARITY & TEST DISTANCE: HORIZONTAL AT 3 M								
NO.	FREQ. (MHz)	EMISSION LEVEL (dBuV/m)	LIMIT (dBuV/m)	MARGIN (dB)	ANTENNA HEIGHT (m)	TABLE ANGLE (Degree)	RAW VALUE (dBuV)	CORRECTION FACTOR (dB/m)
1	118.49	40.0 QP	43.5	-3.5	1.50 H	240	40.79	-0.80
2	145.43	38.2 QP	43.5	-5.3	2.00 H	190	37.04	1.15
3	199.80	39.2 QP	43.5	-4.3	1.00 H	332	41.31	-2.13
4	264.04	41.2 QP	46.0	-4.8	1.00 H	1	40.75	0.41
5	720.03	41.0 QP	46.0	-5.1	1.50 H	360	30.85	10.10
6	799.96	40.8 QP	46.0	-5.2	1.00 H	273	29.12	11.71

ANTENNA POLARITY & TEST DISTANCE: VERTICAL AT 3 M								
NO.	FREQ. (MHz)	EMISSION LEVEL (dBuV/m)	LIMIT (dBuV/m)	MARGIN (dB)	ANTENNA HEIGHT (m)	TABLE ANGLE (Degree)	RAW VALUE (dBuV)	CORRECTION FACTOR (dB/m)
1	118.43	39.7 QP	43.5	-3.8	1.23 V	1	40.49	-0.80
2	295.66	41.6 QP	46.0	-4.4	2.00 V	94	40.01	1.60
3	435.78	39.2 QP	46.0	-6.8	1.00 V	193	33.75	5.41
4	746.59	40.2 QP	46.0	-5.8	1.50 V	304	29.17	11.05
5	799.96	40.7 QP	46.0	-5.3	1.50 V	305	29.01	11.71
6	900.02	40.3 QP	46.0	-5.7	1.50 V	107	27.02	13.28

**REMARKS:**

1. Emission Level(dBuV/m) = Raw Value(dBuV) + Correction Factor(dB/m)
2. Correction Factor(dB/m) = Antenna Factor(dB/m) + Cable Factor(dB) – Pre-Amplifier Factor(dB)
3. The other emission levels were very low against the limit.
4. Margin value = Emission Level – Limit value

## 4.2 6dB Bandwidth Measurement

### 4.2.1 Limits of 6dB Bandwidth Measurement

The minimum of 6dB Bandwidth Measurement is 0.5 MHz.

### 4.2.2 Test Setup

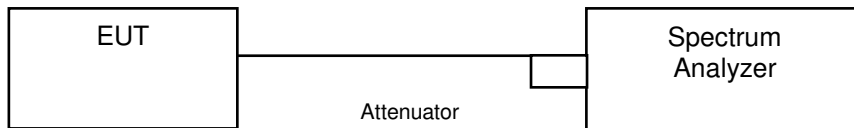

### 4.2.3 Test Instruments

Refer to section 4.1.2 to get information of above instrument.

### 4.2.4 Test Procedure

- a. Set resolution bandwidth (RBW) = 100kHz
- b. Set the video bandwidth (VBW)  $\geq 3 \times$  RBW, Detector = Peak.
- c. Trace mode = max hold.
- d. Sweep = auto couple.
- e. Measure the maximum width of the emission that is constrained by the frequencies associated with the two amplitude points (upper and lower) that are attenuated by 6 dB relative to the maximum level measured in the fundamental emission

### 4.2.5 Deviation from Test Standard

No deviation.

### 4.2.6 EUT Operating Conditions

The software provided by client to enable the EUT under transmission condition continuously at lowest, middle and highest channel frequencies individually.

#### 4.2.7 Test Result

Channel	Frequency (MHz)	6dB bandwidth (MHz)	Minimum limit (MHz)	Pass / fail
0	2402	0.71	0.5	PASS
19	2440	0.72	0.5	PASS
39	2480	0.73	0.5	PASS

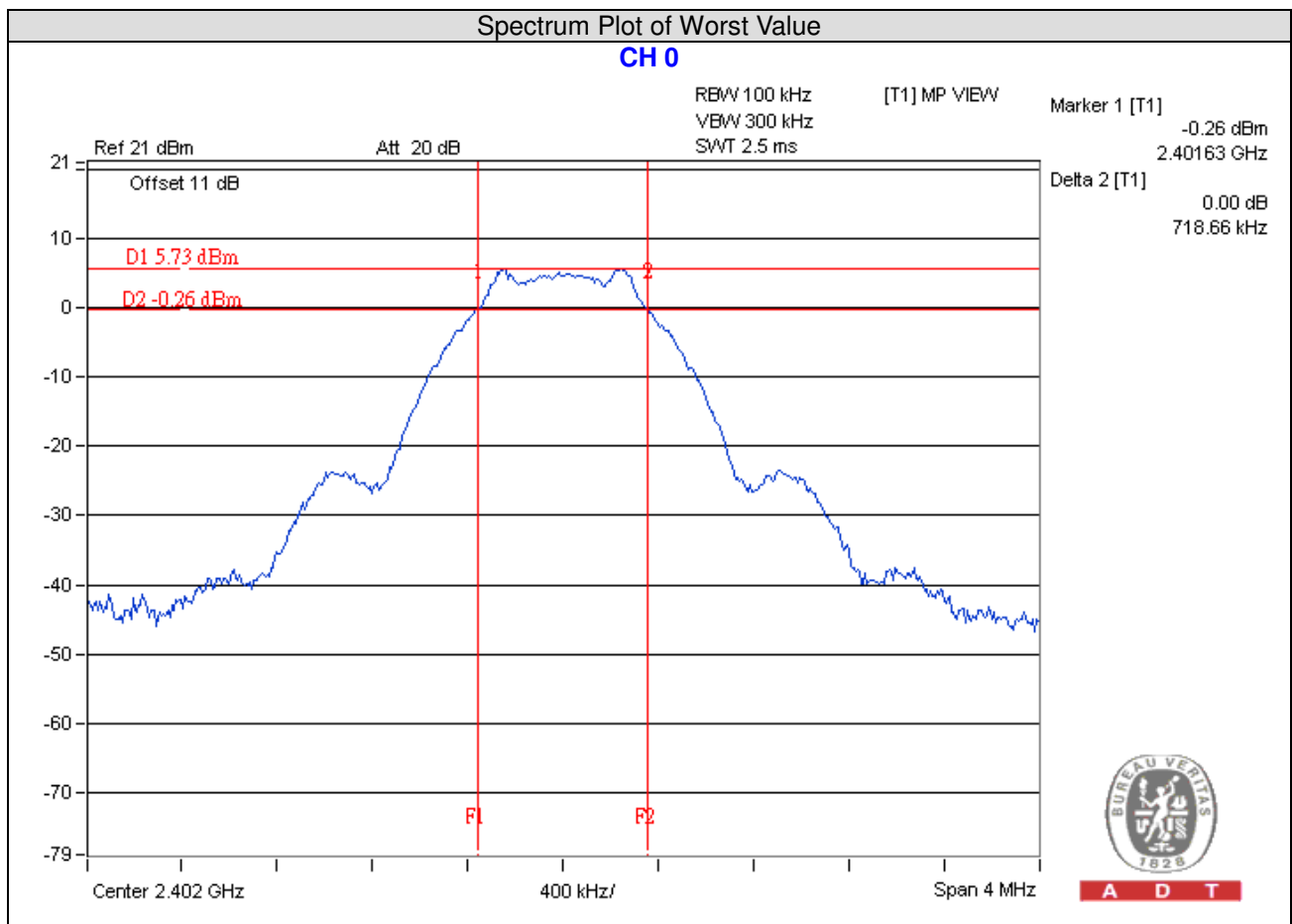

### 4.3 Conducted Output Power Measurement

#### 4.3.1 Limits OF Conducted Output Power Measurement

For systems using digital modulation in the 2400–2483.5 MHz bands: 1 Watt (30dBm)

#### 4.3.2 Test Setup

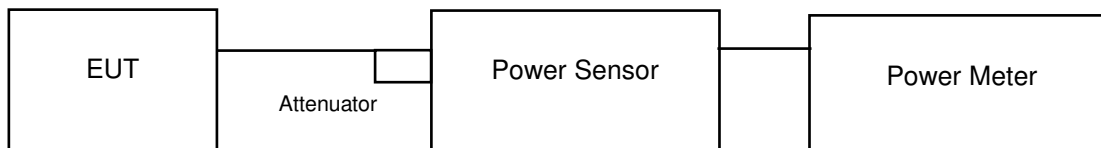

#### 4.3.3 Test Instruments

Refer to section 4.1.2 to get information of above instrument.

#### 4.3.4 Test Procedures

A peak / average power sensor was used on the output port of the EUT. A power meter was used to read the response of the peak / average power sensor. Record the power level.

#### 4.3.5 Deviation from Test Standard

No deviation.

#### 4.3.6 EUT Operating Conditions

Same as Item 4.2.6.

#### 4.3.7 Test Results

##### FOR PEAK POWER

Channel	Frequency (MHz)	Peak Power (mW)	Peak Power (dBm)	Limit (dBm)	Pass/Fail
0	2402	4.159	6.19	30	Pass
19	2440	3.864	5.87	30	Pass
39	2480	3.597	5.56	30	Pass

##### FOR AVERAGE POWER

Channel	Frequency (MHz)	Average Power (mW)	Average Power (dBm)
0	2402	4.13	6.16
19	2440	3.846	5.85
39	2480	3.581	5.54



## 4.4 Power Spectral Density Measurement

### 4.4.1 Limits of Power Spectral Density Measurement

The Maximum of Power Spectral Density Measurement is 8dBm.

### 4.4.2 Test Setup

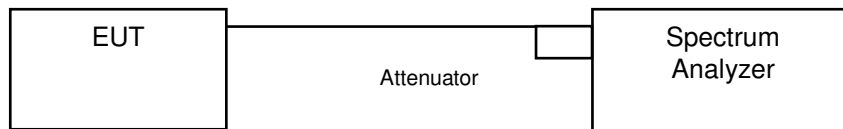

### 4.4.3 Test Instruments

Refer to section 4.1.2 to get information of above instrument.

### 4.4.4 Test Procedure

- a. Set analyzer center frequency to DTS channel center frequency.
- b. Set the span to 1.5 times the DTS bandwidth.
- c. Set the RBW to:  $3 \text{ kHz} \leq \text{RBW} \leq 100 \text{ kHz}$ .
- d. Set the VBW  $\geq 3 \times \text{RBW}$ .
- e. Detector = peak.
- f. Sweep time = auto couple.
- g. Trace mode = max hold.
- h. Allow trace to fully stabilize.
- i. Use the peak marker function to determine the maximum amplitude level within the RBW.

### 4.4.5 Deviation from Test Standard

No deviation.

### 4.4.6 EUT Operating Condition

Same as Item 4.2.6

#### 4.4.7 Test Results

Channel	Freq. (MHz)	PSD (dBm/3kHz)	Limit (dBm/3kHz)	PASS /FAIL
0	2402	-6.72	8	PASS
19	2440	-7.06	8	PASS
39	2480	-7.38	8	PASS

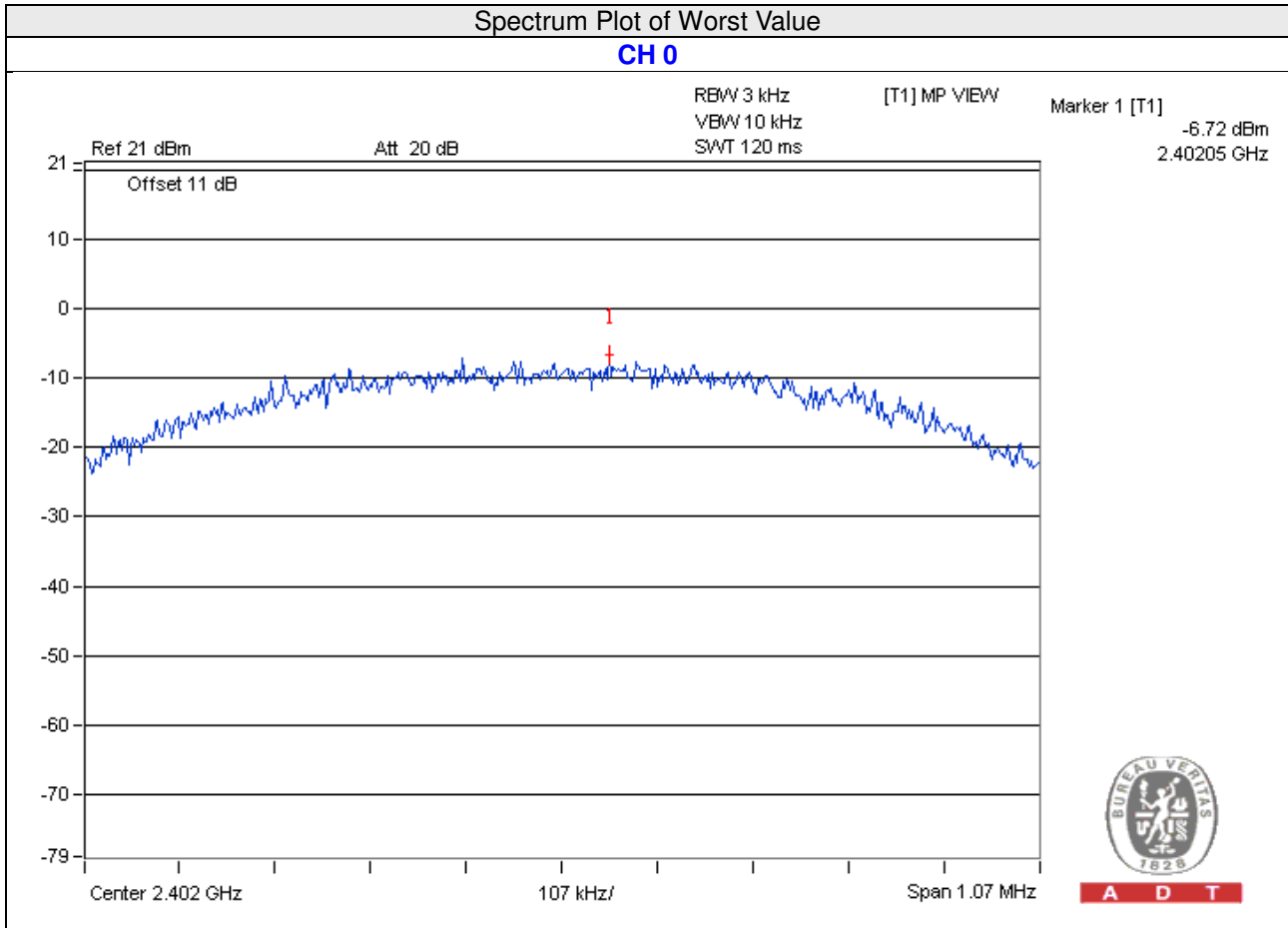

## 4.5 Conducted Out of Band Emission Measurement

### 4.5.1 Limits of Conducted Out of Band Emission Measurement

Below  $-20\text{dB}$  of the highest emission level of operating band (in 100kHz Resolution Bandwidth).

### 4.5.2 Test Setup

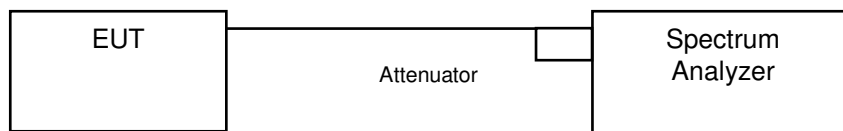

### 4.5.3 Test Instruments

Refer to section 4.1.2 to get information of above instrument.

### 4.5.4 Test Procedure

#### MEASUREMENT PROCEDURE REF

1. Set the RBW = 100 kHz.
2. Set the VBW  $\geq$  300 kHz.
3. Detector = peak.
4. Sweep time = auto couple.
5. Trace mode = max hold.
6. Allow trace to fully stabilize.
7. Use the peak marker function to determine the maximum power level in any 100 kHz band segment within the fundamental EBW.

#### MEASUREMENT PROCEDURE OOB

1. Set RBW = 100 kHz.
2. Set VBW  $\geq$  300 kHz.
3. Detector = peak.
4. Sweep = auto couple.
5. Trace Mode = max hold.
6. Allow trace to fully stabilize.
7. Use the peak marker function to determine the maximum amplitude level.

### 4.5.5 Deviation from Test Standard

No deviation.

### 4.5.6 EUT Operating Condition

Same as Item 4.2.6

### 4.5.7 Test results

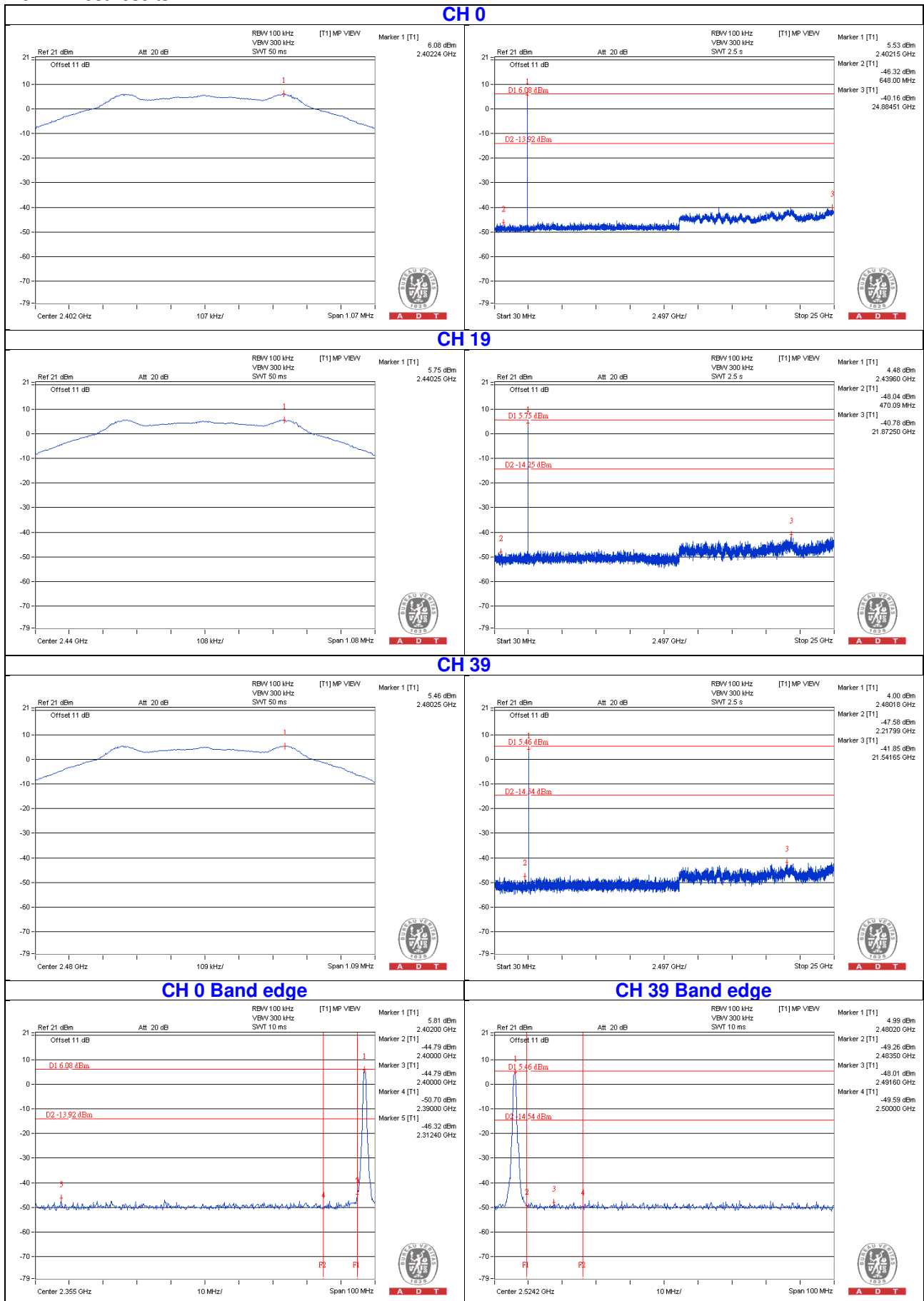

## 5 Pictures of Test Arrangements

Please refer to the attached file (Test Setup Photo).

## Appendix – Information on the Testing Laboratories

We, Bureau Veritas Consumer Products Services (H.K.) Ltd., Taoyuan Branch, were founded in 1988 to provide our best service in EMC, Radio, Telecom and Safety consultation. Our laboratories are accredited and approved according to ISO/IEC 17025.

If you have any comments, please feel free to contact us at the following:

**Linko EMC/RF Lab**

Tel: 886-2-26052180

Fax: 886-2-26051924

**Hsin Chu EMC/RF/Telecom Lab**

Tel: 886-3-6668565

Fax: 886-3-6668323

**Hwa Ya EMC/RF/Safety Lab**

Tel: 886-3-3183232

Fax: 886-3-3270892

**Email:** [service.adt@tw.bureauveritas.com](mailto:service.adt@tw.bureauveritas.com)

**Web Site:** [www.bureauveritas-adt.com](http://www.bureauveritas-adt.com)

The address and road map of all our labs can be found in our web site also.

--- END ---