

FCC Test Report (GFSK)

Report No.: RF190116E05A

FCC ID: JNZMR0080B

Test Model: MR0080

Received Date: Feb. 23, 2019

Test Date: Mar. 07, 2019

Issued Date: Mar. 13, 2019

Applicant: LOGITECH FAR EAST LTD.

Address: #2 Creation Rd. 4, Science-Based Ind. Park Hsinchu Taiwan, R.O.C.

Issued By: Bureau Veritas Consumer Products Services (H.K.) Ltd., Taoyuan Branch
Hsin Chu Laboratory

Lab Address: E-2, No.1, Li Hsin 1st Road, Hsinchu Science Park, Hsinchu City 300,
Taiwan R.O.C.

Test Location: E-2, No.1, Li Hsin 1st Road, Hsinchu Science Park, Hsinchu City 300,
Taiwan R.O.C.

**FCC Registration /
Designation Number:** 723255 / TW2022



This report is for your exclusive use. Any copying or replication of this report to or for any other person or entity, or use of our name or trademark, is permitted only with our prior written permission. This report sets forth our findings solely with respect to the test samples identified herein. The results set forth in this report are not indicative or representative of the quality or characteristics of the lot from which a test sample was taken or any similar or identical product unless specifically and expressly noted. Our report includes all of the tests requested by you and the results thereof based upon the information that you provided to us. You have 60 days from date of issuance of this report to notify us of any material error or omission caused by our negligence, provided, however, that such notice shall be in writing and shall specifically address the issue you wish to raise. A failure to raise such issue within the prescribed time shall constitute your unqualified acceptance of the completeness of this report, the tests conducted and the correctness of the report contents. Unless specific mention, the uncertainty of measurement has been explicitly taken into account to declare the compliance or non-compliance to the specification. The report must not be used by the client to claim product certification, approval, or endorsement by TAF or any government agencies.

Table of Contents

Release Control Record	4
1 Certificate of Conformity	5
2 Summary of Test Results	6
2.1 Measurement Uncertainty	6
2.2 Modification Record	6
3 General Information	7
3.1 General Description of EUT (GFSK)	7
3.2 Description of Test Modes	8
3.2.1 Test Mode Applicability and Tested Channel Detail	9
3.3 Duty Cycle of Test Signal	11
3.4 Description of Support Units	12
3.4.1 Configuration of System under Test	13
3.5 General Description of Applied Standards	14
4 Test Types and Results	15
4.1 Radiated Emission and Bandedge Measurement	15
4.1.1 Limits of Radiated Emission and Bandedge Measurement	15
4.1.2 Test Instruments	16
4.1.3 Test Procedures	17
4.1.4 Deviation from Test Standard	17
4.1.5 Test Setup	18
4.1.6 EUT Operating Conditions	19
4.1.7 Test Results	20
4.2 Conducted Emission Measurement	25
4.2.1 Limits of Conducted Emission Measurement	25
4.2.2 Test Instruments	25
4.2.3 Test Procedures	26
4.2.4 Deviation from Test Standard	26
4.2.5 Test Setup	26
4.2.6 EUT Operating Conditions	26
4.2.7 Test Results	27
4.3 6dB Bandwidth Measurement	29
4.3.1 Limits of 6dB Bandwidth Measurement	29
4.3.2 Test Setup	29
4.3.3 Test Instruments	29
4.3.4 Test Procedure	29
4.3.5 Deviation from Test Standard	29
4.3.6 EUT Operating Conditions	29
4.3.7 Test Results	30
4.4 Conducted Output Power Measurement	31
4.4.1 Limits of Conducted Output Power Measurement	31
4.4.2 Test Setup	31
4.4.3 Test Instruments	31
4.4.4 Test Procedures	31
4.4.5 Deviation from Test Standard	31
4.4.6 EUT Operating Conditions	31
4.4.7 Test Results	32
4.5 Power Spectral Density Measurement	33
4.5.1 Limits of Power Spectral Density Measurement	33
4.5.2 Test Setup	33
4.5.3 Test Instruments	33
4.5.4 Test Procedure	33
4.5.5 Deviation from Test Standard	33
4.5.6 EUT Operating Condition	33

4.5.7 Test Results	34
4.6 Conducted Out of Band Emission Measurement	35
4.6.1 Limits of Conducted Out of Band Emission Measurement.....	35
4.6.2 Test Setup.....	35
4.6.3 Test Instruments	35
4.6.4 Test Procedure	35
4.6.5 Deviation from Test Standard	35
4.6.6 EUT Operating Condition	35
4.6.7 Test Results	35
5 Pictures of Test Arrangements.....	37
Appendix – Information of the Testing Laboratories	38

Release Control Record

Issue No.	Description	Date Issued
RF190116E05A	Original release.	Mar. 13, 2019

1 Certificate of Conformity

Product: Wireless Mouse

Brand: logitech G

Test Model: MR0080

Sample Status: ENGINEERING SAMPLE

Applicant: LOGITECH FAR EAST LTD.

Test Date: Mar. 07, 2019

Standards: 47 CFR FCC Part 15, Subpart C (Section 15.247)
ANSI C63.10: 2013

The above equipment has been tested by **Bureau Veritas Consumer Products Services (H.K.) Ltd., Taoyuan Branch**, and found compliance with the requirement of the above standards. The test record, data evaluation & Equipment Under Test (EUT) configurations represented herein are true and accurate accounts of the measurements of the sample's EMC characteristics under the conditions specified in this report.

Prepared by :  , **Date:** Mar. 13, 2019
Claire Kuan / Specialist

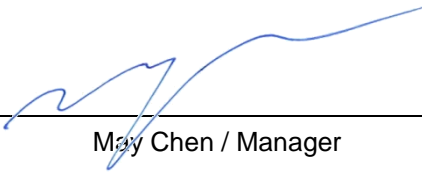
Approved by :  , **Date:** Mar. 13, 2019
May Chen / Manager

2 Summary of Test Results

47 CFR FCC Part 15, Subpart C (Section 15.247)			
FCC Clause	Test Item	Result	Remarks
15.207	AC Power Conducted Emission	PASS	Meet the requirement of limit. Minimum passing margin is -15.35dB at 0.15000MHz.
15.205 / 15.209 / 15.247(d)	Radiated Emissions and Band Edge Measurement	PASS	Meet the requirement of limit. Minimum passing margin is -5.1dB at 2483.50MHz.
15.247(d)	Antenna Port Emission	PASS	Meet the requirement of limit.
15.247(a)(2)	6dB bandwidth	PASS	Meet the requirement of limit.
15.247(b)	Conducted power	PASS	Meet the requirement of limit.
15.247(e)	Power Spectral Density	PASS	Meet the requirement of limit.
15.203	Antenna Requirement	PASS	No antenna connector is used.

Note:

Determining compliance based on the results of the compliance measurement, not taking into account measurement instrumentation uncertainty.

2.1 Measurement Uncertainty

Where relevant, the following measurement uncertainty levels have been estimated for tests performed on the EUT as specified in CISPR 16-4-2:

Measurement	Frequency	Expanded Uncertainty (k=2) (\pm)
Conducted Emissions at mains ports	150kHz ~ 30MHz	1.8 dB
Radiated Emissions up to 1 GHz	30MHz ~ 1GHz	5.1 dB
Radiated Emissions above 1 GHz	1GHz ~ 6GHz	5.1 dB
	6GHz ~ 18GHz	5.0 dB
	18GHz ~ 40GHz	5.2 dB

2.2 Modification Record

There were no modifications required for compliance.

3 General Information

3.1 General Description of EUT (GFSK)

Product	Wireless Mouse
PMN	G703 LIGHTSPEED
Brand	logitech G
Test Model	MR0080
Status of EUT	ENGINEERING SAMPLE
Power Supply Rating	3.7Vdc from battery or 5Vdc from USB interface
Modulation Type	GFSK
Transfer Rate	Up to 2Mbps
Operating Frequency	2.402 ~ 2.481GHz
Number of Channel	80
Output Power	6.887 mW
Antenna Type	Refer to Note
Antenna Connector	Refer to Note
Accessory Device	NA
Data Cable Supplied	USB to Micro USB cable x 1 (shielded, 1.85m with one core)

Note:

- The EUT may have a lot of colors for marketing requirement.
- The EUT could be supplied with rechargeable battery as the following table:

Brand	Model No.	Spec.
SYNERGY SCIENTECH CORP or logi	AHB521630PJT-04 or 533-000151	3.7V, 240mAh, 0.9Wh

- The device wireless function will be disabled automatically when the device is connected to the host equipment through USB cable.
- For radiated emissions, the EUT was pre-tested under the following modes:

Test Mode	Description
Mode A	Power from USB adapter
Mode B	Power from Battery

Note: From the above modes, the worst case was found in **Mode A**. Therefore only the test data of the mode was recorded in this report.

- For AC power conducted emissions, the EUT was pre-tested under the following modes:

Test Mode	Description
Mode A	Power from USB adapter
Mode B	Power from Laptop

Note: From the above modes, the worst case was found in **Mode B**. Therefore only the test data of the mode was recorded in this report.

- The antenna provided to the EUT, please refer to the following table:

Antenna Gain(dBi)	Frequency range (GHz)	Antenna Type	Connector Type
1.27	2.4~2.4835	PIFA Antenna	NA

- The above EUT information is declared by manufacturer and for more detailed features description, please refer to the manufacturer's specifications or user's manual.

3.2 Description of Test Modes

80 channels are provided to this EUT:

Channel	Freq. (MHz)	Channel	Freq. (MHz)	Channel	Freq. (MHz)	Channel	Freq. (MHz)
1	2402	21	2422	41	2442	61	2462
2	2403	22	2423	42	2443	62	2463
3	2404	23	2424	43	2444	63	2464
4	2405	24	2425	44	2445	64	2465
5	2406	25	2426	45	2446	65	2466
6	2407	26	2427	46	2447	66	2467
7	2408	27	2428	47	2448	67	2468
8	2409	28	2429	48	2449	68	2469
9	2410	29	2430	49	2450	69	2470
10	2411	30	2431	50	2451	70	2471
11	2412	31	2432	51	2452	71	2472
12	2413	32	2433	52	2453	72	2473
13	2414	33	2434	53	2454	73	2474
14	2415	34	2435	54	2455	74	2475
15	2416	35	2436	55	2456	75	2476
16	2417	36	2437	56	2457	76	2477
17	2418	37	2438	57	2458	77	2478
18	2419	38	2439	58	2459	78	2479
19	2420	39	2440	59	2460	79	2480
20	2421	40	2441	60	2461	80	2481

3.2.1 Test Mode Applicability and Tested Channel Detail

EUT CONFIGURE MODE	APPLICABLE TO				DESCRIPTION
	RE \geq 1G	RE $<$ 1G	PLC	APCM	
-	√	√	√	√	-

Where **RE \geq 1G**: Radiated Emission above 1GHz & Bandedge Measurement
RE $<$ 1G: Radiated Emission below 1GHz
PLC: Power Line Conducted Emission
APCM: Antenna Port Conducted Measurement

Radiated Emission Test (Above 1GHz):

- Pre-Scan has been conducted to determine the worst-case mode from all possible combinations between available modulations, data rates and antenna ports (if EUT with antenna diversity architecture).
- Following channel(s) was (were) selected for the final test as listed below.

AVAILABLE CHANNEL	TESTED CHANNEL	MODULATION TYPE	DATA RATE (Mbps)
1 to 80	1, 41, 80	GFSK	2

Radiated Emission Test (Below 1GHz):

- Pre-Scan has been conducted to determine the worst-case mode from all possible combinations between available modulations, data rates and antenna ports (if EUT with antenna diversity architecture).
- Following channel(s) was (were) selected for the final test as listed below.

AVAILABLE CHANNEL	TESTED CHANNEL	MODULATION TYPE	DATA RATE (Mbps)
1 to 80	41	GFSK	2

Power Line Conducted Emission Test:

- Pre-Scan has been conducted to determine the worst-case mode from all possible combinations between available modulations, data rates and antenna ports (if EUT with antenna diversity architecture).
- Following channel(s) was (were) selected for the final test as listed below.

AVAILABLE CHANNEL	TESTED CHANNEL	MODULATION TYPE	DATA RATE (Mbps)
1 to 80	41	GFSK	2

Antenna Port Conducted Measurement:

- This item includes all test value of each mode, but only includes spectrum plot of worst value of each mode.
- Pre-Scan has been conducted to determine the worst-case mode from all possible combinations between available modulations, data rates and antenna ports (if EUT with antenna diversity architecture).
- Following channel(s) was (were) selected for the final test as listed below.

AVAILABLE CHANNEL	TESTED CHANNEL	MODULATION TYPE	DATA RATE (Mbps)
1 to 80	1, 41, 80	GFSK	2

Test Condition:

APPLICABLE TO	ENVIRONMENTAL CONDITIONS	INPUT POWER (SYSTEM)	TESTED BY
RE \geq 1G	24deg. C, 73%RH	120Vac, 60Hz	Steven Chiang
RE $<$ 1G	22deg. C, 69%RH	120Vac, 60Hz	Steven Chiang
PLC	24deg. C, 76%RH	120Vac, 60Hz	Frank Chuang
APCM	25deg. C, 60%RH	120Vac, 60Hz	Anderson Chen

3.3 Duty Cycle of Test Signal

$$\text{Duty cycle} = 0.171 \text{ ms} / 0.98 \text{ ms} = 0.174$$

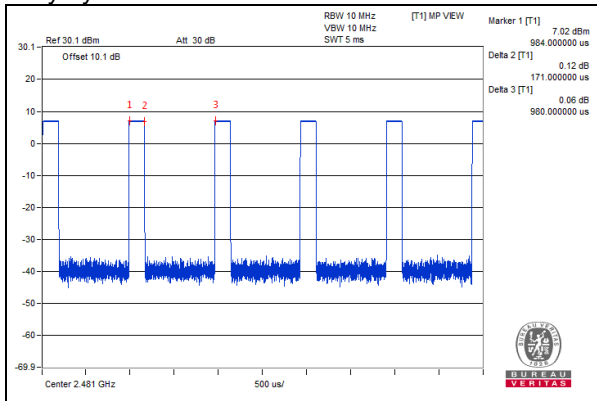

Note: This is highest operational duty cycle.

3.4 Description of Support Units

The EUT has been tested as an independent unit together with other necessary accessories or support units. The following support units or accessories were used to form a representative test configuration during the tests.

ID	Product	Brand	Model No.	Serial No.	FCC ID	Remarks
A.	USB Adapter	ASUS	AD876320	NA	NA	Provided by Lab
B.	Laptop	DELL	E6420	B92T3R1	FCC DoC	Provided by Lab

Note:

1. All power cords of the above support units are non-shielded (1.8m).

ID	Descriptions	Qty.	Length (m)	Shielding (Yes/No)	Cores (Qty.)	Remarks
1.	USB Cable	1	1.85	Yes	1	Supplied by client

Note: The core is originally attached to the cable.

3.4.1 Configuration of System under Test

For Adapter Mode :

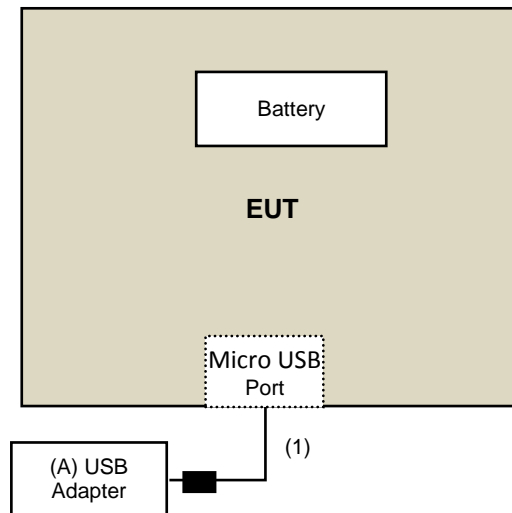

For Laptop Mode :

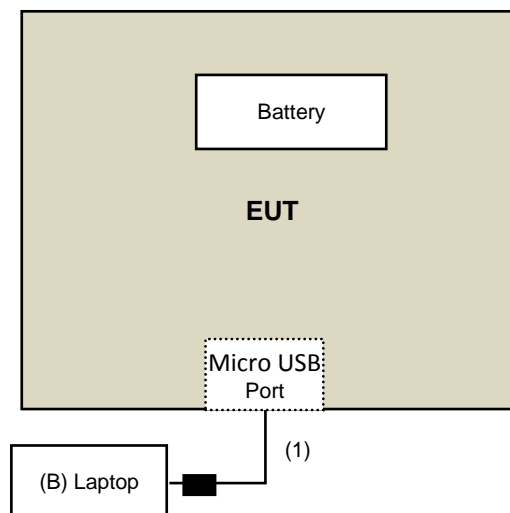

3.5 General Description of Applied Standards

The EUT is a RF Product. According to the specifications of the manufacturer, it must comply with the requirements of the following standards:

FCC Part 15, Subpart C (15.247)

KDB 558074 D01 15.247 Meas Guidance v05r01

ANSI C63.10-2013

All test items have been performed and recorded as per the above standards.

4 Test Types and Results

4.1 Radiated Emission and Bandedge Measurement

4.1.1 Limits of Radiated Emission and Bandedge Measurement

Radiated emissions which fall in the restricted bands must comply with the radiated emission limits specified as below table. Other emissions shall be at least 20dB below the highest level of the desired power:

Frequencies (MHz)	Field Strength (microvolts/meter)	Measurement Distance (meters)
0.009 ~ 0.490	2400/F(kHz)	300
0.490 ~ 1.705	24000/F(kHz)	30
1.705 ~ 30.0	30	30
30 ~ 88	100	3
88 ~ 216	150	3
216 ~ 960	200	3
Above 960	500	3

Note:

1. The lower limit shall apply at the transition frequencies.
2. Emission level (dBuV/m) = 20 log Emission level (uV/m).
3. For frequencies above 1000MHz, the field strength limits are based on average detector, however, the peak field strength of any emission shall not exceed the maximum permitted average limits, specified above by more than 20dB under any condition of modulation.

4.1.2 Test Instruments

DESCRIPTION & MANUFACTURER	MODEL NO.	SERIAL NO.	CALIBRATED DATE	CALIBRATED UNTIL
Test Receiver Agilent	N9038A	MY50010156	July 12, 2018	July 11, 2019
Pre-Amplifier EMCI	EMC001340	980142	Jan. 25, 2019	Jan. 24, 2020
Loop Antenna Electro-Metrics	EM-6879	269	Sep. 07, 2018	Sep. 06, 2019
RF Cable	NA	LOOPCAB-001	Jan. 14, 2019	Jan. 13, 2020
RF Cable	NA	LOOPCAB-002	Jan. 14, 2019	Jan. 13, 2020
Pre-Amplifier Mini-Circuits	ZFL-1000VH2B	AMP-ZFL-05	May 05, 2018	May 04, 2019
Trilog Broadband Antenna SCHWARZBECK	VULB 9168	9168-361	Nov. 22, 2018	Nov. 21, 2019
RF Cable	8D	966-3-1	Mar. 20, 2018	Mar. 19, 2019
RF Cable	8D	966-3-2	Mar. 20, 2018	Mar. 19, 2019
RF Cable	8D	966-3-3	Mar. 20, 2018	Mar. 19, 2019
Fixed attenuator Mini-Circuits	UNAT-5+	PAD-3m-3-01	Sep. 27, 2018	Sep. 26, 2019
Horn_Antenna SCHWARZBECK	BBHA9120-D	9120D-406	Nov. 25, 2018	Nov. 24, 2019
Pre-Amplifier EMCI	EMC12630SE	980384	Jan. 28, 2019	Jan. 27, 2020
RF Cable	EMC104-SM-SM-1200	160922	Jan. 28, 2019	Jan. 27, 2020
RF Cable	EMC104-SM-SM-2000	180601	June 12, 2018	June 11, 2019
RF Cable	EMC104-SM-SM-6000	180602	June 12, 2018	June 11, 2019
Spectrum Analyzer Keysight	N9030A	MY54490679	July 23, 2018	July 22, 2019
Pre-Amplifier EMCI	EMC184045SE	980387	Jan. 28, 2019	Jan. 27, 2020
Horn_Antenna SCHWARZBECK	BBHA 9170	BBHA9170519	Nov. 25, 2018	Nov. 24, 2019
RF Cable	EMC102-KM-KM-1200	160924	Jan. 28, 2019	Jan. 27, 2020
RF Cable	EMC102-KM-KM-1200	160925	Jan. 28, 2019	Jan. 27, 2020
Software	ADT_Radiated_V8.7.08	NA	NA	NA
Antenna Tower & Turn Table Max-Full	MF-7802	MF780208406	NA	NA
Boresight Antenna Fixture	FBA-01	FBA-SIP01	NA	NA
Spectrum Analyzer R&S	FSV40	100964	June 20, 2018	June 19, 2019
Power meter Anritsu	ML2495A	1014008	May 09, 2018	May 08, 2019
Power sensor Anritsu	MA2411B	0917122	May 09, 2018	May 08, 2019

Note:

1. The calibration interval of the above test instruments is 12 months and the calibrations are traceable to NML/ROC and NIST/USA.
2. The test was performed in 966 Chamber No. 3.
3. The CANADA Site Registration No. is 20331-1
4. Loop antenna was used for all emissions below 30 MHz.
5. Tested Date: Mar. 07, 2019

4.1.3 Test Procedures

For Radiated emission below 30MHz

- a. The EUT was placed on the top of a rotating table 0.8 meters above the ground at a 3 meter chamber room. The table was rotated 360 degrees to determine the position of the highest radiation.
- b. The EUT was set 3 meters away from the interference-receiving antenna, which was mounted on the top of a variable-height antenna tower.
- c. Parallel, perpendicular, and ground-parallel orientations of the antenna are set to make the measurement.
- d. For each suspected emission, the EUT was arranged to its worst case and the rotatable table was turned from 0 degrees to 360 degrees to find the maximum reading.
- e. The test-receiver system was set to Quasi-Peak Detect Function and Specified Bandwidth with Maximum Hold Mode.

Note:

1. The resolution bandwidth and video bandwidth of test receiver/spectrum analyzer is 9kHz at frequency below 30MHz.

For Radiated emission above 30MHz

- a. The EUT was placed on the top of a rotating table 0.8 meters (for 30MHz ~ 1GHz) / 1.5 meters (for above 1GHz) above the ground at 3 meter chamber room for test. The table was rotated 360 degrees to determine the position of the highest radiation.
- b. The EUT was set 3 meters away from the interference-receiving antenna, which was mounted on the top of a variable-height antenna tower.
- c. The height of antenna is varied from one meter to four meters above the ground to determine the maximum value of the field strength. Both horizontal and vertical polarizations of the antenna are set to make the measurement.
- d. For each suspected emission, the EUT was arranged to its worst case and then the antenna was tuned to heights from 1 meter to 4 meters and the rotatable table was turned from 0 degrees to 360 degrees to find the maximum reading.
- e. The test-receiver system was set to quasi-peak detect function and specified bandwidth with maximum hold mode when the test frequency is below 1 GHz.
- f. The test-receiver system was set to peak and average detects function and specified bandwidth with maximum hold mode when the test frequency is above 1 GHz. If the peak reading value also meets average limit, measurement with the average detector is unnecessary.

Note:

1. The resolution bandwidth and video bandwidth of test receiver/spectrum analyzer is 120kHz for Quasi-peak detection (QP) at frequency below 1GHz.
2. The resolution bandwidth of test receiver/spectrum analyzer is 1 MHz and the video bandwidth is 3 MHz for Peak detection (PK) at frequency above 1GHz.
3. The resolution bandwidth of test receiver/spectrum analyzer is 1 MHz and the video bandwidth is 3 MHz for Average detection (AV) at frequency above 1GHz.
4. All modes of operation were investigated and the worst-case emissions are reported.

4.1.4 Deviation from Test Standard

No deviation.

4.1.5 Test Setup

For Radiated emission below 30MHz

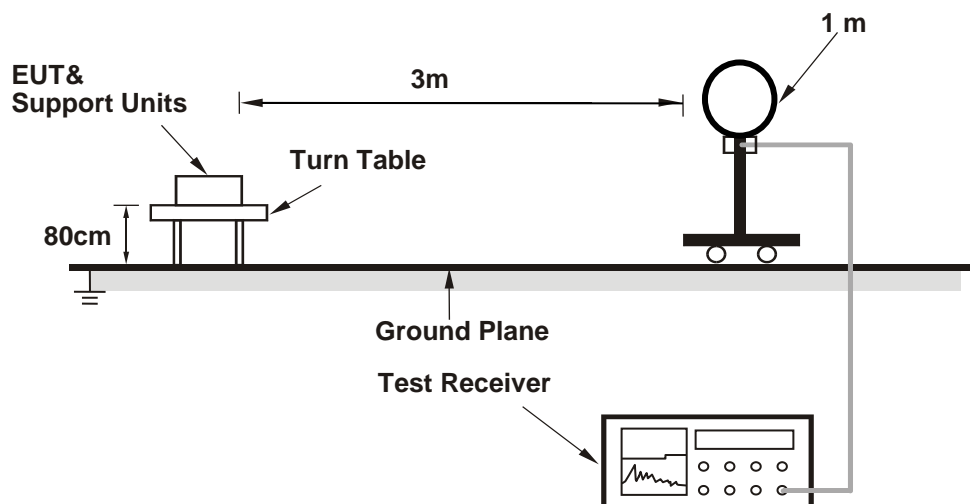

For Radiated emission 30MHz to 1GHz

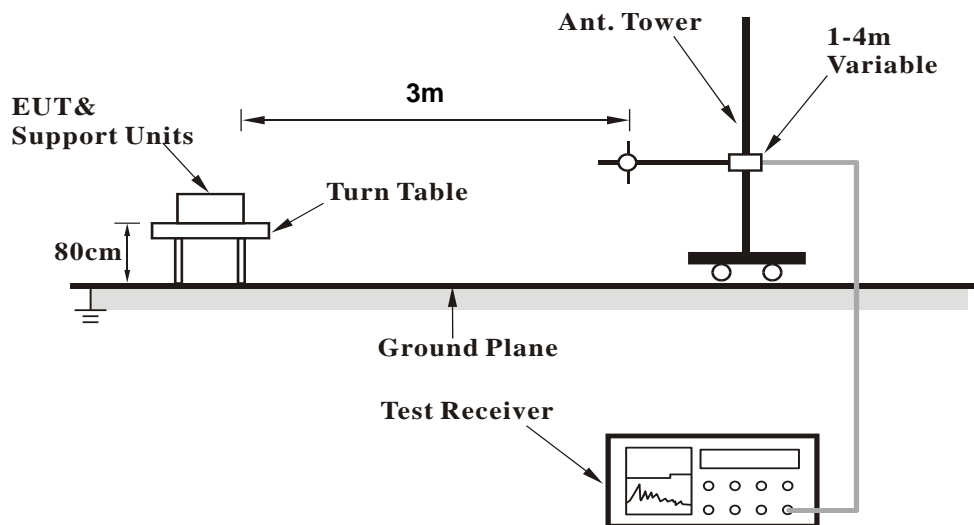

For Radiated emission above 1GHz

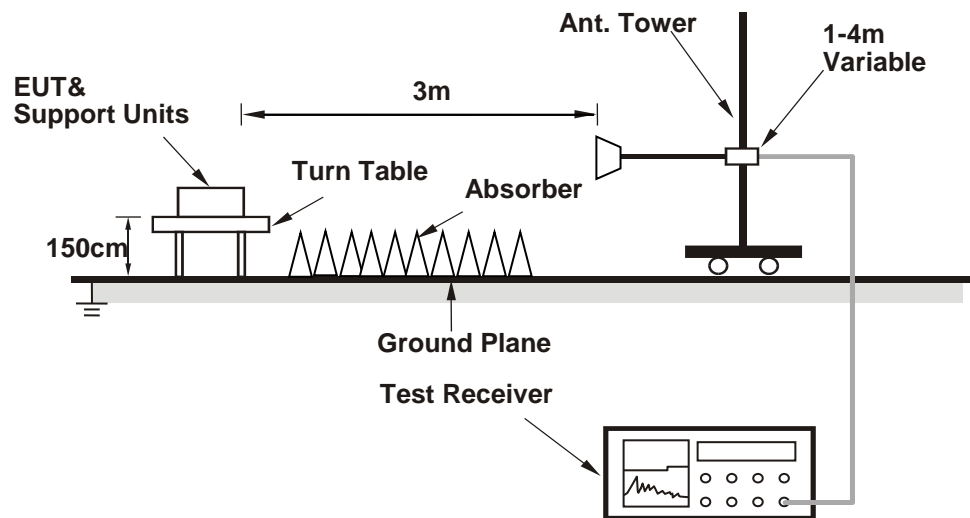

For the actual test configuration, please refer to the attached file (Test Setup Photo).

4.1.6 EUT Operating Conditions

- a. Placed the EUT on the testing table.
- b. Controlling software (RF Sample [Number Lock]) has been activated to set the EUT under transmission/receiving condition continuously.

4.1.7 Test Results

Above 1GHz Data:

CHANNEL	TX Channel 1	DETECTOR FUNCTION	Peak (PK)
FREQUENCY RANGE	1GHz ~ 25GHz		Average (AV)

ANTENNA POLARITY & TEST DISTANCE: HORIZONTAL AT 3 M

NO.	FREQ. (MHz)	EMISSION LEVEL (dBuV/m)	LIMIT (dBuV/m)	MARGIN (dB)	ANTENNA HEIGHT (m)	TABLE ANGLE (Degree)	RAW VALUE (dBuV)	CORRECTION FACTOR (dB/m)
1	2390.00	55.2 PK	74.0	-18.8	1.13 H	23	57.3	-2.1
2	2390.00	42.2 AV	54.0	-11.8	1.13 H	23	44.3	-2.1
3	*2402.00	98.3 PK			1.13 H	23	100.4	-2.1
4	*2402.00	54.9 AV			1.13 H	23	57.0	-2.1
5	4804.00	42.2 PK	74.0	-31.8	1.38 H	344	40.1	2.1
6	4804.00	30.7 AV	54.0	-23.3	1.38 H	344	28.6	2.1

ANTENNA POLARITY & TEST DISTANCE: VERTICAL AT 3 M

NO.	FREQ. (MHz)	EMISSION LEVEL (dBuV/m)	LIMIT (dBuV/m)	MARGIN (dB)	ANTENNA HEIGHT (m)	TABLE ANGLE (Degree)	RAW VALUE (dBuV)	CORRECTION FACTOR (dB/m)
1	2390.00	54.8 PK	74.0	-19.2	3.44 V	273	56.9	-2.1
2	2390.00	42.0 AV	54.0	-12.0	3.44 V	273	44.1	-2.1
3	*2402.00	92.7 PK			3.44 V	273	94.8	-2.1
4	*2402.00	50.6 AV			3.44 V	273	52.7	-2.1
5	4804.00	40.5 PK	74.0	-33.5	1.13 V	260	38.4	2.1
6	4804.00	29.2 AV	54.0	-24.8	1.13 V	260	27.1	2.1

REMARKS:

1. Emission Level(dBuV/m) = Raw Value(dBuV) + Correction Factor(dB/m)
2. Correction Factor(dB/m) = Antenna Factor(dB/m) + Cable Factor(dB) – Pre-Amplifier Factor(dB)
3. Margin value = Emission Level – Limit value
4. The other emission levels were very low against the limit.
5. " * ": Fundamental frequency.

CHANNEL	TX Channel 41	DETECTOR FUNCTION	Peak (PK)
FREQUENCY RANGE	1GHz ~ 25GHz		Average (AV)

ANTENNA POLARITY & TEST DISTANCE: HORIZONTAL AT 3 M

NO.	FREQ. (MHz)	EMISSION LEVEL (dBuV/m)	LIMIT (dBuV/m)	MARGIN (dB)	ANTENNA HEIGHT (m)	TABLE ANGLE (Degree)	RAW VALUE (dBuV)	CORRECTION FACTOR (dB/m)
1	*2442.00	105.9 PK			1.08 H	9	108.2	-2.3
2	*2442.00	62.7 AV			1.08 H	9	65.0	-2.3
3	4884.00	42.3 PK	74.0	-31.7	1.38 H	341	40.1	2.2
4	4884.00	30.7 AV	54.0	-23.3	1.38 H	341	28.5	2.2
5	7326.00	51.6 PK	74.0	-22.4	3.33 H	15	43.6	8.0
6	7326.00	35.4 AV	54.0	-18.6	3.33 H	15	27.4	8.0

ANTENNA POLARITY & TEST DISTANCE: VERTICAL AT 3 M

NO.	FREQ. (MHz)	EMISSION LEVEL (dBuV/m)	LIMIT (dBuV/m)	MARGIN (dB)	ANTENNA HEIGHT (m)	TABLE ANGLE (Degree)	RAW VALUE (dBuV)	CORRECTION FACTOR (dB/m)
1	*2442.00	99.9 PK			3.46 V	269	102.2	-2.3
2	*2442.00	57.1 AV			3.46 V	269	59.4	-2.3
3	4884.00	40.4 PK	74.0	-33.6	1.04 V	256	38.2	2.2
4	4884.00	28.3 AV	54.0	-25.7	1.04 V	256	26.1	2.2
5	7326.00	51.7 PK	74.0	-22.3	1.56 V	253	43.7	8.0
6	7326.00	32.3 AV	54.0	-21.7	1.56 V	253	24.3	8.0

REMARKS:

1. Emission Level(dBuV/m) = Raw Value(dBuV) + Correction Factor(dB/m)
2. Correction Factor(dB/m) = Antenna Factor(dB/m) + Cable Factor(dB) – Pre-Amplifier Factor(dB)
3. Margin value = Emission Level – Limit value
4. The other emission levels were very low against the limit.
5. " * ": Fundamental frequency.

CHANNEL	TX Channel 80	DETECTOR FUNCTION	Peak (PK)
FREQUENCY RANGE	1GHz ~ 25GHz		Average (AV)

ANTENNA POLARITY & TEST DISTANCE: HORIZONTAL AT 3 M

NO.	FREQ. (MHz)	EMISSION LEVEL (dBuV/m)	LIMIT (dBuV/m)	MARGIN (dB)	ANTENNA HEIGHT (m)	TABLE ANGLE (Degree)	RAW VALUE (dBuV)	CORRECTION FACTOR (dB/m)
1	*2481.00	105.9 PK			1.04 H	17	108.3	-2.4
2	*2481.00	63.0 AV			1.04 H	17	65.4	-2.4
3	2483.50	68.9 PK	74.0	-5.1	1.04 H	17	71.3	-2.4
4	2483.50	47.2 AV	54.0	-6.8	1.04 H	17	49.6	-2.4
5	4962.00	42.5 PK	74.0	-31.5	1.34 H	351	40.2	2.3
6	4962.00	30.1 AV	54.0	-23.9	1.34 H	351	27.8	2.3
7	7443.00	52.1 PK	74.0	-21.9	3.32 H	17	43.7	8.4
8	7443.00	35.1 AV	54.0	-18.9	3.32 H	17	26.7	8.4

ANTENNA POLARITY & TEST DISTANCE: VERTICAL AT 3 M

NO.	FREQ. (MHz)	EMISSION LEVEL (dBuV/m)	LIMIT (dBuV/m)	MARGIN (dB)	ANTENNA HEIGHT (m)	TABLE ANGLE (Degree)	RAW VALUE (dBuV)	CORRECTION FACTOR (dB/m)
1	*2481.00	99.2 PK			3.45 V	246	101.6	-2.4
2	*2481.00	56.6 AV			3.45 V	246	59.0	-2.4
3	2483.50	64.5 PK	74.0	-9.5	3.45 V	246	66.9	-2.4
4	2483.50	45.4 AV	54.0	-8.6	3.45 V	246	47.8	-2.4
5	4962.00	40.4 PK	74.0	-33.6	1.07 V	277	38.1	2.3
6	4962.00	29.2 AV	54.0	-24.8	1.07 V	277	26.9	2.3
7	7443.00	50.8 PK	74.0	-23.2	1.56 V	254	42.4	8.4
8	7443.00	31.8 AV	54.0	-22.2	1.56 V	254	23.4	8.4

REMARKS:

1. Emission Level(dBuV/m) = Raw Value(dBuV) + Correction Factor(dB/m)
2. Correction Factor(dB/m) = Antenna Factor(dB/m) + Cable Factor(dB) – Pre-Amplifier Factor(dB)
3. The other emission levels were very low against the limit.
4. Margin value = Emission Level – Limit value
5. " * ": Fundamental frequency.

Below 1GHz Data:

CHANNEL	TX Channel 41	DETECTOR FUNCTION	Quasi-Peak (QP)
FREQUENCY RANGE	9kHz ~ 1GHz		

ANTENNA POLARITY & TEST DISTANCE: HORIZONTAL AT 3 M								
NO.	FREQ. (MHz)	EMISSION LEVEL (dBuV/m)	LIMIT (dBuV/m)	MARGIN (dB)	ANTENNA HEIGHT (m)	TABLE ANGLE (Degree)	RAW VALUE (dBuV)	CORRECTION FACTOR (dB/m)
1	38.76	32.4 QP	40.0	-7.6	1.00 H	213	42.0	-9.6
2	138.70	30.4 QP	43.5	-13.1	1.43 H	265	39.0	-8.6
3	343.31	28.3 QP	46.0	-17.7	1.50 H	264	34.4	-6.1
4	512.77	30.7 QP	46.0	-15.3	1.50 H	131	32.4	-1.7
5	776.10	34.8 QP	46.0	-11.2	1.50 H	154	31.7	3.1
6	946.50	36.8 QP	46.0	-9.2	1.00 H	265	31.4	5.4

REMARKS:

1. Emission Level(dBuV/m) = Raw Value(dBuV) + Correction Factor(dB/m)
2. Correction Factor(dB/m) = Antenna Factor(dB/m) + Cable Factor(dB) – Pre-Amplifier Factor(dB)
3. Margin value = Emission Level – Limit value
4. The emission levels were very low against the limit of frequency range 9kHz~30MHz: the amplitude of spurious emissions attenuated more than 20 dB below the permissible value to be report.

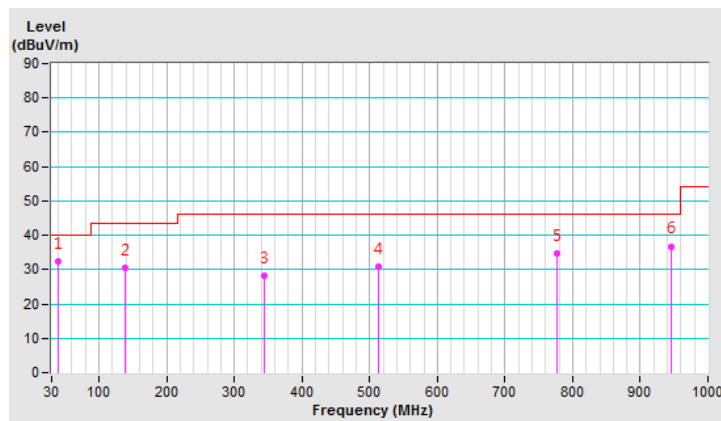

CHANNEL	TX Channel 41	DETECTOR FUNCTION	Quasi-Peak (QP)
FREQUENCY RANGE	9kHz ~ 1GHz		

ANTENNA POLARITY & TEST DISTANCE: VERTICAL AT 3 M

NO.	FREQ. (MHz)	EMISSION LEVEL (dBuV/m)	LIMIT (dBuV/m)	MARGIN (dB)	ANTENNA HEIGHT (m)	TABLE ANGLE (Degree)	RAW VALUE (dBuV)	CORRECTION FACTOR (dB/m)
1	30.38	31.5 QP	40.0	-8.5	1.50 V	264	41.2	-9.7
2	147.10	28.4 QP	43.5	-15.1	1.50 V	147	36.5	-8.1
3	461.50	30.2 QP	46.0	-15.8	1.00 V	263	33.4	-3.2
4	644.35	33.5 QP	46.0	-12.5	2.00 V	138	32.5	1.0
5	760.80	34.7 QP	46.0	-11.3	1.50 V	143	31.7	3.0
6	930.89	36.5 QP	46.0	-9.5	1.00 V	265	31.2	5.3

REMARKS:

1. Emission Level(dBuV/m) = Raw Value(dBuV) + Correction Factor(dB/m)
2. Correction Factor(dB/m) = Antenna Factor(dB/m) + Cable Factor(dB) – Pre-Amplifier Factor(dB)
3. Margin value = Emission Level – Limit value
4. The emission levels were very low against the limit of frequency range 9kHz~30MHz: the amplitude of spurious emissions attenuated more than 20 dB below the permissible value to be report.

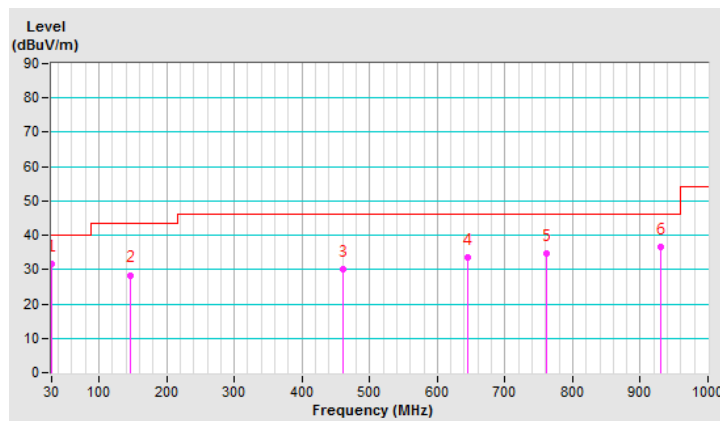

4.2 Conducted Emission Measurement

4.2.1 Limits of Conducted Emission Measurement

Frequency (MHz)	Conducted Limit (dBuV)	
	Quasi-peak	Average
0.15 - 0.5	66 - 56	56 - 46
0.50 - 5.0	56	46
5.0 - 30.0	60	50

Note: 1. The lower limit shall apply at the transition frequencies.

2. The limit decreases in line with the logarithm of the frequency in the range of 0.15 to 0.50MHz.

4.2.2 Test Instruments

DESCRIPTION & MANUFACTURER	MODEL NO.	SERIAL NO.	CALIBRATED DATE	CALIBRATED UNTIL
Test Receiver R&S	ESCS 30	847124/029	Oct. 24, 2018	Oct. 23, 2019
Line-Impedance Stabilization Network (for EUT) R&S	ESH3-Z5	848773/004	Oct. 22, 2018	Oct. 21, 2019
Line-Impedance Stabilization Network (for Peripheral) R&S	ENV216	100072	June 04, 2018	June 03, 2019
50 ohms Terminator	N/A	3	Oct. 22, 2018	Oct. 21, 2019
RF Cable	5D-FB	COCCAB-001	Sep. 28, 2018	Sep. 27, 2019
Fixed attenuator EMCI	STI02-2200-10	003	Mar. 16, 2018	Mar. 15, 2019
Software BVADT	BVADT_Cond_ V7.3.7.4	NA	NA	NA

Note:

1. The calibration interval of the above test instruments are 12 months and the calibrations are traceable to NML/ROC and NIST/USA.
2. The test was performed in Conduction 1.
3. Tested Date: Mar. 07, 2019

4.2.3 Test Procedures

- The EUT was placed 0.4 meters from the conducting wall of the shielded room with EUT being connected to the power mains through a line impedance stabilization network (LISN). Other support units were connected to the power mains through another LISN. The two LISNs provide 50 ohm/ 50uH of coupling impedance for the measuring instrument.
- Both lines of the power mains connected to the EUT were checked for maximum conducted interference.
- The frequency range from 150kHz to 30MHz was searched. Emission levels under (Limit - 20dB) was not recorded.

Note: The resolution bandwidth and video bandwidth of test receiver is 9kHz for quasi-peak detection (QP) and average detection (AV) at frequency 0.15MHz-30MHz.

4.2.4 Deviation from Test Standard

No deviation.

4.2.5 Test Setup

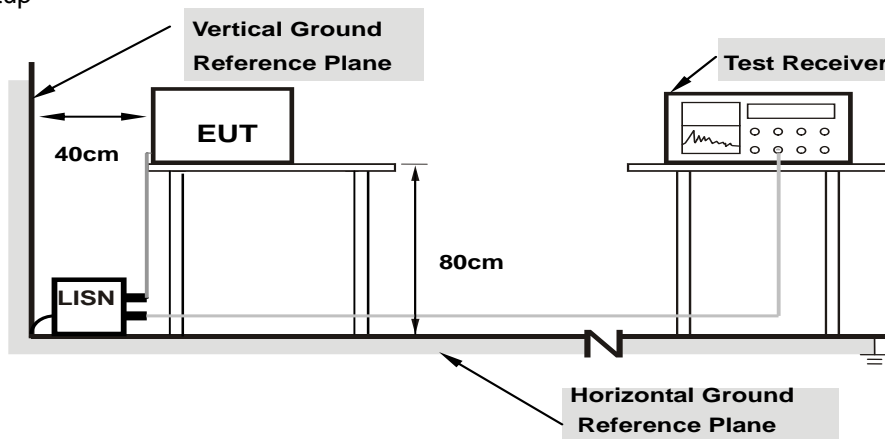

Note: 1.Support units were connected to second LISN.

For the actual test configuration, please refer to the attached file (Test Setup Photo).

4.2.6 EUT Operating Conditions

Same as 4.1.6.

4.2.7 Test Results

Phase	Line (L)	Detector Function	Quasi-Peak (QP) / Average (AV)
-------	----------	-------------------	--------------------------------

No	Freq. [MHz]	Corr.	Reading Value		Emission Level		Limit		Margin	
		Factor (dB)	[dB (uV)]		[dB (uV)]		[dB (uV)]		(dB)	
			Q.P.	AV.	Q.P.	AV.	Q.P.	AV.	Q.P.	AV.
1	0.15000	10.02	37.14	15.65	47.16	25.67	66.00	56.00	-18.84	-30.33
2	0.18124	10.03	35.02	18.03	45.05	28.06	64.43	54.43	-19.38	-26.37
3	0.54845	10.08	21.95	6.23	32.03	16.31	56.00	46.00	-23.97	-29.69
4	0.87655	10.10	20.31	8.54	30.41	18.64	56.00	46.00	-25.59	-27.36
5	3.51560	10.23	22.61	15.64	32.84	25.87	56.00	46.00	-23.16	-20.13
6	8.31640	10.45	17.45	11.38	27.90	21.83	60.00	50.00	-32.10	-28.17

Remarks:

1. Q.P. and AV. are abbreviations of quasi-peak and average individually.
2. The emission levels of other frequencies were very low against the limit.
3. Margin value = Emission level – Limit value
4. Correction factor = Insertion loss + Cable loss
5. Emission Level = Correction Factor + Reading Value

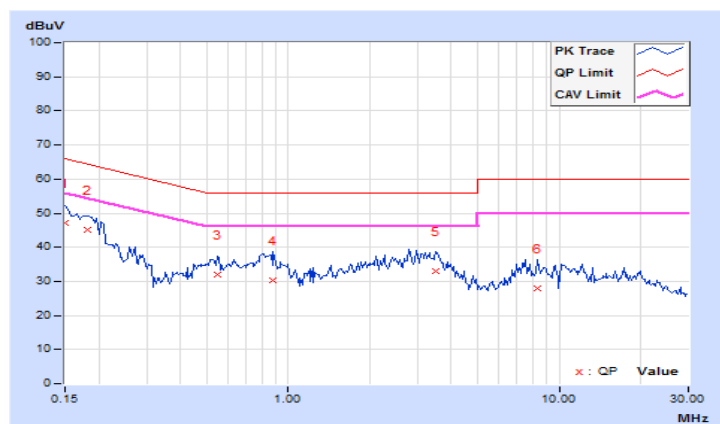

Phase	Neutral (N)	Detector Function	Quasi-Peak (QP) / Average (AV)
-------	-------------	-------------------	--------------------------------

No	Freq. [MHz]	Corr.	Reading Value		Emission Level		Limit		Margin	
		Factor	[dB (uV)]		[dB (uV)]		[dB (uV)]		(dB)	
	(dB)	Q.P.	AV.	Q.P.	AV.	Q.P.	AV.	Q.P.	AV.	
1	0.15000	9.93	40.72	18.66	50.65	28.59	66.00	56.00	-15.35	-27.41
2	0.16561	9.93	35.53	13.81	45.46	23.74	65.18	55.18	-19.72	-31.44
3	0.88439	9.98	20.76	9.15	30.74	19.13	56.00	46.00	-25.26	-26.87
4	3.35546	10.09	23.54	16.03	33.63	26.12	56.00	46.00	-22.37	-19.88
5	7.66798	10.28	18.76	13.04	29.04	23.32	60.00	50.00	-30.96	-26.68
6	11.22265	10.44	18.53	11.62	28.97	22.06	60.00	50.00	-31.03	-27.94

Remarks:

1. Q.P. and AV. are abbreviations of quasi-peak and average individually.
2. The emission levels of other frequencies were very low against the limit.
3. Margin value = Emission level – Limit value
4. Correction factor = Insertion loss + Cable loss
5. Emission Level = Correction Factor + Reading Value

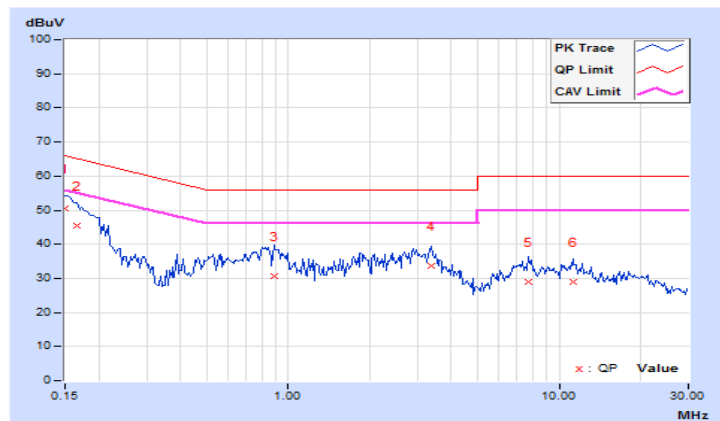

4.3 6dB Bandwidth Measurement

4.3.1 Limits of 6dB Bandwidth Measurement

The minimum of 6dB Bandwidth Measurement is 0.5 MHz.

4.3.2 Test Setup

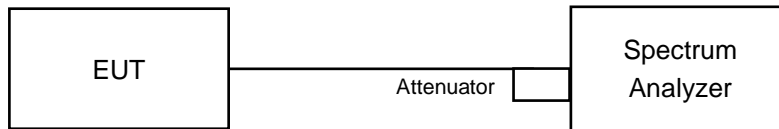

4.3.3 Test Instruments

Refer to section 4.1.2 to get information of above instrument.

4.3.4 Test Procedure

- a. Set resolution bandwidth (RBW) = 100kHz
- b. Set the video bandwidth (VBW) $\geq 3 \times$ RBW, Detector = Peak.
- c. Trace mode = max hold.
- d. Sweep = auto couple.
- e. Measure the maximum width of the emission that is constrained by the frequencies associated with the two amplitude points (upper and lower) that are attenuated by 6 dB relative to the maximum level measured in the fundamental emission

4.3.5 Deviation from Test Standard

No deviation.

4.3.6 EUT Operating Conditions

The software provided by client to enable the EUT under transmission condition continuously at lowest, middle and highest channel frequencies individually.

4.3.7 Test Results

Channel	Frequency (MHz)	6dB Bandwidth (MHz)	Minimum Limit (MHz)	Pass / Fail
1	2402	1.21	0.5	Pass
41	2442	1.18	0.5	Pass
80	2481	1.20	0.5	Pass

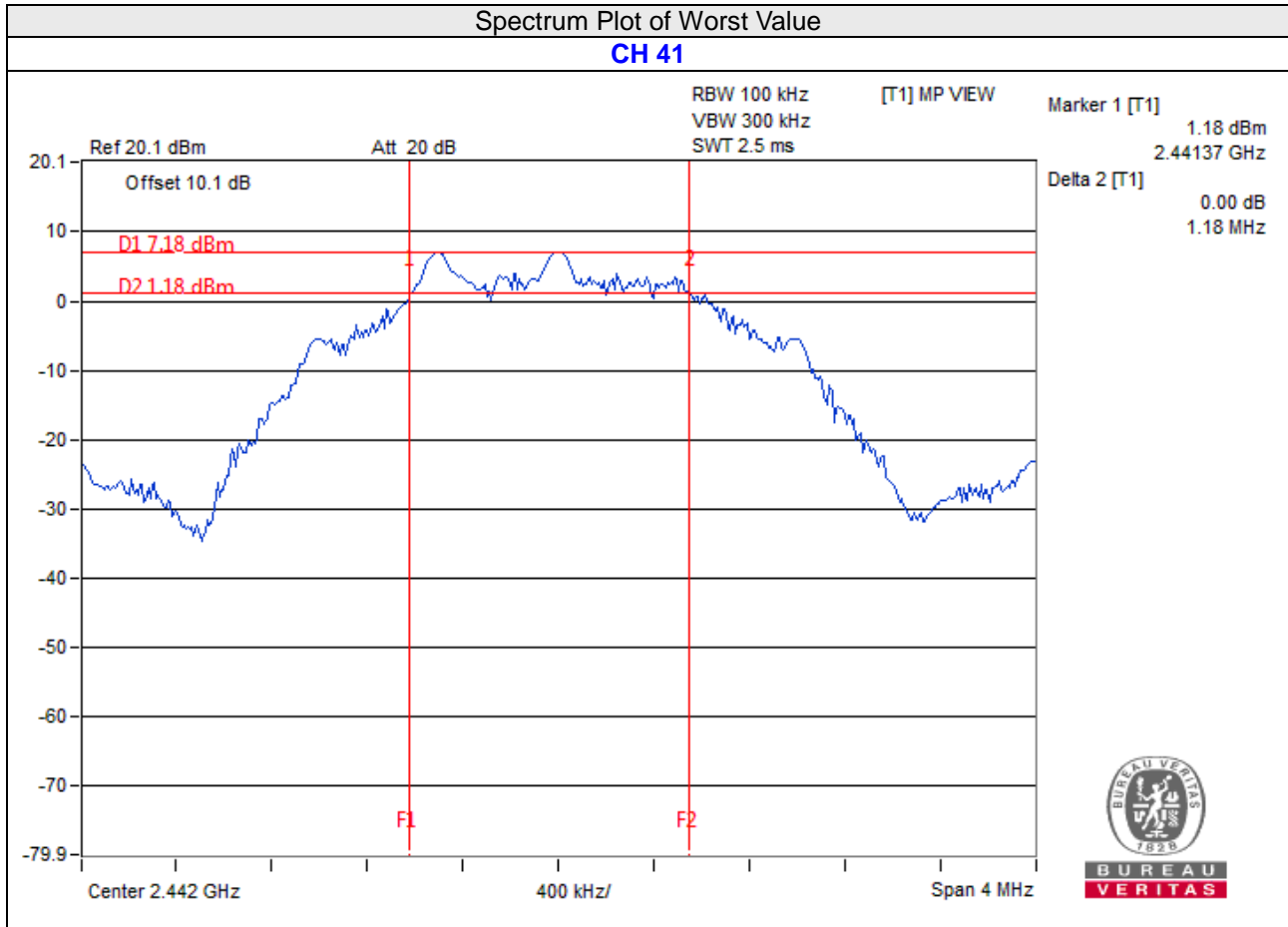

4.4 Conducted Output Power Measurement

4.4.1 Limits of Conducted Output Power Measurement

For systems using digital modulation in the 2400–2483.5 MHz bands: 1 Watt (30dBm)

4.4.2 Test Setup

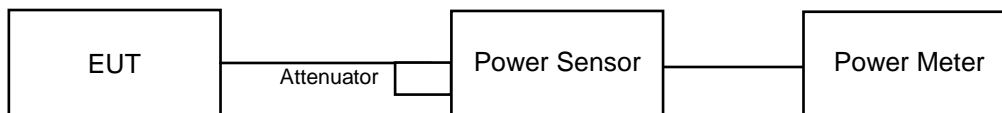

4.4.3 Test Instruments

Refer to section 4.1.2 to get information of above instrument.

4.4.4 Test Procedures

A peak power sensor was used on the output port of the EUT. A power meter was used to read the response of the peak power sensor. Record the power level.

Average power sensor was used to perform output power measurement, trigger and gating function of wide band power meter is enabled to measure max output power of TX on burst. Duty factor is not added to measured value.

4.4.5 Deviation from Test Standard

No deviation.

4.4.6 EUT Operating Conditions

Same as Item 4.3.6.

4.4.7 Test Results

FOR PEAK POWER

Channel	Frequency (MHz)	Peak Power (mW)	Peak Power (dBm)	Limit (dBm)	Pass/Fail
1	2402	1.312	1.18	30	Pass
41	2442	6.887	8.38	30	Pass
80	2481	6.745	8.29	30	Pass

FOR AVERAGE POWER

Channel	Frequency (MHz)	Average Power (mW)	Average Power (dBm)
1	2402	1.276	1.06
41	2442	6.792	8.32
80	2481	6.668	8.24

4.5 Power Spectral Density Measurement

4.5.1 Limits of Power Spectral Density Measurement

The Maximum of Power Spectral Density Measurement is 8dBm in any 3 kHz.

4.5.2 Test Setup

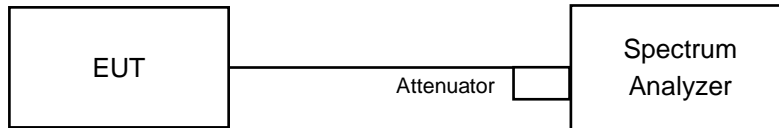

4.5.3 Test Instruments

Refer to section 4.1.2 to get information of above instrument.

4.5.4 Test Procedure

- a. Set analyzer center frequency to DTS channel center frequency.
- b. Set the span to 1.5 times the DTS bandwidth.
- c. Set the RBW to: $3 \text{ kHz} \leq \text{RBW} \leq 100 \text{ kHz}$.
- d. Set the VBW $\geq 3 \times \text{RBW}$.
- e. Detector = peak.
- f. Sweep time = auto couple.
- g. Trace mode = max hold.
- h. Allow trace to fully stabilize.
- i. Use the peak marker function to determine the maximum amplitude level within the RBW.

4.5.5 Deviation from Test Standard

No deviation.

4.5.6 EUT Operating Condition

Same as Item 4.3.6.

4.5.7 Test Results

Channel	Freq. (MHz)	PSD (dBm/3kHz)	Limit (dBm/3kHz)	Pass /Fail
1	2402	-7.83	8	Pass
41	2442	-1.05	8	Pass
80	2481	-0.81	8	Pass

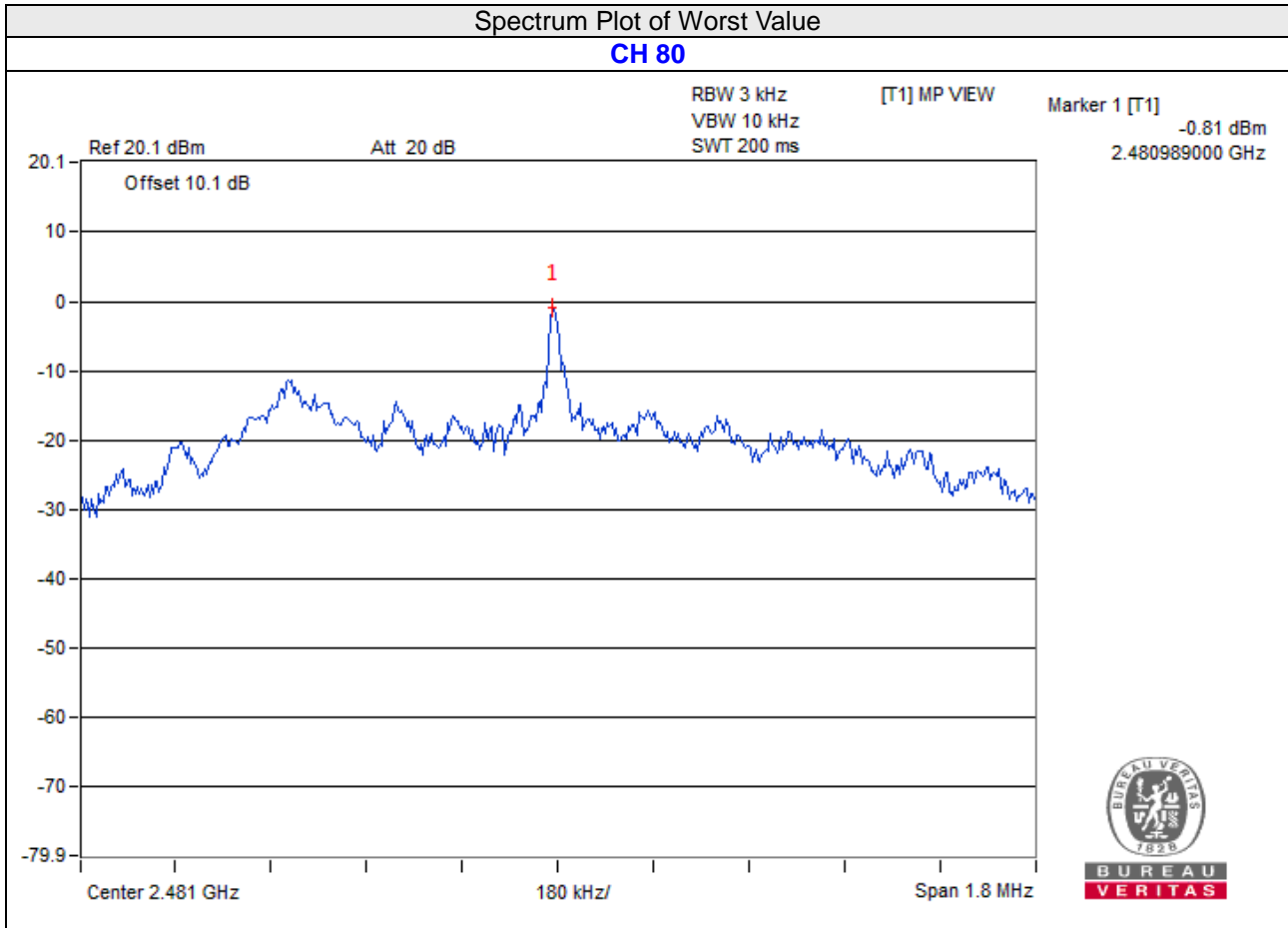

4.6 Conducted Out of Band Emission Measurement

4.6.1 Limits of Conducted Out of Band Emission Measurement

Below 20dB of the highest emission level of operating band (in 100kHz Resolution Bandwidth).

4.6.2 Test Setup

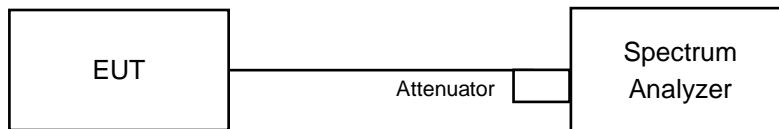

4.6.3 Test Instruments

Refer to section 4.1.2 to get information of above instrument.

4.6.4 Test Procedure

MEASUREMENT PROCEDURE REF

1. Set the RBW = 100 kHz.
2. Set the VBW \geq 300 kHz.
3. Detector = peak.
4. Sweep time = auto couple.
5. Trace mode = max hold.
6. Allow trace to fully stabilize.
7. Use the peak marker function to determine the maximum power level in any 100 kHz band segment within the fundamental EBW.

MEASUREMENT PROCEDURE OOB

1. Set RBW = 100 kHz.
2. Set VBW \geq 300 kHz.
3. Detector = peak.
4. Sweep = auto couple.
5. Trace Mode = max hold.
6. Allow trace to fully stabilize.
7. Use the peak marker function to determine the maximum amplitude level.

4.6.5 Deviation from Test Standard

No deviation.

4.6.6 EUT Operating Condition

The software provided by client enabled the EUT to transmit and receive data at lowest and highest channel frequencies individually.

4.6.7 Test Results

The spectrum plots are attached on the following pages. D1 line indicates the highest level, and D2 line indicates the 20dB offset below D1. It shows compliance with the requirement.

CH 1

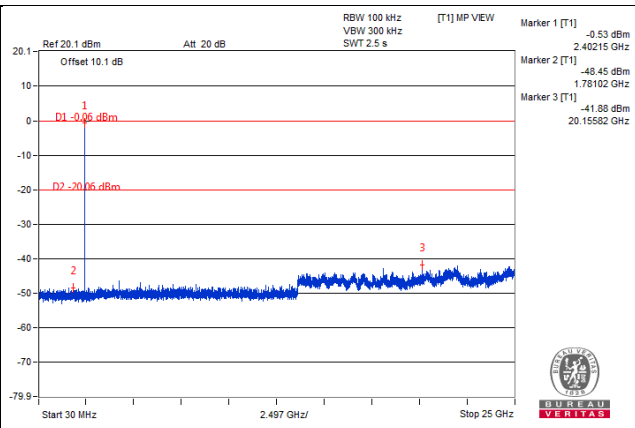
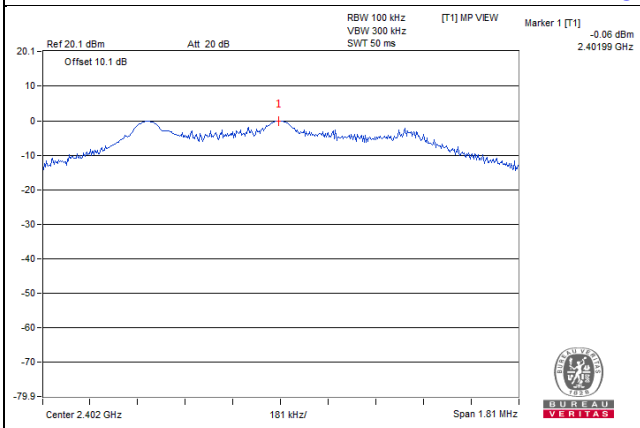

CH 41

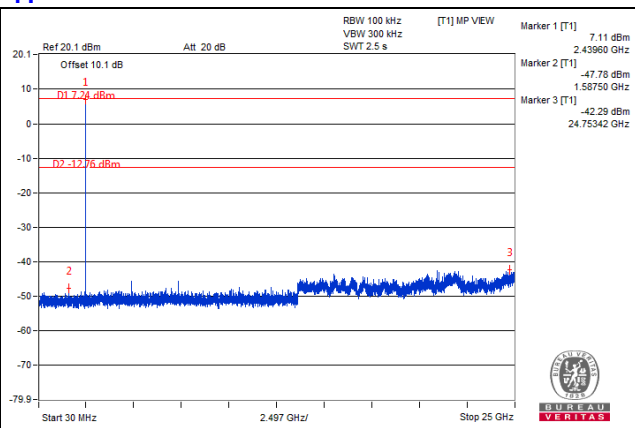
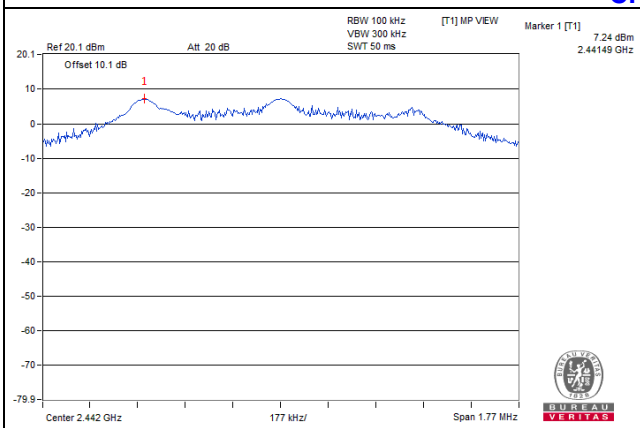

CH 80

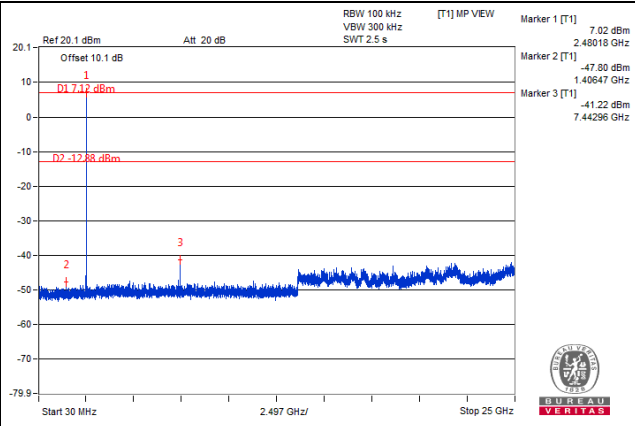
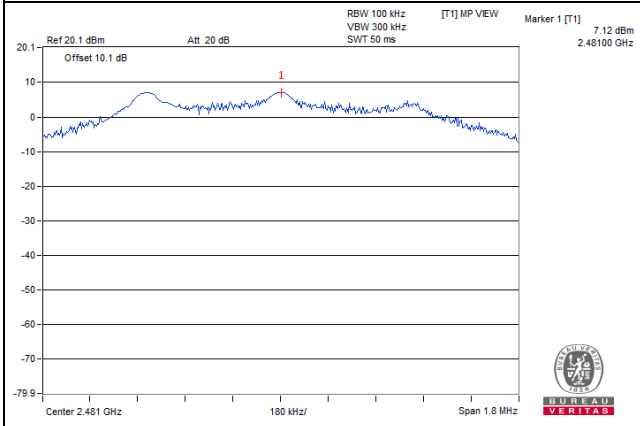

CH 1 Band edge

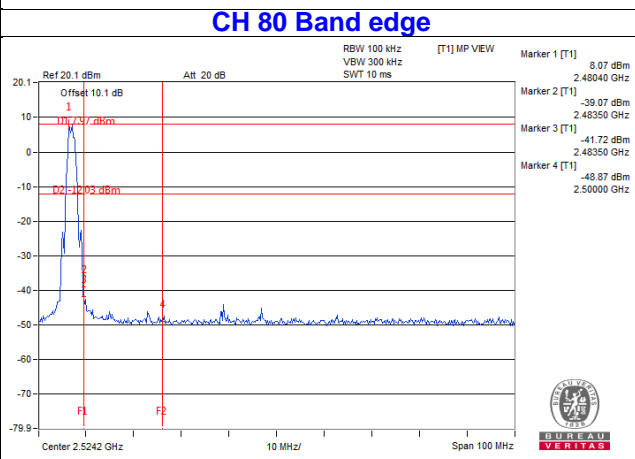
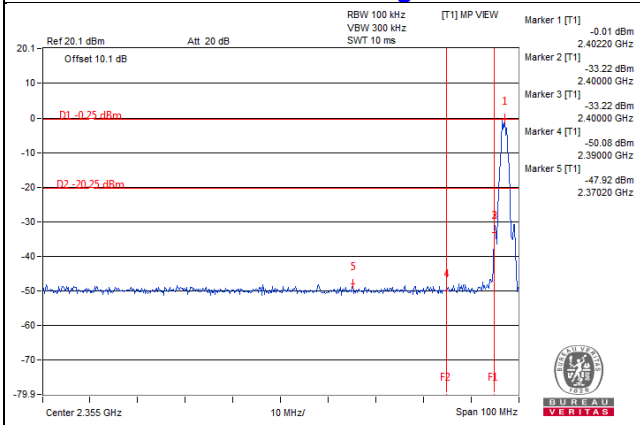

5 Pictures of Test Arrangements

Please refer to the attached file (Test Setup Photo).

Appendix – Information of the Testing Laboratories

We, Bureau Veritas Consumer Products Services (H.K.) Ltd., Taoyuan Branch, were founded in 1988 to provide our best service in EMC, Radio, Telecom and Safety consultation. Our laboratories are FCC recognized accredited test firms and accredited according to ISO/IEC 17025.

If you have any comments, please feel free to contact us at the following:

Lin Kou EMC/RF Lab

Tel: 886-2-26052180

Fax: 886-2-26051924

Hsin Chu EMC/RF/Telecom Lab

Tel: 886-3-6668565

Fax: 886-3-6668323

Hwa Ya EMC/RF/Safety Lab

Tel: 886-3-3183232

Fax: 886-3-3270892

Email: service.adt@tw.bureauveritas.com

Web Site: www.bureauveritas-adt.com

The address and road map of all our labs can be found in our web site also.

--- END ---