

## FCC Certification Test Report

**Report No.:** FC170905E06

**Test Model:** M-R0073

**Received Date:** Sep. 29, 2017

**Test Date:** Sep. 29, 2017

**Issued Date:** Oct. 11, 2017

**Applicant:** LOGITECH FAR EAST LTD.

**Address:** #2 Creation Rd. 4, Science-Based Ind. Park Hsinchu Taiwan, R.O.C.

**Issued By:** Bureau Veritas Consumer Products Services (H.K.) Ltd., Taoyuan Branch  
Hsin Chu Laboratory

**Lab Address:** E-2, No.1, Li Hsin 1st Road, Hsinchu Science Park, Hsinchu City 300,  
Taiwan R.O.C.

**Test Location (1):** E-2, No.1, Li Hsin 1st Road, Hsinchu Science Park, Hsinchu City 300,  
Taiwan R.O.C.

**Test Location (2):** No. 49, Ln. 206, Wende Rd., Shangshan Tsuen, Chiung Lin Hsiang, Hsin  
Chu Hsien 307, Taiwan R.O.C.



This report is for your exclusive use. Any copying or replication of this report to or for any other person or entity, or use of our name or trademark, is permitted only with our prior written permission. This report sets forth our findings solely with respect to the test samples identified herein. The results set forth in this report are not indicative or representative of the quality or characteristics of the lot from which a test sample was taken or any similar or identical product unless specifically and expressly noted. Our report includes all of the tests requested by you and the results thereof based upon the information that you provided to us. You have 60 days from date of issuance of this report to notify us of any material error or omission caused by our negligence, provided, however, that such notice shall be in writing and shall specifically address the issue you wish to raise. A failure to raise such issue within the prescribed time shall constitute your unqualified acceptance of the completeness of this report, the tests conducted and the correctness of the report contents. Unless specific mention, the uncertainty of measurement has been explicitly taken into account to declare the compliance or non-compliance to the specification.. The report must not be used by the client to claim product certification, approval, or endorsement by TAF or any government agencies.

## Table of Contents

<b>Release Control Record .....</b>	<b>3</b>
<b>1 Certificate of Conformity .....</b>	<b>4</b>
<b>2 Summary of Test Results.....</b>	<b>5</b>
2.1 Measurement Uncertainty .....	5
2.2 Modification Record .....	5
<b>3 General Information .....</b>	<b>6</b>
3.1 Features of EUT .....	6
3.2 General Description of EUT .....	6
3.3 Operating Modes of EUT and Determination of Worst Case Operating Mode .....	7
3.4 Test Program Used and Operation Descriptions.....	7
3.5 Primary Clock Frequencies of Internal Source .....	7
3.6 Miscellaneous.....	8
<b>4 Configuration and Connections with EUT .....</b>	<b>9</b>
4.1 Connection Diagram of EUT and Peripheral Devices .....	9
4.2 Configuration of Peripheral Devices and Cable Connections .....	9
<b>5 Radiated Emissions up to 1 GHz .....</b>	<b>10</b>
5.1 Limits .....	10
5.2 Test Instruments .....	11
5.3 Test Arrangement .....	12
5.4 Supplementary Information .....	12
5.5 Test Results.....	13
<b>6 Radiated Emissions above 1 GHz.....</b>	<b>15</b>
6.1 Limits .....	15
6.2 Test Instruments .....	16
6.3 Test Arrangement .....	17
6.4 Supplementary Information .....	17
6.5 Test Results.....	18
<b>7 Pictures of Test Arrangements .....</b>	<b>20</b>
<b>Appendix – Information on the Testing Laboratories .....</b>	<b>21</b>

### Release Control Record

Issue No.	Description	Date Issued
FC170905E06	Original release.	Oct. 11, 2017

## 1 Certificate of Conformity

**Product:** 2.4GHz Cordless Mouse

**Brand:** Logitech

**Test Model:** M-R0073

**Sample Status:** ENGINEERING SAMPLE

**Applicant:** LOGITECH FAR EAST LTD.

**Test Date:** Sep. 09, 2017

**Standards:** 47 CFR FCC Part 15, Subpart B, Class B  
ICES-003:2016 Issue 6, Class B  
ANSI C63.4:2014

The above equipment has been tested by **Bureau Veritas Consumer Products Services (H.K.) Ltd., Taoyuan Branch**, and found compliance with the requirement of the above standards. The test record, data evaluation & Equipment Under Test (EUT) configurations represented herein are true and accurate accounts of the measurements of the sample's EMC characteristics under the conditions specified in this report.

**Prepared by :** Nico Liu , **Date:** Oct. 11, 2017  
Nico Liu / Specialist

**Approved by :** Ken Lu , **Date:** Oct. 11, 2017  
Ken Lu / Manager

## 2 Summary of Test Results

47 CFR FCC Part 15: 2015, Subpart B , Class B/ ICES-003:2016 Issue 6, Class

ANSI C63.4:2014

FCC Clause	ICES-003 Clause	Test Item	Result/Remarks	Verdict
15.107	6.1	AC Power Line Conducted Emissions	Not applicable, because the port is absent in the EUT	N/A
15.109	6.2.1	Radiated Emissions up to 1 GHz	Minimum passing Class B margin is -4.30 dB at 226.09 MHz	Pass
	6.2.2	Radiated Emissions above 1 GHz	Minimum passing Class B margin is -22.89 dB at 5082.98 MHz	Pass

Note: There is no deviation to the applied test methods and requirements covered by the scope of this report.

### 2.1 Measurement Uncertainty

Where relevant, the following measurement uncertainty levels have been estimated for tests performed on the EUT:

The listed uncertainties are the worst case uncertainty for the entire range of measurement. Please note that the uncertainty values are provided for informational purposes only and are not used in determining the PASS/FAIL results.

Measurement	Frequency	Expanded Uncertainty (k=2) ( $\pm$ )
Radiated Emissions up to 1 GHz	30MHz ~ 1GHz	3.91 dB
Radiated Emissions above 1 GHz	1GHz ~ 6GHz	4.73 dB
	6GHz ~ 18GHz	5.24 dB
	18GHz ~40GHz	5.25 dB

### 2.2 Modification Record

There were no modifications required for compliance.

### 3 General Information

#### 3.1 Features of EUT

The tests reported herein were performed according to the method specified by LOGITECH FAR EAST LTD., for detailed feature description, please refer to the manufacturer's specifications or user's manual.

#### 3.2 General Description of EUT

Product	2.4GHz Cordless Mouse
Brand	Logitech
Test Model	M-R0073
Status of EUT	ENGINEERING SAMPLE
Power Supply Rating	DC 1.5V from battery
Modulation Type	GFSK
Transfer Rate	2Mbps
Operating Frequency	2405MHz ~ 2474MHz
Antenna Type	Refer to Note
Antenna Connector	Refer to Note
Accessory Device	NA
Data Cable Supplied	NA

Note:

1. The EUT may have a lot of colors for marketing requirement.
2. The antenna provided to the EUT, please refer to the following table:

Brand	Model	Antenna Gain (dBi)	Frequency range(GHz)	Antenna Type	Connector Type	Cable Length
NA	NA	-0.20	2.4-2.4835	PCB printed Antenna	NA	NA

3. The above EUT information is declared by manufacturer and for more detailed features description, please refer to the manufacturer's specifications or user's manual.

### 3.3 Operating Modes of EUT and Determination of Worst Case Operating Mode

There are both standby mode and normal mode to be pre-tested then normal mode has the highest emission value for radiated emission test.

Test mode is presented in the report as below.

Mode	Test Condition
1	Normal Mode

### 3.4 Test Program Used and Operation Descriptions

1. Turn on the power of all equipment.
2. EUT link support unit B (Laptop) by Wireless 2.4G via support unit C (2.4GHz Transceiver).
3. Support unit B (Laptop) runs "EMC test.exe" then sends "H" messages to itself.

### 3.5 Primary Clock Frequencies of Internal Source

The EUT is provided by LOGITECH FAR EAST LTD., for detailed internal source, please refer to the manufacturer's specifications.

### 3.6 Miscellaneous

#### Labelling Requirements for Part 15 Devices:

➤ Verification

The specific labelling requirements for a device subject to the Verification procedure are contained in Section 15.19(a). These labelling requirements are:

If the device is subject only to Verification, include a label bearing a unique identifier (Section 2.954) and one of three compliance statements specified in Section 15.19(a). If the labeling area for the device is so small, and/or it is not practical to place the compliance statement on the device, then the statement can be placed in the user manual or product packaging (Section 15.19(a)(5)). However, the device must still be labelled with the unique identifier (Verification). Generally, devices smaller than the palm of the hand are considered too small for the compliance statement.

➤ Certification

If the device is subject to Certification: (1) Section 2.925 contains information on identification of the equipment; (2) include a label bearing an FCC Identifier (FCC ID) (Section 2.926) and (3) include the appropriate compliance statement in Section 15.19(a). If the device is considered too small and therefore it is impractical (smaller than the palm of the hand) to display the compliance statement, then the statement may be placed in the user manual or product packaging. However, the device must still be labelled with the FCC ID. If the device is unquestionably too small for the FCC ID to be readable (smaller than 4-6 points), the FCC ID may be placed in the user manual. However, it must be determined that the device itself is too small – the label area allocated to the FCC ID may not be reduced because of over crowded identification of other product and regulatory information.

An electronic display of the FCC ID (see 9. Electronic Labelling below) may be used for Certification of Section 15.212 modular transmitters and software defined radios (Section 2.944).

➤ Declaration of Conformity (DoC):

The labelling requirements for a device subject to the DoC procedure are specified in Section 15.19(b). The label should include the FCC logo along with the Trade Name and Model Number, which satisfies the unique identifier requirement of Section 2.1074 if it represents the identical equipment tested for DoC compliance. For personal computers assembled from authorized components, the following additional text must also be included: “Assembled from tested components,” “Complete system not tested.” When the device is so small and/or when it is not practical to place the required additional text on the device, the text may be placed in the user manual or pamphlet supplied to the user. However, the FCC logo, Trade Name, and Model Number must still be displayed on the device (Section 15.19(b)(3)).



Part 15 Declaration of Conformity (DoC) Label Examples

Equipment certified as software defined radio may use a means that readily displays the FCC ID on an electronic display screen, instead of labelling the device (Section 2.925 (e)).

Further information may refer to FCC KDB:784748 D01 Labelling Part 15 &18 Guidelines

#### Labelling Requirements for ICES-003 Devices:

➤ Industry Canada ICES-003 Compliance Label:

*CAN ICES-3 (\*)/NMB-3(\*)*

\* Insert either “A” or “B” but not both to identify the applicable Class of ITE.



## 4 Configuration and Connections with EUT

### 4.1 Connection Diagram of EUT and Peripheral Devices

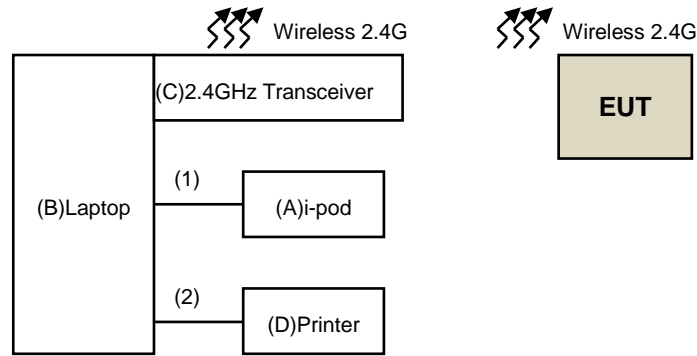

### 4.2 Configuration of Peripheral Devices and Cable Connections

ID	Product	Brand	Model No.	Serial No.	FCC ID	Remarks
A	i-pod	Apple	MC749TA/A	CC4DMFJUDFDM	NA	Provided by Lab
B	Laptop	DELL	Latitude E5440	519OP32	FCC DoC	Provided by Lab
C	2.4GHz Transceiver	Logitech	C-U0007	NA	NA	Provided by Lab
D	Printer	EPSON	LQ-300+II	G88Y074085	FCC DoC	Provided by Lab
E	PC	DELL	DCSCMF	CKKB32S	FCC DoC	Provided by Lab
F	Monitor	DELL	E2210C	CN-0W366R-64180-05J-0CVS	FCC DoC	Provided by Lab
G	USB Keyboard	DELL	SK-8115	MY-0DJ325-71619-99B-0476	FCC DoC	Provided by Lab

1. All power cords of the above support units are non-shielded (1.8m).

ID	Descriptions	Qty.	Length (m)	Shielding (Yes/No)	Cores (Qty.)	Remarks
1	USB Cable	1	1.2	Yes	0	Supplied by client
2	USB Cable	1	1.8	Yes	0	Provided by Lab
3	VGA Cable	1	1.8	Yes	2	Provided by Lab
4	USB Cable	1	1.8	Yes	0	Provided by Lab

Note: The cores are originally attached to the cable

## 5 Radiated Emissions up to 1 GHz

### 5.1 Limits

Emissions radiated outside of the specified bands, shall be according to the general radiated limits as following:

Radiated Emissions Limits at 10 meters (dB $\mu$ V/m)				
Frequencies (MHz)	FCC 15B / ICES-003, Class A	FCC 15B / ICES-003, Class B	CISPR 22, Class A	CISPR 22, Class B
30-88	39	29.5	40	30
88-216	43.5	33.1		
216-230	46.4	35.6		
230-960			47	37
960-1000	49.5	43.5		

Radiated Emissions Limits at 3 meters (dB $\mu$ V/m)				
Frequencies (MHz)	FCC 15B / ICES-003, Class A	FCC 15B / ICES-003, Class B	CISPR 22, Class A	CISPR 22, Class B
30-88	49.5	40	50.5	40.5
88-216	54	43.5		
216-230	56.9	46		
230-960			57.5	47.5
960-1000	60	54		

- Notes:
1. The lower limit shall apply at the transition frequencies.
  2. Emission level (dB $\mu$ V/m) = 20 log Emission level (uV/m).
  3. QP detector shall be applied if not specified.

## 5.2 Test Instruments

DESCRIPTION & MANUFACTURER	MODEL NO.	SERIAL NO.	CALIBRATED DATE	CALIBRATED UNTIL
Test Receiver Agilent	N9038A	MY50010125	Apr. 15, 2017	Apr. 14, 2018
	N9038A	MY50010132	June 16, 2017	June 15, 2018
Pre-Amplifier Sonoma	310N	352925	Aug. 28, 2017	Aug. 27, 2018
	310N	352926	Aug. 28, 2017	Aug. 27, 2018
Trilog Broadband Antenna SCHWARZBECK	VULB 9168	9168-359	Dec. 28, 2016	Dec. 27, 2017
	VULB 9168	9168-358	Dec. 16, 2016	Dec. 15, 2017
Fixed attenuator Mini-Circuits	UNAT-5+	CHF-001	Sep. 07, 2017	Sep. 06, 2018
	UNAT-5+	CHF-002	Sep. 07, 2017	Sep. 06, 2018
RF Cable	8D-FB	CHFCAB-001-1 CHFCAB-001-3 CHFCAB-001-4	Sep. 20, 2017	Sep. 19, 2018
		CHFCAB-002-1 CHFCAB-002-3 CHFCAB-002-4	Sep. 20, 2017	Sep. 19, 2018
Software BVADT	ADT_Radiated_V 8.7.08	NA	NA	NA
Antenna Tower & Turn Table CT	NA	NA	NA	NA

### Note:

1. The calibration interval of the above test instruments are 12 months and the calibrations are traceable to NML/ROC and NIST/USA.
2. The test was performed in 10m Chamber No. F.
3. The VCCI Site Registration No. is R-3252.
4. The FCC Designation Number is TW1085.
5. The CANADA Site Registration No. is IC 7450H-1.
6. Tested Date: Sep. 29, 2017

### 5.3 Test Arrangement

- The EUT was placed on the top of a rotating table 0.8 meters above the ground at an accredited test facility. The table was rotated 360 degrees to determine the position of the highest radiation.
- The EUT was set 10 meters away from the interference-receiving antenna, which was mounted on the top of a variable-height antenna tower.
- The antenna is a broadband antenna, and its height is varied from one meter to four meters above the ground to determine the maximum value of the field strength. Both horizontal and vertical polarizations of the antenna are set to make the measurement.
- For each suspected emission, the EUT was arranged to its worst case and then the antenna was tuned to heights from 1 meter to 4 meters and the rotatable table was turned from 0 degrees to 360 degrees to find the maximum reading.
- The test-receiver system was set to quasi-peak detect function and specified bandwidth with maximum hold mode when the test frequency is up to 1 GHz.

Note: The resolution bandwidth and video bandwidth of test receiver/spectrum analyzer is 120kHz for quasi-peak detection (QP) at frequency up to 1GHz.

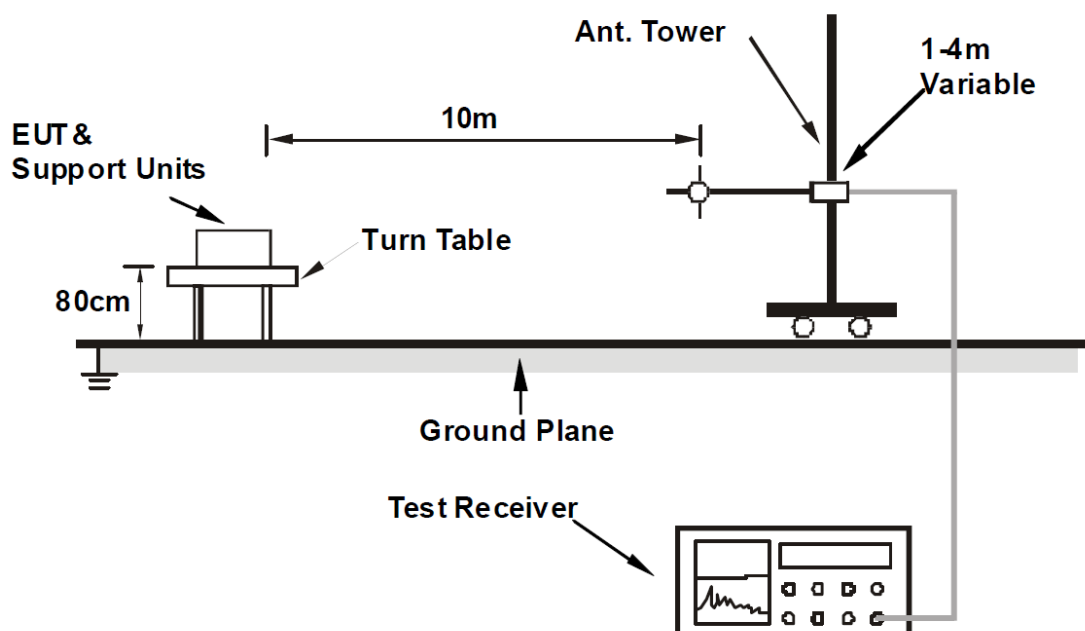

For the actual test configuration, please refer to the related Item – Photographs of the Test Configuration.

### 5.4 Supplementary Information

There is not any deviation from the test standards for the test method.

### 5.5 Test Results

Frequency Range	30MHz ~ 1GHz	Detector Function & Resolution Bandwidth	Quasi-Peak (QP), 120kHz
Input Power	DC 1.5V from battery	Environmental Conditions	22°C, 68%RH
Tested by	David Chuang		
Test Mode	Mode 1		

Antenna Polarity & Test Distance : Horizontal at 10 m								
No	Frequency (MHz)	Emission Level (dBuV/m)	Limit (dBuV/m)	Margin (dB)	Antenna Height (m)	Table Angle (Degree)	Raw Value (dBuV)	Correction Factor (dB/m)
1	36.89	15.37 QP	30.00	-14.63	4.00 H	31	29.20	-13.83
2	210.54	22.42 QP	30.00	-7.58	4.00 H	118	37.94	-15.52
3	253.00	24.29 QP	37.00	-12.71	4.00 H	135	37.65	-13.36
4	281.16	21.01 QP	37.00	-15.99	4.00 H	310	33.06	-12.05
5	421.59	26.04 QP	37.00	-10.96	3.00 H	356	34.41	-8.37
6	491.91	30.60 QP	37.00	-6.40	3.00 H	34	37.39	-6.79

Remarks:

1. Emission Level(dBuV/m) = Raw Value(dBuV) + Correction Factor(dB/m)
2. Correction Factor(dB/m) = Antenna Factor (dB/m) + Cable Factor (dB) – Pre-Amplifier Factor (dB)
3. The other emission levels were very low against the limit.
4. Margin value = Emission level – Limit value

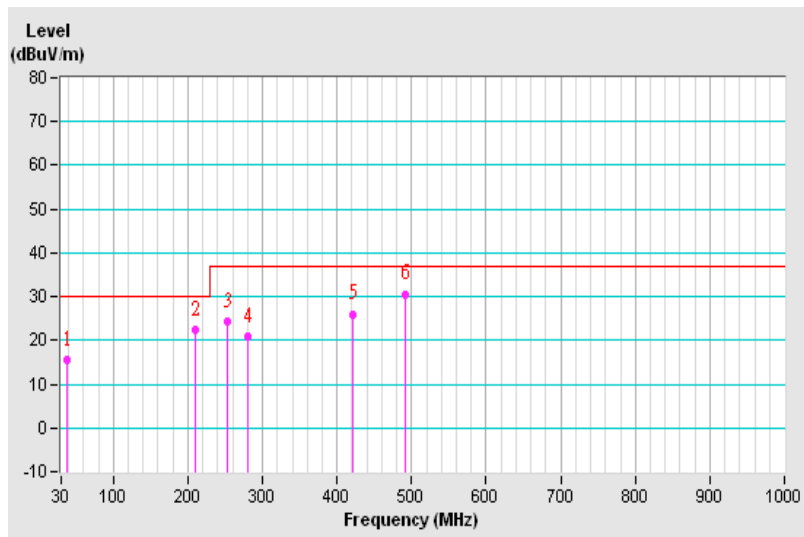

Frequency Range	30MHz ~ 1GHz	Detector Function & Resolution Bandwidth	Quasi-Peak (QP), 120kHz
Input Power	DC 1.5V from battery	Environmental Conditions	22°C, 68%RH
Tested by	David Chuang		
Test Mode	Mode 1		

Antenna Polarity & Test Distance : Vertical at 10 m								
No	Frequency (MHz)	Emission Level (dBuV/m)	Limit (dBuV/m)	Margin (dB)	Antenna Height (m)	Table Angle (Degree)	Raw Value (dBuV)	Correction Factor (dB/m)
1	45.69	21.98 QP	30.00	-8.02	3.00 V	106	35.01	-13.03
2	210.57	23.02 QP	30.00	-6.98	1.00 V	8	38.72	-15.70
<b>3</b>	<b>226.09</b>	<b>25.70 QP</b>	<b>30.00</b>	<b>-4.30</b>	<b>2.00 V</b>	<b>348</b>	<b>41.19</b>	<b>-15.49</b>
4	419.89	27.35 QP	37.00	-9.65	4.00 V	305	35.54	-8.19
5	489.88	31.94 QP	37.00	-5.06	1.00 V	232	38.47	-6.53
6	910.78	21.84 QP	37.00	-15.16	3.00 V	348	19.97	1.87

Remarks:

1. Emission Level(dBuV/m) = Raw Value(dBuV) + Correction Factor(dB/m)
2. Correction Factor(dB/m) = Antenna Factor (dB/m) + Cable Factor (dB) – Pre-Amplifier Factor (dB)
3. The other emission levels were very low against the limit.
4. Margin value = Emission level – Limit value

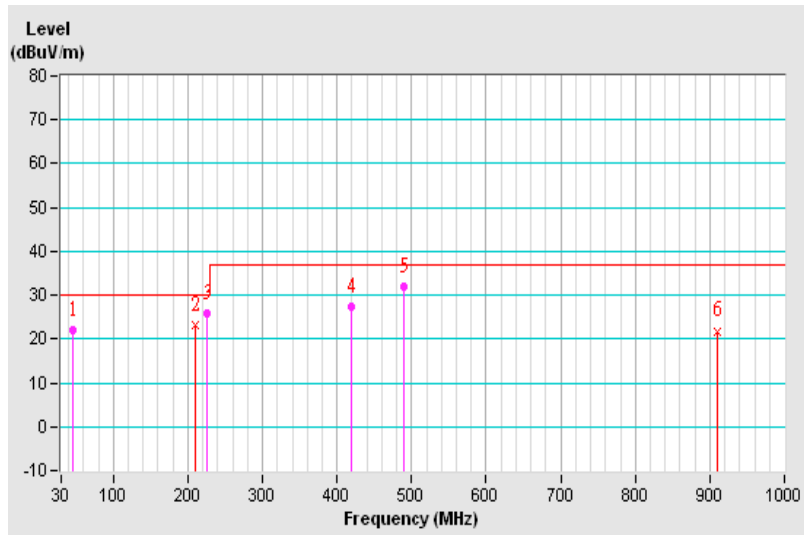

## 6 Radiated Emissions above 1 GHz

### 6.1 Limits

Emissions radiated outside of the specified bands, shall be according to the general radiated limits as following:

Radiated Emissions Limits at 10 meters (dB $\mu$ V/m)				
Frequencies (MHz)	FCC 15B / ICES-003, Class A	FCC 15B / ICES-003, Class B	CISPR 22, Class A	CISPR 22, Class B
1000-3000	Avg: 49.5	Avg: 43.5	Not defined	Not defined
Above 3000	Peak: 69.5	Peak: 63.5	Not defined	Not defined

Radiated Emissions Limits at 3 meters (dB $\mu$ V/m)				
Frequencies (MHz)	FCC 15B / ICES-003, Class A	FCC 15B / ICES-003, Class B	CISPR 22, Class A	CISPR 22, Class B
1000-3000	Avg: 60	Avg: 54	Avg: 56 Peak: 76	Avg: 50 Peak: 70
Above 3000	Peak: 80	Peak: 74	Avg: 60 Peak: 80	Avg: 54 Peak: 74

- Notes:
1. The lower limit shall apply at the transition frequencies.
  2. Emission level (dB $\mu$ V/m) = 20 log Emission level (uV/m).
  3. As shown in 15.35(b), for frequencies above 1000MHz, the field strength limits are based on average detector, however, the peak field strength of any emission shall not exceed the maximum permitted average limits, specified above by more than 20dB under any condition of modulation.

#### Frequency Range (For unintentional radiators)

Highest frequency generated or used in the device or on which the device operates or tunes (MHz)	Upper frequency of measurement range (MHz)
Below 1.705	30
1.705-108	1000
108-500	2000
500-1000	5000
Above 1000	5th harmonic of the highest frequency or 40GHz, whichever is lower

## 6.2 Test Instruments

DESCRIPTION & MANUFACTURER	MODEL NO.	SERIAL NO.	CALIBRATED DATE	CALIBRATED UNTIL
Test Receiver Agilent	N9038A	MY50010125	Apr. 15, 2017	Apr. 14, 2018
Pre-Amplifier Agilent	8449B	3008A01975	Feb. 26, 2017	Feb. 25, 2018
Horn Antenna SCHWARZBECK	BBHA 9120D	D123	Dec. 15, 2016	Dec. 14, 2017
RF Coaxial Cable	EMC104-SM-SM -11000	170209	Mar. 07, 2017	Mar. 06, 2018
RF Coaxial Cable	EMC104-SM-SM -6000	170207	Mar. 07, 2017	Mar. 06, 2018
RF Coaxial Cable	EMC104-SM-SM -2500	170206	Mar. 07, 2017	Mar. 06, 2018
Software BVADT	ADT_Radiated_ V8.7.08	NA	NA	NA
Antenna Tower & Turn Table CT	NA	NA	NA	NA

### Note:

1. The calibration interval of the above test instruments are 12 months and the calibrations are traceable to NML/ROC and NIST/USA.
2. The test was performed in 10m Chamber No. F.
3. The VCCI Site Registration No. is G-136.
4. The 3dB beamwidth of the horn antenna is minimum 30 degree (or  $w = 1.6m$  at 3m distance) for 1~6 GHz.
5. Tested Date: Sep. 29, 2017



### 6.3 Test Arrangement

- The EUT was placed on the top of a rotating table 0.8 meters above the ground at an accredited chamber room. The table was rotated 360 degrees to determine the position of the highest radiation.
- The EUT was set 3 meters away from the interference-receiving antenna, which was mounted on the top of a variable-height antenna tower.
- The height of antenna can be varied from one meter to four meters, the height of adjustment depends on the EUT height and the antenna 3dB beamwidth both, to detect the maximum value of the field strength. Both horizontal and vertical polarizations of the antenna are set to make the measurement.
- For each suspected emission, the EUT was arranged to its worst case and then the antenna was tuned to heights and the rotatable table was turned from 0 degrees to 360 degrees to find the maximum reading.
- The spectrum analyzer system was set to peak and average detect function and specified bandwidth with maximum hold mode when the test frequency is above 1 GHz.

Note: The resolution bandwidth of test receiver/spectrum analyzer is 1MHz and video bandwidth is 3MHz for Peak detection (PK) at frequency above 1GHz. The resolution bandwidth of test receiver/spectrum analyzer is 1 MHz for Average detection (AV) at frequency above 1GHz.

#### < Frequency Range above 1GHz >

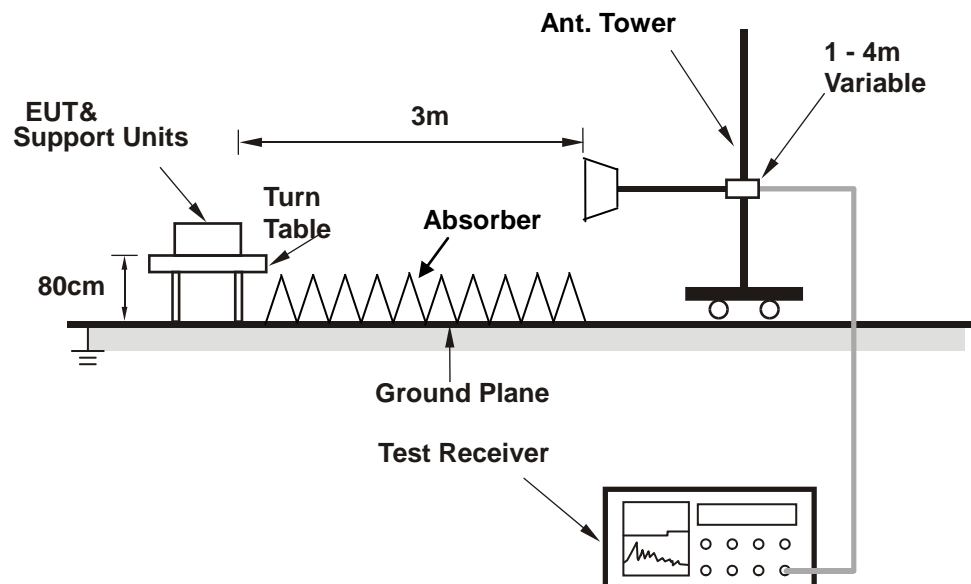

The test arrangement is in accordance with ANSI 63.4:2014. For the actual test configuration, please refer to the related item – Photographs of the Test Configuration.

### 6.4 Supplementary Information

There is not any deviation from the test standards for the test method.

## 6.5 Test Results

Frequency Range	1GHz~6GHz	Detector Function & Resolution Bandwidth	Peak (PK) / Average (AV), 1MHz
Input Power	DC 1.5V from battery	Environmental Conditions	24°C, 70%RH
Tested by	David Chuang		
Test Mode	Mode 1		

Antenna Polarity & Test Distance : Horizontal at 3 m								
No	Frequency (MHz)	Emission Level (dBuV/m)	Limit (dBuV/m)	Margin (dB)	Antenna Height (m)	Table Angle (Degree)	Raw Value (dBuV)	Correction Factor (dB/m)
1	1576.72	36.88 PK	74.00	-37.12	1.00 H	243	40.02	-3.14
2	1576.72	24.27 AV	54.00	-29.73	1.00 H	243	27.41	-3.14
3	1896.75	38.74 PK	74.00	-35.26	1.00 H	65	40.68	-1.94
4	1896.75	25.58 AV	54.00	-28.42	1.00 H	65	27.52	-1.94
5	2069.72	40.85 PK	74.00	-33.15	1.00 H	87	41.72	-0.87
6	2069.72	27.74 AV	54.00	-26.26	1.00 H	87	28.61	-0.87
7	2906.55	40.51 PK	74.00	-33.49	1.00 H	310	38.00	2.51
8	2906.55	27.48 AV	54.00	-26.52	1.00 H	310	24.97	2.51
9	3783.75	41.39 PK	74.00	-32.61	1.00 H	50	36.80	4.59
10	3783.75	28.66 AV	54.00	-25.34	1.00 H	50	24.07	4.59
11	4560.65	42.51 PK	74.00	-31.49	1.00 H	208	35.81	6.70
12	4560.65	30.36 AV	54.00	-23.64	1.00 H	208	23.66	6.70

Remarks:

1. Emission Level(dBuV/m) = Raw Value(dBuV) + Correction Factor(dB/m)
2. Correction Factor(dB/m) = Antenna Factor (dB/m) + Cable Factor (dB) – Pre-Amplifier Factor (dB)
3. The other emission levels were very low against the limit.
4. Margin value = Emission level – Limit value

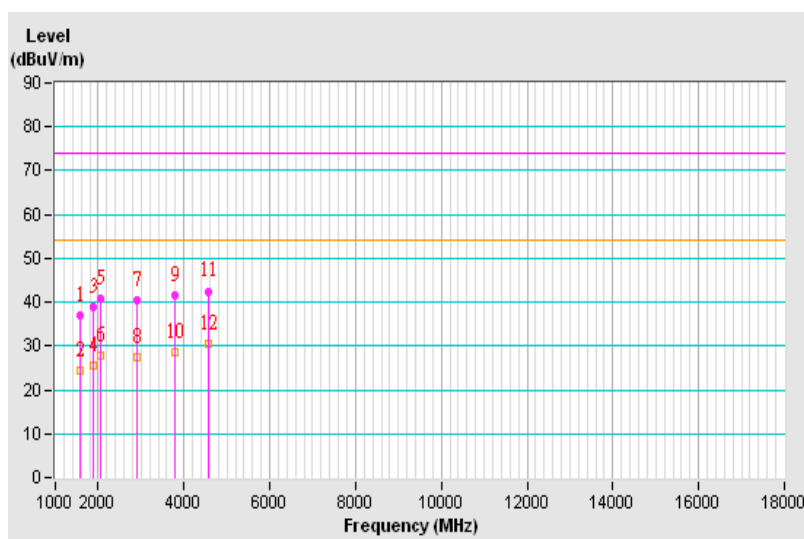

Frequency Range	1GHz~6GHz	Detector Function & Resolution Bandwidth	Peak (PK) / Average (AV), 1MHz
Input Power	DC 1.5V from battery	Environmental Conditions	24°C, 70%RH
Tested by	David Chuang		
Test Mode	Mode 1		

Antenna Polarity & Test Distance : Vertical at 3 m								
No	Frequency (MHz)	Emission Level (dBuV/m)	Limit (dBuV/m)	Margin (dB)	Antenna Height (m)	Table Angle (Degree)	Raw Value (dBuV)	Correction Factor (dB/m)
1	1259.67	41.85 PK	74.00	-32.15	1.00 V	293	46.83	-4.98
2	1259.67	28.07 AV	54.00	-25.93	1.00 V	293	33.05	-4.98
3	1756.50	39.04 PK	74.00	-34.96	1.00 V	5	41.51	-2.47
4	1756.50	26.81 AV	54.00	-27.19	1.00 V	5	29.28	-2.47
5	1995.35	45.47 PK	74.00	-28.53	1.00 V	157	46.78	-1.31
6	1995.35	25.52 AV	54.00	-28.48	1.00 V	157	26.83	-1.31
7	2070.15	43.22 PK	74.00	-30.78	1.00 V	5	44.08	-0.86
8	2070.15	29.51 AV	54.00	-24.49	1.00 V	5	30.37	-0.86
9	3920.18	42.52 PK	74.00	-31.48	1.00 V	152	38.01	4.51
10	3920.18	28.73 AV	54.00	-25.27	1.00 V	152	24.22	4.51
11	5082.98	44.54 PK	74.00	-29.46	1.00 V	152	36.37	8.17
12	<b>5082.98</b>	<b>31.11 AV</b>	<b>54.00</b>	<b>-22.89</b>	<b>1.00 V</b>	<b>152</b>	<b>22.94</b>	<b>8.17</b>

Remarks:

1. Emission Level(dBuV/m) = Raw Value(dBuV) + Correction Factor(dB/m)
2. Correction Factor(dB/m) = Antenna Factor (dB/m) + Cable Factor (dB) – Pre-Amplifier Factor (dB)
3. The other emission levels were very low against the limit.
4. Margin value = Emission level – Limit value

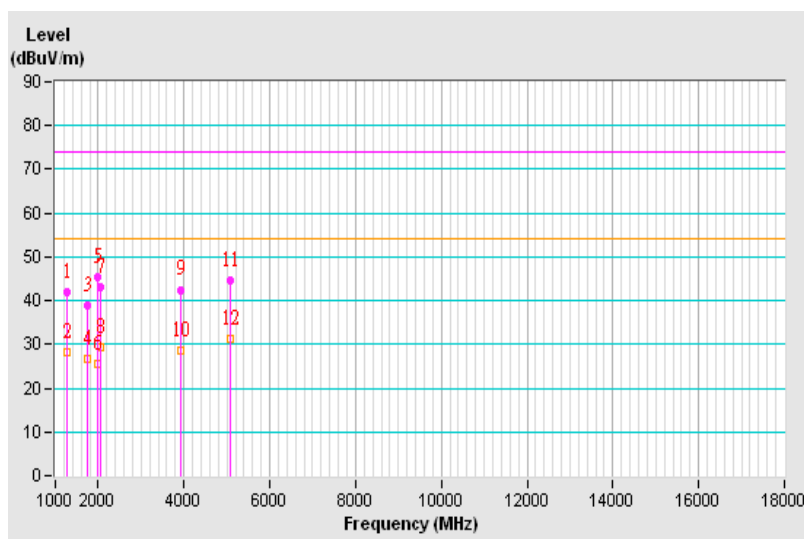

## 7 Pictures of Test Arrangements

Please refer to the attached file (Test Setup Photo).

## Appendix – Information on the Testing Laboratories

We, Bureau Veritas Consumer Products Services (H.K.) Ltd., Taoyuan Branch, were founded in 1988 to provide our best service in EMC, Radio, Telecom and Safety consultation. Our laboratories are accredited and approved according to ISO/IEC 17025.

If you have any comments, please feel free to contact us at the following:

**Linko EMC/RF Lab**

Tel: 886-2-26052180

Fax: 886-2-26051924

**Hsin Chu EMC/RF/Telecom Lab**

Tel: 886-3-6668565

Fax: 886-3-6668323

**Hwa Ya EMC/RF/Safety Lab**

Tel: 886-3-3183232

Fax: 886-3-3270892

**Email:** [service.adt@tw.bureauveritas.com](mailto:service.adt@tw.bureauveritas.com)

**Web Site:** [www.bureauveritas-adt.com](http://www.bureauveritas-adt.com)

The address and road map of all our labs can be found in our web site also.

--- END ---