

TEST REPORT

CERTIFICATE OF CONFORMITY

Standard: 47 CFR FCC Part 15, Subpart C (Section 15.247)

Report No.: RFBDKG-WTW-P21040783C-1

FCC ID: JNZMR0067

Product: Cordless Mouse

Brand: Logitech

Model No.: M-R0067

Received Date: 2023/11/2

Test Date: 2023/11/6 ~ 2023/11/9

Issued Date: 2023/11/24

Applicant: Logitech Far East Ltd.

Address: #2 Creation Rd. 4, Science-Based Ind. Park Hsinchu Taiwan, R.O.C.

Issued By: Bureau Veritas Consumer Products Services (H.K.) Ltd., Taoyuan Branch
Hsin Chu Laboratory

Lab Address: E-2, No.1, Li Hsin 1st Road, Hsinchu Science Park, Hsinchu City 300, Taiwan

Test Location: E-2, No.1, Li Hsin 1st Road, Hsinchu Science Park, Hsinchu City 300, Taiwan

FCC Registration / 723255 / TW2022

Designation Number:

Approved by: _____



May Chen / Manager

, Date: _____

2023/11/24

This test report consists of 31 pages in total. It may be duplicated completely for legal use with the approval of the applicant. It should not be reproduced except in full, without the written approval of our laboratory. The test results in the report only apply to the tested sample. The test results in this report are traceable to the national or international standards.



Prepared by : Vito Lung / Specialist

This report is governed by, and incorporates by reference, the Conditions of Testing as posted at the date of issuance of this report at <http://www.bureauveritas.com/home/about-us/our-business/cps/about-us/terms-conditions/> and is intended for your exclusive use. Any copying or replication of this report to or for any other person or entity, or use of our name or trademark, is permitted only with our prior written permission. This report sets forth our findings solely with respect to the test samples identified herein. The results set forth in this report are not indicative or representative of the quality or characteristics of the lot from which a test sample was taken or any similar or identical product unless specifically and expressly noted. Our report includes all of the tests requested by you and the results thereof based upon the information that you provided to us. Measurement uncertainty is only provided upon request for accredited tests. Statements of conformity are based on simple acceptance criteria without taking measurement uncertainty into account, unless otherwise requested in writing. You have 60 days from date of issuance of this report to notify us of any material error or omission caused by our negligence or if you require measurement uncertainty; provided, however, that such notice shall be in writing and shall specifically address the issue you wish to raise. A failure to raise such issue within the prescribed time shall constitute your unqualified acceptance of the completeness of this report, the tests conducted and the correctness of the report contents.

Table of Contents

Release Control Record	3
1 Certificate.....	4
2 Summary of Test Results	5
2.1 Measurement Uncertainty	5
2.2 Supplementary Information	5
3 General Information	6
3.1 General Description	6
3.2 Antenna Description of EUT	7
3.3 Channel List.....	8
3.4 Test Mode Applicability and Tested Channel Detail.....	9
3.5 Duty Cycle of Test Signal.....	10
3.6 Test Program Used and Operation Descriptions	11
3.7 Connection Diagram of EUT and Peripheral Devices	11
3.8 Configuration of Peripheral Devices and Cable Connections	11
4 Test Instruments	12
4.1 RF Output Power	12
4.2 Unwanted Emissions below 1 GHz	12
4.3 Unwanted Emissions above 1 GHz.....	13
5 Limits of Test Items.....	14
5.1 RF Output Power	14
5.2 Unwanted Emissions below 1 GHz	14
5.3 Unwanted Emissions above 1 GHz.....	14
6 Test Arrangements.....	15
6.1 RF Output Power	15
6.1.1 Test Setup	15
6.1.2 Test Procedure.....	15
6.2 Unwanted Emissions below 1 GHz	16
6.2.1 Test Setup	16
6.2.2 Test Procedure.....	17
6.3 Unwanted Emissions above 1 GHz.....	18
6.3.1 Test Setup	18
6.3.2 Test Procedure.....	18
7 Test Results of Test Item	19
7.1 RF Output Power	19
7.2 Unwanted Emissions below 1 GHz	20
7.3 Unwanted Emissions above 1 GHz.....	22
8 Pictures of Test Arrangements	30
9 Information of the Testing Laboratories	31



Release Control Record

Issue No.	Description	Date Issued
RFBDKG-WTW-P21040783C-1	Original release.	2023/11/24

1 Certificate

Product: Cordless Mouse

Brand: Logitech

Test Model: M-R0067

Sample Status: Engineering sample

Applicant: Logitech Far East Ltd.

Test Date: 2023/11/6 ~ 2023/11/9

Standard: 47 CFR FCC Part 15, Subpart C (Section 15.247)

Measurement ANSI C63.10-2013

procedure: KDB 558074 D01 15.247 Meas Guidance v05r02

The above equipment has been tested by **Bureau Veritas Consumer Products Services (H.K.) Ltd., Taoyuan Branch**, and found compliance with the requirement of the above standards. The test record, data evaluation & Equipment Under Test (EUT) configurations represented herein are true and accurate accounts of the measurements of the sample's RF characteristics under the conditions specified in this report.

2 Summary of Test Results

47 CFR FCC Part 15, Subpart C (Section 15.247)			
Standard / Clause	Test Item	Result	Remark
15.247(b)	RF Output Power	Pass	Meet the requirement of limit.
15.247(e)	Power Spectral Density	NA	Refer to Note 1 below
15.247(a)(2)	6 dB Bandwidth	NA	Refer to Note 1 below
15.247(d)	Conducted Out of Band Emissions	NA	Refer to Note 1 below
15.207	AC Power Conducted Emissions	NA	Refer to Note 1 below
15.205 / 15.209 / 15.247(d)	Unwanted Emissions below 1 GHz	Pass	Minimum passing margin is -9.0 dB at 41.28 MHz
15.205 / 15.209 / 15.247(d)	Unwanted Emissions above 1 GHz	Pass	Minimum passing margin is -7.9 dB at 2483.50 MHz
15.203	Antenna Requirement	Pass	No antenna connector is used.

Notes:

1. Only RF Output Power and Unwanted Emissions test items were performed for this addendum. The others testing data refer to original test report.
2. Determining compliance based on the results of the compliance measurement, not taking into account measurement instrumentation uncertainty.

2.1 Measurement Uncertainty

Where relevant, the following measurement uncertainty levels have been estimated for tests performed on the EUT as specified in CISPR 16-4-2:

Measurement	Specification	Expanded Uncertainty (k=2) (±)
RF Output Power	-	1.1 dB
Unwanted Emissions below 1 GHz	9 kHz ~ 30 MHz	3.1 dB
	30 MHz ~ 1 GHz	5.5 dB
Unwanted Emissions above 1 GHz	1 GHz ~ 18 GHz	5.1 dB
	18 GHz ~ 40 GHz	5.3 dB

The other instruments specified are routine verified to remain within the calibrated levels, no measurement uncertainty is required to be calculated.

2.2 Supplementary Information

There is not any deviation from the test standards for the test method, and no modifications required for compliance.

3 General Information

3.1 General Description

Product	Cordless Mouse
Brand	Logitech
Test Model	M-R0067
Status of EUT	Engineering sample
Power Supply Rating	3.7 Vdc from battery or 5 Vdc from USB interface
Modulation Type	GFSK
Modulation Technology	DTS
Transfer Rate	2 Mbps
Operating Frequency	2.405 GHz ~ 2.474 GHz
Number of Channel	12
Output Power	2.382 mW (3.77 dBm)
Accessory	USB cable x 1 (shielded, 0.7m)

Note:

- This report is prepared for FCC class II change. The difference compared with the Report No.: RF161220E09-1 as the following:
 - ◆ Antenna gain change from 0.16 dBi to 3.3 dBi rename antenna type.
 - ◆ Remove metallic paints.
- According to above conditions, only RF Output Power and Unwanted Emissions test items need to be performed. All data for meeting the requirement is verified.
- The EUT may have a lot of colors for marketing requirement.
- The EUT could be supplied with a battery as the following table:

No.	Brand	Model	Specification
1	SYNERGY SCIENTECH CORP or Logitech	AHB572535PJT or 533-000120	Power Rating: 3.7Vdc, 500mAh
2	SPRINGPOWER TECHNOLOGY SHENZHEN CO LTD or Logitech	652535 or 533-000121	Power Rating: 3.7Vdc, 500mAh

- The above EUT information is declared by manufacturer and for more detailed features description, please refer to the manufacturer's specifications or User's Manual.

3.2 Antenna Description of EUT

1. The antenna information is listed as below.

Antenna Gain (dBi)	Frequency Range (GHz)	Antenna Type	Connector Type
3.3	2.4-2.4835	CERAMIC Antenna	None

* Detail antenna specification please refer to antenna datasheet and/or antenna measurement report.

3.3 Channel List

12 channels are provided to this EUT:

Channel	Frequency (MHz)	Channel	Frequency (MHz)
1	2405	7	2441
2	2408	8	2444
3	2414	9	2462
4	2417	10	2465
5	2432	11	2471
6	2435	12	2474

3.4 Test Mode Applicability and Tested Channel Detail

Pre-Scan:	Pre-Scan has been conducted to determine the worst-case mode from all possible combinations between available modulations, data rates and antenna ports (if EUT with antenna diversity architecture).
-----------	---

Following channel(s) was (were) selected for the final test as listed below:

Test Item	Tested Channel	Modulation	Data Rate Parameter
RF Output Power	1, 8, 12	GFSK	2Mb/s
Unwanted Emissions below 1 GHz	8	GFSK	2Mb/s
Unwanted Emissions above 1 GHz	1, 8, 12	GFSK	2Mb/s

Note: In the original report:

The worst condition of power supply: Power from USB interface (AC Adapter Incl. Battery AHB572535PJT or 533-000120)

3.5 Duty Cycle of Test Signal

GFSK: Duty cycle = $0.125 \text{ ms} / 9.952 \text{ ms} \times 100\% = 1.3\%$

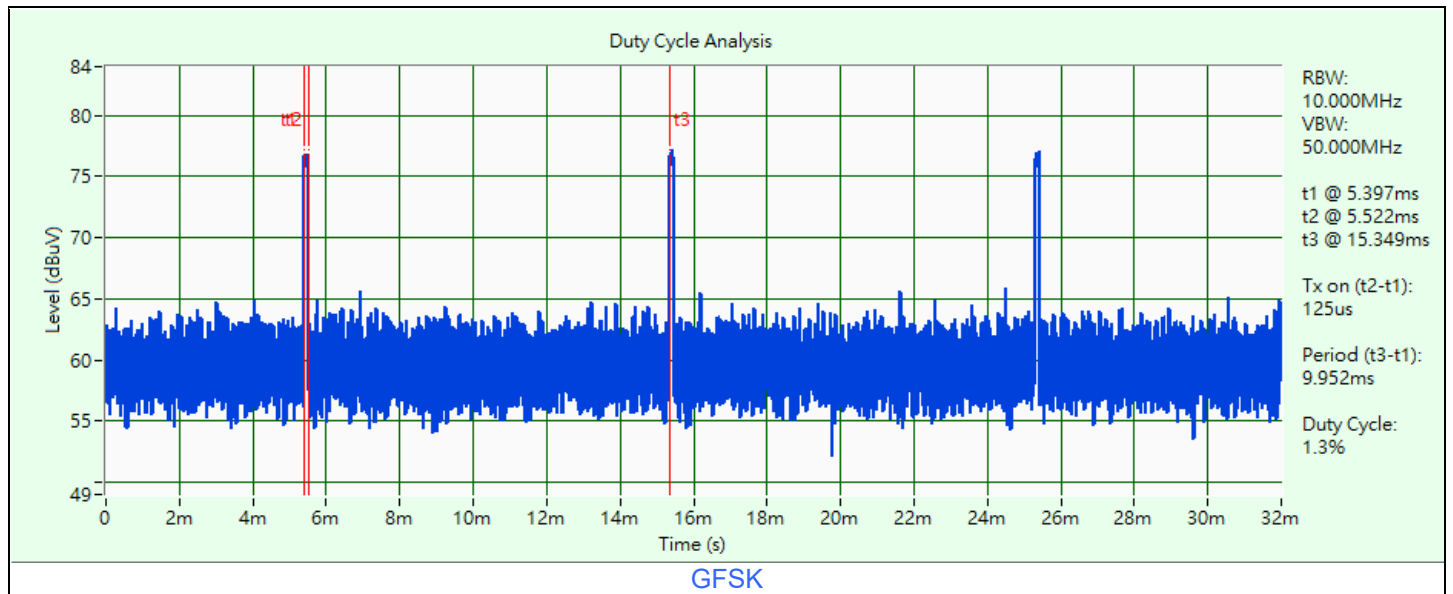

3.6 Test Program Used and Operation Descriptions

Controlling software (RF Sample with Receiver [Number Lock]) has been activated to set the EUT under transmission condition continuously at specific channel frequency.

Test Item	Operation Description
RF Output Power	UFY TX Modulated low duty cycle 2405MHz
Unwanted Emissions below 1 GHz	UFY TX Modulated low duty cycle 2444MHz
Unwanted Emissions above 1 GHz	UFY TX Modulated low duty cycle 2474MHz

3.7 Connection Diagram of EUT and Peripheral Devices

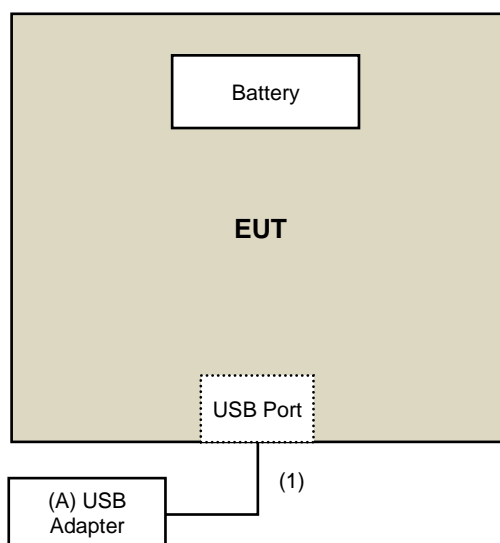

3.8 Configuration of Peripheral Devices and Cable Connections

ID	Product	Brand	Model No.	Serial No.	FCC ID	Remarks
A	USB Adapter	ASUS	EXA1205UA	N/A	N/A	Provided by Lab

ID	Cable Descriptions	Qty.	Length (m)	Shielding (Yes/No)	Cores (Qty.)	Remarks
1	USB Cable	1	0.7	Yes	0	Supplied by applicant

4 Test Instruments

The calibration interval of the all test instruments are 12 months and the calibrations are traceable to NML/ROC and NIST/USA.

4.1 RF Output Power

Description Manufacturer	Model No.	Serial No.	Calibrated Date	Calibrated Until
Power Meter Anritsu	ML2495A	1529002	2023/6/17	2024/6/16
Pulse Power Sensor Anritsu	MA2411B	1726434	2023/6/19	2024/6/18

Notes:

1. The test was performed in Oven room 2.
2. Tested Date: 2023/11/6

4.2 Unwanted Emissions below 1 GHz

Description Manufacturer	Model No.	Serial No.	Calibrated Date	Calibrated Until
Bi_Log Antenna Schwarzbeck	VULB 9168	9168-406	2023/10/13	2024/10/12
Boresight Antenna Tower & Turn Table Max-Full	MF-7802BS	MF780208530	N/A	N/A
Fixed Attenuator Mini-Circuits	UNAT-5+	PAD-ATT5-03	2022/12/28	2023/12/27
Loop Antenna Electro-Metrics	EM-6879	264	2023/2/21	2024/2/20
MXA Signal Analyzer Keysight	N9020B	MY60112408	2023/3/6	2024/3/5
MXE EMI Receiver Keysight	N9038A	MY59050100	2023/6/13	2024/6/12
Preamplifier EMCI	EMC330N	980701	2023/2/18	2024/2/17
	EMC001340	980142	2023/5/8	2024/5/7
RF Coaxial Cable JYEBAO	5D-FB	LOOPCAB-001	2022/12/19	2023/12/18
		LOOPCAB-002	2022/12/19	2023/12/18
RF Coaxial Cable PEWC	8D	966-4-1	2023/2/18	2024/2/17
		966-4-2	2023/2/18	2024/2/17
		966-4-3	2023/2/18	2024/2/17
Software	ADT_Radiated_V8.7.08	N/A	N/A	N/A

Notes:

1. The test was performed in 966 Chamber No. 4.
2. Tested Date: 2023/11/6

4.3 Unwanted Emissions above 1 GHz

Description Manufacturer	Model No.	Serial No.	Calibrated Date	Calibrated Until
Boresight Antenna Tower & Turn Table Max-Full	MF-7802BS	MF780208530	N/A	N/A
Horn Antenna Schwarzbeck	BBHA 9120D	9120D-783	2022/11/13	2023/11/12
	BBHA 9170	9170-739	2022/11/13	2023/11/12
MXA Signal Analyzer Keysight	N9020B	MY60112408	2023/3/6	2024/3/5
Preamplifier EMCI	EMC12630SE	980688	2023/10/3	2024/10/2
	EMC184045SE	980387	2023/8/9	2024/8/8
RF Coaxial Cable EMCI	EMC-KM-KM-4000	200214	2023/2/20	2024/2/19
	EMC102-KM-KM-1200	160924	2023/8/9	2024/8/8
	EMC104-SM-SM-1200	160922	2023/8/9	2024/8/8
	EMC104-SM-SM-2000	180502	2023/3/27	2024/3/26
	EMC104-SM-SM-6000	210704	2023/11/2	2024/11/1
Software	ADT_Radiated_V8.7.08	N/A	N/A	N/A

Notes:

1. The test was performed in 966 Chamber No. 4.
2. Tested Date: 2023/11/7 ~ 2023/11/9

5 Limits of Test Items

5.1 RF Output Power

For systems using digital modulation in the 2400–2483.5 MHz bands: 1 Watt (30 dBm)

5.2 Unwanted Emissions below 1 GHz

Radiated emissions up to 1 GHz which fall in the restricted bands must comply with the radiated emission limits specified as below table. Other emissions shall be at least 20 dB below the highest level of the desired power:

Frequencies (MHz)	Field Strength (microvolts/meter)	Measurement Distance (meters)
0.009 ~ 0.490	2400/F(kHz)	300
0.490 ~ 1.705	24000/F(kHz)	30
1.705 ~ 30.0	30	30
30 ~ 88	100	3
88 ~ 216	150	3
216 ~ 960	200	3
Above 960	500	3

Notes:

1. The lower limit shall apply at the transition frequencies.
2. Emission level (dBuV/m) = 20 log Emission level (uV/m).

5.3 Unwanted Emissions above 1 GHz

Radiated emissions above 1 GHz which fall in the restricted bands must comply with the radiated emission limits specified as below table. Other emissions shall be at least 20 dB below the highest level of the desired power:

Frequencies (MHz)	Field Strength (microvolts/meter)	Measurement Distance (meters)
Above 960	500	3

Notes:

1. The lower limit shall apply at the transition frequencies.
2. Emission level (dBuV/m) = 20 log Emission level (uV/m).
3. For frequencies above 1000 MHz, the field strength limits are based on average detector, however, the peak field strength of any emission shall not exceed the maximum permitted average limits, specified above by more than 20 dB under any condition of modulation.

6 Test Arrangements

6.1 RF Output Power

6.1.1 Test Setup

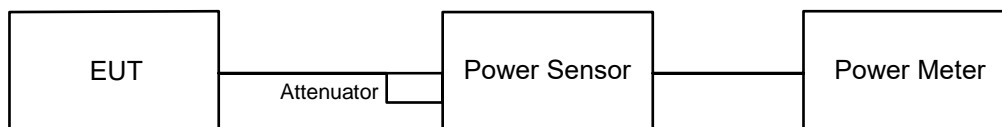

6.1.2 Test Procedure

Peak Power:

A peak power sensor was used on the output port of the EUT. A power meter was used to read the response of the peak power sensor. Record the power level.

Average Power:

Average power sensor was used to perform output power measurement, trigger and gating function of wide band power meter is enabled to measure max output power of TX on burst. Duty factor is not added to measured value.

6.2 Unwanted Emissions below 1 GHz

6.2.1 Test Setup

For Radiated emission below 30 MHz

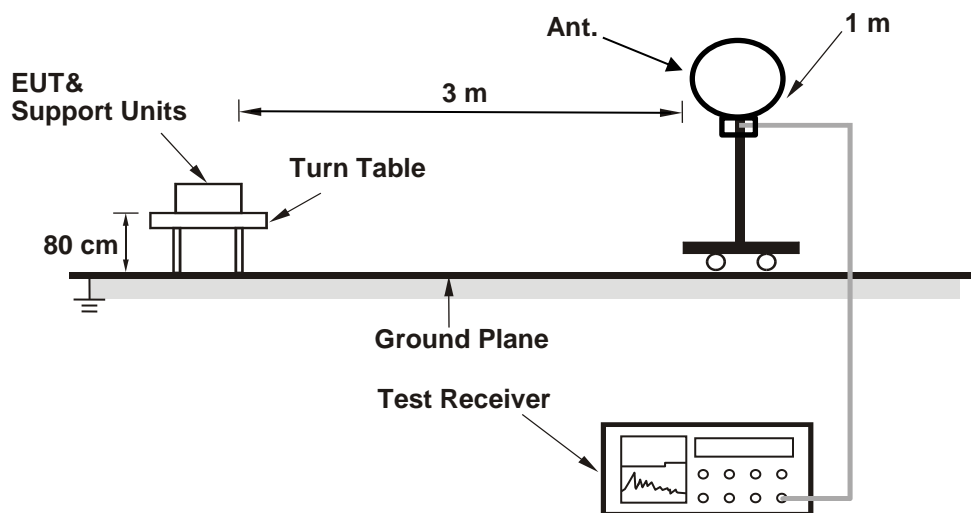

For Radiated emission above 30 MHz

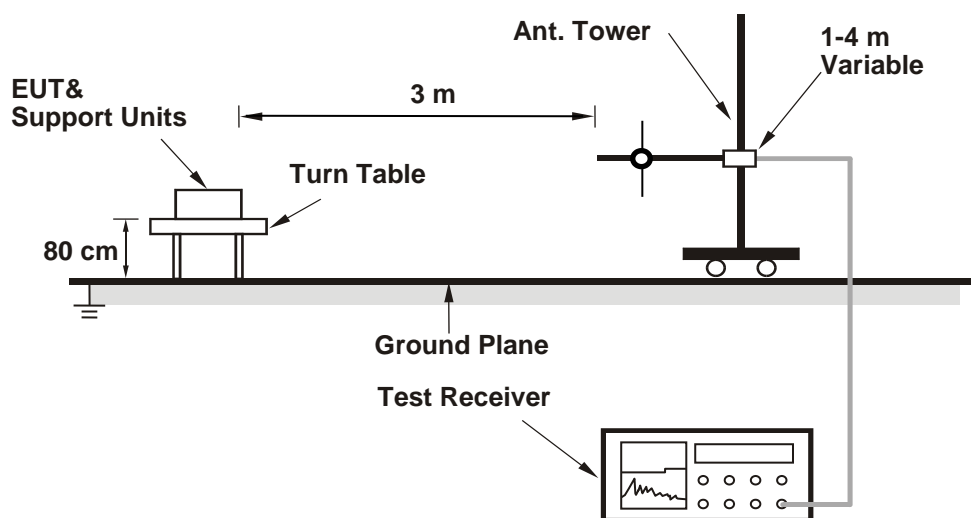

For the actual test configuration, please refer to the attached file (Test Setup Photo).

6.2.2 Test Procedure

For Radiated emission below 30 MHz

- a. The EUT was placed on the top of a rotating table 0.8 meters above the ground at 3 meter chamber room for test. The table was rotated 360 degrees to determine the position of the highest radiation.
- b. The EUT was set 3 meters away from the interference-receiving antenna, which was mounted on the top of a variable-height antenna tower.
- c. Parallel, perpendicular, and ground-parallel orientations of the antenna are set to make the measurement.
- d. For each suspected emission, the EUT was arranged to its worst case and the rotatable table was turned from 0 degrees to 360 degrees to find the maximum reading.
- e. The test-receiver system was set to Quasi-Peak Detect Function and Specified Bandwidth with Maximum Hold Mode, except for the frequency band (9 kHz to 90 kHz and 110 kHz to 490 kHz) set to average detect function and peak detect function.

Notes:

1. The resolution bandwidth and video bandwidth of test receiver/spectrum analyzer is 200 Hz at frequency below 150 kHz.
2. The resolution bandwidth and video bandwidth of test receiver/spectrum analyzer is 9 kHz or 10 kHz at frequency (150 kHz to 30 MHz).
3. All modes of operation were investigated and the worst-case emissions are reported.

For Radiated emission above 30 MHz

- a. The EUT was placed on the top of a rotating table 0.8 meters above the ground at 3 meter chamber room for test. The table was rotated 360 degrees to determine the position of the highest radiation.
- b. The EUT was set 3 meters away from the interference-receiving antenna, which was mounted on the top of a variable-height antenna tower.
- c. The height of antenna is varied from one meter to four meters above the ground to determine the maximum value of the field strength. Both horizontal and vertical polarizations of the antenna are set to make the measurement.
- d. For each suspected emission, the EUT was arranged to its worst case and then the antenna was tuned to heights from 1 meter to 4 meters and the rotatable table was turned from 0 degrees to 360 degrees to find the maximum reading.
- e. The test-receiver system was set to quasi-peak detect function and specified bandwidth with maximum hold mode when the test frequency is below 1 GHz.

Notes:

1. The resolution bandwidth and video bandwidth of test receiver/spectrum analyzer is 120 kHz for Quasi-peak detection (QP) at frequency below 1 GHz.
2. All modes of operation were investigated and the worst-case emissions are reported.

6.3 Unwanted Emissions above 1 GHz

6.3.1 Test Setup

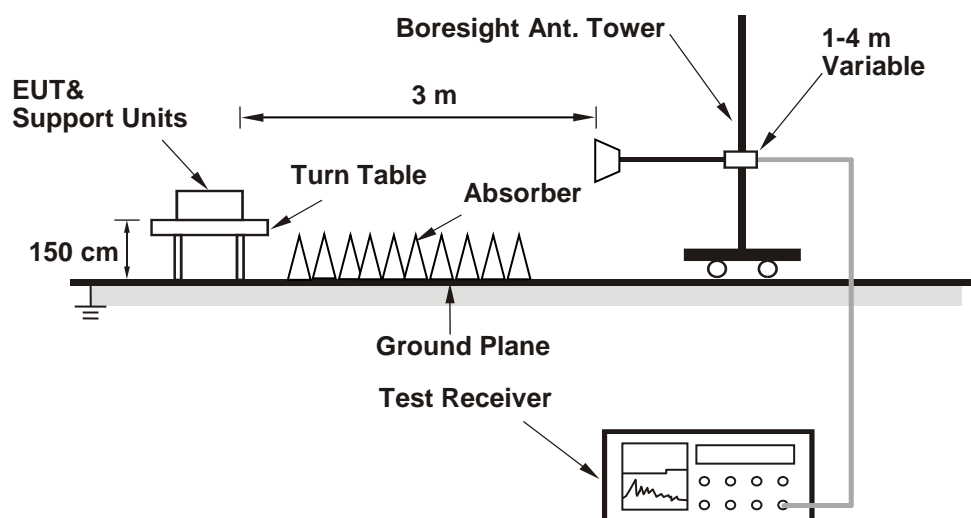

For the actual test configuration, please refer to the attached file (Test Setup Photo).

6.3.2 Test Procedure

- The EUT was placed on the top of a rotating table 1.5 meters above the ground at 3 meter chamber room for test. The table was rotated 360 degrees to determine the position of the highest radiation.
- The EUT was set 3 meters away from the interference-receiving antenna, which was mounted on the top of a variable-height antenna tower.
- The height of antenna is varied from one meter to four meters above the ground to determine the maximum value of the field strength. Both horizontal and vertical polarizations of the antenna are set to make the measurement.
- For each suspected emission, the EUT was arranged to its worst case and then the antenna was tuned to heights from 1 meter to 4 meters and the rotatable table was turned from 0 degrees to 360 degrees to find the maximum reading.
- The test-receiver/spectrum analyzer was set to peak and average detects function and specified bandwidth with maximum hold mode when the test frequency is above 1 GHz. If the peak reading value also meets average limit, measurement with the average detector is unnecessary.

Notes:

- The resolution bandwidth of test receiver/spectrum analyzer is 1 MHz and the video bandwidth is 3 MHz for Peak detection (PK) and Average detection (AV) at frequency above 1 GHz.
- For fundamental and harmonic signal measurement, according to KDB 558074 D01 15.247 Meas Guidance v05r02 section 8.1(c)(3). The spectrum analyzer settings meet the requirements of 11.12.2.4 in ANSI C63.10 for making a Peak measurement, the average value = Peak value + duty cycle correction factor. The duty cycle measurement refers to FCC 47 CFR Part 15C section 15.35 (c). For duty cycle correction factor values, see the Test Signal Duty Cycle section in this report.
- All modes of operation were investigated and the worst-case emissions are reported.

7 Test Results of Test Item

7.1 RF Output Power

Input Power:	3.7 Vdc	Environmental Conditions:	25°C, 60% RH	Tested By:	Louis Yang
--------------	---------	---------------------------	--------------	------------	------------

For Peak Power

Chan.	Chan. Freq. (MHz)	Peak Power (mW)	Peak Power (dBm)	Power Limit (dBm)	Test Result
1	2405	2.286	3.59	30	Pass
8	2444	2.382	3.77	30	Pass
12	2474	2.301	3.62	30	Pass

Note: The antenna gain is 3.3 dBi < 6 dBi, so the output power limit shall not be reduced.

For Average Power

Chan.	Chan. Freq. (MHz)	Average Power (mW)	Average Power (dBm)
1	2405	2.28	3.58
8	2444	2.371	3.75
12	2474	2.259	3.54

7.2 Unwanted Emissions below 1 GHz

RF Mode	GFSK	Channel	CH 8 : 2444 MHz
Frequency Range	30 MHz ~ 1 GHz	Detector Function & Bandwidth	QP: RB=120kHz, DET=Quasi-Peak
Input Power (System)	120 Vac, 60 Hz	Environmental Conditions	23°C, 63% RH
Tested By	Sampson Chen		

Antenna Polarity & Test Distance : Horizontal at 3 m

No	Frequency (MHz)	Emission Level (dBuV/m)	Limit (dBuV/m)	Margin (dB)	Antenna Height (m)	Table Angle (Degree)	Raw Value (dBuV)	Correction Factor (dB/m)
1	38.73	20.6 QP	40.0	-19.4	1.00 H	316	34.0	-13.4
2	106.36	20.1 QP	43.5	-23.4	3.00 H	240	36.5	-16.4
3	145.82	20.2 QP	43.5	-23.3	2.00 H	276	33.3	-13.1
4	228.10	21.0 QP	46.0	-25.0	1.00 H	64	37.2	-16.2
5	421.54	22.8 QP	46.0	-23.2	1.00 H	291	32.2	-9.4
6	609.43	26.8 QP	46.0	-19.2	2.00 H	210	31.8	-5.0

Remarks:

1. Emission Level(dBuV/m) = Raw Value(dBuV) + Correction Factor(dB/m)
2. Correction Factor(dB/m) = Antenna Factor(dB/m) + Cable Factor(dB) – Pre-Amplifier Factor(dB)
3. Margin value = Emission Level – Limit value
4. The other emission levels were very low against the limit of frequency range 30 MHz ~ 1 GHz.
5. The frequency range 9 kHz ~ 30 MHz: all emissions are more than 20 dB below the limit, therefore do not be recorded in this report.

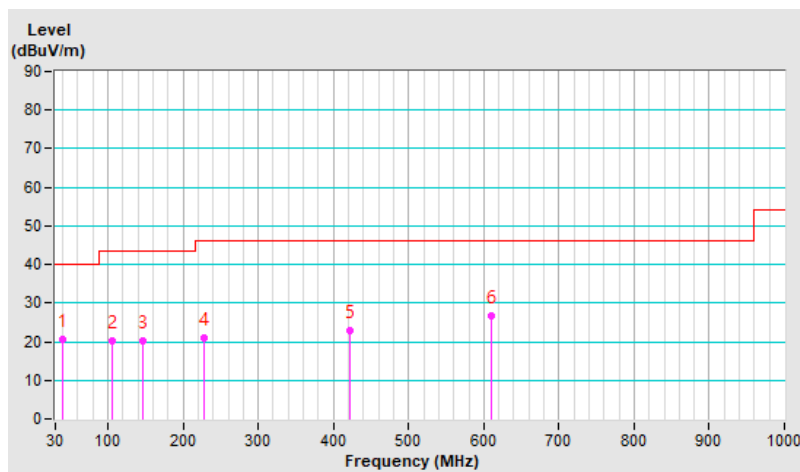

RF Mode	GFSK	Channel	CH 8 : 2444 MHz
Frequency Range	30 MHz ~ 1 GHz	Detector Function & Bandwidth	QP: RB=120kHz, DET=Quasi-Peak
Input Power (System)	120 Vac, 60 Hz	Environmental Conditions	23°C, 63% RH
Tested By	Sampson Chen		

Antenna Polarity & Test Distance : Vertical at 3 m								
No	Frequency (MHz)	Emission Level (dBuV/m)	Limit (dBuV/m)	Margin (dB)	Antenna Height (m)	Table Angle (Degree)	Raw Value (dBuV)	Correction Factor (dB/m)
1	41.28	31.0 QP	40.0	-9.0	1.00 V	324	44.3	-13.3
2	98.22	24.9 QP	43.5	-18.6	1.00 V	285	42.7	-17.8
3	164.10	18.5 QP	43.5	-25.0	2.00 V	20	31.7	-13.2
4	428.82	24.2 QP	46.0	-21.8	1.50 V	288	33.2	-9.0
5	576.21	24.9 QP	46.0	-21.1	2.00 V	246	31.2	-6.3
6	710.92	28.3 QP	46.0	-17.7	3.00 V	360	32.2	-3.9

Remarks:

1. Emission Level(dBuV/m) = Raw Value(dBuV) + Correction Factor(dB/m)
2. Correction Factor(dB/m) = Antenna Factor(dB/m) + Cable Factor(dB) – Pre-Amplifier Factor(dB)
3. Margin value = Emission Level – Limit value
4. The other emission levels were very low against the limit of frequency range 30 MHz ~ 1 GHz.
5. The frequency range 9 kHz ~ 30 MHz: all emissions are more than 20 dB below the limit, therefore do not be recorded in this report.

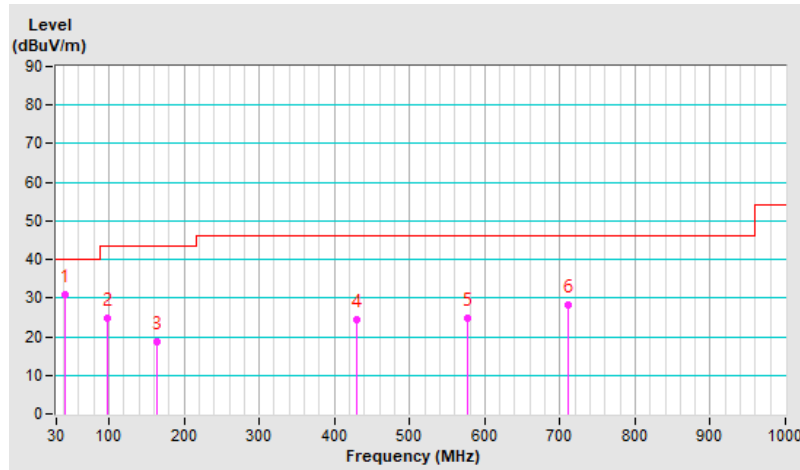

7.3 Unwanted Emissions above 1 GHz

RF Mode	GFSK	Channel	CH 1 : 2405 MHz
Frequency Range	1 GHz ~ 25 GHz	Detector Function & Bandwidth	PK: RB=1 MHz, VB=3 MHz, DET=Peak AV: RB=1 MHz, VB=3 MHz, DET=RMS
Input Power (System)	120 Vac, 60 Hz	Environmental Conditions	22°C, 71% RH
Tested By	Louis Yang		

Antenna Polarity & Test Distance : Horizontal at 3 m								
No	Frequency (MHz)	Emission Level (dBuV/m)	Limit (dBuV/m)	Margin (dB)	Antenna Height (m)	Table Angle (Degree)	Raw Value (dBuV)	Correction Factor (dB/m)
1	2390.00	59.8 PK	74.0	-14.2	1.18 H	206	60.2	-0.4
2	2390.00	44.9 AV	54.0	-9.1	1.18 H	206	45.3	-0.4
3	*2405.00	100.7 PK			1.18 H	206	101.1	-0.4
4	*2405.00	62.7 AV			1.18 H	206	63.1	-0.4
5	4810.00	49.1 PK	74.0	-24.9	1.70 H	260	44.7	4.4
6	4810.00	11.1 AV	54.0	-42.9	1.70 H	260	6.7	4.4

Remarks:

- Emission Level(dBuV/m) = Raw Value(dBuV) + Correction Factor(dB/m)
- Correction Factor(dB/m) = Antenna Factor(dB/m) + Cable Factor(dB) – Pre-Amplifier Factor(dB)
- Margin value = Emission Level – Limit value
- The other emission levels were very low against the limit.
- " * " : Fundamental frequency, the limit was restricted at the RF Output Power.
- The average value of fundamental and harmonic frequency is: Average = Peak value + 20 log(Duty cycle) Where the duty cycle correction factor is calculated from following formula:

$$20 \log(\text{Duty cycle}) = 20 \log(0.125 \text{ ms} / 9.952 \text{ ms}) = -38.0 \text{ dB}$$

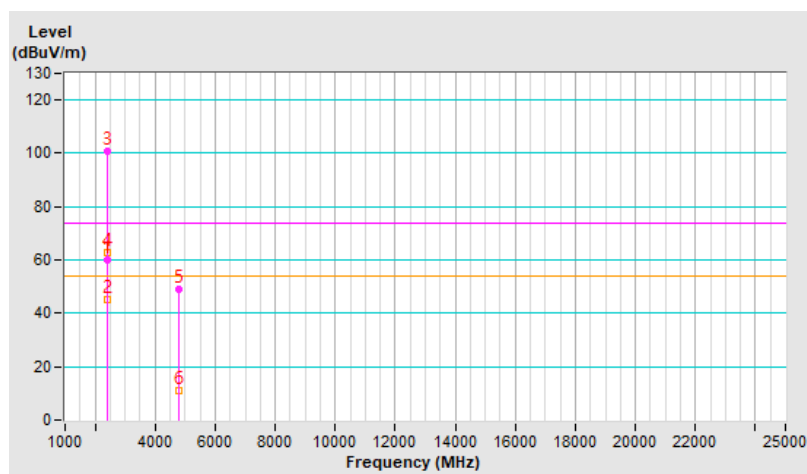

RF Mode	GFSK	Channel	CH 1 : 2405 MHz
Frequency Range	1 GHz ~ 25 GHz	Detector Function & Bandwidth	PK: RB=1 MHz, VB=3 MHz, DET=Peak AV: RB=1 MHz, VB=3 MHz, DET=RMS
Input Power (System)	120 Vac, 60 Hz	Environmental Conditions	22°C, 71% RH
Tested By	Louis Yang		

Antenna Polarity & Test Distance : Vertical at 3 m								
No	Frequency (MHz)	Emission Level (dBuV/m)	Limit (dBuV/m)	Margin (dB)	Antenna Height (m)	Table Angle (Degree)	Raw Value (dBuV)	Correction Factor (dB/m)
1	2390.00	55.1 PK	74.0	-18.9	1.21 V	36	55.5	-0.4
2	2390.00	45.1 AV	54.0	-8.9	1.21 V	36	45.5	-0.4
3	*2405.00	88.3 PK			1.21 V	36	88.7	-0.4
4	*2405.00	50.3 AV			1.21 V	36	50.7	-0.4
5	4810.00	44.5 PK	74.0	-29.5	1.06 V	144	40.1	4.4
6	4810.00	6.5 AV	54.0	-47.5	1.06 V	144	2.1	4.4

Remarks:

1. Emission Level(dBuV/m) = Raw Value(dBuV) + Correction Factor(dB/m)
2. Correction Factor(dB/m) = Antenna Factor(dB/m) + Cable Factor(dB) – Pre-Amplifier Factor(dB)
3. Margin value = Emission Level – Limit value
4. The other emission levels were very low against the limit.
5. " * " : Fundamental frequency, the limit was restricted at the RF Output Power.
6. The average value of fundamental and harmonic frequency is: Average = Peak value + 20 log(Duty cycle) Where the duty cycle correction factor is calculated from following formula:
 $20 \log(\text{Duty cycle}) = 20 \log(0.125 \text{ ms} / 9.952 \text{ ms}) = -38.0 \text{ dB}$

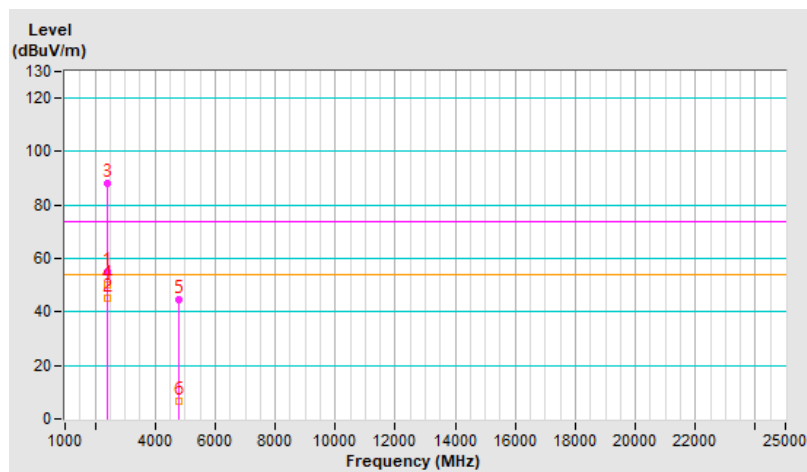

RF Mode	GFSK	Channel	CH 8 : 2444 MHz
Frequency Range	1 GHz ~ 25 GHz	Detector Function & Bandwidth	PK: RB=1 MHz, VB=3 MHz, DET=Peak AV: RB=1 MHz, VB=3 MHz, DET=RMS
Input Power (System)	120 Vac, 60 Hz	Environmental Conditions	22°C, 71% RH
Tested By	Louis Yang		

Antenna Polarity & Test Distance : Horizontal at 3 m								
No	Frequency (MHz)	Emission Level (dBuV/m)	Limit (dBuV/m)	Margin (dB)	Antenna Height (m)	Table Angle (Degree)	Raw Value (dBuV)	Correction Factor (dB/m)
1	*2444.00	101.7 PK			2.09 H	212	102.0	-0.3
2	*2444.00	63.7 AV			2.09 H	212	64.0	-0.3
3	4888.00	47.6 PK	74.0	-26.4	1.40 H	148	43.1	4.5
4	4888.00	9.6 AV	54.0	-44.4	1.40 H	148	5.1	4.5
5	7332.00	45.2 PK	74.0	-28.8	1.51 H	146	33.6	11.6
6	7332.00	7.2 AV	54.0	-46.8	1.51 H	146	-4.4	11.6

Remarks:

1. Emission Level(dBuV/m) = Raw Value(dBuV) + Correction Factor(dB/m)
2. Correction Factor(dB/m) = Antenna Factor(dB/m) + Cable Factor(dB) – Pre-Amplifier Factor(dB)
3. Margin value = Emission Level – Limit value
4. The other emission levels were very low against the limit.
5. " * " : Fundamental frequency, the limit was restricted at the RF Output Power.
6. The average value of fundamental and harmonic frequency is: Average = Peak value + 20 log(Duty cycle) Where the duty cycle correction factor is calculated from following formula:
 $20 \log(\text{Duty cycle}) = 20 \log(0.125 \text{ ms} / 9.952 \text{ ms}) = -38.0 \text{ dB}$

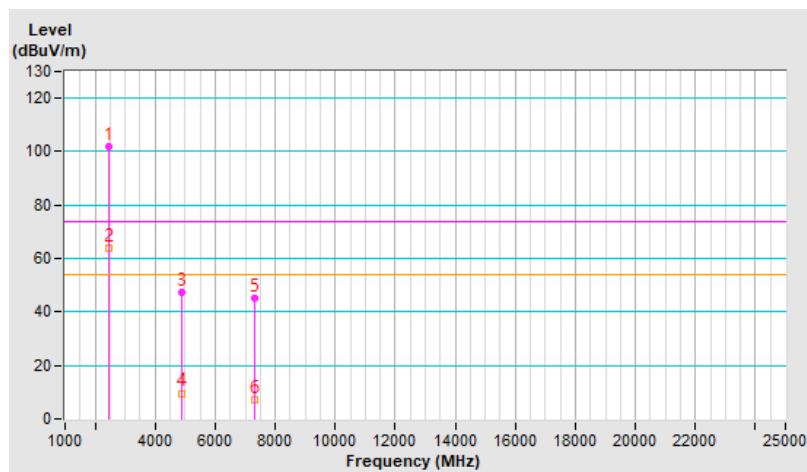

RF Mode	GFSK	Channel	CH 8 : 2444 MHz
Frequency Range	1 GHz ~ 25 GHz	Detector Function & Bandwidth	PK: RB=1 MHz, VB=3 MHz, DET=Peak AV: RB=1 MHz, VB=3 MHz, DET=RMS
Input Power (System)	120 Vac, 60 Hz	Environmental Conditions	22°C, 71% RH
Tested By	Louis Yang		

Antenna Polarity & Test Distance : Vertical at 3 m								
No	Frequency (MHz)	Emission Level (dBuV/m)	Limit (dBuV/m)	Margin (dB)	Antenna Height (m)	Table Angle (Degree)	Raw Value (dBuV)	Correction Factor (dB/m)
1	*2444.00	89.3 PK			1.54 V	32	89.6	-0.3
2	*2444.00	51.3 AV			1.54 V	32	51.6	-0.3
3	4888.00	43.5 PK	74.0	-30.5	1.00 V	346	39.0	4.5
4	4888.00	5.5 AV	54.0	-48.5	1.00 V	346	1.0	4.5
5	7332.00	44.8 PK	74.0	-29.2	3.16 V	343	33.2	11.6
6	7332.00	6.8 AV	54.0	-47.2	3.16 V	343	-4.8	11.6

Remarks:

1. Emission Level(dBuV/m) = Raw Value(dBuV) + Correction Factor(dB/m)
2. Correction Factor(dB/m) = Antenna Factor(dB/m) + Cable Factor(dB) – Pre-Amplifier Factor(dB)
3. Margin value = Emission Level – Limit value
4. The other emission levels were very low against the limit.
5. " * " : Fundamental frequency, the limit was restricted at the RF Output Power.
6. The average value of fundamental and harmonic frequency is: Average = Peak value + 20 log(Duty cycle) Where the duty cycle correction factor is calculated from following formula:
 $20 \log(\text{Duty cycle}) = 20 \log(0.125 \text{ ms} / 9.952 \text{ ms}) = -38.0 \text{ dB}$

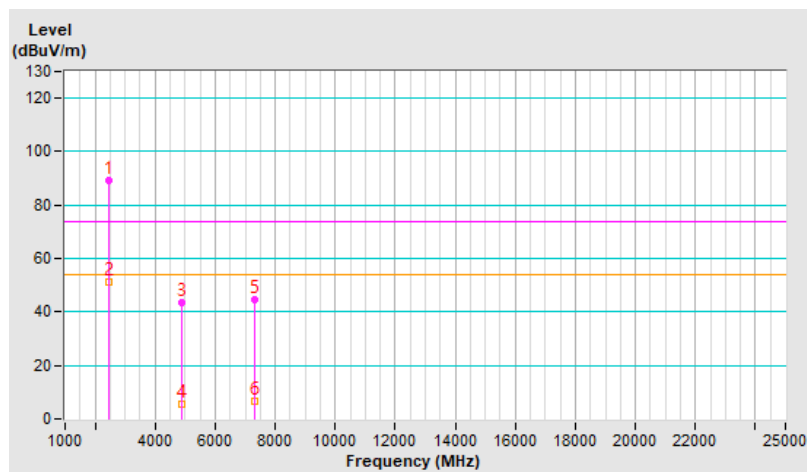

RF Mode	GFSK	Channel	CH 12 : 2474 MHz
Frequency Range	1 GHz ~ 25 GHz	Detector Function & Bandwidth	PK: RB=1 MHz, VB=3 MHz, DET=Peak AV: RB=1 MHz, VB=3 MHz, DET=RMS
Input Power (System)	120 Vac, 60 Hz	Environmental Conditions	22°C, 71% RH
Tested By	Louis Yang		

Antenna Polarity & Test Distance : Horizontal at 3 m								
No	Frequency (MHz)	Emission Level (dBuV/m)	Limit (dBuV/m)	Margin (dB)	Antenna Height (m)	Table Angle (Degree)	Raw Value (dBuV)	Correction Factor (dB/m)
1	*2474.00	101.5 PK			1.13 H	206	101.9	-0.4
2	*2474.00	63.5 AV			1.13 H	206	63.9	-0.4
3	2483.50	66.1 PK	74.0	-7.9	1.13 H	206	66.5	-0.4
4	2483.50	46.0 AV	54.0	-8.0	1.13 H	206	46.4	-0.4
5	4948.00	45.4 PK	74.0	-28.6	1.37 H	150	40.7	4.7
6	4948.00	7.4 AV	54.0	-46.6	1.37 H	150	2.7	4.7
7	7422.00	47.5 PK	74.0	-26.5	2.35 H	348	35.7	11.8
8	7422.00	9.5 AV	54.0	-44.5	2.35 H	348	-2.3	11.8

Remarks:

1. Emission Level(dBuV/m) = Raw Value(dBuV) + Correction Factor(dB/m)
2. Correction Factor(dB/m) = Antenna Factor(dB/m) + Cable Factor(dB) – Pre-Amplifier Factor(dB)
3. Margin value = Emission Level – Limit value
4. The other emission levels were very low against the limit.
5. " * ": Fundamental frequency, the limit was restricted at the RF Output Power.
6. The average value of fundamental and harmonic frequency is: Average = Peak value + 20 log(Duty cycle) Where the duty cycle correction factor is calculated from following formula:
 $20 \log(\text{Duty cycle}) = 20 \log(0.125 \text{ ms} / 9.952 \text{ ms}) = -38.0 \text{ dB}$

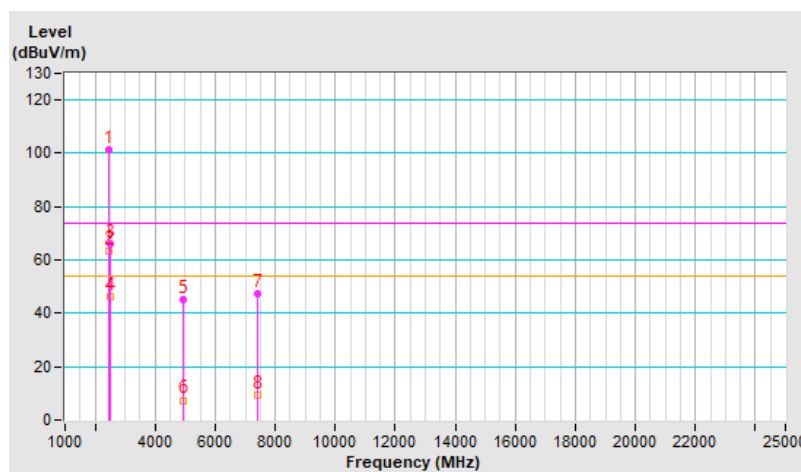

RF Mode	GFSK	Channel	CH 12 : 2474 MHz
Frequency Range	1 GHz ~ 25 GHz	Detector Function & Bandwidth	PK: RB=1 MHz, VB=3 MHz, DET=Peak AV: RB=1 MHz, VB=3 MHz, DET=RMS
Input Power (System)	120 Vac, 60 Hz	Environmental Conditions	22°C, 71% RH
Tested By	Louis Yang		

Antenna Polarity & Test Distance : Vertical at 3 m								
No	Frequency (MHz)	Emission Level (dBuV/m)	Limit (dBuV/m)	Margin (dB)	Antenna Height (m)	Table Angle (Degree)	Raw Value (dBuV)	Correction Factor (dB/m)
1	*2474.00	89.1 PK			1.83 V	25	89.5	-0.4
2	*2474.00	51.1 AV			1.83 V	25	51.5	-0.4
3	2483.50	55.4 PK	74.0	-18.6	1.83 V	25	55.8	-0.4
4	2483.50	45.2 AV	54.0	-8.8	1.83 V	25	45.6	-0.4
5	4948.00	42.6 PK	74.0	-31.4	1.02 V	329	37.9	4.7
6	4948.00	4.6 AV	54.0	-49.4	1.02 V	329	-0.1	4.7
7	7422.00	46.2 PK	74.0	-27.8	1.06 V	325	34.4	11.8
8	7422.00	8.2 AV	54.0	-45.8	1.06 V	325	-3.6	11.8

Remarks:

1. Emission Level(dBuV/m) = Raw Value(dBuV) + Correction Factor(dB/m)
2. Correction Factor(dB/m) = Antenna Factor(dB/m) + Cable Factor(dB) – Pre-Amplifier Factor(dB)
3. Margin value = Emission Level – Limit value
4. The other emission levels were very low against the limit.
5. " * ": Fundamental frequency, the limit was restricted at the RF Output Power.
6. The average value of fundamental and harmonic frequency is: Average = Peak value + 20 log(Duty cycle) Where the duty cycle correction factor is calculated from following formula:
 $20 \log(\text{Duty cycle}) = 20 \log(0.125 \text{ ms} / 9.952 \text{ ms}) = -38.0 \text{ dB}$

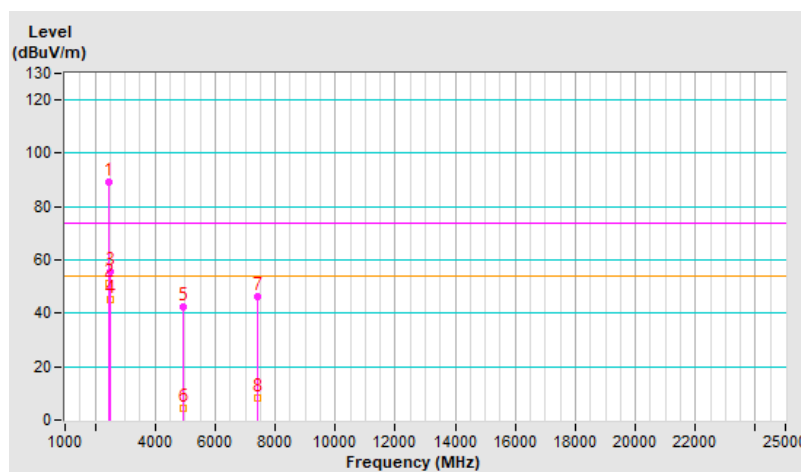

Plot of Band Edge

Frequency Range	2.31 GHz ~ 2.5 GHz	Detector Function & Bandwidth	PK: RB=1 MHz, VB=3 MHz, DET=Peak AV: RB=1 MHz, VB=3 MHz, DET=RMS
-----------------	--------------------	-------------------------------	---

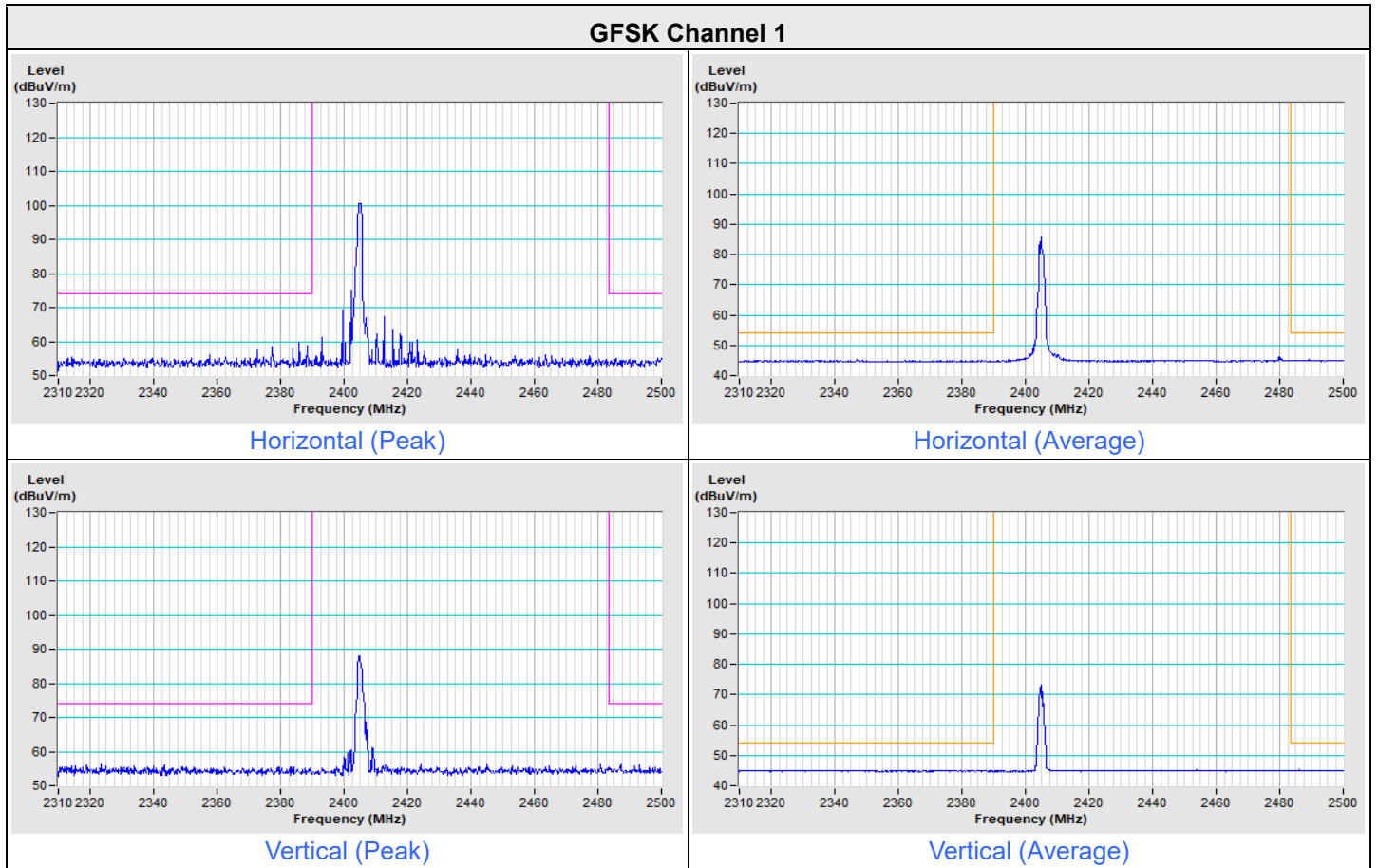

GFSK Channel 12

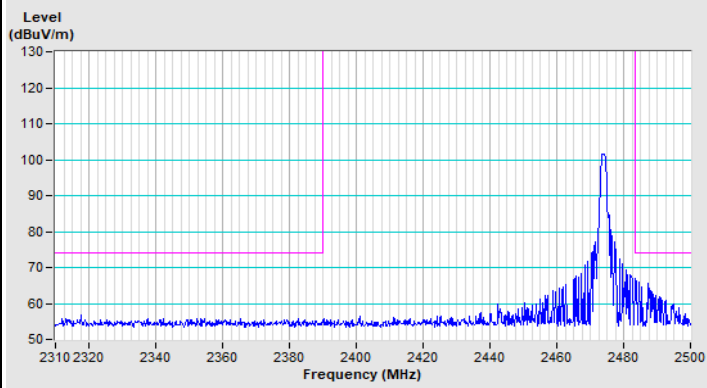

Horizontal (Peak)

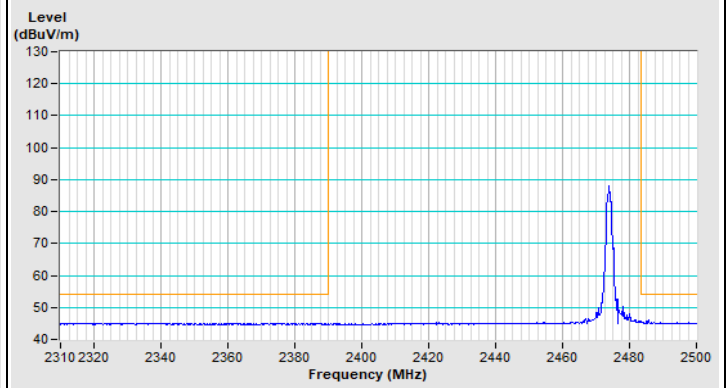

Horizontal (Average)

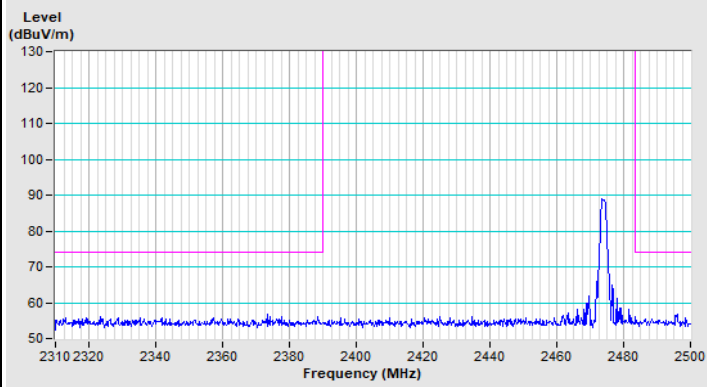

Vertical (Peak)

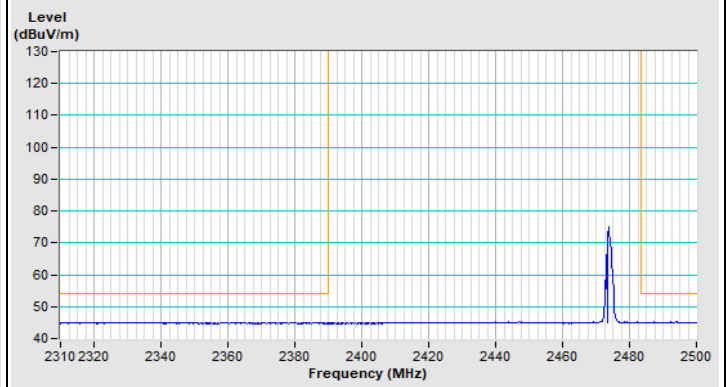

Vertical (Average)

8 Pictures of Test Arrangements

Please refer to the attached file (Test Setup Photo)

9 Information of the Testing Laboratories

We, Bureau Veritas Consumer Products Services (H.K.) Ltd., Taoyuan Branch, were founded in 1988 to provide our best service in EMC, Radio, Telecom and Safety consultation. Our laboratories are FCC recognized accredited test firms and accredited according to ISO/IEC 17025.

If you have any comments, please feel free to contact us at the following:

Lin Kou EMC/RF Lab

Tel: 886-2-26052180

Fax: 886-2-26051924

Hsin Chu EMC/RF/Telecom Lab

Tel: 886-3-6668565

Fax: 886-3-6668323

Hwa Ya EMC/RF/Safety Lab

Tel: 886-3-3183232

Fax: 886-3-3270892

Email: service.adt@bureauveritas.com

Web Site: <http://ee.bureauveritas.com.tw>

The address and road map of all our labs can be found in our web site also.

--- END ---