



A D T

FCC TEST REPORT

REPORT NO.: RF980312H09

MODEL NO.: C-X50001

RECEIVED: Mar. 12, 2009

TESTED: Mar. 18 to 27, 2009

ISSUED: Mar. 30, 2009

APPLICANT: LOGITECH FAR EAST LTD.

ADDRESS: #2 Creation Rd. 4, Science-Based Ind. Park
Hsinchu Taiwan, R.O.C.

ISSUED BY: Bureau Veritas Consumer Products Services
(H.K.) Ltd., Taoyuan Branch

TEST LOCATION: No. 81-1, Lu Liao Keng, 9th Ling, Wu Lung Tsuen,
Chiung Lin Hsiang, Hsin Chu Hsien 307, Taiwan

This test report consists of 23 pages in total. It may be duplicated completely for legal use with the approval of the applicant. It should not be reproduced, except in full, without the written approval of our laboratory. The client should not use it to claim product endorsement by TAF or any government agencies. The test results in the report only apply to the tested sample.





Table of Contents

1	CERTIFICATION	3
2	SUMMARY OF TEST RESULTS	4
2.1	MEASUREMENT UNCERTAINTY	4
3	GENERAL INFORMATION	5
3.1	GENERAL DESCRIPTION OF EUT	5
3.2	DESCRIPTION OF TEST MODES	6
3.3	GENERAL DESCRIPTION OF APPLIED STANDARDS	6
3.4	DESCRIPTION OF SUPPORT UNITS	7
1.1.1	CONFIGURATION OF SYSTEM UNDER TEST	7
4	TEST PROCEDURES AND RESULTS	8
4.1	CONDUCTED EMISSION MEASUREMENT	8
4.1.1	LIMITS OF CONDUCTED EMISSION MEASUREMENT	8
4.1.2	TEST INSTRUMENTS	8
4.1.3	TEST PROCEDURES	9
4.1.4	TEST SETUP	9
4.1.5	EUT OPERATING CONDITIONS	9
4.1.6	TEST RESULTS	10
4.2	RADIATED EMISSION MEASUREMENT	12
4.2.1	LIMITS OF RADIATED EMISSION MEASUREMENT	12
4.2.2	TEST INSTRUMENTS	13
4.2.3	TEST PROCEDURES	14
4.2.4	DEVIATION FROM TEST STANDARD	14
4.2.5	TEST SETUP	15
4.2.6	EUT OPERATING CONDITIONS	15
4.2.7	TEST RESULTS	16
4.3	CONDUCTED - OUT BAND MEASUREMENT	20
4.3.1	LIMITS OF CONDUCTED - OUT BAND MEASUREMENT	20
4.3.2	TEST INSTRUMENTS	20
4.3.3	TEST PROCEDURE	20
4.3.4	DEVIATION FROM TEST STANDARD	20
4.3.5	EUT OPERATING CONDITION	20
4.3.6	TEST RESULTS	21
5	INFORMATION ON THE TESTING LABORATORIES	22
6	APPENDIX A - MODIFICATIONS RECORDERS FOR ENGINEERING CHANGES TO THE EUT BY THE LAB	23



A D T

1 CERTIFICATION

PRODUCT : Wireless Game Controller_Receiver's
BRAND NAME : SONY
MODEL NO. : C-X50001
TESTED : Mar. 18 to 27, 2009
TEST SAMPLE : MASS-PRODUCTION
APPLICANT : LOGITECH FAR EAST LTD.
STANDARDS : 47 CFR Part 15, Subpart C (Section 15.249),
ANSI C63.4-2003

The above equipment (Model: C-X50001) has been tested by **Bureau Veritas Consumer Products Services (H.K.) Ltd., Taoyuan Branch**, and found compliance with the requirement of the above standards. The test record, data evaluation & Equipment Under Test (EUT) configurations represented herein are true and accurate accounts of the measurements of the sample's EMC characteristics under the conditions specified in this report.

PREPARED BY : Sunny Wen , **DATE:** Mar. 30, 2009
(Sunny Wen, Specialist)

TECHNICAL ACCEPTANCE : Hank Chung , **DATE:** Mar. 30, 2009
Responsible for RF (Hank Chung, Deputy Manager)

APPROVED BY : May Chen , **DATE:** Mar. 30, 2009
(May Chen, Deputy Manager)

2 SUMMARY OF TEST RESULTS

The EUT has been tested according to the following specifications:

APPLIED STANDARD: 47 CFR Part 15, Subpart C			
Standard Paragraph	Test Type	Result	Remark
15.207	Conducted Emission Test	PASS	Minimum passing margin is -16.02dB at 0.150MHz
15.249	Radiated Emission Test	PASS	Minimum passing margin is -10.62dB at 627.25.00MHz
15.249	Conducted out-band Emission Limit: 50 dB less than the peak value of fundamental frequency	PASS	Meet the requirement of limit

2.1 MEASUREMENT UNCERTAINTY

Where relevant, the following measurement uncertainty levels have been estimated for tests performed on the EUT as specified in CISPR 16-4-2:

This uncertainty represents an expanded uncertainty expressed at approximately the 95% confidence level using a coverage factor of $k=2$.

Measurement	Value
Conducted Emission	2.44 dB
Radiated emissions (30MHz-1GHz)	3.94 dB
Radiated emissions (1GHz -18GHz)	2.49 dB
Radiated emissions (18GHz -40GHz)	2.70 dB

3 GENERAL INFORMATION

3.1 GENERAL DESCRIPTION OF EUT

PRODUCT	Wireless Game Controller_Receiver's
MODEL NO.	C-X50001
FCC ID	JNZCX50001
POWER SUPPLY	DC 5V from host equipment
MODULATION TYPE	GFSK
MODULATION TECHNOLOGY	FHSS
CARRIER FREQUENCY OF EACH CHANNEL	2402MHz ~ 2480MHz
NUMBER OF CHANNEL	79
ANTENNA TYPE	Printed meander line on PCB antenna without connector (Antenna Gain : 0.6dBi)
DATA CABLE	NA
I/O PORTS	NA
ASSOCIATED DEVICES	NA

NOTE:

1. The above EUT information was declared by the manufacturer and for more detailed features description, please refer to the manufacturer's specifications or User's Manual.

3.2 DESCRIPTION OF TEST MODES

Seventy-nine channels are provided to this EUT.

Channel	Freq. (MHz)	Channel	Freq. (MHz)	Channel	Freq. (MHz)	Channel	Freq. (MHz)
0	2402	20	2422	40	2442	60	2462
1	2403	21	2423	41	2443	61	2463
2	2404	22	2424	42	2444	62	2464
3	2405	23	2425	43	2445	63	2465
4	2406	24	2426	44	2446	64	2466
5	2407	25	2427	45	2447	65	2467
6	2408	26	2428	46	2448	66	2468
7	2409	27	2429	47	2449	67	2469
8	2410	28	2430	48	2450	68	2470
9	2411	29	2431	49	2451	69	2471
10	2412	30	2432	50	2452	70	2472
11	2413	31	2433	51	2453	71	2473
12	2414	32	2434	52	2454	72	2474
13	2415	33	2435	53	2455	73	2475
14	2416	34	2436	54	2456	74	2476
15	2417	35	2437	55	2457	75	2477
16	2418	36	2438	56	2458	76	2478
17	2419	37	2439	57	2459	77	2479
18	2420	38	2440	58	2460	78	2480
19	2421	39	2441	59	2461		

NOTE:

1. Below 1 GHz, the channel 0, 39, and 78 were pre-tested in chamber. The channel 0, worst case one, was chosen for final test.
2. Above 1 GHz, the channel 0, 39, and 78 were tested individually.

3.3 GENERAL DESCRIPTION OF APPLIED STANDARDS

The EUT is a Wireless Game Controller_Receiver's. According to the specifications of the manufacturer, it must comply with the requirements of the following standards:

**47 CFR Part 15, Subpart C (Section 15.249)
ANSI C63.4: 2003**

All tests have been performed and recorded as per the above standards.

NOTE: The EUT is also considered as a kind of computer peripheral, because the connection to computer is necessary for typical use. It has been verified to comply with the requirements of FCC Part 15, Subpart B, Class B (DoC). The test report has been issued separately.

3.4 DESCRIPTION OF SUPPORT UNITS

The EUT has been tested as an independent unit together with other necessary accessories or support units. The following support units or accessories were used to form a representative test configuration during the tests.

NO.	PRODUCT	BRAND	MODEL NO.	SERIAL NO.	FCC ID
1	NOTEBOOK COMPUTER	DELL	D531	CN-0XM006-48643-86L-4472	QDS-BRCM1019
2	iPod	Apple	A1137	6U6078FMUPR	DoC

NO.	SIGNAL CABLE DESCRIPTION OF THE ABOVE SUPPORT UNITS
1	NA
2	NA

NOTE: All power cords of the above support units are non shielded (1.8m).

1.1. CONFIGURATION OF SYSTEM UNDER TEST

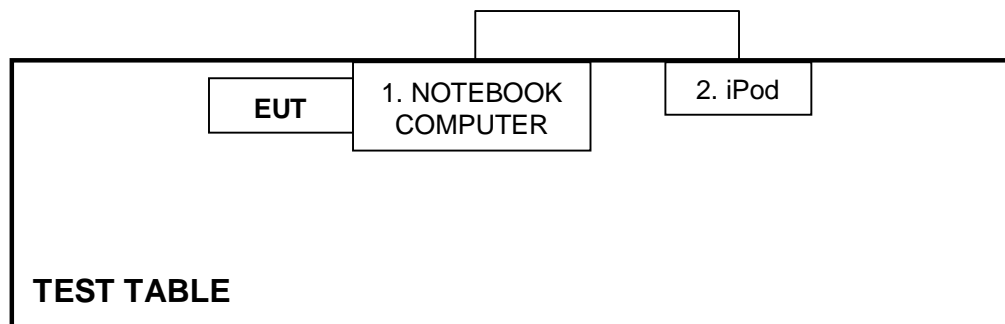



4 TEST PROCEDURES AND RESULTS

4.1 CONDUCTED EMISSION MEASUREMENT

4.1.1 LIMITS OF CONDUCTED EMISSION MEASUREMENT

FREQUENCY OF EMISSION (MHz)	CONDUCTED LIMIT (dB μ V)	
	Quasi-peak	Average
0.15-0.5	66 to 56	56 to 46
0.5-5	56	46
5-30	60	50

NOTE:

1. The lower limit shall apply at the transition frequencies.
2. All emanations from a class B digital device or system, including any network of conductors and apparatus connected thereto, shall not exceed the level of field strengths specified above.

4.1.2 TEST INSTRUMENTS

DESCRIPTION & MANUFACTURER	MODEL NO.	SERIAL NO.	CALIBRATED DATE	CALIBRATED UNTIL
Test Receiver	ESCS 30	100375	April 01, 2008	Mar. 31, 2009
Line-Impedance Stabilization Network (for EUT)	ENV-216	100071	Nov. 26, 2008	Nov. 25, 2009
Line-Impedance Stabilization Network (for Peripheral)	ESH3-Z5	848773/004	Nov. 05, 2008	Nov. 04, 2009
RF Cable (JYEBAO)	5DFB	COBCAB-001	Aug. 15, 2008	Aug. 14, 2009
50 ohms Terminator	50	3	Nov. 05, 2008	Nov. 04, 2009
Software	BV ADT_Cond_V7.3.7	NA	NA	NA

Note:

1. The calibration interval of the above test instruments is 12 months and the calibrations are traceable to NML/ROC and NIST/USA.
2. The test was performed in Shielded Room No. B.
3. The VCCI Con B Registration No. is C-2193.

4.1.3 TEST PROCEDURES

- a. The EUT/HOST was placed 0.4 meters from the conducting wall of the shielded room with EUT/HOST being connected to the power mains through a line impedance stabilization network (LISN). Other support units were connected to the power mains through another LISN. The two LISNs provide 50 ohm/ 50uH of coupling impedance for the measuring instrument.
- b. Both lines of the power mains connected to the EUT/HOST were checked for maximum conducted interference.
- c. The frequency range from 150 kHz to 30 MHz was searched. Emission levels over 10dB under the prescribed limits could not be reported

4.1.4 TEST SETUP

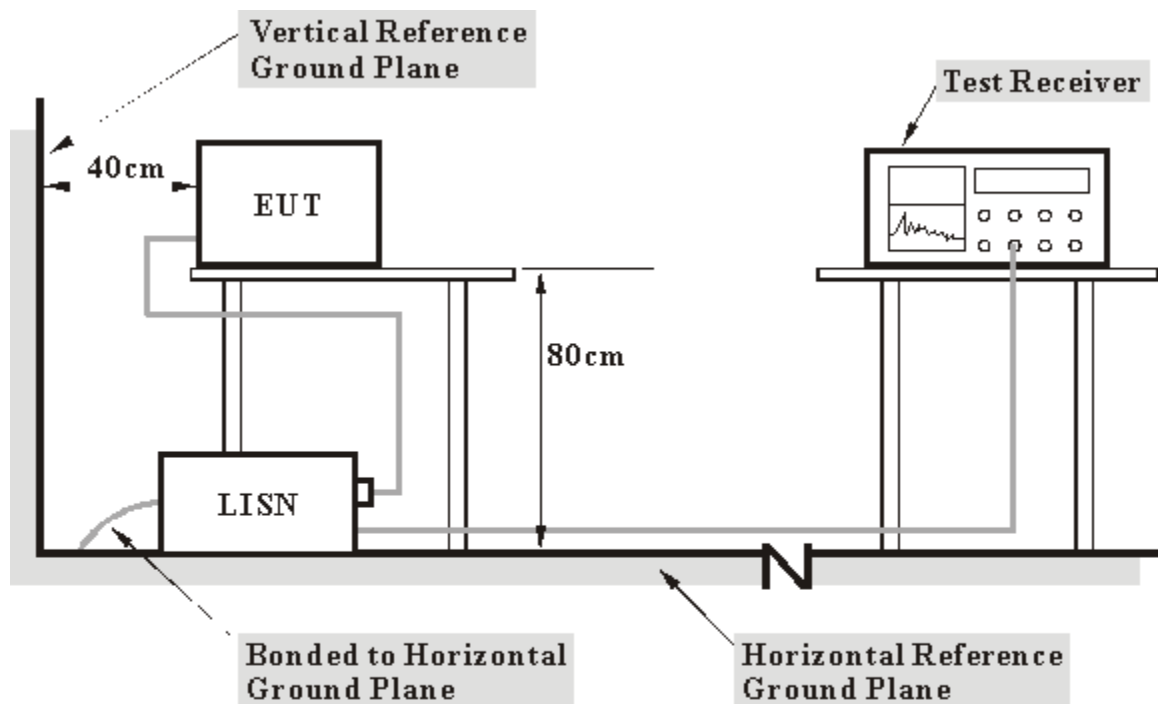

- Note:**
1. Support units were connected to second LISN.
 2. Both of LISNs (AMN) 80 cm from EUT and at the least 80 cm from other units and other metal planes support units.

For the actual test configuration, please refer to the related item – Photographs of the Test Configuration.

4.1.5 EUT OPERATING CONDITIONS

Set the EUT under transmission / receiver condition continuously at specific channel frequency.

4.1.6 TEST RESULTS

INPUT POWER (SYSTEM)	120Vac, 60 Hz	6DB BANDWIDTH	9 kHz
ENVIRONMENTAL CONDITIONS	24 deg. C, 60%RH, 962 hPa	PHASE	Line (L)
TESTED BY	Wen Yu		

No	Freq. [MHz]	Corr. Factor (dB)	Reading Value		Emission Level		Limit		Margin	
			[dB (uV)]		[dB (uV)]		[dB (uV)]		(dB)	
			Q.P.	AV.	Q.P.	AV.	Q.P.	AV.	Q.P.	AV.
1	0.150	0.11	49.38	-	49.49	-	66.00	56.00	-16.51	-
2	0.177	0.13	45.49	-	45.62	-	64.61	54.61	-18.99	-
3	0.236	0.18	38.23	-	38.41	-	62.24	52.24	-23.82	-
4	0.295	0.25	34.93	-	35.18	-	60.40	50.40	-25.21	-
5	1.574	0.24	26.12	-	26.36	-	56.00	46.00	-29.64	-
6	3.918	0.42	28.53	-	28.95	-	56.00	46.00	-27.05	-
7	5.074	0.44	27.55	-	27.99	-	60.00	50.00	-32.01	-

- REMARKS:**
1. Q.P. and AV. are abbreviations of quasi-peak and average individually.
 2. "-": The Quasi-peak reading value also meets average limit and measurement with the average detector is unnecessary.
 3. The emission levels of other frequencies were very low against the limit.
 4. Margin value = Emission level - Limit value
 5. Correction factor = Insertion loss + Cable loss
 6. Emission Level = Correction Factor + Reading Value.

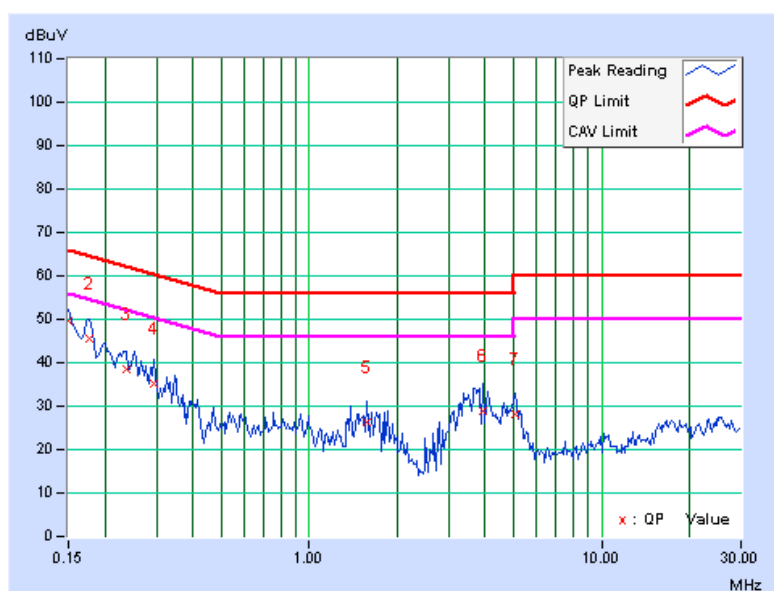

INPUT POWER (SYSTEM)	120Vac, 60 Hz	6dB BANDWIDTH	9 kHz
ENVIRONMENTAL CONDITIONS	24 deg. C, 60%RH, 962 hPa	PHASE	Neutral (N)
TESTED BY	Wen Yu		

No	Freq. [MHz]	Corr. Factor (dB)	Reading Value		Emission Level		Limit		Margin	
			[dB (uV)]		[dB (uV)]		[dB (uV)]		(dB)	
			Q.P.	AV.	Q.P.	AV.	Q.P.	AV.	Q.P.	AV.
1	0.150	0.10	49.88	-	49.98	-	66.00	56.00	-16.02	-
2	0.177	0.12	45.25	-	45.37	-	64.61	54.61	-19.24	-
3	0.236	0.17	38.73	-	38.90	-	62.24	52.24	-23.33	-
4	0.345	0.30	31.48	-	31.78	-	59.07	49.07	-27.29	-
5	3.887	0.35	25.36	-	25.71	-	56.00	46.00	-30.29	-
6	5.074	0.37	28.09	-	28.46	-	60.00	50.00	-31.54	-

- REMARKS:**
1. Q.P. and AV. are abbreviations of quasi-peak and average individually.
 2. "-": The Quasi-peak reading value also meets average limit and measurement with the average detector is unnecessary.
 3. The emission levels of other frequencies were very low against the limit.
 4. Margin value = Emission level - Limit value
 5. Correction factor = Insertion loss + Cable loss
 6. Emission Level = Correction Factor + Reading Value.

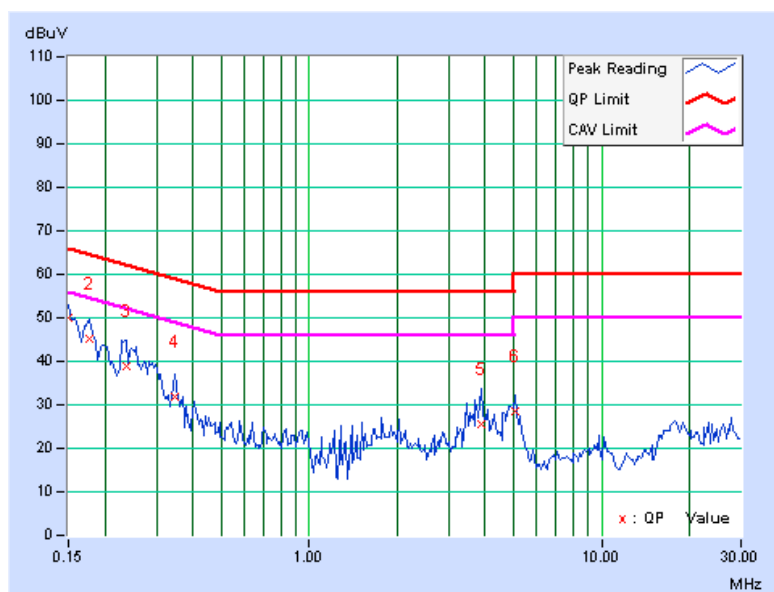

4.2 RADIATED EMISSION MEASUREMENT

4.2.1 LIMITS OF RADIATED EMISSION MEASUREMENT

According to 15.249 the field strength of emissions from intentional radiators operated under these frequencies bands shall not exceed the following:

Fundamental Frequency (MHz)	Field Strength of Fundamental (dBuV/m)	
	Peak	Average
2400 ~ 2483.5	114	94
	Field Strength of Harmonics (dBuV/m)	
	74	54

Emissions radiated outside of the specified frequency bands, except for harmonics, shall be attenuated by at least 50 dB below the level of the fundamental or to the general radiated emission limits in Section 15.209, whichever is the lesser attenuation.

Emissions radiated outside of the specified bands, shall be according to the general radiated limits in 15.209 as following:

Frequencies (MHz)	Field strength (microvolts/meter)	Measurement distance (meters)
0.009-0.490	2400/F(kHz)	300
0.490-1.705	24000/F(kHz)	30
1.705-30.0	30	30
30-88	100	3
88-216	150	3
216-960	200	3
Above 960	500	3

As shown in 15.35(b), for frequencies above 1000MHz, the field strength limits are based on average detector, however, the peak field strength of any emission shall not exceed the maximum permitted average limits, specified above by more than 20dB under any condition of modulation.



4.2.2 TEST INSTRUMENTS

DESCRIPTION & MANUFACTURER	MODEL NO.	SERIAL NO.	CALIBRATED DATE	CALIBRATED UNTIL
ROHDE & SCHWARZ Spectrum Analyzer	FSP40	100036	Dec. 09, 2008	Dec. 08, 2009
HP Pre_Amplifier	8449B	3008A01923	Nov. 10, 2008	Nov. 09, 2009
ROHDE & SCHWARZ Test Receiver	ESCS30	847124/029	Sep. 09, 2008	Sep. 08, 2009
SCHWARZBECK TRILOG Broadband Antenna	VULB 9168	138	April 30, 2008	April 29, 2009
Schwarzbeck Horn_Antenna	BBHA9120	D124	Dec. 09, 2008	Dec. 08, 2009
Schwarzbeck Horn_Antenna	BBHA 9170	BBHA9170153	Jan. 22, 2009	Jan. 21, 2010
RF Switches	EMH-011	08009	Oct. 07, 2008	Oct. 06, 2009
RF CABLE (Chaintek)	Sucoflex 106	28077	Aug. 15, 2008	Aug. 14, 2009
RF Cable	8DFB	STCCAB-30M-1GHz	Oct. 07, 2008	Oct. 06, 2009
Software	ADT_Radiated_V7.6.15.9.2	NA	NA	NA
CT Antenna Tower & Turn Table	NA	NA	NA	NA

Note: 1. The calibration interval of the above test instruments is 12 months and the calibrations are traceable to NML/ROC and NIST/USA.

2. The horn antenna, HP preamplifier (model: 8449B) and Spectrum Analyzer (model: FSP40) are used only for the measurement of emission frequency above 1GHz if tested.

3. The test was performed in Open Site No. C.

4. The FCC Site Registration No. is 656396.

5. The VCCI Site Registration No. is R-1626.

6. The CANADA Site Registration No. is IC 7450G-3.

4.2.3 TEST PROCEDURES

- a. The EUT was placed on the top of a rotating table 0.8 meters above the ground at a 10 meter open area test site. The table was rotated 360 degrees to determine the position of the highest radiation.
- b. The EUT was set 3 meters away from the interference-receiving antenna, which was mounted on the top of a variable-height antenna tower.
- c. The antenna is a broadband antenna, and its height is varied from one meter to four meters above the ground to determine the maximum value of the field strength. Both horizontal and vertical polarizations of the antenna are set to make the measurement.
- d. For each suspected emission, the EUT was arranged to its worst case and then the antenna was tuned to heights from 1 meter to 4 meters and the rotatable table was turned from 0 degrees to 360 degrees to find the maximum reading.
- e. The test-receiver system was set to Peak Detect Function and Specified Bandwidth with Maximum Hold Mode.
- f. If the emission level of the EUT in peak mode was 10 dB lower than the limit specified, then testing could be stopped and the peak values of the EUT would be reported. Otherwise the emissions that did not have 10 dB margin would be re-tested one by one using peak, quasi-peak or average method as specified and then reported in a data sheet.

NOTE:

1. The resolution bandwidth and video bandwidth of test receiver/spectrum analyzer is 120kHz for Peak detection (PK) and Quasi-peak detection (QP) at frequency below 1GHz.
2. The resolution bandwidth is 1MHz and video bandwidth of test receiver/spectrum analyzer is 3MHz for Peak detection at frequency above 1GHz. The resolution bandwidth of test receiver/spectrum analyzer is 1 MHz for Average detection (AV) at frequency above 1GHz.
3. The resolution bandwidth of test receiver/spectrum analyzer is 1 MHz and the video bandwidth is 10 Hz for Average detection (AV) at frequency above 1GHz.

4.2.4 DEVIATION FROM TEST STANDARD

No deviation

4.2.5 TEST SETUP

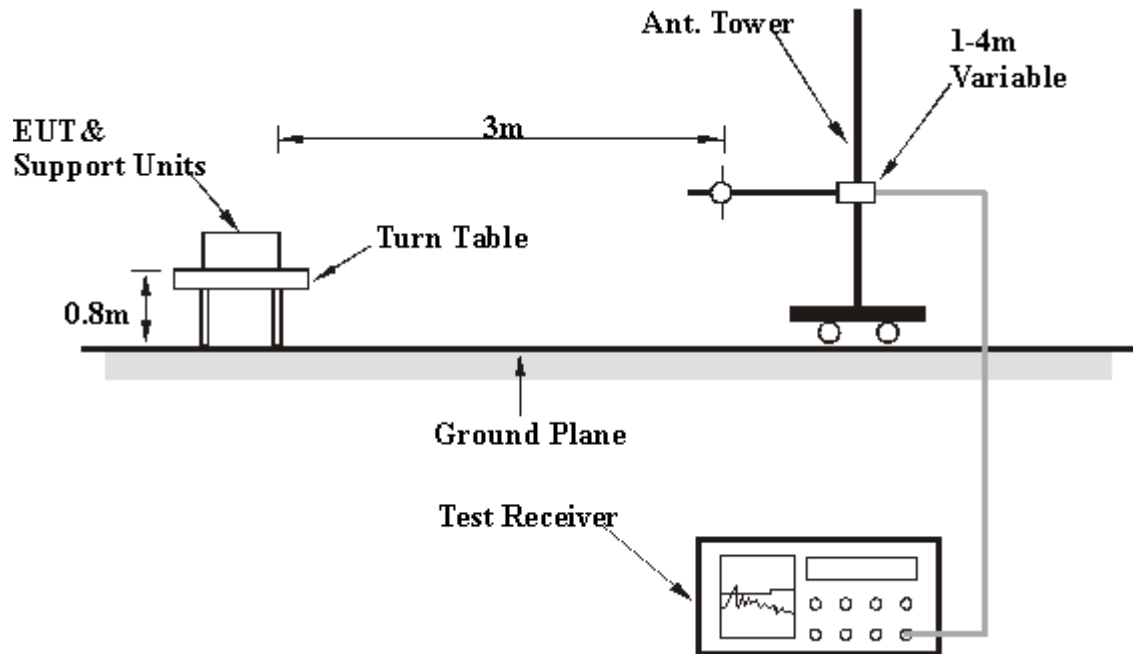

For the actual test configuration, please refer to the related item – Photographs of the Test Configuration.

4.2.6 EUT OPERATING CONDITIONS

Set the EUT under transmission / receiver condition continuously at specific channel frequency.



4.2.7 TEST RESULTS

EUT TEST CONDITION		MEASUREMENT DETAIL	
CHANNEL	Channel 0	FREQUENCY RANGE	Below 1000MHz
INPUT POWER (SYSTEME)	120Vac, 60Hz	DETECTOR FUNCTION	Quasi-Peak
ENVIRONMENTAL CONDITIONS	25deg. C, 61%RH 962hPa	TESTED BY	Frank Liu

ANTENNA POLARITY & TEST DISTANCE: HORIZONTAL AT 3 M								
NO.	FREQ. (MHz)	EMISSION LEVEL (dBuV/m)	LIMIT (dBuV/m)	MARGIN (dB)	ANTENNA HEIGHT (m)	TABLE ANGLE (Degree)	RAW VALUE (dBuV)	CORRECTION FACTOR (dB/m)
1	166.280	24.65 QP	43.50	-18.85	1.00 H	322	9.22	15.43
2	184.260	28.06 QP	43.50	-15.44	1.00 H	43	13.86	14.20
3	228.840	29.80 QP	46.00	-16.20	1.00 H	20	15.41	14.39
4	336.000	27.42 QP	46.00	-18.58	1.00 H	12	8.93	18.49
5	360.000	25.15 QP	46.00	-20.85	1.00 H	112	5.67	19.48
6	473.260	30.00 QP	46.00	-16.00	1.23 H	302	7.75	22.25
7	627.250	35.38 QP	46.00	-10.62	1.64 H	15	9.99	25.39

ANTENNA POLARITY & TEST DISTANCE: VERTICAL AT 3 M								
NO.	FREQ. (MHz)	EMISSION LEVEL (dBuV/m)	LIMIT (dBuV/m)	MARGIN (dB)	ANTENNA HEIGHT (m)	TABLE ANGLE (Degree)	RAW VALUE (dBuV)	CORRECTION FACTOR (dB/m)
1	238.400	26.37 QP	46.00	-19.63	1.00 V	216	11.52	14.85
2	362.330	25.46 QP	46.00	-20.54	1.00 V	265	5.88	19.58
3	434.000	35.32 QP	46.00	-10.68	1.00 V	155	13.67	21.65
4	528.000	26.54 QP	46.00	-19.46	1.00 V	302	3.21	23.33
5	627.250	33.84 QP	46.00	-12.16	1.00 V	147	8.45	25.39
6	687.250	28.10 QP	46.00	-17.90	1.00 V	115	1.35	26.75

- REMARKS:**
1. Emission level (dBuV/m) = Raw Value (dBuV) + Correction Factor (dB/m).
 2. Correction Factor (dB/m) = Antenna Factor (dB/m) + Cable Factor (dB).
 3. The other emission levels were very low against the limit.
 4. Margin value = Emission level – Limit value.



EUT TEST CONDITION		MEASUREMENT DETAIL	
CHANNEL	Channel 0	FREQUENCY RANGE	1 ~ 25GHz
INPUT POWER (SYSTEME)	120Vac, 60Hz	DETECTOR FUNCTION	Peak (PK) Average (AV)
ENVIRONMENTAL CONDITIONS	25deg. C, 67%RH 962hPa	TESTED BY	Eric Lee

ANTENNA POLARITY & TEST DISTANCE: HORIZONTAL AT 3 M								
NO.	FREQ. (MHz)	EMISSION LEVEL (dBuV/m)	LIMIT (dBuV/m)	MARGIN (dB)	ANTENNA HEIGHT (m)	TABLE ANGLE (Degree)	RAW VALUE (dBuV)	CORRECTION FACTOR (dB/m)
1	2399.990	51.45 PK	74.00	-22.55	1.40 H	172	21.35	30.10
2	2399.990	19.70 AV	54.00	-34.30	1.40 H	172	-10.40	30.10
3	*2402.000	91.22 PK	114.00	-22.78	1.40 H	172	61.11	30.11
4	*2402.000	59.47 AV	94.00	-34.53	1.40 H	172	29.36	30.11
5	4804.000	55.18 PK	74.00	-18.82	1.28 H	82	19.75	35.43
6	4804.000	23.43 AV	54.00	-30.57	1.28 H	82	-12.00	35.43
7	7206.000	53.69 PK	74.00	-20.31	1.72 H	30	11.91	41.78
8	7206.000	21.94 AV	54.00	-32.06	1.72 H	30	-19.84	41.78
ANTENNA POLARITY & TEST DISTANCE: VERTICAL AT 3 M								
NO.	FREQ. (MHz)	EMISSION LEVEL (dBuV/m)	LIMIT (dBuV/m)	MARGIN (dB)	ANTENNA HEIGHT (m)	TABLE ANGLE (Degree)	RAW VALUE (dBuV)	CORRECTION FACTOR (dB/m)
1	2399.990	55.87 PK	74.00	-18.13	1.34 V	80	25.77	30.10
2	2399.990	24.12 AV	54.00	-29.88	1.34 V	80	-5.98	30.10
3	*2402.000	95.64 PK	114.00	-18.36	1.34 V	80	65.53	30.11
4	*2402.000	63.89 AV	94.00	-30.11	1.34 V	80	33.78	30.11
5	4804.000	53.11 PK	74.00	-20.89	1.29 V	122	17.68	35.43
6	4804.000	21.36 AV	54.00	-32.64	1.29 V	122	-14.07	35.43
7	7206.000	53.92 PK	74.00	-20.08	1.31 V	71	12.14	41.78
8	7206.000	22.17 AV	54.00	-31.83	1.31 V	71	-19.61	41.78

- REMARKS:**
1. Emission level (dBuV/m) = Raw Value (dBuV) + Correction Factor (dB/m).
 2. Correction Factor (dB/m) = Antenna Factor (dB/m) + Cable Factor (dB).
 3. The other emission levels were very low against the limit.
 4. Margin value = Emission level – Limit value.
 5. “ * “: Fundamental frequency.
 6. Duty cycle = 2.58%
 7. Average value = peak reading + 20log(duty cycle).



EUT TEST CONDITION		MEASUREMENT DETAIL	
CHANNEL	Channel 39	FREQUENCY RANGE	1 ~ 25GHz
INPUT POWER (SYSTME)	120Vac, 60Hz	DETECTOR FUNCTION	Peak (PK) Average (AV)
ENVIRONMENTAL CONDITIONS	25deg. C, 67%RH 962hPa	TESTED BY	Eric Lee

ANTENNA POLARITY & TEST DISTANCE: HORIZONTAL AT 3 M								
NO.	FREQ. (MHz)	EMISSION LEVEL (dBuV/m)	LIMIT (dBuV/m)	MARGIN (dB)	ANTENNA HEIGHT (m)	TABLE ANGLE (Degree)	RAW VALUE (dBuV)	CORRECTION FACTOR (dB/m)
1	*2441.000	90.65 PK	114.00	-23.35	1.35 H	169	60.39	30.26
2	*2441.000	58.90 AV	94.00	-35.10	1.35 H	169	28.64	30.26
3	4882.000	55.08 PK	74.00	-18.92	1.18 H	79	19.52	35.56
4	4882.000	23.33 AV	54.00	-30.67	1.18 H	79	-12.23	35.56
5	7323.000	52.87 PK	74.00	-21.13	1.62 H	28	10.80	42.07
6	7323.000	21.12 AV	54.00	-32.88	1.62 H	28	-20.95	42.07
ANTENNA POLARITY & TEST DISTANCE: VERTICAL AT 3 M								
NO.	FREQ. (MHz)	EMISSION LEVEL (dBuV/m)	LIMIT (dBuV/m)	MARGIN (dB)	ANTENNA HEIGHT (m)	TABLE ANGLE (Degree)	RAW VALUE (dBuV)	CORRECTION FACTOR (dB/m)
1	*2441.000	94.89 PK	114.00	-19.11	1.30 V	118	64.63	30.26
2	*2441.000	63.14 AV	94.00	-30.86	1.30 V	118	32.88	30.26
3	4882.000	53.09 PK	74.00	-20.91	1.30 V	169	17.53	35.56
4	4882.000	21.34 AV	54.00	-32.66	1.30 V	169	-14.22	35.56
5	7323.000	53.11 PK	74.00	-20.89	1.28 V	92	11.04	42.07
6	7323.000	21.36 AV	54.00	-32.64	1.28 V	92	-20.71	42.07

- REMARKS:**
1. Emission level (dBuV/m) = Raw Value (dBuV) + Correction Factor (dB/m).
 2. Correction Factor (dB/m) = Antenna Factor (dB/m) + Cable Factor (dB).
 3. The other emission levels were very low against the limit.
 4. Margin value = Emission level – Limit value.
 5. “ * ”: Fundamental frequency.
 6. Duty cycle = 2.58%
 7. Average value = peak reading + 20log(duty cycle).



EUT TEST CONDITION		MEASUREMENT DETAIL	
CHANNEL	Channel 78	FREQUENCY RANGE	1 ~ 25GHz
INPUT POWER (SYSTME)	120Vac, 60Hz	DETECTOR FUNCTION	Peak (PK) Average (AV)
ENVIRONMENTAL CONDITIONS	25deg. C, 67%RH 962hPa	TESTED BY	Eric Lee

ANTENNA POLARITY & TEST DISTANCE: HORIZONTAL AT 3 M

NO.	FREQ. (MHz)	EMISSION LEVEL (dBuV/m)	LIMIT (dBuV/m)	MARGIN (dB)	ANTENNA HEIGHT (m)	TABLE ANGLE (Degree)	RAW VALUE (dBuV)	CORRECTION FACTOR (dB/m)
1	*2480.000	89.17 PK	114.00	-24.83	1.30 H	170	58.76	30.41
2	*2480.000	57.42 AV	94.00	-32.34	1.30 H	170	27.01	30.41
3	2483.500	47.51 PK	74.00	-26.49	1.30 H	170	17.08	30.43
4	2483.500	15.82 AV	54.00	-38.18	1.30 H	170	-14.61	30.43
5	4960.000	54.96 PK	74.00	-19.04	1.68 H	275	19.27	35.69
6	4960.000	23.21 AV	54.00	-30.79	1.68 H	275	-12.48	35.69
7	7440.000	52.97 PK	74.00	-21.03	1.37 H	257	10.60	42.37
8	7440.000	21.22 AV	54.00	-32.78	1.37 H	257	-21.15	42.37

ANTENNA POLARITY & TEST DISTANCE: VERTICAL AT 3 M

NO.	FREQ. (MHz)	EMISSION LEVEL (dBuV/m)	LIMIT (dBuV/m)	MARGIN (dB)	ANTENNA HEIGHT (m)	TABLE ANGLE (Degree)	RAW VALUE (dBuV)	CORRECTION FACTOR (dB/m)
1	*2480.000	93.41 PK	114.00	-20.59	1.27 V	131	63.00	30.41
2	*2480.000	61.66 AV	94.00	-32.34	1.27 V	131	31.25	30.41
3	2483.500	51.75 PK	74.00	-22.25	1.27 V	131	21.32	30.43
4	2483.500	20.00 AV	54.00	-34.00	1.27 V	131	-10.43	30.43
5	4960.000	53.78 PK	74.00	-20.22	1.27 V	113	18.09	35.69
6	4960.000	22.03 AV	54.00	-31.97	1.27 V	113	-13.66	35.69
7	7440.000	52.08 PK	74.00	-21.92	1.15 V	80	9.71	42.37
8	7440.000	20.33 AV	54.00	-33.67	1.15 V	80	-22.04	42.37

- REMARKS:**
1. Emission level (dBuV/m) = Raw Value (dBuV) + Correction Factor (dB/m).
 2. Correction Factor (dB/m) = Antenna Factor (dB/m) + Cable Factor (dB).
 3. The other emission levels were very low against the limit.
 4. Margin value = Emission level – Limit value.
 5. “ * “: Fundamental frequency.
 6. Duty cycle = 2.58%
 7. Average value = peak reading + 20log(duty cycle).



4.3 CONDUCTED - OUT BAND MEASUREMENT

4.3.1 LIMITS OF CONDUCTED - OUT BAND MEASUREMENT

Emissions radiated outside of the specified frequency bands, except for harmonics, shall be attenuated by at least 50 dB below the level of the fundamental or to the general radiated emission limits in Section 15.209, whichever is the lesser attenuation.

4.3.2 TEST INSTRUMENTS

DESCRIPTION & MANUFACTURER	MODEL NO.	SERIAL NO.	CALIBRATED DATE	CALIBRATED UNTIL
R&S SPECTRUM ANALYZER	FSP40	100036	Dec. 09, 2008	Dec. 08, 2009

NOTE:

- 1.The calibration interval of the above test instruments is 12 months and the calibrations are traceable to NML/ROC and NIST/USA.

4.3.3 TEST PROCEDURE

The transmitter output was connected to the spectrum analyzer via a low lose cable. Set both RBW and VBW of spectrum analyzer to 100 kHz with suitable frequency span including 300 MHz bandwidth from band edge. The band edges was measured and recorded.

4.3.4 DEVIATION FROM TEST STANDARD

No deviation

4.3.5 EUT OPERATING CONDITION

The software provided by client enabled the EUT to transmit and receive data at lowest, middle and highest channel frequencies individually.

4.3.6 TEST RESULTS

Emissions radiated outside of the specified frequency bands, please refer pages form 12 to 15 for met the requirement of the general radiated emission limits in § 15.209. CH0

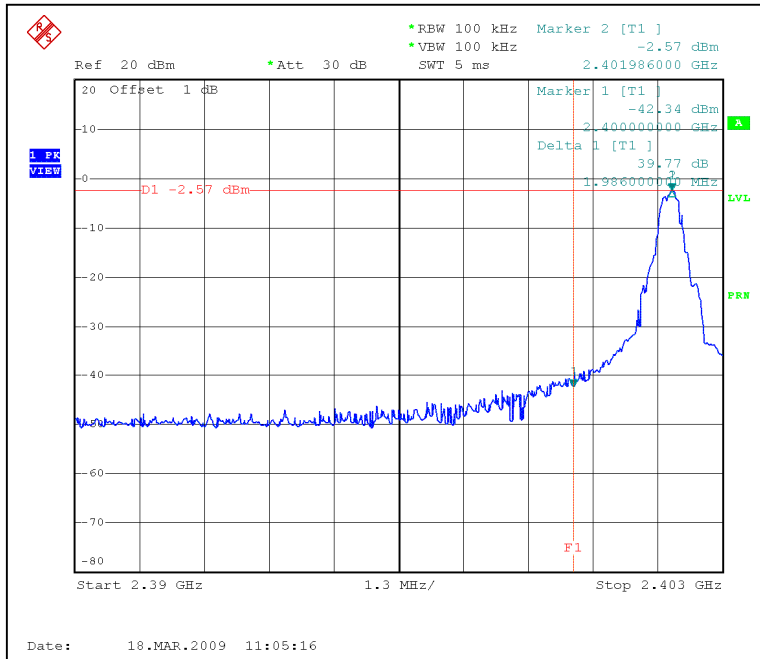

CH78

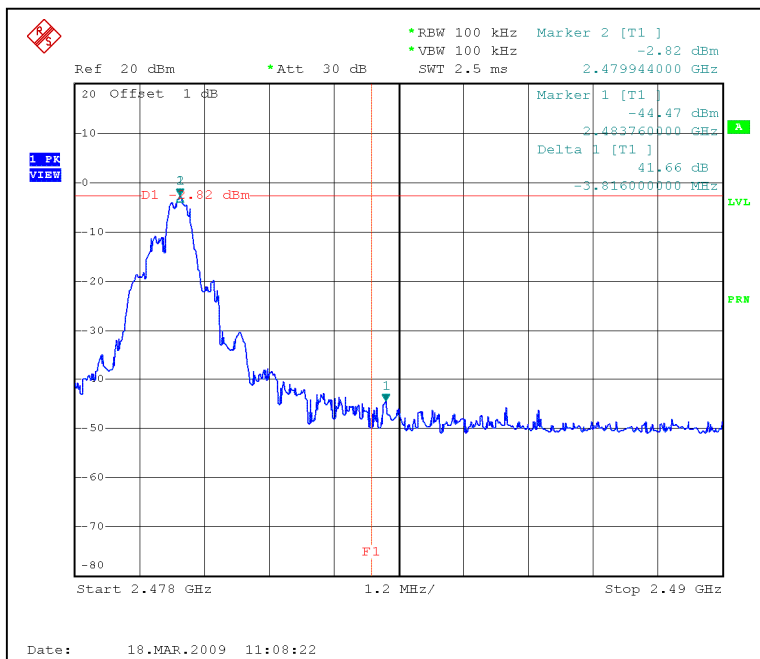



A D T

5 INFORMATION ON THE TESTING LABORATORIES

We, Bureau Veritas Consumer Products Services (H.K.) Ltd., Taoyuan Branch, were founded in 1988 to provide our best service in EMC, Radio, Telecom and Safety consultation. Our laboratories are accredited and approved by the following approval agencies according to ISO/IEC 17025.

USA	FCC, NVLAP
Germany	TUV Rheinland
Japan	VCCI
Norway	NEMKO
Canada	INDUSTRY CANADA, CSA
R.O.C.	TAF, BSMI, NCC
Netherlands	Telefication
Singapore	GOST-ASIA (MOU)
Russia	CERTIS (MOU)

Copies of accreditation certificates of our laboratories obtained from approval agencies can be downloaded from our web site: www.adt.com.tw/index.5/phtml.

If you have any comments, please feel free to contact us at the following:

Linko EMC/RF Lab:

Tel: 886-2-26052180

Fax: 886-2-26051924

Hsin Chu EMC/RF Lab:

Tel: 886-3-5935343

Fax: 886-3-5935342

Hwa Ya EMC/RF/Safety/Telecom Lab:

Tel: 886-3-3183232

Fax: 886-3-3185050

Email: service@adt.com.tw

Web Site: www.adt.com.tw

The address and road map of all our labs can be found in our web site also.



A D T

6 APPENDIX A - MODIFICATIONS RECORDERS FOR ENGINEERING CHANGES TO THE EUT BY THE LAB

No any modifications are made to the EUT by the lab during the test.

--- END ---