

FCC TEST REPORT

REPORT NO.: RF970107H03

MODEL NO.: C-UBG-DEL4

RECEIVED: Jan. 31, 2008

TESTED: Feb. 02 to 13, 2008

ISSUED: Feb. 14, 2008

APPLICANT: LOGITECH FAR EAST LTD.

ADDRESS: #2 Creation Rd. 4, Science-Based Ind. Park
Hsinchu Taiwan, R.O.C.

ISSUED BY: Advance Data Technology Corporation

LAB LOCATION: No. 81-1, Lu Liao Keng, 9 Ling, Wu Lung Tsuen,
Chiung Lin Hsiang, Hsin Chu Hsien,
Taiwan, R.O.C.

This test report consists of 26 pages in total. It may be duplicated completely for legal use with the approval of the applicant. It should not be reproduced except in full, without the written approval of our laboratory. The client should not use it to claim product endorsement by TAF, A2LA or any government agencies. The test results in the report only apply to the tested sample.



Table of Contents

1	CERTIFICATION.....	3
2	SUMMARY OF TEST RESULTS.....	4
3	GENERAL INFORMATION	5
3.1	GENERAL DESCRIPTION OF EUT.....	5
3.2	DESCRIPTION OF TEST MODES.....	6
3.3	GENERAL DESCRIPTION OF APPLIED STANDARDS	6
3.4	DESCRIPTION OF SUPPORT UNITS.....	7
3.5	CONFIGURATION OF SYSTEM UNDER TEST	7
4	TEST PROCEDURES AND RESULTS	8
4.1	CONDUCTED EMISSION MEASUREMENT	8
4.1.1	LIMITS OF CONDUCTED EMISSION MEASUREMENT	8
4.1.2	TEST INSTRUMENTS.....	8
4.1.3	TEST PROCEDURES.....	9
4.1.4	TEST SETUP.....	9
4.1.5	EUT OPERATING CONDITIONS.....	10
4.1.6	TEST RESULTS	11
4.2	RADIATED EMISSION MEASUREMENT	13
4.2.1	LIMITS OF RADIATED EMISSION MEASUREMENT	13
4.2.2	TEST INSTRUMENTS.....	15
4.2.3	TEST PROCEDURES.....	16
4.2.4	DEVIATION FROM TEST STANDARD	16
4.2.5	TEST SETUP.....	17
4.2.6	EUT OPERATING CONDITIONS.....	17
4.2.7	TEST RESULTS	18
4.3	BAND EDGES MEASUREMENT.....	22
4.3.1	LIMITS OF BAND EDGES MEASUREMENT.....	22
4.3.2	TEST INSTRUMENTS.....	22
4.3.3	TEST PROCEDURE	22
4.3.4	DEVIATION FROM TEST STANDARD	22
4.3.5	EUT OPERATING CONDITION.....	22
4.3.6	TEST RESULTS	23
5	INFORMATION ON THE TESTING LABORATORIES	25
6	APPENDIX-A- MODIFICATIONS RECORDERS FOR ENGINEERING CHANGES TO THE EUT BY THE LAB	26

1 CERTIFICATION

PRODUCT : 2.4GHz internal Transceiver
BRAND NAME : DELL
MODEL NO : C-UBG-DEL4
TESTED: Feb. 02 to 13, 2008
APPLICANT : LOGITECH FAR EAST LTD.
STANDARDS : 47 CFR Part 15, Subpart C (Section 15.249),
ANSI C63.4-2003

The above equipment (Model: C-UBG-DEL4) has been tested by **Advance Data Technology Corporation**, and found compliance with the requirement of the above standards. The test record, data evaluation & Equipment Under Test (EUT) configurations represented herein are true and accurate accounts of the measurements of the sample's EMC characteristics under the conditions specified in this report.

PREPARED BY : Carol Liao , **DATE:** Feb. 14, 2008
(Carol Liao, Specialist)

TECHNICAL ACCEPTANCE : Hank Chung , **DATE:** Feb. 14, 2008
Responsible for RF (Hank Chung, Deputy Manager)

APPROVED BY : May Chen , **DATE:** Feb. 14, 2008
(May Chen, Deputy Manager)

2 SUMMARY OF TEST RESULTS

The EUT has been tested according to the following specifications:

APPLIED STANDARD: 47 CFR Part 15, Subpart C			
Standard Paragraph	Test Type	Result	Remark
15.207	Conducted Emission Test	PASS	Minimum passing margin is -14.25dB at 0.170MHz
15.249	Radiated Emission Test	PASS	Minimum passing margin is -3.46dB at 2483.50MHz
15.249	Band Edge Measurement	PASS	Meet the requirement of limit

3 GENERAL INFORMATION

3.1 GENERAL DESCRIPTION OF EUT

PRODUCT	2.4GHz internal Transceiver
MODEL NO.	C-UBG-DEL4
FCC ID	JNZCUBGDEL4
POWER SUPPLY	DC 5.0V from host equipment
MODULATION TYPE	GFSK
CARRIER FREQUENCY OF EACH CHANNEL	2402MHz ~ 2481MHz
NUMBER OF CHANNEL	80
ANTENNA TYPE	PCB printed meander line antenna with -10.37dBi antenna gain
DATA CABLE	NA
I/O PORTS	NA
ASSOCIATED DEVICES	NA

NOTE:

1. The above EUT information was declared by the manufacturer and for more detailed features description, please refer to the manufacturer's specifications or User's Manual.

3.2 DESCRIPTION OF TEST MODES

Eighty channels are provided to this EUT.

Channel	Freq. (MHz)	Channel	Freq. (MHz)	Channel	Freq. (MHz)	Channel	Freq. (MHz)
0	2402	20	2422	40	2442	60	2462
1	2403	21	2423	41	2443	61	2463
2	2404	22	2424	42	2444	62	2464
3	2405	23	2425	43	2445	63	2465
4	2406	24	2426	44	2446	64	2466
5	2407	25	2427	45	2447	65	2467
6	2408	26	2428	46	2448	66	2468
7	2409	27	2429	47	2449	67	2469
8	2410	28	2430	48	2450	68	2470
9	2411	29	2431	49	2451	69	2471
10	2412	30	2431	50	2452	70	2472
11	2413	31	2433	51	2453	71	2473
12	2414	32	2434	52	2454	72	2474
13	2415	33	2435	53	2455	73	2475
14	2416	34	2436	54	2456	74	2476
15	2417	35	2437	55	2457	75	2477
16	2418	36	2438	56	2458	76	2478
17	2419	37	2439	57	2459	77	2479
18	2420	38	2440	58	2460	78	2480
19	2421	39	2441	59	2461	79	2481

NOTE:

1. Below 1 GHz, the channel 0, 39, and 79 were pre-tested in chamber. The channel 0, worst case one, was chosen for final test.
2. Above 1 GHz, the channel 0, 39, and 79 were tested individually.

3.3 GENERAL DESCRIPTION OF APPLIED STANDARDS

The EUT is a 2.4GHz internal Transceiver. According to the specifications of the manufacturer, it must comply with the requirements of the following standards:

**47 CFR Part 15, Subpart C (Section 15.249)
ANSI C63.4: 2003**

All tests have been performed and recorded as per the above standards.

3.4 DESCRIPTION OF SUPPORT UNITS

The EUT has been tested as an independent unit together with other necessary accessories or support units. The following support units or accessories were used to form a representative test configuration during the tests.

NO.	PRODUCT	BRAND	MODEL NO.	SERIAL NO.	FCC ID
1	Notebook Computer	DELL	PP05L	CN-04Y212-48643-3 8E-0145	FCC DoC

NO.	SIGNAL CABLE DESCRIPTION OF THE ABOVE SUPPORT UNITS
1	NA

NOTE: All power cords of the above support units are non-shielded (1.8m).

3.5 CONFIGURATION OF SYSTEM UNDER TEST

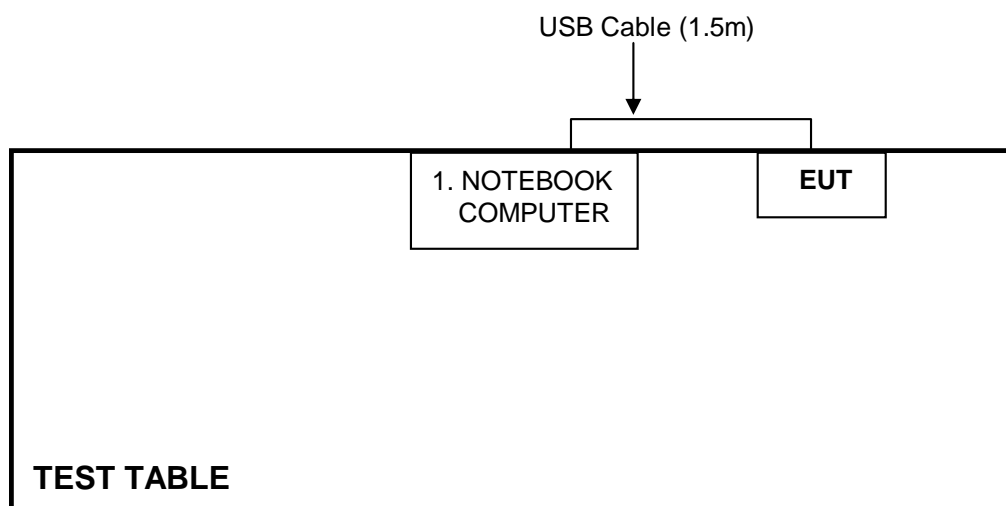

4 TEST PROCEDURES AND RESULTS

4.1 CONDUCTED EMISSION MEASUREMENT

4.1.1 LIMITS OF CONDUCTED EMISSION MEASUREMENT

FREQUENCY OF EMISSION (MHz)	CONDUCTED LIMIT (dB μ V)	
	Quasi-peak	Average
0.15-0.5	66 to 56	56 to 46
0.5-5	56	46
5-30	60	50

NOTE:

1. The lower limit shall apply at the transition frequencies.
2. All emanations from a class B digital device or system, including any network of conductors and apparatus connected thereto, shall not exceed the level of field strengths specified above.

4.1.2 TEST INSTRUMENTS

DESCRIPTION & MANUFACTURER	MODEL NO.	SERIAL NO.	CALIBRATED UNTIL
Test Receiver	ESCS 30	847124/029	Mar. 28, 2008
Line-Impedance Stabilization Network(for EUT)	ESH3-Z5	848773/004	Nov. 08, 2008
Line-Impedance Stabilization Network(for Peripheral)	ENV-216	100071	Nov. 26, 2008
RF Cable (JETBAO)	RG233/U	Cable_CB_01	Dec. 09, 2008
50 ohms Terminator	50	3	Nov. 15, 2008
Software	ADT_Cond_V7.3.2	NA	NA

- NOTE: 1. The calibration interval of the above test instruments is 12 months and the calibrations are traceable to NML/ROC and NIST/USA.
 2. The test was performed in ADT Shielded Room No. B.
 3. The VCCI Con B Registration No. is C-2193.

4.1.3 TEST PROCEDURES

- a. The EUT/HOST was placed 0.4 meters from the conducting wall of the shielded room with EUT/HOST being connected to the power mains through a line impedance stabilization network (LISN). Other support units were connected to the power mains through another LISN. The two LISNs provide 50 ohm/ 50uH of coupling impedance for the measuring instrument.
- b. Both lines of the power mains connected to the EUT/HOST were checked for maximum conducted interference.
- c. The frequency range from 150 kHz to 30 MHz was searched. Emission levels over 10dB under the prescribed limits could not be reported

4.1.4 TEST SETUP

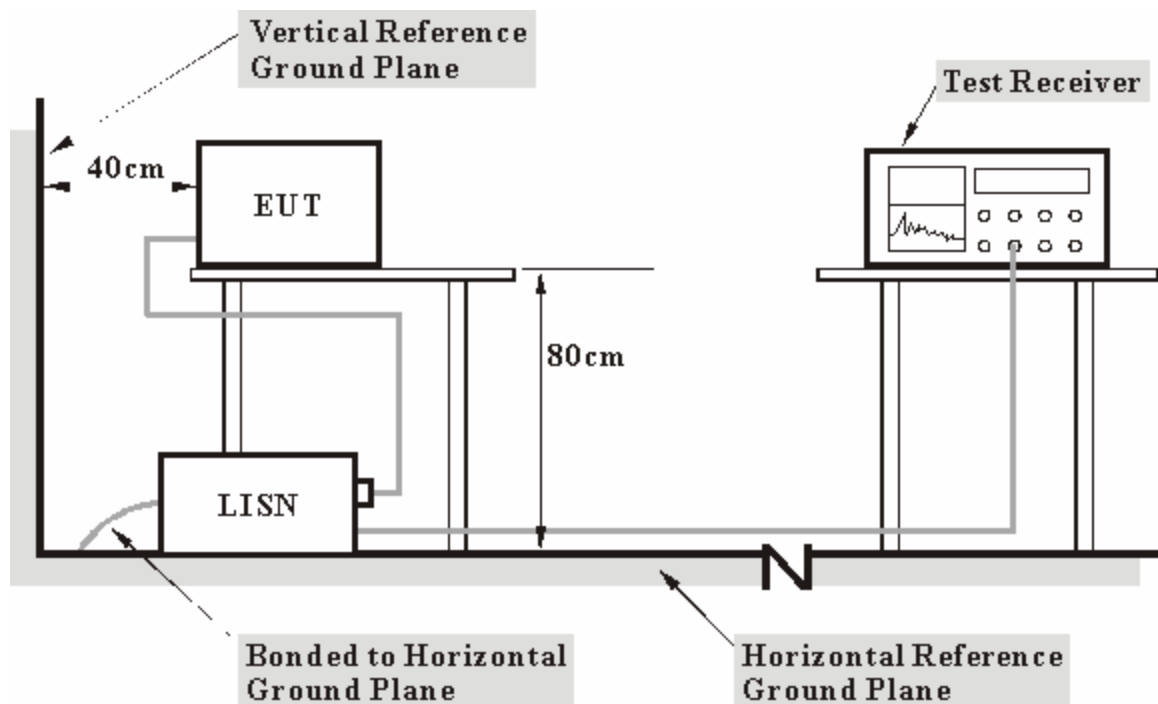

- Note:**
1. Support units were connected to second LISN.
 2. Both of LISNs (AMN) 80 cm from EUT and at the least 80 cm from other units and other metal planes support units.

For the actual test configuration, please refer to the related item – Photographs of the Test Configuration.

4.1.5 EUT OPERATING CONDITIONS

- a. Connect the EUT with the support unit 1 (Notebook computer) which placed on a testing table.
- b. The support unit 1 (Notebook computer) ran a test program “WUSBLP_test.exe” to enable EUT under transmission condition continuously at specific channel frequency.

4.1.6 TEST RESULTS

INPUT POWER (SYSTEM)	120Vac, 60 Hz	6DB BANDWIDTH	9 kHz
ENVIRONMENTAL CONDITIONS	13 deg. C, 56%RH, 971 hPa	PHASE	Line (L)
TESTED BY	Wen Yu		

No	Freq. [MHz]	Corr. Factor (dB)	Reading Value		Emission Level		Limit		Margin	
			[dB (uV)]		[dB (uV)]		[dB (uV)]		(dB)	
	Q.P.	AV.	Q.P.	AV.	Q.P.	AV.	Q.P.	AV.	Q.P.	AV.
1	0.170	0.15	50.58	-	50.73	-	64.98	54.98	-14.25	-
2	0.224	0.16	43.20	-	43.36	-	62.66	52.66	-19.30	-
3	1.068	0.29	27.82	-	28.11	-	56.00	46.00	-27.89	-
4	1.314	0.32	30.79	-	31.11	-	56.00	46.00	-24.89	-
5	3.891	0.35	36.11	-	36.46	-	56.00	46.00	-19.54	-
6	26.602	1.53	33.90	-	35.43	-	60.00	50.00	-24.57	-

- REMARKS:**
1. Q.P. and AV. are abbreviations of quasi-peak and average individually.
 2. "-": The Quasi-peak reading value also meets average limit and measurement with the average detector is unnecessary.
 3. The emission levels of other frequencies were very low against the limit.
 4. Margin value = Emission level - Limit value
 5. Correction factor = Insertion loss + Cable loss
 6. Emission Level = Correction Factor + Reading Value.

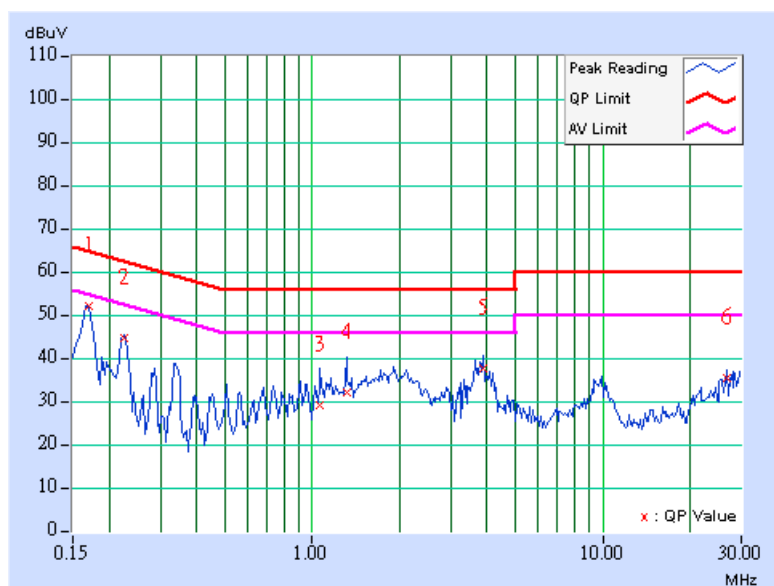

INPUT POWER (SYSTEM)	120Vac, 60 Hz	6dB BANDWIDTH	9 kHz
ENVIRONMENTAL CONDITIONS	13 deg. C, 56%RH, 971 hPa	PHASE	Neutral (N)
TESTED BY	Wen Yu		

No	Freq. [MHz]	Corr. Factor (dB)	Reading Value		Emission Level		Limit		Margin	
			[dB (uV)]		[dB (uV)]		[dB (uV)]		(dB)	
			Q.P.	AV.	Q.P.	AV.	Q.P.	AV.	Q.P.	AV.
1	0.166	0.08	50.14	-	50.22	-	65.18	55.18	-14.96	-
2	0.224	0.08	42.33	-	42.41	-	62.66	52.66	-20.25	-
3	0.275	0.08	37.18	-	37.26	-	60.97	50.97	-23.71	-
4	1.923	0.31	31.64	-	31.95	-	56.00	46.00	-24.05	-
5	3.949	0.28	32.82	-	33.10	-	56.00	46.00	-22.90	-
6	27.980	1.51	33.41	-	34.92	-	60.00	50.00	-25.08	-

- REMARKS:**
1. Q.P. and AV. are abbreviations of quasi-peak and average individually.
 2. "-": The Quasi-peak reading value also meets average limit and measurement with the average detector is unnecessary.
 3. The emission levels of other frequencies were very low against the limit.
 4. Margin value = Emission level - Limit value
 5. Correction factor = Insertion loss + Cable loss
 6. Emission Level = Correction Factor + Reading Value.

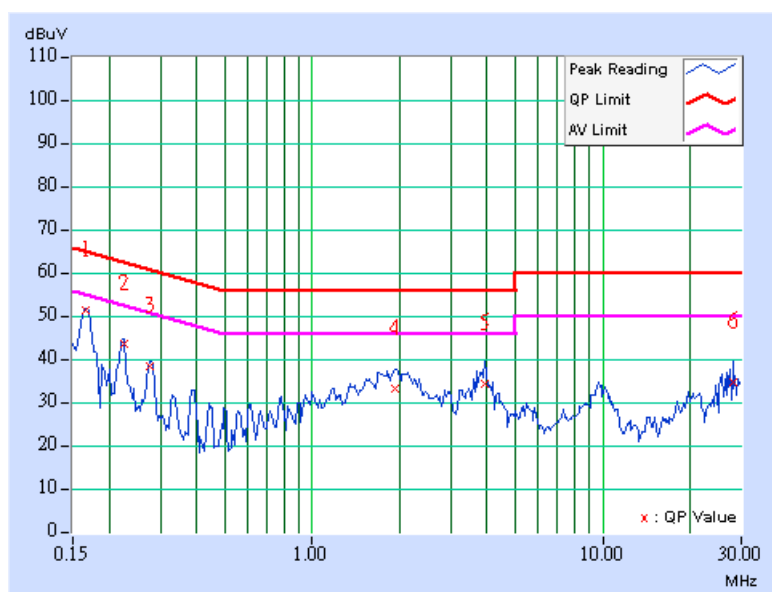

4.2 RADIATED EMISSION MEASUREMENT

4.2.1 LIMITS OF RADIATED EMISSION MEASUREMENT

According to 15.249 the field strength of emissions from intentional radiators operated under these frequencies bands shall not exceed the following:

Fundamental Frequency (MHz)	Field Strength of Fundamental (dBuV/m)	
	Peak	Average
2400 ~ 2483.5	114	94
	Field Strength of Harmonics (dBuV/m)	
	74	54

Emissions radiated outside of the specified frequency bands, except for harmonics, shall be attenuated by at least 50 dB below the level of the fundamental or to the general radiated emission limits in Section 15.209, whichever is the lesser attenuation.

Emissions radiated outside of the specified bands, shall be according to the general radiated limits in 15.209 as following:

Frequencies (MHz)	Field strength (microvolts/meter)	Measurement distance (meters)
0.009-0.490	2400/F(kHz)	300
0.490-1.705	24000/F(kHz)	30
1.705-30.0	30	30
30-88	100	3
88-216	150	3
216-960	200	3
Above 960	500	3

As shown in 15.35(b), for frequencies above 1000MHz, the field strength limits are based on average detector, however, the peak field strength of any emission shall not exceed the maximum permitted average limits, specified above by more than 20dB under any condition of modulation.

4.2.2 TEST INSTRUMENTS

DESCRIPTION & MANUFACTURER	MODEL NO.	SERIAL NO.	CALIBRATED UNTIL
ADVANTEST Spectrum Analyzer	R3271A	85060311	July 15, 2008
HP Pre_Amplifier	8449B	3008A01922	Oct. 04, 2008
ROHDE & SCHWARZ Test Receiver	ESCS30	100375	Mar. 26, 2008
CHASE Broadband Antenna	VULB 9168	138	July 26, 2008
Schwarzbeck Horn_Antenna	BBHA9120	D124	Dec. 16, 2008
Schwarzbeck Horn_Antenna	BBHA 9170	BBHA9170153	Jan. 25, 2009
TRILOG Broad Band Antenna	VULB 9168	138	July 26, 2008
RF Switches (ARNITSU)	CS-201	1565157	Aug. 13, 2008
RF CABLE (Chaintek)	SF102	22054-2	Dec. 06, 2008
RF Cable(RICHTEC)	9913-30M N-N Cable	STCCAB-30M-1 GHz	Aug. 13, 2008
Software	ADT_Radiated_V 7.6.15.8	NA	NA
CHANCE MOST Antenna Tower	AT-100	0203	NA
CHANCE MOST Turn Table	TT-100	0203	NA

- Note: 1. The calibration interval of the above test instruments is 12 months and the calibrations are traceable to NML/ROC and NIST/USA.
2. The horn antenna, HP preamplifier (model: 8449B) and Spectrum Analyzer (model: R3271A) are used only for the measurement of emission frequency above 1GHz if tested.
3. The test was performed in ADT Open Site No. C.
4. The FCC Site Registration No. is 656396.
5. The VCCI Site Registration No. is R-1626.
6. The CANADA Site Registration No. is IC 4824A-3.
7. The following table is for the measurement uncertainty, which is calculated as per the document CISPR 16-4. This uncertainty represents an expanded uncertainty expressed at approximately the 95% confidence level using a coverage factor of k=2.

Measurement	Value
Radiated emissions (30MHz-1GHz)	3.94 dB
Radiated emissions (1GHz ~18GHz)	2.33 dB
Radiated emissions (18GHz ~40GHz)	2.55 dB

4.2.3 TEST PROCEDURES

- a. The EUT was placed on the top of a rotating table 0.8 meters above the ground at a 10 meter open area test site. The table was rotated 360 degrees to determine the position of the highest radiation.
- b. The EUT was set 3 meters away from the interference-receiving antenna, which was mounted on the top of a variable-height antenna tower.
- c. The antenna is a broadband antenna, and its height is varied from one meter to four meters above the ground to determine the maximum value of the field strength. Both horizontal and vertical polarizations of the antenna are set to make the measurement.
- d. For each suspected emission, the EUT was arranged to its worst case and then the antenna was tuned to heights from 1 meter to 4 meters and the rotatable table was turned from 0 degrees to 360 degrees to find the maximum reading.
- e. The test-receiver system was set to Peak Detect Function and Specified Bandwidth with Maximum Hold Mode.
- f. If the emission level of the EUT in peak mode was 10 dB lower than the limit specified, then testing could be stopped and the peak values of the EUT would be reported. Otherwise the emissions that did not have 10 dB margin would be re-tested one by one using peak, quasi-peak or average method as specified and then reported in a data sheet.

NOTE:

1. The resolution bandwidth and video bandwidth of test receiver/spectrum analyzer is 120kHz for Peak detection (PK) and Quasi-peak detection (QP) at frequency below 1GHz.
2. The resolution bandwidth is 1MHz and video bandwidth of test receiver/spectrum analyzer is 3MHz for Peak detection at frequency above 1GHz. The resolution bandwidth of test receiver/spectrum analyzer is 1 MHz for Average detection (AV) at frequency above 1GHz.
3. The resolution bandwidth of test receiver/spectrum analyzer is 1 MHz and the video bandwidth is 10 Hz for Average detection (AV) at frequency above 1GHz.

4.2.4 DEVIATION FROM TEST STANDARD

No deviation

4.2.5 TEST SETUP

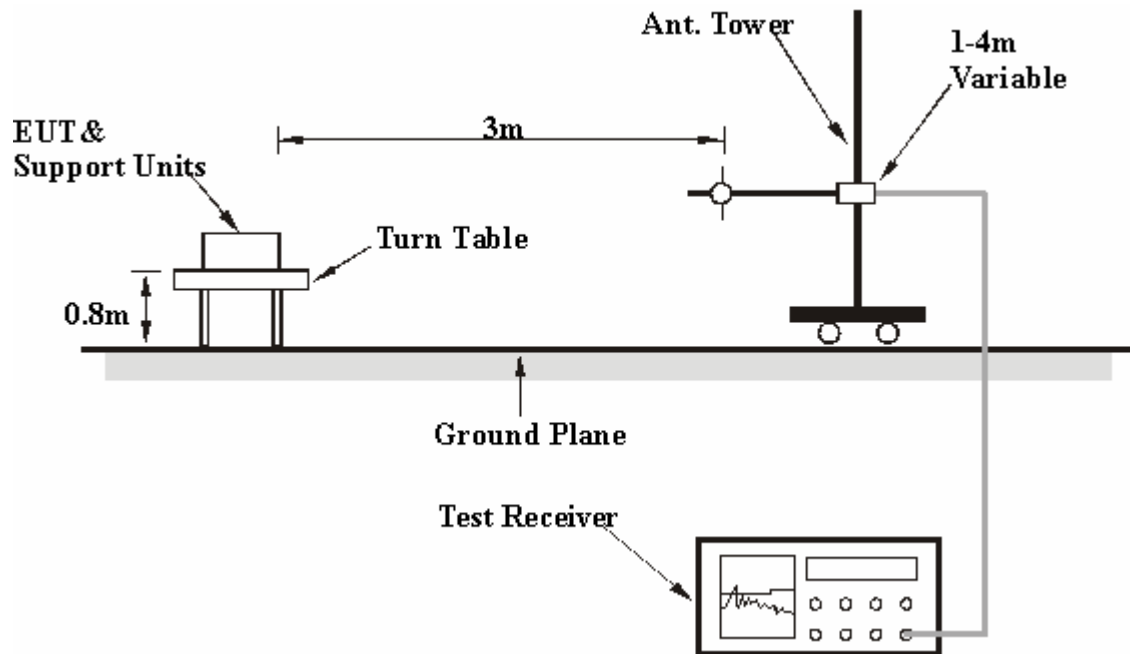

For the actual test configuration, please refer to the related item – Photographs of the Test Configuration.

4.2.6 EUT OPERATING CONDITIONS

Set the EUT under transmission/ receiver condition continuously at specific channel frequency.

4.2.7 TEST RESULTS

MODE	Channel 0	INPUT POWER	120Vac, 60 Hz
FREQUENCY RANGE	30-1000 MHz	DETECTOR FUNCTION & BANDWIDTH	Quasi-Peak, 120kHz
ENVIRONMENTAL CONDITIONS	16 deg. C, 62%RH, 971 hPa	TESTED BY	Phoenix Huang

ANTENNA POLARITY & TEST DISTANCE: HORIZONTAL AT 3 M								
No.	Freq. (MHz)	Emission Level (dBuV/m)	Limit (dBuV/m)	Margin (dB)	Antenna Height (m)	Table Angle (Degree)	Raw Value (dBuV)	Correction Factor (dB/m)
1	50.06	32.64 QP	40.00	-7.36	1.81 H	233	16.71	15.93
2	131.31	38.97 QP	43.50	-4.53	1.44 H	260	25.29	13.68
3	140.11	36.86 QP	43.50	-6.64	1.13 H	322	22.54	14.32
4	160.01	32.19 QP	43.50	-11.31	1.76 H	329	16.94	15.25
5	200.35	25.23 QP	43.50	-18.27	1.29 H	238	13.19	12.04
6	400.00	29.09 QP	46.00	-16.91	1.34 H	160	11.04	18.05
7	663.25	35.69 QP	46.00	-10.31	1.16 H	275	11.21	24.48
8	732.00	36.69 QP	46.00	-9.31	1.08 H	54	10.42	26.27
9	800.70	33.37 QP	46.00	-12.63	1.00 H	21	5.31	28.06
10	960.00	31.86 QP	46.00	-14.14	1.00 H	164	2.19	29.67

ANTENNA POLARITY & TEST DISTANCE: VERTICAL AT 3 M								
No.	Freq. (MHz)	Emission Level (dBuV/m)	Limit (dBuV/m)	Margin (dB)	Antenna Height (m)	Table Angle (Degree)	Raw Value (dBuV)	Correction Factor (dB/m)
1	53.52	34.76 QP	40.00	-5.24	1.00 V	22	19.58	15.18
2	131.87	35.88 QP	43.50	-7.62	1.00 V	181	22.16	13.72
3	160.00	31.97 QP	43.50	-11.53	1.00 V	101	16.72	15.25
4	180.00	30.85 QP	43.50	-12.65	1.00 V	23	17.52	13.33
5	480.30	33.24 QP	46.00	-12.76	1.00 V	39	12.65	20.59
6	520.00	33.94 QP	46.00	-12.06	1.00 V	317	12.96	20.98
7	720.00	36.88 QP	46.00	-9.12	1.61 V	16	11.26	25.62
8	801.80	37.63 QP	46.00	-8.37	1.62 V	291	9.56	28.07
9	959.82	34.71 QP	46.00	-11.29	1.47 V	256	5.05	29.66

- REMARKS:**
1. Emission level(dBuV/m)=Raw Value(dBuV) + Correction Factor(dB/m)
 2. Correction Factor(dB/m) = Antenna Factor (dB/m) + Cable Factor (dB)
 3. The other emission levels were very low against the limit.
 4. Margin value = Emission level – Limit value.

MODE	Channel 0	INPUT POWER	120Vac, 60 Hz
FREQUENCY RANGE	1000~25000MHz	DETECTOR FUNCTION & BANDWIDTH	Peak (PK) Average (AV) 1 MHz
ENVIRONMENTAL CONDITIONS	16 deg. C, 78%RH, 971 hPa	TESTED BY	Phoenix Huang

ANTENNA POLARITY & TEST DISTANCE: HORIZONTAL AT 3 M

No.	Freq. (MHz)	Emission Level (dBuV/m)	Limit (dBuV/m)	Margin (dB)	Antenna Height (m)	Table Angle (Degree)	Raw Value (dBuV)	Correction Factor (dB/m)
1	2352.00	61.70 PK	74.00	-12.30	1.33 H	10	31.48	30.22
2	2352.00	45.29 AV	54.00	-8.71	1.33 H	10	15.07	30.22
3	*2402.00	97.50 PK	114.00	-16.50	1.32 H	11	67.05	30.45
4	*2402.00	76.20 AV	94.00	-17.80	1.32 H	11	45.75	30.45
5	4804.00	51.20 PK	74.00	-22.80	1.51 H	7	15.55	35.65
6	4804.00	29.90 AV	54.00	-24.10	1.51 H	7	-5.75	35.65
7	7206.00	57.04 PK	74.00	-16.96	1.77 H	321	14.91	42.13
8	7206.00	35.74 AV	54.00	-18.26	1.77 H	321	-6.39	42.13

ANTENNA POLARITY & TEST DISTANCE: VERTICAL AT 3 M

No.	Freq. (MHz)	Emission Level (dBuV/m)	Limit (dBuV/m)	Margin (dB)	Antenna Height (m)	Table Angle (Degree)	Raw Value (dBuV)	Correction Factor (dB/m)
1	2351.90	65.39 PK	74.00	-8.61	1.07 V	257	35.17	30.22
2	2351.90	47.16 AV	54.00	-6.84	1.07 V	257	16.94	30.22
3	*2402.00	100.00 PK	114.00	-14.00	1.07 V	258	69.55	30.45
4	*2402.00	78.70 AV	94.00	-15.30	1.07 V	258	48.25	30.45
5	4804.00	55.80 PK	74.00	-18.20	1.25 V	79	20.15	35.65
6	4804.00	34.50 AV	54.00	-19.50	1.25 V	79	-1.15	35.65
7	7206.00	54.40 PK	74.00	-19.60	1.43 V	287	12.27	42.13
8	7206.00	33.10 AV	54.00	-20.90	1.43 V	287	-9.03	42.13

REMARKS:

1. Emission level(dBuV/m)=Raw Value(dBuV) + Correction Factor(dB/m)
2. Correction Factor(dB/m) = Antenna Factor (dB/m) + Cable Factor (dB)
3. Margin value = Emission level - Limit value
4. “ * “ : Fundamental frequency
5. The other emission levels were very low against the limit.

MODE	Channel 39	INPUT POWER	120Vac, 60 Hz
FREQUENCY RANGE	1000~25000MHz	DETECTOR FUNCTION & BANDWIDTH	Peak (PK) Average (AV) 1 MHz
ENVIRONMENTAL CONDITIONS	16 deg. C, 78%RH, 971 hPa	TESTED BY	Phoenix Huang

ANTENNA POLARITY & TEST DISTANCE: HORIZONTAL AT 3 M

No.	Freq. (MHz)	Emission Level (dBuV/m)	Limit (dBuV/m)	Margin (dB)	Antenna Height (m)	Table Angle (Degree)	Raw Value (dBuV)	Correction Factor (dB/m)
1	*2441.00	96.90 PK	114.00	-17.10	1.34 H	10	66.28	30.62
2	*2441.00	75.60 AV	94.00	-18.40	1.34 H	10	44.98	30.62
3	4882.00	49.70 PK	74.00	-24.30	1.03 H	3	13.89	35.81
4	4882.00	28.40 AV	54.00	-25.60	1.03 H	3	-7.41	35.81
5	7323.00	60.90 PK	74.00	-13.10	1.29 H	304	18.34	42.56
6	7323.00	39.60 AV	54.00	-14.40	1.29 H	304	-2.96	42.56

ANTENNA POLARITY & TEST DISTANCE: VERTICAL AT 3 M

No.	Freq. (MHz)	Emission Level (dBuV/m)	Limit (dBuV/m)	Margin (dB)	Antenna Height (m)	Table Angle (Degree)	Raw Value (dBuV)	Correction Factor (dB/m)
1	*2441.00	100.10 PK	114.00	-13.90	1.09 V	259	69.48	30.62
2	*2441.00	78.80 AV	94.00	-15.20	1.09 V	259	48.18	30.62
3	4882.00	53.24 PK	74.00	-20.76	1.36 V	72	17.43	35.81
4	4882.00	31.94 AV	54.00	-22.06	1.36 V	72	-3.87	35.81
5	7323.00	59.40 PK	74.00	-14.60	1.33 V	162	16.84	42.56
6	7323.00	38.10 AV	54.00	-15.90	1.33 V	162	-4.46	42.56

REMARKS:

1. Emission level(dBuV/m)=Raw Value(dBuV) + Correction Factor(dB/m)
2. Correction Factor(dB/m) = Antenna Factor (dB/m) + Cable Factor (dB)
3. Margin value = Emission level - Limit value
4. " * " : Fundamental frequency
5. The other emission levels were very low against the limit.

MODE	Channel 79	INPUT POWER	120Vac, 60 Hz
FREQUENCY RANGE	1000~25000MHz	DETECTOR FUNCTION & BANDWIDTH	Peak (PK) Average (AV) 1 MHz
ENVIRONMENTAL CONDITIONS	16 deg. C, 78%RH, 971 hPa	TESTED BY	Phoenix Huang

ANTENNA POLARITY & TEST DISTANCE: HORIZONTAL AT 3 M

No.	Freq. (MHz)	Emission Level (dBuV/m)	Limit (dBuV/m)	Margin (dB)	Antenna Height (m)	Table Angle (Degree)	Raw Value (dBuV)	Correction Factor (dB/m)
1	*2481.00	81.13 PK	114.00	-32.87	1.08 H	260	50.33	30.80
2	*2481.00	59.83 AV	94.00	-34.17	1.08 H	260	29.03	30.80
3	2483.50	57.66 PK	74.00	-16.34	1.24 H	10	26.84	30.82
4	2483.50	46.45 AV	54.00	-7.55	1.24 H	10	15.63	30.82
5	4962.00	51.90 PK	74.00	-22.10	1.50 H	107	15.92	35.98
6	4962.00	30.60 AV	54.00	-23.40	1.50 H	107	-5.38	35.98
7	7443.00	63.92 PK	74.00	-10.08	1.13 H	256	20.91	43.01
8	7443.00	42.62 AV	54.00	-11.38	1.13 H	256	-0.39	43.01

ANTENNA POLARITY & TEST DISTANCE: VERTICAL AT 3 M

No.	Freq. (MHz)	Emission Level (dBuV/m)	Limit (dBuV/m)	Margin (dB)	Antenna Height (m)	Table Angle (Degree)	Raw Value (dBuV)	Correction Factor (dB/m)
1	*2481.00	89.60 PK	114.00	-24.40	1.02 V	261	58.80	30.80
2	*2481.00	68.30 AV	94.00	-25.70	1.02 V	261	37.50	30.80
3	2483.50	65.06 PK	74.00	-8.94	1.03 V	261	34.24	30.82
4	2483.50	50.54 AV	54.00	-3.46	1.03 V	261	19.72	30.82
5	4962.00	48.30 PK	74.00	-25.70	1.41 V	0	12.32	35.98
6	4962.00	27.00 AV	54.00	-27.00	1.41 V	0	-8.98	35.98
7	7443.00	65.00 PK	74.00	-9.00	1.15 V	327	21.99	43.01
8	7443.00	43.70 AV	54.00	-10.30	1.15 V	327	0.69	43.01

REMARKS:

1. Emission level(dBuV/m)=Raw Value(dBuV) + Correction Factor(dB/m)
2. Correction Factor(dB/m) = Antenna Factor (dB/m) + Cable Factor (dB)
3. Margin value = Emission level - Limit value
4. “ * “ : Fundamental frequency
5. The other emission levels were very low against the limit.

4.3 BAND EDGES MEASUREMENT

4.3.1 LIMITS OF BAND EDGES MEASUREMENT

Emissions radiated outside of the specified frequency bands, except for harmonics, shall be attenuated by at least 50 dB below the level of the fundamental or to the general radiated emission limits in Section 15.209, whichever is the lesser attenuation.

4.3.2 TEST INSTRUMENTS

Description & Manufacturer	Model No.	Serial No.	Calibrated Until
R&S SPECTRUM ANALYZER	FSP40	100037	Aug. 12, 2008

NOTE:

- 1.The measurement uncertainty is less than +/- 2.6dB, which is calculated as per the NAMAS document NIS81.
- 2.The calibration interval of the above test instruments is 12 months and the calibrations are traceable to NML/ROC and NIST/USA.

4.3.3 TEST PROCEDURE

The transmitter output was connected to the spectrum analyzer via a low lose cable. Set RBW of spectrum analyzer to 100 kHz and VBW of spectrum analyzer to 300 kHz with suitable frequency span including 100 MHz bandwidth from band edge. The band edges was measured and recorded.

4.3.4 DEVIATION FROM TEST STANDARD

No deviation

4.3.5 EUT OPERATING CONDITION

The software provided by client enabled the EUT to transmit and receive data at lowest, middle and highest channel frequencies individually.

4.3.6 TEST RESULTS

Emissions radiated outside of the specified frequency bands, please refer pages form 19 to 21 for met the requirement of the general radiated emission limits in § 15.209.
CH0

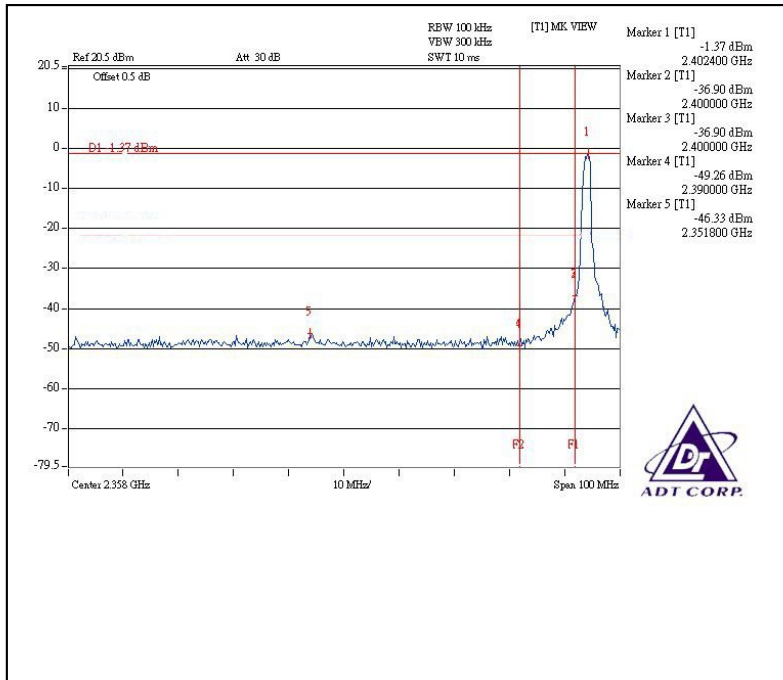

CH79

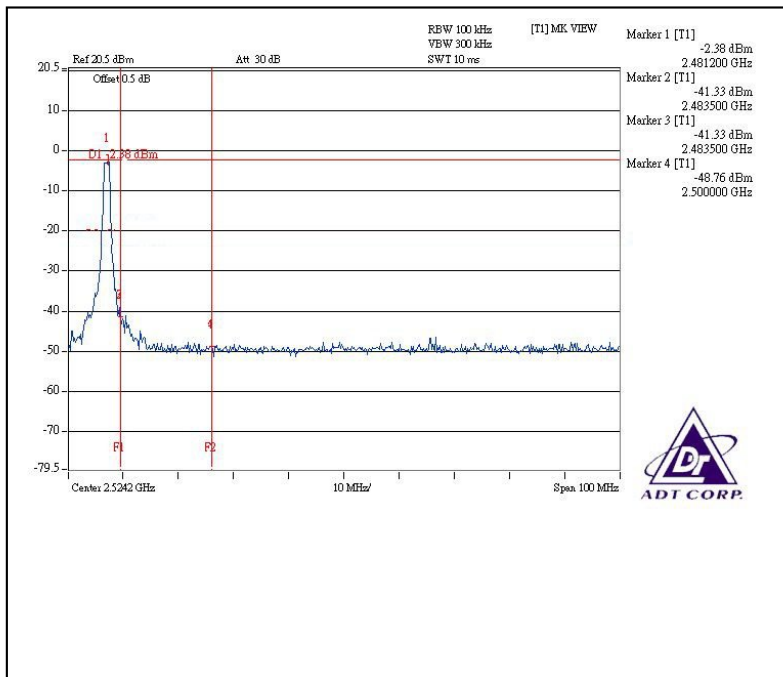

CH0

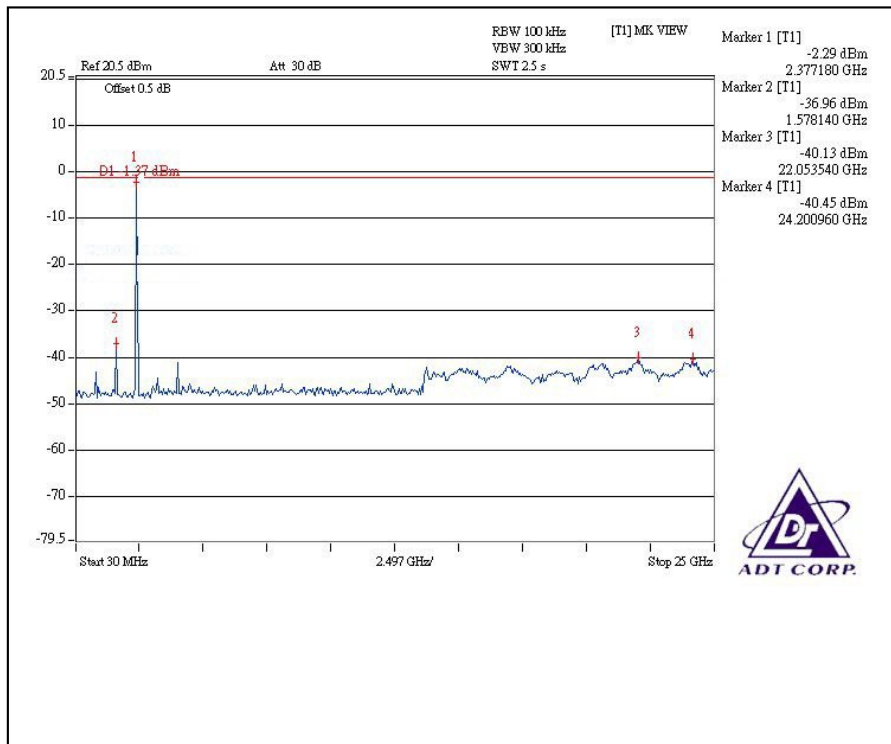

CH79

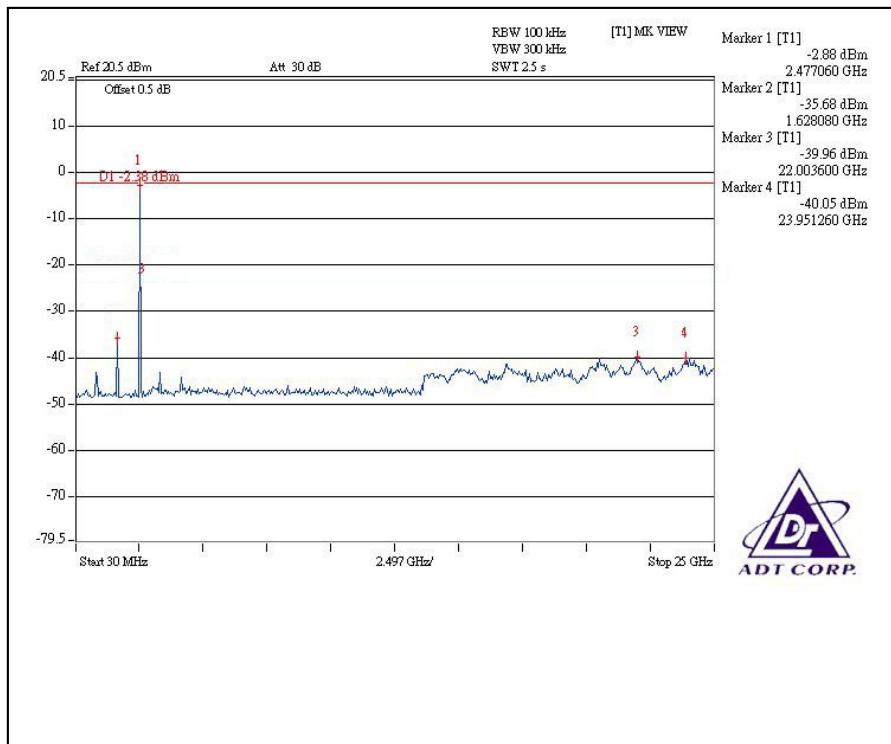

5 INFORMATION ON THE TESTING LABORATORIES

We, ADT Corp., were founded in 1988 to provide our best service in EMC, Radio, Telecom and Safety consultation. Our laboratories are accredited and approved by the following approval agencies according to ISO/IEC 17025:

USA	FCC, UL, A2LA
Germany	TUV Rheinland
Japan	VCCI
Norway	NEMKO
Canada	INDUSTRY CANADA, CSA
R.O.C.	TAF, BSMI, NCC
Netherlands	Telefication
Singapore	GOST-ASIA (MOU)
Russia	CERTIS (MOU)

Copies of accreditation certificates of our laboratories obtained from approval agencies can be downloaded from our web site: www.adt.com.tw/index.5/phtml.

If you have any comments, please feel free to contact us at the following:

Linko EMC/RF Lab:

Tel: 886-2-26052180

Fax: 886-2-26052943

Hsin Chu EMC/RF Lab:

Tel: 886-3-5935343

Fax: 886-3-5935342

Hwa Ya EMC/RF/Safety/Telecom Lab:

Tel: 886-3-3183232

Fax: 886-3-3185050

Email: service@adt.com.tw

Web Site: www.adt.com.tw

The address and road map of all our labs can be found in our web site also.

6 APPENDIX-A- MODIFICATIONS RECORDERS FOR ENGINEERING CHANGES TO THE EUT BY THE LAB

No any modifications are made to the EUT by the lab during the test.