

## FCC Test Report (BT-LE)

**Report No.:** RF200615E03-1

**FCC ID:** JNZCU0021

**Test Model:** CU0021

**Received Date:** June 15, 2020

**Test Date:** July 02 to 20, 2020

**Issued Date:** Aug. 07, 2020

**Applicant:** LOGITECH FAR EAST LTD.

**Address:** #2 Creation Rd. 4, Science-Based Ind. Park Hsinchu Taiwan, R.O.C.

**Issued By:** Bureau Veritas Consumer Products Services (H.K.) Ltd., Taoyuan Branch  
Hsin Chu Laboratory

**Lab Address:** E-2, No.1, Li Hsin 1st Road, Hsinchu Science Park, Hsinchu City 300,  
Taiwan

**Test Location:** E-2, No.1, Li Hsin 1st Road, Hsinchu Science Park, Hsinchu City 300,  
Taiwan

**FCC Registration /  
Designation Number:** 723255 / TW2022



This report is for your exclusive use. Any copying or replication of this report to or for any other person or entity, or use of our name or trademark, is permitted only with our prior written permission. This report sets forth our findings solely with respect to the test samples identified herein. The results set forth in this report are not indicative or representative of the quality or characteristics of the lot from which a test sample was taken or any similar or identical product unless specifically and expressly noted. Our report includes all of the tests requested by you and the results thereof based upon the information that you provided to us. You have 60 days from date of issuance of this report to notify us of any material error or omission caused by our negligence, provided, however, that such notice shall be in writing and shall specifically address the issue you wish to raise. A failure to raise such issue within the prescribed time shall constitute your unqualified acceptance of the completeness of this report, the tests conducted and the correctness of the report contents. Unless specific mention, the uncertainty of measurement has been explicitly taken into account to declare the compliance or non-compliance to the specification.

## Table of Contents

<b>Release Control Record</b> .....	<b>4</b>
<b>1 Certificate of Conformity</b> .....	<b>5</b>
<b>2 Summary of Test Results</b> .....	<b>6</b>
2.1 Measurement Uncertainty .....	6
2.2 Modification Record .....	6
<b>3 General Information</b> .....	<b>7</b>
3.1 General Description of EUT (BT-LE) .....	7
3.2 Description of Test Modes .....	8
3.2.1 Test Mode Applicability and Tested Channel Detail .....	9
3.3 Duty Cycle of Test Signal .....	11
3.4 Description of Support Units .....	12
3.4.1 Configuration of System under Test .....	12
3.5 General Description of Applied Standards and references .....	13
<b>4 Test Types and Results</b> .....	<b>14</b>
4.1 Radiated Emission and Bandedge Measurement .....	14
4.1.1 Limits of Radiated Emission and Bandedge Measurement .....	14
4.1.2 Test Instruments .....	15
4.1.3 Test Procedures .....	17
4.1.4 Deviation from Test Standard .....	17
4.1.5 Test Setup .....	18
4.1.6 EUT Operating Conditions .....	19
4.1.7 Test Results .....	20
4.2 Conducted Emission Measurement .....	28
4.2.1 Limits of Conducted Emission Measurement .....	28
4.2.2 Test Instruments .....	28
4.2.3 Test Procedures .....	29
4.2.4 Deviation from Test Standard .....	29
4.2.5 Test Setup .....	29
4.2.6 EUT Operating Conditions .....	29
4.2.7 Test Results .....	30
4.3 6dB Bandwidth Measurement .....	32
4.3.1 Limits of 6dB Bandwidth Measurement .....	32
4.3.2 Test Setup .....	32
4.3.3 Test Instruments .....	32
4.3.4 Test Procedure .....	32
4.3.5 Deviation from Test Standard .....	32
4.3.6 EUT Operating Conditions .....	32
4.3.7 Test Result .....	33
4.4 Conducted Output Power Measurement .....	35
4.4.1 Limits of Conducted Output Power Measurement .....	35
4.4.2 Test Setup .....	35
4.4.3 Test Instruments .....	35
4.4.4 Test Procedures .....	35
4.4.5 Deviation from Test Standard .....	35
4.4.6 EUT Operating Conditions .....	35
4.4.7 Test Results .....	36
4.5 Power Spectral Density Measurement .....	37
4.5.1 Limits of Power Spectral Density Measurement .....	37
4.5.2 Test Setup .....	37
4.5.3 Test Instruments .....	37
4.5.4 Test Procedure .....	37
4.5.5 Deviation from Test Standard .....	37
4.5.6 EUT Operating Condition .....	37

4.5.7 Test Results .....	38
4.6 Conducted Out of Band Emission Measurement .....	40
4.6.1 Limits of Conducted Out of Band Emission Measurement.....	40
4.6.2 Test Setup.....	40
4.6.3 Test Instruments .....	40
4.6.4 Test Procedure .....	40
4.6.5 Deviation from Test Standard .....	40
4.6.6 EUT Operating Condition .....	40
4.6.7 Test Results .....	40
<b>5 Pictures of Test Arrangements.....</b>	<b>43</b>
<b>Annex A - Band-Edge Measurement.....</b>	<b>44</b>
<b>Appendix – Information of the Testing Laboratories .....</b>	<b>46</b>

### Release Control Record

Issue No.	Description	Date Issued
RF200615E03-1	Original release.	Aug. 07, 2020

## 1 Certificate of Conformity

**Product:** Wireless USB dongle

**Brand:** Logitech

**Test Model:** CU0021

**Sample Status:** ENGINEERING SAMPLE

**Applicant:** LOGITECH FAR EAST LTD.

**Test Date:** July 02 to 20, 2020

**Standards:** 47 CFR FCC Part 15, Subpart C (Section 15.247)  
ANSI C63.10: 2013

The above equipment has been tested by **Bureau Veritas Consumer Products Services (H.K.) Ltd., Taoyuan Branch**, and found compliance with the requirement of the above standards. The test record, data evaluation & Equipment Under Test (EUT) configurations represented herein are true and accurate accounts of the measurements of the sample's EMC characteristics under the conditions specified in this report.

**Prepared by :** Vivian Huang , **Date:** Aug. 07, 2020  
Vivian Huang / Specialist

**Approved by :** Clark Lin , **Date:** Aug. 07, 2020  
Clark Lin / Technical Manager

## 2 Summary of Test Results

47 CFR FCC Part 15, Subpart C (SECTION 15.247)			
FCC Clause	Test Item	Result	Remarks
15.207	AC Power Conducted Emission	PASS	Meet the requirement of limit. Minimum passing margin is -15.50dB at 0.43125MHz.
15.205 & 209 & 15.247(d)	Radiated Emissions & Band Edge Measurement	PASS	Meet the requirement of limit. Minimum passing margin is -4.5dB at 7440.00MHz.
15.247(d)	Antenna Port Emission	PASS	Meet the requirement of limit.
15.247(a)(2)	6dB bandwidth	PASS	Meet the requirement of limit.
15.247(b)	Conducted power	PASS	Meet the requirement of limit.
15.247(e)	Power Spectral Density	PASS	Meet the requirement of limit.
15.203	Antenna Requirement	PASS	No antenna connector is used.

### Note:

- For 2.4 GHz band compliance with rule 15.247(d) of the band-edge items, the test plots were recorded in Annex A.
- Determining compliance based on the results of the compliance measurement, not taking into account measurement instrumentation uncertainty.

### 2.1 Measurement Uncertainty

Where relevant, the following measurement uncertainty levels have been estimated for tests performed on the EUT as specified in CISPR 16-4-2:

Measurement	Frequency	Expanded Uncertainty (k=2) ( $\pm$ )
Conducted Emissions at mains ports	150kHz ~ 30MHz	1.9 dB
Conducted Emissions	-	2.5 dB
Radiated Emissions up to 1 GHz	9kHz ~ 30MHz	3.1 dB
	30MHz ~ 1GHz	5.5 dB
Radiated Emissions above 1 GHz	1GHz ~ 18GHz	5.1 dB
	18GHz ~ 40GHz	5.3 dB

### 2.2 Modification Record

There were no modifications required for compliance.

### 3 General Information

#### 3.1 General Description of EUT (BT-LE)

Product	Wireless USB dongle
Brand	Logitech
Test Model	CU0021
Status of EUT	ENGINEERING SAMPLE
Power Supply Rating	5Vdc from USB interface
Modulation Type	GFSK
Modulation Technology	DTS
Transfer Rate	<b>BT-LE:</b> Up to 2Mbps (*Note 1)
Operating Frequency	<b>BT-LE:</b> 2402MHz ~ 2480MHz (*Note 1)
Number of Channel	<b>BT-LE:</b> 40 (*Note 1)
Output Power	<b>BT-LE 1M:</b> 5.888 mW <b>BT-LE 2M:</b> 5.875 mW
Antenna Type	Refer to Note
Antenna Connector	Refer to Note
Accessory Device	NA
Cable Supplied	NA

Note:

1. BT-LE technique supports 1Mbps and 2Mbps data rates, both have been evaluated in this test report. Refer to "**section 3.2 Description of Test Modes**" for more detail specification.
2. The antenna provided to the EUT, please refer to the following table:

Antenna Gain (dBi)	Frequency Range (GHz)	Antenna Type	Connector Type
-3	2.4-2.4835	PIFA	None

3. The device of Bluetooth and GFSK modulation type can't transmit simultaneously.
4. The above EUT information is declared by manufacturer and for more detailed features description, please refers to the manufacturer's specifications or user's manual.
5. The above Antenna information is declared by manufacturer and for more detailed features description, please refer to the manufacturer's specifications, the laboratory shall not be held responsible.

### 3.2 Description of Test Modes

40 channels are provided to this EUT:

RF Channel	RF Center Frequency	Channel Index	Channels Type for BT 5.x		Channels Type for BT 4.x
			Maximum Data Rate 2Mbps	Maximum Data Rate 1Mbps	Maximum Data Rate 1Mbps
0	2402 MHz	37		●	●
1	2404 MHz	0	●		●
2	2406 MHz	1	●		●
3	2408 MHz	2	●		●
4	2410 MHz	3	●		●
5	2412 MHz	4	●		●
6	2414 MHz	5	●		●
7	2416 MHz	6	●		●
8	2418 MHz	7	●		●
9	2420 MHz	8	●		●
10	2422 MHz	9	●		●
11	2424 MHz	10	●		●
12	2426 MHz	38		●	●
13	2428 MHz	11	●		●
14	2430 MHz	12	●		●
15	2432 MHz	13	●		●
16	2434 MHz	14	●		●
17	2436 MHz	15	●		●
18	2438 MHz	16	●		●
19	2440 MHz	17	●		●
20	2442 MHz	18	●		●
21	2444 MHz	19	●		●
22	2446 MHz	20	●		●
23	2448 MHz	21	●		●
24	2450 MHz	22	●		●
25	2452 MHz	23	●		●
26	2454 MHz	24	●		●
27	2456 MHz	25	●		●
28	2458 MHz	26	●		●
29	2460 MHz	27	●		●
30	2462 MHz	28	●		●
31	2464 MHz	29	●		●
32	2466 MHz	30	●		●
33	2468 MHz	31	●		●
34	2470 MHz	32	●		●
35	2472 MHz	33	●		●
36	2474 MHz	34	●		●
37	2476 MHz	35	●		●
38	2478 MHz	36	●		●
39	2480 MHz	39		●	●



### 3.2.1 Test Mode Applicability and Tested Channel Detail

EUT CONFIGURE MODE	APPLICABLE TO				DESCRIPTION
	RE $\geq$ 1G	RE $<$ 1G	PLC	APCM	
-	√	√	√	√	-

Where **RE $\geq$ 1G**: Radiated Emission above 1GHz      **RE $<$ 1G**: Radiated Emission below 1GHz  
**PLC**: Power Line Conducted Emission      **APCM**: Antenna Port Conducted Measurement

**Note:** The EUT had been pre-tested on the positioned of each 3 axis. The worst case was found when positioned on X-plane (below 1GHz) and Z-plane (above 1GHz)

#### **Radiated Emission Test (Above 1GHz):**

- Pre-Scan has been conducted to determine the worst-case mode from all possible combinations between available modulations, data rates and antenna ports (if EUT with antenna diversity architecture).
- Following channel(s) was (were) selected for the final test as listed below.

AVAILABLE CHANNEL	TESTED CHANNEL	MODULATION TYPE	DATA RATE (Mbps)
0 to 39	0, 19, 39	GFSK	1
1 to 38	1, 19, 38	GFSK	2

#### **Radiated Emission Test (Below 1GHz):**

- Pre-Scan has been conducted to determine the worst-case mode from all possible combinations between available modulations, data rates and antenna ports (if EUT with antenna diversity architecture).
- Following channel(s) was (were) selected for the final test as listed below.

AVAILABLE CHANNEL	TESTED CHANNEL	MODULATION TYPE	DATA RATE (Mbps)
1 to 38	19	GFSK	2

#### **Power Line Conducted Emission Test:**

- Pre-Scan has been conducted to determine the worst-case mode from all possible combinations between available modulations, data rates and antenna ports (if EUT with antenna diversity architecture).
- Following channel(s) was (were) selected for the final test as listed below.

AVAILABLE CHANNEL	TESTED CHANNEL	MODULATION TYPE	DATA RATE (Mbps)
1 to 38	19	GFSK	2

**Antenna Port Conducted Measurement:**

- This item includes all test value of each mode, but only includes spectrum plot of worst value of each mode.
- Pre-Scan has been conducted to determine the worst-case mode from all possible combinations between available modulations, data rates and antenna ports (if EUT with antenna diversity architecture).
- Following channel(s) was (were) selected for the final test as listed below.

AVAILABLE CHANNEL	TESTED CHANNEL	MODULATION TYPE	DATA RATE (Mbps)
0 to 39	0, 19, 39	GFSK	1
1 to 38	1, 19, 38	GFSK	2

**Test Condition:**

APPLICABLE TO	ENVIRONMENTAL CONDITIONS	INPUT POWER (System)	TESTED BY
RE $\geq$ 1G	25deg. C, 75%RH	120Vac, 60Hz	Nelson Teng
RE<1G	25deg. C, 65%RH	120Vac, 60Hz	Nelson Teng
PLC	25deg. C, 70%RH	120Vac, 60Hz	Sampson Chen
APCM	25deg. C, 60%RH	120Vac, 60Hz	Jyunchun Lin

### 3.3 Duty Cycle of Test Signal

#### BT-LE 1M

If duty cycle of test signal is < 98%, duty factor shall be considered.

Duty cycle = 0.347 ms/0.996 ms = 0.348, Duty factor =  $10 \cdot \log(1/\text{Duty cycle}) = 4.58 \text{ dB}$

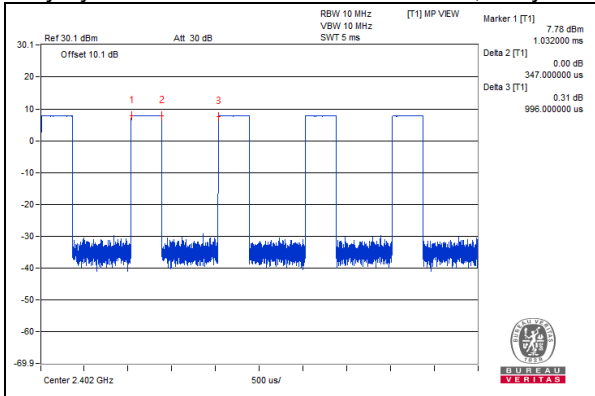

#### BT-LE 2M

If duty cycle of test signal is < 98%, duty factor shall be considered.

Duty cycle = 0.175 ms/1.002 ms = 0.175, Duty factor =  $10 \cdot \log(1/\text{Duty cycle}) = 7.58 \text{ dB}$

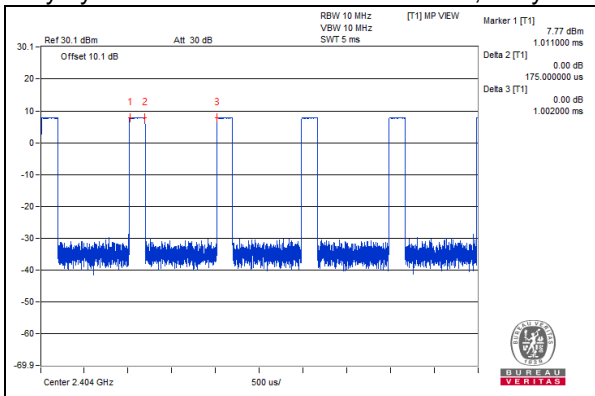

### 3.4 Description of Support Units

The EUT has been tested as an independent unit together with other necessary accessories or support units. The following support units or accessories were used to form a representative test configuration during the tests.

ID	Product	Brand	Model No.	Serial No.	FCC ID	Remarks
A.	Adapter	Lenovo	PA-1450-55LL	NA	NA	Provided by Lab
B.	Laptop	Lenovo	81A4	YD02YN76	NA	Provided by Lab

ID	Descriptions (Cables)	Qty	Length (m)	Shielding (Yes/No)	Cores (Number)	Remarks
1	DC Cable	1	2	No	0	Provided by Lab
2	USB Cable	1	1.5	Yes	0	Provided by Lab

#### 3.4.1 Configuration of System under Test

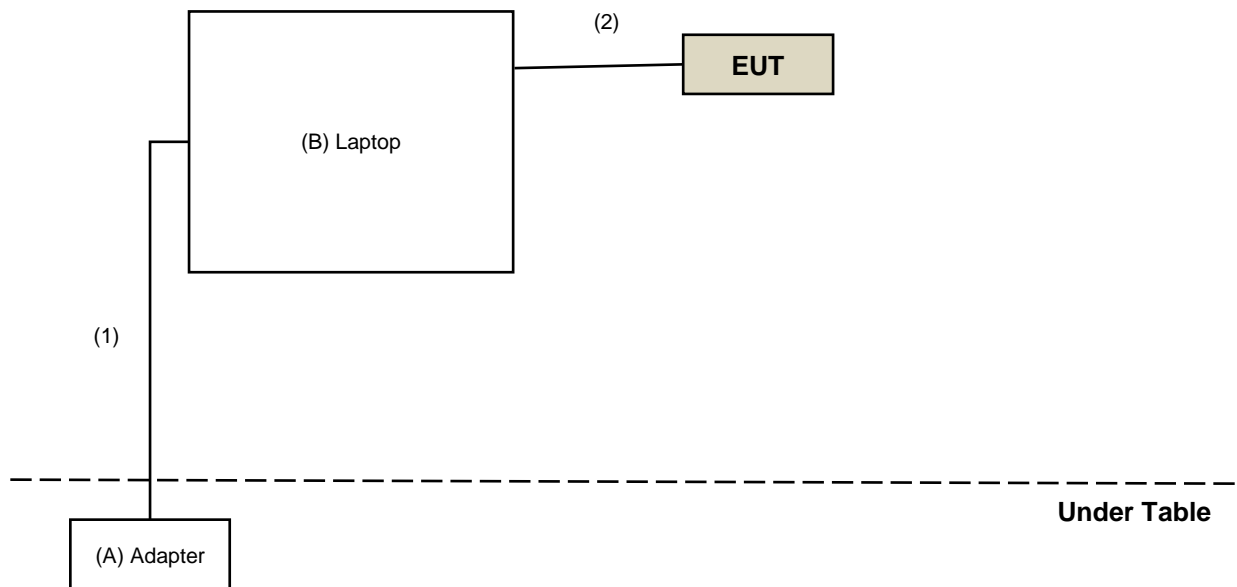

### 3.5 General Description of Applied Standards and references

The EUT is a RF Product. According to the specifications of the manufacturer, it must comply with the requirements of the following standards and references:

**Test standard:**

**FCC Part 15, Subpart C (15.247)**

ANSI C63.10-2013

All test items have been performed and recorded as per the above standards.

**References Test Guidance:**

**KDB 558074 D01 15.247 Meas Guidance v05r02**

All test items have been performed as a reference to the above KDB test guidance.

## 4 Test Types and Results

### 4.1 Radiated Emission and Bandedge Measurement

#### 4.1.1 Limits of Radiated Emission and Bandedge Measurement

Radiated emissions which fall in the restricted bands must comply with the radiated emission limits specified as below table. Other emissions shall be at least 20dB below the highest level of the desired power:

Frequencies (MHz)	Field Strength (microvolts/meter)	Measurement Distance (meters)
0.009 ~ 0.490	2400/F(kHz)	300
0.490 ~ 1.705	24000/F(kHz)	30
1.705 ~ 30.0	30	30
30 ~ 88	100	3
88 ~ 216	150	3
216 ~ 960	200	3
Above 960	500	3

**NOTE:**

1. The lower limit shall apply at the transition frequencies.
2. Emission level (dBuV/m) = 20 log Emission level (uV/m).
3. For frequencies above 1000MHz, the field strength limits are based on average detector, however, the peak field strength of any emission shall not exceed the maximum permitted average limits, specified above by more than 20dB under any condition of modulation.

## 4.1.2 Test Instruments

**Radiated emission & BandEdge test:**

DESCRIPTION & MANUFACTURER	MODEL NO.	SERIAL NO.	CALIBRATED DATE	CALIBRATED UNTIL
Test Receiver Agilent	N9038A	MY51210202	Dec. 13, 2019	Dec. 12, 2020
Pre-Amplifier EMCI	EMC001340	980142	May 25, 2020	May 24, 2021
Loop Antenna Electro-Metrics	EM-6879	264	Feb. 18, 2020	Feb. 17, 2021
RF Cable	NA	LOOPCAB-001	Jan. 08, 2020	Jan. 07, 2021
RF Cable	NA	LOOPCAB-002	Jan. 08, 2020	Jan. 07, 2021
Pre-Amplifier Mini-Circuits	ZFL-1000VH2B	AMP-ZFL-01	Oct. 23, 2019	Oct. 22, 2020
Trilog Broadband Antenna SCHWARZBECK	VULB 9168	9168-406	Nov. 11, 2019	Nov. 10, 2020
RF Cable	8D	966-4-1	Mar. 18, 2020	Mar. 17, 2021
RF Cable	8D	966-4-2	Mar. 18, 2020	Mar. 17, 2021
RF Cable	8D	966-4-3	Mar. 18, 2020	Mar. 17, 2021
Fixed attenuator Mini-Circuits	UNAT-5+	PAD-3m-4-01	Sep. 26, 2019	Sep. 25, 2020
Horn_Antenna SCHWARZBECK	BBHA 9120D	9120D-783	Nov. 24, 2019	Nov. 23, 2020
Pre-Amplifier EMCI	EMC12630SE	980385	Aug. 15, 2019	Aug. 14, 2020
RF Cable	EMC104-SM-SM-1200	160923	Jan. 15, 2020	Jan. 14, 2021
RF Cable	EMC104-SM-SM-2000	180502	Apr. 29, 2020	Apr. 28, 2021
RF Cable	EMC104-SM-SM-6000	180418	Apr. 29, 2020	Apr. 28, 2021
Pre-Amplifier EMCI	EMC184045SE	980387	Jan. 15, 2020	Jan. 14, 2021
Horn_Antenna SCHWARZBECK	BBHA 9170	BBHA9170519	Nov. 24, 2019	Nov. 23, 2020
RF Cable	EMC102-KM-KM-1200	160924	Jan. 15, 2020	Jan. 14, 2021
RF Cable	EMC-KM-KM-4000	200214	Mar. 11, 2020	Mar. 10, 2021
Software	ADT_Radiated_V8.7.08	NA	NA	NA
Boresight Antenna Tower & Turn Table Max-Full	MF-7802BS	MF780208530	NA	NA

**Note:**

1. The calibration interval of the above test instruments is 12 months and the calibrations are traceable to NML/ROC and NIST/USA.
2. The test was performed in 966 Chamber No. 4.
3. Tested Date: July 02 to 20, 2020

**For other test:**

DESCRIPTION & MANUFACTURER	MODEL NO.	SERIAL NO.	CALIBRATED DATE	CALIBRATED UNTIL
Spectrum Analyzer R&S	FSV40	100964	May 29, 2020	May 28, 2021
Power meter Anritsu	ML2495A	1529002	July 26, 2019	July 25, 2020
Power sensor Anritsu	MA2411B	1339443	July 26, 2019	July 25, 2020
Fixed Attenuator Mini-Circuits	MDCS18N-10	MDCS18N-10-01	Apr. 14, 2020	Apr. 13, 2021
Software	ADT_RF Test Software V6.6.5.4	NA	NA	NA

- NOTE:**
1. The test was performed in Oven room 2.
  2. The calibration interval of the above test instruments is 12 months and the calibrations are traceable to NML/ROC and NIST/USA.
  3. Tested Date: July 17, 2020



#### 4.1.3 Test Procedures

##### **For Radiated emission below 30MHz**

- a. The EUT was placed on the top of a rotating table 0.8 meters above the ground at a 3 meter chamber room. The table was rotated 360 degrees to determine the position of the highest radiation.
- b. The EUT was set 3 meters away from the interference-receiving antenna, which was mounted on the top of a variable-height antenna tower.
- c. Parallel, perpendicular, and ground-parallel orientations of the antenna are set to make the measurement.
- d. For each suspected emission, the EUT was arranged to its worst case and the rotatable table was turned from 0 degrees to 360 degrees to find the maximum reading.
- e. The test-receiver system was set to Quasi-Peak Detect Function and Specified Bandwidth with Maximum Hold Mode.

##### **NOTE:**

1. The resolution bandwidth and video bandwidth of test receiver/spectrum analyzer is 9kHz at frequency below 30MHz.

##### **For Radiated emission above 30MHz**

- a. The EUT was placed on the top of a rotating table 0.8 meters (for 30MHz ~ 1GHz) / 1.5 meters (for above 1GHz) above the ground at 3 meter chamber room for test. The table was rotated 360 degrees to determine the position of the highest radiation.
- b. The EUT was set 3 meters away from the interference-receiving antenna, which was mounted on the top of a variable-height antenna tower.
- c. The height of antenna is varied from one meter to four meters above the ground to determine the maximum value of the field strength. Both horizontal and vertical polarizations of the antenna are set to make the measurement.
- d. For each suspected emission, the EUT was arranged to its worst case and then the antenna was tuned to heights from 1 meter to 4 meters and the rotatable table was turned from 0 degrees to 360 degrees to find the maximum reading.
- e. The test-receiver system was set to quasi-peak detect function and specified bandwidth with maximum hold mode when the test frequency is below 1 GHz.
- f. The test-receiver system was set to peak and average detect function and specified bandwidth with maximum hold mode when the test frequency is above 1 GHz. If the peak reading value also meets average limit, measurement with the average detector is unnecessary.

##### **Note:**

1. The resolution bandwidth and video bandwidth of test receiver/spectrum analyzer is 120kHz for Quasi-peak detection (QP) at frequency below 1GHz.
2. The resolution bandwidth of test receiver/spectrum analyzer is 1 MHz and the video bandwidth is 3 MHz for Peak detection (PK) at frequency above 1GHz.
3. The resolution bandwidth of test receiver/spectrum analyzer is 1MHz and the video bandwidth is  $\geq 1/T$  (Duty cycle < 98%) or 10Hz (Duty cycle  $\geq 98\%$ ) for Average detection (AV) at frequency above 1GHz.
4. All modes of operation were investigated and the worst-case emissions are reported.

#### 4.1.4 Deviation from Test Standard

No deviation.

#### 4.1.5 Test Setup

##### For Radiated emission below 30MHz

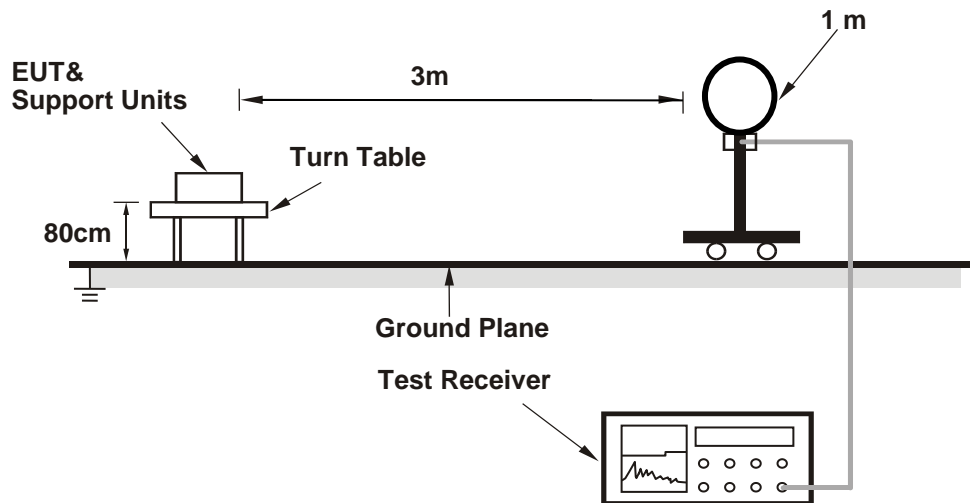

##### For Radiated emission 30MHz to 1GHz

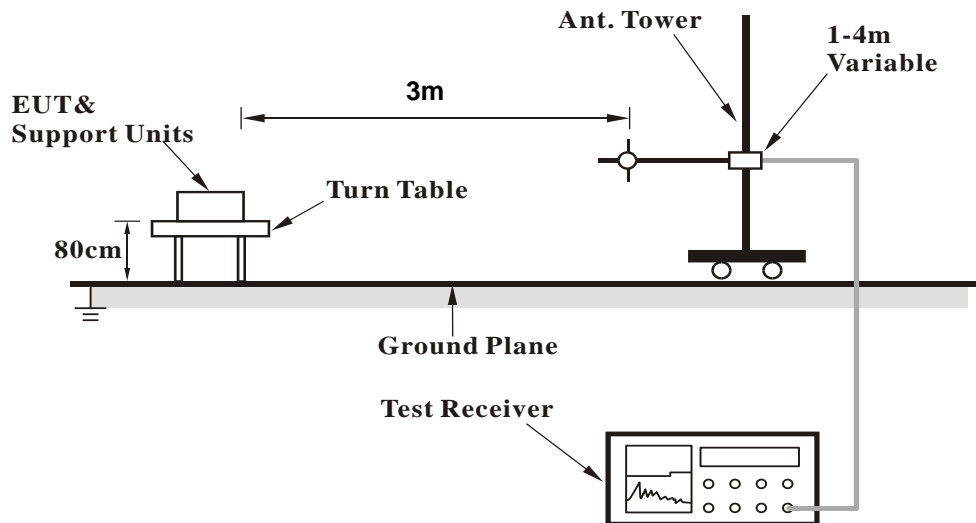

### For Radiated emission above 1GHz

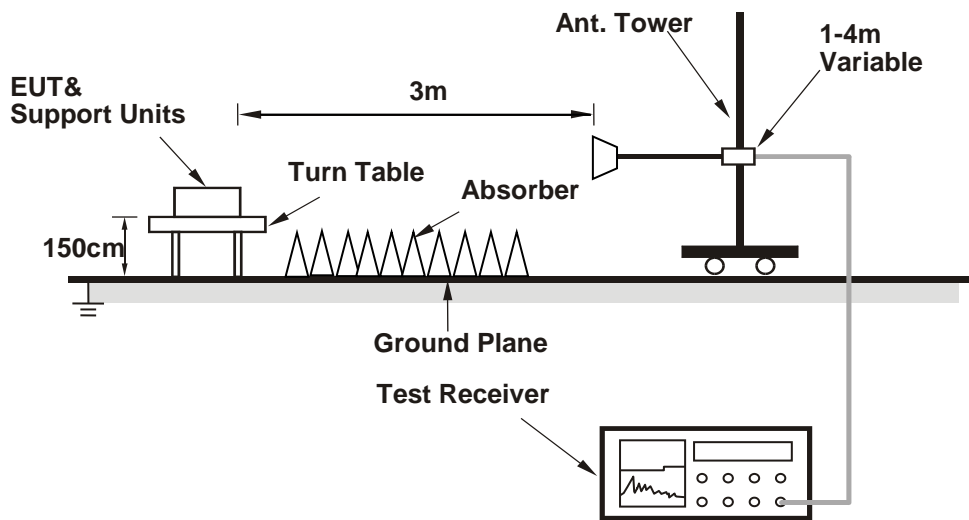

For the actual test configuration, please refer to the attached file (Test Setup Photo).

#### 4.1.6 EUT Operating Conditions

- a. Placed the EUT on the testing table.
- b. Controlling software (RF Sample with Receiver [Number Lock]) has been activated to set the EUT under transmission condition continuously at specific channel frequency.
  - ◆ BLE1M TX Modulated low duty cycle 2402MHz
  - ◆ BLE1M TX Modulated low duty cycle 2440MHz
  - ◆ BLE1M TX Modulated low duty cycle 2480MHz
  - ◆ BLE2M TX Modulated low duty cycle 2404MHz
  - ◆ BLE2M TX Modulated low duty cycle 2440MHz
  - ◆ BLE2M TX Modulated low duty cycle 2478MHz

#### 4.1.7 Test Results

#### Above 1GHz Data :

#### BT-LE 1M

<b>Channel</b>	TX Channel 0	<b>Detector Function</b>	Peak (PK)
<b>Frequency Range</b>	1GHz ~ 25GHz		Average (AV)

#### Antenna Polarity & Test Distance : Horizontal at 3 m

No	Frequency (MHz)	Emission Level (dBuV/m)	Limit (dBuV/m)	Margin (dB)	Antenna Height (m)	Table Angle (Degree)	Raw Value (dBuV)	Correction Factor (dB/m)
1	2338.02	55.5 PK	74.0	-18.5	1.43 H	353	57.3	-1.8
2	2338.02	45.6 AV	54.0	-8.4	1.43 H	353	47.4	-1.8
3	*2402.00	103.2 PK			1.43 H	353	105.0	-1.8
4	*2402.00	102.4 AV			1.43 H	353	104.2	-1.8
5	4804.00	41.8 PK	74.0	-32.2	3.06 H	5	39.6	2.2
6	4804.00	34.3 AV	54.0	-19.7	3.06 H	5	32.1	2.2

#### Antenna Polarity & Test Distance : Vertical at 3 m

No	Frequency (MHz)	Emission Level (dBuV/m)	Limit (dBuV/m)	Margin (dB)	Antenna Height (m)	Table Angle (Degree)	Raw Value (dBuV)	Correction Factor (dB/m)
1	2338.02	56.5 PK	74.0	-17.5	1.21 V	1	58.3	-1.8
2	2338.02	47.2 AV	54.0	-6.8	1.21 V	1	49.0	-1.8
3	*2402.00	106.3 PK			1.21 V	1	108.1	-1.8
4	*2402.00	105.5 AV			1.21 V	1	107.3	-1.8
5	4804.00	42.3 PK	74.0	-31.7	1.00 V	48	40.1	2.2
6	4804.00	36.5 AV	54.0	-17.5	1.00 V	48	34.3	2.2

#### Remarks:

1. Emission Level(dBuV/m) = Raw Value(dBuV) + Correction Factor(dB/m)
2. Correction Factor(dB/m) = Antenna Factor(dB/m) + Cable Factor(dB) – Pre-Amplifier Factor(dB)
3. Margin value = Emission Level – Limit value
4. The other emission levels were very low against the limit.
5. " \* ": Fundamental frequency.

<b>Channel</b>	TX Channel 19	<b>Detector Function</b>	Peak (PK)
<b>Frequency Range</b>	1GHz ~ 25GHz		Average (AV)

**Antenna Polarity & Test Distance : Horizontal at 3 m**

No	Frequency (MHz)	Emission Level (dBuV/m)	Limit (dBuV/m)	Margin (dB)	Antenna Height (m)	Table Angle (Degree)	Raw Value (dBuV)	Correction Factor (dB/m)
1	*2440.00	103.3 PK			1.52 H	349	105.1	-1.8
2	*2440.00	102.8 AV			1.52 H	349	104.6	-1.8
3	4880.00	41.1 PK	74.0	-32.9	3.07 H	11	39.0	2.1
4	4880.00	33.8 AV	54.0	-20.2	3.07 H	11	31.7	2.1
5	7320.00	53.8 PK	74.0	-20.2	1.06 H	12	44.7	9.1
6	7320.00	47.5 AV	54.0	-6.5	1.06 H	12	38.4	9.1

**Antenna Polarity & Test Distance : Vertical at 3 m**

No	Frequency (MHz)	Emission Level (dBuV/m)	Limit (dBuV/m)	Margin (dB)	Antenna Height (m)	Table Angle (Degree)	Raw Value (dBuV)	Correction Factor (dB/m)
1	*2440.00	106.0 PK			1.32 V	358	107.8	-1.8
2	*2440.00	105.1 AV			1.32 V	358	106.9	-1.8
3	4880.00	42.1 PK	74.0	-31.9	1.00 V	47	40.0	2.1
4	4880.00	35.8 AV	54.0	-18.2	1.00 V	47	33.7	2.1
5	7320.00	54.5 PK	74.0	-19.5	3.23 V	360	45.4	9.1
6	7320.00	49.3 AV	54.0	-4.7	3.23 V	360	40.2	9.1

**Remarks:**

1. Emission Level(dBuV/m) = Raw Value(dBuV) + Correction Factor(dB/m)
2. Correction Factor(dB/m) = Antenna Factor(dB/m) + Cable Factor(dB) – Pre-Amplifier Factor(dB)
3. Margin value = Emission Level – Limit value
4. The other emission levels were very low against the limit.
5. " \* ": Fundamental frequency.

<b>Channel</b>	TX Channel 39	<b>Detector Function</b>	Peak (PK)
<b>Frequency Range</b>	1GHz ~ 25GHz		Average (AV)

**Antenna Polarity & Test Distance : Horizontal at 3 m**

No	Frequency (MHz)	Emission Level (dBuV/m)	Limit (dBuV/m)	Margin (dB)	Antenna Height (m)	Table Angle (Degree)	Raw Value (dBuV)	Correction Factor (dB/m)
1	*2480.00	103.1 PK			1.50 H	346	105.0	-1.9
2	*2480.00	102.7 AV			1.50 H	346	104.6	-1.9
3	2483.50	59.2 PK	74.0	-14.8	1.50 H	346	61.1	-1.9
4	2483.50	46.1 AV	54.0	-7.9	1.50 H	346	48.0	-1.9
5	4960.00	40.9 PK	74.0	-33.1	3.08 H	12	38.4	2.5
6	4960.00	33.7 AV	54.0	-20.3	3.08 H	12	31.2	2.5
7	7440.00	53.8 PK	74.0	-20.2	1.07 H	7	44.5	9.3
8	7440.00	47.7 AV	54.0	-6.3	1.07 H	7	38.4	9.3

**Antenna Polarity & Test Distance : Vertical at 3 m**

No	Frequency (MHz)	Emission Level (dBuV/m)	Limit (dBuV/m)	Margin (dB)	Antenna Height (m)	Table Angle (Degree)	Raw Value (dBuV)	Correction Factor (dB/m)
1	*2480.00	107.2 PK			1.12 V	360	109.1	-1.9
2	*2480.00	106.4 AV			1.12 V	360	108.3	-1.9
3	2483.50	63.1 PK	74.0	-10.9	1.12 V	360	65.0	-1.9
4	2483.50	46.3 AV	54.0	-7.7	1.12 V	360	48.2	-1.9
5	4960.00	42.1 PK	74.0	-31.9	1.00 V	34	39.6	2.5
6	4960.00	36.1 AV	54.0	-17.9	1.00 V	34	33.6	2.5
7	7440.00	55.0 PK	74.0	-19.0	3.19 V	360	45.7	9.3
<b>8</b>	<b>7440.00</b>	<b>49.5 AV</b>	<b>54.0</b>	<b>-4.5</b>	<b>3.19 V</b>	<b>360</b>	<b>40.2</b>	<b>9.3</b>

**Remarks:**

1. Emission Level(dBuV/m) = Raw Value(dBuV) + Correction Factor(dB/m)
2. Correction Factor(dB/m) = Antenna Factor(dB/m) + Cable Factor(dB) – Pre-Amplifier Factor(dB)
3. Margin value = Emission Level – Limit value
4. The other emission levels were very low against the limit.
5. " \* ": Fundamental frequency.

**BT-LE 2M**

<b>Channel</b>	TX Channel 1	<b>Detector Function</b>	Peak (PK)
<b>Frequency Range</b>	1GHz ~ 25GHz		Average (AV)

**Antenna Polarity & Test Distance : Horizontal at 3 m**

No	Frequency (MHz)	Emission Level (dBuV/m)	Limit (dBuV/m)	Margin (dB)	Antenna Height (m)	Table Angle (Degree)	Raw Value (dBuV)	Correction Factor (dB/m)
1	2340.17	55.5 PK	74.0	-18.5	1.59 H	351	57.3	-1.8
2	2340.17	47.5 AV	54.0	-6.5	1.59 H	351	49.3	-1.8
3	*2404.00	102.7 PK			1.59 H	351	104.5	-1.8
4	*2404.00	102.4 AV			1.59 H	351	104.2	-1.8
5	4808.00	40.8 PK	74.0	-33.2	3.07 H	20	38.6	2.2
6	4808.00	33.5 AV	54.0	-20.5	3.07 H	20	31.3	2.2

**Antenna Polarity & Test Distance : Vertical at 3 m**

No	Frequency (MHz)	Emission Level (dBuV/m)	Limit (dBuV/m)	Margin (dB)	Antenna Height (m)	Table Angle (Degree)	Raw Value (dBuV)	Correction Factor (dB/m)
1	2340.17	56.6 PK	74.0	-17.4	1.12 V	6	58.4	-1.8
2	2340.17	48.5 AV	54.0	-5.5	1.12 V	6	50.3	-1.8
3	*2404.00	106.0 PK			1.12 V	6	107.8	-1.8
4	*2404.00	105.5 AV			1.12 V	6	107.3	-1.8
5	4808.00	42.1 PK	74.0	-31.9	1.06 V	34	39.9	2.2
6	4808.00	36.3 AV	54.0	-17.7	1.06 V	34	34.1	2.2

**Remarks:**

1. Emission Level(dBuV/m) = Raw Value(dBuV) + Correction Factor(dB/m)
2. Correction Factor(dB/m) = Antenna Factor(dB/m) + Cable Factor(dB) – Pre-Amplifier Factor(dB)
3. Margin value = Emission Level – Limit value
4. The other emission levels were very low against the limit.
5. " \* ": Fundamental frequency.

<b>Channel</b>	TX Channel 19	<b>Detector Function</b>	Peak (PK)
<b>Frequency Range</b>	1GHz ~ 25GHz		Average (AV)

**Antenna Polarity & Test Distance : Horizontal at 3 m**

No	Frequency (MHz)	Emission Level (dBuV/m)	Limit (dBuV/m)	Margin (dB)	Antenna Height (m)	Table Angle (Degree)	Raw Value (dBuV)	Correction Factor (dB/m)
1	*2440.00	103.1 PK			1.61 H	353	104.9	-1.8
2	*2440.00	102.5 AV			1.61 H	353	104.3	-1.8
3	4880.00	40.9 PK	74.0	-33.1	3.04 H	24	38.8	2.1
4	4880.00	33.6 AV	54.0	-20.4	3.04 H	24	31.5	2.1
5	7320.00	54.3 PK	74.0	-19.7	1.08 H	26	45.2	9.1
6	7320.00	47.8 AV	54.0	-6.2	1.08 H	26	38.7	9.1

**Antenna Polarity & Test Distance : Vertical at 3 m**

No	Frequency (MHz)	Emission Level (dBuV/m)	Limit (dBuV/m)	Margin (dB)	Antenna Height (m)	Table Angle (Degree)	Raw Value (dBuV)	Correction Factor (dB/m)
1	*2440.00	106.2 PK			1.17 V	19	108.0	-1.8
2	*2440.00	105.7 AV			1.17 V	19	107.5	-1.8
3	4880.00	42.0 PK	74.0	-32.0	1.00 V	39	39.9	2.1
4	4880.00	36.1 AV	54.0	-17.9	1.00 V	39	34.0	2.1
5	7320.00	54.5 PK	74.0	-19.5	3.19 V	360	45.4	9.1
6	7320.00	49.3 AV	54.0	-4.7	3.19 V	360	40.2	9.1

**Remarks:**

1. Emission Level(dBuV/m) = Raw Value(dBuV) + Correction Factor(dB/m)
2. Correction Factor(dB/m) = Antenna Factor(dB/m) + Cable Factor(dB) – Pre-Amplifier Factor(dB)
3. Margin value = Emission Level – Limit value
4. The other emission levels were very low against the limit.
5. " \* ": Fundamental frequency.



<b>Channel</b>	TX Channel 38	<b>Detector Function</b>	Peak (PK)
<b>Frequency Range</b>	1GHz ~ 25GHz		Average (AV)

**Antenna Polarity & Test Distance : Horizontal at 3 m**

No	Frequency (MHz)	Emission Level (dBuV/m)	Limit (dBuV/m)	Margin (dB)	Antenna Height (m)	Table Angle (Degree)	Raw Value (dBuV)	Correction Factor (dB/m)
1	*2478.00	103.2 PK			1.54 H	350	105.1	-1.9
2	*2478.00	102.7 AV			1.54 H	350	104.6	-1.9
3	2483.50	56.5 PK	74.0	-17.5	1.54 H	350	58.4	-1.9
4	2483.50	47.5 AV	54.0	-6.5	1.54 H	350	49.4	-1.9
5	4956.00	41.0 PK	74.0	-33.0	3.09 H	23	38.5	2.5
6	4956.00	33.4 AV	54.0	-20.6	3.09 H	23	30.9	2.5
7	7434.00	53.9 PK	74.0	-20.1	1.10 H	5	44.6	9.3
8	7434.00	47.6 AV	54.0	-6.4	1.10 H	5	38.3	9.3

**Antenna Polarity & Test Distance : Vertical at 3 m**

No	Frequency (MHz)	Emission Level (dBuV/m)	Limit (dBuV/m)	Margin (dB)	Antenna Height (m)	Table Angle (Degree)	Raw Value (dBuV)	Correction Factor (dB/m)
1	*2478.00	106.7 PK			1.16 V	12	108.6	-1.9
2	*2478.00	106.2 AV			1.16 V	12	108.1	-1.9
3	2483.50	58.9 PK	74.0	-15.1	1.16 V	12	60.8	-1.9
4	2483.50	48.1 AV	54.0	-5.9	1.16 V	12	50.0	-1.9
5	4956.00	41.8 PK	74.0	-32.2	1.01 V	20	39.3	2.5
6	4956.00	35.8 AV	54.0	-18.2	1.01 V	20	33.3	2.5
7	7434.00	54.6 PK	74.0	-19.4	3.22 V	358	45.3	9.3
8	7434.00	49.0 AV	54.0	-5.0	3.22 V	358	39.7	9.3

**Remarks:**

1. Emission Level(dBuV/m) = Raw Value(dBuV) + Correction Factor(dB/m)
2. Correction Factor(dB/m) = Antenna Factor(dB/m) + Cable Factor(dB) – Pre-Amplifier Factor(dB)
3. Margin value = Emission Level – Limit value
4. The other emission levels were very low against the limit.
5. " \* ": Fundamental frequency.

**Below 1GHz Data:**

**BT\_LE-2M**

<b>CHANNEL</b>	TX Channel 19	<b>DETECTOR FUNCTION</b>	Quasi-Peak (QP)
<b>FREQUENCY RANGE</b>	9kHz ~ 1GHz		

ANTENNA POLARITY & TEST DISTANCE: HORIZONTAL AT 3 M								
NO.	FREQ. (MHz)	EMISSION LEVEL (dBuV/m)	LIMIT (dBuV/m)	MARGIN (dB)	ANTENNA HEIGHT (m)	TABLE ANGLE (Degree)	RAW VALUE (dBuV)	CORRECTION FACTOR (dB/m)
1	67.93	31.8 QP	40.0	-8.2	3.00 H	0	41.5	-9.7
2	149.87	23.5 QP	43.5	-20.0	4.00 H	59	30.9	-7.4
3	381.16	25.4 QP	46.0	-20.6	3.00 H	74	29.7	-4.3
4	523.75	29.1 QP	46.0	-16.9	1.00 H	82	29.8	-0.7
5	657.06	31.6 QP	46.0	-14.4	2.00 H	348	29.3	2.3
6	895.89	34.9 QP	46.0	-11.1	3.00 H	0	28.5	6.4

**REMARKS:**

1. Emission Level(dBuV/m) = Raw Value(dBuV) + Correction Factor(dB/m)
2. Correction Factor(dB/m) = Antenna Factor(dB/m) + Cable Factor(dB) – Pre-Amplifier Factor(dB)
3. Margin value = Emission Level – Limit value
4. The other emission levels were very low against the limit of frequency range 30MHz~1000MHz.
5. The emission levels were very low against the limit of frequency range 9kHz~30MHz: the amplitude of spurious emissions attenuated more than 20 dB below the permissible value to be report.

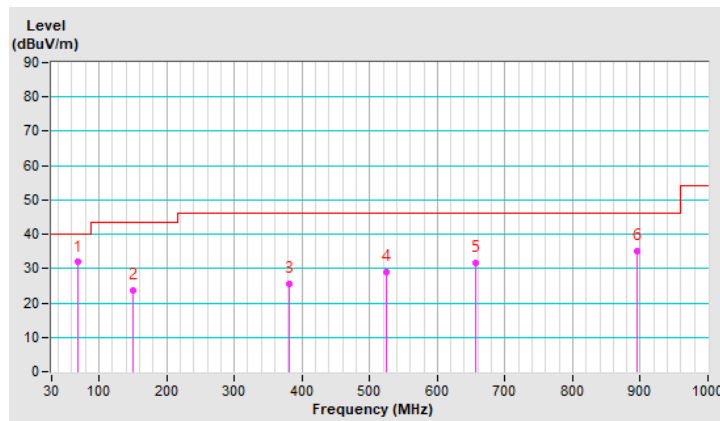

<b>CHANNEL</b>	TX Channel 19	<b>DETECTOR FUNCTION</b>	Quasi-Peak (QP)
<b>FREQUENCY RANGE</b>	9kHz ~ 1GHz		

**ANTENNA POLARITY & TEST DISTANCE: VERTICAL AT 3 M**

NO.	FREQ. (MHz)	EMISSION LEVEL (dBuV/m)	LIMIT (dBuV/m)	MARGIN (dB)	ANTENNA HEIGHT (m)	TABLE ANGLE (Degree)	RAW VALUE (dBuV)	CORRECTION FACTOR (dB/m)
1	66.67	28.7 QP	40.0	-11.3	3.00 V	0	37.9	-9.2
2	161.68	23.5 QP	43.5	-20.0	3.00 V	4	31.0	-7.5
3	371.49	24.9 QP	46.0	-21.1	2.00 V	335	29.4	-4.5
4	598.47	30.4 QP	46.0	-15.6	1.00 V	247	29.0	1.4
5	783.59	35.7 QP	46.0	-10.3	2.00 V	333	30.6	5.1
6	895.41	35.4 QP	46.0	-10.6	1.00 V	134	29.0	6.4

**REMARKS:**

1. Emission Level(dBuV/m) = Raw Value(dBuV) + Correction Factor(dB/m)
2. Correction Factor(dB/m) = Antenna Factor(dB/m) + Cable Factor(dB) – Pre-Amplifier Factor(dB)
3. Margin value = Emission Level – Limit value
4. The other emission levels were very low against the limit of frequency range 30MHz~1000MHz.
5. The emission levels were very low against the limit of frequency range 9kHz~30MHz: the amplitude of spurious emissions attenuated more than 20 dB below the permissible value to be report.

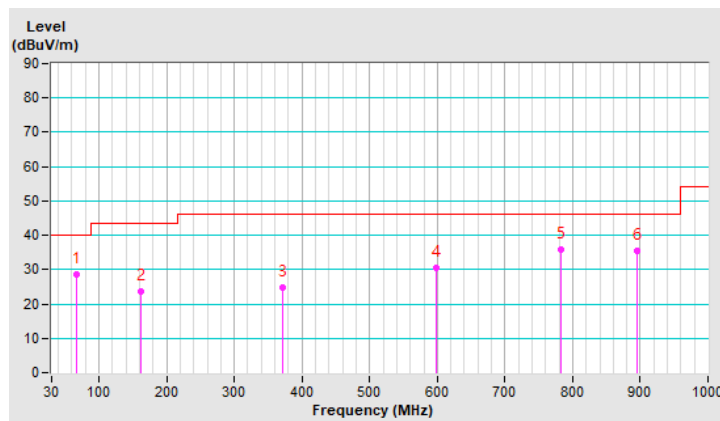

## 4.2 Conducted Emission Measurement

### 4.2.1 Limits of Conducted Emission Measurement

Frequency (MHz)	Conducted Limit (dBuV)	
	Quasi-peak	Average
0.15 - 0.5	66 - 56	56 - 46
0.50 - 5.0	56	46
5.0 - 30.0	60	50

Note: 1. The lower limit shall apply at the transition frequencies.

2. The limit decreases in line with the logarithm of the frequency in the range of 0.15 to 0.50MHz.

### 4.2.2 Test Instruments

DESCRIPTION & MANUFACTURER	MODEL NO.	SERIAL NO.	CALIBRATED DATE	CALIBRATED UNTIL
Test Receiver R&S	ESCS 30	847124/029	Oct. 23, 2019	Oct. 22, 2020
Line-Impedance Stabilization Network (for EUT) R&S	ESH3-Z5	848773/004	Oct. 23, 2019	Oct. 22, 2020
Line-Impedance Stabilization Network (for Peripheral) R&S	ESH3-Z5	835239/001	Mar. 19, 2020	Mar. 18, 2021
50 ohms Terminator	50	3	Oct. 23, 2019	Oct. 22, 2020
RF Cable	5D-FB	COCCAB-001	Sep. 27, 2019	Sep. 26, 2020
Fixed attenuator EMCI	STI02-2200-10	003	Aug. 30, 2019	Aug. 29, 2020
Software BVADT	BVADT_Cond_ V7.3.7.4	NA	NA	NA

**Note:**

1. The calibration interval of the above test instruments are 12 months and the calibrations are traceable to NML/ROC and NIST/USA.
2. The test was performed in Conduction 1.
3. Tested Date: July 20, 2020

#### 4.2.3 Test Procedures

- The EUT was placed 0.4 meters from the conducting wall of the shielded room with EUT being connected to the power mains through a line impedance stabilization network (LISN). Other support units were connected to the power mains through another LISN. The two LISNs provide 50 ohm/ 50uH of coupling impedance for the measuring instrument.
- Both lines of the power mains connected to the EUT were checked for maximum conducted interference.
- The frequency range from 150kHz to 30MHz was searched. Emission levels under (Limit - 20dB) was not recorded.

**NOTE:** The resolution bandwidth and video bandwidth of test receiver is 9kHz for quasi-peak detection (QP) and average detection (AV) at frequency 0.15MHz-30MHz.

#### 4.2.4 Deviation from Test Standard

No deviation.

#### 4.2.5 Test Setup

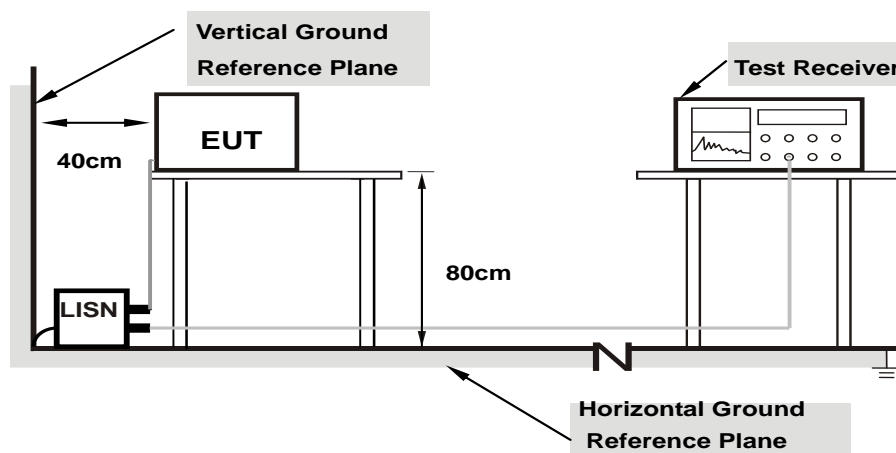

**Note: 1.Support units were connected to second LISN.**

For the actual test configuration, please refer to the attached file (Test Setup Photo).

#### 4.2.6 EUT Operating Conditions

Same as 4.1.6.

#### 4.2.7 Test Results

Phase	Line (L)	Detector Function	Quasi-Peak (QP) / Average (AV)
-------	----------	-------------------	--------------------------------

No	Freq. [MHz]	Corr.	Reading Value		Emission Level		Limit		Margin	
		Factor	[dB (uV)]		[dB (uV)]		[dB (uV)]		(dB)	
		(dB)	Q.P.	AV.	Q.P.	AV.	Q.P.	AV.	Q.P.	AV.
1	0.15000	9.97	35.40	17.59	45.37	27.56	66.00	56.00	-20.63	-28.44
2	0.16953	9.97	34.12	18.75	44.09	28.72	64.98	54.98	-20.89	-26.26
3	0.27891	9.97	24.93	14.84	34.90	24.81	60.85	50.85	-25.95	-26.04
<b>4</b>	<b>0.43125</b>	<b>9.98</b>	<b>28.48</b>	<b>21.75</b>	<b>38.46</b>	<b>31.73</b>	<b>57.23</b>	<b>47.23</b>	<b>-18.77</b>	<b>-15.50</b>
5	1.65234	10.05	21.97	17.21	32.02	27.26	56.00	46.00	-23.98	-18.74
6	21.05078	11.08	20.02	15.14	31.10	26.22	60.00	50.00	-28.90	-23.78

#### REMARKS:

1. Q.P. and AV. are abbreviations of quasi-peak and average individually.
2. The emission levels of other frequencies were very low against the limit.
3. Margin value = Emission level - Limit value
4. Correction factor = Insertion loss + Cable loss
5. Emission Level = Correction Factor + Reading Value.

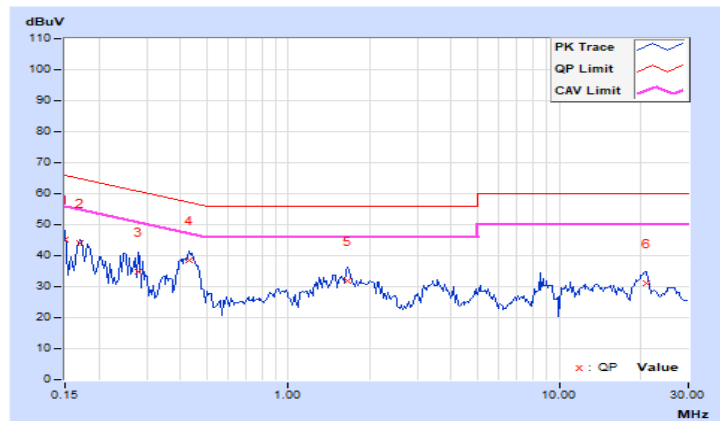

Phase	Neutral (N)	Detector Function	Quasi-Peak (QP) / Average (AV)
-------	-------------	-------------------	-----------------------------------

No	Freq. [MHz]	Corr.	Reading Value		Emission Level		Limit		Margin	
		Factor	[dB (uV)]		[dB (uV)]		[dB (uV)]		(dB)	
		(dB)	Q.P.	AV.	Q.P.	AV.	Q.P.	AV.	Q.P.	AV.
1	0.15000	9.97	35.78	19.93	45.75	29.90	66.00	56.00	-20.25	-26.10
2	0.16953	9.97	29.77	12.88	39.74	22.85	64.98	54.98	-25.24	-32.13
3	0.23203	9.97	24.86	17.02	34.83	26.99	62.38	52.38	-27.55	-25.39
4	0.43125	9.98	26.37	20.51	36.35	30.49	57.23	47.23	-20.88	-16.74
5	1.41797	10.04	21.13	16.20	31.17	26.24	56.00	46.00	-24.83	-19.76
6	8.38672	10.32	21.68	15.13	32.00	25.45	60.00	50.00	-28.00	-24.55

#### REMARKS:

1. Q.P. and AV. are abbreviations of quasi-peak and average individually.
2. The emission levels of other frequencies were very low against the limit.
3. Margin value = Emission level - Limit value
4. Correction factor = Insertion loss + Cable loss
5. Emission Level = Correction Factor + Reading Value.

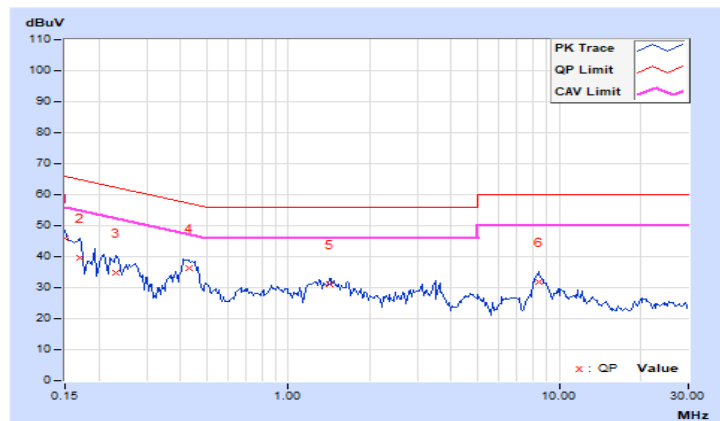

### 4.3 6dB Bandwidth Measurement

#### 4.3.1 Limits of 6dB Bandwidth Measurement

The minimum of 6dB Bandwidth Measurement is 0.5 MHz.

#### 4.3.2 Test Setup

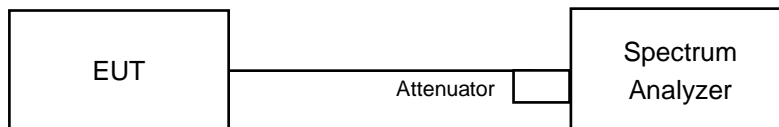

#### 4.3.3 Test Instruments

Refer to section 4.1.2 to get information of above instrument.

#### 4.3.4 Test Procedure

- a. Set resolution bandwidth (RBW) = 100kHz
- b. Set the video bandwidth (VBW)  $\geq 3 \times$  RBW, Detector = Peak.
- c. Trace mode = max hold.
- d. Sweep = auto couple.
- e. Measure the maximum width of the emission that is constrained by the frequencies associated with the two amplitude points (upper and lower) that are attenuated by 6 dB relative to the maximum level measured in the fundamental emission

#### 4.3.5 Deviation from Test Standard

No deviation.

#### 4.3.6 EUT Operating Conditions

The software provided by client to enable the EUT under transmission condition continuously at lowest, middle and highest channel frequencies individually.



4.3.7 Test Result

BT-LE 1M

Channel	Frequency (MHz)	6dB Bandwidth (MHz)	Minimum Limit (MHz)	Pass / Fail
0	2402	0.71	0.5	Pass
19	2440	0.71	0.5	Pass
39	2480	0.72	0.5	Pass

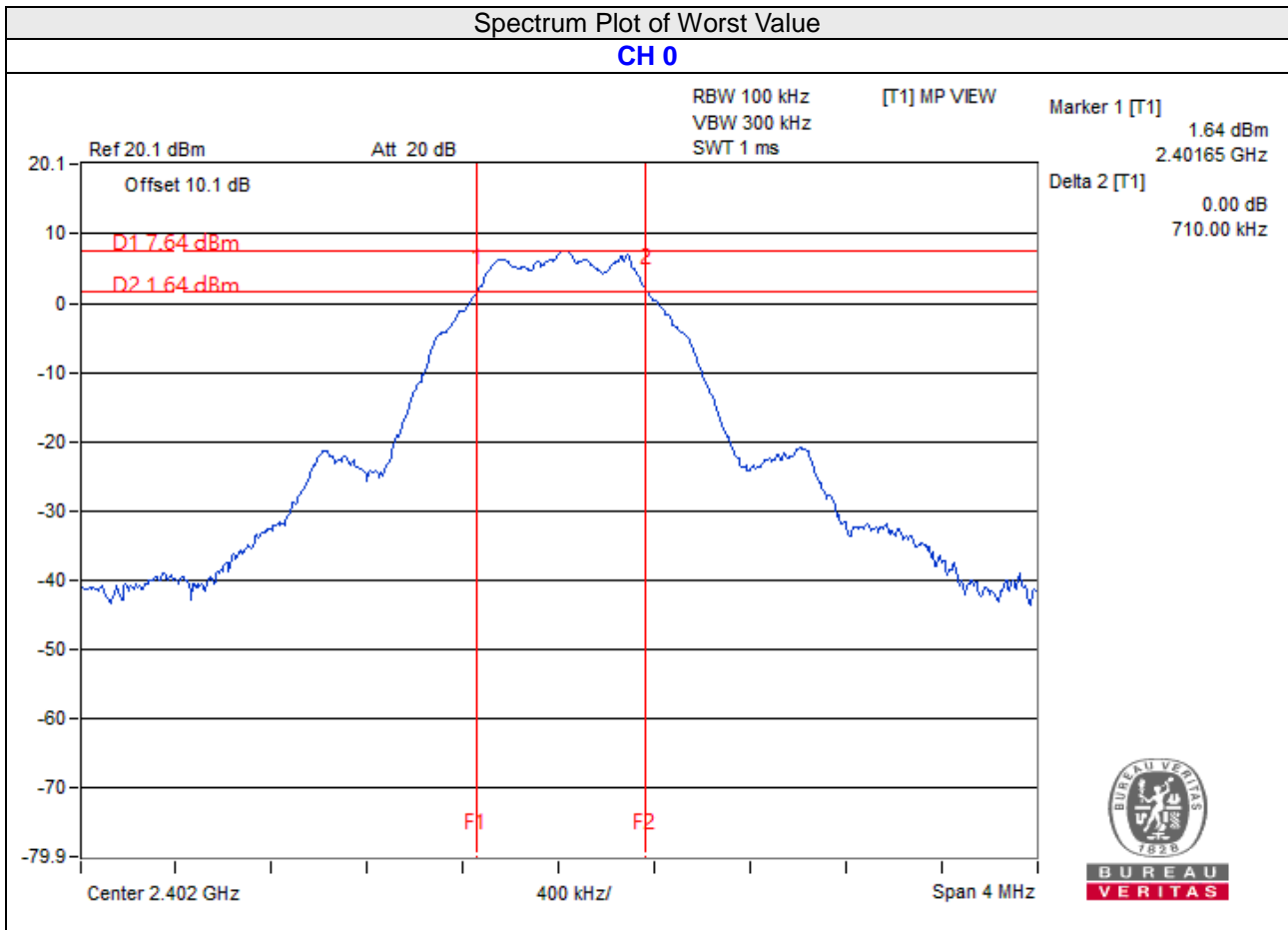

**BT-LE 2M**

Channel	Frequency (MHz)	6dB Bandwidth (MHz)	Minimum Limit (MHz)	Pass / Fail
1	2404	1.16	0.5	Pass
19	2440	1.15	0.5	Pass
38	2478	1.14	0.5	Pass

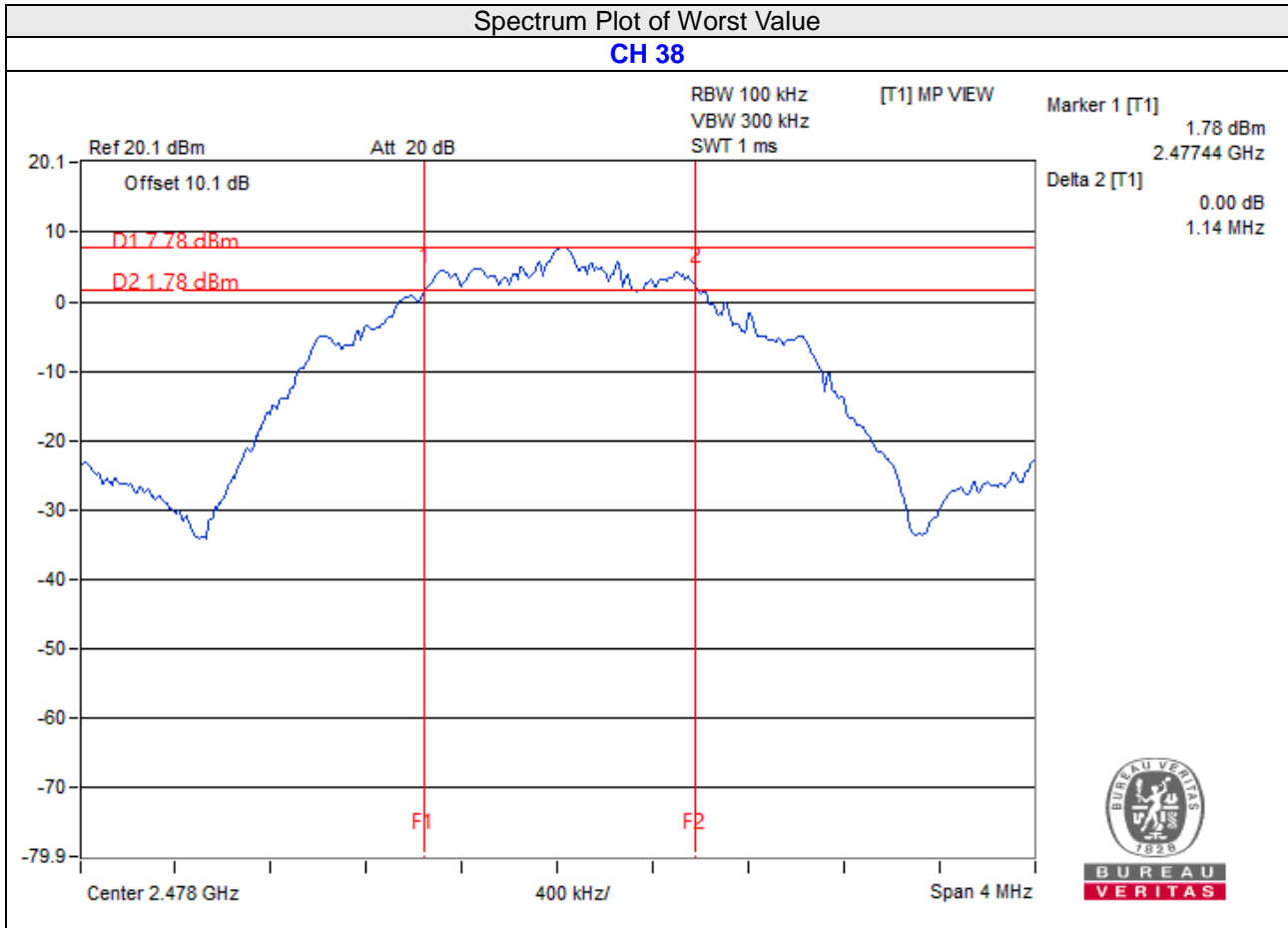

## 4.4 Conducted Output Power Measurement

### 4.4.1 Limits of Conducted Output Power Measurement

For systems using digital modulation in the 2400–2483.5 MHz bands: 1 Watt (30dBm)

### 4.4.2 Test Setup

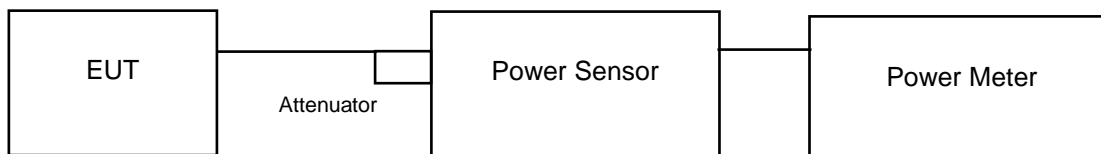

### 4.4.3 Test Instruments

Refer to section 4.1.2 to get information of above instrument.

### 4.4.4 Test Procedures

A peak power sensor was used on the output port of the EUT. A power meter was used to read the response of the peak power sensor. Record the power level.

Average power sensor was used to perform output power measurement, trigger and gating function of wide band power meter is enabled to measure max output power of TX on burst. Duty factor is not added to measured value..

### 4.4.5 Deviation from Test Standard

No deviation.

### 4.4.6 EUT Operating Conditions

Same as Item 4.3.6.

#### 4.4.7 Test Results

##### BT-LE 1M

##### FOR PEAK POWER

Channel	Frequency (MHz)	Peak Power (mW)	Peak Power (dBm)	Limit (dBm)	Pass/Fail
0	2402	5.861	7.68	30	Pass
19	2440	5.888	7.70	30	Pass
39	2480	5.875	7.69	30	Pass

##### FOR AVERAGE POWER

Channel	Frequency (MHz)	Average Power (mW)	Average Power (dBm)
0	2402	5.768	7.61
19	2440	5.794	7.63
39	2480	5.781	7.62

##### BT-LE 2M

##### FOR PEAK POWER

Channel	Frequency (MHz)	Peak Power (mW)	Peak Power (dBm)	Limit (dBm)	Pass/Fail
1	2404	5.821	7.65	30	Pass
19	2440	5.875	7.69	30	Pass
38	2478	5.861	7.68	30	Pass

##### FOR AVERAGE POWER

Channel	Frequency (MHz)	Average Power (mW)	Average Power (dBm)
1	2404	5.768	7.61
19	2440	5.808	7.64
38	2478	5.794	7.63

## 4.5 Power Spectral Density Measurement

### 4.5.1 Limits of Power Spectral Density Measurement

The Maximum of Power Spectral Density Measurement is 8dBm in any 3kHz.

### 4.5.2 Test Setup

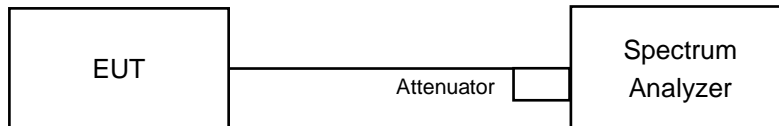

### 4.5.3 Test Instruments

Refer to section 4.1.2 to get information of above instrument.

### 4.5.4 Test Procedure

- a. Set analyzer center frequency to DTS channel center frequency.
- b. Set the span to 1.5 times the DTS bandwidth.
- c. Set the RBW to:  $3 \text{ kHz} \leq \text{RBW} \leq 100 \text{ kHz}$ .
- d. Set the VBW  $\geq 3 \times \text{RBW}$ .
- e. Detector = peak.
- f. Sweep time = auto couple.
- g. Trace mode = max hold.
- h. Allow trace to fully stabilize.
- i. Use the peak marker function to determine the maximum amplitude level within the RBW.

### 4.5.5 Deviation from Test Standard

No deviation.

### 4.5.6 EUT Operating Condition

Same as Item 4.3.6

#### 4.5.7 Test Results

##### BT-LE 1M

Channel	Freq. (MHz)	PSD (dBm/3kHz)	Limit (dBm/3kHz)	Pass /Fail
0	2402	5.23	8	Pass
19	2440	5.19	8	Pass
39	2480	5.36	8	Pass

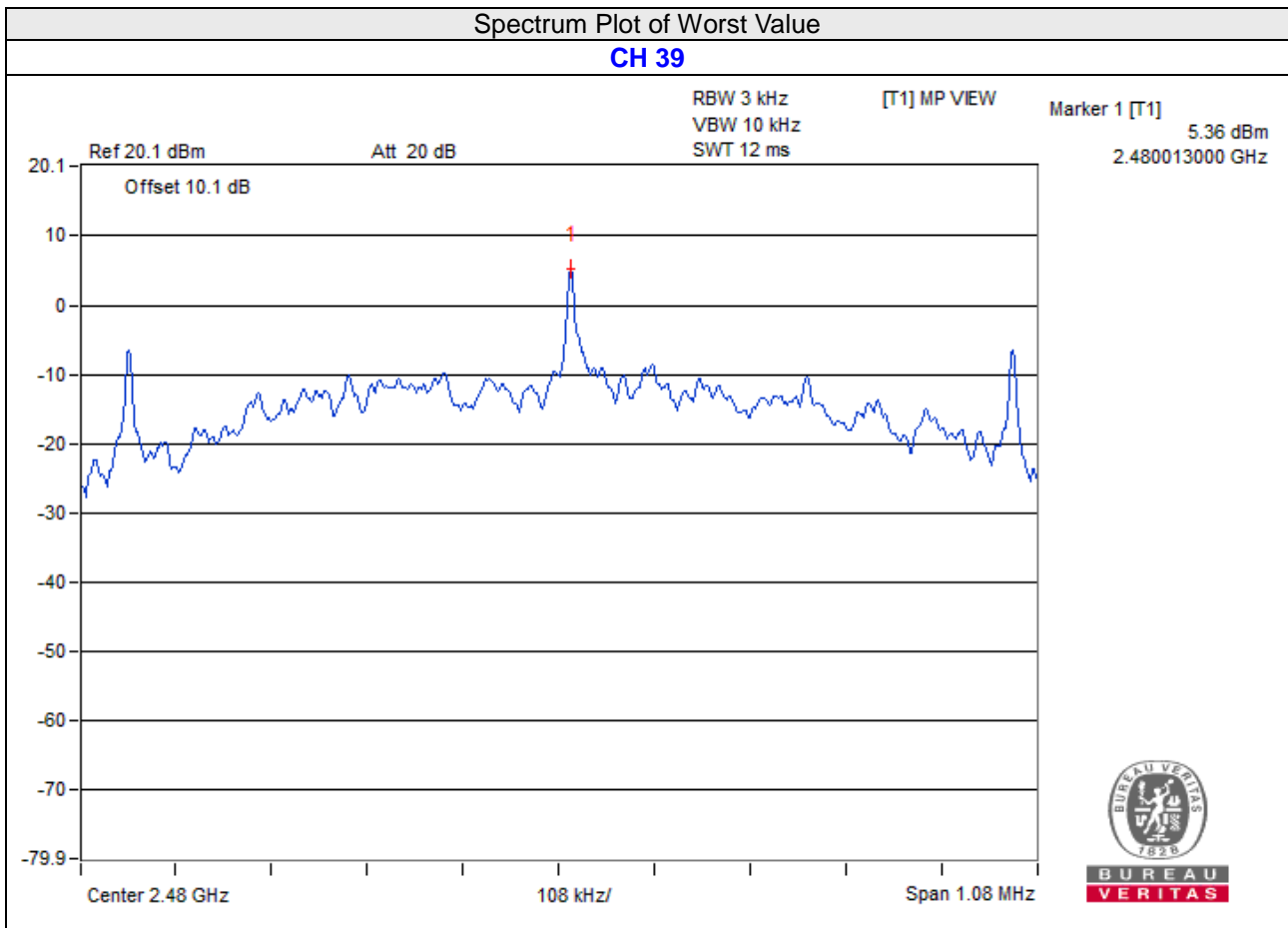

**BT-LE 2M**

Channel	Freq. (MHz)	PSD (dBm/3kHz)	Limit (dBm/3kHz)	Pass /Fail
1	2404	1.07	8	Pass
19	2440	1.30	8	Pass
38	2478	1.37	8	Pass

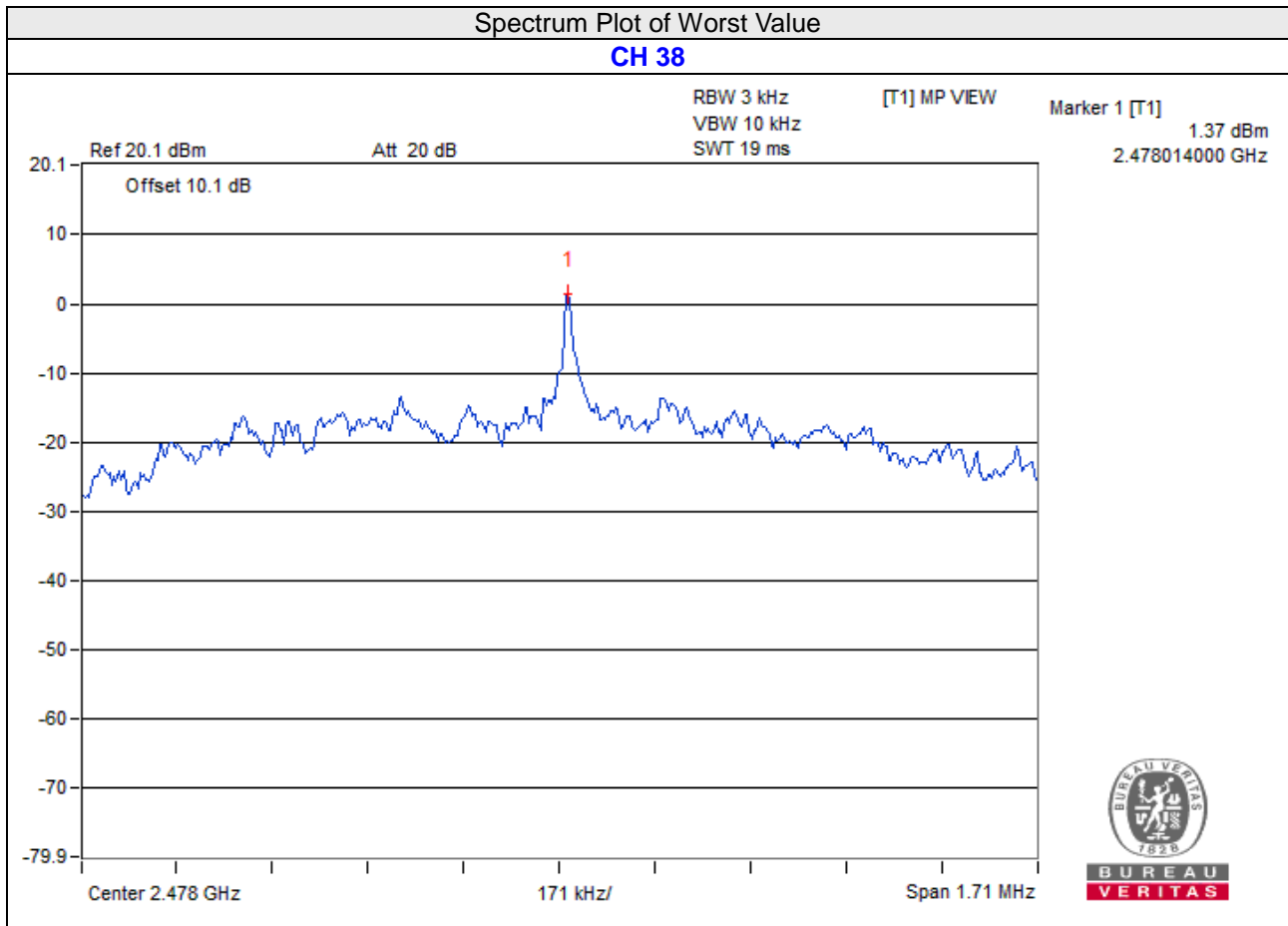

## 4.6 Conducted Out of Band Emission Measurement

### 4.6.1 Limits of Conducted Out of Band Emission Measurement

Below 20dB of the highest emission level of operating band (in 100kHz Resolution Bandwidth).

### 4.6.2 Test Setup

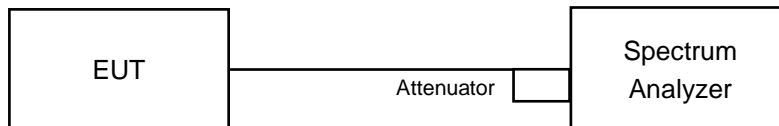

### 4.6.3 Test Instruments

Refer to section 4.1.2 to get information of above instrument.

### 4.6.4 Test Procedure

#### MEASUREMENT PROCEDURE REF

1. Set the RBW = 100 kHz.
2. Set the VBW  $\geq$  300 kHz.
3. Detector = peak.
4. Sweep time = auto couple.
5. Trace mode = max hold.
6. Allow trace to fully stabilize.
7. Use the peak marker function to determine the maximum power level in any 100 kHz band segment within the fundamental EBW.

#### MEASUREMENT PROCEDURE OOBE

1. Set RBW = 100 kHz.
2. Set VBW  $\geq$  300 kHz.
3. Detector = peak.
4. Sweep = auto couple.
5. Trace Mode = max hold.
6. Allow trace to fully stabilize.
7. Use the peak marker function to determine the maximum amplitude level.

### 4.6.5 Deviation from Test Standard

No deviation.

### 4.6.6 EUT Operating Condition

Same as Item 4.3.6

### 4.6.7 Test Results

The spectrum plots are attached on the following pages. D1 line indicates the highest level, and D2 line indicates the 20dB offset below D1. It shows compliance with the requirement.



# BT-LE 1M

## CH 0

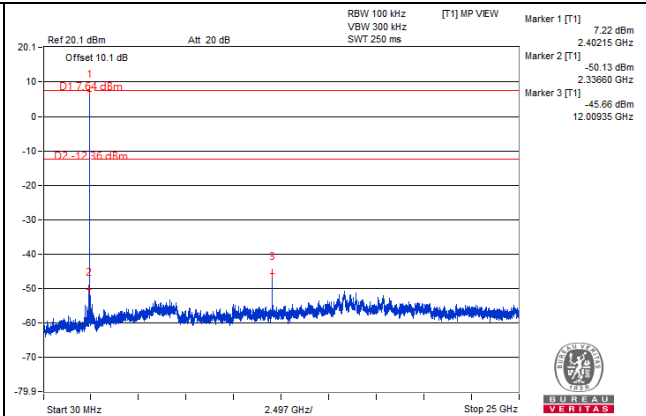
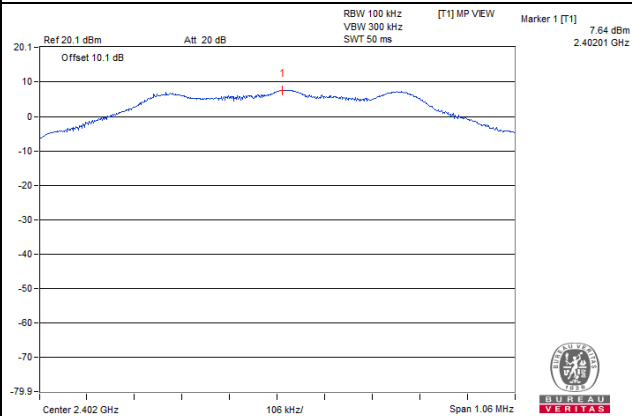

## CH 19

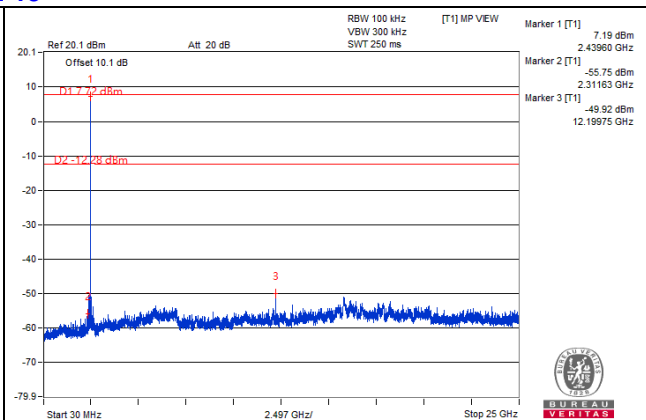
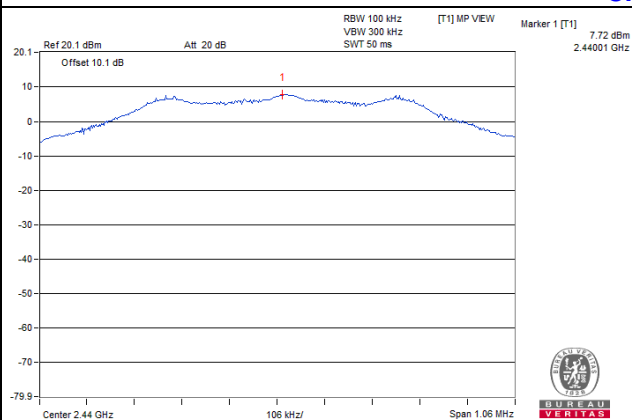

## CH 39

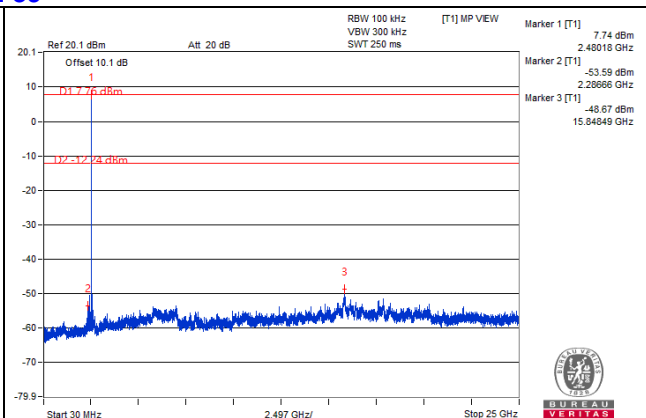
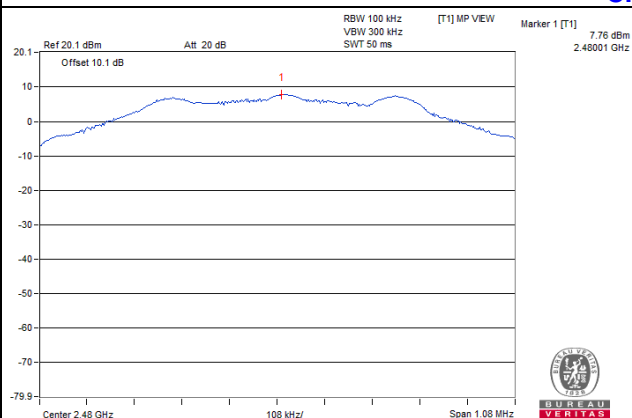

## CH 0 Band edge

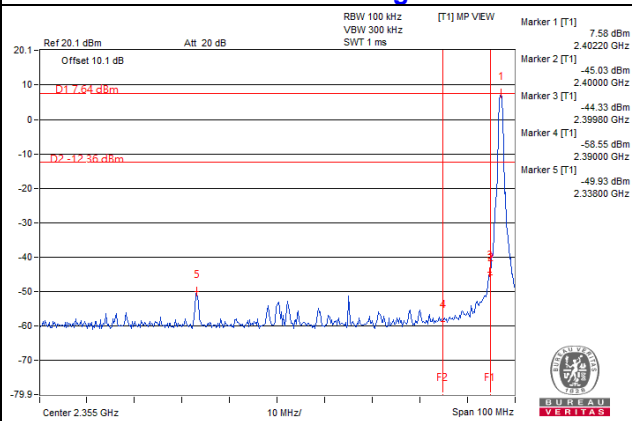

## CH 39 Band edge

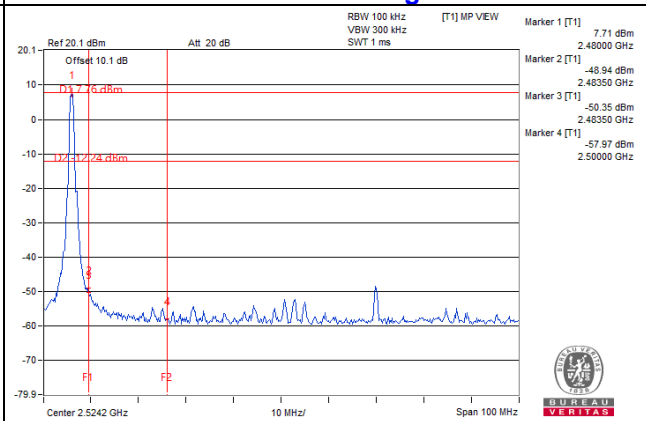

# BT-LE 2M

## CH 1

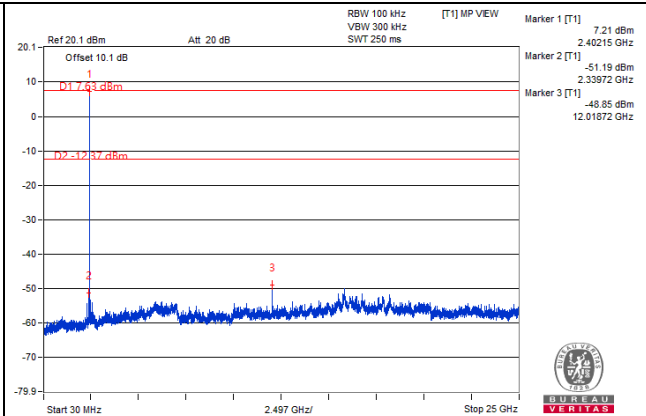
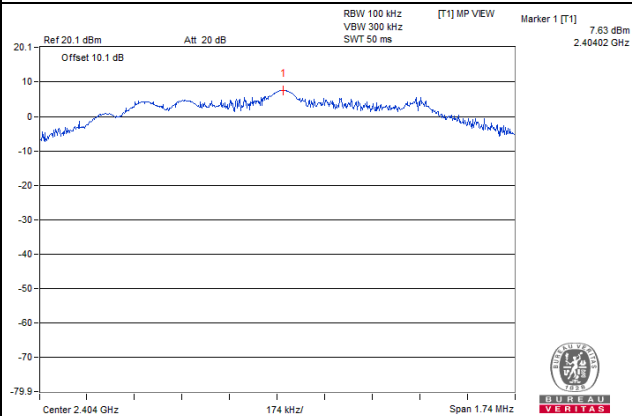

## CH 19

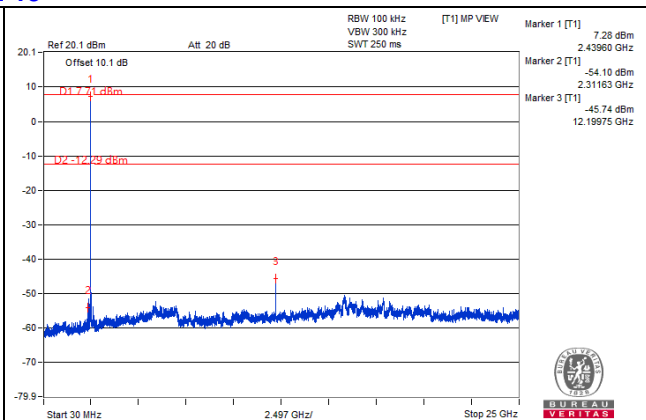
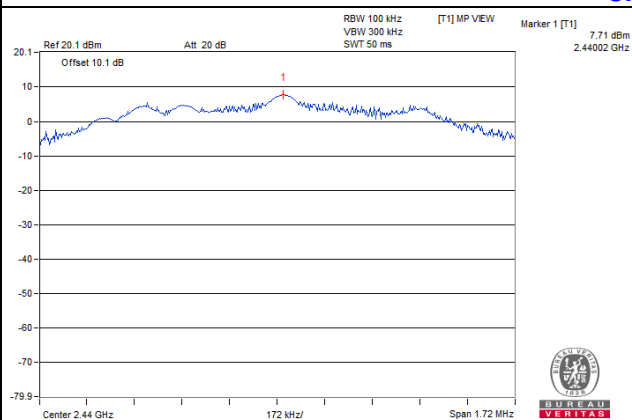

## CH 38

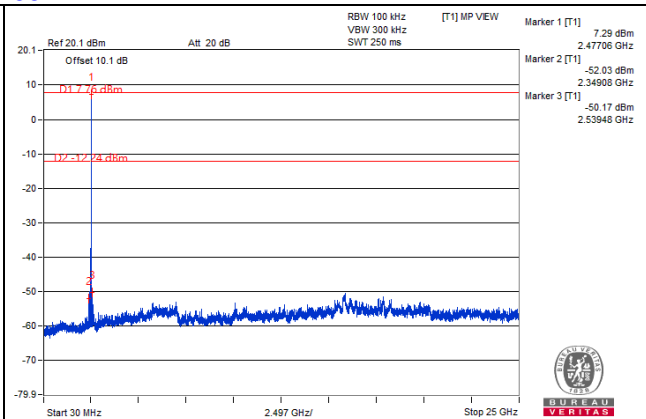
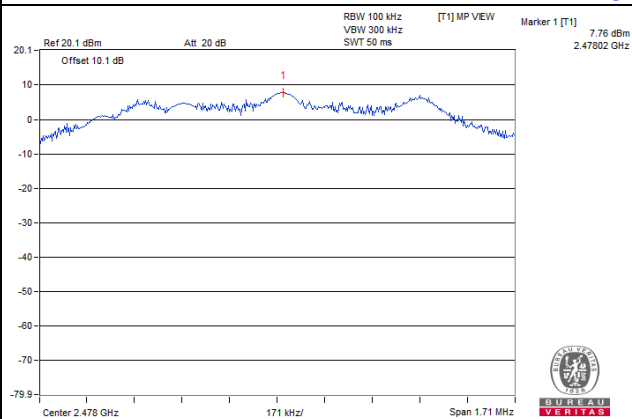

## CH 1 Band edge

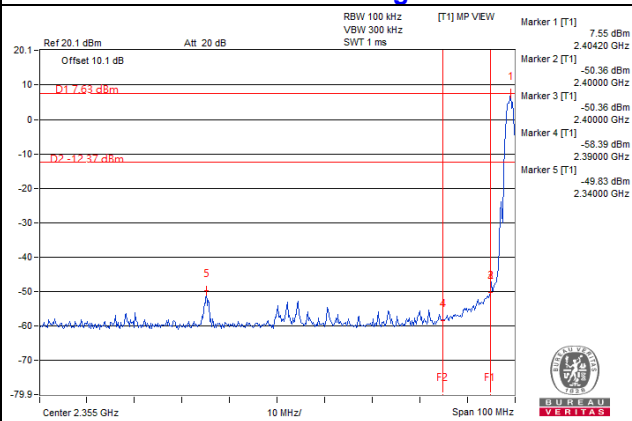

## CH 38 Band edge

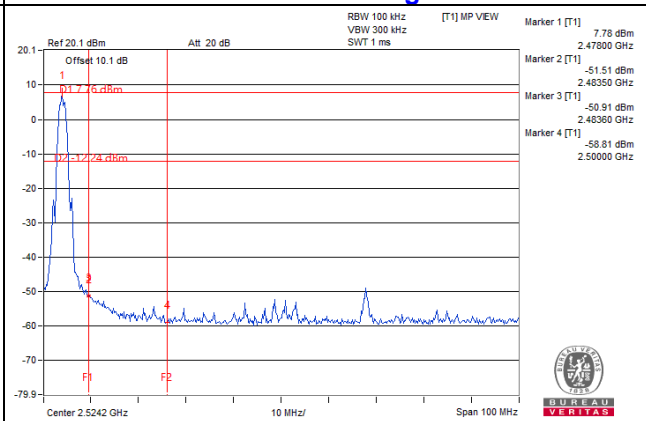

## 5 Pictures of Test Arrangements

Please refer to the attached file (Test Setup Photo).

# Annex A - Band-Edge Measurement

BT\_LE-1M

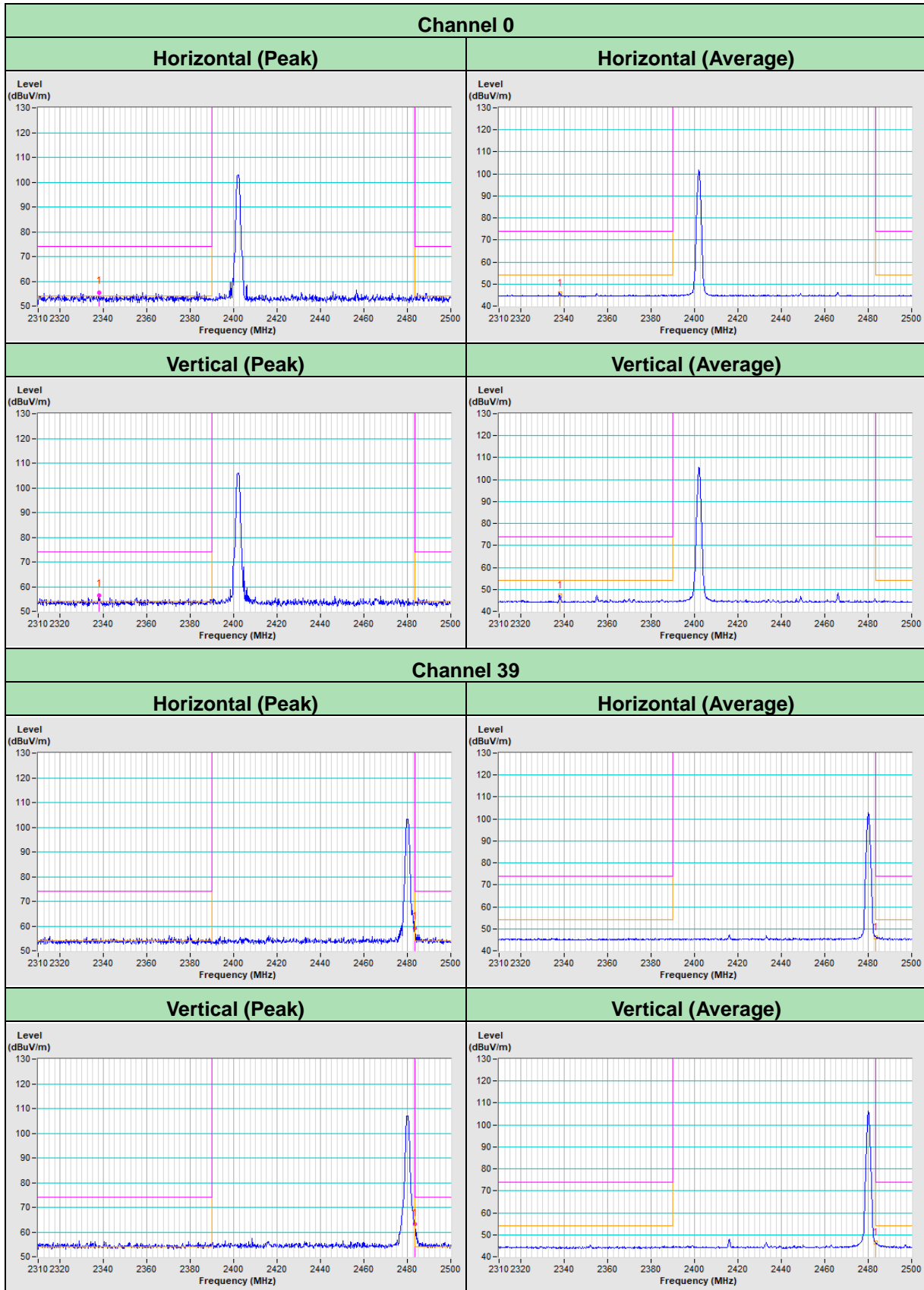

BT\_LE-2M

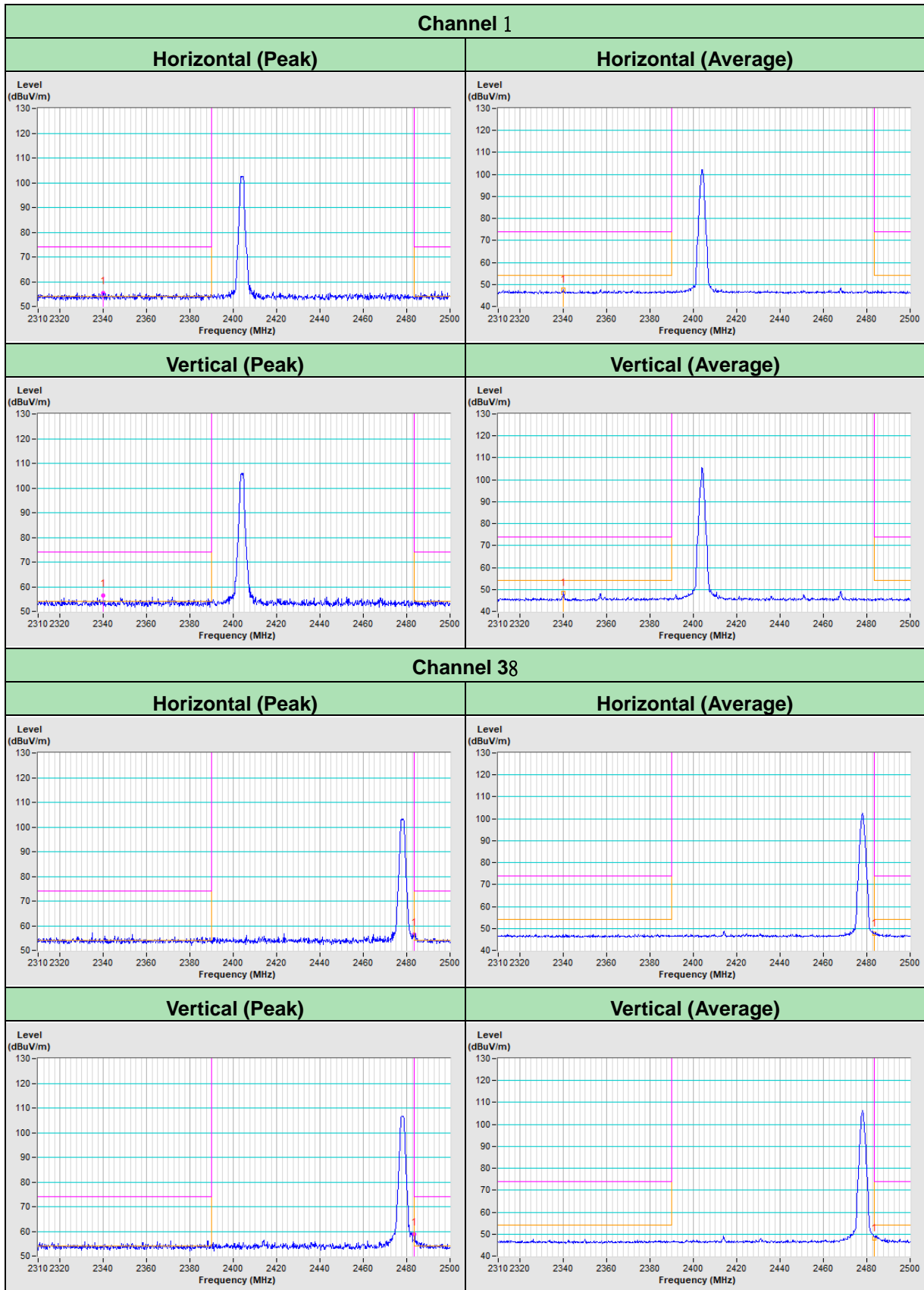

## Appendix – Information of the Testing Laboratories

We, Bureau Veritas Consumer Products Services (H.K.) Ltd., Taoyuan Branch, were founded in 1988 to provide our best service in EMC, Radio, Telecom and Safety consultation. Our laboratories are FCC recognized accredited test firms and accredited according to ISO/IEC 17025.

If you have any comments, please feel free to contact us at the following:

**Lin Kou EMC/RF Lab**

Tel: 886-2-26052180

Fax: 886-2-26051924

**Hsin Chu EMC/RF/Telecom Lab**

Tel: 886-3-6668565

Fax: 886-3-6668323

**Hwa Ya EMC/RF/Safety Lab**

Tel: 886-3-3183232

Fax: 886-3-3270892

**Email:** [service.adt@tw.bureauveritas.com](mailto:service.adt@tw.bureauveritas.com)

**Web Site:** [www.bureauveritas-adt.com](http://www.bureauveritas-adt.com)

The address and road map of all our labs can be found in our web site also.

--- END ---