

# TEST REPORT

## CERTIFICATE OF CONFORMITY

**Standard:** 47 CFR FCC Part 15, Subpart C (Section 15.247)

**Report No.:** RFBDKG-WTW-P20100478B

**FCC ID:** JNZCU0011

**Product:** 2.4GHz USB Transceiver

**Brand:** Logitech

**Model No.:** C-U0011

**Received Date:** 2023/12/1

**Test Date:** 2023/12/12 ~ 2024/2/2

**Issued Date:** 2024/3/6

**Applicant:** LOGITECH FAR EAST LTD.

**Address:** #2 Creation Rd. 4, Science-Based Ind. Park Hsinchu Taiwan, R.O.C.

**Issued By:** Bureau Veritas Consumer Products Services (H.K.) Ltd., Taoyuan Branch  
Hsin Chu Laboratory

**Lab Address:** E-2, No.1, Li Hsin 1st Road, Hsinchu Science Park, Hsinchu City 300, Taiwan

**Test Location:** No. 49, Ln. 206, Wende Rd., Shangshan Tsuen, Chiung Lin Hsiang, Hsin Chu Hsien 307, Taiwan

**FCC Registration /** 736135 / TW0004

**Designation Number:**

Approved by: \_\_\_\_\_

May Chen / Manager

, Date: \_\_\_\_\_

2024/3/6

This test report consists of 39 pages in total. It may be duplicated completely for legal use with the approval of the applicant. It should not be reproduced except in full, without the written approval of our laboratory. The test results in the report only apply to the tested sample. The test results in this report are traceable to the national or international standards.



Prepared by : Claire Kuan / Specialist

This report is governed by, and incorporates by reference, the Conditions of Testing as posted at the date of issuance of this report at <http://www.bureauveritas.com/home/about-us/our-business/cps/about-us/terms-conditions/> and is intended for your exclusive use. Any copying or replication of this report to or for any other person or entity, or use of our name or trademark, is permitted only with our prior written permission. This report sets forth our findings solely with respect to the test samples identified herein. The results set forth in this report are not indicative or representative of the quality or characteristics of the lot from which a test sample was taken or any similar or identical product unless specifically and expressly noted. Our report includes all of the tests requested by you and the results thereof based upon the information that you provided to us. Measurement uncertainty is only provided upon request for accredited tests. Statements of conformity are based on simple acceptance criteria without taking measurement uncertainty into account, unless otherwise requested in writing. You have 60 days from date of issuance of this report to notify us of any material error or omission caused by our negligence or if you require measurement uncertainty; provided, however, that such notice shall be in writing and shall specifically address the issue you wish to raise. A failure to raise such issue within the prescribed time shall constitute your unqualified acceptance of the completeness of this report, the tests conducted and the correctness of the report contents.

## Table of Contents

<b>Release Control Record .....</b>	<b>3</b>
<b>1 Certificate.....</b>	<b>4</b>
<b>2 Summary of Test Results .....</b>	<b>5</b>
2.1 Measurement Uncertainty .....	5
2.2 Supplementary Information .....	5
<b>3 General Information .....</b>	<b>6</b>
3.1 General Description .....	6
3.2 Antenna Description of EUT .....	7
3.3 Channel List.....	8
3.4 Test Mode Applicability and Tested Channel Detail.....	9
3.5 Duty Cycle of Test Signal.....	10
3.6 Test Program Used and Operation Descriptions .....	11
3.7 Connection Diagram of EUT and Peripheral Devices .....	12
3.8 Configuration of Peripheral Devices and Cable Connections .....	13
<b>4 Test Instruments .....</b>	<b>14</b>
4.1 RF Output Power .....	14
4.2 Power Spectral Density .....	14
4.3 AC Power Conducted Emissions .....	14
4.4 Unwanted Emissions below 1 GHz .....	15
4.5 Unwanted Emissions above 1 GHz.....	16
<b>5 Limits of Test Items.....</b>	<b>17</b>
5.1 RF Output Power .....	17
5.2 Power Spectral Density .....	17
5.3 AC Power Conducted Emissions .....	17
5.4 Unwanted Emissions below 1 GHz .....	17
5.5 Unwanted Emissions above 1 GHz.....	18
<b>6 Test Arrangements.....</b>	<b>19</b>
6.1 RF Output Power .....	19
6.1.1 Test Setup .....	19
6.1.2 Test Procedure.....	19
6.2 Power Spectral Density .....	19
6.2.1 Test Setup .....	19
6.2.2 Test Procedure.....	19
6.3 AC Power Conducted Emissions .....	20
6.3.1 Test Setup .....	20
6.3.2 Test Procedure.....	20
6.4 Unwanted Emissions below 1 GHz .....	21
6.4.1 Test Setup .....	21
6.4.2 Test Procedure.....	22
6.5 Unwanted Emissions above 1 GHz.....	23
6.5.1 Test Setup .....	23
6.5.2 Test Procedure.....	23
<b>7 Test Results of Test Item .....</b>	<b>24</b>
7.1 RF Output Power .....	24
7.2 Power Spectral Density .....	25
7.3 AC Power Conducted Emissions .....	26
7.4 Unwanted Emissions below 1 GHz .....	28
7.5 Unwanted Emissions above 1 GHz.....	30
<b>8 Pictures of Test Arrangements .....</b>	<b>38</b>
<b>9 Information of the Testing Laboratories .....</b>	<b>39</b>



## Release Control Record

Issue No.	Description	Date Issued
RFBDKG-WTW-P20100478B	Original release.	2024/3/6

## 1 Certificate

**Product:** 2.4GHz USB Transceiver

**Brand:** Logitech

**Test Model:** C-U0011

**Sample Status:** Engineering sample

**Applicant:** LOGITECH FAR EAST LTD.

**Test Date:** 2023/12/12 ~ 2024/2/2

**Standard:** 47 CFR FCC Part 15, Subpart C (Section 15.247)

**Measurement** ANSI C63.10-2013

**procedure:** KDB 558074 D01 15.247 Meas Guidance v05r02

The above equipment has been tested by **Bureau Veritas Consumer Products Services (H.K.) Ltd., Taoyuan Branch**, and found compliance with the requirement of the above standards. The test record, data evaluation & Equipment Under Test (EUT) configurations represented herein are true and accurate accounts of the measurements of the sample's RF characteristics under the conditions specified in this report.

## 2 Summary of Test Results

47 CFR FCC Part 15, Subpart C (Section 15.247)			
Standard / Clause	Test Item	Result	Remark
15.247(b)	RF Output Power	Pass	Meet the requirement of limit.
15.247(e)	Power Spectral Density	Pass	Meet the requirement of limit.
15.247(a)(2)	6 dB Bandwidth	NA	Refer to Note 1 below
15.247(d)	Conducted Out of Band Emissions	NA	Refer to Note 1 below
15.207	AC Power Conducted Emissions	Pass	Minimum passing margin is -16.85 dB at 0.37266 MHz
15.205 / 15.209 / 15.247(d)	Unwanted Emissions below 1 GHz	Pass	Minimum passing margin is -9.1 dB at 30.11 MHz
15.205 / 15.209 / 15.247(d)	Unwanted Emissions above 1 GHz	Pass	Minimum passing margin is -7.4 dB at 2483.50 MHz
15.203	Antenna Requirement	Pass	No antenna connector is used.

Note:

- RF output power, Power Spectral Density, AC power conducted emission and unwanted emissions were performed for this addendum. The others testing data refer to original test report.
- Determining compliance based on the results of the compliance measurement, not taking into account measurement instrumentation uncertainty.

### 2.1 Measurement Uncertainty

Where relevant, the following measurement uncertainty levels have been estimated for tests performed on the EUT as specified in CISPR 16-4-2:

Parameter	Specification	Uncertainty (±)
RF Output Power	-	1.1 dB
AC Power Conducted Emissions	150 kHz ~ 30 MHz	1.9 dB
Unwanted Emissions above 1 GHz	1 GHz ~ 18 GHz	5.0 dB
	18 GHz ~ 40 GHz	5.3 dB

The other instruments specified are routine verified to remain within the calibrated levels, no measurement uncertainty is required to be calculated.

### 2.2 Supplementary Information

There is not any deviation from the test standards for the test method, and no modifications required for compliance.

### 3 General Information

#### 3.1 General Description

Product	2.4GHz USB Transceiver
Brand	Logitech
Test Model	C-U0011
Status of EUT	Engineering sample
Power Supply Rating	5 Vdc from USB interface
Modulation Type	GFSK
Modulation Technology	DTS
Transfer Rate	2 Mbps
Operating Frequency	2.405 GHz ~ 2.474 GHz
Number of Channel	12
Output Power	1.002 mW (0.01 dBm)

Note:

- This is a supplementary report of Report No.: RFBDKG-WTW-P20100478. The differences between them are as below information:
  - ◆ RF components and some of capacitors be changed with different size (involved C1,C5,C6,C9,C10,L1,C13,C2,L2,L3).
  - ◆ Antenna gain changed from -3.48 dBi to 1.75 dBi and rename antenna type.
- According to above conditions, only RF output power, Power Spectral Density, AC power conducted emission and unwanted emissions test items need to be performed. And all data was verified to meet the requirements.
- The EUT may have a lot of colors for marketing requirement.
- The above EUT information is declared by manufacturer and for more detailed features description, please refer to the manufacturer's specifications or User's Manual.

### 3.2 Antenna Description of EUT

1. The antenna information is listed as below.

Antenna Gain (dBi)	Frequency Range (GHz)	Antenna Type	Connector Type
1.75	2.4-2.4835	Printed Inverted F Antenna	None

\* Detail antenna specification please refer to antenna datasheet and/or antenna measurement report.

### 3.3 Channel List

12 channels are provided to this EUT:

Channel	Frequency (MHz)	Channel	Frequency (MHz)
1	2405	7	2441
2	2408	8	2444
3	2414	9	2462
4	2417	10	2465
5	2432	11	2471
6	2435	12	2474



### 3.4 Test Mode Applicability and Tested Channel Detail

Pre-Scan:	1. Pre-Scan has been conducted to determine the worst-case mode from all possible combinations between available modulations, data rates and antenna ports (if EUT with antenna diversity architecture).
-----------	--

Following channel(s) was (were) selected for the final test as listed below:

Test Item	Tested Channel	Modulation	Data Rate Parameter
RF Output Power	1, 8, 12	GFSK	2Mb/s
Power Spectral Density	1, 8, 12	GFSK	2Mb/s
AC Power Conducted Emissions	12	GFSK	2Mb/s
Unwanted Emissions below 1 GHz	12	GFSK	2Mb/s
Unwanted Emissions above 1 GHz	1, 8, 12	GFSK	2Mb/s

Note: In the original report:

The worst case was found when positioned on X-plane.

### 3.5 Duty Cycle of Test Signal

**GFSK:** Duty cycle =  $3.336 \text{ ms} / 3.425 \text{ ms} \times 100\% = 97.4\%$

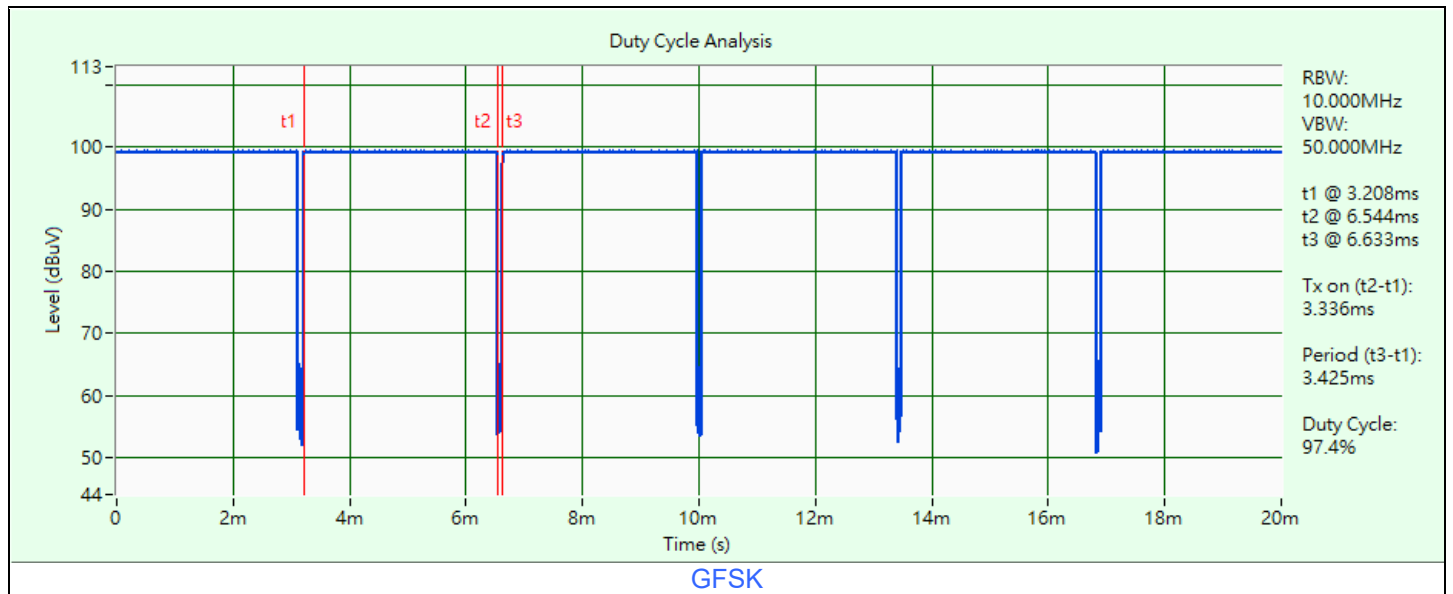

### 3.6 Test Program Used and Operation Descriptions

Controlling software (RF Sample with Receiver [Number Lock]) has been activated to set the EUT under transmission condition continuously at specific channel frequency.

Test Item	Operation Description
RF Output Power Power Spectral Density AC Power Conducted Emissions Unwanted Emissions	Modulated carrier 2.405 GHz Modulated carrier 2.444 GHz Modulated carrier 2.474 GHz

### 3.7 Connection Diagram of EUT and Peripheral Devices

#### For Unwanted Emission test:

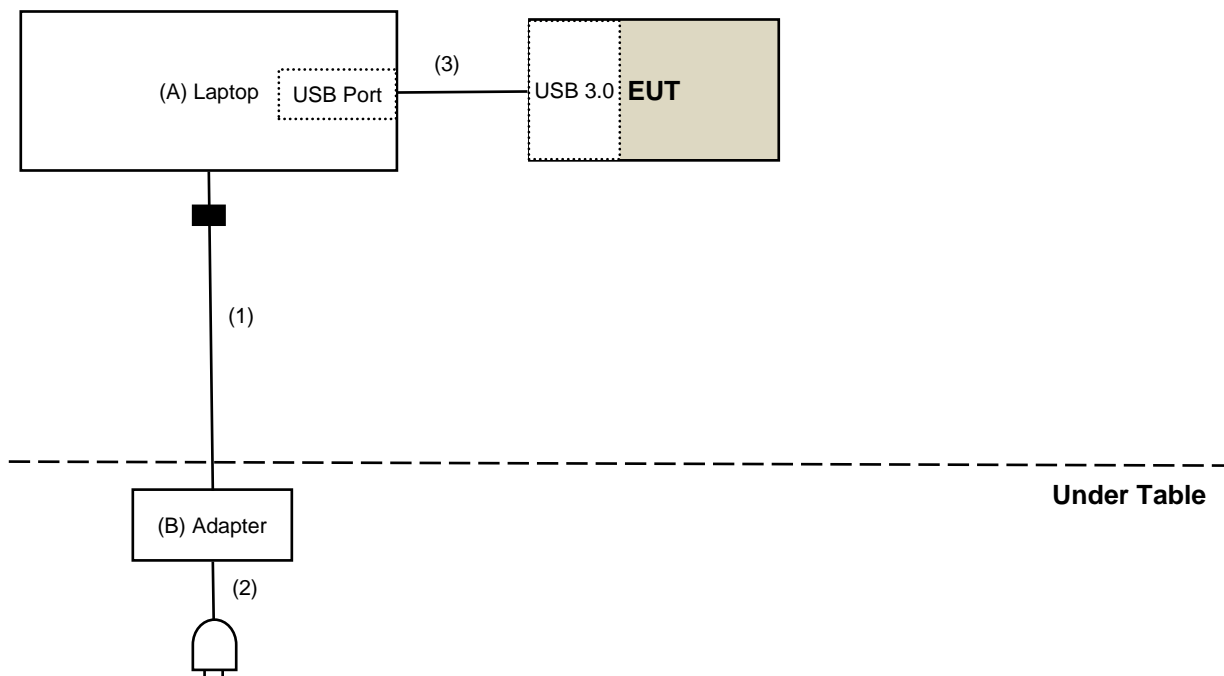

#### For AC Power Conducted Emission Test:

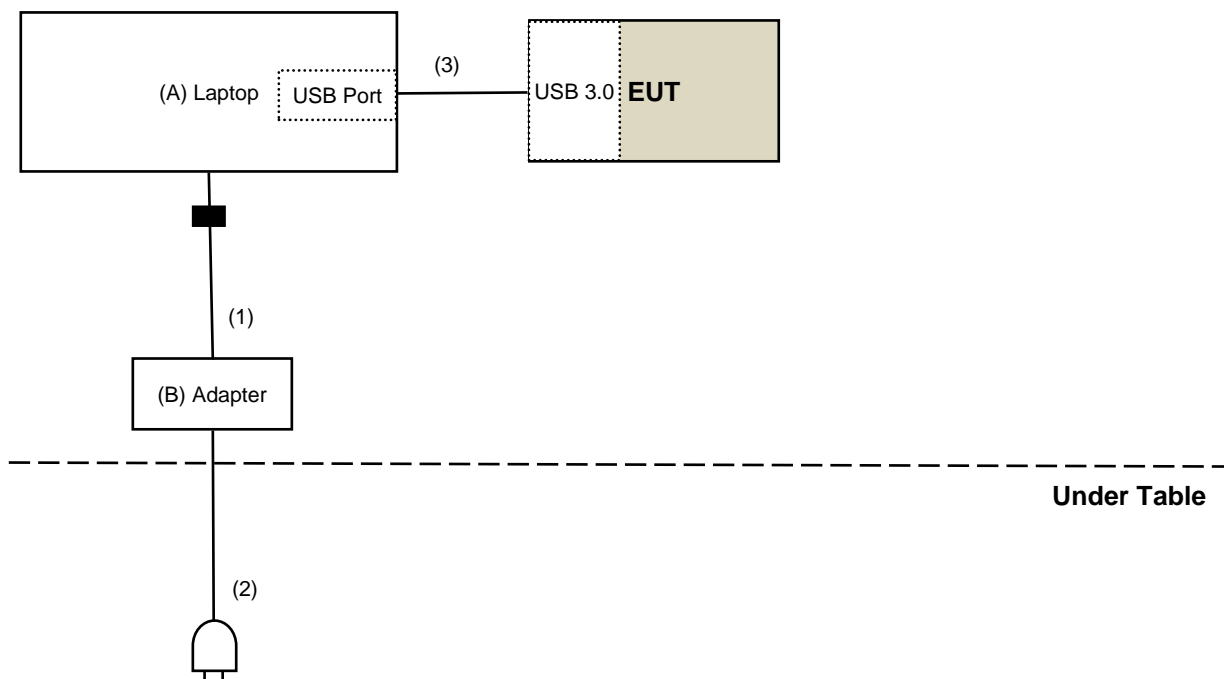

### 3.8 Configuration of Peripheral Devices and Cable Connections

ID	Product	Brand	Model No.	Serial No.	FCC ID	Remarks
A	Laptop	DELL	E6420	H62T3R1	DoC	Provided by Lab
B	Adapter	DELL	LA90PE-01	N/A	N/A	Provided by Lab

ID	Cable Descriptions	Qty.	Length (m)	Shielding (Yes/No)	Cores (Qty.)	Remarks
1	DC Cable	1	0.9	NO	1	Provided by Lab
2	AC Cable	1	1.8	NO	0	Provided by Lab
3	USB Cable	1	1.5	YES	0	Provided by Lab

## 4 Test Instruments

The calibration interval of the all test instruments are 12 months and the calibrations are traceable to NML/ROC and NIST/USA.

### 4.1 RF Output Power

Description Manufacturer	Model No.	Serial No.	Calibrated Date	Calibrated Until
Power Meter Anritsu	ML2495A	1529002	2023/6/17	2024/6/16
Pulse Power Sensor Anritsu	MA2411B	1726434	2023/6/19	2024/6/18

Notes:

1. The test was performed in Oven room 2.
2. Tested Date: 2023/12/20

### 4.2 Power Spectral Density

Description Manufacturer	Model No.	Serial No.	Calibrated Date	Calibrated Until
MXA Signal Analyzer Keysight	N9020B	MY60112409	2023/2/18	2024/2/17
Software	ADT_RF Test Software V7.6.5.4	N/A	N/A	N/A

Notes:

1. The test was performed in Oven room 2.
2. Tested Date: 2024/2/2

### 4.3 AC Power Conducted Emissions

Description Manufacturer	Model No.	Serial No.	Calibrated Date	Calibrated Until
50 ohm terminal resistance Telegartner	50 ohm	3	2023/10/20	2024/10/19
EMI Test Receiver R&S	ESCS 30	847124/029	2023/10/18	2024/10/17
Fixed Attenuator STI	STI02-2200-10	005	2023/7/1	2024/6/30
LISN R&S	ESH3-Z5	835239/001	2023/4/6	2024/4/5
		848773/004	2023/10/13	2024/10/12
RF Coaxial Cable JYEBAO	5D-FB	COCCAB-001	2023/7/1	2024/6/30
Software BVADT	BVADT_Cond_V7.3.7.4	N/A	N/A	N/A

Notes:

1. The test was performed in Conduction 1
2. Tested Date: 2023/12/20 ~ 2023/12/25

#### 4.4 Unwanted Emissions below 1 GHz

Description Manufacturer	Model No.	Serial No.	Calibrated Date	Calibrated Until
Antenna Tower & Turn Table Max-Full	MF-7802	MF780208406	N/A	N/A
Bi_Log Antenna Schwarzbeck	VULB 9168	9168-361	2023/10/13	2024/10/12
Fix tool for Boresight antenna tower BV	FBA-01	FBA_SIP01	N/A	N/A
Fixed Attenuator Mini-Circuits	UNAT-5+	PAD-3m-3-01	2023/9/7	2024/9/6
Loop Antenna Electro-Metrics	EM-6879	264	2023/2/21	2024/2/20
MXE EMI Receiver Agilent	N9038A	MY50010156	2023/6/13	2024/6/12
Preamplifier EMCI	EMC330N	980852	2023/2/20	2024/2/19
	EMC001340	980142	2023/5/8	2024/5/7
RF Coaxial Cable JYEBAO	5D-FB	LOOPCAB-001	2023/12/12	2024/12/11
		LOOPCAB-002	2023/12/12	2024/12/11
RF Coaxial Cable PEWC	8D	966-3-2	2023/2/17	2024/2/16
		966-3-3	2023/2/17	2024/2/16
		966-4-1	2023/2/18	2024/2/17
Software	ADT_Radiated_V8.7.08	N/A	N/A	N/A

Notes:

1. The test was performed in 966 Chamber No. 3.
2. Tested Date: 2023/12/13

#### 4.5 Unwanted Emissions above 1 GHz

Description Manufacturer	Model No.	Serial No.	Calibrated Date	Calibrated Until
Antenna Tower & Turn Table Max-Full	MF-7802	MF780208406	N/A	N/A
Fix tool for Boresight antenna tower BV	FBA-01	FBA_SIP01	N/A	N/A
Horn Antenna Schwarzbeck	BBHA 9120D	9120D-406	2023/11/12	2024/11/11
	BBHA 9170	9170-739	2023/11/12	2024/11/11
MXE EMI Receiver Agilent	N9038A	MY50010156	2023/6/13	2024/6/12
Preamplifier EMCI	EMC12630SE	980384	2023/8/9	2024/8/8
	EMC184045SE	980387	2023/8/9	2024/8/8
PXA Signal Analyzer Keysight	N9030B	MY57142938	2023/4/6	2024/4/5
RF Coaxial Cable EMCI	EMC-KM-KM-4000	200214	2023/2/20	2024/2/19
	EMC102-KM-KM-1200	160924	2023/8/9	2024/8/8
	EMC104-SM-SM-1500	180504	2023/3/27	2024/3/26
	EMC104-SM-SM-2000	180601	2023/6/2	2024/6/1
	EMC104-SM-SM-6000	210201	2023/5/8	2024/5/7
Software	ADT_Radiated_V8.7.08	N/A	N/A	N/A

Notes:

3. The test was performed in 966 Chamber No. 3.
4. Tested Date: 2023/12/12 ~ 2023/12/13



## 5 Limits of Test Items

### 5.1 RF Output Power

For systems using digital modulation in the 2400–2483.5 MHz bands: 1 Watt (30 dBm)

### 5.2 Power Spectral Density

The Maximum of Power Spectral Density Measurement is 8 dBm in any 3 kHz.

### 5.3 AC Power Conducted Emissions

Frequency (MHz)	Conducted Limit (dBuV)	
	Quasi-peak	Average
0.15 - 0.5	66 - 56	56 - 46
0.50 - 5.0	56	46
5.0 - 30.0	60	50

Notes:

1. The lower limit shall apply at the transition frequencies.
2. The limit decreases in line with the logarithm of the frequency in the range of 0.15 to 0.50 MHz.

### 5.4 Unwanted Emissions below 1 GHz

Radiated emissions up to 1 GHz which fall in the restricted bands must comply with the radiated emission limits specified as below table. Other emissions shall be at least 20 dB below the highest level of the desired power:

Frequencies (MHz)	Field Strength (microvolts/meter)	Measurement Distance (meters)
0.009 ~ 0.490	2400/F(kHz)	300
0.490 ~ 1.705	24000/F(kHz)	30
1.705 ~ 30.0	30	30
30 ~ 88	100	3
88 ~ 216	150	3
216 ~ 960	200	3
Above 960	500	3

Notes:

1. The lower limit shall apply at the transition frequencies.
2. Emission level (dBuV/m) = 20 log Emission level (uV/m).

## 5.5 Unwanted Emissions above 1 GHz

Radiated emissions above 1 GHz which fall in the restricted bands must comply with the radiated emission limits specified as below table. Other emissions shall be at least 20 dB below the highest level of the desired power:

Frequencies (MHz)	Field Strength (microvolts/meter)	Measurement Distance (meters)
Above 960	500	3

### Notes:

1. The lower limit shall apply at the transition frequencies.
2. Emission level (dBuV/m) = 20 log Emission level (uV/m).
3. For frequencies above 1000 MHz, the field strength limits are based on average detector, however, the peak field strength of any emission shall not exceed the maximum permitted average limits, specified above by more than 20 dB under any condition of modulation.

## 6 Test Arrangements

### 6.1 RF Output Power

#### 6.1.1 Test Setup

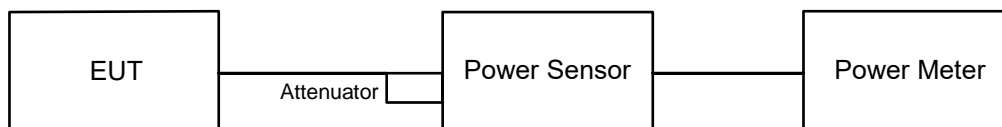

#### 6.1.2 Test Procedure

##### Peak Power:

A peak power sensor was used on the output port of the EUT. A power meter was used to read the response of the peak power sensor. Record the power level.

##### Average Power:

Average power sensor was used to perform output power measurement, trigger and gating function of wide band power meter is enabled to measure max output power of TX on burst. Duty factor is not added to measured value.

### 6.2 Power Spectral Density

#### 6.2.1 Test Setup

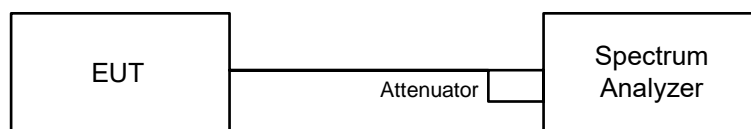

#### 6.2.2 Test Procedure

- a. Set analyzer center frequency to DTS channel center frequency.
- b. Set the span to 1.5 times the DTS bandwidth.
- c. Set the RBW to: 3 kHz.
- d. Set the VBW  $\geq 3 \times$  RBW.
- e. Detector = peak.
- f. Sweep time = auto couple.
- g. Trace mode = max hold.
- h. Allow trace to fully stabilize.
- i. Use the peak marker function to determine the maximum amplitude level within the RBW.

## 6.3 AC Power Conducted Emissions

### 6.3.1 Test Setup

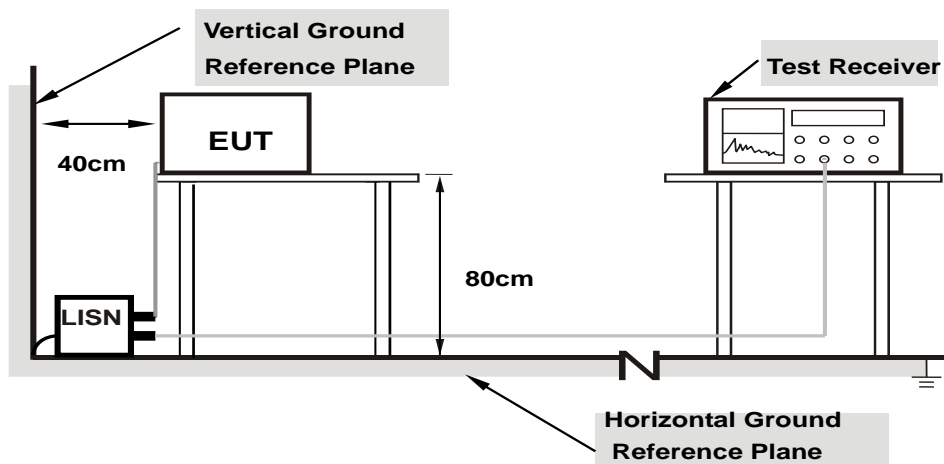

**Note: 1.Support units were connected to second LISN.**

For the actual test configuration, please refer to the attached file (Test Setup Photo).

### 6.3.2 Test Procedure

- The EUT was placed on a 0.8 meter to the top of table and placed 0.4 meters from the conducting wall of the shielded room with EUT being connected to the power mains through a line impedance stabilization network (LISN). Other support units were connected to the power mains through another LISN. The two LISNs provide 50 ohm/ 50 uH of coupling impedance for the measuring instrument.
- Both lines of the power mains connected to the EUT were checked for maximum conducted interference.
- The frequency range from 150 kHz to 30 MHz was searched. Emission levels under (Limit – 20 dB) was not recorded.

Note: The resolution bandwidth and video bandwidth of test receiver is 9 kHz for quasi-peak detection (QP) and average detection (AV) at frequency 0.15 MHz-30 MHz.

## 6.4 Unwanted Emissions below 1 GHz

### 6.4.1 Test Setup

#### For Radiated emission below 30 MHz

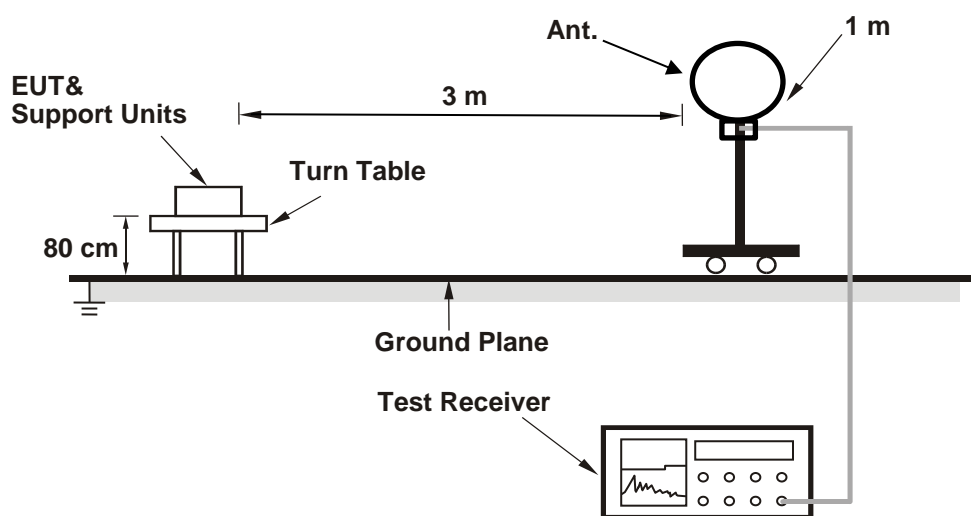

#### For Radiated emission above 30 MHz

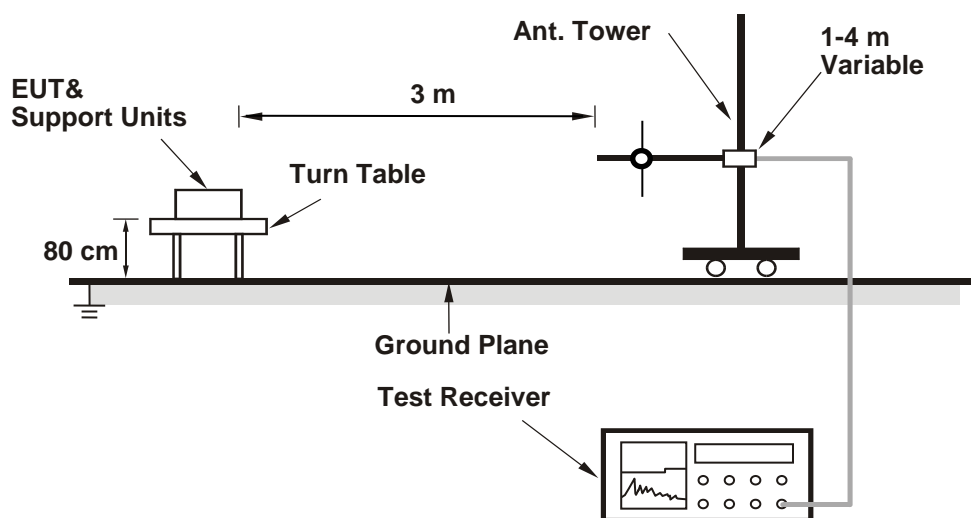

For the actual test configuration, please refer to the attached file (Test Setup Photo).

## 6.4.2 Test Procedure

### For Radiated emission below 30 MHz

- a. The EUT was placed on the top of a rotating table 0.8 meters above the ground at 3 meter chamber room for test. The table was rotated 360 degrees to determine the position of the highest radiation.
- b. The EUT was set 3 meters away from the interference-receiving antenna, which was mounted on the top of a variable-height antenna tower.
- c. Parallel, perpendicular, and ground-parallel orientations of the antenna are set to make the measurement.
- d. For each suspected emission, the EUT was arranged to its worst case and the rotatable table was turned from 0 degrees to 360 degrees to find the maximum reading.
- e. The test-receiver system was set to Quasi-Peak Detect Function and Specified Bandwidth with Maximum Hold Mode, except for the frequency band (9 kHz to 90 kHz and 110 kHz to 490 kHz) set to average detect function and peak detect function.

#### Notes:

1. The resolution bandwidth and video bandwidth of test receiver/spectrum analyzer is 200 Hz at frequency below 150 kHz.
2. The resolution bandwidth and video bandwidth of test receiver/spectrum analyzer is 9 kHz or 10 kHz at frequency (150 kHz to 30 MHz).
3. All modes of operation were investigated and the worst-case emissions are reported.

### For Radiated emission above 30 MHz

- a. The EUT was placed on the top of a rotating table 0.8 meters above the ground at 3 meter chamber room for test. The table was rotated 360 degrees to determine the position of the highest radiation.
- b. The EUT was set 3 meters away from the interference-receiving antenna, which was mounted on the top of a variable-height antenna tower.
- c. The height of antenna is varied from one meter to four meters above the ground to determine the maximum value of the field strength. Both horizontal and vertical polarizations of the antenna are set to make the measurement.
- d. For each suspected emission, the EUT was arranged to its worst case and then the antenna was tuned to heights from 1 meter to 4 meters and the rotatable table was turned from 0 degrees to 360 degrees to find the maximum reading.
- e. The test-receiver system was set to quasi-peak detect function and specified bandwidth with maximum hold mode when the test frequency is below 1 GHz.

#### Notes:

1. The resolution bandwidth and video bandwidth of test receiver/spectrum analyzer is 120 kHz for Quasi-peak detection (QP) at frequency below 1 GHz.
2. All modes of operation were investigated and the worst-case emissions are reported.

## 6.5 Unwanted Emissions above 1 GHz

### 6.5.1 Test Setup

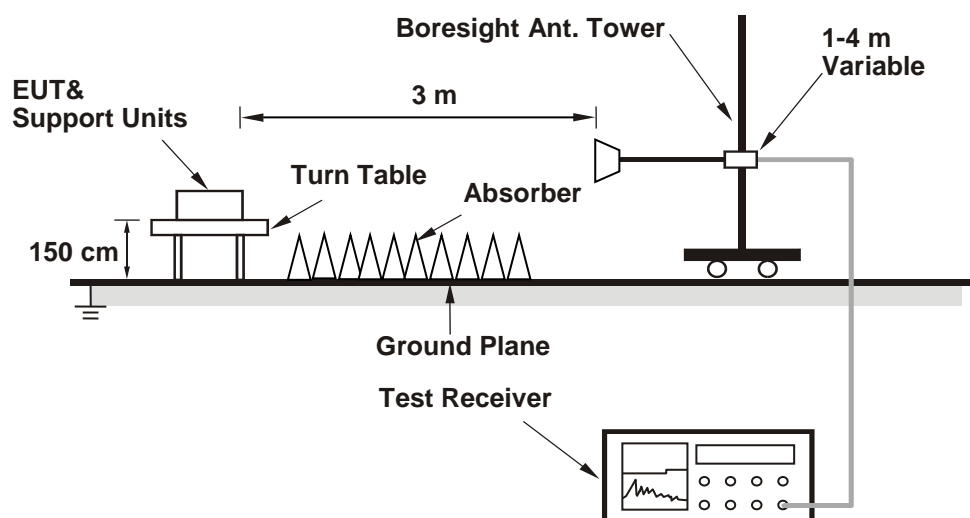

For the actual test configuration, please refer to the attached file (Test Setup Photo).

### 6.5.2 Test Procedure

- The EUT was placed on the top of a rotating table 1.5 meters above the ground at 3 meter chamber room for test. The table was rotated 360 degrees to determine the position of the highest radiation.
- The EUT was set 3 meters away from the interference-receiving antenna, which was mounted on the top of a variable-height antenna tower.
- The height of antenna is varied from one meter to four meters above the ground to determine the maximum value of the field strength. Both horizontal and vertical polarizations of the antenna are set to make the measurement.
- For each suspected emission, the EUT was arranged to its worst case and then the antenna was tuned to heights from 1 meter to 4 meters and the rotatable table was turned from 0 degrees to 360 degrees to find the maximum reading.
- The test-receiver/spectrum analyzer was set to peak and average detects function and specified bandwidth with maximum hold mode when the test frequency is above 1 GHz. If the peak reading value also meets average limit, measurement with the average detector is unnecessary.

#### Notes:

- The resolution bandwidth of test receiver/spectrum analyzer is 1 MHz and the video bandwidth is 3 MHz for Peak detection (PK) and Average detection (AV) at frequency above 1 GHz.
- For harmonic signal measurement, the resolution bandwidth of test receiver/spectrum analyzer is 1 MHz and the video bandwidth is  $\geq 1/T$  (Duty cycle < 98%) or 10 Hz (Duty cycle  $\geq 98\%$ ) for Average detection (AV) at frequency above 1 GHz.
- All modes of operation were investigated and the worst-case emissions are reported.

## 7 Test Results of Test Item

### 7.1 RF Output Power

Input Power:	5 Vdc	Environmental Conditions:	25°C, 60% RH	Tested By:	Katina Lu
--------------	-------	---------------------------	--------------	------------	-----------

#### For Peak Power

Chan.	Chan. Freq. (MHz)	Peak Power (mW)	Peak Power (dBm)	Power Limit (dBm)	Test Result
1	2405	0.7834	-1.06	30	Pass
8	2444	0.9311	-0.31	30	Pass
12	2474	1.002	0.01	30	Pass

Note: The antenna gain is 1.75 dBi < 6 dBi, so the output power limit shall not be reduced.

#### For Average Power

Chan.	Chan. Freq. (MHz)	Average Power (mW)	Average Power (dBm)
1	2405	0.7709	-1.13
8	2444	0.912	-0.40
12	2474	0.9931	-0.03



## 7.2 Power Spectral Density

Input Power:	5 Vdc	Environmental Conditions:	25°C, 60% RH	Tested By:	Katina Lu
--------------	-------	---------------------------	--------------	------------	-----------

Chan.	Chan. Freq. (MHz)	PSD (dBm/3kHz)	PSD Limit (dBm/3kHz)	Test Result
1	2405	-9.90	8	Pass
8	2444	-9.06	8	Pass
12	2474	-9.42	8	Pass

Note: The antenna gain is 1.75 dBi < 6 dBi, so the power density limit shall not be reduced.

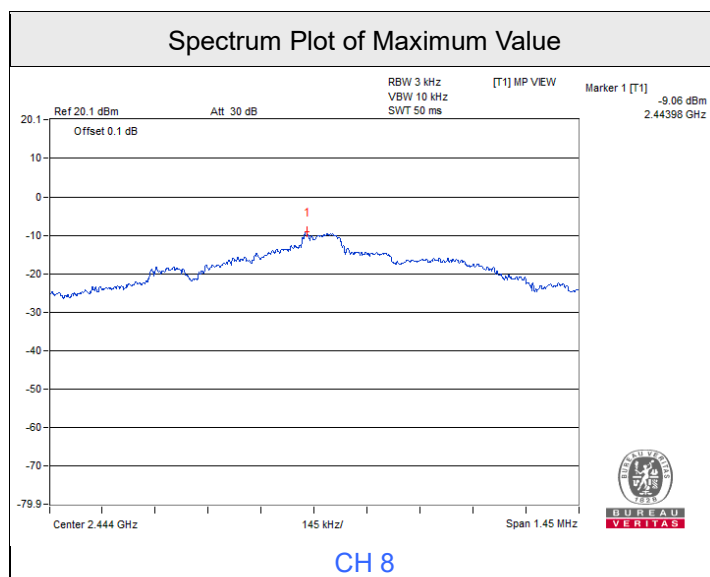

### 7.3 AC Power Conducted Emissions

RF Mode	GFSK	Channel	CH 12 : 2474 MHz
Frequency Range	150 kHz ~ 30 MHz	Detector Function & Resolution Bandwidth	Quasi-Peak (QP) / Average (AV), 9 kHz
Input Power (System)	120 Vac, 60 Hz	Environmental Conditions	20°C, 70% RH
Tested By	Louis Yang		

Phase Of Power : Line (L)										
No	Frequency (MHz)	Correction Factor (dB)	Reading Value (dBuV)		Emission Level (dBuV)		Limit (dBuV)		Margin (dB)	
			Q.P.	AV.	Q.P.	AV.	Q.P.	AV.	Q.P.	AV.
1	0.15391	9.93	37.29	25.93	47.22	35.86	65.79	55.79	-18.57	-19.93
<b>2</b>	<b>0.37266</b>	<b>9.94</b>	<b>27.60</b>	<b>21.65</b>	<b>37.54</b>	<b>31.59</b>	<b>58.44</b>	<b>48.44</b>	<b>-20.90</b>	<b>-16.85</b>
3	0.98203	9.97	14.18	9.29	24.15	19.26	56.00	46.00	-31.85	-26.74
4	3.61719	10.09	16.43	3.69	26.52	13.78	56.00	46.00	-29.48	-32.22
5	14.48047	10.76	16.79	9.18	27.55	19.94	60.00	50.00	-32.45	-30.06
6	22.59375	11.24	18.91	13.73	30.15	24.97	60.00	50.00	-29.85	-25.03

#### Remarks:

1. Q.P. and AV. are abbreviations of quasi-peak and average individually.
2. The emission levels of other frequencies were very low against the limit.
3. Margin value = Emission level – Limit value
4. Correction factor = Insertion loss + Cable loss
5. Emission Level = Correction Factor + Reading Value

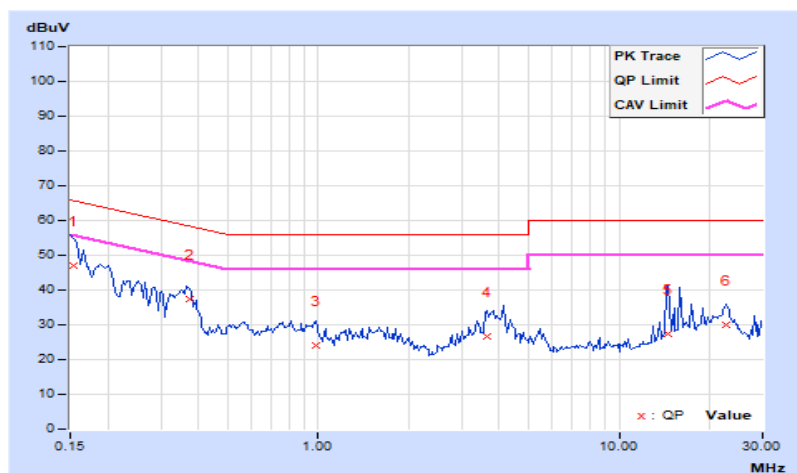

<b>RF Mode</b>	GFSK	<b>Channel</b>	CH 12 : 2474 MHz
<b>Frequency Range</b>	150 kHz ~ 30 MHz	<b>Detector Function &amp; Resolution Bandwidth</b>	Quasi-Peak (QP) / Average (AV), 9 kHz
<b>Input Power (System)</b>	120 Vac, 60 Hz	<b>Environmental Conditions</b>	20°C, 70% RH
<b>Tested By</b>	Louis Yang		

Phase Of Power : Neutral (N)										
No	Frequency (MHz)	Correction Factor (dB)	Reading Value (dBuV)		Emission Level (dBuV)		Limit (dBuV)		Margin (dB)	
			Q.P.	AV.	Q.P.	AV.	Q.P.	AV.	Q.P.	AV.
1	0.16562	9.99	34.97	15.54	44.96	25.53	65.18	55.18	-20.22	-29.65
2	0.22812	9.99	29.09	21.15	39.08	31.14	62.52	52.52	-23.44	-21.38
3	0.73594	10.01	15.26	3.95	25.27	13.96	56.00	46.00	-30.73	-32.04
4	1.50391	10.04	15.93	10.48	25.97	20.52	56.00	46.00	-30.03	-25.48
5	3.96094	10.15	17.43	4.86	27.58	15.01	56.00	46.00	-28.42	-30.99
6	23.13281	10.95	19.62	13.98	30.57	24.93	60.00	50.00	-29.43	-25.07

**Remarks:**

1. Q.P. and AV. are abbreviations of quasi-peak and average individually.
2. The emission levels of other frequencies were very low against the limit.
3. Margin value = Emission level – Limit value
4. Correction factor = Insertion loss + Cable loss
5. Emission Level = Correction Factor + Reading Value

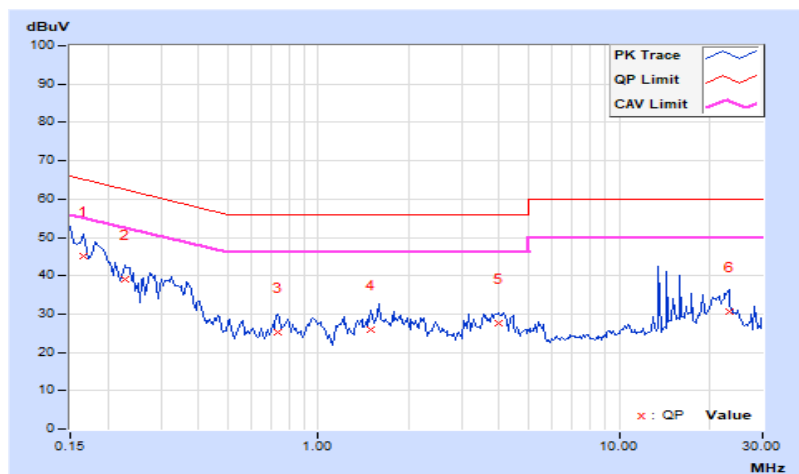

## 7.4 Unwanted Emissions below 1 GHz

<b>RF Mode</b>	GFSK	<b>Channel</b>	CH 12 : 2474 MHz
<b>Frequency Range</b>	30 MHz ~ 1 GHz	<b>Detector Function &amp; Bandwidth</b>	QP: RB=120kHz, DET=Quasi-Peak
<b>Input Power (System)</b>	120 Vac, 60 Hz	<b>Environmental Conditions</b>	25°C, 75% RH
<b>Tested By</b>	Louis Yang		

### Antenna Polarity & Test Distance : Horizontal at 3 m

No	Frequency (MHz)	Emission Level (dBuV/m)	Limit (dBuV/m)	Margin (dB)	Antenna Height (m)	Table Angle (Degree)	Raw Value (dBuV)	Correction Factor (dB/m)
1	30.11	30.9 QP	40.0	-9.1	1.50 H	227	39.6	-8.7
2	47.17	28.4 QP	40.0	-11.6	1.00 H	94	36.1	-7.7
3	105.02	30.7 QP	43.5	-12.8	2.50 H	249	41.4	-10.7
4	248.41	26.0 QP	46.0	-20.0	1.00 H	202	34.0	-8.0
5	321.21	32.4 QP	46.0	-13.6	1.00 H	246	37.4	-5.0
6	477.21	31.9 QP	46.0	-14.1	2.00 H	220	32.8	-0.9

### Remarks:

1. Emission Level(dBuV/m) = Raw Value(dBuV) + Correction Factor(dB/m)
2. Correction Factor(dB/m) = Antenna Factor(dB/m) + Cable Factor(dB) – Pre-Amplifier Factor(dB)
3. Margin value = Emission Level – Limit value
4. The other emission levels were very low against the limit of frequency range 30 MHz ~ 1 GHz.
5. The frequency range 9 kHz ~ 30 MHz: all emissions are more than 20 dB below the limit, therefore do not be recorded in this report.

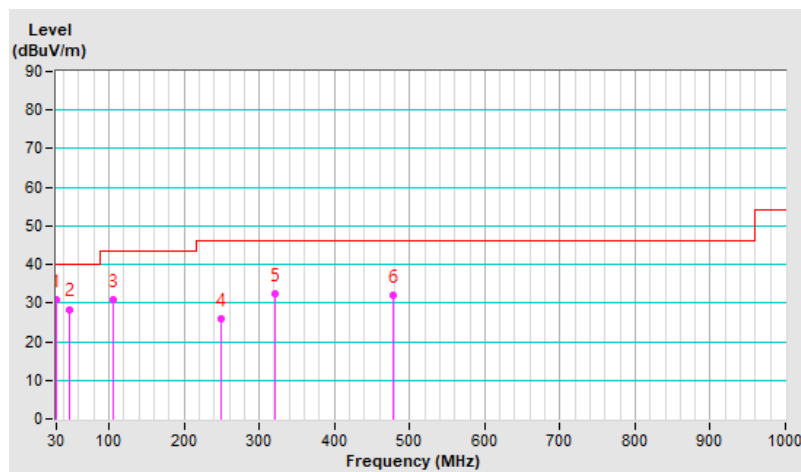

<b>RF Mode</b>	GFSK	<b>Channel</b>	CH 12 : 2474 MHz
<b>Frequency Range</b>	30 MHz ~ 1 GHz	<b>Detector Function &amp; Bandwidth</b>	QP: RB=120kHz, DET=Quasi-Peak
<b>Input Power (System)</b>	120 Vac, 60 Hz	<b>Environmental Conditions</b>	25°C, 75% RH
<b>Tested By</b>	Louis Yang		

Antenna Polarity & Test Distance : Vertical at 3 m								
No	Frequency (MHz)	Emission Level (dBuV/m)	Limit (dBuV/m)	Margin (dB)	Antenna Height (m)	Table Angle (Degree)	Raw Value (dBuV)	Correction Factor (dB/m)
1	33.61	29.5 QP	40.0	-10.5	1.50 V	46	38.2	-8.7
2	57.69	29.9 QP	40.0	-10.1	1.50 V	2	38.1	-8.2
3	98.24	30.8 QP	43.5	-12.7	1.50 V	1	42.9	-12.1
4	127.38	26.7 QP	43.5	-16.8	2.50 V	268	35.1	-8.4
5	163.91	29.2 QP	43.5	-14.3	1.00 V	25	36.4	-7.2
6	297.14	34.4 QP	46.0	-11.6	2.00 V	147	40.4	-6.0

**Remarks:**

1. Emission Level(dBuV/m) = Raw Value(dBuV) + Correction Factor(dB/m)
2. Correction Factor(dB/m) = Antenna Factor(dB/m) + Cable Factor(dB) – Pre-Amplifier Factor(dB)
3. Margin value = Emission Level – Limit value
4. The other emission levels were very low against the limit of frequency range 30 MHz ~ 1 GHz.
5. The frequency range 9 kHz ~ 30 MHz: all emissions are more than 20 dB below the limit, therefore do not be recorded in this report.

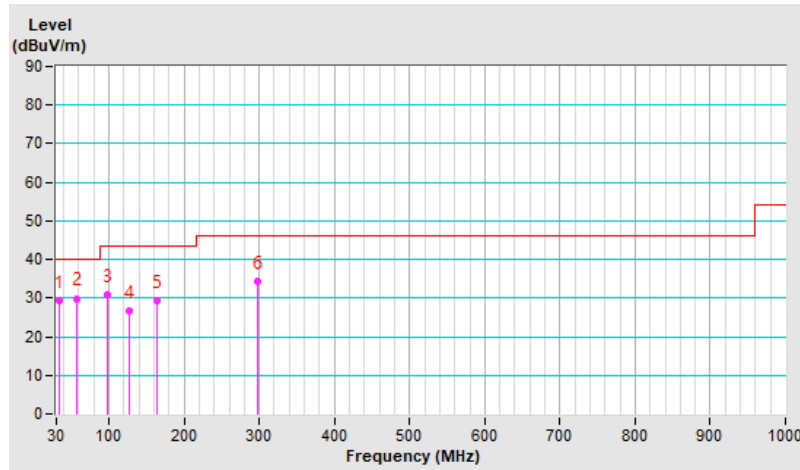

## 7.5 Unwanted Emissions above 1 GHz

<b>RF Mode</b>	GFSK	<b>Channel</b>	CH 1 : 2405 MHz
<b>Frequency Range</b>	1 GHz ~ 25 GHz	<b>Detector Function &amp; Bandwidth</b>	PK: RB=1 MHz, VB=3 MHz, DET=Peak AV: RB=1 MHz, VB=510 Hz, DET=Peak
<b>Input Power (System)</b>	120 Vac, 60 Hz	<b>Environmental Conditions</b>	21°C, 68% RH
<b>Tested By</b>	Louis Yang		

Antenna Polarity & Test Distance : Horizontal at 3 m								
No	Frequency (MHz)	Emission Level (dBuV/m)	Limit (dBuV/m)	Margin (dB)	Antenna Height (m)	Table Angle (Degree)	Raw Value (dBuV)	Correction Factor (dB/m)
1	2390.00	61.7 PK	74.0	-12.3	1.24 H	162	64.0	-2.3
2	2390.00	45.4 AV	54.0	-8.6	1.24 H	162	47.7	-2.3
3	*2405.00	99.2 PK			1.24 H	162	101.5	-2.3
4	*2405.00	97.6 AV			1.24 H	162	99.9	-2.3
5	4810.00	54.1 PK	74.0	-19.9	1.17 H	360	51.9	2.2
6	4810.00	45.1 AV	54.0	-8.9	1.17 H	360	42.9	2.2

### Remarks:

1. Emission Level(dBuV/m) = Raw Value(dBuV) + Correction Factor(dB/m)
2. Correction Factor(dB/m) = Antenna Factor(dB/m) + Cable Factor(dB) – Pre-Amplifier Factor(dB)
3. Margin value = Emission Level – Limit value
4. The other emission levels were very low against the limit.
5. " \* " : Fundamental frequency, the limit was restricted at the RF Output Power.

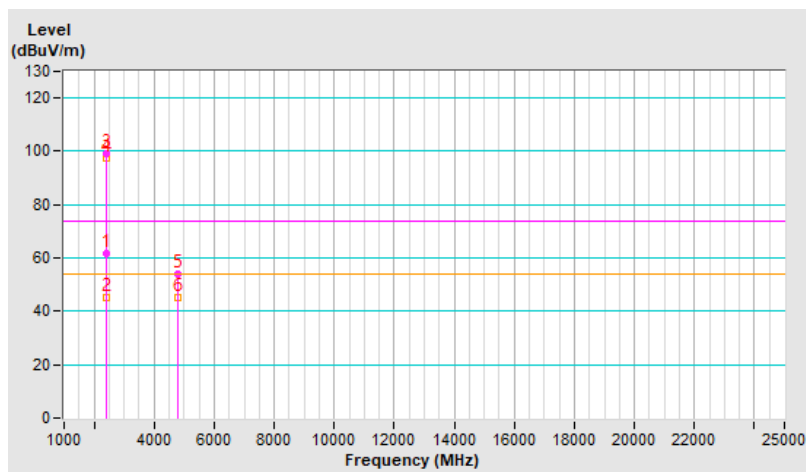

<b>RF Mode</b>	GFSK	<b>Channel</b>	CH 1 : 2405 MHz
<b>Frequency Range</b>	1 GHz ~ 25 GHz	<b>Detector Function &amp; Bandwidth</b>	PK: RB=1 MHz, VB=3 MHz, DET=Peak AV: RB=1 MHz, VB=510 Hz, DET=Peak
<b>Input Power (System)</b>	120 Vac, 60 Hz	<b>Environmental Conditions</b>	21°C, 68% RH
<b>Tested By</b>	Louis Yang		

Antenna Polarity & Test Distance : Vertical at 3 m								
No	Frequency (MHz)	Emission Level (dBuV/m)	Limit (dBuV/m)	Margin (dB)	Antenna Height (m)	Table Angle (Degree)	Raw Value (dBuV)	Correction Factor (dB/m)
1	2390.00	56.9 PK	74.0	-17.1	3.78 V	227	59.2	-2.3
2	2390.00	46.0 AV	54.0	-8.0	3.78 V	227	48.3	-2.3
3	*2405.00	94.3 PK			3.78 V	227	96.6	-2.3
4	*2405.00	92.7 AV			3.78 V	227	95.0	-2.3
5	4810.00	53.8 PK	74.0	-20.2	1.15 V	348	51.6	2.2
6	4810.00	45.0 AV	54.0	-9.0	1.15 V	348	42.8	2.2

**Remarks:**

1. Emission Level(dBuV/m) = Raw Value(dBuV) + Correction Factor(dB/m)
2. Correction Factor(dB/m) = Antenna Factor(dB/m) + Cable Factor(dB) – Pre-Amplifier Factor(dB)
3. Margin value = Emission Level – Limit value
4. The other emission levels were very low against the limit.
5. " \* " : Fundamental frequency, the limit was restricted at the RF Output Power.

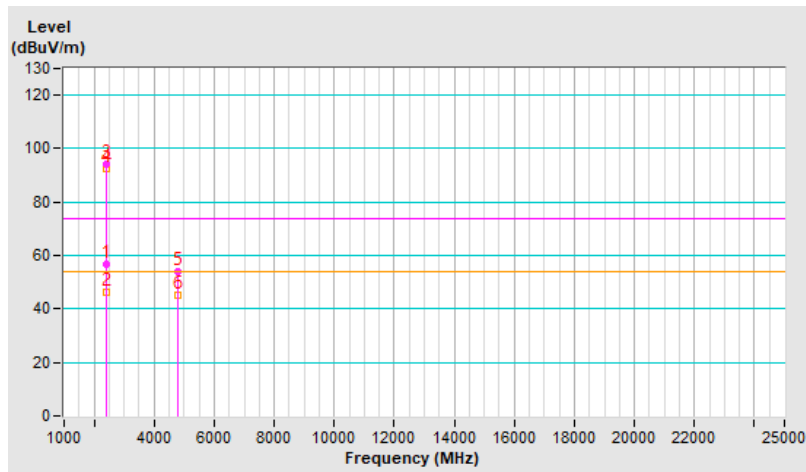

<b>RF Mode</b>	GFSK	<b>Channel</b>	CH 8 : 2444 MHz
<b>Frequency Range</b>	1 GHz ~ 25 GHz	<b>Detector Function &amp; Bandwidth</b>	PK: RB=1 MHz, VB=3 MHz, DET=Peak AV: RB=1 MHz, VB=510 Hz, DET=Peak
<b>Input Power (System)</b>	120 Vac, 60 Hz	<b>Environmental Conditions</b>	21°C, 68% RH
<b>Tested By</b>	Louis Yang		

Antenna Polarity & Test Distance : Horizontal at 3 m								
No	Frequency (MHz)	Emission Level (dBuV/m)	Limit (dBuV/m)	Margin (dB)	Antenna Height (m)	Table Angle (Degree)	Raw Value (dBuV)	Correction Factor (dB/m)
1	*2444.00	98.5 PK			1.23 H	173	100.7	-2.2
2	*2444.00	97.2 AV			1.23 H	173	99.4	-2.2
3	4888.00	55.1 PK	74.0	-18.9	1.21 H	360	53.1	2.0
4	4888.00	46.3 AV	54.0	-7.7	1.21 H	360	44.3	2.0
5	7332.00	46.1 PK	74.0	-27.9	2.53 H	46	38.4	7.7
6	7332.00	42.3 AV	54.0	-11.7	2.53 H	46	34.6	7.7

**Remarks:**

1. Emission Level(dBuV/m) = Raw Value(dBuV) + Correction Factor(dB/m)
2. Correction Factor(dB/m) = Antenna Factor(dB/m) + Cable Factor(dB) – Pre-Amplifier Factor(dB)
3. Margin value = Emission Level – Limit value
4. The other emission levels were very low against the limit.
5. " \* " : Fundamental frequency, the limit was restricted at the RF Output Power.

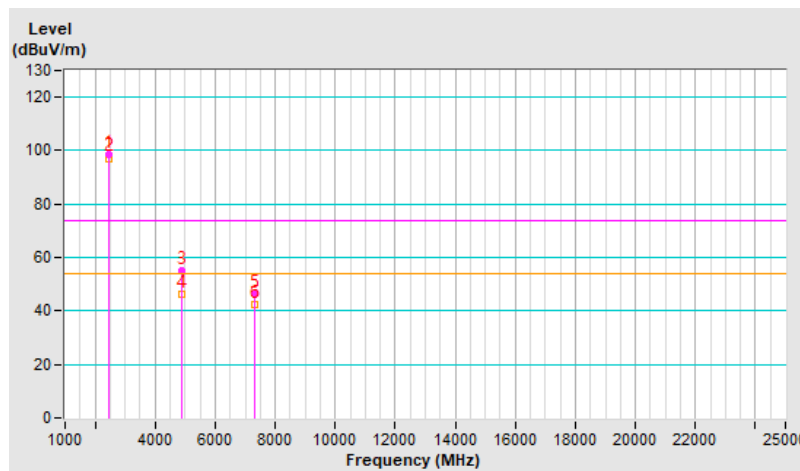



<b>RF Mode</b>	GFSK	<b>Channel</b>	CH 8 : 2444 MHz
<b>Frequency Range</b>	1 GHz ~ 25 GHz	<b>Detector Function &amp; Bandwidth</b>	PK: RB=1 MHz, VB=3 MHz, DET=Peak AV: RB=1 MHz, VB=510 Hz, DET=Peak
<b>Input Power (System)</b>	120 Vac, 60 Hz	<b>Environmental Conditions</b>	21°C, 68% RH
<b>Tested By</b>	Louis Yang		

Antenna Polarity & Test Distance : Vertical at 3 m								
No	Frequency (MHz)	Emission Level (dBuV/m)	Limit (dBuV/m)	Margin (dB)	Antenna Height (m)	Table Angle (Degree)	Raw Value (dBuV)	Correction Factor (dB/m)
1	*2444.00	94.3 PK			3.78 V	233	96.5	-2.2
2	*2444.00	92.5 AV			3.78 V	233	94.7	-2.2
3	4888.00	54.5 PK	74.0	-19.5	1.20 V	360	52.5	2.0
4	4888.00	45.4 AV	54.0	-8.6	1.20 V	360	43.4	2.0
5	7332.00	45.9 PK	74.0	-28.1	2.48 V	34	38.2	7.7
6	7332.00	42.3 AV	54.0	-11.7	2.48 V	34	34.6	7.7

**Remarks:**

1. Emission Level(dBuV/m) = Raw Value(dBuV) + Correction Factor(dB/m)
2. Correction Factor(dB/m) = Antenna Factor(dB/m) + Cable Factor(dB) – Pre-Amplifier Factor(dB)
3. Margin value = Emission Level – Limit value
4. The other emission levels were very low against the limit.
5. " \* " : Fundamental frequency, the limit was restricted at the RF Output Power.

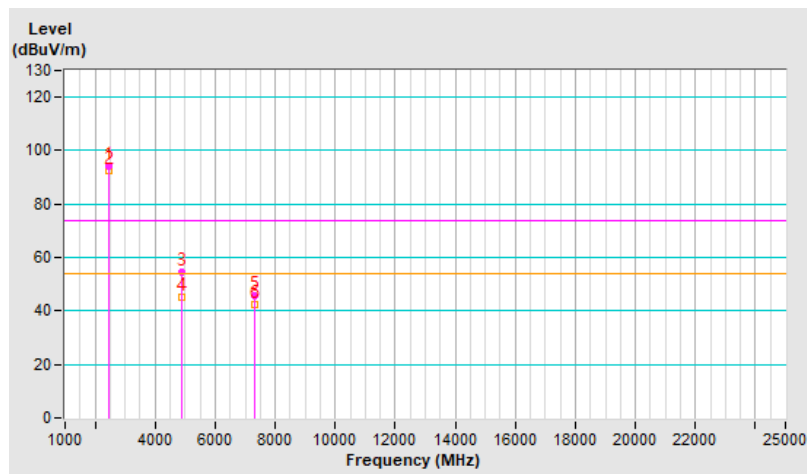

<b>RF Mode</b>	GFSK	<b>Channel</b>	CH 12 : 2474 MHz
<b>Frequency Range</b>	1 GHz ~ 25 GHz	<b>Detector Function &amp; Bandwidth</b>	PK: RB=1 MHz, VB=3 MHz, DET=Peak AV: RB=1 MHz, VB=510 Hz, DET=Peak
<b>Input Power (System)</b>	120 Vac, 60 Hz	<b>Environmental Conditions</b>	21°C, 68% RH
<b>Tested By</b>	Louis Yang		

Antenna Polarity & Test Distance : Horizontal at 3 m								
No	Frequency (MHz)	Emission Level (dBuV/m)	Limit (dBuV/m)	Margin (dB)	Antenna Height (m)	Table Angle (Degree)	Raw Value (dBuV)	Correction Factor (dB/m)
1	*2474.00	99.4 PK			1.05 H	166	101.6	-2.2
2	*2474.00	97.8 AV			1.05 H	166	100.0	-2.2
3	2483.50	63.0 PK	74.0	-11.0	1.05 H	166	65.3	-2.3
4	2483.50	44.8 AV	54.0	-9.2	1.05 H	166	47.1	-2.3
5	4948.00	55.2 PK	74.0	-18.8	1.26 H	360	53.0	2.2
6	4948.00	46.2 AV	54.0	-7.8	1.26 H	360	44.0	2.2
7	7422.00	45.6 PK	74.0	-28.4	2.54 H	41	37.6	8.0
8	7422.00	41.9 AV	54.0	-12.1	2.54 H	41	33.9	8.0

**Remarks:**

1. Emission Level(dBuV/m) = Raw Value(dBuV) + Correction Factor(dB/m)
2. Correction Factor(dB/m) = Antenna Factor(dB/m) + Cable Factor(dB) – Pre-Amplifier Factor(dB)
3. Margin value = Emission Level – Limit value
4. The other emission levels were very low against the limit.
5. " \* ": Fundamental frequency, the limit was restricted at the RF Output Power.

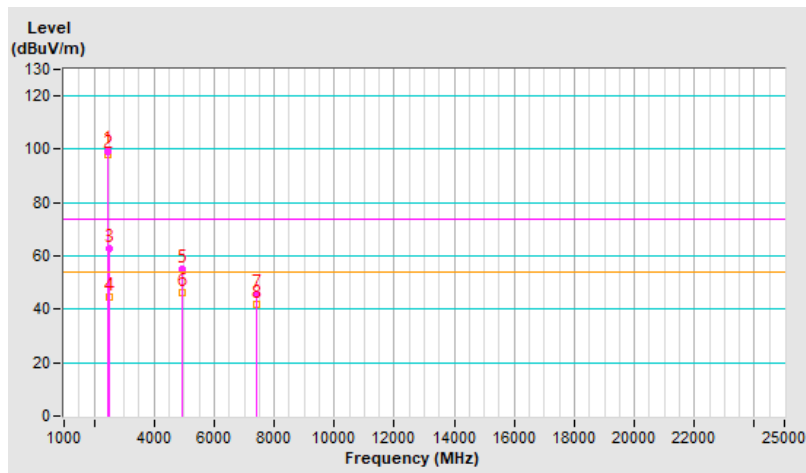

<b>RF Mode</b>	GFSK	<b>Channel</b>	CH 12 : 2474 MHz
<b>Frequency Range</b>	1 GHz ~ 25 GHz	<b>Detector Function &amp; Bandwidth</b>	PK: RB=1 MHz, VB=3 MHz, DET=Peak AV: RB=1 MHz, VB=510 Hz, DET=Peak
<b>Input Power (System)</b>	120 Vac, 60 Hz	<b>Environmental Conditions</b>	21°C, 68% RH
<b>Tested By</b>	Louis Yang		

Antenna Polarity & Test Distance : Vertical at 3 m								
No	Frequency (MHz)	Emission Level (dBuV/m)	Limit (dBuV/m)	Margin (dB)	Antenna Height (m)	Table Angle (Degree)	Raw Value (dBuV)	Correction Factor (dB/m)
1	*2474.00	94.2 PK			3.77 V	233	96.4	-2.2
2	*2474.00	92.8 AV			3.77 V	233	95.0	-2.2
3	2483.50	60.0 PK	74.0	-14.0	3.77 V	233	62.3	-2.3
<b>4</b>	<b>2483.50</b>	<b>46.6 AV</b>	<b>54.0</b>	<b>-7.4</b>	<b>3.77 V</b>	<b>233</b>	<b>48.9</b>	<b>-2.3</b>
5	4948.00	54.5 PK	74.0	-19.5	1.22 V	347	52.3	2.2
6	4948.00	45.3 AV	54.0	-8.7	1.22 V	347	43.1	2.2
7	7422.00	45.9 PK	74.0	-28.1	2.49 V	19	37.9	8.0
8	7422.00	42.4 AV	54.0	-11.6	2.49 V	19	34.4	8.0

**Remarks:**

1. Emission Level(dBuV/m) = Raw Value(dBuV) + Correction Factor(dB/m)
2. Correction Factor(dB/m) = Antenna Factor(dB/m) + Cable Factor(dB) – Pre-Amplifier Factor(dB)
3. Margin value = Emission Level – Limit value
4. The other emission levels were very low against the limit.
5. " \* ": Fundamental frequency, the limit was restricted at the RF Output Power.

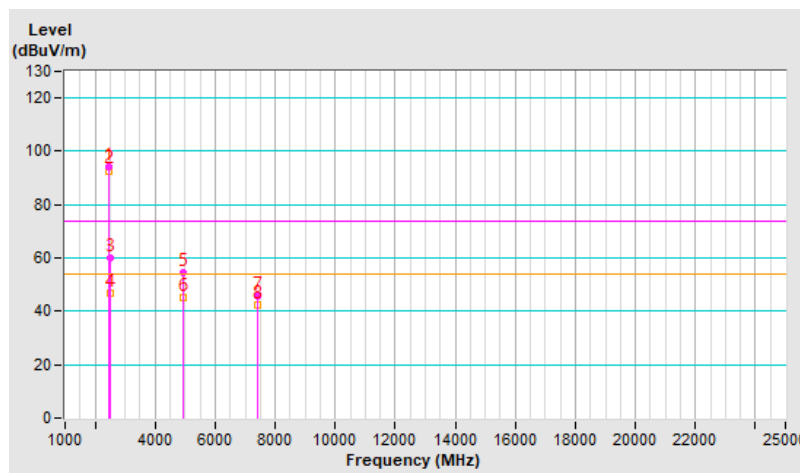

### Plot of Band Edge

Frequency Range	2.31 GHz ~ 2.5 GHz	Detector Function & Bandwidth	PK: RB=1 MHz, VB=3 MHz, DET=Peak AV: RB=1 MHz, VB=510 Hz, DET=Peak
-----------------	--------------------	-------------------------------	---

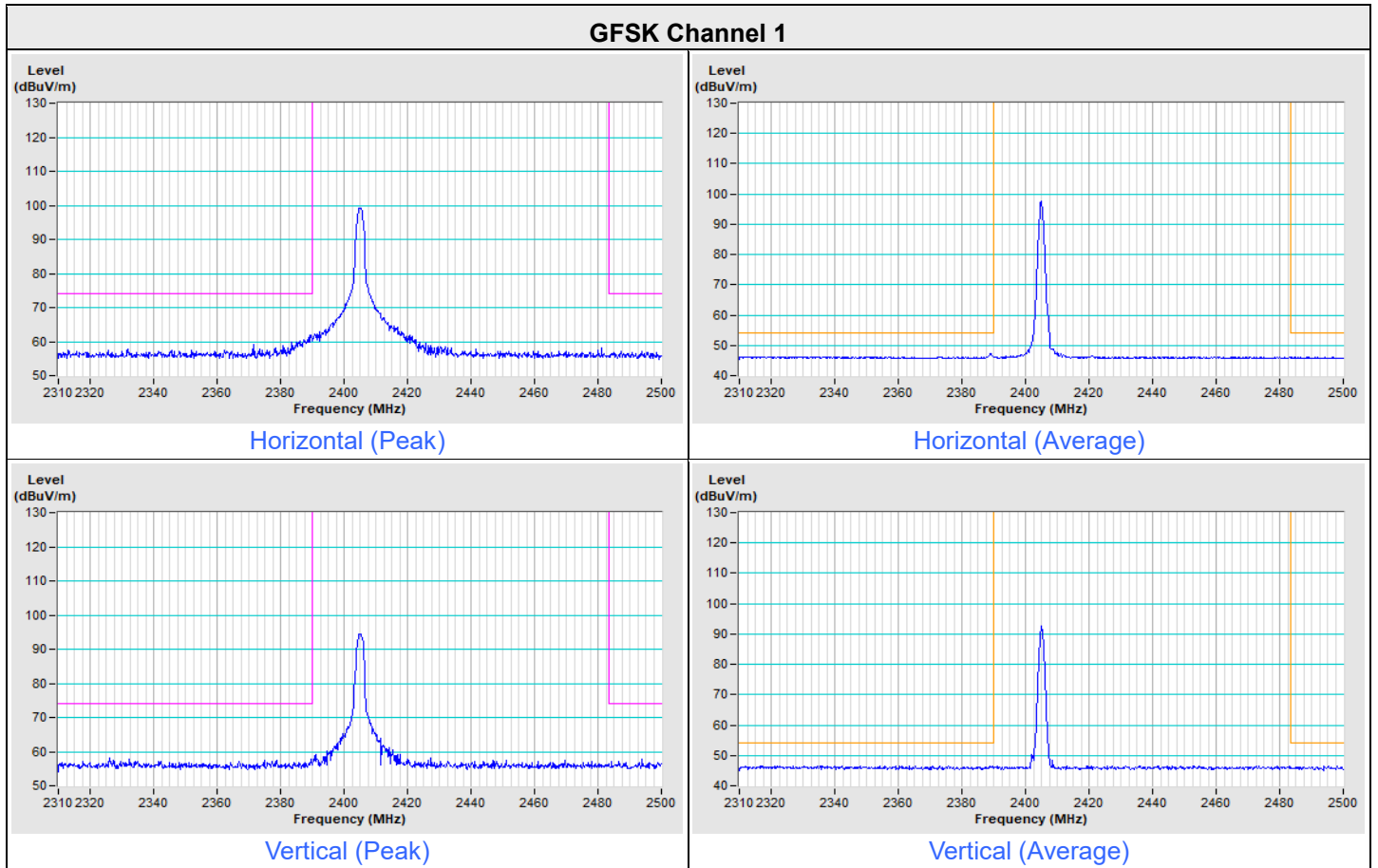

### GFSK Channel 12

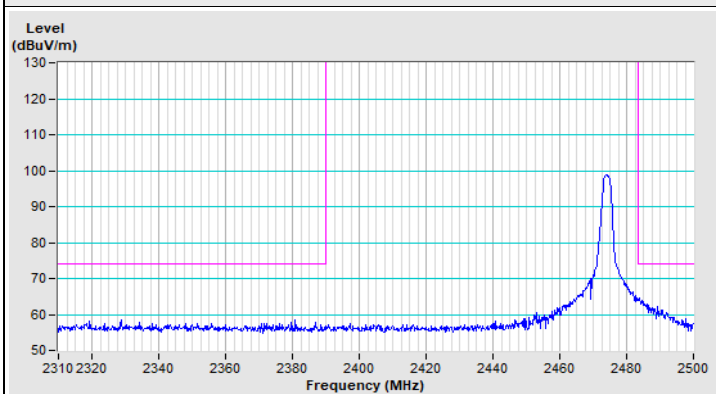

Horizontal (Peak)

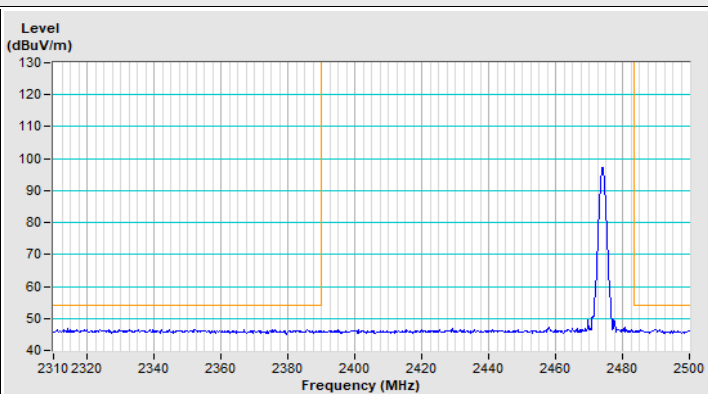

Horizontal (Average)

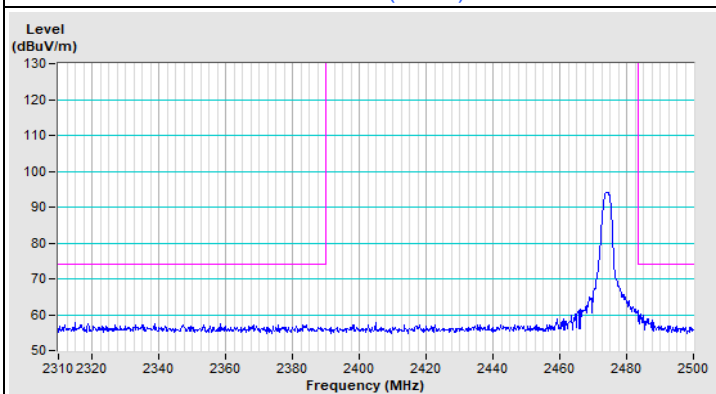

Vertical (Peak)

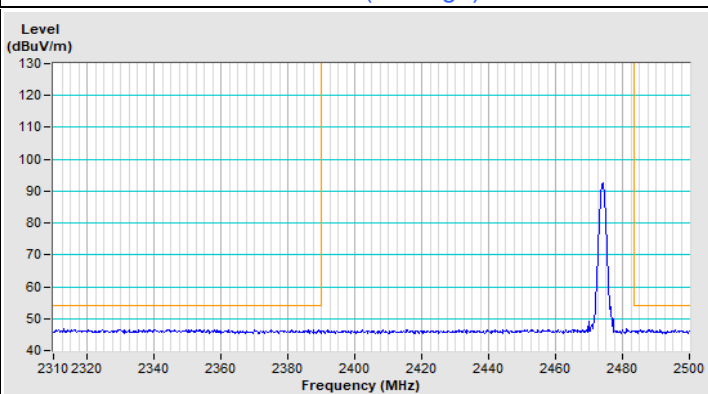

Vertical (Average)

## 8 Pictures of Test Arrangements

Please refer to the attached file (Test Setup Photo)

## 9 Information of the Testing Laboratories

We, Bureau Veritas Consumer Products Services (H.K.) Ltd., Taoyuan Branch, were founded in 1988 to provide our best service in EMC, Radio, Telecom and Safety consultation. Our laboratories are FCC recognized accredited test firms and accredited according to ISO/IEC 17025.

If you have any comments, please feel free to contact us at the following:

**Lin Kou EMC/RF Lab**

Tel: 886-2-26052180

Fax: 886-2-26051924

**Hsin Chu EMC/RF/Telecom Lab**

Tel: 886-3-6668565

Fax: 886-3-6668323

**Hwa Ya EMC/RF/Safety Lab**

Tel: 886-3-3183232

Fax: 886-3-3270892

**Email:** [service.adt@bureauveritas.com](mailto:service.adt@bureauveritas.com)

**Web Site:** <http://ee.bureauveritas.com.tw>

The address and road map of all our labs can be found in our web site also.

--- END ---