

FITS

SETUP GUIDE | 设置指南

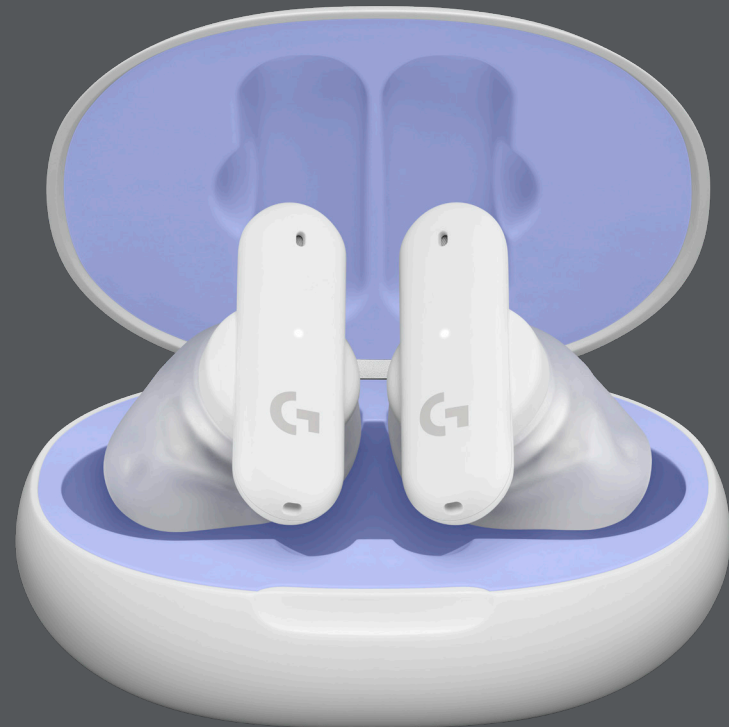

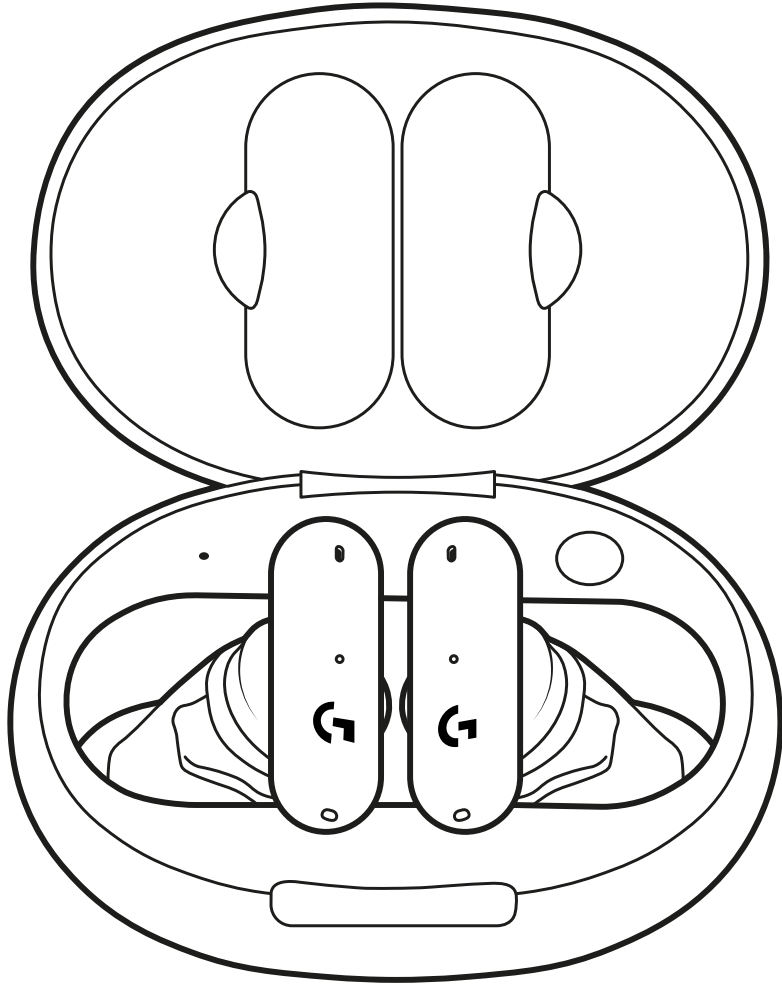

ENGLISH 3
简体中文 8
繁體中文 13
한국어 18

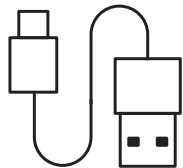
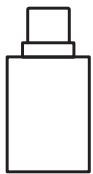
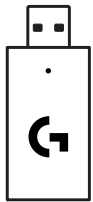

BLUETOOTH® CONNECTION

Connect to your phone, handheld gaming console, or other *Bluetooth*® compatible device.

- Place earbuds in the case. Press & hold case button for 3 seconds.
- Earbud LEDs will flash white as it enters pairing mode.

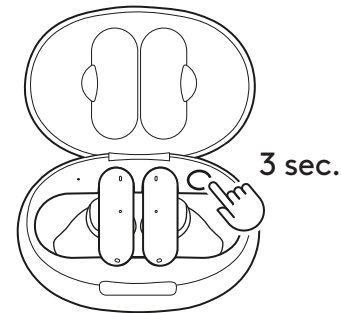

- Select Logitech G FITS from your device *Bluetooth*® connection settings.
- Remove earbuds from the case.

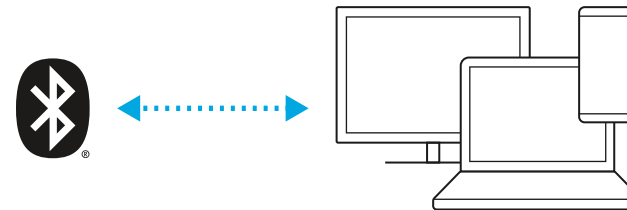

- Tap either the right or left earbud 3 times to switch between LIGHTSPEED and *Bluetooth*®. Tone will play to indicate a new source.

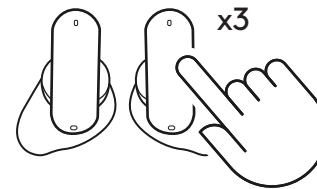

LIGHTSPEED CONNECTION

Connect to your PC, Mac, PlayStation 5, PlayStation 4 or docked Nintendo Switch with LIGHTSPEED Wireless Technology.

- Insert LIGHTSPEED receiver into the USB port of your device.

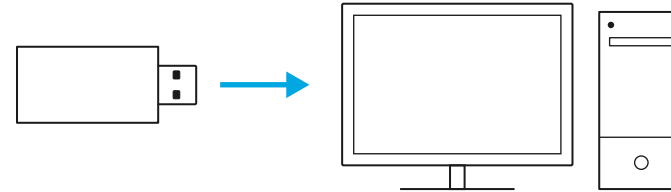

- Remove earbuds from the case.

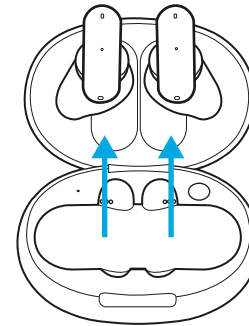

- The LED on the receiver turns solid white once connected.

- Tap either the right or left earbud 3 times to switch between LIGHTSPEED and Bluetooth®. Tone will play to indicate a new source.

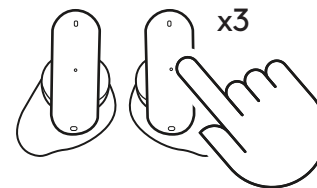



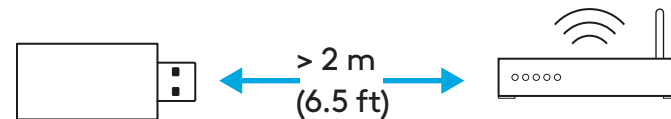



- Ensure receiver is at least 2 m away from the wifi router.

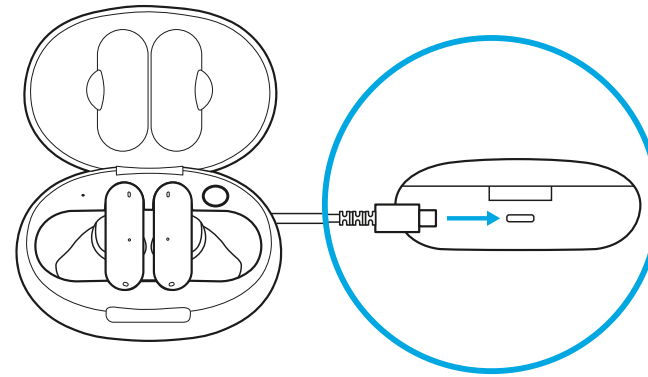

BATTERY

- To charge your case, plug USB-C cable into the back of case.
- To charge your earbuds, place earbuds inside the case.
- Open case lid to check its battery level.
- Place earbuds in the case to check their battery level.
- To improve battery life, mute the mic when not in use.



LED INDICATORS		
Status	Case	Earphones
Charging	 Pulsing white	 Pulsing white
Fully charged	 Solid white	 Solid white for 10 sec
Low battery	 Solid amber for 10 sec	—
Battery above 20%	 Pulsing white for 10 sec	—

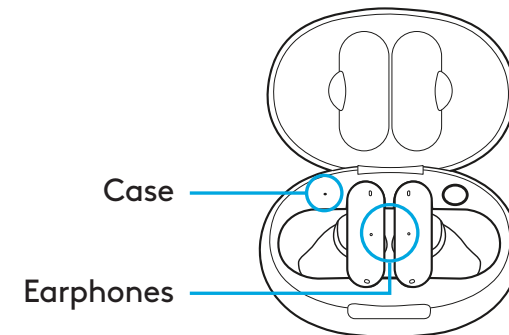

CONTROLS

Double Tap

- On LIGHTSPEED: Mute/Unmute Mic
- On *Bluetooth*[®]: Play/Pause

Triple Tap

- Switch from LIGHTSPEED to *Bluetooth*[®]

Customize controls in the Logitech G FITS mobile app or G HUB
logitechg.com/FITS/appdownload
logitechg.com/ghub

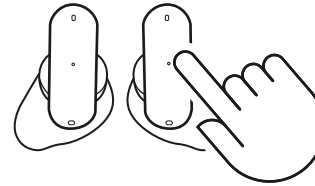

MOLDING NEW EARTIPS

To mold newly purchased eartips, download the Logitech G FITS app from your device's app/play store. Then, tap on "Mold new tips" under "support" in the main menu.

SPARE PARTS

- Ear tips
- Earbuds (L & R)
- Receiver
- Case
- Charging Cable

RECYCLING

We encourage you to resell or donate working products. Otherwise, batteries, electronic and electrical equipment should not be disposed of with household waste. Wherever possible, they should be segregated and brought to an appropriate collection point to enable recycling and avoid potential impacts on the environment and human health. For more information, contact your local authorities or place of purchase, or visit www.logitech.com/recycling

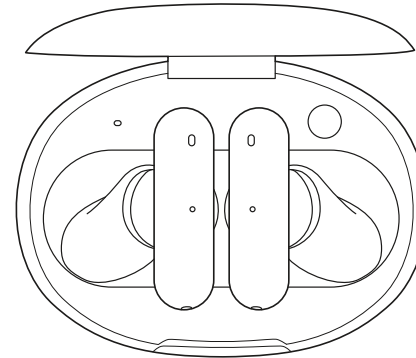

QUESTIONS?

logitechG.com/support/FITS

蓝牙™连接

连接到您的手机、掌上游戏机或其他蓝牙™兼容设备。

- 将耳机放入充电盒按住充电盒按钮 3 秒。
- 进入配对模式后, 耳机 LED 会闪烁白色。
- 在设备的蓝牙™连接设置中选择罗技 G FITS。

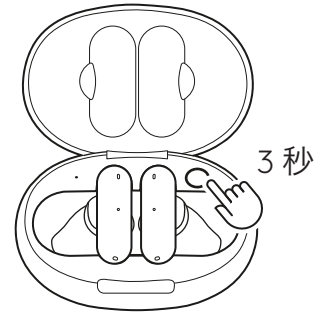

- 从充电盒中取出耳机。
- 轻点左耳机或右耳机 3 次以在 LIGHTSPEED 和蓝牙™之间切换。切换音源后将播放提示音。

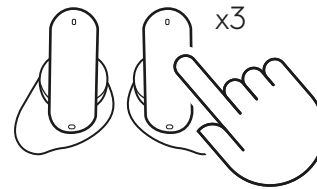
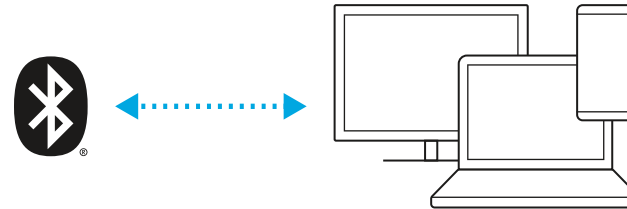

LIGHTSPEED 连接

通过 LIGHTSPEED 无线技术连接您的 PC、Mac、PlayStation 5、PlayStation 4 或放入底座的 Nintendo Switch。

- 将 LIGHTSPEED 接收器插入设备的 USB 端口。

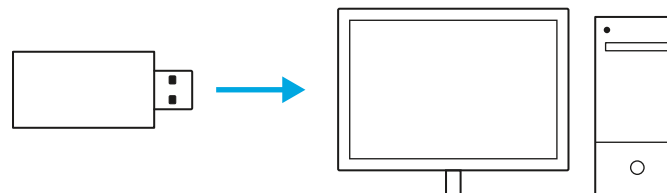

- 从充电盒中取出耳机。

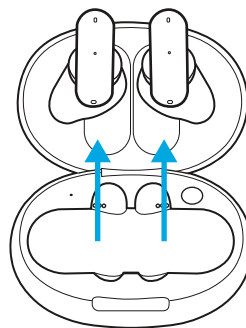

- 连接后, 接收器上的 LED 将常亮白色。

- 轻点左耳机或右耳机 3 次以在 LIGHTSPEED 和蓝牙™ 之间切换。切换音源后将播放提示音。

- 确保接收器距离 wifi 路由器至少 2 米。

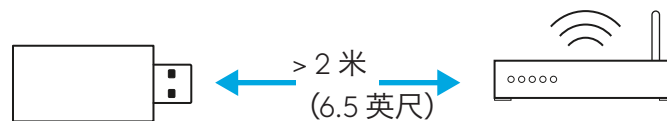
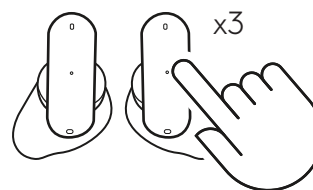

电池

- 要为充电盒充电, 请将 USB-C 数据线插入充电盒背面。
- 要为耳机充电, 请将耳机放入充电盒。
- 打开充电盒盖以检查其电量。
- 将耳机放入充电盒以检查其电量。
- 欲延长使用时间, 请在不使用时将麦克风静音。

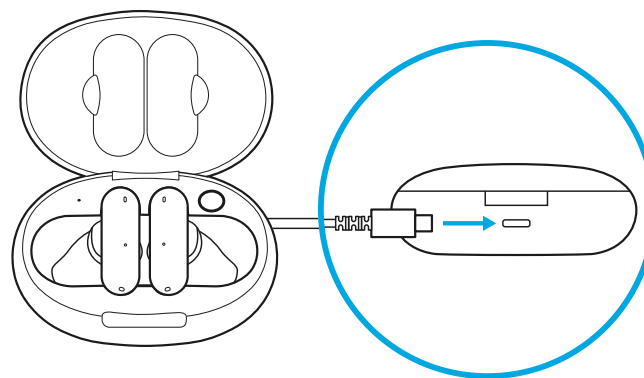

LED 指示灯		
状态	充电盒	耳机
正在充电	◉ 闪烁白色	◉ 闪烁白色
完全充电	○ 常亮白色	○ 常亮白色 10 秒
低电量	● 亮起琥珀色 10 秒	—
电量低于 20%	◉ 闪烁白色 10 秒	—

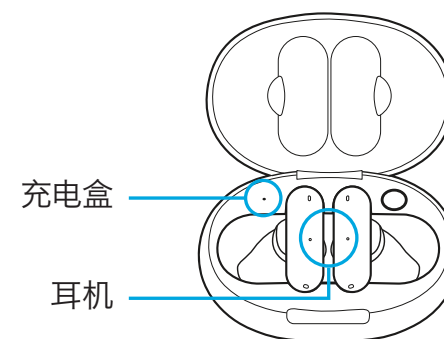

控制

轻点两次

- LIGHTSPEED 模式下: 麦克风静音/取消静音
- 蓝牙™模式下: 播放/暂停

轻点三次

- 从 LIGHTSPEED 切换至蓝牙™

在罗技 G FITS 移动应用程序或 G HUB 中自定义控制

logitechg.com/FITS/appdownload

logitechg.com/ghub

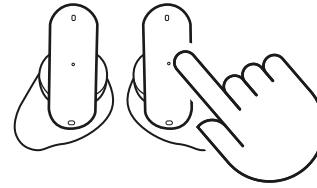

塑造新耳套

要塑造新购的耳套, 请从设备的 app/play store 下载罗技 G FITS 应用程序。然后, 点击主菜单中“支持”下的“塑造新耳套”。

备件

- 耳套
- 耳机 (左和右)
- 接收器
- 充电盒
- 充电线缆

回收

我们鼓励您转售或捐赠仍可运行的产品。若非如此，电池、电子设备和电气设备不应与生活垃圾一同处理。只要情况允许，应将其隔离并带到适当的收集点，以便回收利用，并避免对环境和人类健康的潜在影响。欲了解更多信息，请联系当地主管部门或购买地点，或访问 www.logitech.com/recycling。

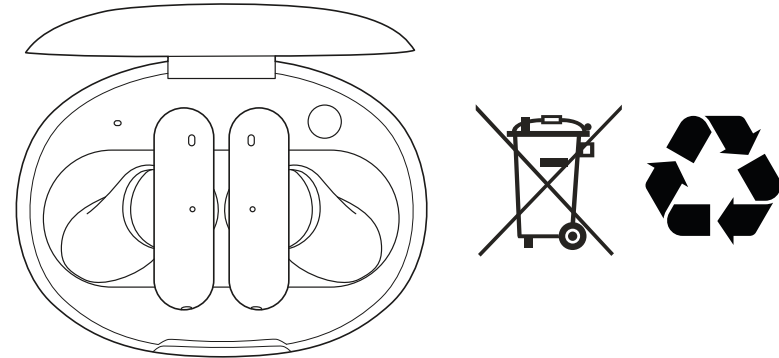

遇到问题？

logitechG.com/support/FITS

藍牙™連線

連線到您的手機、手持遊戲機或其他藍牙™相容裝置。

- 將耳機放入到充電盒按住充電盒按鈕 3 秒鐘不放。
- 當裝置進入配對模式時，耳機 LED 指示燈會閃爍白燈。
- 從您裝置的藍牙™連線設定中，選擇 Logitech G FITS。

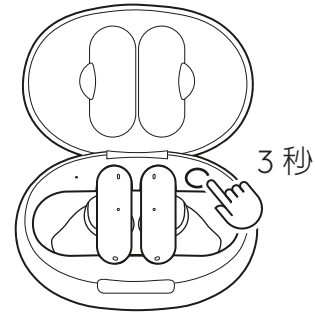

- 從充電盒中取出耳機。
- 點按右耳或左耳耳機三次可切換 LIGHTSPEED 和藍牙™模式。會播放提示音以指明新來源。

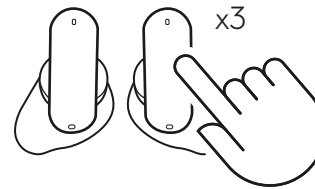
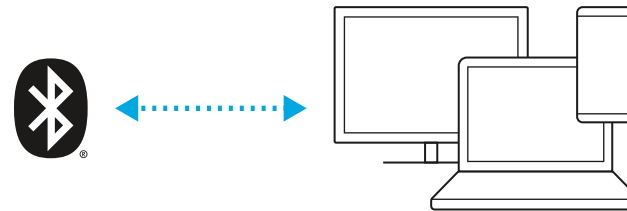

LIGHTSPEED 連線

利用 LIGHTSPEED 無線技術，連線到您的 PC、Mac、PlayStation 5、PlayStation 4 或放在底座上的 Nintendo Switch。

一將 LIGHTSPEED 接收器插入到您裝置的 USB 連接埠。

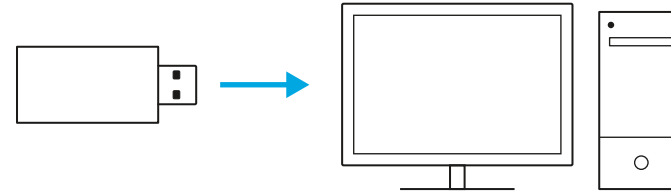

一從充電盒中取出耳機。

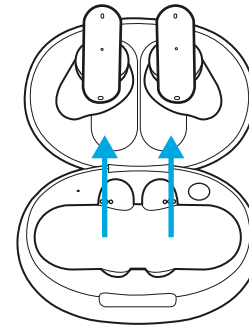

一連線後，接收器上的 LED 指示燈會亮起穩定白燈。

一點按右耳或左耳耳機三次可切換 LIGHTSPEED 和藍牙™ 模式。會播放提示音以指明新來源。

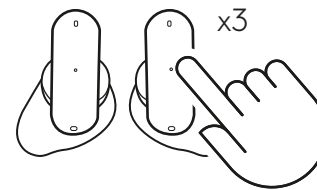

一確認接收器與 wifi 路由器保持至少 2 公尺距離。

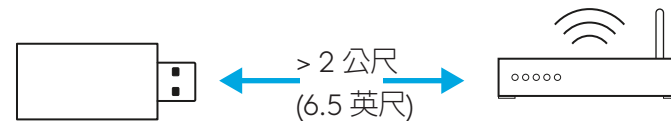

電池

- 若要為充電盒充電，請將 USB-C 連接線插入到充電盒背面。
- 若要為耳機充電，請將耳機放入充電盒。
- 打開充電盒外蓋可檢查其電池電量。
- 將耳機放入充電盒可檢查其電池電量。
- 若要增強電池壽命，請在麥克風不使用時將其靜音。

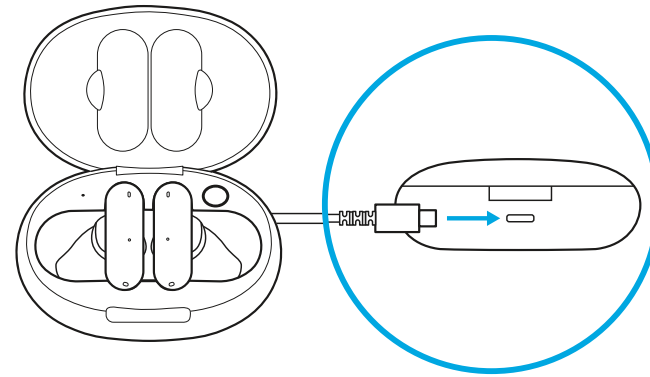

LED 指示燈		
狀態	充電盒	耳機
充電中	◉ 閃爍白燈	◉ 閃爍白燈
充電完成	○ 穩定白燈	○ 穩定白燈 10 秒
電池電力不足	● 穩定琥珀色燈 10 秒	—
電池電量高於 20%	◉ 閃爍白燈 10 秒	—

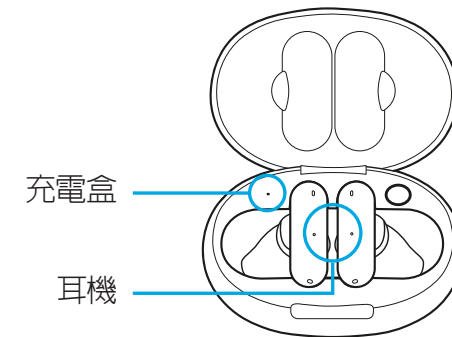

控制

點按兩下

- 在 LIGHTSPEED 上：麥克風靜音/取消靜音
- 在藍牙™上：播放/暫停

點按三下

- 從 LIGHTSPEED 切換到藍牙™

在 Logitech G FITS 行動應用程式或 G HUB 中自訂控制
logitechg.com/FITS/appdownload
logitechg.com/ghub

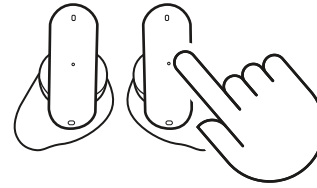

新耳塞塑形

若要為新購買的耳塞塑形，請從您裝置的應用程式/play 商店下載 Logitech G FITS 應用程式。然後在主功能表中點按「支援」下方的「新耳塞塑形」。

備用零件

- 耳塞
- 耳機 (左與右)
- 接收器
- 充電盒
- 充電連接線

回收

我們鼓勵您轉售或捐贈可用的產品。否則，電池與電子廢棄物不應隨家庭廢棄物棄置。在可能時，應將其區分開並帶到適當的收集點以進行回收，避免可能對環境和人體健康造成潛在影響。如需詳細資訊，請聯繫您當地的機關或購買場所，或是造訪 www.logitech.com/recycling

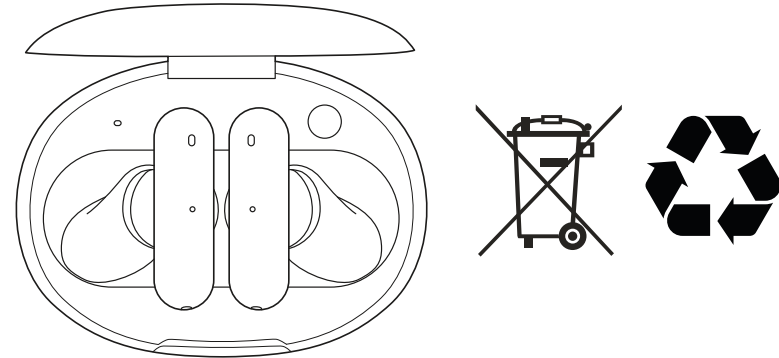

有問題？

logitechG.com/support/FIT5

BLUETOOTH 연결

휴대전화, 휴대용 게이밍 콘솔, 기타 Bluetooth 호환 장치를 연결합니다.

- 케이스에 이어폰을 넣습니다. 케이스 버튼을 3초 동안 길게 누릅니다.
- 페어링 모드에 진입하면 이어폰 LED가 흰색으로 깜박입니다.

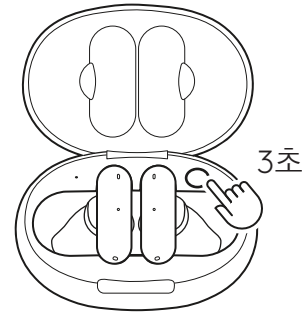

- 장치 Bluetooth 연결 설정에서 로지텍 G FITS를 선택합니다.
- 이어폰을 케이스에서 꺼냅니다.

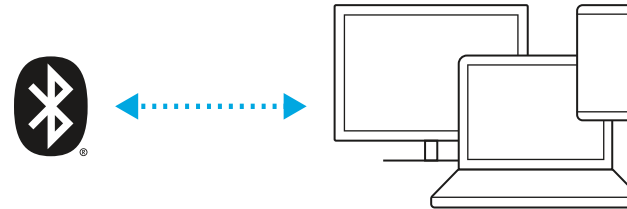

- 오른쪽 또는 왼쪽 이어폰 중 하나를 3번 탭하면 LIGHTSPEED 및 Bluetooth가 전환됩니다. 새로운 소스를 알리는 알림음이 재생됩니다.

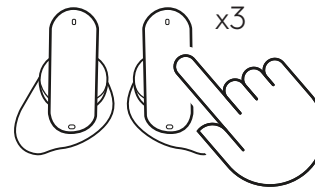

LIGHTSPEED 연결

PC, Mac, PlayStation 5, PlayStation 4 또는 도킹 Nintendo Switch를 LIGHTSPEED 무선 기술로 연결해보세요.

- 장치의 USB 포트에 LIGHTSPEED 수신기를 삽입합니다.

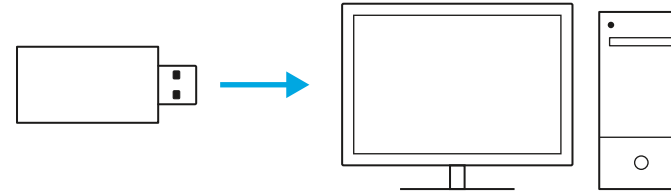

- 이어폰을 케이스에서 꺼냅니다.
- 연결되면 수신기의 LED가 흰색으로 유지됩니다.

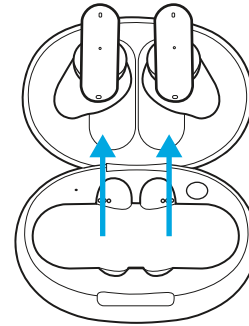

- 오른쪽 또는 왼쪽 이어폰 중 하나를 3번 탭하면 LIGHTSPEED 및 Bluetooth가 전환됩니다. 새로운 소스를 알리는 알림음이 재생됩니다.
- 수신기가 WiFi 라우터에서 2m 이상 떨어져 있어야 합니다.

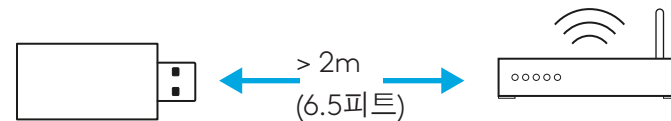
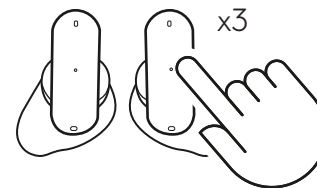

배터리

- 케이스를 충전하려면 USB-C 케이블을 케이스 후면에 연결합니다.
- 이어폰을 충전하려면 이어폰을 케이스 안에 넣습니다.
- 배터리 잔량을 확인하려면 케이스 뚜껑을 엽니다.
- 이어폰을 케이스에 넣으면 배터리 잔량을 확인할 수 있습니다.
- 배터리 수명을 개선하려면 사용하지 않는 마이크는 음소거합니다.

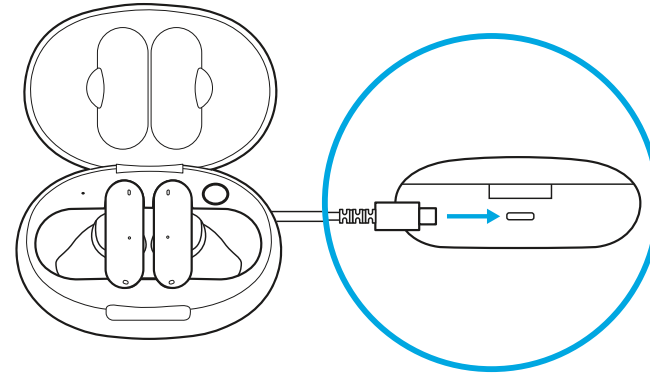

LED 표시등		
상태	케이스	이어폰
충전 중	● 흰색으로 깜박임	● 흰색으로 깜박임
완전히 충전됨	○ 흰색으로 유지	○ 10초 동안 흰색으로 유지
배터리 부족	● 10초 동안 주황색으로 유지	-
배터리 20% 이상	● 10초 동안 흰색으로 깜박임	-

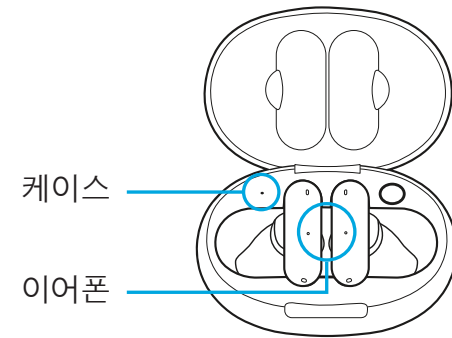

컨트롤

두 번 탭

- LIGHTSPEED: 마이크 음소거/음소거 해제
- *Bluetooth*[®]: 재생/일시 중지

세 번 탭

- LIGHTSPEED에서 *Bluetooth*[®]로 전환

로지텍 G FITS 모바일 앱 또는 G HUB에서 컨트롤 커스텀이 가능합니다.

logitechg.com/FITS/appdownload

logitechg.com/ghub

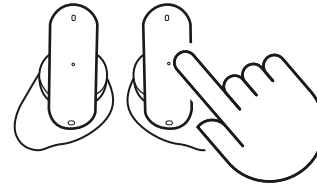

새 이어팁 몰딩

새로 구매한 이어팁을 몰딩하려면 장치의 App Store 또는 Play Store에서 로지텍 G FITS 앱을 다운로드합니다. 메인 메뉴의 “지원” 아래에 “새 이어팁 몰딩”을 탭합니다.

예비 부품

- 이어팁
- 이어폰(L & R)
- 수신기
- 케이스
- 충전 케이블

재활용

작동하는 제품인 경우 재판매 또는 기부를 권장합니다. 재판매나 기부를 하지 않는 경우, 배터리, 전자기기, 전기장비는 생활 폐기물과 함께 처리하면 안 됩니다. 가능하면 재활용과 환경 보호, 공중 보건을 위해 분리하여 정해진 수거 장소에 버려야 합니다. 자세한 사항은 지방 관헌이나 구매처에 문의하십시오. www.logitech.com/recycling에서도 확인할 수 있습니다.

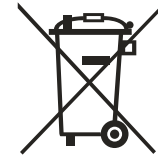
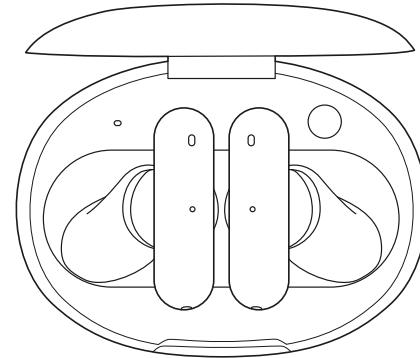

질문이 있으십니까?

logitechG.com/support/FITS



©2022 Logitech. Logitech, Logitech G, Logi and their respective logos are trademarks or registered trademarks of Logitech Europe S.A. and/or its affiliates in the U.S. and other countries. All other trademarks are the property of their respective owners. Logitech assumes no responsibility for any errors that may appear in this manual. Information contained herein is subject to change without notice.

版权所有 © 2022 罗技。罗技、罗技 G、Logi、Logitech、Logitech G 及其各自标志为 罗技欧洲公司 和/或其在美国及其他国家/地区附属公司的商标、并或已注册。所有其它商标均是其各自所有者的财产。罗技对于本手册中可能出现的任何错误不 承担 任何 责任。本手册中包含的信息如有更改，恕不事先通知。

本设置指南内所使用的数据如无特别说明均来自罗技有限公司和/或其关联公司和/或其指定的供应商。图片仅作说明之用，可能与实物有所差别。

WEB-621-002278 002