

## FCC Test Report

**Report No.:** RFBDKG-WTW-P21060156

**FCC ID:** JNZB00042

**Test Model:** B00042

**Received Date:** June 22, 2021

**Test Date:** June 22 to July 01, 2021

**Issued Date:** July 22, 2021

**Applicant:** LOGITECH FAR EAST LTD.

**Address:** 7700 Gateway Boulevard Newark California United States

**Issued By:** Bureau Veritas Consumer Products Services (H.K.) Ltd., Taoyuan Branch  
Hsin Chu Laboratory

**Lab Address:** E-2, No.1, Li Hsin 1st Road, Hsinchu Science Park, Hsinchu City 300,  
Taiwan

**Test Location:** E-2, No.1, Li Hsin 1st Road, Hsinchu Science Park, Hsinchu City 300,  
Taiwan

**FCC Registration /  
Designation Number:** 723255 / TW2022



This report is for your exclusive use. Any copying or replication of this report to or for any other person or entity, or use of our name or trademark, is permitted only with our prior written permission. This report sets forth our findings solely with respect to the test samples identified herein. The results set forth in this report are not indicative or representative of the quality or characteristics of the lot from which a test sample was taken or any similar or identical product unless specifically and expressly noted. Our report includes all of the tests requested by you and the results thereof based upon the information that you provided to us. You have 60 days from date of issuance of this report to notify us of any material error or omission caused by our negligence, provided, however, that such notice shall be in writing and shall specifically address the issue you wish to raise. A failure to raise such issue within the prescribed time shall constitute your unqualified acceptance of the completeness of this report, the tests conducted and the correctness of the report contents. Unless specific mention, the uncertainty of measurement has been explicitly taken into account to declare the compliance or non-compliance to the specification.

## Table of Contents

<b>Release Control Record</b> .....	<b>4</b>
<b>1 Certificate of Conformity</b> .....	<b>5</b>
<b>2 Summary of Test Results</b> .....	<b>6</b>
2.1 Measurement Uncertainty .....	6
2.2 Modification Record .....	6
<b>3 General Information</b> .....	<b>7</b>
3.1 General Description of EUT .....	7
3.2 Description of Test Modes .....	9
3.2.1 Test Mode Applicability and Tested Channel Detail .....	10
3.3 Duty Cycle of Test Signal .....	12
3.4 Description of Support Units .....	13
3.4.1 Configuration of System under Test .....	14
3.5 General Description of Applied Standards and References .....	16
<b>4 Test Types and Results</b> .....	<b>17</b>
4.1 Radiated Emission and Bandedge Measurement .....	17
4.1.1 Limits of Radiated Emission and Bandedge Measurement .....	17
4.1.2 Test Instruments .....	18
4.1.3 Test Procedures .....	20
4.1.4 Deviation from Test Standard .....	20
4.1.5 Test Setup .....	21
4.1.6 EUT Operating Conditions .....	22
4.1.7 Test Results .....	23
4.2 Conducted Emission Measurement .....	28
4.2.1 Limits of Conducted Emission Measurement .....	28
4.2.2 Test Instruments .....	28
4.2.3 Test Procedures .....	29
4.2.4 Deviation from Test Standard .....	29
4.2.5 Test Setup .....	29
4.2.6 EUT Operating Conditions .....	29
4.2.7 Test Results .....	30
4.3 6dB Bandwidth Measurement .....	32
4.3.1 Limits of 6dB Bandwidth Measurement .....	32
4.3.2 Test Setup .....	32
4.3.3 Test Instruments .....	32
4.3.4 Test Procedure .....	32
4.3.5 Deviation from Test Standard .....	32
4.3.6 EUT Operating Conditions .....	32
4.3.7 Test Results .....	33
4.4 Conducted Output Power Measurement .....	34
4.4.1 Limits of Conducted Output Power Measurement .....	34
4.4.2 Test Setup .....	34
4.4.3 Test Instruments .....	34
4.4.4 Test Procedures .....	34
4.4.5 Deviation from Test Standard .....	34
4.4.6 EUT Operating Conditions .....	34
4.4.7 Test Results .....	35
4.5 Power Spectral Density Measurement .....	36
4.5.1 Limits of Power Spectral Density Measurement .....	36
4.5.2 Test Setup .....	36
4.5.3 Test Instruments .....	36
4.5.4 Test Procedure .....	36
4.5.5 Deviation from Test Standard .....	36
4.5.6 EUT Operating Condition .....	36

4.5.7 Test Results .....	37
4.6 Conducted Out of Band Emission Measurement .....	38
4.6.1 Limits of Conducted Out of Band Emission Measurement.....	38
4.6.2 Test Setup.....	38
4.6.3 Test Instruments .....	38
4.6.4 Test Procedure .....	38
4.6.5 Deviation from Test Standard .....	38
4.6.6 EUT Operating Condition .....	38
4.6.7 Test Results .....	38
<b>5 Pictures of Test Arrangements.....</b>	<b>40</b>
<b>Annex A - Band-Edge Measurement.....</b>	<b>41</b>
<b>Appendix – Information of the Testing Laboratories .....</b>	<b>42</b>

### Release Control Record

Issue No.	Description	Date Issued
RFBDKG-WTW-P21060156	Original release.	July 22, 2021

## 1 Certificate of Conformity

**Product:** Charger case

**Brand:** Logitech

**Test Model:** B00042

**Sample Status:** Engineering sample

**Applicant:** LOGITECH FAR EAST LTD.

**Test Date:** June 22 to July 01, 2021

**Standards:** 47 CFR FCC Part 15, Subpart C (Section 15.247)  
ANSI C63.10: 2013

The above equipment has been tested by **Bureau Veritas Consumer Products Services (H.K.) Ltd., Taoyuan Branch**, and found compliance with the requirement of the above standards. The test record, data evaluation & Equipment Under Test (EUT) configurations represented herein are true and accurate accounts of the measurements of the sample's EMC characteristics under the conditions specified in this report.

**Prepared by :**  \_\_\_\_\_, **Date:** July 22, 2021  
Claire Kuan / Specialist

**Approved by :**  \_\_\_\_\_, **Date:** July 22, 2021  
Clark Lin / Technical Manager

## 2 Summary of Test Results

47 CFR FCC Part 15, Subpart C (Section 15.247)			
FCC Clause	Test Item	Result	Remarks
15.207	AC Power Conducted Emission	PASS	Meet the requirement of limit. Minimum passing margin is -13.50 dB at 0.56797 MHz.
15.205 / 15.209 / 15.247(d)	Radiated Emissions and Band Edge Measurement	PASS	Meet the requirement of limit. Minimum passing margin is -5.60 dB at 2486.00 MHz.
15.247(d)	Antenna Port Emission	PASS	Meet the requirement of limit.
15.247(a)(2)	6dB bandwidth	PASS	Meet the requirement of limit.
15.247(b)	Conducted power	PASS	Meet the requirement of limit.
15.247(e)	Power Spectral Density	PASS	Meet the requirement of limit.
15.203	Antenna Requirement	PASS	No antenna connector is used.

### Note:

- For 2.4 GHz band compliance with rule 15.247(d) of the band-edge items, the test plots were recorded in Annex A.
- Determining compliance based on the results of the compliance measurement, not taking into account measurement instrumentation uncertainty.

### 2.1 Measurement Uncertainty

Where relevant, the following measurement uncertainty levels have been estimated for tests performed on the EUT as specified in CISPR 16-4-2:

Measurement	Frequency	Expanded Uncertainty (k=2) ( $\pm$ )
Conducted Emissions at mains ports	150kHz ~ 30MHz	1.9 dB
Conducted emissions	-	2.5 dB
Radiated Emissions up to 1 GHz	9kHz ~ 30MHz	3.1 dB
	30MHz ~ 1GHz	5.4 dB
Radiated Emissions above 1 GHz	1GHz ~ 18GHz	5.0 dB
	18GHz ~ 40GHz	5.3 dB

### 2.2 Modification Record

There were no modifications required for compliance.

### 3 General Information

#### 3.1 General Description of EUT

Product	Charger case
Brand	Logitech
Test Model	B00042
Status of EUT	Engineering sample
Power Supply Rating	DC 5V from USB interface or DC 3.8V from battery
Modulation Type	GFSK
Modulation Technology	DTS
Transfer Rate	Up to 1 Mbps
Operating Frequency	2.402 ~ 2.480 GHz
Number of Channel	40
Output Power	5.559 mW
Antenna Type	Refer to Note
Antenna Connector	Refer to Note
Accessory Device	NA
Cable Supplied	USB-A to C cable x 1 (Shielded, 0.25m)

Note:

1. The EUT may have a lot of colors for marketing requirement.
2. The EUT must be supplied with a battery as the following table:

Brand	Model No.	Spec.
GP	NTA3640-V2	3.8 Vdc; 490 mAh

3. The antenna provided to the EUT, please refer to the following table:

Antenna Gain (dBi)	Frequency Range (GHz)	Antenna Type	Connector Type
-0.05	2.4~2.4835	PIFA	None

4. For conducted emission test, the EUT was pre-tested under the following modes:

Test Mode	Description
Mode A	Power from Adapter mode
Mode B	Power from Laptop mode
<b>Mode C</b>	<b>Power from Qi mode</b>

Note: From the above modes, the worst case was found in **Mode C**. Therefore only the test data of the mode was recorded in this report.

5. For radiated emissions below 1GHz test, the EUT was pre-tested under the following modes:

Test Mode	Description
Mode A	Power from Battery mode , Eut X-Y
Mode B	Power from Battery mode , Eut X-Z
Mode C	Power from Battery mode , Eut Y-Z
Mode D	Power from Adapter mode , Eut X-Y
<b>Mode E</b>	<b>Power from Qi mode , Eut X-Y</b>

Note: From the above modes, the worst case was found in **Mode E**. Therefore only the test data of the mode was recorded in this report.

6. The above EUT information is declared by manufacturer and for more detailed features description, please refer to the manufacturer's specifications or user's manual.

7. The above Antenna information is declared by manufacturer and for more detailed features description, please refer to the manufacturer's specifications, the laboratory shall not be held responsible.



### 3.2 Description of Test Modes

40 channels are provided to this EUT:

CHANNEL	FREQ. (MHz)	CHANNEL	FREQ. (MHz)	CHANNEL	FREQ. (MHz)	CHANNEL	FREQ. (MHz)
0	2402	10	2422	20	2442	30	2462
1	2404	11	2424	21	2444	31	2464
2	2406	12	2426	22	2446	32	2466
3	2408	13	2428	23	2448	33	2468
4	2410	14	2430	24	2450	34	2470
5	2412	15	2432	25	2452	35	2472
6	2414	16	2434	26	2454	36	2474
7	2416	17	2436	27	2456	37	2476
8	2418	18	2438	28	2458	38	2478
9	2420	19	2440	29	2460	39	2480

### 3.2.1 Test Mode Applicability and Tested Channel Detail

EUT CONFIGURE MODE	APPLICABLE TO				DESCRIPTION
	RE≥1G	RE<1G	PLC	APCM	
-	√	√	√	√	-

Where **RE≥1G**: Radiated Emission above 1GHz & Bandedge Measurement

**RE<1G**: Radiated Emission below 1GHz

**PLC**: Power Line Conducted Emission

**APCM**: Antenna Port Conducted Measurement

Note: The EUT had been pre-tested on the positioned of each 3 axis. The worst case was found when positioned on **X-place**.

#### **Radiated Emission Test (Above 1GHz):**

- Pre-Scan has been conducted to determine the worst-case mode from all possible combinations between available modulations, data rates and antenna ports (if EUT with antenna diversity architecture).
- Following channel(s) was (were) selected for the final test as listed below.

AVAILABLE CHANNEL	TESTED CHANNEL	MODULATION TYPE	DATA RATE (Mbps)
0 to 39	0, 19, 39	GFSK	1

#### **Radiated Emission Test (Below 1GHz):**

- Pre-Scan has been conducted to determine the worst-case mode from all possible combinations between available modulations, data rates and antenna ports (if EUT with antenna diversity architecture).
- Following channel(s) was (were) selected for the final test as listed below.

AVAILABLE CHANNEL	TESTED CHANNEL	MODULATION TYPE	DATA RATE (Mbps)
0 to 39	0	GFSK	1

#### **Power Line Conducted Emission Test:**

- Pre-Scan has been conducted to determine the worst-case mode from all possible combinations between available modulations, data rates and antenna ports (if EUT with antenna diversity architecture).
- Following channel(s) was (were) selected for the final test as listed below.

AVAILABLE CHANNEL	TESTED CHANNEL	MODULATION TYPE	DATA RATE (Mbps)
0 to 39	0	GFSK	1

**Antenna Port Conducted Measurement:**

- This item includes all test value of each mode, but only includes spectrum plot of worst value of each mode.
- Pre-Scan has been conducted to determine the worst-case mode from all possible combinations between available modulations, data rates and antenna ports (if EUT with antenna diversity architecture).
- Following channel(s) was (were) selected for the final test as listed below.

AVAILABLE CHANNEL	TESTED CHANNEL	MODULATION TYPE	DATA RATE (Mbps)
0 to 39	0, 19, 39	GFSK	1

**Test Condition:**

Applicable to	Environmental Conditions	Input Power (System)	Tested By
RE $\geq$ 1G	25deg. C, 66%RH	120Vac, 60Hz	Tom Yang
RE<1G	25deg. C, 66%RH	120Vac, 60Hz	Tom Yang
PLC	25deg. C, 66%RH	120Vac, 60Hz	Tom Yang
APCM	25deg. C, 60%RH	120Vac, 60Hz	Kevin Ko

### 3.3 Duty Cycle of Test Signal

Duty cycle =  $0.379 \text{ ms} / 1.255 \text{ ms} = 0.302$

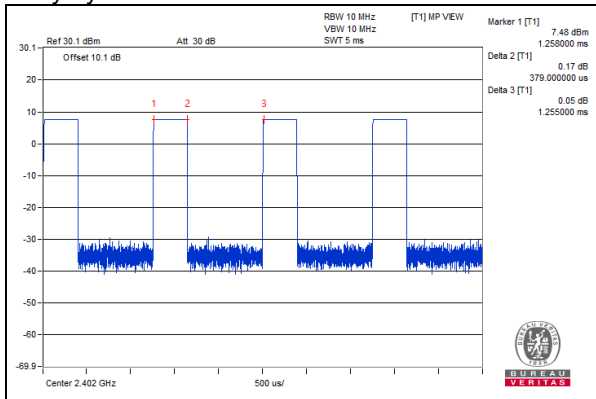

### 3.4 Description of Support Units

The EUT has been tested as an independent unit together with other necessary accessories or support units. The following support units or accessories were used to form a representative test configuration during the tests.

ID	Product	Brand	Model No.	Serial No	FCC ID	Remarks
A.	Laptop	DELL	Inspiron 7570	DW3CSJ2	NA	Provided by Lab
B.	Test Tool	Logitech	NA	NA	NA	Supplied by client
C.	Test Tool	Logitech	NA	NA	NA	Supplied by client
D.	Left earphone	Logitech	B00036	NA	NA	Supplied by client
E.	Right earphone	Logitech	B00036	NA	NA	Supplied by client
F.	Qi Wireless Charging Pad	Belkin	F8M747	NA	NA	Provided by Lab
G.	Adapter	ASUS	EXA1205UA	NA	NA	Provided by Lab
H.	Adapter	Dell	LA65NS2-01	NA	NA	Provided by Lab

ID	Descriptions	Qty.	Length (m)	Shielding (Yes/No)	Cores (Qty.)	Remarks
1.	USB Type A to C Cable	1	0.25	Yes	0	Supplied by client
2.	Console Cable	1	0.1	No	0	Supplied by client
3.	Mini USB Cable	1	1.5	Yes	0	Provided by Lab
4.	DC Cable	1	1.8	No	1	Provided by Lab
5.	AC Cable	1	0.9	No	0	Provided by Lab
6.	USB Cable	1	1.8	Yes	0	Provided by Lab

Note: The core(s) is(are) originally attached to the cable(s).

### 3.4.1 Configuration of System under Test

For conducted emission below 1GHz test:

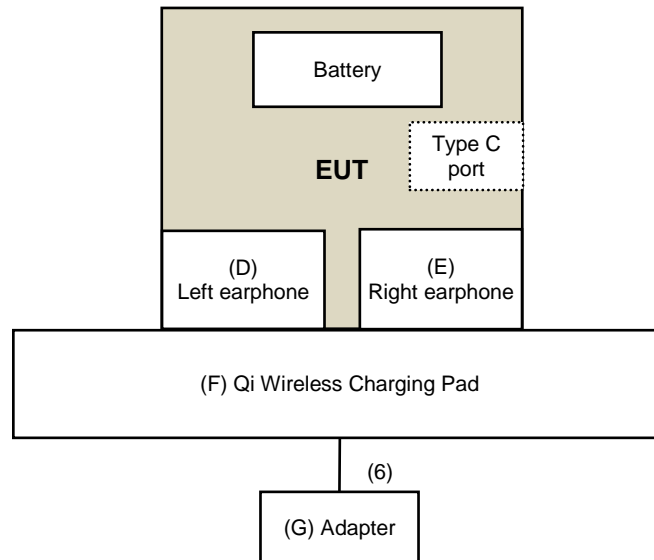

For radiated emission below 1GHz test:

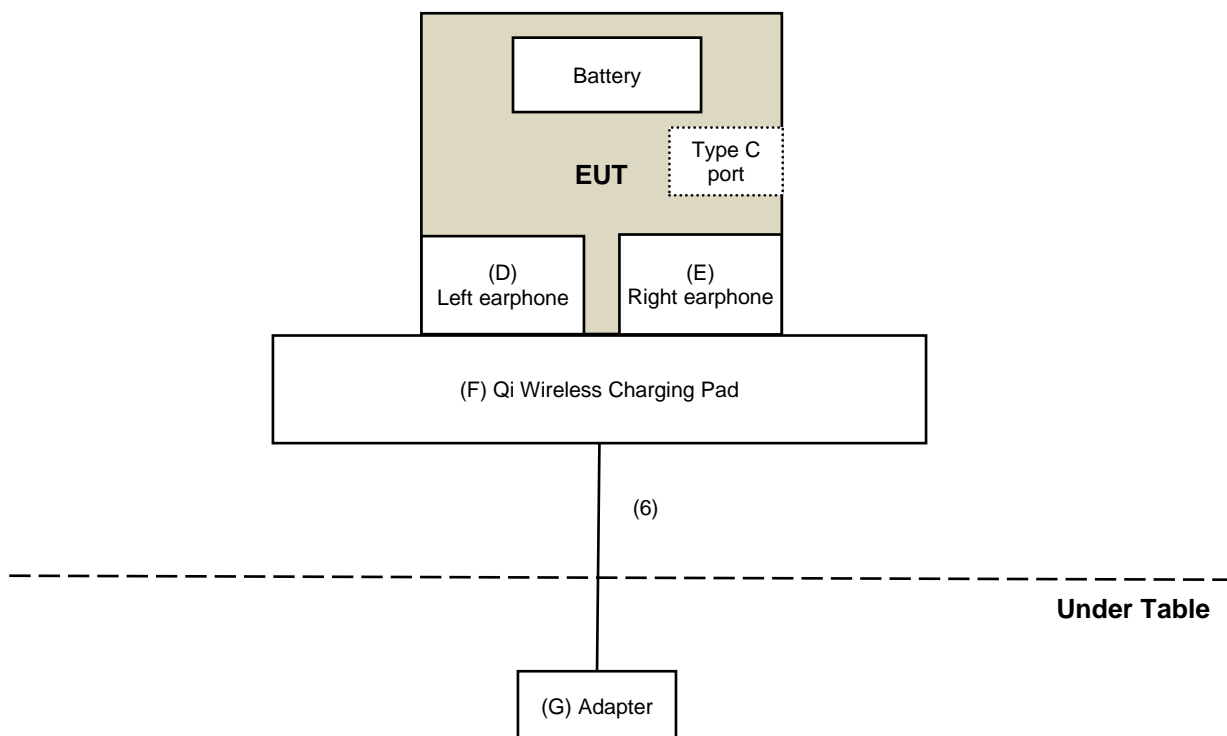

For radiated emission above 1GHz test:

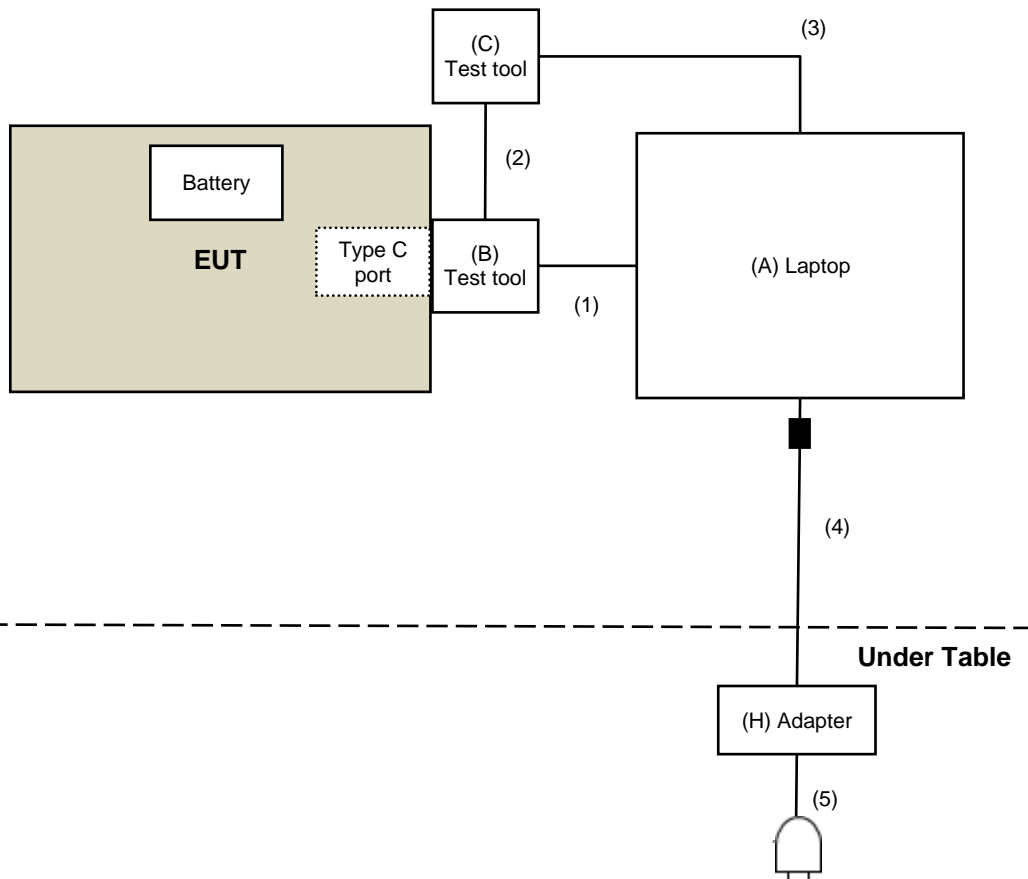

### 3.5 General Description of Applied Standards and References

The EUT is a RF Product. According to the specifications of the manufacturer, it must comply with the requirements of the following standards and references:

**Test Standard:**

**FCC Part 15, Subpart C (15.247)**

**ANSI C63.10-2013**

All test items have been performed and recorded as per the above standards.

**References Test Guidance:**

**KDB 558074 D01 15.247 Meas Guidance v05r02**

All test items have been performed as a reference to the above KDB test guidance.



## 4 Test Types and Results

### 4.1 Radiated Emission and Bandedge Measurement

#### 4.1.1 Limits of Radiated Emission and Bandedge Measurement

Radiated emissions which fall in the restricted bands must comply with the radiated emission limits specified as below table. Other emissions shall be at least 20dB below the highest level of the desired power:

Frequencies (MHz)	Field Strength (microvolts/meter)	Measurement Distance (meters)
0.009 ~ 0.490	2400/F(kHz)	300
0.490 ~ 1.705	24000/F(kHz)	30
1.705 ~ 30.0	30	30
30 ~ 88	100	3
88 ~ 216	150	3
216 ~ 960	200	3
Above 960	500	3

**Note:**

1. The lower limit shall apply at the transition frequencies.
2. Emission level (dBuV/m) = 20 log Emission level (uV/m).
3. For frequencies above 1000MHz, the field strength limits are based on average detector, however, the peak field strength of any emission shall not exceed the maximum permitted average limits, specified above by more than 20dB under any condition of modulation.

## 4.1.2 Test Instruments

**For Radiated Emission & Band Edge test:**

DESCRIPTION & MANUFACTURER	MODEL NO.	SERIAL NO.	CALIBRATED DATE	CALIBRATED UNTIL
Test Receiver Keysight	N9038A	MY54450088	July 06, 2020	July 05, 2021
Pre-Amplifier EMCI	EMC001340	980142	May 24, 2021	May 23, 2022
Loop Antenna Electro-Metrics	EM-6879	264	Mar. 05, 2021	Mar. 04, 2022
RF Cable	5D-FB	LOOPCAB-001	Jan. 07, 2021	Jan. 06, 2022
RF Cable	5D-FB	LOOPCAB-002	Jan. 07, 2021	Jan. 06, 2022
Pre-Amplifier Mini-Circuits	ZFL-1000VH2	QA0838008	Oct. 20, 2020	Oct. 19, 2021
Trilog Broadband Antenna SCHWARZBECK	VULB 9168	9168-361	Nov. 05, 2020	Nov. 04, 2021
RF Cable	8D	966-3-1	Mar. 16, 2021	Mar. 15, 2022
RF Cable	8D	966-3-2	Mar. 16, 2021	Mar. 15, 2022
RF Cable	8D	966-3-3	Mar. 16, 2021	Mar. 15, 2022
Fixed attenuator Mini-Circuits	UNAT-5+	PAD-3m-3-01	Sep. 24, 2020	Sep. 23, 2021
Horn_Antenna SCHWARZBECK	BBHA9120-D	9120D-406	Nov. 22, 2020	Nov. 21, 2021
Pre-Amplifier EMCI	EMC12630SE	980384	Jan. 11, 2021	Jan. 10, 2022
RF Cable	EMC104-SM-SM-1500	180504	Apr. 26, 2021	Apr. 25, 2022
RF Cable	EMC104-SM-SM-2000	180601	June 08, 2021	June 07, 2022
RF Cable	EMC104-SM-SM-6000	210201	May 13, 2021	May 12, 2022
Spectrum Analyzer Keysight	N9030A	MY54490679	July 13, 2020	July 12, 2021
Pre-Amplifier EMCI	EMC184045SE	980387	Jan. 11, 2021	Jan. 10, 2022
Horn_Antenna SCHWARZBECK	BBHA 9170	BBHA9170519	Nov. 22, 2020	Nov. 21, 2021
RF Cable	EMC102-KM-KM-1200	160924	Jan. 11, 2021	Jan. 10, 2022
RF Cable	EMC-KM-KM-4000	200214	Mar. 10, 2021	Mar. 09, 2022
Software	ADT_Radiated_V8.7.08	NA	NA	NA
Antenna Tower & Turn Table Max-Full	MF-7802	MF780208406	NA	NA
Boresight Antenna Fixture	FBA-01	FBA-SIP01	NA	NA

**Note:**

1. The calibration interval of the above test instruments is 12 months and the calibrations are traceable to NML/ROC and NIST/USA.
2. The test was performed in 966 Chamber No. 3.
3. Tested Date: July 01, 2021

**For other test items:**

DESCRIPTION & MANUFACTURER	MODEL NO.	SERIAL NO.	CALIBRATED DATE	CALIBRATED UNTIL
Spectrum Analyzer R&S	FSV40	101516	Mar. 08, 2021	Mar. 07, 2022
Power meter Anritsu	ML2495A	1529002	July 22, 2020	July 21, 2021
Power sensor Anritsu	MA2411B	1339443	July 22, 2020	July 21, 2021
Fixed Attenuator Mini-Circuits	MDCS18N-10	MDCS18N-10-01	Apr. 13, 2021	Apr. 12, 2022
Software	ADT_RF Test Software V6.6.5.4	NA	NA	NA

- NOTE:**
1. The test was performed in Oven room 2.
  2. The calibration interval of the above test instruments is 12 months and the calibrations are traceable to NML/ROC and NIST/USA.
  3. Tested Date: June 22, 2021

#### 4.1.3 Test Procedures

##### **For Radiated emission below 30MHz**

- a. The EUT was placed on the top of a rotating table 0.8 meters above the ground at a 3 meter chamber room. The table was rotated 360 degrees to determine the position of the highest radiation.
- b. The EUT was set 3 meters away from the interference-receiving antenna, which was mounted on the top of a variable-height antenna tower.
- c. Parallel, perpendicular, and ground-parallel orientations of the antenna are set to make the measurement.
- d. For each suspected emission, the EUT was arranged to its worst case and the rotatable table was turned from 0 degrees to 360 degrees to find the maximum reading.
- e. The test-receiver system was set to Quasi-Peak Detect Function and Specified Bandwidth with Maximum Hold Mode.

##### **Note:**

1. The resolution bandwidth and video bandwidth of test receiver/spectrum analyzer is 9kHz at frequency below 30MHz.

##### **For Radiated emission above 30MHz**

- a. The EUT was placed on the top of a rotating table 0.8 meters (for 30MHz ~ 1GHz) / 1.5 meters (for above 1GHz) above the ground at 3 meter chamber room for test. The table was rotated 360 degrees to determine the position of the highest radiation.
- b. The EUT was set 3 meters away from the interference-receiving antenna, which was mounted on the top of a variable-height antenna tower.
- c. The height of antenna is varied from one meter to four meters above the ground to determine the maximum value of the field strength. Both horizontal and vertical polarizations of the antenna are set to make the measurement.
- d. For each suspected emission, the EUT was arranged to its worst case and then the antenna was tuned to heights from 1 meter to 4 meters and the rotatable table was turned from 0 degrees to 360 degrees to find the maximum reading.
- e. The test-receiver system was set to quasi-peak detect function and specified bandwidth with maximum hold mode when the test frequency is below 1 GHz.
- f. The test-receiver system was set to peak and average detects function and specified bandwidth with maximum hold mode when the test frequency is above 1 GHz. If the peak reading value also meets average limit, measurement with the average detector is unnecessary.

##### **Note:**

1. The resolution bandwidth and video bandwidth of test receiver/spectrum analyzer is 120kHz for Quasi-peak detection (QP) at frequency below 1GHz.
2. The resolution bandwidth of test receiver/spectrum analyzer is 1 MHz and the video bandwidth is 3 MHz for Peak detection (PK) at frequency above 1GHz.
3. The resolution bandwidth of test receiver/spectrum analyzer is 1 MHz and the video bandwidth is 3 MHz for Average detection (AV) at frequency above 1GHz.
4. All modes of operation were investigated and the worst-case emissions are reported.

#### 4.1.4 Deviation from Test Standard

No deviation.

#### 4.1.5 Test Setup

##### For Radiated emission below 30MHz

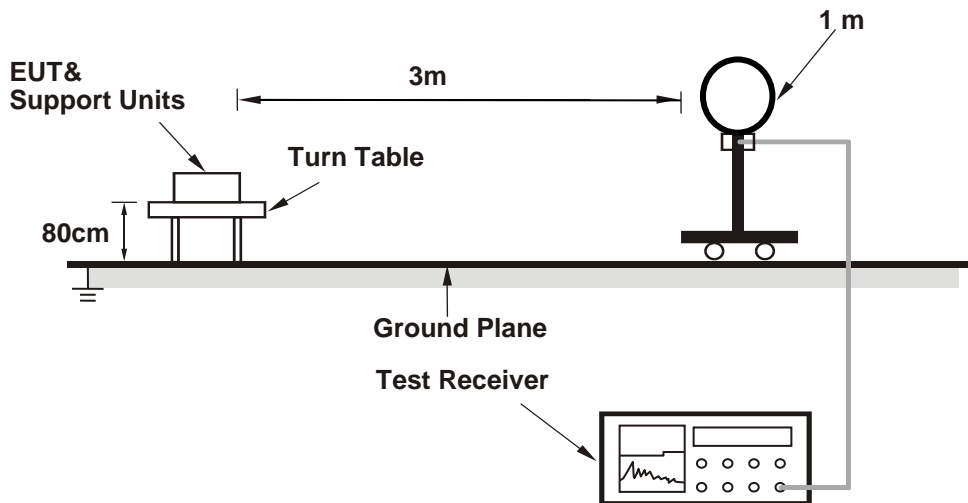

##### For Radiated emission 30MHz to 1GHz

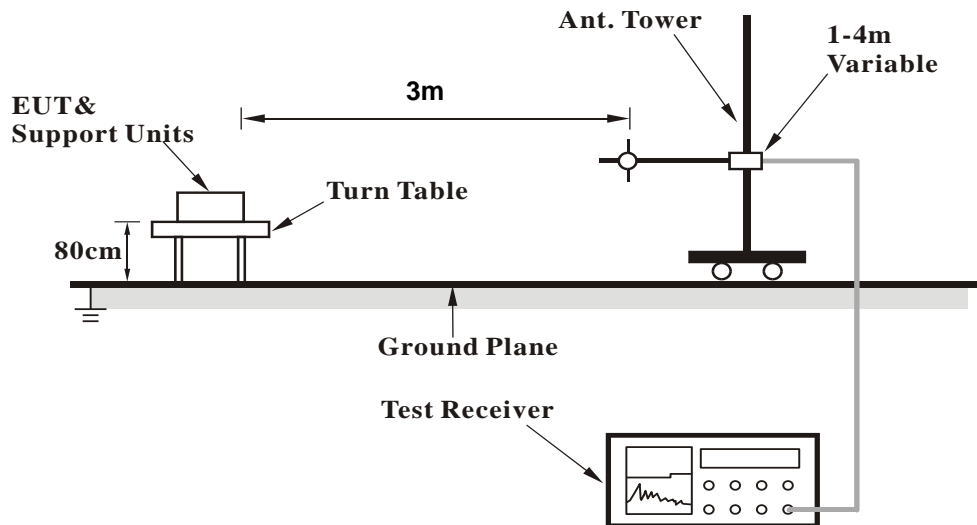

### For Radiated emission above 1GHz

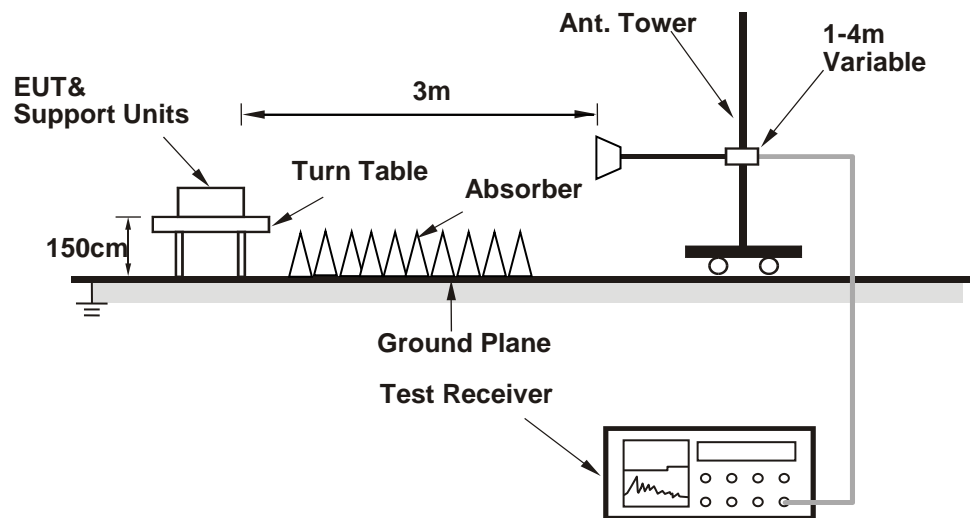

For the actual test configuration, please refer to the attached file (Test Setup Photo).

#### 4.1.6 EUT Operating Conditions

- a. Placed the EUT on the testing table.
- b. Controlling software (BlueNRG) has been activated to set the EUT under transmission condition continuously at specific channel frequency.

#### 4.1.7 Test Results

##### Above 1GHz Data:

<b>RF Mode</b>	TX BT_LE-1M	<b>Channel</b>	CH 0 : 2402 MHz
<b>Frequency Range</b>	1GHz ~ 25GHz	<b>Detector Function</b>	Peak (PK) Average (AV)

Antenna Polarity & Test Distance : Horizontal at 3 m								
No	Frequency (MHz)	Emission Level (dBUV/m)	Limit (dBUV/m)	Margin (dB)	Antenna Height (m)	Table Angle (Degree)	Raw Value (dBUV)	Correction Factor (dB/m)
1	2387.60	55.9 PK	74.0	-18.1	1.52 H	169	57.1	-1.2
2	2387.60	44.6 AV	54.0	-9.4	1.52 H	169	45.8	-1.2
3	*2402.00	103.0 PK			1.52 H	169	104.2	-1.2
4	*2402.00	92.6 AV			1.52 H	169	93.8	-1.2
5	4804.00	45.1 PK	74.0	-28.9	1.05 H	123	41.3	3.8
6	4804.00	34.7 AV	54.0	-19.3	1.05 H	123	30.9	3.8
Antenna Polarity & Test Distance : Vertical at 3 m								
No	Frequency (MHz)	Emission Level (dBUV/m)	Limit (dBUV/m)	Margin (dB)	Antenna Height (m)	Table Angle (Degree)	Raw Value (dBUV)	Correction Factor (dB/m)
1	2347.50	56.1 PK	74.0	-17.9	1.39 V	11	57.2	-1.1
2	2347.50	45.3 AV	54.0	-8.7	1.39 V	11	46.4	-1.1
3	*2402.00	95.4 PK			1.39 V	11	96.6	-1.2
4	*2402.00	85.0 AV			1.39 V	11	86.2	-1.2
5	4804.00	43.6 PK	74.0	-30.4	1.33 V	302	39.8	3.8
6	4804.00	33.2 AV	54.0	-20.8	1.33 V	302	29.4	3.8

##### Remarks:

- Emission Level(dBUV/m) = Raw Value(dBUV) + Correction Factor(dB/m)
- Correction Factor(dB/m) = Antenna Factor(dB/m) + Cable Factor(dB) – Pre-Amplifier Factor(dB)
- Margin value = Emission Level – Limit value
- The other emission levels were very low against the limit.
- " \* ": Fundamental frequency.
- The average value of fundamental and harmonic frequency is: Average = Peak value + 20 log(Duty cycle) Where the duty factor is calculated from following formula:  
 $20 \log(\text{Duty cycle}) = 20 \log(0.379 \text{ ms} / 1.255 \text{ ms}) = -10.4 \text{ dB}$   
 Please see page 3.3 for plotted duty.

<b>RF Mode</b>	TX BT_LE-1M	<b>Channel</b>	CH 19 : 2440 MHz
<b>Frequency Range</b>	1GHz ~ 25GHz	<b>Detector Function</b>	Peak (PK) Average (AV)

Antenna Polarity & Test Distance : Horizontal at 3 m								
No	Frequency (MHz)	Emission Level (dBuV/m)	Limit (dBuV/m)	Margin (dB)	Antenna Height (m)	Table Angle (Degree)	Raw Value (dBuV)	Correction Factor (dB/m)
1	*2440.00	102.4 PK			1.51 H	149	103.6	-1.2
2	*2440.00	92.0 AV			1.51 H	149	93.2	-1.2
3	4880.00	45.3 PK	74.0	-28.7	1.09 H	134	41.5	3.8
4	4880.00	34.9 AV	54.0	-19.1	1.09 H	134	31.1	3.8
5	7320.00	54.0 PK	74.0	-20.0	1.13 H	129	44.3	9.7
6	7320.00	43.6 AV	54.0	-10.4	1.13 H	129	33.9	9.7
Antenna Polarity & Test Distance : Vertical at 3 m								
No	Frequency (MHz)	Emission Level (dBuV/m)	Limit (dBuV/m)	Margin (dB)	Antenna Height (m)	Table Angle (Degree)	Raw Value (dBuV)	Correction Factor (dB/m)
1	*2440.00	95.2 PK			1.36 V	20	96.4	-1.2
2	*2440.00	84.8 AV			1.36 V	20	86.0	-1.2
3	4880.00	43.7 PK	74.0	-30.3	1.31 V	308	39.9	3.8
4	4880.00	33.3 AV	54.0	-20.7	1.31 V	308	29.5	3.8
5	7320.00	50.0 PK	74.0	-24.0	1.59 V	14	40.3	9.7
6	7320.00	39.6 AV	54.0	-14.4	1.59 V	14	29.9	9.7

**Remarks:**

- Emission Level(dBuV/m) = Raw Value(dBuV) + Correction Factor(dB/m)
- Correction Factor(dB/m) = Antenna Factor(dB/m) + Cable Factor(dB) – Pre-Amplifier Factor(dB)
- Margin value = Emission Level – Limit value
- The other emission levels were very low against the limit.
- " \* ": Fundamental frequency.
- The average value of fundamental and harmonic frequency is: Average = Peak value + 20 log(Duty cycle) Where the duty factor is calculated from following formula:  
 $20 \log(\text{Duty cycle}) = 20 \log(0.379 \text{ ms} / 1.255 \text{ ms}) = -10.4 \text{ dB}$   
 Please see page 3.3 for plotted duty.



<b>RF Mode</b>	TX BT_LE-1M	<b>Channel</b>	CH 39 : 2480 MHz
<b>Frequency Range</b>	1GHz ~ 25GHz	<b>Detector Function</b>	Peak (PK) Average (AV)

Antenna Polarity & Test Distance : Horizontal at 3 m								
No	Frequency (MHz)	Emission Level (dBuV/m)	Limit (dBuV/m)	Margin (dB)	Antenna Height (m)	Table Angle (Degree)	Raw Value (dBuV)	Correction Factor (dB/m)
1	*2480.00	102.3 PK			1.50 H	158	103.5	-1.2
2	*2480.00	91.9 AV			1.50 H	158	93.1	-1.2
3	2486.00	58.8 PK	74.0	-15.2	1.50 H	158	60.0	-1.2
<b>4</b>	<b>2486.00</b>	<b>48.4 AV</b>	<b>54.0</b>	<b>-5.6</b>	<b>1.50 H</b>	<b>158</b>	<b>49.6</b>	<b>-1.2</b>
5	4960.00	45.8 PK	74.0	-28.2	1.12 H	135	41.8	4.0
6	4960.00	35.4 AV	54.0	-18.6	1.12 H	135	31.4	4.0
7	7440.00	54.2 PK	74.0	-19.8	1.11 H	137	44.5	9.7
8	7440.00	43.8 AV	54.0	-10.2	1.11 H	137	34.1	9.7
Antenna Polarity & Test Distance : Vertical at 3 m								
No	Frequency (MHz)	Emission Level (dBuV/m)	Limit (dBuV/m)	Margin (dB)	Antenna Height (m)	Table Angle (Degree)	Raw Value (dBuV)	Correction Factor (dB/m)
1	*2480.00	94.9 PK			1.30 V	10	96.1	-1.2
2	*2480.00	84.5 AV			1.30 V	10	85.7	-1.2
3	2486.00	55.6 PK	74.0	-18.4	1.30 V	10	56.8	-1.2
4	2486.00	45.2 AV	54.0	-8.8	1.30 V	10	46.4	-1.2
5	4960.00	44.3 PK	74.0	-29.7	1.30 V	293	40.3	4.0
6	4960.00	33.9 AV	54.0	-20.1	1.30 V	293	29.9	4.0
7	7440.00	50.8 PK	74.0	-23.2	1.53 V	8	41.1	9.7
8	7440.00	40.4 AV	54.0	-13.6	1.53 V	8	30.7	9.7

**Remarks:**

1. Emission Level(dBuV/m) = Raw Value(dBuV) + Correction Factor(dB/m)
2. Correction Factor(dB/m) = Antenna Factor(dB/m) + Cable Factor(dB) – Pre-Amplifier Factor(dB)
3. Margin value = Emission Level – Limit value
4. The other emission levels were very low against the limit.
5. " \* ": Fundamental frequency.
6. The average value of fundamental and harmonic frequency is: Average = Peak value + 20 log(Duty cycle) Where the duty factor is calculated from following formula:  
 $20 \log(\text{Duty cycle}) = 20 \log(0.379 \text{ ms} / 1.255 \text{ ms}) = -10.4 \text{ dB}$   
 Please see page 3.3 for plotted duty.

### Below 1GHz Data:

<b>RF Mode</b>	TX BT_LE-1M	<b>Channel</b>	CH 0 : 2402 MHz
<b>Frequency Range</b>	9kHz ~ 1GHz	<b>Detector Function</b>	Quasi-Peak (QP)

Antenna Polarity & Test Distance : Horizontal at 3 m								
No	Frequency (MHz)	Emission Level (dBuV/m)	Limit (dBuV/m)	Margin (dB)	Antenna Height (m)	Table Angle (Degree)	Raw Value (dBuV)	Correction Factor (dB/m)
1	44.94	33.0 QP	40.0	-7.0	3.00 H	57	41.2	-8.2
2	112.98	24.0 QP	43.5	-19.5	3.00 H	64	34.5	-10.5
3	208.94	25.9 QP	43.5	-17.6	1.50 H	103	36.6	-10.7
4	278.64	28.8 QP	46.0	-17.2	1.00 H	84	36.1	-7.3
5	444.65	26.4 QP	46.0	-19.6	1.50 H	360	28.6	-2.2
6	578.37	29.0 QP	46.0	-17.0	1.50 H	115	28.4	0.6

### Remarks:

1. Emission Level(dBuV/m) = Raw Value(dBuV) + Correction Factor(dB/m)
2. Correction Factor(dB/m) = Antenna Factor(dB/m) + Cable Factor(dB) – Pre-Amplifier Factor(dB)
3. Margin value = Emission Level – Limit value
4. The other emission levels were very low against the limit of frequency range 30MHz~1000MHz.
5. The emission levels were very low against the limit of frequency range 9kHz~30MHz: the amplitude of spurious emissions attenuated more than 20 dB below the permissible value to be report.

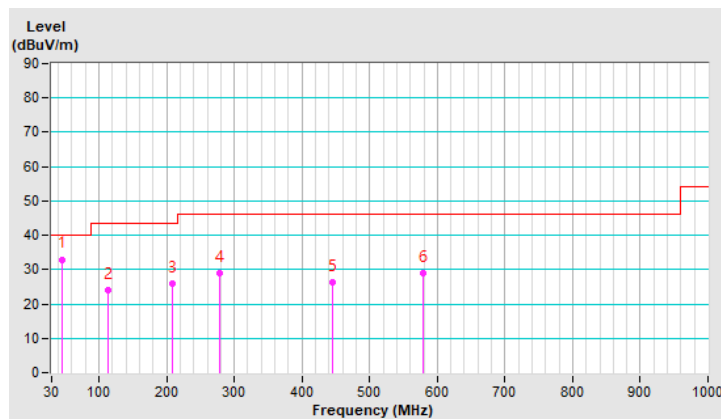

RF Mode	TX BT_LE-1M	Channel	CH 0 : 2402 MHz
Frequency Range	9kHz ~ 1GHz	Detector Function	Quasi-Peak (QP)

**Antenna Polarity & Test Distance : Vertical at 3 m**

No	Frequency (MHz)	Emission Level (dBUV/m)	Limit (dBUV/m)	Margin (dB)	Antenna Height (m)	Table Angle (Degree)	Raw Value (dBUV)	Correction Factor (dB/m)
1	45.89	34.0 QP	40.0	-6.0	1.00 V	80	42.1	-8.1
2	88.59	29.0 QP	43.5	-14.5	2.00 V	360	42.8	-13.8
3	187.67	27.3 QP	43.5	-16.2	1.00 V	270	37.3	-10.0
4	250.55	25.8 QP	46.0	-20.2	1.00 V	264	34.4	-8.6
5	436.31	27.2 QP	46.0	-18.8	1.50 V	130	29.5	-2.3
6	558.46	29.1 QP	46.0	-16.9	3.00 V	0	29.1	0.0

**Remarks:**

1. Emission Level(dBuV/m) = Raw Value(dBuV) + Correction Factor(dB/m)
2. Correction Factor(dB/m) = Antenna Factor(dB/m) + Cable Factor(dB) – Pre-Amplifier Factor(dB)
3. Margin value = Emission Level – Limit value
4. The other emission levels were very low against the limit of frequency range 30MHz~1000MHz.
5. The emission levels were very low against the limit of frequency range 9kHz~30MHz: the amplitude of spurious emissions attenuated more than 20 dB below the permissible value to be report.

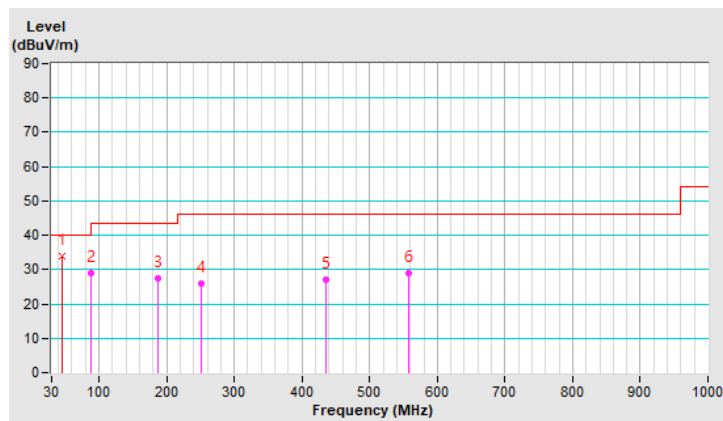

## 4.2 Conducted Emission Measurement

### 4.2.1 Limits of Conducted Emission Measurement

Frequency (MHz)	Conducted Limit (dBuV)	
	Quasi-peak	Average
0.15 - 0.5	66 - 56	56 - 46
0.50 - 5.0	56	46
5.0 - 30.0	60	50

Note: 1. The lower limit shall apply at the transition frequencies.

2. The limit decreases in line with the logarithm of the frequency in the range of 0.15 to 0.50MHz.

### 4.2.2 Test Instruments

DESCRIPTION & MANUFACTURER	MODEL NO.	SERIAL NO.	CALIBRATED DATE	CALIBRATED UNTIL
Test Receiver R&S	ESCS 30	847124/029	Oct. 20, 2020	Oct. 19, 2021
Line-Impedance Stabilization Network (for EUT) R&S	ESH3-Z5	848773/004	Oct. 27, 2020	Oct. 26, 2021
Line-Impedance Stabilization Network (for Peripheral) R&S	ESH3-Z5	835239/001	Mar. 26, 2021	Mar. 25, 2022
50 ohms Terminator	50	3	Oct. 26, 2020	Oct. 25, 2021
RF Cable	5D-FB	COCCAB-001	Sep. 26, 2020	Sep. 25, 2021
Fixed attenuator EMCI	STI02-2200-10	005	Aug. 29, 2020	Aug. 28, 2021
Software BVADT	BVADT_Cond_ V7.3.7.4	NA	NA	NA

**Note:**

1. The calibration interval of the above test instruments are 12 months and the calibrations are traceable to NML/ROC and NIST/USA.
2. The test was performed in Conduction 1.
3. Tested Date: July 01, 2021

#### 4.2.3 Test Procedures

- The EUT was placed 0.4 meters from the conducting wall of the shielded room with EUT being connected to the power mains through a line impedance stabilization network (LISN). Other support units were connected to the power mains through another LISN. The two LISNs provide 50 ohm/ 50uH of coupling impedance for the measuring instrument.
- Both lines of the power mains connected to the EUT were checked for maximum conducted interference.
- The frequency range from 150kHz to 30MHz was searched. Emission levels under (Limit - 20dB) was not recorded.

**Note:** The resolution bandwidth and video bandwidth of test receiver is 9kHz for quasi-peak detection (QP) and average detection (AV) at frequency 0.15MHz-30MHz.

#### 4.2.4 Deviation from Test Standard

No deviation.

#### 4.2.5 Test Setup

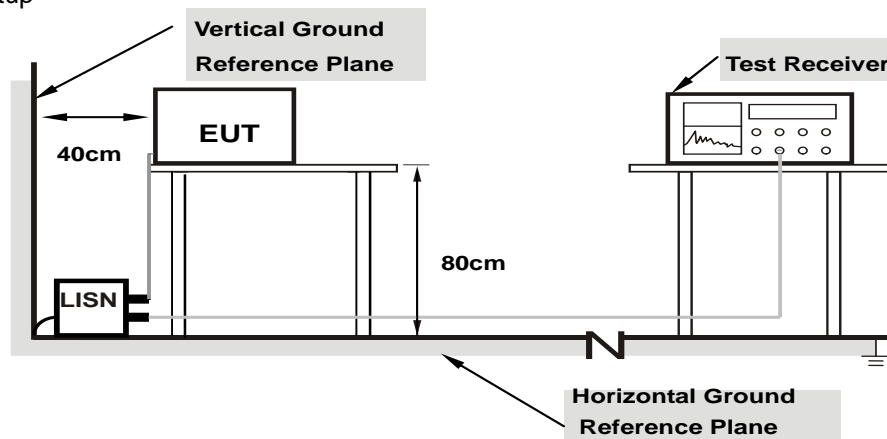

**Note:** 1.Support units were connected to second LISN.

For the actual test configuration, please refer to the attached file (Test Setup Photo).

#### 4.2.6 EUT Operating Conditions

- Placed the EUT on the testing table.
- Controlling software (BlueNRG) has been activated to set the EUT under transmission condition continuously at specific channel frequency.

## 4.2.7 Test Results

<b>RF Mode</b>	TX BT_LE-1M	<b>Channel</b>	CH 0 : 2402 MHz
<b>Frequency Range</b>	150kHz ~ 30MHz	<b>Detector Function &amp; Resolution Bandwidth</b>	Quasi-Peak (QP) / Average (AV), 9kHz

Phase Of Power : Line (L)										
No	Frequency (MHz)	Correction Factor (dB)	Reading Value (dBuV)		Emission Level (dBuV)		Limit (dBuV)		Margin (dB)	
			Q.P.	AV.	Q.P.	AV.	Q.P.	AV.	Q.P.	AV.
1	0.16953	9.98	32.77	22.79	42.75	32.77	64.98	54.98	-22.23	-22.21
2	0.23594	10.01	27.45	16.45	37.46	26.46	62.24	52.24	-24.78	-25.78
3	0.43906	10.03	23.38	12.92	33.41	22.95	57.08	47.08	-23.67	-24.13
<b>4</b>	<b>0.56797</b>	<b>10.04</b>	<b>32.46</b>	<b>22.04</b>	<b>42.50</b>	<b>32.08</b>	<b>56.00</b>	<b>46.00</b>	<b>-13.50</b>	<b>-13.92</b>
5	0.97031	10.07	23.62	11.28	33.69	21.35	56.00	46.00	-22.31	-24.65
6	1.68750	10.10	23.61	15.42	33.71	25.52	56.00	46.00	-22.29	-20.48

## Remarks:

1. Q.P. and AV. are abbreviations of quasi-peak and average individually.
2. The emission levels of other frequencies were very low against the limit.
3. Margin value = Emission level – Limit value
4. Correction factor = Insertion loss + Cable loss
5. Emission Level = Correction Factor + Reading Value

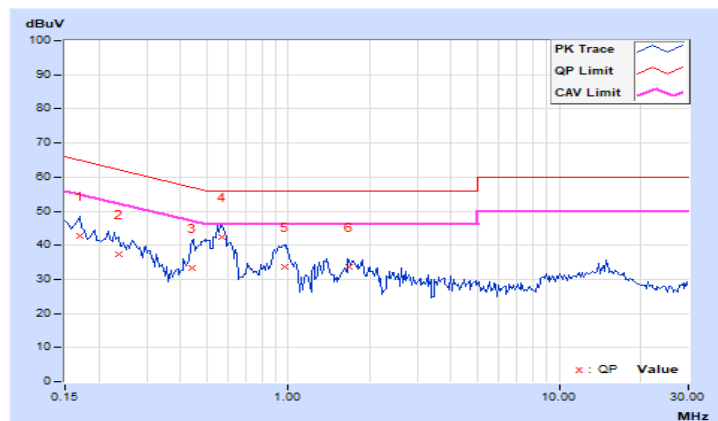

<b>RF Mode</b>	TX BT_LE-1M	<b>Channel</b>	CH 0 : 2402 MHz
<b>Frequency Range</b>	150kHz ~ 30MHz	<b>Detector Function &amp; Resolution Bandwidth</b>	Quasi-Peak (QP) / Average (AV), 9kHz

Phase Of Power : Neutral (N)										
No	Frequency (MHz)	Correction Factor (dB)	Reading Value (dBuV)		Emission Level (dBuV)		Limit (dBuV)		Margin (dB)	
			Q.P.	AV.	Q.P.	AV.	Q.P.	AV.	Q.P.	AV.
1	0.16562	9.97	33.33	17.00	43.30	26.97	65.18	55.18	-21.88	-28.21
2	0.24766	10.00	26.73	12.35	36.73	22.35	61.84	51.84	-25.11	-29.49
3	0.56797	10.03	25.61	14.46	35.64	24.49	56.00	46.00	-20.36	-21.51
4	0.98984	10.06	19.90	5.45	29.96	15.51	56.00	46.00	-26.04	-30.49
5	1.85938	10.12	14.16	2.70	24.28	12.82	56.00	46.00	-31.72	-33.18
6	14.94531	10.89	13.18	6.13	24.07	17.02	60.00	50.00	-35.93	-32.98

**Remarks:**

1. Q.P. and AV. are abbreviations of quasi-peak and average individually.
2. The emission levels of other frequencies were very low against the limit.
3. Margin value = Emission level – Limit value
4. Correction factor = Insertion loss + Cable loss
5. Emission Level = Correction Factor + Reading Value

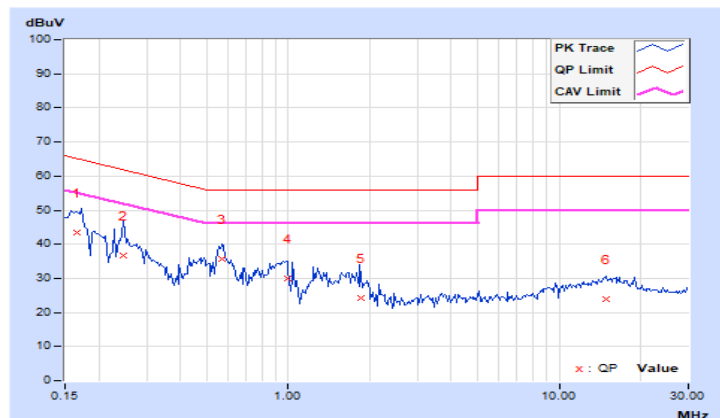

### 4.3 6dB Bandwidth Measurement

#### 4.3.1 Limits of 6dB Bandwidth Measurement

The minimum of 6dB Bandwidth Measurement is 0.5 MHz.

#### 4.3.2 Test Setup

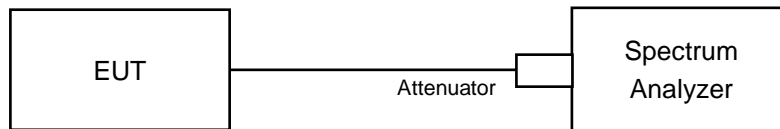

#### 4.3.3 Test Instruments

Refer to section 4.1.2 to get information of above instrument.

#### 4.3.4 Test Procedure

- a. Set resolution bandwidth (RBW) = 100kHz
- b. Set the video bandwidth (VBW)  $\geq 3 \times$  RBW, Detector = Peak.
- c. Trace mode = max hold.
- d. Sweep = auto couple.
- e. Measure the maximum width of the emission that is constrained by the frequencies associated with the two amplitude points (upper and lower) that are attenuated by 6 dB relative to the maximum level measured in the fundamental emission

#### 4.3.5 Deviation from Test Standard

No deviation.

#### 4.3.6 EUT Operating Conditions

The software provided by client to enable the EUT under transmission condition continuously at lowest, middle and highest channel frequencies individually.



### 4.3.7 Test Results

Channel	Frequency (MHz)	6dB Bandwidth (MHz)	Minimum Limit (MHz)	Pass / Fail
0	2402	0.68	0.5	Pass
19	2440	0.68	0.5	Pass
39	2480	0.69	0.5	Pass

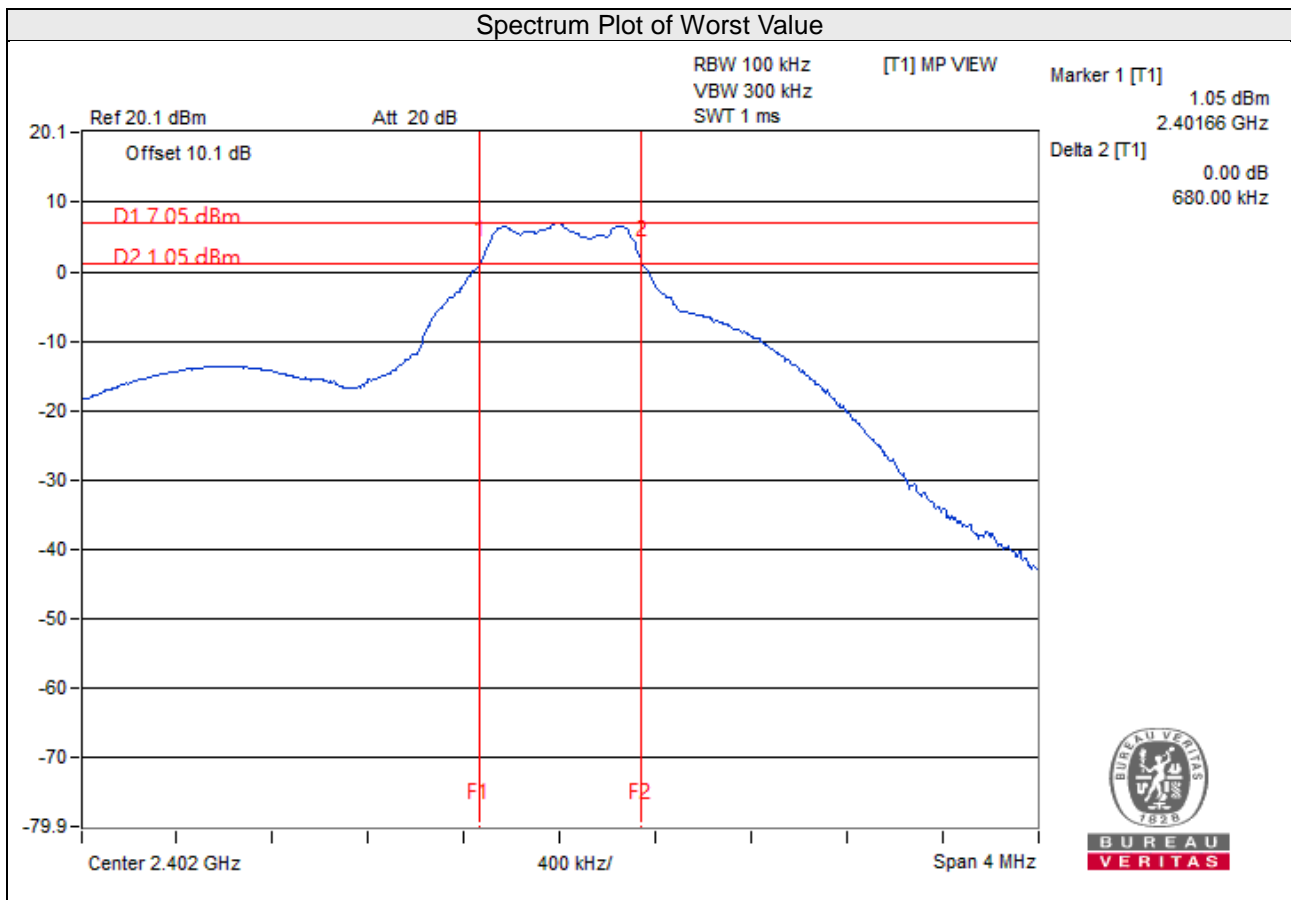

## 4.4 Conducted Output Power Measurement

### 4.4.1 Limits of Conducted Output Power Measurement

For systems using digital modulation in the 2400–2483.5 MHz bands: 1 Watt (30dBm)

### 4.4.2 Test Setup

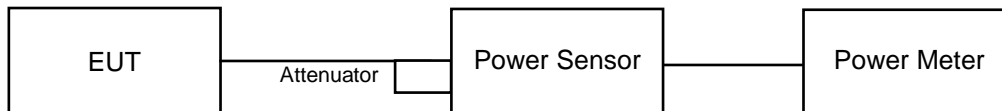

### 4.4.3 Test Instruments

Refer to section 4.1.2 to get information of above instrument.

### 4.4.4 Test Procedures

A peak power sensor was used on the output port of the EUT. A power meter was used to read the response of the peak power sensor. Record the power level.

Average power sensor was used to perform output power measurement, trigger and gating function of wide band power meter is enabled to measure max output power of TX on burst. Duty factor is not added to measured value.

### 4.4.5 Deviation from Test Standard

No deviation.

### 4.4.6 EUT Operating Conditions

The software provided by client to enable the EUT under transmission condition continuously at lowest, middle and highest channel frequencies individually.

#### 4.4.7 Test Results

##### FOR PEAK POWER

Channel	Frequency (MHz)	Peak Power (mW)	Peak Power (dBm)	Limit (dBm)	Pass/Fail
0	2402	5.559	7.45	30	Pass
19	2440	5.495	7.40	30	Pass
39	2480	5.37	7.30	30	Pass

##### FOR AVERAGE POWER

Channel	Frequency (MHz)	Average Power (mW)	Average Power (dBm)
0	2402	5.346	7.28
19	2440	5.321	7.26
39	2480	5.224	7.18

## 4.5 Power Spectral Density Measurement

### 4.5.1 Limits of Power Spectral Density Measurement

The Maximum of Power Spectral Density Measurement is 8dBm in any 3 kHz.

### 4.5.2 Test Setup

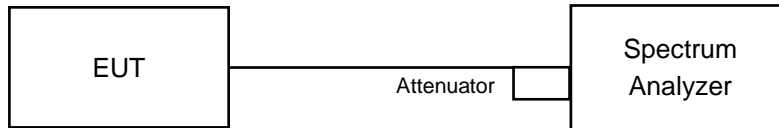

### 4.5.3 Test Instruments

Refer to section 4.1.2 to get information of above instrument.

### 4.5.4 Test Procedure

- a. Set analyzer center frequency to DTS channel center frequency.
- b. Set the span to 1.5 times the DTS bandwidth.
- c. Set the RBW to:  $3 \text{ kHz} \leq \text{RBW} \leq 100 \text{ kHz}$ .
- d. Set the VBW  $\geq 3 \times \text{RBW}$ .
- e. Detector = peak.
- f. Sweep time = auto couple.
- g. Trace mode = max hold.
- h. Allow trace to fully stabilize.
- i. Use the peak marker function to determine the maximum amplitude level within the RBW.

### 4.5.5 Deviation from Test Standard

No deviation.

### 4.5.6 EUT Operating Condition

The software provided by client to enable the EUT under transmission condition continuously at lowest, middle and highest channel frequencies individually.

#### 4.5.7 Test Results

Channel	Freq. (MHz)	PSD (dBm/3kHz)	Limit (dBm/3kHz)	Pass /Fail
0	2402	-7.18	8	Pass
19	2440	-7.47	8	Pass
39	2480	-6.94	8	Pass

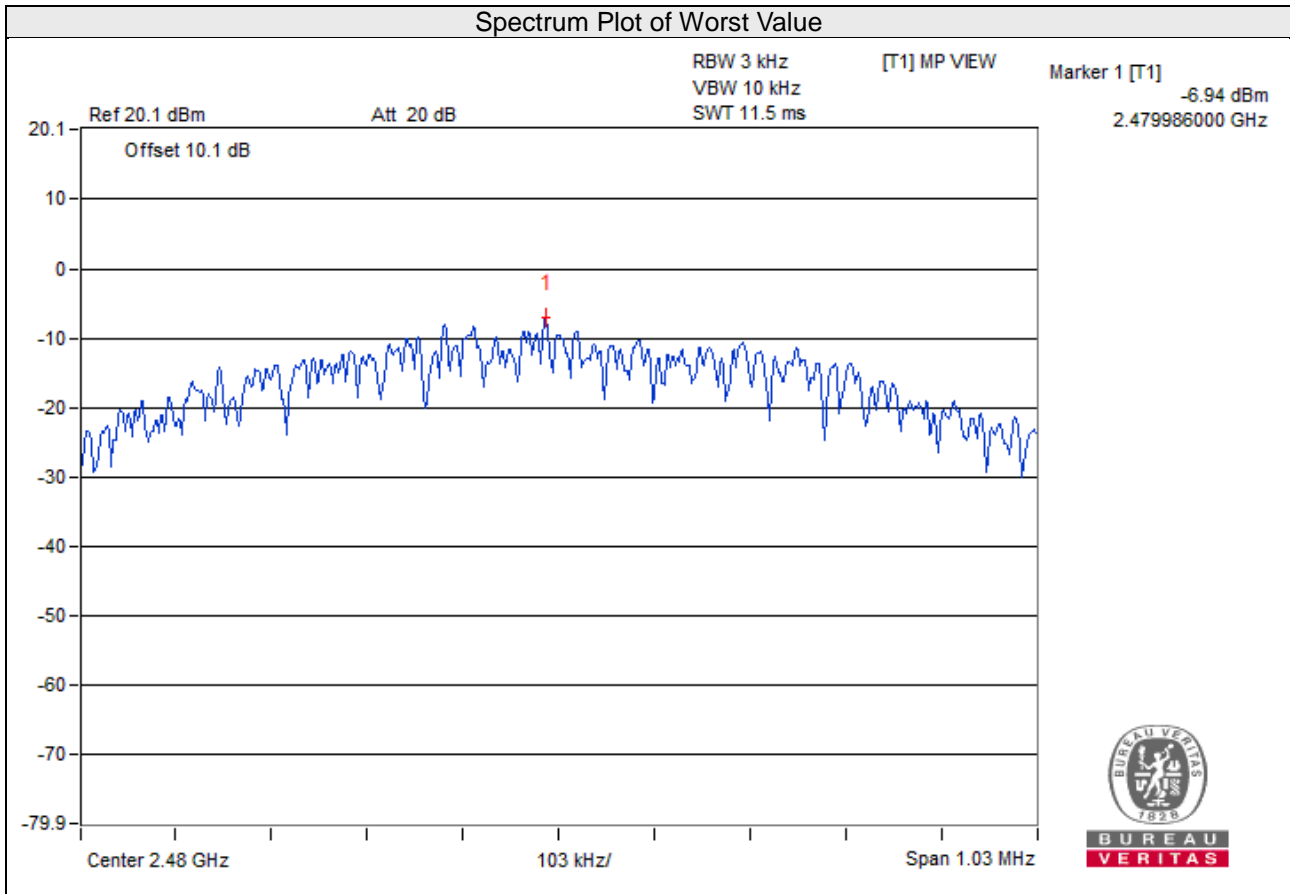

## 4.6 Conducted Out of Band Emission Measurement

### 4.6.1 Limits of Conducted Out of Band Emission Measurement

Below 20dB of the highest emission level of operating band (in 100kHz Resolution Bandwidth).

### 4.6.2 Test Setup

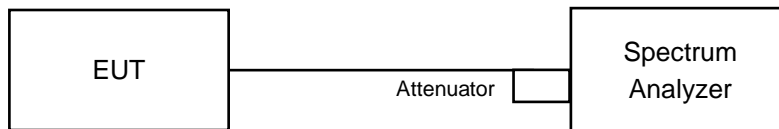

### 4.6.3 Test Instruments

Refer to section 4.1.2 to get information of above instrument.

### 4.6.4 Test Procedure

#### MEASUREMENT PROCEDURE REF

1. Set the RBW = 100 kHz.
2. Set the VBW  $\geq$  300 kHz.
3. Detector = peak.
4. Sweep time = auto couple.
5. Trace mode = max hold.
6. Allow trace to fully stabilize.
7. Use the peak marker function to determine the maximum power level in any 100 kHz band segment within the fundamental EBW.

#### MEASUREMENT PROCEDURE OOBE

1. Set RBW = 100 kHz.
2. Set VBW  $\geq$  300 kHz.
3. Detector = peak.
4. Sweep = auto couple.
5. Trace Mode = max hold.
6. Allow trace to fully stabilize.
7. Use the peak marker function to determine the maximum amplitude level.

### 4.6.5 Deviation from Test Standard

No deviation.

### 4.6.6 EUT Operating Condition

The software provided by client enabled the EUT to transmit and receive data at lowest and highest channel frequencies individually.

### 4.6.7 Test Results

The spectrum plots are attached on the following pages. D1 line indicates the highest level, and D2 line indicates the 20dB offset below D1. It shows compliance with the requirement.

### CH 0

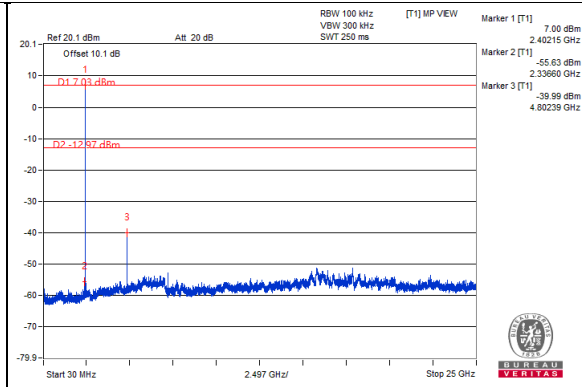
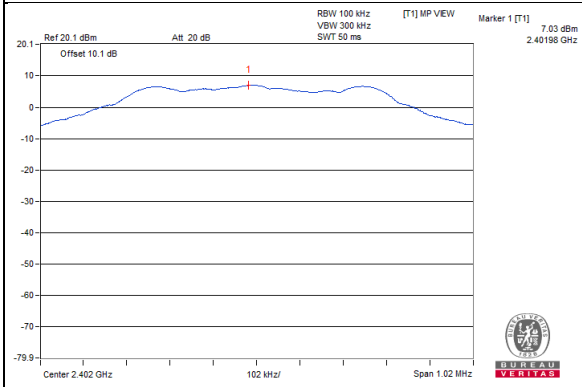

### CH 19

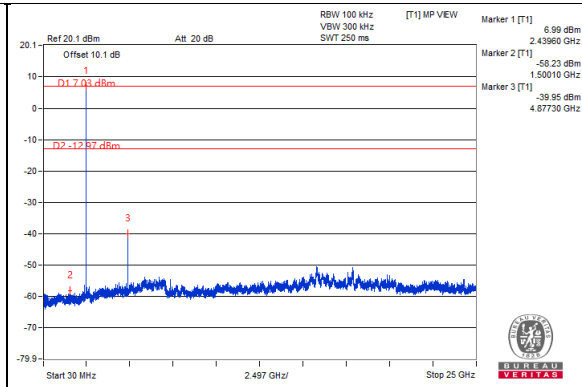
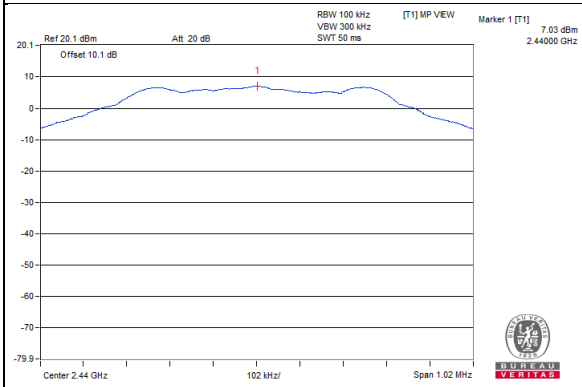

### CH 39

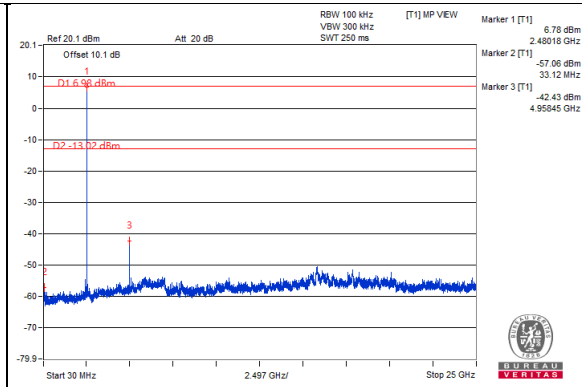
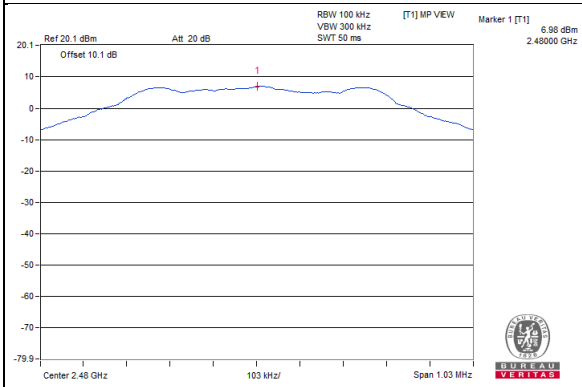

### CH 0 Band edge

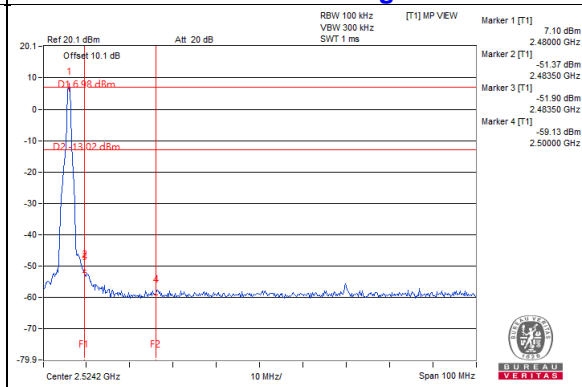
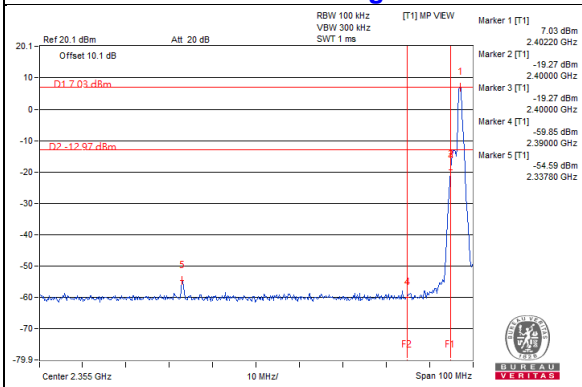

## 5 Pictures of Test Arrangements

Please refer to the attached file (Test Setup Photo).



# Annex A - Band-Edge Measurement

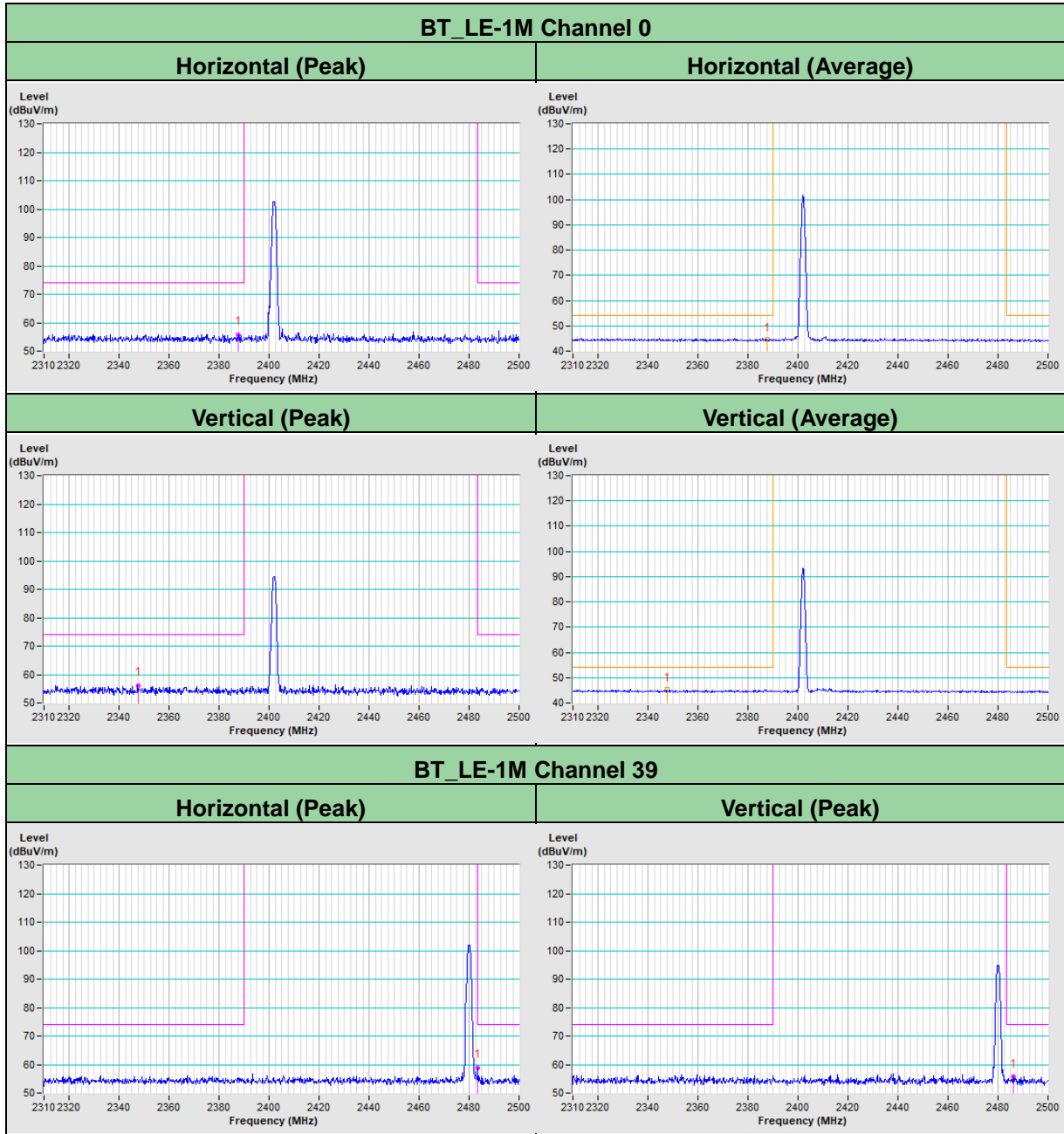

## Appendix – Information of the Testing Laboratories

We, Bureau Veritas Consumer Products Services (H.K.) Ltd., Taoyuan Branch, were founded in 1988 to provide our best service in EMC, Radio, Telecom and Safety consultation. Our laboratories are FCC recognized accredited test firms and accredited according to ISO/IEC 17025.

If you have any comments, please feel free to contact us at the following:

**Lin Kou EMC/RF Lab**

Tel: 886-2-26052180

Fax: 886-2-26051924

**Hsin Chu EMC/RF/Telecom Lab**

Tel: 886-3-6668565

Fax: 886-3-6668323

**Hwa Ya EMC/RF/Safety Lab**

Tel: 886-3-3183232

Fax: 886-3-3270892

**Email:** [service.adt@tw.bureauveritas.com](mailto:service.adt@tw.bureauveritas.com)

**Web Site:** [www.bureauveritas-adt.com](http://www.bureauveritas-adt.com)

The address and road map of all our labs can be found in our web site also.

--- END ---