

FCC Test Report (BT-LE)

Report No.: RF200611E06-1

FCC ID: JNZB00040

Test Model: B00040

Received Date: June 11, 2020

Test Date: July 18 to Aug. 03, 2020

Issued Date: Aug. 11, 2020

Applicant: LOGITECH FAR EAST LTD.

Address: #2 Creation Rd. 4, Science-Based Ind. Park Hsinchu Taiwan, R.O.C.

Issued By: Bureau Veritas Consumer Products Services (H.K.) Ltd., Taoyuan Branch
Hsin Chu Laboratory

Lab Address: E-2, No.1, Li Hsin 1st Road, Hsinchu Science Park, Hsinchu City 300,
Taiwan

Test Location: E-2, No.1, Li Hsin 1st Road, Hsinchu Science Park, Hsinchu City 300,
Taiwan

**FCC Registration /
Designation Number:** 723255 / TW2022



This report is for your exclusive use. Any copying or replication of this report to or for any other person or entity, or use of our name or trademark, is permitted only with our prior written permission. This report sets forth our findings solely with respect to the test samples identified herein. The results set forth in this report are not indicative or representative of the quality or characteristics of the lot from which a test sample was taken or any similar or identical product specifically and expressly noted. Our report includes all of the tests requested by you and the results thereof based upon the information that you provided to us. You have 60 days from date of issuance of this report to notify us of any material error or omission caused by our negligence, provided, however, that such notice shall be in writing and shall specifically address the issue you wish to raise. A failure to raise such issue within the prescribed time shall constitute your unqualified acceptance of the completeness of this report, the tests conducted and the correctness of the report contents. Unless specific mention, the uncertainty of measurement has been explicitly taken into account to declare the compliance or non-compliance to the specification.

Table of Contents

Release Control Record	4
1 Certificate of Conformity	5
2 Summary of Test Results	6
2.1 Measurement Uncertainty.....	6
2.2 Modification Record.....	6
3 General Information	7
3.1 General Description of EUT (BT-LE).....	7
3.2 Description of Test Modes.....	9
3.2.1 Test Mode Applicability and Tested Channel Detail.....	10
3.3 Duty Cycle of Test Signal.....	12
3.4 Description of Support Units.....	13
3.4.1 Configuration of System under Test.....	14
3.5 General Description of Applied Standards and References.....	15
4 Test Types and Results	16
4.1 Radiated Emission and Bandedge Measurement.....	16
4.1.1 Limits of Radiated Emission and Bandedge Measurement.....	16
4.1.2 Test Instruments.....	17
4.1.3 Test Procedures.....	19
4.1.4 Deviation from Test Standard.....	19
4.1.5 Test Setup.....	20
4.1.6 EUT Operating Conditions.....	21
4.1.7 Test Results.....	22
4.2 Conducted Emission Measurement.....	30
4.2.1 Limits of Conducted Emission Measurement.....	30
4.2.2 Test Instruments.....	30
4.2.3 Test Procedures.....	31
4.2.4 Deviation from Test Standard.....	31
4.2.5 Test Setup.....	31
4.2.6 EUT Operating Conditions.....	31
4.2.7 Test Results.....	32
4.3 6dB Bandwidth Measurement.....	34
4.3.1 Limits of 6dB Bandwidth Measurement.....	34
4.3.2 Test Setup.....	34
4.3.3 Test Instruments.....	34
4.3.4 Test Procedure.....	34
4.3.5 Deviation from Test Standard.....	34
4.3.6 EUT Operating Conditions.....	34
4.3.7 Test Results.....	35
4.4 Conducted Output Power Measurement.....	36
4.4.1 Limits of Conducted Output Power Measurement.....	36
4.4.2 Test Setup.....	36
4.4.3 Test Instruments.....	36
4.4.4 Test Procedures.....	36
4.4.5 Deviation from Test Standard.....	36
4.4.6 EUT Operating Conditions.....	36
4.4.7 Test Results.....	37
4.5 Power Spectral Density Measurement.....	38
4.5.1 Limits of Power Spectral Density Measurement.....	38
4.5.2 Test Setup.....	38
4.5.3 Test Instruments.....	38
4.5.4 Test Procedure.....	38
4.5.5 Deviation from Test Standard.....	38
4.5.6 EUT Operating Condition.....	38

4.5.7 Test Results	39
4.6 Conducted Out of Band Emission Measurement.....	40
4.6.1 Limits of Conducted Out of Band Emission Measurement	40
4.6.2 Test Setup.....	40
4.6.3 Test Instruments	40
4.6.4 Test Procedure	40
4.6.5 Deviation from Test Standard	40
4.6.6 EUT Operating Condition	40
4.6.7 Test Results	40
5 Pictures of Test Arrangements.....	43
Annex A - Band-Edge Measurement.....	44
Appendix – Information of the Testing Laboratories	46

Release Control Record

Issue No.	Description	Date Issued
RF200611E06-1	Original release.	Aug. 11, 2020

1 Certificate of Conformity

Product: Wireless Earphones

Brand: ULTIMATE EARS

Test Model: B00040

Sample Status: ENGINEERING SAMPLE

Applicant: LOGITECH FAR EAST LTD.

Test Date: July 18 to Aug. 03, 2020

Standards: 47 CFR FCC Part 15, Subpart C (Section 15.247)
ANSI C63.10: 2013

The above equipment has been tested by **Bureau Veritas Consumer Products Services (H.K.) Ltd., Taoyuan Branch**, and found compliance with the requirement of the above standards. The test record, data evaluation & Equipment Under Test (EUT) configurations represented herein are true and accurate accounts of the measurements of the sample's EMC characteristics under the conditions specified in this report.

Prepared by : Phoenix Huang , **Date:** Aug. 11, 2020
Phoenix Huang / Specialist

Approved by : Clark Lin , **Date:** Aug. 11, 2020
Clark Lin / Technical Manager

2 Summary of Test Results

47 CFR FCC Part 15, Subpart C (Section 15.247)			
FCC Clause	Test Item	Result	Remarks
15.207	AC Power Conducted Emission	PASS	Meet the requirement of limit. Minimum passing margin is -25.37 dB at 0.16562 MHz.
15.205 / 15.209 / 15.247(d)	Radiated Emissions and Band Edge Measurement	PASS	Meet the requirement of limit. Minimum passing margin is -5.2 dB at 7440.00 MHz.
15.247(d)	Antenna Port Emission	PASS	Meet the requirement of limit.
15.247(a)(2)	6dB bandwidth	PASS	Meet the requirement of limit.
15.247(b)	Conducted power	PASS	Meet the requirement of limit.
15.247(e)	Power Spectral Density	PASS	Meet the requirement of limit.
15.203	Antenna Requirement	PASS	No antenna connector is used.

Note:

- For 2.4 GHz band compliance with rule 15.247(d) of the band-edge items, the test plots were recorded in Annex A.
- Determining compliance based on the results of the compliance measurement, not taking into account measurement instrumentation uncertainty.

2.1 Measurement Uncertainty

Where relevant, the following measurement uncertainty levels have been estimated for tests performed on the EUT as specified in CISPR 16-4-2:

Measurement	Frequency	Expanded Uncertainty (k=2) (\pm)
Conducted Emissions at mains ports	150kHz ~ 30MHz	1.9 dB
Conducted emissions	-	2.5 dB
Radiated Emissions up to 1 GHz	9kHz ~ 30MHz	3.1 dB
	30MHz ~ 1GHz	5.1 dB
Radiated Emissions above 1 GHz	1GHz ~ 18GHz	5.1 dB
	18GHz ~ 40GHz	5.3 dB

2.2 Modification Record

There were no modifications required for compliance.

3 General Information

3.1 General Description of EUT (BT-LE)

Product	Wireless Earphones
Brand	ULTIMATE EARS
Test Model	B00040
Status of EUT	ENGINEERING SAMPLE
Power Supply Rating	Wireless earphone battery output is 3.7 Vdc, Wireless earphone inputs are (5Vdc/10mA to 5Vdc/60mA) each. Charging case output is 5Vdc, 60mA for each wireless earphone (5Vdc/120mA total).
Modulation Type	GFSK
Modulation Technology	DTS
Transfer Rate	BT-LE: Up to 2 Mbps (*Note 1)
Operating Frequency	BT-LE: 2.402 ~ 2.480 GHz (*Note 1)
Number of Channel	BT-LE: 40 (*Note 1)
Output Power	8.453 mW
Antenna Type	Refer to Note
Antenna Connector	Refer to Note
Accessory Device	Charging case x 1
Data Cable Supplied	USB to type C cable x 1 (Unshielded, 0.6 m)

Note:

- BT-LE technique supports 1Mbps and 2Mbps data rates, both have been evaluated in this test report. Refer to “**section 3.2 Description of Test Modes**” for more detail specification.
- The EUT (Wireless Earphones, Charging Case) power needs to be supplied from a battery, the information is as below table:

Wireless earphones battery		
Brand Name	Model No.	Spec.
VARTA or Logitech	CP1254 A3 or 533-000186	3.7Vdc, 60 mAh
Charging case		
Brand Name	Model No.	Spec.
ULTIMATE EARS	B00041	Input: 5 Vdc, 350 mA Output: 5 Vdc, 250 mA
Battery (For charging case used)		
Brand Name	Model No.	Spec.
Springpower Technology (Shenzhen) Co., Ltd. or Logitech	491032 or 533-000182 or 533-000193	3.8 Vdc, 135 mAh, 0.513 Wh

- When charge case is open, wireless function will be operated, when charge case is close, wireless function will be not operated.
- The antenna provided to the EUT, please refer to the following table:

Earphone	Antenna Gain (dBi)	Frequency Range (GHz)	Antenna Type	Connector Type
Left	-1.02	2.4~2.4835	Chip	None
Right	-1.02	2.4~2.4835	Chip	None

5. The EUT was pre-tested under the following modes:

Radiated Emission test	
Test Mode	Description
Mode A	EUT powered by Charge case (use USB adapter)
Mode B	EUT powered by Charge case
Note: From the above modes, the worst case was found in Mode A . Therefore only the test data of the mode was recorded in this report.	
AC Power Conducted Emission test	
Test Mode	Description
Mode A	EUT powered by Charge case (use USB adapter)
Mode B	EUT powered by Charge case (use Laptop)
Note: From the above modes, the worst case was found in Mode A . Therefore only the test data of the mode was recorded in this report.	

6. The above EUT information is declared by manufacturer and for more detailed features description, please refer to the manufacturer's specifications or user's manual.

7. The above Antenna information is declared by manufacturer and for more detailed features description, please refer to the manufacturer's specifications, the laboratory shall not be held responsible.

3.2 Description of Test Modes

BT-LE channels:

RF Channel	RF Center Frequency	Channel Index	Channels Type for BT 5.x		Channels Type for BT 4.x
			Maximum Data Rate 2Mbps	Maximum Data Rate 1Mbps	Maximum Data Rate 1Mbps
0	2402 MHz	37		●	●
1	2404 MHz	0	●		●
2	2406 MHz	1	●		●
3	2408 MHz	2	●		●
4	2410 MHz	3	●		●
5	2412 MHz	4	●		●
6	2414 MHz	5	●		●
7	2416 MHz	6	●		●
8	2418 MHz	7	●		●
9	2420 MHz	8	●		●
10	2422 MHz	9	●		●
11	2424 MHz	10	●		●
12	2426 MHz	38		●	●
13	2428 MHz	11	●		●
14	2430 MHz	12	●		●
15	2432 MHz	13	●		●
16	2434 MHz	14	●		●
17	2436 MHz	15	●		●
18	2438 MHz	16	●		●
19	2440 MHz	17	●		●
20	2442 MHz	18	●		●
21	2444 MHz	19	●		●
22	2446 MHz	20	●		●
23	2448 MHz	21	●		●
24	2450 MHz	22	●		●
25	2452 MHz	23	●		●
26	2454 MHz	24	●		●
27	2456 MHz	25	●		●
28	2458 MHz	26	●		●
29	2460 MHz	27	●		●
30	2462 MHz	28	●		●
31	2464 MHz	29	●		●
32	2466 MHz	30	●		●
33	2468 MHz	31	●		●
34	2470 MHz	32	●		●
35	2472 MHz	33	●		●
36	2474 MHz	34	●		●
37	2476 MHz	35	●		●
38	2478 MHz	36	●		●
39	2480 MHz	39		●	●

3.2.1 Test Mode Applicability and Tested Channel Detail

EUT CONFIGURE MODE	APPLICABLE TO				DESCRIPTION
	RE \geq 1G	RE $<$ 1G	PLC	APCM	
-	√	√	√	√	-

Where **RE \geq 1G**: Radiated Emission above 1GHz & Bandedge Measurement

RE $<$ 1G: Radiated Emission below 1GHz

PLC: Power Line Conducted Emission

APCM: Antenna Port Conducted Measurement

Note: The EUT had been pre-tested on the positioned of each 3 axis. The worst case was found when positioned on X-plane (Below 1GHz) & Z-plane (Above 1GHz).

Radiated Emission Test (Above 1GHz):

- Pre-Scan has been conducted to determine the worst-case mode from all possible combinations between available modulations, data rates and antenna ports (if EUT with antenna diversity architecture).
- Following channel(s) was (were) selected for the final test as listed below.

AVAILABLE CHANNEL	TESTED CHANNEL	MODULATION TYPE	DATA RATE (Mbps)
0 to 39	0, 19, 39	GFSK	1
1 to 38	1, 19, 38	GFSK	2

Radiated Emission Test (Below 1GHz):

- Pre-Scan has been conducted to determine the worst-case mode from all possible combinations between available modulations, data rates and antenna ports (if EUT with antenna diversity architecture).
- Following channel(s) was (were) selected for the final test as listed below.

AVAILABLE CHANNEL	TESTED CHANNEL	MODULATION TYPE	DATA RATE (Mbps)
1 to 38	19	GFSK	2

Power Line Conducted Emission Test:

- Pre-Scan has been conducted to determine the worst-case mode from all possible combinations between available modulations, data rates and antenna ports (if EUT with antenna diversity architecture).
- Following channel(s) was (were) selected for the final test as listed below.

AVAILABLE CHANNEL	TESTED CHANNEL	MODULATION TYPE	DATA RATE (Mbps)
1 to 38	19	GFSK	2

Antenna Port Conducted Measurement:

- This item includes all test value of each mode, but only includes spectrum plot of worst value of each mode.
- Pre-Scan has been conducted to determine the worst-case mode from all possible combinations between available modulations, data rates and antenna ports (if EUT with antenna diversity architecture).
- Following channel(s) was (were) selected for the final test as listed below.

AVAILABLE CHANNEL	TESTED CHANNEL	MODULATION TYPE	DATA RATE (Mbps)
0 to 39	0, 19, 39	GFSK	1
1 to 38	1, 19, 38	GFSK	2

Test Condition:

APPLICABLE TO	ENVIRONMENTAL CONDITIONS	INPUT POWER	TESTED BY
RE \geq 1G	25deg. C, 66%RH	120Vac, 60Hz (System)	Nelson Teng
RE<1G	25deg. C, 65%RH	120Vac, 60Hz (System)	Nelson Teng
PLC	25deg. C, 75%RH	120Vac, 60Hz (System)	Kevin Ko
APCM	25deg. C, 60%RH	3.7 Vdc	Anderson Chen

3.3 Duty Cycle of Test Signal

Duty cycle of test signal is < 98 %, duty factor shall be considered.

BT-LE 1M: Duty cycle = 0.383 ms/0.627 ms = 0.611, Duty factor = $10 \cdot \log(1/\text{Duty cycle}) = 2.14 \text{ dB}$

BT-LE 2M: Duty cycle = 1.067 ms/1.876 ms = 0.569, Duty factor = $10 \cdot \log(1/\text{Duty cycle}) = 2.45 \text{ dB}$

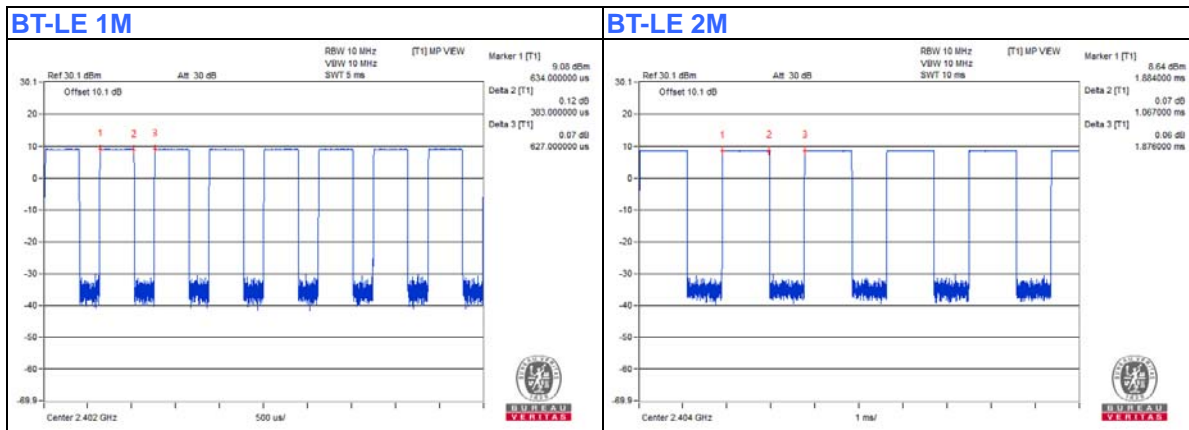

3.4 Description of Support Units

The EUT has been tested as an independent unit together with other necessary accessories or support units. The following support units or accessories were used to form a representative test configuration during the tests.

ID	Product	Brand	Model No.	Serial No.	FCC ID	Remarks
A.	USB Adapter	ASUS	EXA1205UA	NA	NA	Provided by Lab

ID	Descriptions	Qty.	Length (m)	Shielding (Yes/No)	Cores (Qty.)	Remarks
1.	USB to type C Cable	1	0.6	No	0	Supplied by client
2.	Console Cable	1	0.03	No	0	Supplied by client (For RF Setup)
3.	Console Cable	1	0.03	No	0	Supplied by client (For RF Setup)

3.4.1 Configuration of System under Test

For Radiated Emission test:

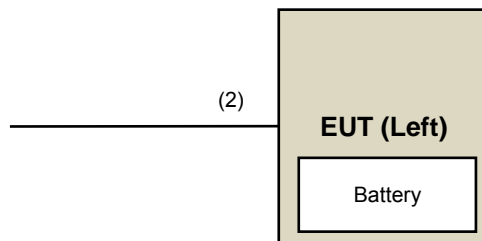

For AC Power Conducted Emission test

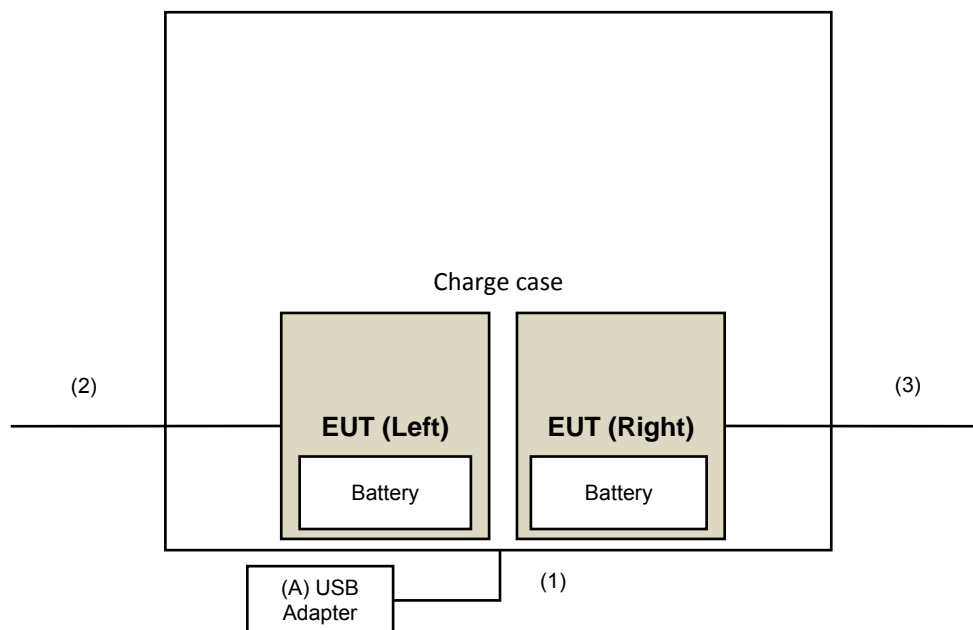

3.5 General Description of Applied Standards and References

The EUT is a RF Product. According to the specifications of the manufacturer, it must comply with the requirements of the following standards and references:

Test Standard:

FCC Part 15, Subpart C (15.247)

ANSI C63.10-2013

All test items have been performed and recorded as per the above standards.

References Test Guidance:

KDB 558074 D01 15.247 Meas Guidance v05r02

All test items have been performed as a reference to the above KDB test guidance.

4 Test Types and Results

4.1 Radiated Emission and Bandedge Measurement

4.1.1 Limits of Radiated Emission and Bandedge Measurement

Radiated emissions which fall in the restricted bands must comply with the radiated emission limits specified as below table. Other emissions shall be at least 20dB below the highest level of the desired power:

Frequencies (MHz)	Field Strength (microvolts/meter)	Measurement Distance (meters)
0.009 ~ 0.490	2400/F(kHz)	300
0.490 ~ 1.705	24000/F(kHz)	30
1.705 ~ 30.0	30	30
30 ~ 88	100	3
88 ~ 216	150	3
216 ~ 960	200	3
Above 960	500	3

Note:

1. The lower limit shall apply at the transition frequencies.
2. Emission level (dBuV/m) = 20 log Emission level (uV/m).
3. For frequencies above 1000MHz, the field strength limits are based on average detector, however, the peak field strength of any emission shall not exceed the maximum permitted average limits, specified above by more than 20dB under any condition of modulation.

4.1.2 Test Instruments

For Radiated Emission test:

DESCRIPTION & MANUFACTURER	MODEL NO.	SERIAL NO.	CALIBRATED DATE	CALIBRATED UNTIL
Test Receiver R&S	ESR7	102026	Apr. 22, 2020	Apr. 21, 2021
Spectrum Analyzer Keysight	N9030B	MY57141948	May 22, 2020	May 21, 2021
Pre-Amplifier EMCI	EMC001340	980142	May 25, 2020	May 24, 2021
Loop Antenna Electro-Metrics	EM-6879	264	Feb. 18, 2020	Feb. 17, 2021
RF Cable	NA	LOOPCAB-001	Jan. 08, 2020	Jan. 07, 2021
RF Cable	NA	LOOPCAB-002	Jan. 08, 2020	Jan. 07, 2021
Pre-Amplifier EMCI	EMC330N	980538	Apr. 28, 2020	Apr. 27, 2021
Trilog Broadband Antenna SCHWARZBECK	VULB9168	9168-0842	Nov. 08, 2019	Nov. 07, 2020
RF Cable	8D	966-5-1	Apr. 29, 2020	Apr. 28, 2021
RF Cable	8D	966-5-2	Apr. 29, 2020	Apr. 28, 2021
RF Cable	8D	966-5-3	Apr. 29, 2020	Apr. 28, 2021
Fixed attenuator Mini-Circuits	UNAT-5+	PAD-ATT5-02	Jan. 14, 2020	Jan. 13, 2021
Horn_Antenna SCHWARZBECK	BBHA 9120D	9120D-1819	Nov. 24, 2019	Nov. 23, 2020
Pre-Amplifier EMCI	EMC12630SE	980509	Apr. 29, 2020	Apr. 28, 2021
RF Cable EMCI	EMC104-SM-SM-1500	180503	Apr. 29, 2020	Apr. 28, 2021
RF Cable EMCI	EMC104-SM-SM-2000	180501	Apr. 29, 2020	Apr. 28, 2021
RF Cable EMCI	EMC104-SM-SM-6000	180506	Apr. 29, 2020	Apr. 28, 2021
Pre-Amplifier EMCI	EMC184045SE	980387	Jan. 15, 2020	Jan. 14, 2021
Horn_Antenna SCHWARZBECK	BBHA 9170	BBHA9170519	Nov. 24, 2019	Nov. 23, 2020
RF Cable	EMC102-KM-KM-1200	160924	Jan. 15, 2020	Jan. 14, 2021
RF Cable	EMC-KM-KM-4000	200214	Mar. 11, 2020	Mar. 10, 2021
Software	ADT_Radiated_V8.7.08	NA	NA	NA
Boresight Antenna Tower & Turn Table Max-Full	MF-7802BS	MF780208530	NA	NA

Note:

1. The calibration interval of the above test instruments is 12 months and the calibrations are traceable to NML/ROC and NIST/USA.
2. The test was performed in 966 Chamber No. 5.
3. Tested Date: July 20 to Aug. 03, 2020

For other test items:

DESCRIPTION & MANUFACTURER	MODEL NO.	SERIAL NO.	CALIBRATED DATE	CALIBRATED UNTIL
Spectrum Analyzer R&S	FSV40	100964	May 29, 2020	May 28, 2021
Power meter Anritsu	ML2495A	1529002	July 22, 2020	July 21, 2021
Power sensor Anritsu	MA2411B	1339443	July 22, 2020	July 21, 2021
Fixed Attenuator Mini-Circuits	MDCS18N-10	MDCS18N-10-01	Apr. 14, 2020	Apr. 13, 2021
Software	ADT_RF Test Software V6.6.5.4	NA	NA	NA

- NOTE:**
1. The test was performed in Oven room 2.
 2. The calibration interval of the above test instruments is 12 months and the calibrations are traceable to NML/ROC and NIST/USA.
 3. Tested Date: July 22, 2020

4.1.3 Test Procedures

For Radiated emission below 30MHz

- a. The EUT was placed on the top of a rotating table 0.8 meters above the ground at a 3 meter chamber room. The table was rotated 360 degrees to determine the position of the highest radiation.
- b. The EUT was set 3 meters away from the interference-receiving antenna, which was mounted on the top of a variable-height antenna tower.
- c. Parallel, perpendicular, and ground-parallel orientations of the antenna are set to make the measurement.
- d. For each suspected emission, the EUT was arranged to its worst case and the rotatable table was turned from 0 degrees to 360 degrees to find the maximum reading.
- e. The test-receiver system was set to Quasi-Peak Detect Function and Specified Bandwidth with Maximum Hold Mode.

Note:

1. The resolution bandwidth and video bandwidth of test receiver/spectrum analyzer is 9kHz at frequency below 30MHz.

For Radiated emission above 30MHz

- a. The EUT was placed on the top of a rotating table 0.8 meters (for 30MHz ~ 1GHz) / 1.5 meters (for above 1GHz) above the ground at 3 meter chamber room for test. The table was rotated 360 degrees to determine the position of the highest radiation.
- b. The EUT was set 3 meters away from the interference-receiving antenna, which was mounted on the top of a variable-height antenna tower.
- c. The height of antenna is varied from one meter to four meters above the ground to determine the maximum value of the field strength. Both horizontal and vertical polarizations of the antenna are set to make the measurement.
- d. For each suspected emission, the EUT was arranged to its worst case and then the antenna was tuned to heights from 1 meter to 4 meters and the rotatable table was turned from 0 degrees to 360 degrees to find the maximum reading.
- e. The test-receiver system was set to quasi-peak detect function and specified bandwidth with maximum hold mode when the test frequency is below 1 GHz.
- f. The test-receiver system was set to peak and average detects function and specified bandwidth with maximum hold mode when the test frequency is above 1 GHz. If the peak reading value also meets average limit, measurement with the average detector is unnecessary.

Note:

1. The resolution bandwidth and video bandwidth of test receiver/spectrum analyzer is 120kHz for Quasi-peak detection (QP) at frequency below 1GHz.
2. The resolution bandwidth of test receiver/spectrum analyzer is 1 MHz and the video bandwidth is 3 MHz for Peak detection (PK) at frequency above 1GHz.
3. The resolution bandwidth of test receiver/spectrum analyzer is 1MHz and the video bandwidth is $\geq 1/T$ (Duty cycle < 98%) or 10Hz (Duty cycle $\geq 98\%$) for Average detection (AV) at frequency above 1GHz.
4. All modes of operation were investigated and the worst-case emissions are reported.

4.1.4 Deviation from Test Standard

No deviation.

4.1.5 Test Setup

For Radiated emission below 30MHz

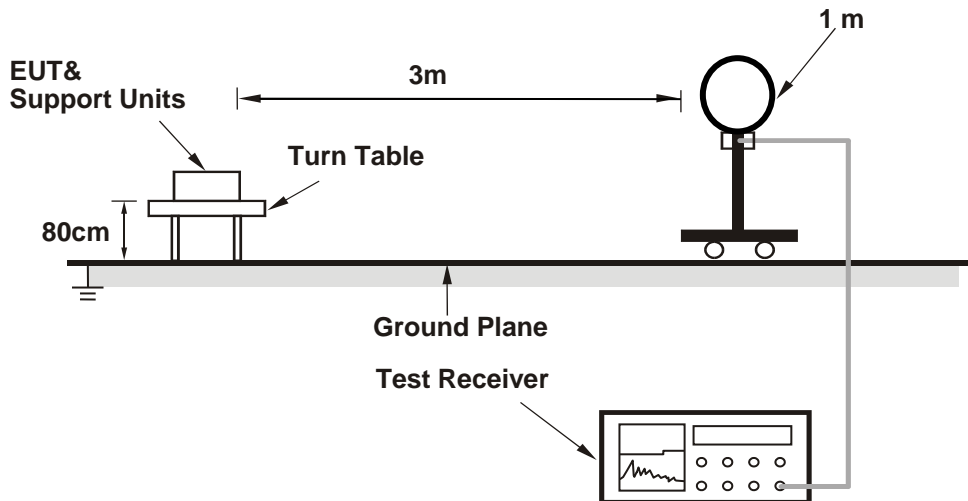

For Radiated emission 30MHz to 1GHz

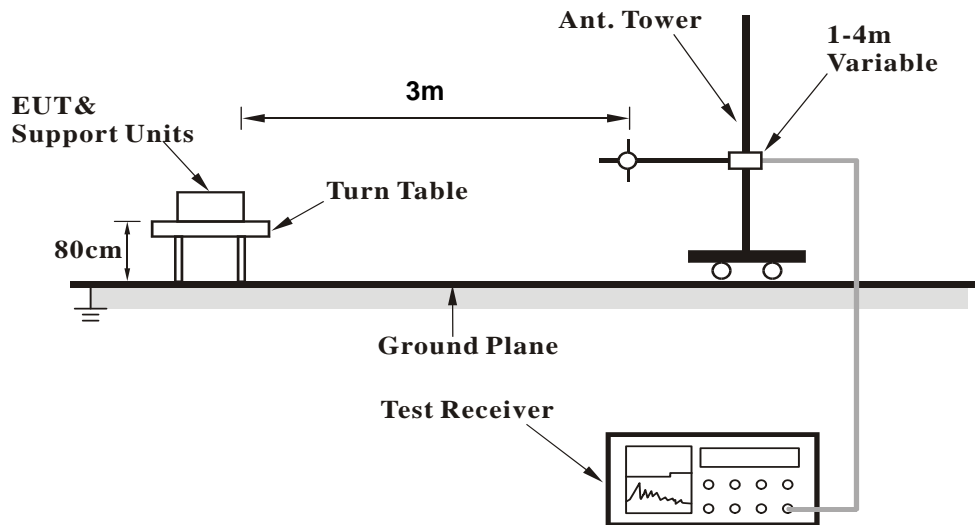

For Radiated emission above 1GHz

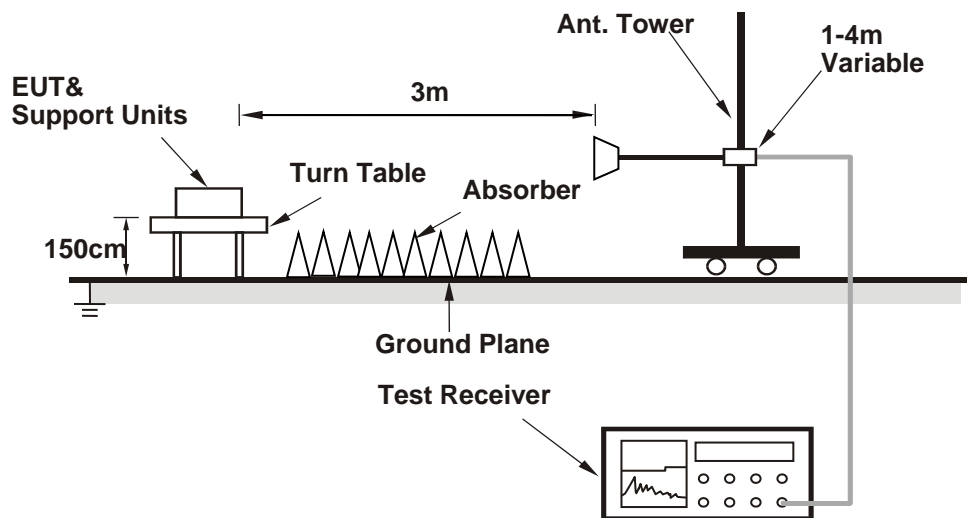

For the actual test configuration, please refer to the attached file (Test Setup Photo).

4.1.6 EUT Operating Conditions

- a. Placed the EUT on the testing table.
- b. Controlling software (BlueTest3_3_2_2_144) has been activated to set the EUT under transmission condition continuously at specific channel frequency.

4.1.7 Test Results

Above 1GHz Data:

BT-LE 1M

Channel	TX Channel 0	Detector Function	Peak (PK)
Frequency Range	1GHz ~ 25GHz		Average (AV)

Antenna Polarity & Test Distance : Horizontal at 3 m								
No	Frequency (MHz)	Emission Level (dBuV/m)	Limit (dBuV/m)	Margin (dB)	Antenna Height (m)	Table Angle (Degree)	Raw Value (dBuV)	Correction Factor (dB/m)
1	2390.00	55.6 PK	74.0	-18.4	1.85 H	159	58.7	-3.1
2	2390.00	43.1 AV	54.0	-10.9	1.85 H	159	46.2	-3.1
3	*2402.00	101.6 PK			1.85 H	159	104.7	-3.1
4	*2402.00	100.3 AV			1.85 H	159	103.4	-3.1
5	4804.00	51.1 PK	74.0	-22.9	1.15 H	113	50.1	1.0
6	4804.00	48.3 AV	54.0	-5.7	1.15 H	113	47.3	1.0
Antenna Polarity & Test Distance : Vertical at 3 m								
No	Frequency (MHz)	Emission Level (dBuV/m)	Limit (dBuV/m)	Margin (dB)	Antenna Height (m)	Table Angle (Degree)	Raw Value (dBuV)	Correction Factor (dB/m)
1	2390.00	55.5 PK	74.0	-18.5	1.04 V	146	58.6	-3.1
2	2390.00	42.9 AV	54.0	-11.1	1.04 V	146	46.0	-3.1
3	*2402.00	101.7 PK			1.04 V	146	104.8	-3.1
4	*2402.00	100.7 AV			1.04 V	146	103.8	-3.1
5	4804.00	48.4 PK	74.0	-25.6	3.41 V	176	47.4	1.0
6	4804.00	44.5 AV	54.0	-9.5	3.41 V	176	43.5	1.0

Remarks:

1. Emission Level(dBuV/m) = Raw Value(dBuV) + Correction Factor(dB/m)
2. Correction Factor(dB/m) = Antenna Factor(dB/m) + Cable Factor(dB) – Pre-Amplifier Factor(dB)
3. Margin value = Emission Level – Limit value
4. The other emission levels were very low against the limit.
5. " * ": Fundamental frequency.

Channel	TX Channel 19	Detector Function	Peak (PK)
Frequency Range	1GHz ~ 25GHz		Average (AV)

Antenna Polarity & Test Distance : Horizontal at 3 m

No	Frequency (MHz)	Emission Level (dBuV/m)	Limit (dBuV/m)	Margin (dB)	Antenna Height (m)	Table Angle (Degree)	Raw Value (dBuV)	Correction Factor (dB/m)
1	*2440.00	101.6 PK			1.87 H	170	104.6	-3.0
2	*2440.00	100.1 AV			1.87 H	170	103.1	-3.0
3	4880.00	51.1 PK	74.0	-22.9	1.10 H	120	50.2	0.9
4	4880.00	48.4 AV	54.0	-5.6	1.10 H	120	47.5	0.9
5	7320.00	53.8 PK	74.0	-20.2	1.84 H	76	46.8	7.0
6	7320.00	47.9 AV	54.0	-6.1	1.84 H	76	40.9	7.0

Antenna Polarity & Test Distance : Vertical at 3 m

No	Frequency (MHz)	Emission Level (dBuV/m)	Limit (dBuV/m)	Margin (dB)	Antenna Height (m)	Table Angle (Degree)	Raw Value (dBuV)	Correction Factor (dB/m)
1	*2440.00	101.3 PK			1.03 V	131	104.3	-3.0
2	*2440.00	100.4 AV			1.03 V	131	103.4	-3.0
3	4880.00	47.6 PK	74.0	-26.4	3.38 V	186	46.7	0.9
4	4880.00	44.1 AV	54.0	-9.9	3.38 V	186	43.2	0.9
5	7320.00	53.7 PK	74.0	-20.3	1.51 V	183	46.7	7.0
6	7320.00	48.7 AV	54.0	-5.3	1.51 V	183	41.7	7.0

Remarks:

1. Emission Level(dBuV/m) = Raw Value(dBuV) + Correction Factor(dB/m)
2. Correction Factor(dB/m) = Antenna Factor(dB/m) + Cable Factor(dB) – Pre-Amplifier Factor(dB)
3. Margin value = Emission Level – Limit value
4. The other emission levels were very low against the limit.
5. " * ": Fundamental frequency.

Channel	TX Channel 39	Detector Function	Peak (PK)
Frequency Range	1GHz ~ 25GHz		Average (AV)

Antenna Polarity & Test Distance : Horizontal at 3 m

No	Frequency (MHz)	Emission Level (dBuV/m)	Limit (dBuV/m)	Margin (dB)	Antenna Height (m)	Table Angle (Degree)	Raw Value (dBuV)	Correction Factor (dB/m)
1	*2480.00	102.0 PK			1.87 H	163	105.1	-3.1
2	*2480.00	101.0 AV			1.87 H	163	104.1	-3.1
3	2483.50	56.0 PK	74.0	-18.0	1.87 H	163	59.1	-3.1
4	2483.50	43.2 AV	54.0	-10.8	1.87 H	163	46.3	-3.1
5	4960.00	51.3 PK	74.0	-22.7	1.14 H	104	50.2	1.1
6	4960.00	48.3 AV	54.0	-5.7	1.14 H	104	47.2	1.1
7	7440.00	53.6 PK	74.0	-20.4	1.81 H	93	46.5	7.1
8	7440.00	47.9 AV	54.0	-6.1	1.81 H	93	40.8	7.1

Antenna Polarity & Test Distance : Vertical at 3 m

No	Frequency (MHz)	Emission Level (dBuV/m)	Limit (dBuV/m)	Margin (dB)	Antenna Height (m)	Table Angle (Degree)	Raw Value (dBuV)	Correction Factor (dB/m)
1	*2480.00	103.6 PK			1.15 V	148	106.7	-3.1
2	*2480.00	102.6 AV			1.15 V	148	105.7	-3.1
3	2483.50	55.4 PK	74.0	-18.6	1.15 V	148	58.5	-3.1
4	2483.50	43.5 AV	54.0	-10.5	1.15 V	148	46.6	-3.1
5	4960.00	47.9 PK	74.0	-26.1	3.37 V	202	46.8	1.1
6	4960.00	44.3 AV	54.0	-9.7	3.37 V	202	43.2	1.1
7	7440.00	54.0 PK	74.0	-20.0	1.46 V	174	46.9	7.1
8	7440.00	48.8 AV	54.0	-5.2	1.46 V	174	41.7	7.1

Remarks:

1. Emission Level(dBuV/m) = Raw Value(dBuV) + Correction Factor(dB/m)
2. Correction Factor(dB/m) = Antenna Factor(dB/m) + Cable Factor(dB) – Pre-Amplifier Factor(dB)
3. Margin value = Emission Level – Limit value
4. The other emission levels were very low against the limit.
5. " * ": Fundamental frequency.

BT-LE 2M

Channel	TX Channel 1	Detector Function	Peak (PK)
Frequency Range	1GHz ~ 25GHz		Average (AV)

Antenna Polarity & Test Distance : Horizontal at 3 m

No	Frequency (MHz)	Emission Level (dBuV/m)	Limit (dBuV/m)	Margin (dB)	Antenna Height (m)	Table Angle (Degree)	Raw Value (dBuV)	Correction Factor (dB/m)
1	2390.00	56.3 PK	74.0	-17.7	1.18 H	237	59.4	-3.1
2	2390.00	43.6 AV	54.0	-10.4	1.18 H	237	46.7	-3.1
3	*2404.00	102.3 PK			1.18 H	237	105.4	-3.1
4	*2404.00	99.0 AV			1.18 H	237	102.1	-3.1
5	4808.00	51.2 PK	74.0	-22.8	1.17 H	119	50.2	1.0
6	4808.00	48.4 AV	54.0	-5.6	1.17 H	119	47.4	1.0

Antenna Polarity & Test Distance : Vertical at 3 m

No	Frequency (MHz)	Emission Level (dBuV/m)	Limit (dBuV/m)	Margin (dB)	Antenna Height (m)	Table Angle (Degree)	Raw Value (dBuV)	Correction Factor (dB/m)
1	2390.00	56.2 PK	74.0	-17.8	1.14 V	239	59.3	-3.1
2	2390.00	43.7 AV	54.0	-10.3	1.14 V	239	46.8	-3.1
3	*2404.00	101.2 PK			1.14 V	239	104.3	-3.1
4	*2404.00	96.6 AV			1.14 V	239	99.7	-3.1
5	4808.00	47.3 PK	74.0	-26.7	3.36 V	171	46.3	1.0
6	4808.00	44.0 AV	54.0	-10.0	3.36 V	171	43.0	1.0

Remarks:

1. Emission Level(dBuV/m) = Raw Value(dBuV) + Correction Factor(dB/m)
2. Correction Factor(dB/m) = Antenna Factor(dB/m) + Cable Factor(dB) – Pre-Amplifier Factor(dB)
3. Margin value = Emission Level – Limit value
4. The other emission levels were very low against the limit.
5. " * ": Fundamental frequency.

Channel	TX Channel 19	Detector Function	Peak (PK)
Frequency Range	1GHz ~ 25GHz		Average (AV)

Antenna Polarity & Test Distance : Horizontal at 3 m

No	Frequency (MHz)	Emission Level (dBuV/m)	Limit (dBuV/m)	Margin (dB)	Antenna Height (m)	Table Angle (Degree)	Raw Value (dBuV)	Correction Factor (dB/m)
1	*2440.00	102.3 PK			1.81 H	151	105.3	-3.0
2	*2440.00	99.2 AV			1.81 H	151	102.2	-3.0
3	4880.00	51.4 PK	74.0	-22.6	1.14 H	111	50.5	0.9
4	4880.00	48.5 AV	54.0	-5.5	1.14 H	111	47.6	0.9
5	7320.00	53.4 PK	74.0	-20.6	1.85 H	104	46.4	7.0
6	7320.00	47.8 AV	54.0	-6.2	1.85 H	104	40.8	7.0

Antenna Polarity & Test Distance : Vertical at 3 m

No	Frequency (MHz)	Emission Level (dBuV/m)	Limit (dBuV/m)	Margin (dB)	Antenna Height (m)	Table Angle (Degree)	Raw Value (dBuV)	Correction Factor (dB/m)
1	*2440.00	101.4 PK			1.04 V	135	104.4	-3.0
2	*2440.00	98.3 AV			1.04 V	135	101.3	-3.0
3	4880.00	47.6 PK	74.0	-26.4	3.38 V	179	46.7	0.9
4	4880.00	44.2 AV	54.0	-9.8	3.38 V	179	43.3	0.9
5	7320.00	53.8 PK	74.0	-20.2	1.53 V	172	46.8	7.0
6	7320.00	48.5 AV	54.0	-5.5	1.53 V	172	41.5	7.0

Remarks:

1. Emission Level(dBuV/m) = Raw Value(dBuV) + Correction Factor(dB/m)
2. Correction Factor(dB/m) = Antenna Factor(dB/m) + Cable Factor(dB) – Pre-Amplifier Factor(dB)
3. Margin value = Emission Level – Limit value
4. The other emission levels were very low against the limit.
5. " * ": Fundamental frequency.

Channel	TX Channel 38	Detector Function	Peak (PK)
Frequency Range	1GHz ~ 25GHz		Average (AV)

Antenna Polarity & Test Distance : Horizontal at 3 m

No	Frequency (MHz)	Emission Level (dBuV/m)	Limit (dBuV/m)	Margin (dB)	Antenna Height (m)	Table Angle (Degree)	Raw Value (dBuV)	Correction Factor (dB/m)
1	*2478.00	102.5 PK			1.16 H	222	105.6	-3.1
2	*2478.00	99.5 AV			1.16 H	222	102.6	-3.1
3	2483.50	56.4 PK	74.0	-17.6	1.16 H	222	59.5	-3.1
4	2483.50	43.5 AV	54.0	-10.5	1.16 H	222	46.6	-3.1
5	4956.00	50.9 PK	74.0	-23.1	1.12 H	110	49.8	1.1
6	4956.00	48.3 AV	54.0	-5.7	1.12 H	110	47.2	1.1
7	7434.00	52.8 PK	74.0	-21.2	1.83 H	103	45.7	7.1
8	7434.00	47.4 AV	54.0	-6.6	1.83 H	103	40.3	7.1

Antenna Polarity & Test Distance : Vertical at 3 m

No	Frequency (MHz)	Emission Level (dBuV/m)	Limit (dBuV/m)	Margin (dB)	Antenna Height (m)	Table Angle (Degree)	Raw Value (dBuV)	Correction Factor (dB/m)
1	*2478.00	101.3 PK			1.19 V	227	104.4	-3.1
2	*2478.00	96.9 AV			1.19 V	227	100.0	-3.1
3	2483.50	55.8 PK	74.0	-18.2	1.19 V	227	58.9	-3.1
4	2483.50	43.6 AV	54.0	-10.4	1.19 V	227	46.7	-3.1
5	4956.00	47.9 PK	74.0	-26.1	3.43 V	183	46.8	1.1
6	4956.00	44.6 AV	54.0	-9.4	3.43 V	183	43.5	1.1
7	7434.00	53.9 PK	74.0	-20.1	1.51 V	160	46.8	7.1
8	7434.00	48.4 AV	54.0	-5.6	1.51 V	160	41.3	7.1

Remarks:

1. Emission Level(dBuV/m) = Raw Value(dBuV) + Correction Factor(dB/m)
2. Correction Factor(dB/m) = Antenna Factor(dB/m) + Cable Factor(dB) – Pre-Amplifier Factor(dB)
3. Margin value = Emission Level – Limit value
4. The other emission levels were very low against the limit.
5. " * ": Fundamental frequency.

Below 1GHz Data:

BT-LE 2M

Channel	TX Channel 19	Detector Function	Quasi-Peak (QP)
Frequency Range	9kHz ~ 1GHz		

Antenna Polarity & Test Distance : Horizontal at 3 m								
No	Frequency (MHz)	Emission Level (dBuV/m)	Limit (dBuV/m)	Margin (dB)	Antenna Height (m)	Table Angle (Degree)	Raw Value (dBuV)	Correction Factor (dB/m)
1	96.11	26.3 QP	43.5	-17.2	2.00 H	277	44.0	-17.7
2	146.49	18.0 QP	43.5	-25.5	2.00 H	62	30.5	-12.5
3	288.17	25.7 QP	46.0	-20.3	1.00 H	89	37.9	-12.2
4	447.78	22.5 QP	46.0	-23.5	3.00 H	235	30.8	-8.3
5	574.20	23.7 QP	46.0	-22.3	4.00 H	133	29.6	-5.9
6	898.49	28.4 QP	46.0	-17.6	2.00 H	342	29.4	-1.0

Remarks:

1. Emission Level(dBuV/m) = Raw Value(dBuV) + Correction Factor(dB/m)
2. Correction Factor(dB/m) = Antenna Factor(dB/m) + Cable Factor(dB) – Pre-Amplifier Factor(dB)
3. Margin value = Emission Level – Limit value
4. The other emission levels were very low against the limit of frequency range 30MHz~1000MHz.
5. The emission levels were very low against the limit of frequency range 9kHz~30MHz: the amplitude of spurious emissions attenuated more than 20 dB below the permissible value to be report.

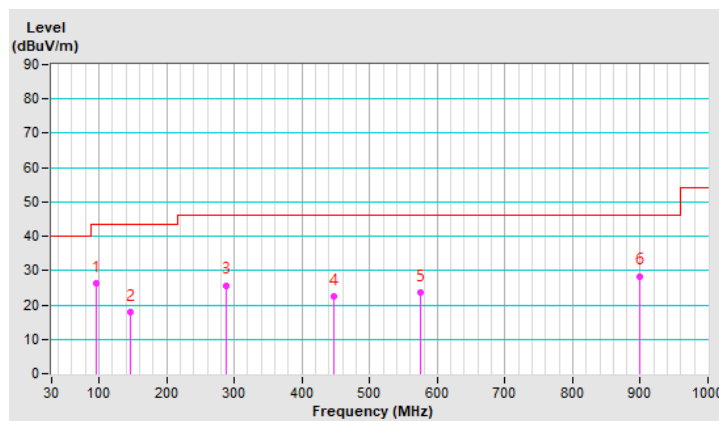

Channel	TX Channel 19	Detector Function	Quasi-Peak (QP)
Frequency Range	9kHz ~ 1GHz		

Antenna Polarity & Test Distance : Vertical at 3 m

No	Frequency (MHz)	Emission Level (dBuV/m)	Limit (dBuV/m)	Margin (dB)	Antenna Height (m)	Table Angle (Degree)	Raw Value (dBuV)	Correction Factor (dB/m)
1	42.85	26.9 QP	40.0	-13.1	1.00 V	13	39.7	-12.8
2	96.06	28.6 QP	43.5	-14.9	1.00 V	72	46.3	-17.7
3	167.01	19.0 QP	43.5	-24.5	2.00 V	341	32.0	-13.0
4	326.50	19.0 QP	46.0	-27.0	1.50 V	75	30.1	-11.1
5	568.33	23.7 QP	46.0	-22.3	4.00 V	297	29.8	-6.1
6	882.93	27.9 QP	46.0	-18.1	2.00 V	268	29.2	-1.3

Remarks:

1. Emission Level(dBuV/m) = Raw Value(dBuV) + Correction Factor(dB/m)
2. Correction Factor(dB/m) = Antenna Factor(dB/m) + Cable Factor(dB) – Pre-Amplifier Factor(dB)
3. Margin value = Emission Level – Limit value
4. The other emission levels were very low against the limit of frequency range 30MHz~1000MHz.
5. The emission levels were very low against the limit of frequency range 9kHz~30MHz: the amplitude of spurious emissions attenuated more than 20 dB below the permissible value to be report.

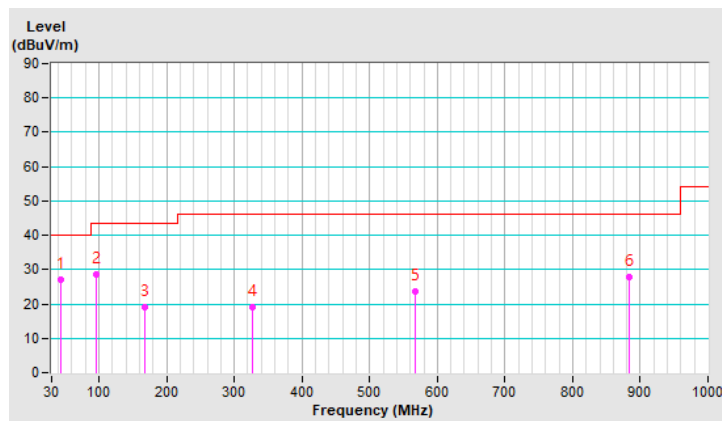

4.2 Conducted Emission Measurement

4.2.1 Limits of Conducted Emission Measurement

Frequency (MHz)	Conducted Limit (dBuV)	
	Quasi-peak	Average
0.15 - 0.5	66 - 56	56 - 46
0.50 - 5.0	56	46
5.0 - 30.0	60	50

Note: 1. The lower limit shall apply at the transition frequencies.

2. The limit decreases in line with the logarithm of the frequency in the range of 0.15 to 0.50MHz.

4.2.2 Test Instruments

DESCRIPTION & MANUFACTURER	MODEL NO.	SERIAL NO.	CALIBRATED DATE	CALIBRATED UNTIL
Test Receiver R&S	ESCS 30	847124/029	Oct. 23, 2019	Oct. 22, 2020
Line-Impedance Stabilization Network (for EUT) R&S	ESH3-Z5	848773/004	Oct. 23, 2019	Oct. 22, 2020
Line-Impedance Stabilization Network (for Peripheral) R&S	ESH3-Z5	835239/001	Mar. 19, 2020	Mar. 18, 2021
50 ohms Terminator	50	3	Oct. 23, 2019	Oct. 22, 2020
RF Cable	5D-FB	COCCAB-001	Sep. 27, 2019	Sep. 26, 2020
Fixed attenuator EMCI	STI02-2200-10	005	Aug. 30, 2019	Aug. 29, 2020
Software BVADT	BVADT_Cond_ V7.3.7.4	NA	NA	NA

Note:

1. The calibration interval of the above test instruments are 12 months and the calibrations are traceable to NML/ROC and NIST/USA.
2. The test was performed in Conduction 1.
- 3 Tested Date: Aug. 03, 2020

4.2.3 Test Procedures

- The EUT was placed 0.4 meters from the conducting wall of the shielded room with EUT being connected to the power mains through a line impedance stabilization network (LISN). Other support units were connected to the power mains through another LISN. The two LISNs provide 50 ohm/ 50uH of coupling impedance for the measuring instrument.
- Both lines of the power mains connected to the EUT were checked for maximum conducted interference.
- The frequency range from 150kHz to 30MHz was searched. Emission levels under (Limit - 20dB) was not recorded.

Note: The resolution bandwidth and video bandwidth of test receiver is 9kHz for quasi-peak detection (QP) and average detection (AV) at frequency 0.15MHz-30MHz.

4.2.4 Deviation from Test Standard

No deviation.

4.2.5 Test Setup

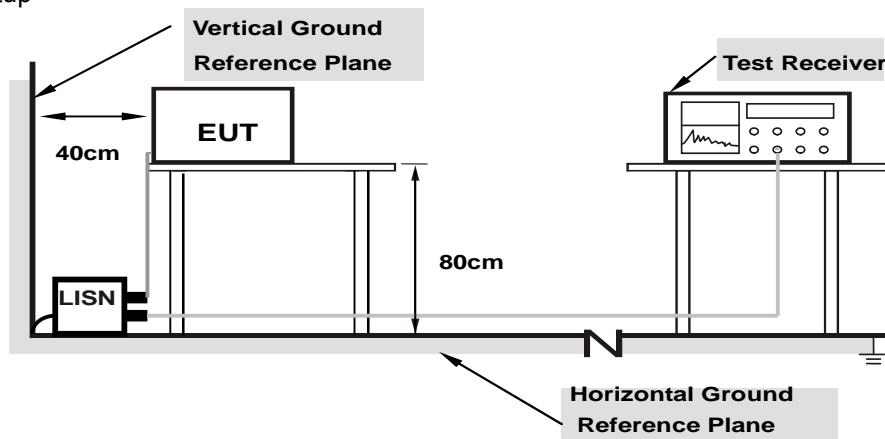

Note: 1.Support units were connected to second LISN.

For the actual test configuration, please refer to the attached file (Test Setup Photo).

4.2.6 EUT Operating Conditions

Same as 4.1.6.

4.2.7 Test Results

Phase	Line (L)	Detector Function	Quasi-Peak (QP) / Average (AV)
-------	----------	-------------------	--------------------------------

Phase Of Power : Line (L)										
No	Frequency (MHz)	Correction Factor (dB)	Reading Value (dBuV)		Emission Level (dBuV)		Limit (dBuV)		Margin (dB)	
			Q.P.	AV.	Q.P.	AV.	Q.P.	AV.	Q.P.	AV.
1	0.15391	9.98	27.27	10.34	37.25	20.32	65.79	55.79	-28.54	-35.47
2	0.16953	9.98	25.76	12.33	35.74	22.31	64.98	54.98	-29.24	-32.67
3	0.36094	10.01	22.31	10.15	32.32	20.16	58.71	48.71	-26.39	-28.55
4	3.79297	10.26	20.05	4.09	30.31	14.35	56.00	46.00	-25.69	-31.65
5	4.10938	10.28	20.17	4.59	30.45	14.87	56.00	46.00	-25.55	-31.13
6	26.55859	11.63	13.30	-0.08	24.93	11.55	60.00	50.00	-35.07	-38.45

Remarks:

1. Q.P. and AV. are abbreviations of quasi-peak and average individually.
2. The emission levels of other frequencies were very low against the limit.
3. Margin value = Emission level – Limit value
4. Correction factor = Insertion loss + Cable loss
5. Emission Level = Correction Factor + Reading Value

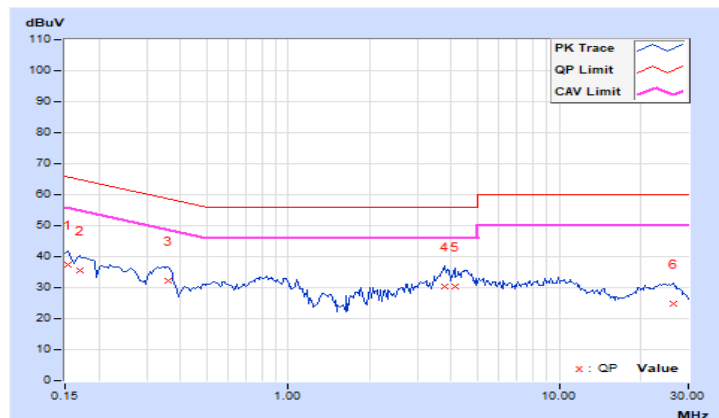

Phase	Neutral (N)	Detector Function	Quasi-Peak (QP) / Average (AV)
-------	-------------	-------------------	--------------------------------

Phase Of Power : Neutral (N)										
No	Frequency (MHz)	Correction Factor (dB)	Reading Value (dBuV)		Emission Level (dBuV)		Limit (dBuV)		Margin (dB)	
			Q.P.	AV.	Q.P.	AV.	Q.P.	AV.	Q.P.	AV.
1	0.16562	9.99	29.82	11.99	39.81	21.98	65.18	55.18	-25.37	-33.20
2	0.18516	10.00	23.79	7.91	33.79	17.91	64.25	54.25	-30.46	-36.34
3	0.81797	10.07	15.93	-0.50	26.00	9.57	56.00	46.00	-30.00	-36.43
4	0.99375	10.09	12.10	-3.18	22.19	6.91	56.00	46.00	-33.81	-39.09
5	3.77344	10.26	16.80	0.45	27.06	10.71	56.00	46.00	-28.94	-35.29
6	4.62109	10.30	17.23	1.15	27.53	11.45	56.00	46.00	-28.47	-34.55

Remarks:

1. Q.P. and AV. are abbreviations of quasi-peak and average individually.
2. The emission levels of other frequencies were very low against the limit.
3. Margin value = Emission level – Limit value
4. Correction factor = Insertion loss + Cable loss
5. Emission Level = Correction Factor + Reading Value

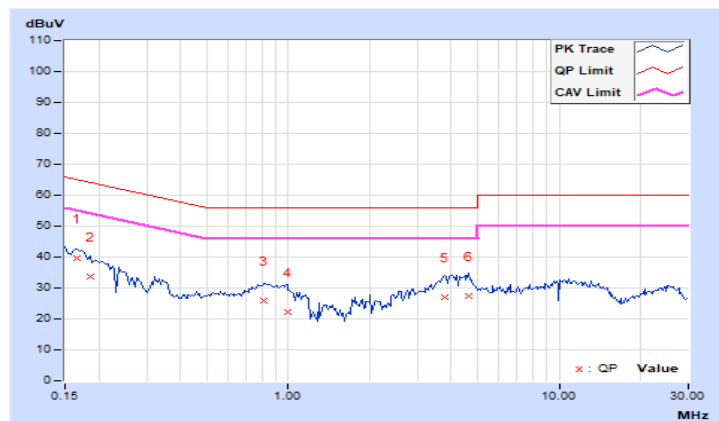

4.3 6dB Bandwidth Measurement

4.3.1 Limits of 6dB Bandwidth Measurement

The minimum of 6dB Bandwidth Measurement is 0.5 MHz.

4.3.2 Test Setup

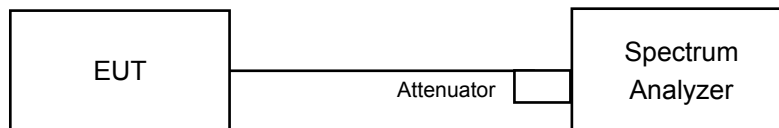

4.3.3 Test Instruments

Refer to section 4.1.2 to get information of above instrument.

4.3.4 Test Procedure

- a. Set resolution bandwidth (RBW) = 100kHz
- b. Set the video bandwidth (VBW) $\geq 3 \times$ RBW, Detector = Peak.
- c. Trace mode = max hold.
- d. Sweep = auto couple.
- e. Measure the maximum width of the emission that is constrained by the frequencies associated with the two amplitude points (upper and lower) that are attenuated by 6 dB relative to the maximum level measured in the fundamental emission

4.3.5 Deviation from Test Standard

No deviation.

4.3.6 EUT Operating Conditions

The software provided by client to enable the EUT under transmission condition continuously at lowest, middle and highest channel frequencies individually.

4.3.7 Test Results

BT-LE 1M

Channel	Frequency (MHz)	6dB Bandwidth (MHz)	Minimum Limit (MHz)	Pass / Fail
0	2402	0.72	0.5	Pass
19	2440	0.71	0.5	Pass
39	2480	0.72	0.5	Pass

BT-LE 2M

Channel	Frequency (MHz)	6dB Bandwidth (MHz)	Minimum Limit (MHz)	Pass / Fail
1	2404	1.28	0.5	Pass
19	2440	1.28	0.5	Pass
38	2478	1.28	0.5	Pass

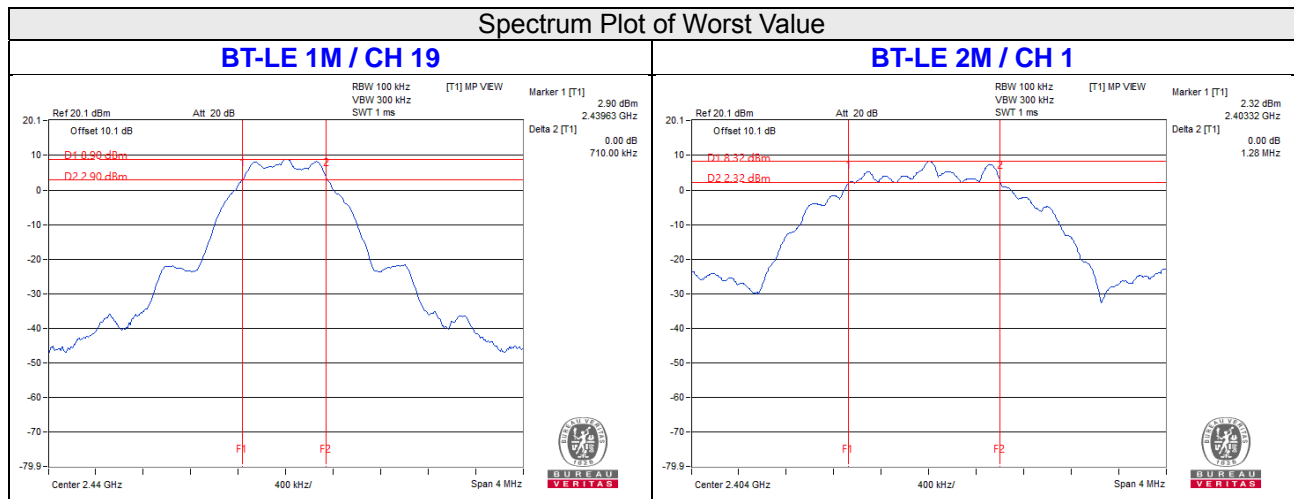

4.4 Conducted Output Power Measurement

4.4.1 Limits of Conducted Output Power Measurement

For systems using digital modulation in the 2400–2483.5 MHz bands: 1 Watt (30dBm)

4.4.2 Test Setup

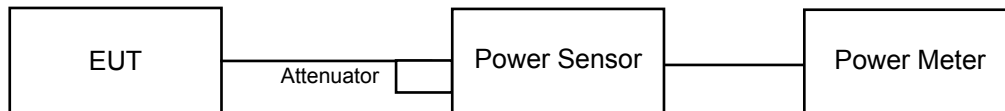

4.4.3 Test Instruments

Refer to section 4.1.2 to get information of above instrument.

4.4.4 Test Procedures

A peak power sensor was used on the output port of the EUT. A power meter was used to read the response of the peak power sensor. Record the power level.

Average power sensor was used to perform output power measurement, trigger and gating function of wide band power meter is enabled to measure max output power of TX on burst. Duty factor is not added to measured value.

4.4.5 Deviation from Test Standard

No deviation.

4.4.6 EUT Operating Conditions

Same as Item 4.3.6.

4.4.7 Test Results

FOR PEAK POWER

BT-LE 1M

Channel	Frequency (MHz)	Peak Power (mW)	Peak Power (dBm)	Limit (dBm)	Pass/Fail
0	2402	8.147	9.11	30	Pass
19	2440	8.453	9.27	30	Pass
39	2480	8.414	9.25	30	Pass

BT-LE 2M

Channel	Frequency (MHz)	Peak Power (mW)	Peak Power (dBm)	Limit (dBm)	Pass/Fail
1	2404	8.147	9.11	30	Pass
19	2440	8.414	9.25	30	Pass
38	2478	8.433	9.26	30	Pass

FOR AVERAGE POWER

BT-LE 1M

Channel	Frequency (MHz)	Average Power (mW)	Average Power (dBm)
0	2402	7.998	9.03
19	2440	8.299	9.19
39	2480	8.299	9.19

BT-LE 2M

Channel	Frequency (MHz)	Average Power (mW)	Average Power (dBm)
1	2404	8.017	9.04
19	2440	8.299	9.19
38	2478	8.318	9.20

4.5 Power Spectral Density Measurement

4.5.1 Limits of Power Spectral Density Measurement

The Maximum of Power Spectral Density Measurement is 8dBm in any 3 kHz.

4.5.2 Test Setup

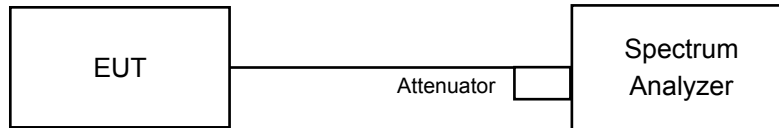

4.5.3 Test Instruments

Refer to section 4.1.2 to get information of above instrument.

4.5.4 Test Procedure

- a. Set analyzer center frequency to DTS channel center frequency.
- b. Set the span to 1.5 times the DTS bandwidth.
- c. Set the RBW to: $3 \text{ kHz} \leq \text{RBW} \leq 100 \text{ kHz}$.
- d. Set the VBW $\geq 3 \times \text{RBW}$.
- e. Detector = peak.
- f. Sweep time = auto couple.
- g. Trace mode = max hold.
- h. Allow trace to fully stabilize.
- i. Use the peak marker function to determine the maximum amplitude level within the RBW.

4.5.5 Deviation from Test Standard

No deviation.

4.5.6 EUT Operating Condition

Same as Item 4.3.6.

4.5.7 Test Results

BT-LE 1M

Channel	Freq. (MHz)	PSD (dBm/3kHz)	Limit (dBm/3kHz)	Pass /Fail
0	2402	-6.33	8	Pass
19	2440	-6.20	8	Pass
39	2480	-6.28	8	Pass

BT-LE 2M

Channel	Freq. (MHz)	PSD (dBm/3kHz)	Limit (dBm/3kHz)	Pass /Fail
1	2404	-8.85	8	Pass
19	2440	-8.81	8	Pass
38	2478	-8.77	8	Pass

Spectrum Plot of Worst Value

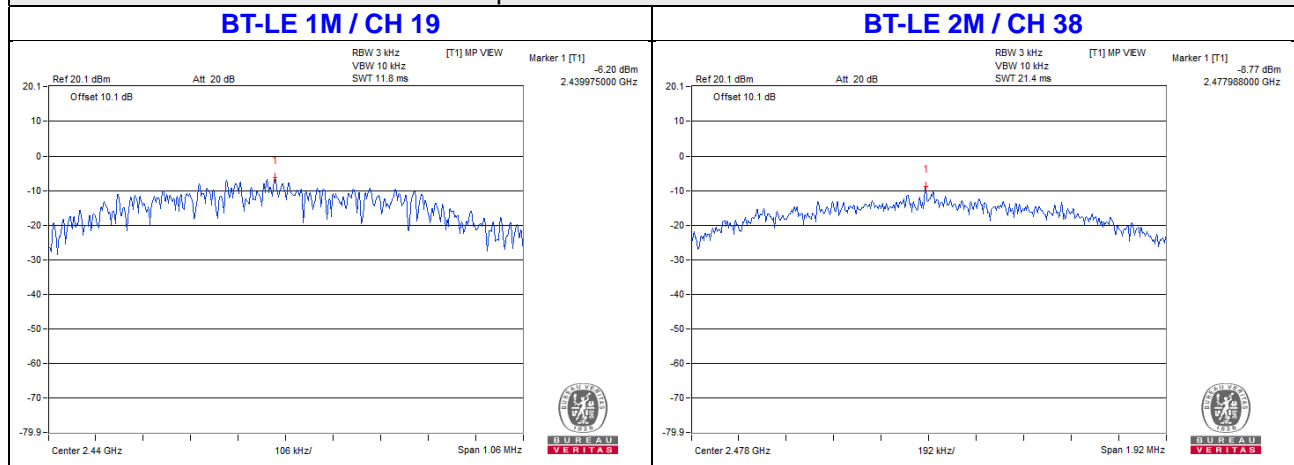

4.6 Conducted Out of Band Emission Measurement

4.6.1 Limits of Conducted Out of Band Emission Measurement

Below 20dB of the highest emission level of operating band (in 100kHz Resolution Bandwidth).

4.6.2 Test Setup

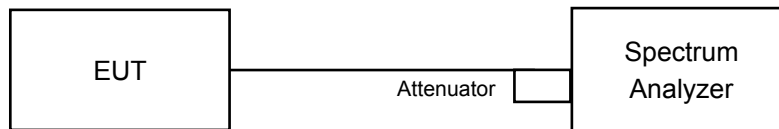

4.6.3 Test Instruments

Refer to section 4.1.2 to get information of above instrument.

4.6.4 Test Procedure

MEASUREMENT PROCEDURE REF

1. Set the RBW = 100 kHz.
2. Set the VBW \geq 300 kHz.
3. Detector = peak.
4. Sweep time = auto couple.
5. Trace mode = max hold.
6. Allow trace to fully stabilize.
7. Use the peak marker function to determine the maximum power level in any 100 kHz band segment within the fundamental EBW.

MEASUREMENT PROCEDURE OOB

1. Set RBW = 100 kHz.
2. Set VBW \geq 300 kHz.
3. Detector = peak.
4. Sweep = auto couple.
5. Trace Mode = max hold.
6. Allow trace to fully stabilize.
7. Use the peak marker function to determine the maximum amplitude level.

4.6.5 Deviation from Test Standard

No deviation.

4.6.6 EUT Operating Condition

The software provided by client enabled the EUT to transmit and receive data at lowest and highest channel frequencies individually.

4.6.7 Test Results

The spectrum plots are attached on the following pages. D1 line indicates the highest level, and D2 line indicates the 20dB offset below D1. It shows compliance with the requirement.

BT-LE 1M

CH 0

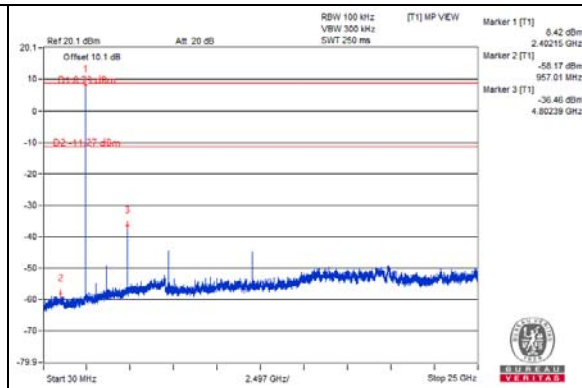
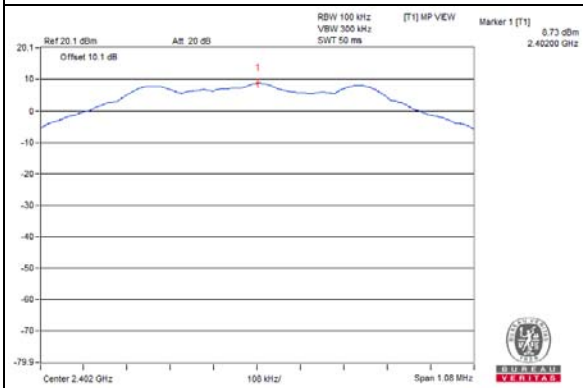

CH 19

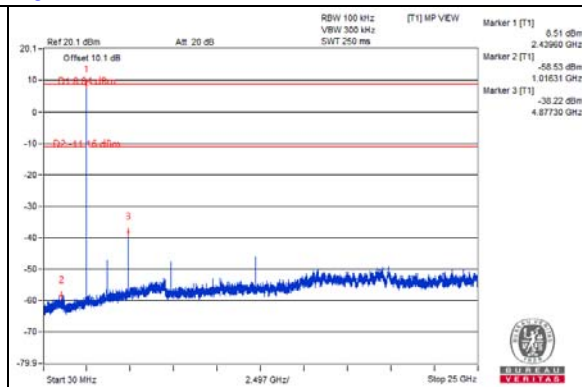
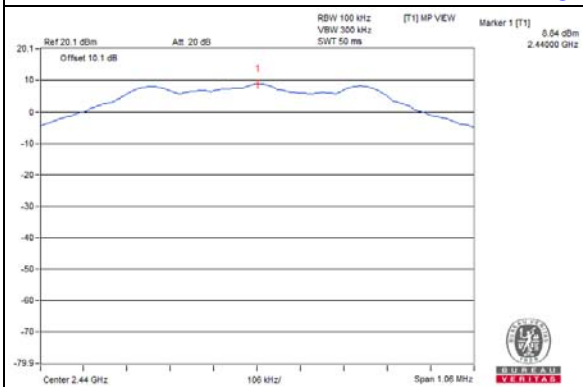

CH 39

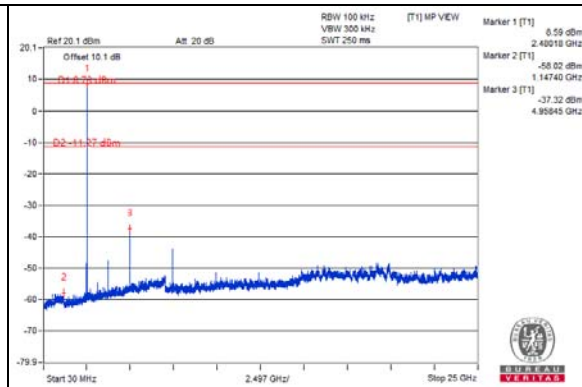
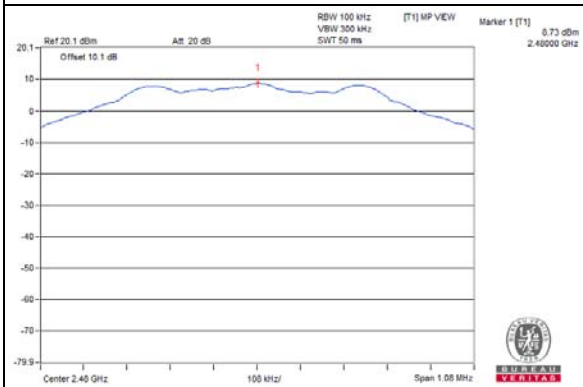

CH 0 Band edge

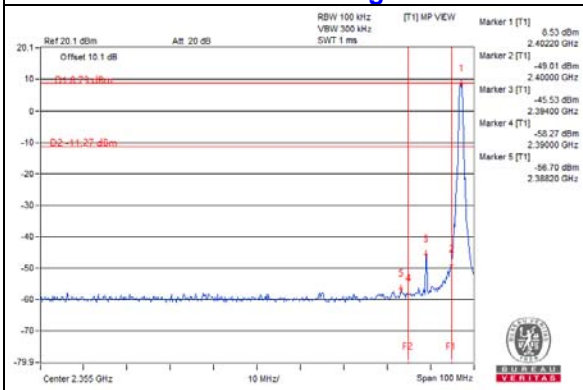

CH 39 Band edge

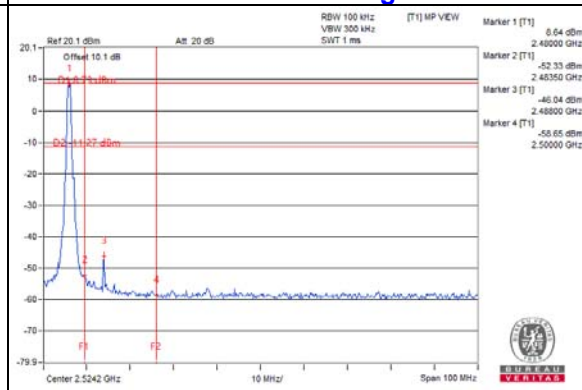

BT-LE 2M

CH 1

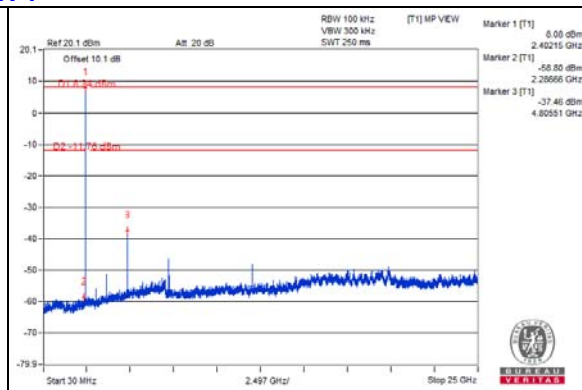
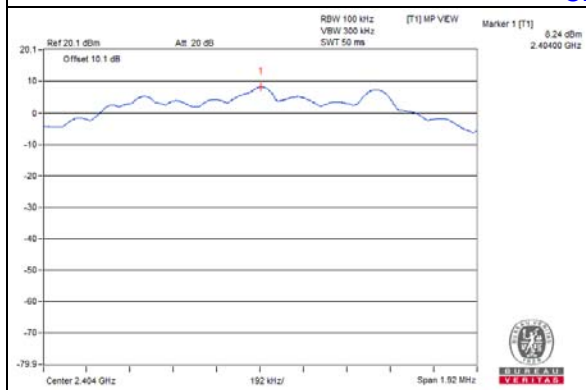

CH 19

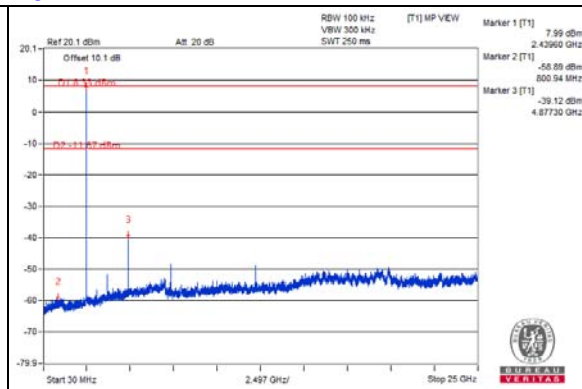
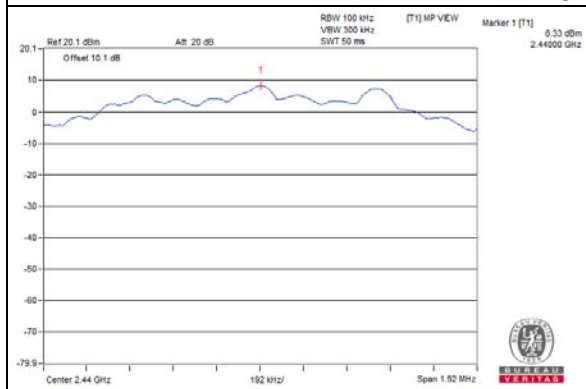

CH 38

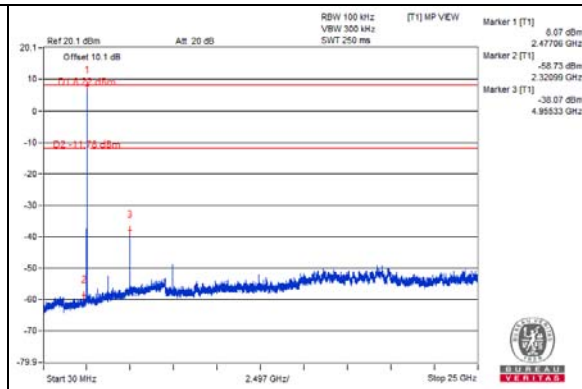
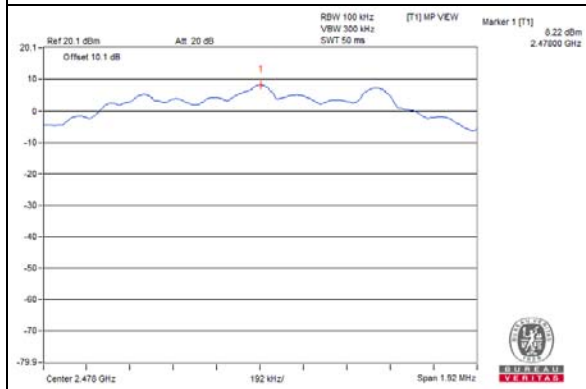

CH 1 Band edge

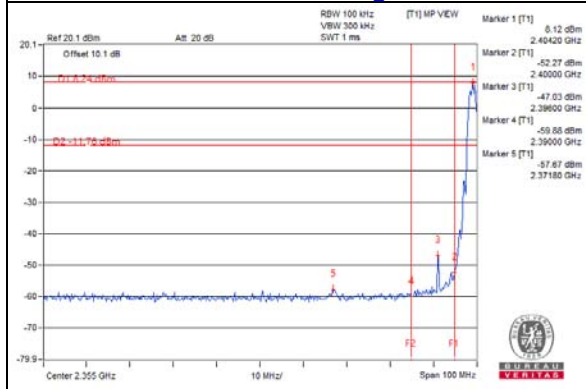

CH 38 Band edge

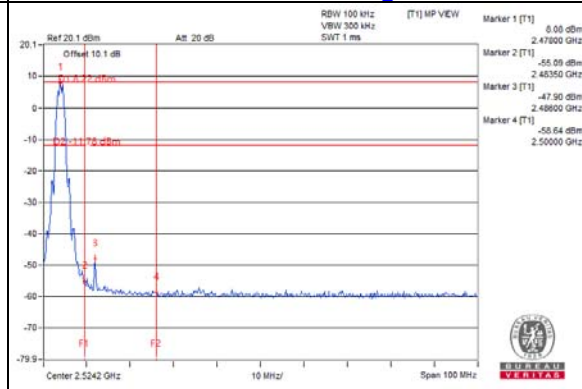

5 Pictures of Test Arrangements

Please refer to the attached file (Test Setup Photo).

Annex A - Band-Edge Measurement

BT-LE 1M

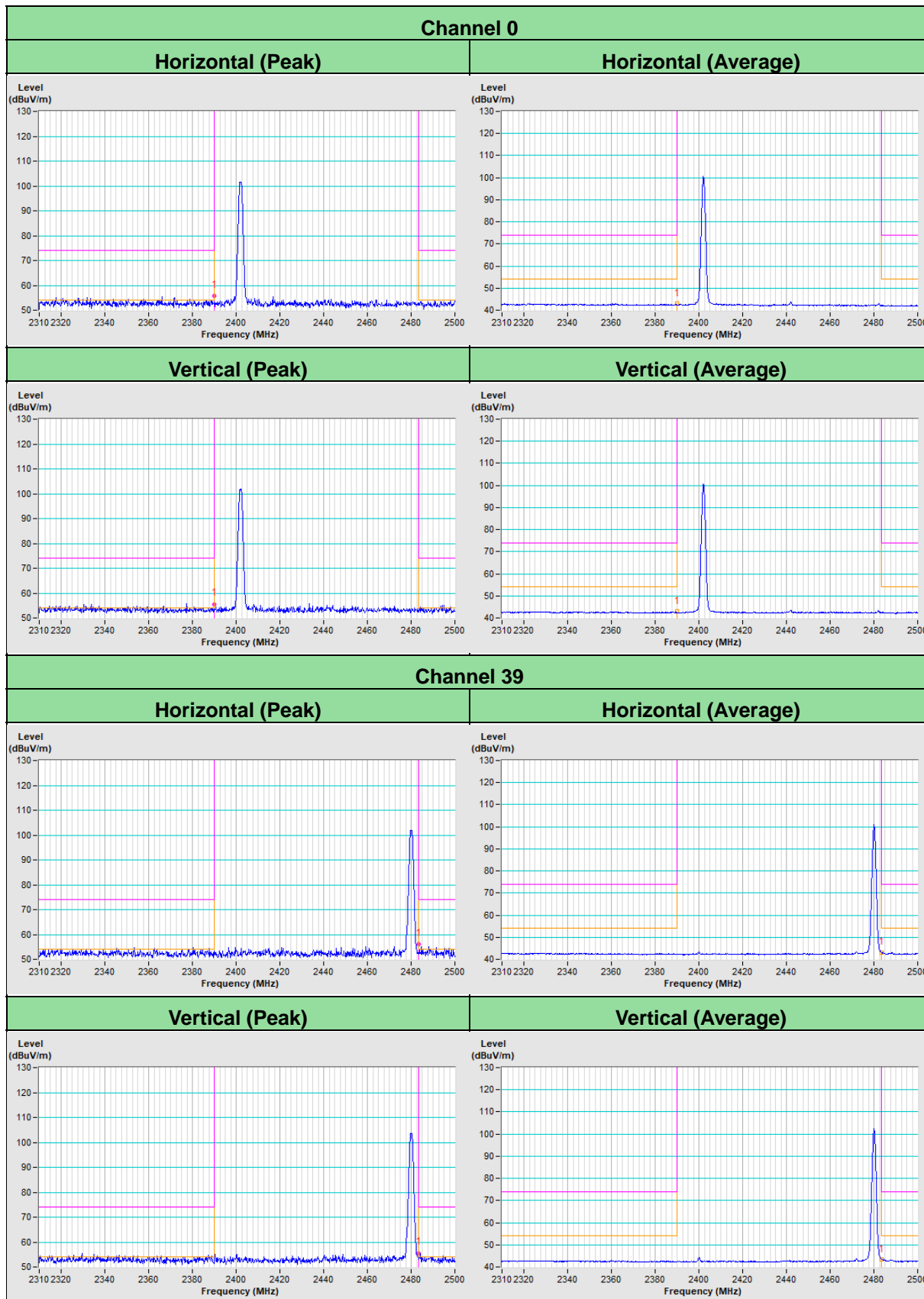

BT-LE 2M

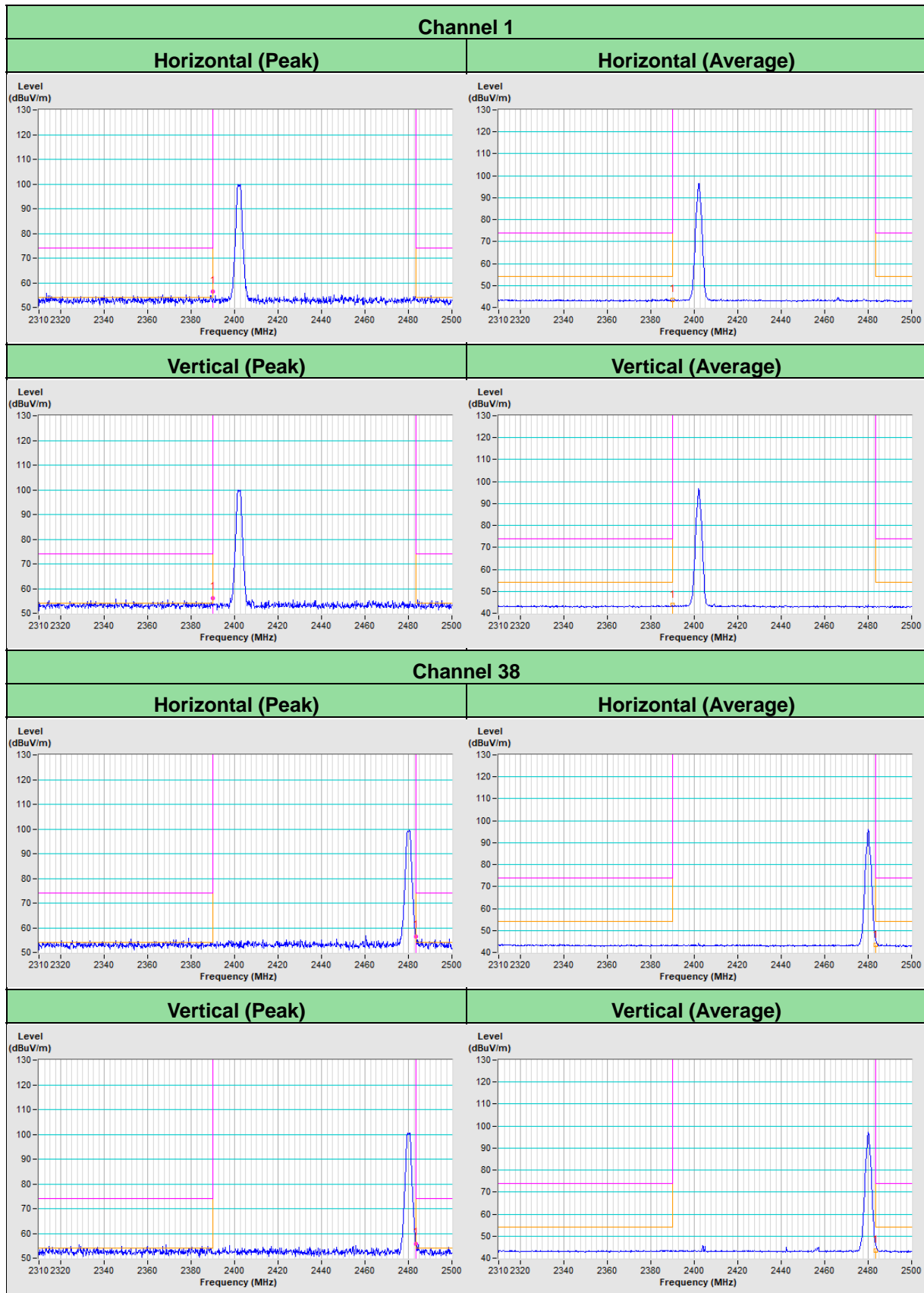

Appendix – Information of the Testing Laboratories

We, Bureau Veritas Consumer Products Services (H.K.) Ltd., Taoyuan Branch, were founded in 1988 to provide our best service in EMC, Radio, Telecom and Safety consultation. Our laboratories are FCC recognized accredited test firms and accredited according to ISO/IEC 17025.

If you have any comments, please feel free to contact us at the following:

Lin Kou EMC/RF Lab

Tel: 886-2-26052180

Fax: 886-2-26051924

Hsin Chu EMC/RF/Telecom Lab

Tel: 886-3-6668565

Fax: 886-3-6668323

Hwa Ya EMC/RF/Safety Lab

Tel: 886-3-3183232

Fax: 886-3-3270892

Email: service.adt@tw.bureauveritas.com

Web Site: www.bureauveritas-adt.com

The address and road map of all our labs can be found in our web site also.

--- END ---