

# TEST REPORT

## CERTIFICATE OF CONFORMITY

**Standard:** 47 CFR FCC Part 15, Subpart C (Section 15.247)

**Report No.:** RFBDKG-WTW-P22090959

**FCC ID:** JNZA00178

**Product:** Wireless Headset

**Brand:** logitech G

**Model No.:** A00178

**Received Date:** 2022/9/21

**Test Date:** 2022/10/4 ~ 2022/10/13

**Issued Date:** 2022/11/16

**Applicant:** Logitech Far East Ltd.

**Address:** 7700 Gateway Boulevard Newark California United States

**Issued By:** Bureau Veritas Consumer Products Services (H.K.) Ltd., Taoyuan Branch  
Hsin Chu Laboratory

**Lab Address:** E-2, No.1, Li Hsin 1st Road, Hsinchu Science Park, Hsinchu City 300, Taiwan

**Test Location:** E-2, No.1, Li Hsin 1st Road, Hsinchu Science Park, Hsinchu City 300, Taiwan

**FCC Registration /** 723255 / TW2022

**Designation Number:**

Approved by: \_\_\_\_\_

May Chen / Manager

, Date: \_\_\_\_\_

2022/11/16

This test report consists of 78 pages in total. It may be duplicated completely for legal use with the approval of the applicant. It should not be reproduced except in full, without the written approval of our laboratory. The test results in the report only apply to the tested sample. The test results in this report are traceable to the national or international standards.



Prepared by : Cherry Chuo / Specialist

This report is governed by, and incorporates by reference, the Conditions of Testing as posted at the date of issuance of this report at <http://www.bureauveritas.com/home/about-us/our-business/cps/about-us/terms-conditions/> and is intended for your exclusive use. Any copying or replication of this report to or for any other person or entity, or use of our name or trademark, is permitted only with our prior written permission. This report sets forth our findings solely with respect to the test samples identified herein. The results set forth in this report are not indicative or representative of the quality or characteristics of the lot from which a test sample was taken or any similar or identical product unless specifically and expressly noted. Our report includes all of the tests requested by you and the results thereof based upon the information that you provided to us. Measurement uncertainty is only provided upon request for accredited tests. Statements of conformity are based on simple acceptance criteria without taking measurement uncertainty into account, unless otherwise requested in writing. You have 60 days from date of issuance of this report to notify us of any material error or omission caused by our negligence or if you require measurement uncertainty; provided, however, that such notice shall be in writing and shall specifically address the issue you wish to raise. A failure to raise such issue within the prescribed time shall constitute your unqualified acceptance of the completeness of this report, the tests conducted and the correctness of the report contents.

## Table of Contents

<b>Release Control Record .....</b>	<b>4</b>
<b>1 Certificate .....</b>	<b>5</b>
<b>2 Summary of Test Results .....</b>	<b>6</b>
2.1 Measurement Uncertainty .....	6
2.2 Supplementary Information .....	6
<b>3 General Information .....</b>	<b>7</b>
3.1 General Description .....	7
3.2 Antenna Description of EUT .....	7
3.3 Channel List .....	8
3.4 Test Mode Applicability and Tested Channel Detail .....	9
3.5 Duty Cycle of Test Signal .....	10
3.6 Test Program Used and Operation Descriptions .....	11
3.7 Connection Diagram of EUT and Peripheral Devices .....	11
3.8 Configuration of Peripheral Devices and Cable Connections .....	12
<b>4 Test Instruments .....</b>	<b>13</b>
4.1 RF Output Power .....	13
4.2 Number of Hopping Frequency Used .....	13
4.3 Dwell Time on Each Channel .....	13
4.4 Hopping Channel Separation .....	13
4.5 20 dB Bandwidth .....	13
4.6 Conducted Out of Band Emissions .....	13
4.7 AC Power Conducted Emissions .....	14
4.8 Unwanted Emissions below 1 GHz .....	14
4.9 Unwanted Emissions above 1 GHz .....	15
<b>5 Limits of Test Items .....</b>	<b>16</b>
5.1 RF Output Power .....	16
5.2 Number of Hopping Frequency Used .....	16
5.3 Dwell Time on Each Channel .....	16
5.4 Hopping Channel Separation .....	16
5.5 20 dB Bandwidth .....	16
5.6 Conducted Out of Band Emissions .....	16
5.7 AC Power Conducted Emissions .....	16
5.8 Unwanted Emissions below 1 GHz .....	17
5.9 Unwanted Emissions above 1 GHz .....	17
<b>6 Test Arrangements .....</b>	<b>18</b>
6.1 RF Output Power .....	18
6.1.1 Test Setup .....	18
6.1.2 Test Procedure .....	18
6.2 Number of Hopping Frequency Used .....	18
6.2.1 Test Setup .....	18
6.2.2 Test Procedure .....	18
6.3 Dwell Time on Each Channel .....	19
6.3.1 Test Setup .....	19
6.3.2 Test Procedure .....	19
6.4 Hopping Channel Separation .....	19
6.4.1 Test Setup .....	19
6.4.2 Test Procedure .....	19
6.5 20 dB Bandwidth .....	20
6.5.1 Test Setup .....	20
6.5.2 Test Procedure .....	20
6.6 Conducted Out of Band Emissions .....	20
6.6.1 Test Setup .....	20
6.6.2 Test Procedure .....	20
6.7 AC Power Conducted Emissions .....	21



6.7.1	Test Setup.....	21
6.7.2	Test Procedure.....	21
6.8	Unwanted Emissions below 1 GHz.....	22
6.8.1	Test Setup.....	22
6.8.2	Test Procedure.....	23
6.9	Unwanted Emissions above 1 GHz.....	24
6.9.1	Test Setup.....	24
6.9.2	Test Procedure.....	24
<b>7</b>	<b>Test Results of Test Item.....</b>	<b>25</b>
7.1	RF Output Power.....	25
7.2	Number of Hopping Frequency Used.....	27
7.3	Dwell Time on Each Channel.....	29
7.4	Hopping Channel Separation.....	33
7.5	20 dB Bandwidth.....	35
7.6	Conducted Out of Band Emissions.....	37
7.7	AC Power Conducted Emissions.....	41
7.8	Unwanted Emissions below 1 GHz.....	45
7.9	Unwanted Emissions above 1 GHz.....	49
<b>8</b>	<b>Pictures of Test Arrangements.....</b>	<b>77</b>
<b>9</b>	<b>Information of the Testing Laboratories.....</b>	<b>78</b>



## Release Control Record

Issue No.	Description	Date Issued
RFBDKG-WTW-P22090959	Original release.	2022/11/16

## 1 Certificate

**Product:** Wireless Headset

**Brand:** logitech G

**Test Model:** A00178

**Sample Status:** Engineering sample

**Applicant:** Logitech Far East Ltd.

**Test Date:** 2022/10/4 ~ 2022/10/13

**Standard:** 47 CFR FCC Part 15, Subpart C (Section 15.247)

**Measurement** ANSI C63.10-2013

**procedure:** KDB 558074 D01 15.247 Meas Guidance v05r02

The above equipment has been tested by **Bureau Veritas Consumer Products Services (H.K.) Ltd., Taoyuan Branch**, and found compliance with the requirement of the above standards. The test record, data evaluation & Equipment Under Test (EUT) configurations represented herein are true and accurate accounts of the measurements of the sample's RF characteristics under the conditions specified in this report.

## 2 Summary of Test Results

47 CFR FCC Part 15, Subpart C (Section 15.247)			
Standard / Clause	Test Item	Result	Remark
15.247 (a)(1)	RF Output Power	Pass	Meet the requirement of limit.
15.247(a)(1) (iii)	Number of Hopping Frequency Used	Pass	Meet the requirement of limit.
15.247(a)(1) (iii)	Dwell Time on Each Channel	Pass	Meet the requirement of limit.
15.247(a)(1)	Hopping Channel Separation	Pass	Meet the requirement of limit.
15.247(a)(1)	20 dB Bandwidth	-	Refer to Note 1
15.247(d)	Conducted Out of Band Emissions	Pass	Meet the requirement of limit.
15.207	AC Power Conducted Emissions	Pass	Minimum passing margin is -12.62 dB at 0.16953 MHz
15.205 / 15.209 / 15.247(d)	Unwanted Emissions below 1 GHz	Pass	Minimum passing margin is -6.7 dB at 42.63 MHz
15.205 / 15.209 / 15.247(d)	Unwanted Emissions above 1 GHz	Pass	Minimum passing margin is -7.6 dB at 2483.50 MHz
15.203	Antenna Requirement	Pass	No antenna connector is used.

### Notes:

1. If the Frequency Hopping System operating in 2400-2483.5 MHz band and the output power less than 125 mW. The hopping channel carrier frequencies separated by a minimum of 25 kHz or two-thirds of the 20 dB bandwidth of hopping channel whichever is greater.
2. Determining compliance based on the results of the compliance measurement, not taking into account measurement instrumentation uncertainty.

### 2.1 Measurement Uncertainty

Where relevant, the following measurement uncertainty levels have been estimated for tests performed on the EUT as specified in CISPR 16-4-2:

Measurement	Specification	Expanded Uncertainty (k=2) (±)
Conducted Out of Band Emissions	9 kHz ~ 40 GHz	2.5 dB
AC Power Conducted Emissions	150 kHz ~ 30 MHz	1.9 dB
Unwanted Emissions below 1 GHz	9 kHz ~ 30 MHz	3.1 dB
	30 MHz ~ 1 GHz	5.1 dB
Unwanted Emissions above 1 GHz	1 GHz ~ 18 GHz	5.0 dB
	18 GHz ~ 40 GHz	5.3 dB

The other instruments specified are routine verified to remain within the calibrated levels, no measurement uncertainty is required to be calculated.

### 2.2 Supplementary Information

There is not any deviation from the test standards for the test method, and no modifications required for compliance.

### 3 General Information

#### 3.1 General Description

Product	Wireless Headset
Brand	logitech G
Test Model	A00178
Status of EUT	Engineering sample
Power Supply Rating	3.7 Vdc from battery or 5 Vdc from USB interface
Modulation Type	<b>BT-EDR:</b> GFSK, $\pi/4$ -DQPSK, 8DPSK <b>LIGHTSPEED:</b> GFSK, $\pi/4$ -DQPSK
Modulation Technology	FHSS
Transfer Rate	<b>BT-EDR:</b> Up to 3 Mbps <b>LIGHTSPEED:</b> Up to 2 Mbps
Operating Frequency	2.402 GHz ~ 2.48 GHz
Number of Channel	79
Output Power	<b>BT-EDR:</b> 8.356 mW (9.22 dBm) <b>LIGHTSPEED:</b> 8.279 mW (9.18 dBm)
Accessory	USB to Type C cable x1 (Shielded, 1.8m with one core), Detachable Mic x1 (Shielded, 0.12m)

Note:

1. The EUT may have a lot of colors for marketing requirement.
2. This device has BT-EDR and LIGHTSPEED functions. LIGHTSPEED is the same technology as BT-EDR then enhancement secure protocol.
3. The EUT of LIGHTSPEED and Bluetooth technology can't transmit simultaneously, and BT-EDR and BT-LE of Bluetooth technology also can't transmit simultaneously, which uses timely shared coexistence technology.
4. The EUT must be supplied with a battery as the following table:

Brand	Model	Specification
Springpower Technology (Shenzhen)Co.,Ltd.	604050 11CP6/40/50 or 533- 000181	Power Rating : 3.7Vdc, 5.55Wh, 1500mAh

5. The above EUT information is declared by manufacturer and for more detailed features description, please refer to the manufacturer's specifications or User's Manual.

#### 3.2 Antenna Description of EUT

1. The antenna information is listed as below.

Model	Antenna Gain (dBi)	Frequency range (GHz)	Antenna Type	Connector Type
A00178	2.5	2.4~2.4835	Loop Antenna	Welding

\* Detail antenna specification please refer to antenna datasheet and/or antenna measurement report.

### 3.3 Channel List

79 channels are provided for BT-EDR & LIGHTSPEED:

Channel	Frequency (MHz)	Channel	Frequency (MHz)	Channel	Frequency (MHz)	Channel	Frequency (MHz)
0	2402	20	2422	40	2442	60	2462
1	2403	21	2423	41	2443	61	2463
2	2404	22	2424	42	2444	62	2464
3	2405	23	2425	43	2445	63	2465
4	2406	24	2426	44	2446	64	2466
5	2407	25	2427	45	2447	65	2467
6	2408	26	2428	46	2448	66	2468
7	2409	27	2429	47	2449	67	2469
8	2410	28	2430	48	2450	68	2470
9	2411	29	2431	49	2451	69	2471
10	2412	30	2432	50	2452	70	2472
11	2413	31	2433	51	2453	71	2473
12	2414	32	2434	52	2454	72	2474
13	2415	33	2435	53	2455	73	2475
14	2416	34	2436	54	2456	74	2476
15	2417	35	2437	55	2457	75	2477
16	2418	36	2438	56	2458	76	2478
17	2419	37	2439	57	2459	77	2479
18	2420	38	2440	58	2460	78	2480
19	2421	39	2441	59	2461		



### 3.4 Test Mode Applicability and Tested Channel Detail

Pre-Scan:	<p>1. For Unwanted Emission items: Battery/ AC Adapter. Pre-scan these modes and find the worst case as a representative test condition.</p> <p>2. For AC Power conducted Emission items: AC Adapter/ Laptop. Pre-scan these modes and find the worst case as a representative test condition.</p> <p>3. EUT can be used in the following ways: X-axis/ Y-axis/ Z-axis. Pre-scan these ways and find the worst case as a representative test condition.</p>
Worst Case:	<p>1. X-axis/ Y-axis/ Z-axis Worst Condition: X-axis</p> <p>2. For Unwanted Emission items Worst condition: AC Adapter</p> <p>3. For AC Power conducted Emission Worst condition: Laptop</p> <p>4. Pre-Scan has been conducted to determine the worst-case mode from all possible combinations between available modulations, data rates and antenna ports (if EUT with antenna diversity architecture).</p>

Following channel(s) was (were) selected for the final test as listed below:

Test Item	Signal Mode	Tested Channel	Modulation	Data Rate Parameter
RF Output Power	BT-EDR	0, 39, 78	GFSK	DH5
			8DPSK	3DH5
	LIGHTSPEED		GFSK	DH5
			$\pi/4$ -DQPSK	2DH5
Number of Hopping Frequency Used	BT-EDR	Hopping	GFSK	DH5
			8DPSK	3DH5
	LIGHTSPEED		GFSK	DH5
			$\pi/4$ -DQPSK	2DH5
Dwell Time on Each Channel	BT-EDR	Hopping	GFSK	DH1/DH3/DH5
			8DPSK	3DH1/3DH3/3DH5
	LIGHTSPEED		GFSK	DH1/DH3/DH5
			$\pi/4$ -DQPSK	2DH1/2DH3/2DH5
Hopping Channel Separation / 20 dB Bandwidth	BT-EDR	0, 39, 78	GFSK	DH5
			8DPSK	3DH5
	LIGHTSPEED		GFSK	DH5
			$\pi/4$ -DQPSK	2DH5
Conducted Out of Band Emissions	BT-EDR	Hopping 0, 78	GFSK	DH5
			8DPSK	3DH5
	LIGHTSPEED		GFSK	DH5
			$\pi/4$ -DQPSK	2DH5
AC Power Conducted Emissions	BT-EDR	0	GFSK	DH5
	LIGHTSPEED	0	GFSK	DH5
Unwanted Emissions below 1 GHz	BT-EDR	0	GFSK	DH5
	LIGHTSPEED	0	GFSK	DH5
Unwanted Emissions above 1 GHz	BT-EDR	0, 39, 78	GFSK	DH5
			8DPSK	3DH5
	LIGHTSPEED		GFSK	DH5
			$\pi/4$ -DQPSK	2DH5

### 3.5 Duty Cycle of Test Signal

**GFSK:** Duty cycle = 3.4 ms / 100 ms x 100% = 3.4%

**8DPSK:** Duty cycle = 3.1 ms / 100 ms x 100% = 3.1%

**GFSK LightSpeed:** Duty cycle = 3.1 ms / 100 ms x 100% = 3.1%

**$\pi/4$ -DQPSK LightSpeed:** Duty cycle = 3.2 ms / 100 ms x 100% = 3.2%

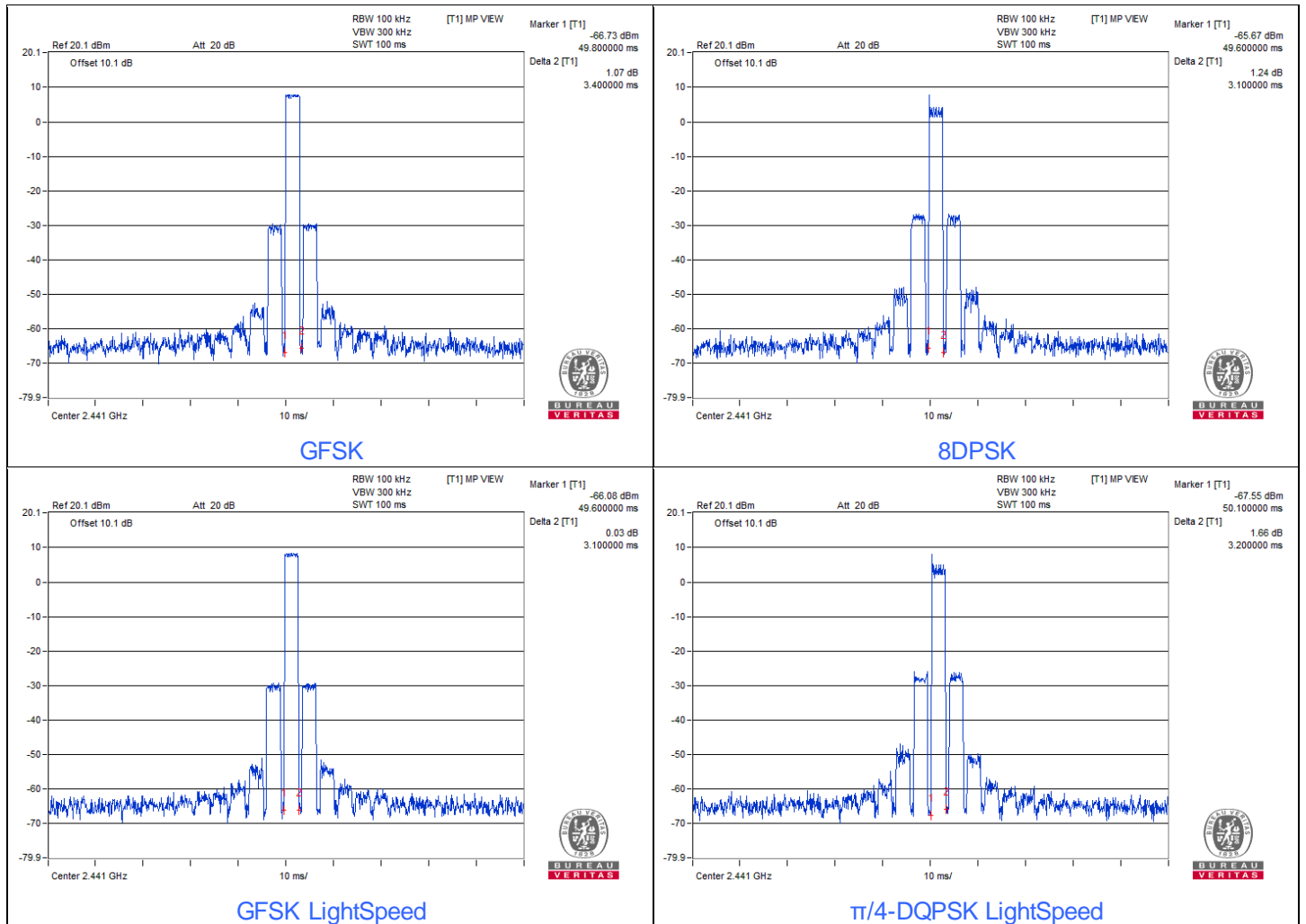

### 3.6 Test Program Used and Operation Descriptions

Controlling software (Airoha.Tool.(AB1565/68 Lab Test tool-2.11.4.707)) has been activated to set the EUT under transmission condition continuously at specific channel frequency.

### 3.7 Connection Diagram of EUT and Peripheral Devices

#### For AC Power Conducted Emission test

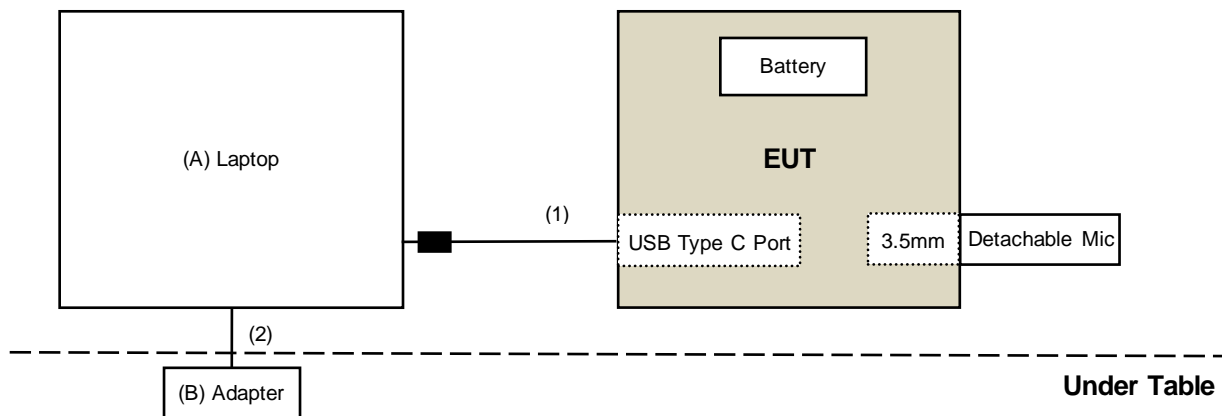

#### For Unwanted Emission test

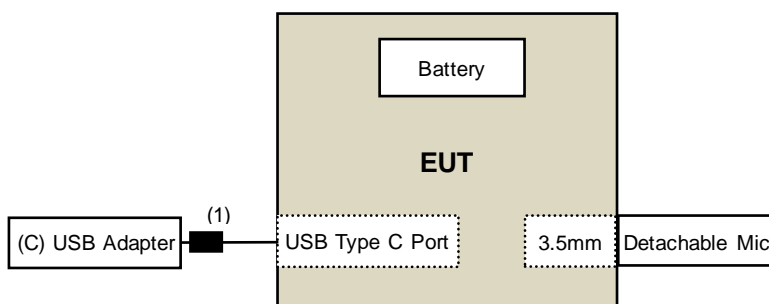

### 3.8 Configuration of Peripheral Devices and Cable Connections

ID	Product	Brand	Model No.	Serial No.	FCC ID	Remarks
A	Laptop	Lenovo	81A4	YD02YN2A	PD93165NGU	Provided by Lab
B	Adapter	Lenovo	PA-1450-55LL	N/A	N/A	Provided by Lab
C	USB Adapter	ASUS	EXA1205UA	N/A	N/A	Provided by Lab

ID	Cable Descriptions	Qty.	Length (m)	Shielding (Yes/No)	Cores (Qty.)	Remarks
1	USB to Type C cable	1	1.8	Yes	1	Supplied by applicant
2	DC Cable	1	2	No	0	Provided by Lab

## 4 Test Instruments

The calibration interval of the all test instruments are 12 months and the calibrations are traceable to NML/ROC and NIST/USA.

### 4.1 RF Output Power

Description Manufacturer	Model No.	Serial No.	Calibrated Date	Calibrated Until
Attenuator WOKEN	MDCS18N-10	MDCS18N-10-01	2022/4/5	2023/4/4
Power Meter Anritsu	ML2495A	1529002	2022/6/22	2023/6/21
Pulse Power Sensor Anritsu	MA2411B	1726434	2022/6/22	2023/6/21
Software	ADT_RF Test Software V6.6.5.4	N/A	N/A	N/A

Notes:

1. The test was performed in Oven room 2.
2. Tested Date: 2022/10/13

### 4.2 Number of Hopping Frequency Used

Description Manufacturer	Model No.	Serial No.	Calibrated Date	Calibrated Until
Attenuator WOKEN	MDCS18N-10	MDCS18N-10-01	2022/4/5	2023/4/4
Software	ADT_RF Test Software V6.6.5.4	N/A	N/A	N/A
Spectrum Analyzer R&S	FSV40	101516	2022/3/7	2023/3/6

Notes:

1. The test was performed in Oven room 2.
2. Tested Date: 2022/10/13

### 4.3 Dwell Time on Each Channel

Refer to section 4.2 to get information of the instruments.

### 4.4 Hopping Channel Separation

Refer to section 4.2 to get information of the instruments.

### 4.5 20 dB Bandwidth

Refer to section 4.2 to get information of the instruments.

### 4.6 Conducted Out of Band Emissions

Refer to section 4.2 to get information of the instruments.

#### 4.7 AC Power Conducted Emissions

Description Manufacturer	Model No.	Serial No.	Calibrated Date	Calibrated Until
50 ohms Terminator	50	3	2021/10/27	2022/10/26
Fixed attenuator STI	STI02-2200-10	005	2022/8/24	2023/8/23
LISN R&S	ESH3-Z5	848773/004	2021/10/29	2022/10/28
RF Coaxial Cable JYEBO	5D-FB	COCCAB-001	2022/8/24	2023/8/23
Software BVADT	BVADT_Cond_V7.3.7.4	N/A	N/A	N/A
TEST RECEIVER R&S	ESCS 30	847124/029	2021/10/13	2022/10/12

Notes:

1. The test was performed in Conduction 1
2. Tested Date: 2022/10/11

#### 4.8 Unwanted Emissions below 1 GHz

Description Manufacturer	Model No.	Serial No.	Calibrated Date	Calibrated Until
Bilog Antenna Schwarzbeck	VULB 9168	9168-0942	2021/10/26	2022/10/25
Boresight Antenna Tower & Turn Table Max-Full	MF-7802BS	MF780208530	N/A	N/A
Fixed attenuator Mini-Circuits	UNAT-5+	PAD-ATT5-01	2022/1/10	2023/1/9
LOOP ANTENNA Electro-Metrics	EM-6879	264	2022/3/18	2023/3/17
Pre_Amplifier EMCI	EMC001340	980142	2022/6/2	2023/6/1
Pre_Amplifier(20M-3G) EMCI	EMC330N	980852	2022/3/28	2023/3/27
RF Coaxial Cable COMMATE/PEWC	8D	966-6-1	2022/4/25	2023/4/24
		966-6-2	2022/4/25	2023/4/24
		966-6-3	2022/4/25	2023/4/24
RF Coaxial Cable JYEBO	5D-FB	LOOPCAB-001	2022/1/6	2023/1/5
		LOOPCAB-002	2022/1/6	2023/1/5
Software	ADT_Radiated_V8.7.08	N/A	N/A	N/A
Spectrum Analyzer Keysight	N9020B	MY60112410	2022/3/13	2023/3/12
Test Receiver KEYSIGHT	N9038A	MY59050100	2022/6/20	2023/6/19

Notes:

1. The test was performed in 966 Chamber No. 6.
2. Tested Date: 2022/10/11

#### 4.9 Unwanted Emissions above 1 GHz

Description Manufacturer	Model No.	Serial No.	Calibrated Date	Calibrated Until
Boresight Antenna Tower & Turn Table Max-Full	MF-7802BS	MF780208530	N/A	N/A
Horn Antenna Schwarzbeck	BBHA 9120D	9120D-2035	2021/11/14	2022/11/13
	BBHA 9170	BBHA9170519	2021/11/14	2022/11/13
Pre_Amplifier EMCI	EMC12630SE	980385	2022/8/15	2023/8/14
	EMC184045SE	980387	2022/1/10	2023/1/9
RF Cable EMCI	EMC104-SM-SM-1300	210205	2022/5/10	2023/5/9
RF Cable-Frequency range: 1- 40GHz EMCI	EMC102-KM-KM-1200	160924	2022/1/10	2023/1/9
RF Coaxial Cable EMCI	EMC-KM-KM-4000	200214	2022/3/8	2023/3/7
	EMC101G-KM-KM-10000	210708	2021/11/9	2022/11/8
Software	ADT_Radiated_V8.7.08	N/A	N/A	N/A
Spectrum Analyzer Keysight	N9020B	MY60112410	2022/3/13	2023/3/12
Test Receiver KEYSIGHT	N9038A	MY59050100	2022/6/20	2023/6/19

Notes:

1. The test was performed in 966 Chamber No. 6.
2. Tested Date: 2022/10/4 ~ 2022/10/11

## 5 Limits of Test Items

### 5.1 RF Output Power

The Maximum Output Power Measurement is 125 mW (21 dBm).

### 5.2 Number of Hopping Frequency Used

At least 15 channels frequencies, and should be equally spaced.

### 5.3 Dwell Time on Each Channel

The average time of occupancy on any channel shall not be greater than 0.4 seconds within a period of 0.4 seconds multiplied by the number of hopping channels employed.

### 5.4 Hopping Channel Separation

At least 25 kHz or two-third of 20 dB hopping channel bandwidth (whichever is greater).

### 5.5 20 dB Bandwidth

Maximum bandwidth is not specified.

### 5.6 Conducted Out of Band Emissions

Below 20 dB of the highest emission level of operating band (in 100 kHz Resolution Bandwidth).

### 5.7 AC Power Conducted Emissions

Frequency (MHz)	Conducted Limit (dBuV)	
	Quasi-peak	Average
0.15 - 0.5	66 - 56	56 - 46
0.50 - 5.0	56	46
5.0 - 30.0	60	50

Notes:

1. The lower limit shall apply at the transition frequencies.
2. The limit decreases in line with the logarithm of the frequency in the range of 0.15 to 0.50 MHz.



## 5.8 Unwanted Emissions below 1 GHz

Radiated emissions up to 1 GHz which fall in the restricted bands must comply with the radiated emission limits specified as below table. Other emissions shall be at least 20 dB below the highest level of the desired power:

Frequencies (MHz)	Field Strength (microvolts/meter)	Measurement Distance (meters)
0.009 ~ 0.490	2400/F(kHz)	300
0.490 ~ 1.705	24000/F(kHz)	30
1.705 ~ 30.0	30	30
30 ~ 88	100	3
88 ~ 216	150	3
216 ~ 960	200	3
Above 960	500	3

Notes:

1. The lower limit shall apply at the transition frequencies.
2. Emission level (dBuV/m) = 20 log Emission level (uV/m).

## 5.9 Unwanted Emissions above 1 GHz

Radiated emissions above 1 GHz which fall in the restricted bands must comply with the radiated emission limits specified as below table. Other emissions shall be at least 20 dB below the highest level of the desired power:

Frequencies (MHz)	Field Strength (microvolts/meter)	Measurement Distance (meters)
Above 960	500	3

Notes:

1. The lower limit shall apply at the transition frequencies.
2. Emission level (dBuV/m) = 20 log Emission level (uV/m).
3. For frequencies above 1000 MHz, the field strength limits are based on average detector, however, the peak field strength of any emission shall not exceed the maximum permitted average limits, specified above by more than 20 dB under any condition of modulation.

## 6 Test Arrangements

### 6.1 RF Output Power

#### 6.1.1 Test Setup

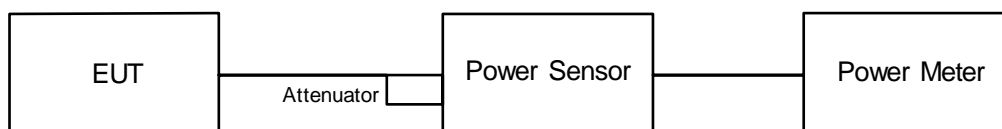

#### 6.1.2 Test Procedure

##### Peak Power:

A peak power sensor was used on the output port of the EUT. A power meter was used to read the response of the peak power sensor. Record the power level.

##### Average Power:

Average power sensor was used to perform output power measurement, trigger and gating function of wide band power meter is enabled to measure max output power of TX on burst. Duty factor is not added to measured value.

### 6.2 Number of Hopping Frequency Used

#### 6.2.1 Test Setup

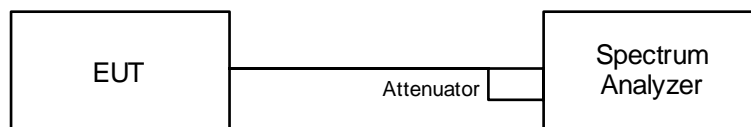

#### 6.2.2 Test Procedure

- a. Check the calibration of the measuring instrument (SA) using either an internal calibrator or a known signal from an external generator.
- b. Turn on the EUT and connect its antenna terminal to measurement via a low loss cable. Then set it to any one measured frequency within its operating range and make sure the instrument is operated in its linear range.
- c. Set the SA on MaxHold Mode, and then keep the EUT in hopping mode. Record all the signals from each channel until each one has been recorded.
- d. Set the SA on View mode and then plot the result on SA screen.
- e. Repeat above procedures until all frequencies measured were complete.

## 6.3 Dwell Time on Each Channel

### 6.3.1 Test Setup

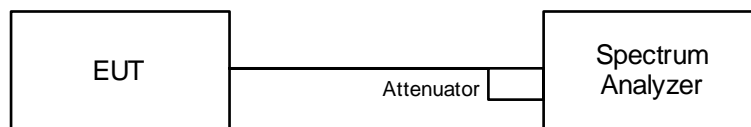

### 6.3.2 Test Procedure

- Check the calibration of the measuring instrument (SA) using either an internal calibrator or a known signal from an external generator.
- Turn on the EUT and connect its antenna terminal to measurement via a low loss cable. Then set it to any one measured frequency within its operating range and make sure the instrument is operated in its linear range.
- Adjust the center frequency of SA on any frequency be measured and set SA to zero span mode. And then, set RBW and VBW of spectrum analyzer to proper value.
- Measure the time duration of one transmission on the measured frequency. And then plot the result with time difference of this time duration.
- Repeat above procedures until all different time-slot modes have been completed.

## 6.4 Hopping Channel Separation

### 6.4.1 Test Setup

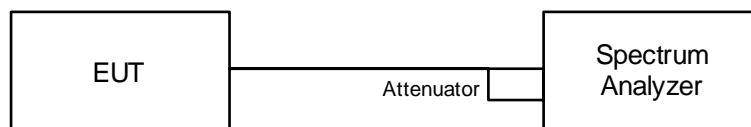

### 6.4.2 Test Procedure

- Check the calibration of the measuring instrument using either an internal calibrator or a known signal from an external generator.
- Turn on the EUT and connect it to measurement instrument. Then set it to any one convenient frequency within its operating range.
- By using the MaxHold function record the separation of two adjacent channels.
- Measure the frequency difference of these two adjacent channels by SA MARK function. And then plot the result on SA screen.
- Repeat above procedures until all frequencies measured were complete.

## 6.5 20 dB Bandwidth

### 6.5.1 Test Setup

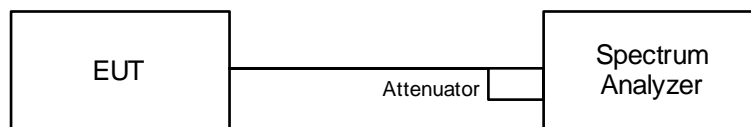

### 6.5.2 Test Procedure

- Check the calibration of the measuring instrument using either an internal calibrator or a known signal from an external generator.
- Turn on the EUT and connect it to measurement instrument. Then set it to any one convenient frequency within its operating range. Set a reference level on the measuring instrument equal to the highest peak value.
- Measure the frequency difference of two frequencies that were attenuated 20 dB from the reference level. Record the frequency difference as the emission bandwidth.
- Repeat above procedures until all frequencies measured were complete.

## 6.6 Conducted Out of Band Emissions

### 6.6.1 Test Setup

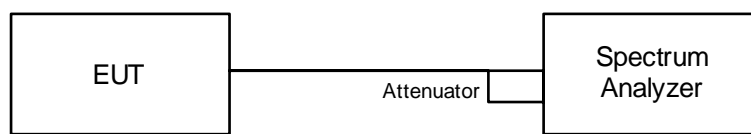

### 6.6.2 Test Procedure

#### MEASUREMENT PROCEDURE REF

- Set the RBW = 100 kHz.
- Set the VBW  $\geq$  300 kHz.
- Detector = peak.
- Sweep time = auto couple.
- Trace mode = max hold.
- Allow trace to fully stabilize.
- Use the peak marker function to determine the maximum power level in any 100 kHz band segment within the fundamental EBW.

#### MEASUREMENT PROCEDURE OOB

- Set RBW = 100 kHz.
- Set VBW  $\geq$  300 kHz.
- Detector = peak.
- Sweep = auto couple.
- Trace Mode = max hold.
- Allow trace to fully stabilize.
- Use the peak marker function to determine the maximum amplitude level.

## 6.7 AC Power Conducted Emissions

### 6.7.1 Test Setup

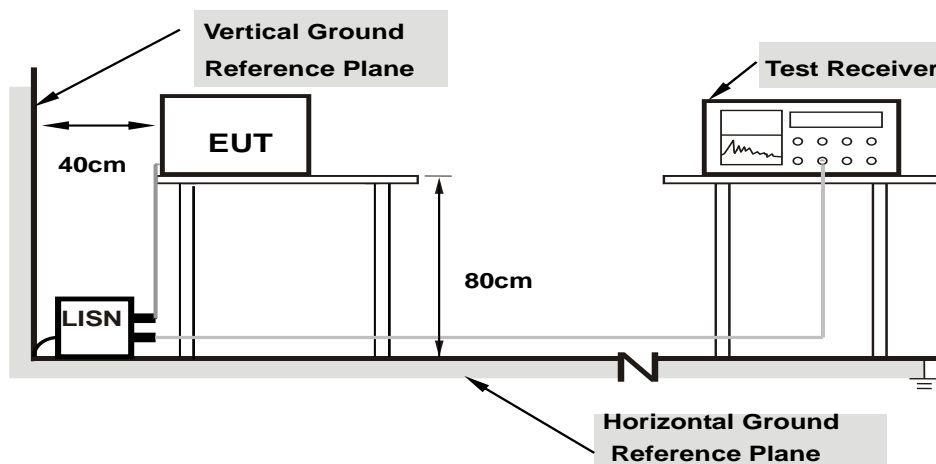

**Note: 1. Support units were connected to second LISN.**

For the actual test configuration, please refer to the attached file (Test Setup Photo).

### 6.7.2 Test Procedure

- The EUT was placed on a 0.8 meter to the top of table and placed 0.4 meters from the conducting wall of the shielded room with EUT being connected to the power mains through a line impedance stabilization network (LISN). Other support units were connected to the power mains through another LISN. The two LISNs provide 50 ohm/ 50 uH of coupling impedance for the measuring instrument.
- Both lines of the power mains connected to the EUT were checked for maximum conducted interference.
- The frequency range from 150 kHz to 30 MHz was searched. Emission levels under (Limit – 20 dB) was not recorded.

Note: The resolution bandwidth and video bandwidth of test receiver is 9 kHz for quasi-peak detection (QP) and average detection (AV) at frequency 0.15 MHz-30 MHz.

## 6.8 Unwanted Emissions below 1 GHz

### 6.8.1 Test Setup

#### For Radiated emission below 30 MHz

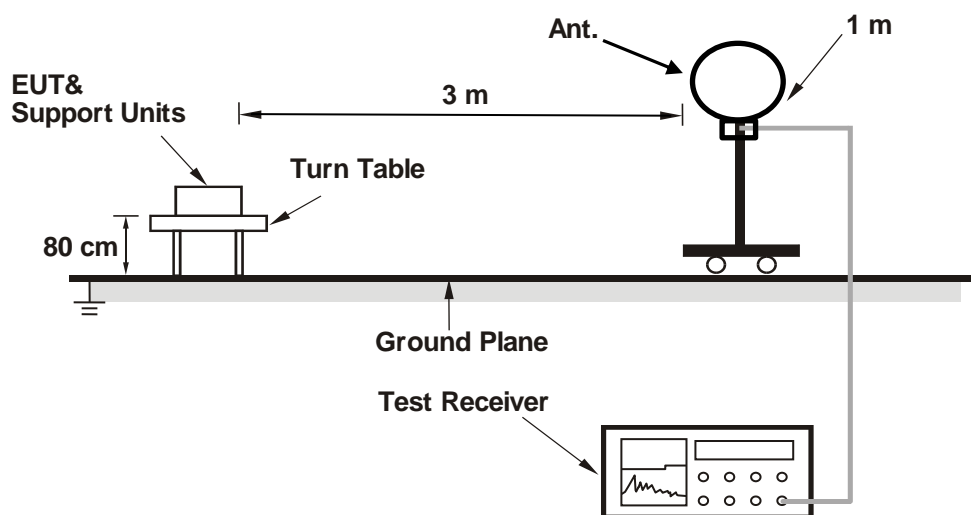

#### For Radiated emission above 30 MHz

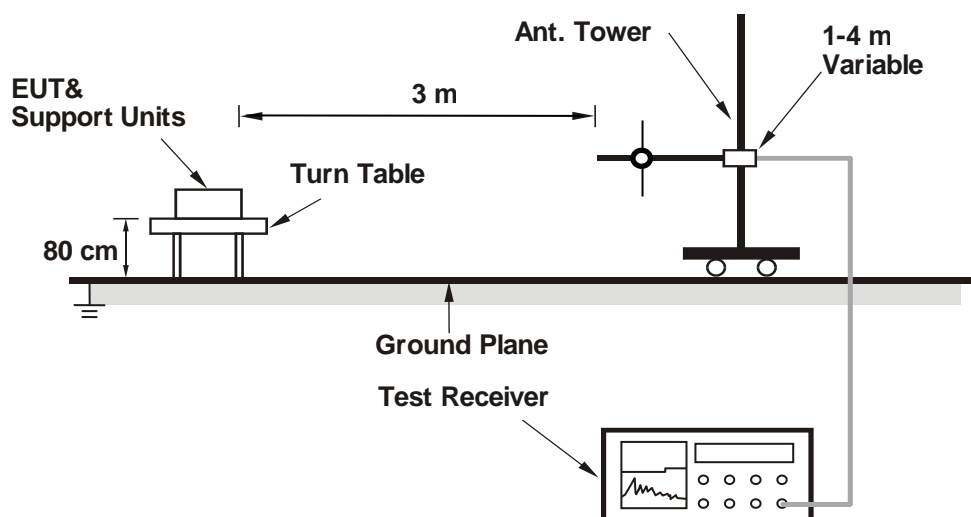

For the actual test configuration, please refer to the attached file (Test Setup Photo).

## 6.8.2 Test Procedure

### For Radiated emission below 30 MHz

- a. The EUT was placed on the top of a rotating table 0.8 meters above the ground at 3 meter chamber room for test. The table was rotated 360 degrees to determine the position of the highest radiation.
- b. The EUT was set 3 meters away from the interference-receiving antenna, which was mounted on the top of a variable-height antenna tower.
- c. Parallel, perpendicular, and ground-parallel orientations of the antenna are set to make the measurement.
- d. For each suspected emission, the EUT was arranged to its worst case and the rotatable table was turned from 0 degrees to 360 degrees to find the maximum reading.
- e. The test-receiver system was set to Quasi-Peak Detect Function and Specified Bandwidth with Maximum Hold Mode, except for the frequency band (9 kHz to 90 kHz and 110 kHz to 490 kHz) set to average detect function and peak detect function.

#### Notes:

1. The resolution bandwidth and video bandwidth of test receiver/spectrum analyzer is 200 Hz at frequency below 150 kHz.
2. The resolution bandwidth and video bandwidth of test receiver/spectrum analyzer is 9 kHz or 10 kHz at frequency (150 kHz to 30 MHz).
3. All modes of operation were investigated and the worst-case emissions are reported.

### For Radiated emission above 30 MHz

- a. The EUT was placed on the top of a rotating table 0.8 meters above the ground at 3 meter chamber room for test. The table was rotated 360 degrees to determine the position of the highest radiation.
- b. The EUT was set 3 meters away from the interference-receiving antenna, which was mounted on the top of a variable-height antenna tower.
- c. The height of antenna is varied from one meter to four meters above the ground to determine the maximum value of the field strength. Both horizontal and vertical polarizations of the antenna are set to make the measurement.
- d. For each suspected emission, the EUT was arranged to its worst case and then the antenna was tuned to heights from 1 meter to 4 meters and the rotatable table was turned from 0 degrees to 360 degrees to find the maximum reading.
- e. The test-receiver system was set to quasi-peak detect function and specified bandwidth with maximum hold mode when the test frequency is below 1 GHz.

#### Notes:

1. The resolution bandwidth and video bandwidth of test receiver/spectrum analyzer is 120 kHz for Quasi-peak detection (QP) at frequency below 1 GHz.
2. All modes of operation were investigated and the worst-case emissions are reported.

## 6.9 Unwanted Emissions above 1 GHz

### 6.9.1 Test Setup

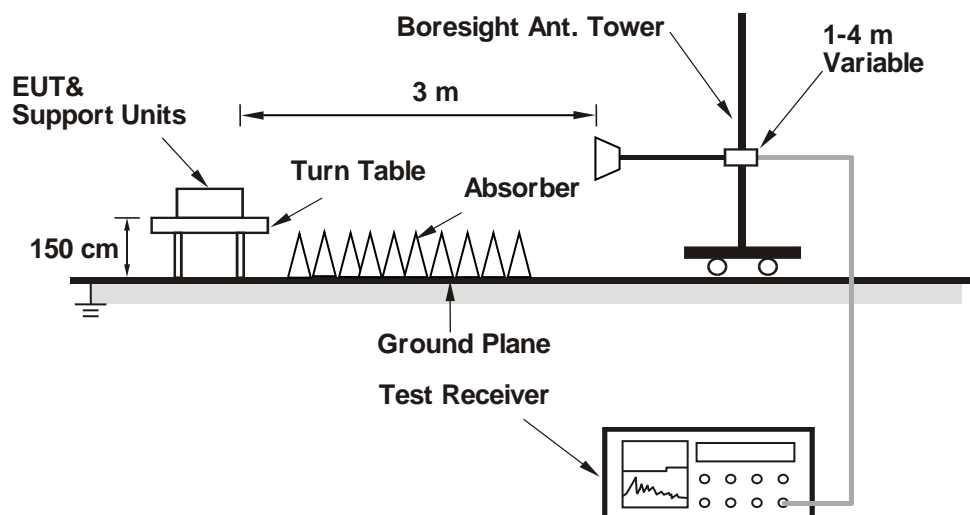

For the actual test configuration, please refer to the attached file (Test Setup Photo).

### 6.9.2 Test Procedure

- The EUT was placed on the top of a rotating table 1.5 meters above the ground at 3 meter chamber room for test. The table was rotated 360 degrees to determine the position of the highest radiation.
- The EUT was set 3 meters away from the interference-receiving antenna, which was mounted on the top of a variable-height antenna tower.
- The height of antenna is varied from one meter to four meters above the ground to determine the maximum value of the field strength. Both horizontal and vertical polarizations of the antenna are set to make the measurement.
- For each suspected emission, the EUT was arranged to its worst case and then the antenna was tuned to heights from 1 meter to 4 meters and the rotatable table was turned from 0 degrees to 360 degrees to find the maximum reading.
- The test-receiver system was set to peak and average detects function and specified bandwidth with maximum hold mode when the test frequency is above 1 GHz. If the peak reading value also meets average limit, measurement with the average detector is unnecessary.

#### Notes:

- The resolution bandwidth of test receiver/spectrum analyzer is 1 MHz and the video bandwidth is 3 MHz for Peak detection (PK) and Average detection (AV) at frequency above 1 GHz.
- According to ANSI C63.10 section 6.6.4 and 4.1.4.2.2. For fundamental and harmonic signal measurement, according to ANSI C63.10 section 7.5, the average value = peak value + duty cycle correction factor. For duty cycle correction factor values, see the Test Signal Duty Cycle section in this report.
- All modes of operation were investigated and the worst-case emissions are reported.



## 7 Test Results of Test Item

### 7.1 RF Output Power

Input Power:	3.7 Vdc	Environmental Conditions:	25°C, 64% RH	Tested By:	Eric Peng
--------------	---------	---------------------------	--------------	------------	-----------

#### For Peak Power

##### GFSK

Chan.	Chan. Freq. (MHz)	Peak Power (mW)	Peak Power (dBm)	Power Limit (dBm)	Test Result
0	2402	8.337	9.21	21	Pass
39	2441	7.834	8.94	21	Pass
78	2480	7.362	8.67	21	Pass

Note: The antenna gain is 2.5 dBi < 6 dBi, so the output power limit shall not be reduced.

##### 8DPSK

Chan.	Chan. Freq. (MHz)	Peak Power (mW)	Peak Power (dBm)	Power Limit (dBm)	Test Result
0	2402	8.356	9.22	21	Pass
39	2441	7.691	8.86	21	Pass
78	2480	7.447	8.72	21	Pass

Note: The antenna gain is 2.5 dBi < 6 dBi, so the output power limit shall not be reduced.

##### GFSK LightSpeed

Chan.	Chan. Freq. (MHz)	Peak Power (mW)	Peak Power (dBm)	Power Limit (dBm)	Test Result
0	2402	8.279	9.18	21	Pass
39	2441	7.798	8.92	21	Pass
78	2480	7.328	8.65	21	Pass

Note: The antenna gain is 2.5 dBi < 6 dBi, so the output power limit shall not be reduced.

##### $\pi/4$ -DQPSK LightSpeed

Chan.	Chan. Freq. (MHz)	Peak Power (mW)	Peak Power (dBm)	Power Limit (dBm)	Test Result
0	2402	8.147	9.11	21	Pass
39	2441	7.586	8.80	21	Pass
78	2480	7.031	8.47	21	Pass

Note: The antenna gain is 2.5 dBi < 6 dBi, so the output power limit shall not be reduced.

## For Average Power

### GFSK

Chan.	Chan. Freq. (MHz)	Average Power (mW)	Average Power (dBm)
0	2402	8.185	9.13
39	2441	7.691	8.86
78	2480	7.228	8.59

### 8DPSK

Chan.	Chan. Freq. (MHz)	Average Power (mW)	Average Power (dBm)
0	2402	5.559	7.45
39	2441	5.058	7.04
78	2480	4.624	6.65

### GFSK LightSpeed

Chan.	Chan. Freq. (MHz)	Average Power (mW)	Average Power (dBm)
0	2402	8.147	9.11
39	2441	7.656	8.84
78	2480	7.194	8.57

### $\pi/4$ -DQPSK LightSpeed

Chan.	Chan. Freq. (MHz)	Average Power (mW)	Average Power (dBm)
0	2402	5.623	7.50
39	2441	5.152	7.12
78	2480	4.688	6.71

## 7.2 Number of Hopping Frequency Used

Input Power:	3.7 Vdc	Environmental Conditions:	25°C, 64% RH	Tested By:	Eric Peng
--------------	---------	---------------------------	--------------	------------	-----------

### GFSK

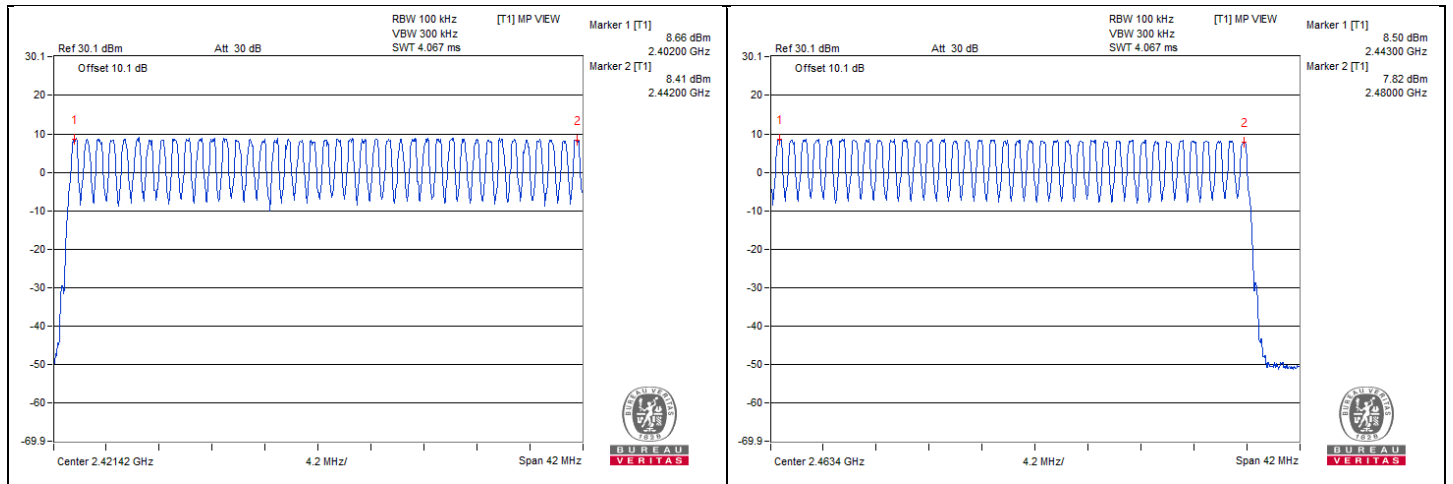

Note: There are 79 hopping frequencies in the hopping mode. On the plots, it shows that the hopping frequencies are equally spaced.

### 8DPSK

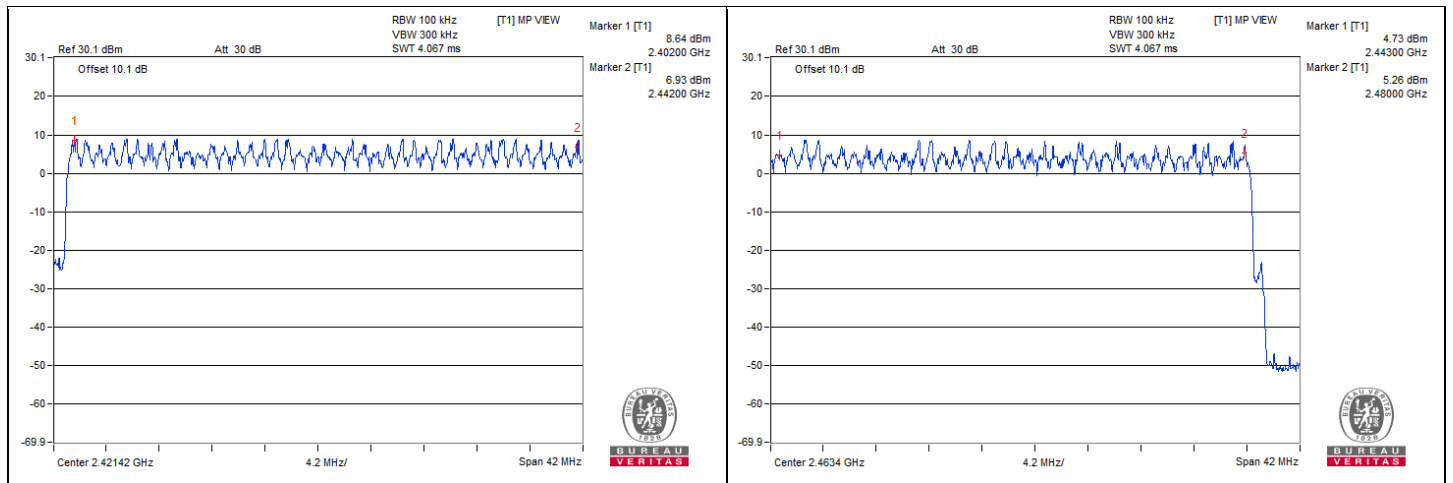

Note: There are 79 hopping frequencies in the hopping mode. On the plots, it shows that the hopping frequencies are equally spaced.

### GFSK LightSpeed

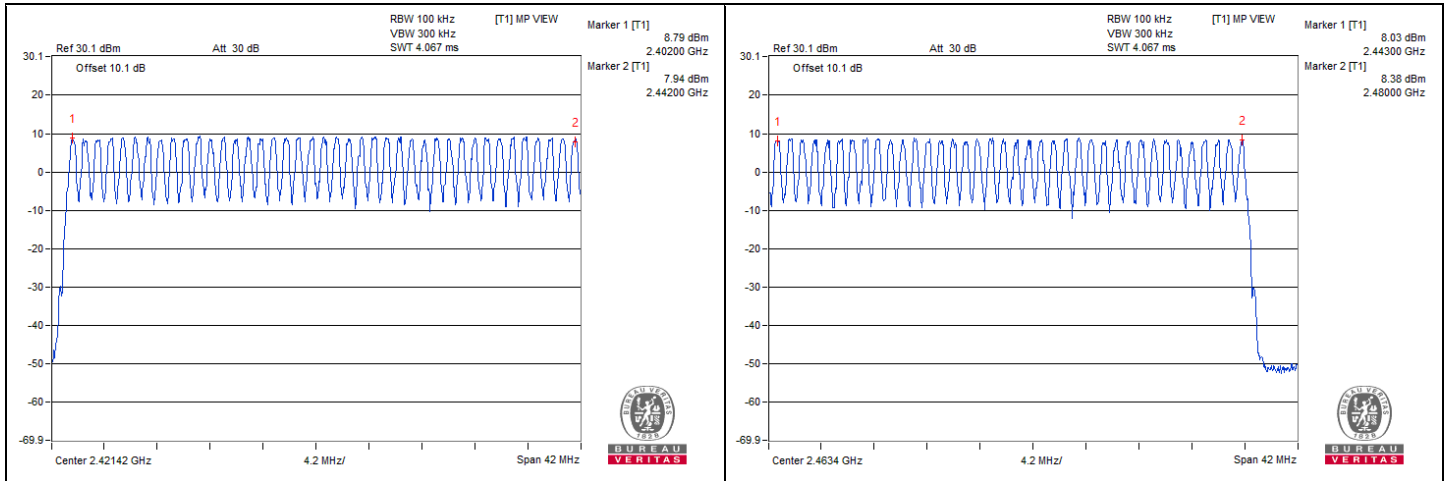

Note: There are 79 hopping frequencies in the hopping mode. On the plots, it shows that the hopping frequencies are equally spaced.

### $\pi/4$ -DQPSK LightSpeed

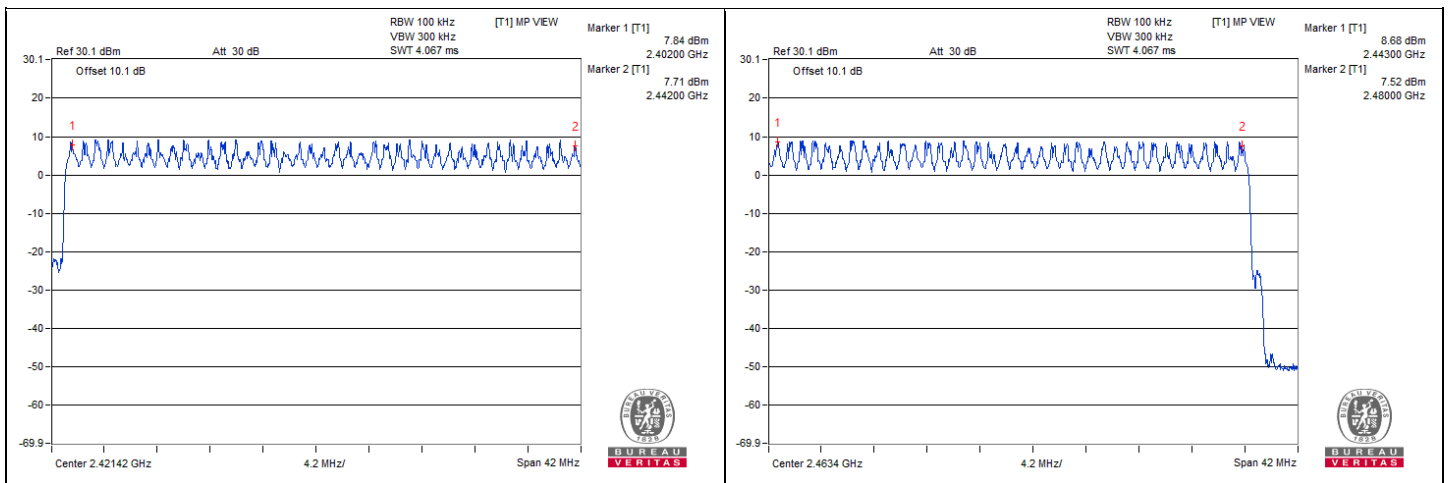

Note: There are 79 hopping frequencies in the hopping mode. On the plots, it shows that the hopping frequencies are equally spaced.

### 7.3 Dwell Time on Each Channel

Input Power:	3.7 Vdc	Environmental Conditions:	25°C, 64% RH	Tested By:	Eric Peng
--------------	---------	---------------------------	--------------	------------	-----------

### GFSK

Mode	Number of transmission in 31.6 sec	Length of transmission time (msec)	Result (msec)	Limit (msec)	Test Result
DH1	51 (times / 5 sec) * 6.32 = 323 times	0.45	145.35	400	Pass
DH3	26 (times / 5 sec) * 6.32 = 165 times	1.71	282.15	400	Pass
DH5	17 (times / 5 sec) * 6.32 = 108 times	2.952	318.82	400	Pass

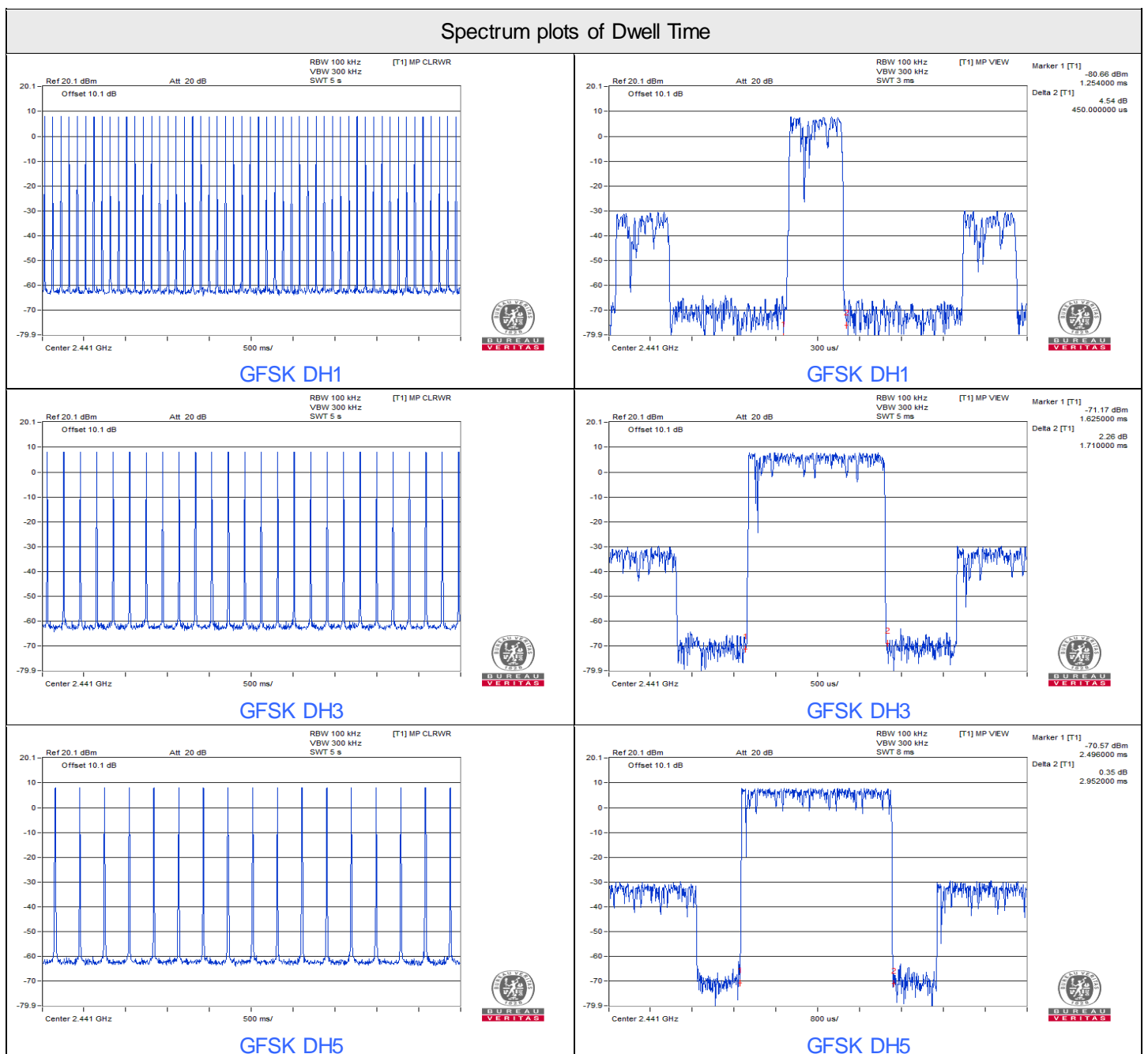

**8DPSK**

Mode	Number of transmission in 31.6 sec	Length of transmission time (msec)	Result (msec)	Limit (msec)	Test Result
3DH1	50 (times / 5 sec) * 6.32 = 316 times	0.417	131.77	400	Pass
3DH3	26 (times / 5 sec) * 6.32 = 165 times	1.69	278.85	400	Pass
3DH5	17 (times / 5 sec) * 6.32 = 108 times	2.952	318.82	400	Pass

**Spectrum plots of Dwell Time**

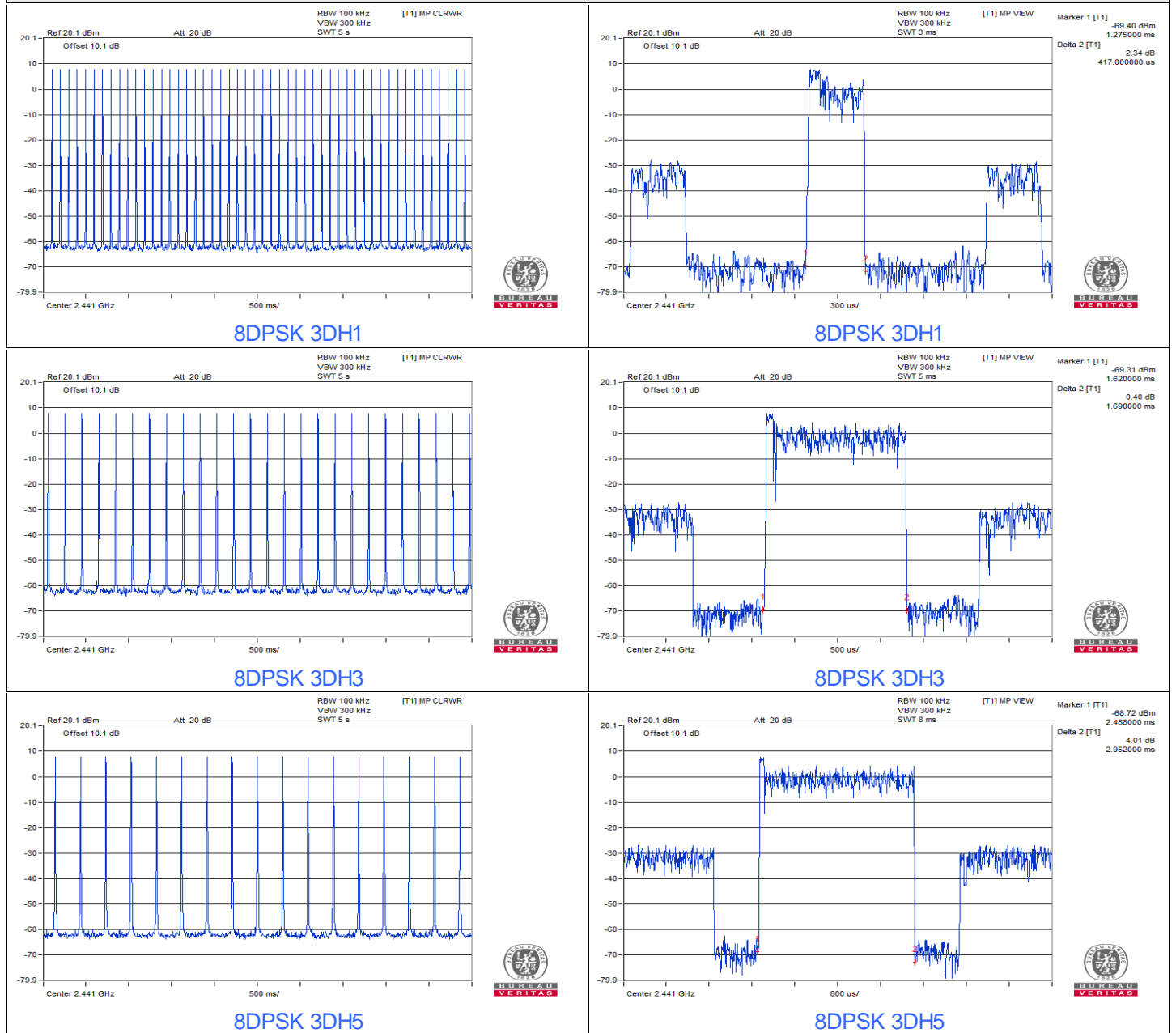

**GFSK LightSpeed**

Mode	Number of transmission in 31.6 sec	Length of transmission time (msec)	Result (msec)	Limit (msec)	Test Result
DH1	50 (times / 5 sec) * 6.32 = 316 times	0.423	133.67	400	Pass
DH3	25 (times / 5 sec) * 6.32 = 158 times	1.715	270.97	400	Pass
DH5	17 (times / 5 sec) * 6.32 = 108 times	2.96	319.68	400	Pass

**Spectrum plots of Dwell Time**

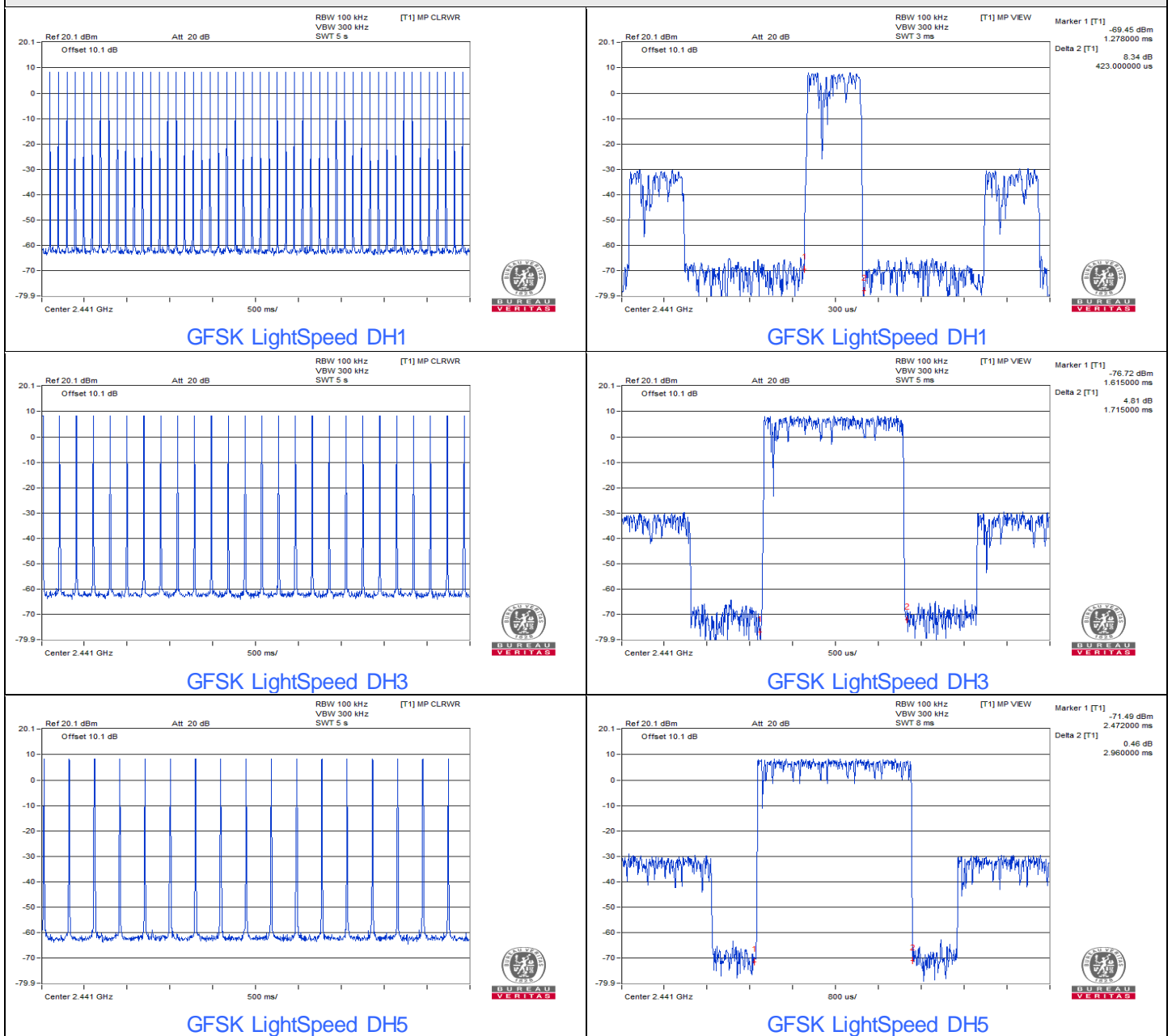

**$\pi/4$ -DQPSK LightSpeed**

Mode	Number of transmission in 31.6 sec	Length of transmission time (msec)	Result (msec)	Limit (msec)	Test Result
2DH1	50 (times / 5 sec) * 6.32 = 316 times	0.435	137.46	400	Pass
2DH3	25 (times / 5 sec) * 6.32 = 158 times	1.705	269.39	400	Pass
2DH5	17 (times / 5 sec) * 6.32 = 108 times	2.928	316.22	400	Pass

**Spectrum plots of Dwell Time**

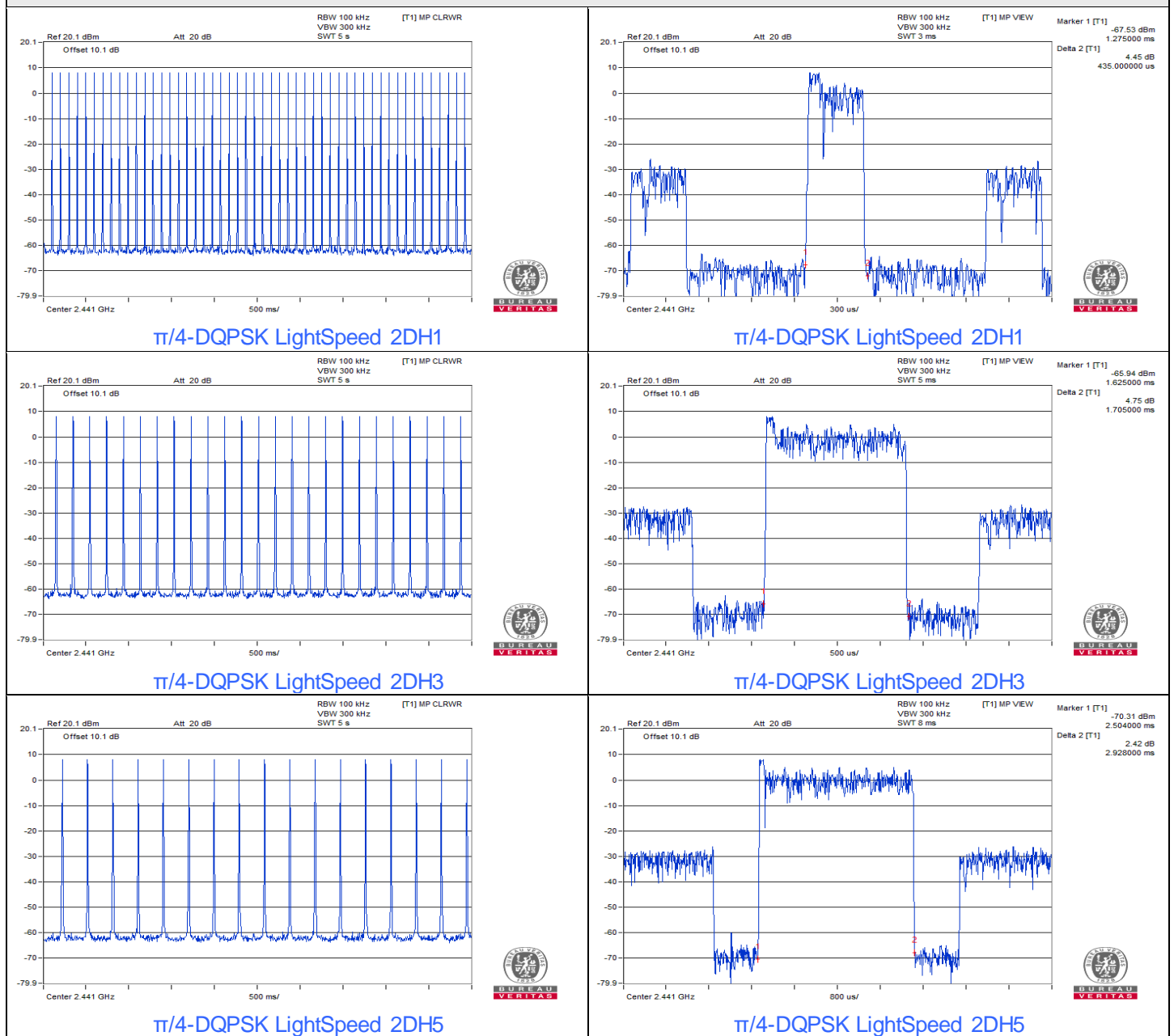



## 7.4 Hopping Channel Separation

Input Power:	3.7 Vdc	Environmental Conditions:	25°C, 64% RH	Tested By:	Eric Peng
--------------	---------	---------------------------	--------------	------------	-----------

### GFSK

Channel	Frequency (MHz)	Hopping Channel Separation (MHz)	Minimum Limit (MHz)	Test Result
0	2402	1	0.66	Pass
39	2441	1	0.7	Pass
78	2480	1	0.69	Pass

Note: The minimum limit is two-third 20dB bandwidth.

### 8DPSK

Channel	Frequency (MHz)	Hopping Channel Separation (MHz)	Minimum Limit (MHz)	Test Result
0	2402	1	0.88	Pass
39	2441	1	0.87	Pass
78	2480	1	0.88	Pass

Note: The minimum limit is two-third 20dB bandwidth.

### GFSK LightSpeed

Channel	Frequency (MHz)	Hopping Channel Separation (MHz)	Minimum Limit (MHz)	Test Result
0	2402	1	0.68	Pass
39	2441	1	0.69	Pass
78	2480	1	0.69	Pass

Note: The minimum limit is two-third 20dB bandwidth.

### $\pi/4$ -DQPSK LightSpeed

Channel	Frequency (MHz)	Hopping Channel Separation (MHz)	Minimum Limit (MHz)	Test Result
0	2402	1	0.86	Pass
39	2441	1	0.86	Pass
78	2480	1	0.86	Pass

Note: The minimum limit is two-third 20dB bandwidth.

### Spectrum Plot of Minimum Value

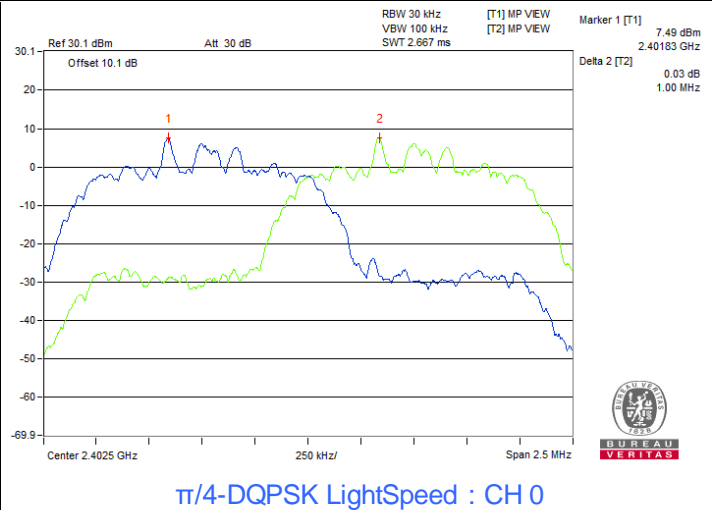
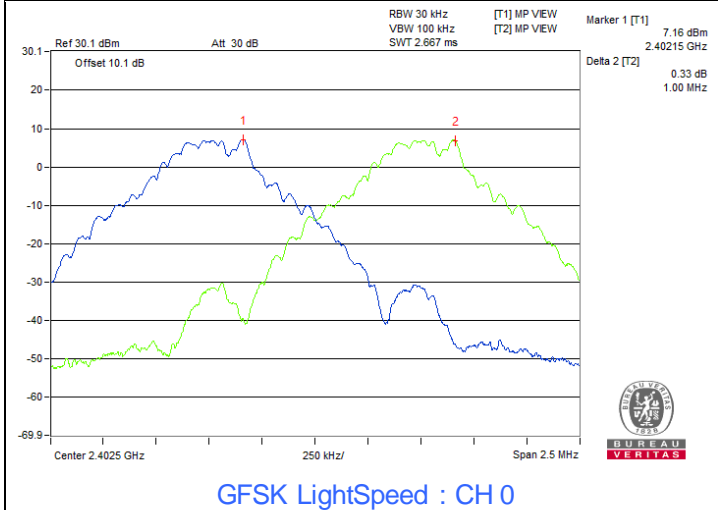
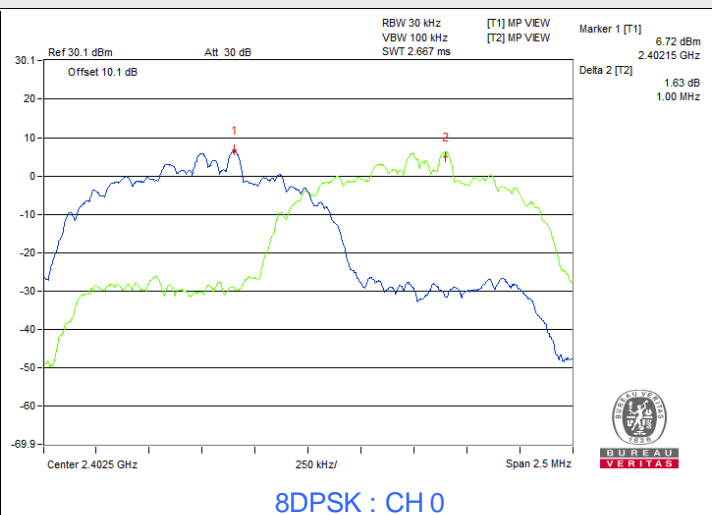
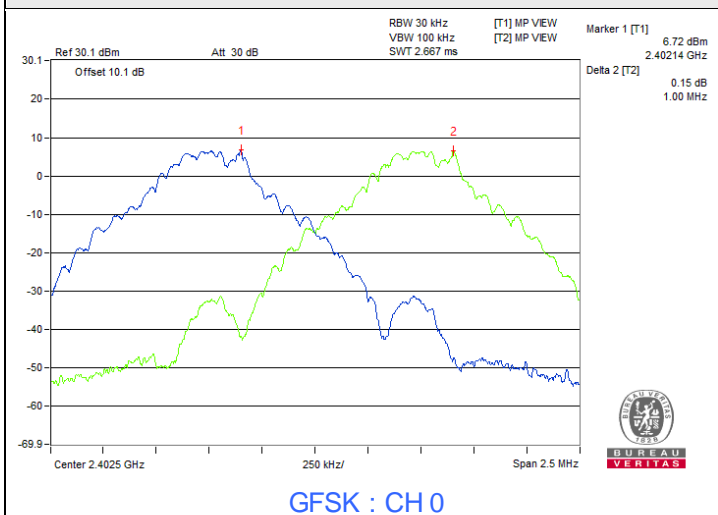

## 7.5 20 dB Bandwidth

Input Power:	3.7 Vdc	Environmental Conditions:	25°C, 64% RH	Tested By:	Eric Peng
--------------	---------	---------------------------	--------------	------------	-----------

### GFSK

Channel	Frequency (MHz)	20dB Bandwidth (MHz)
0	2402	0.98
39	2441	1.04
78	2480	1.03

### 8DPSK

Channel	Frequency (MHz)	20dB Bandwidth (MHz)
0	2402	1.31
39	2441	1.3
78	2480	1.32

### GFSK LightSpeed

Channel	Frequency (MHz)	20dB Bandwidth (MHz)
0	2402	1.02
39	2441	1.03
78	2480	1.03

### $\pi/4$ -DQPSK LightSpeed

Channel	Frequency (MHz)	20dB Bandwidth (MHz)
0	2402	1.28
39	2441	1.28
78	2480	1.28

### Spectrum Plot of Maximum Value

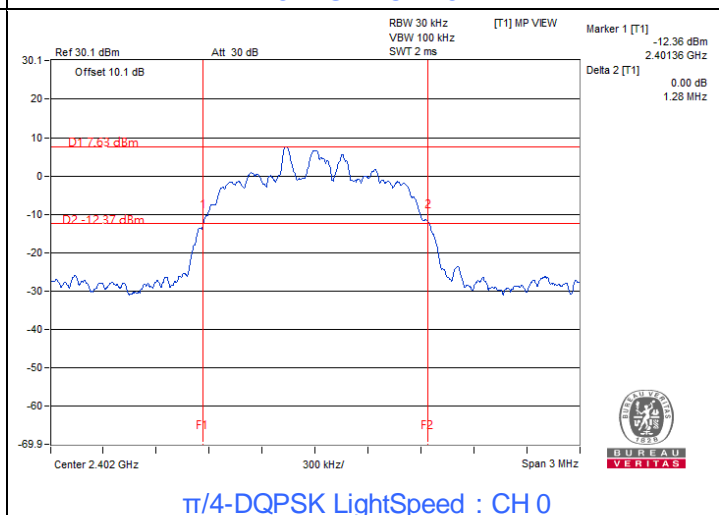
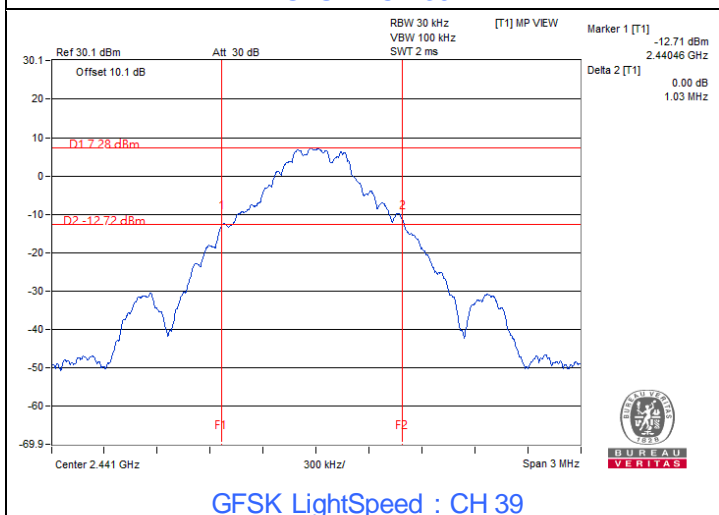
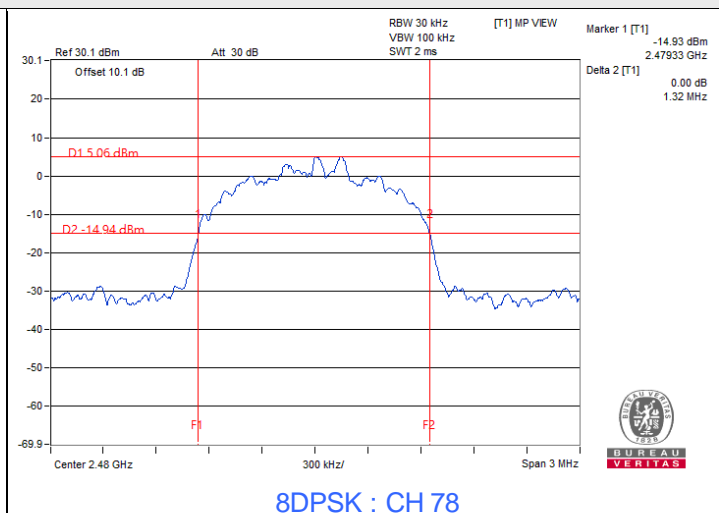
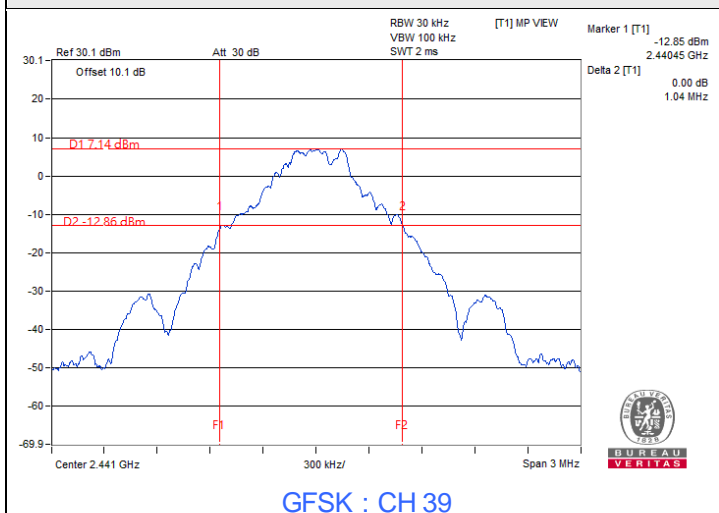

## 7.6 Conducted Out of Band Emissions

Input Power:	3.7 Vdc	Environmental Conditions:	25°C, 64% RH	Tested By:	Eric Peng
--------------	---------	---------------------------	--------------	------------	-----------

### GFSK

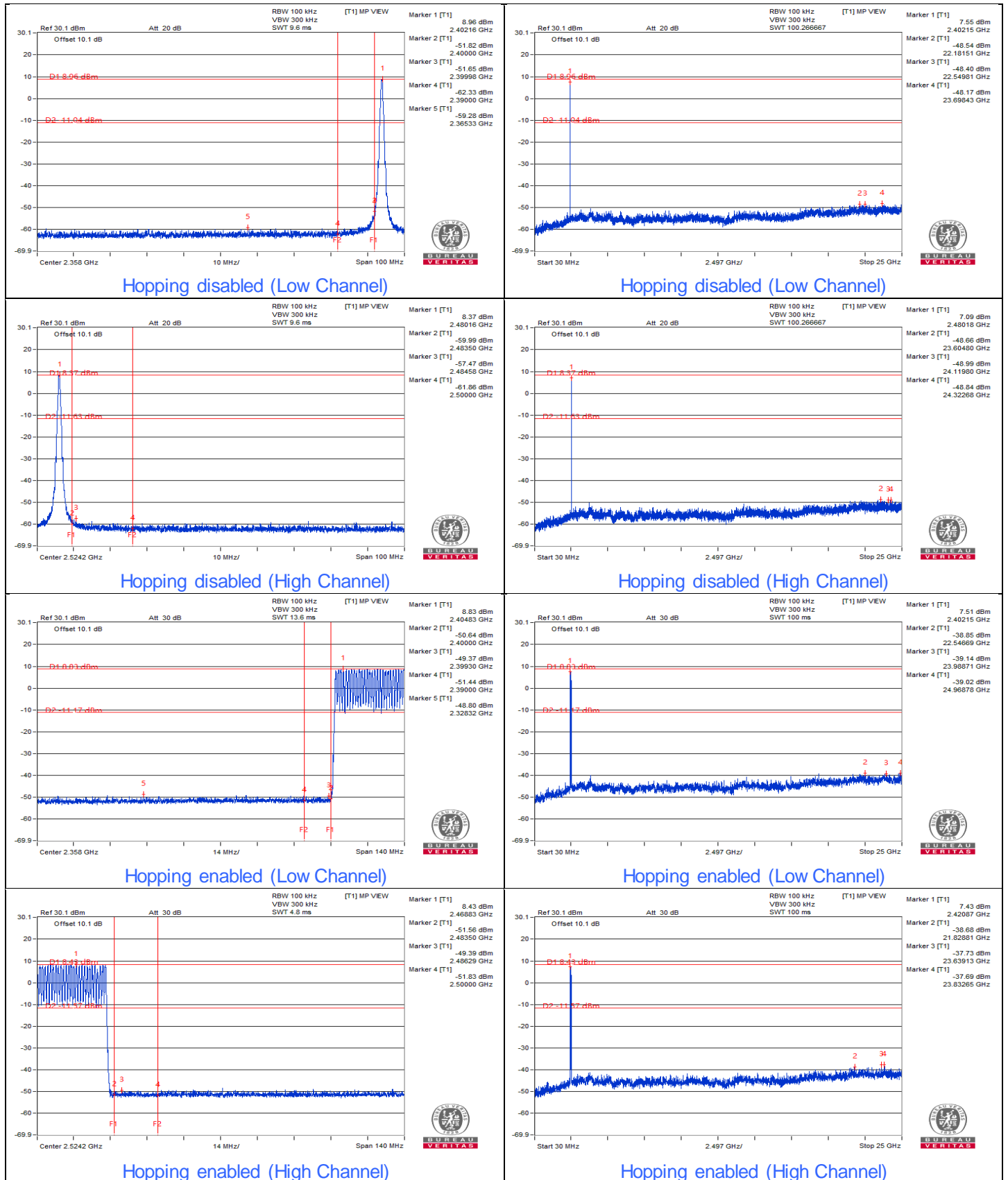



# 8DPSK

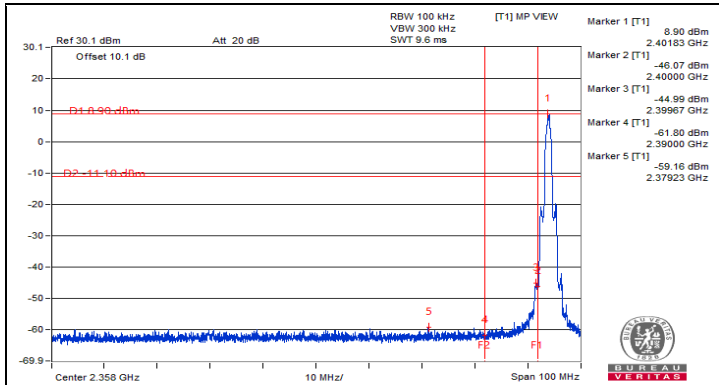

Hopping disabled (Low Channel)

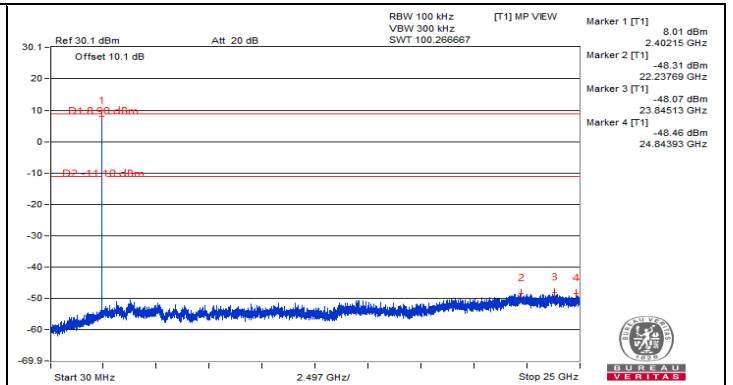

Hopping disabled (Low Channel)

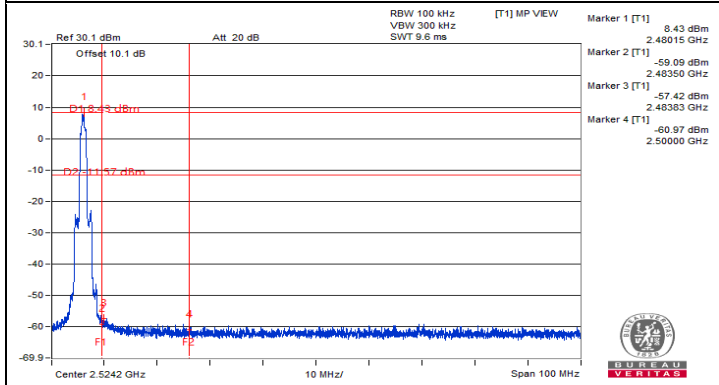

Hopping disabled (High Channel)

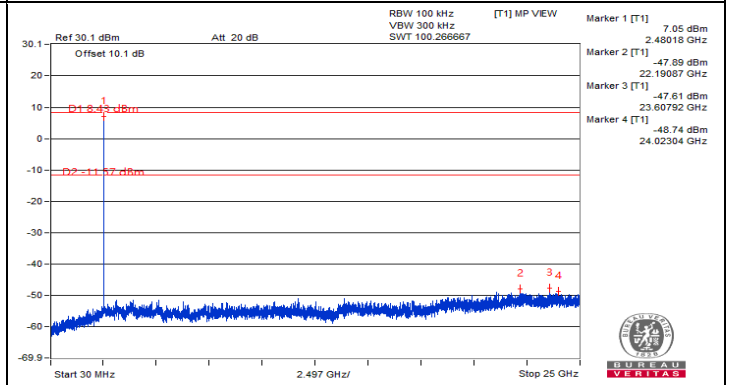

Hopping disabled (High Channel)

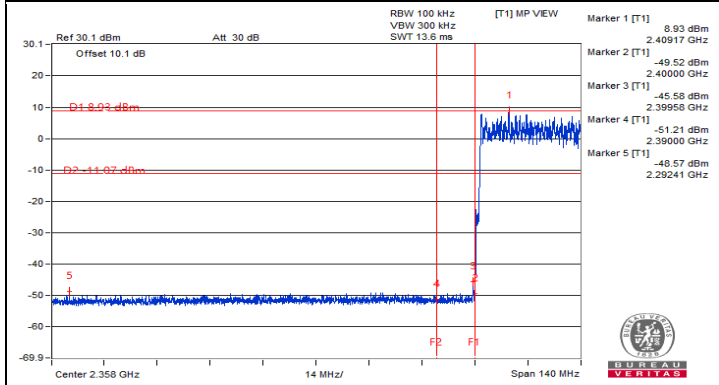

Hopping enabled (Low Channel)

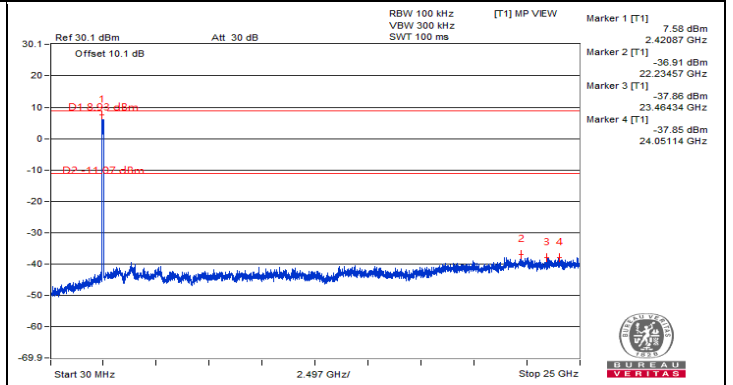

Hopping enabled (Low Channel)

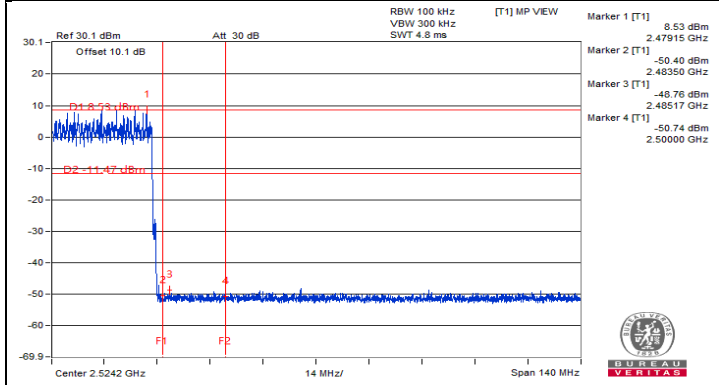

Hopping enabled (High Channel)

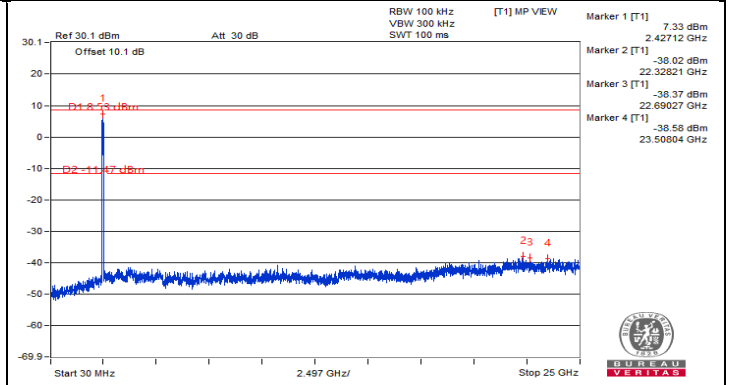

Hopping enabled (High Channel)



# GFSK LightSpeed

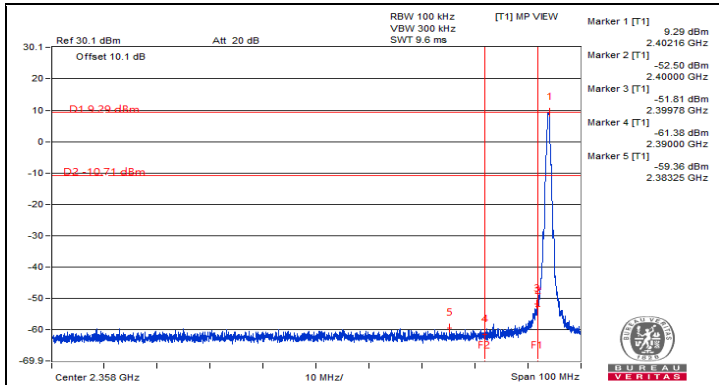

Hopping disabled (Low Channel)

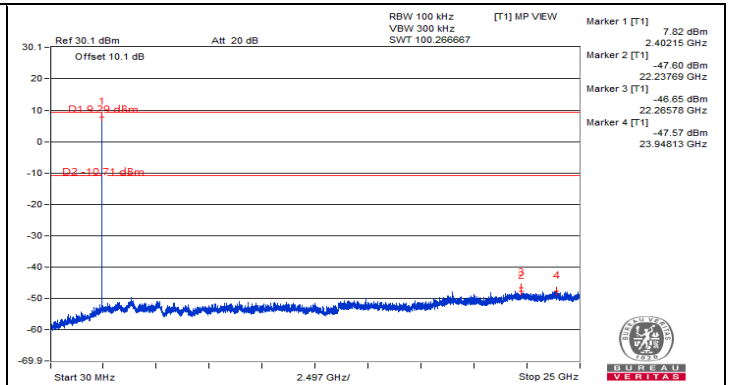

Hopping disabled (Low Channel)

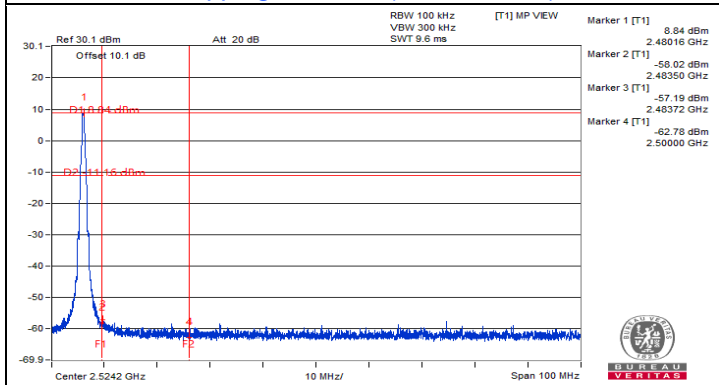

Hopping disabled (High Channel)

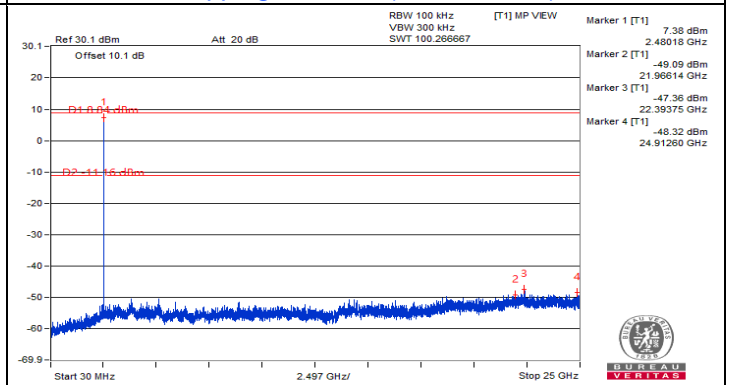

Hopping disabled (High Channel)

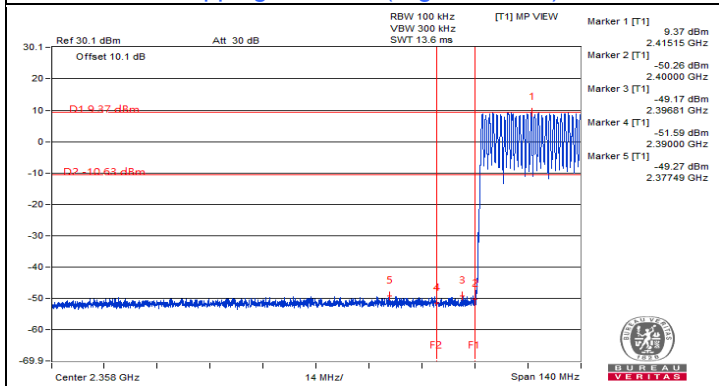

Hopping enabled (Low Channel)

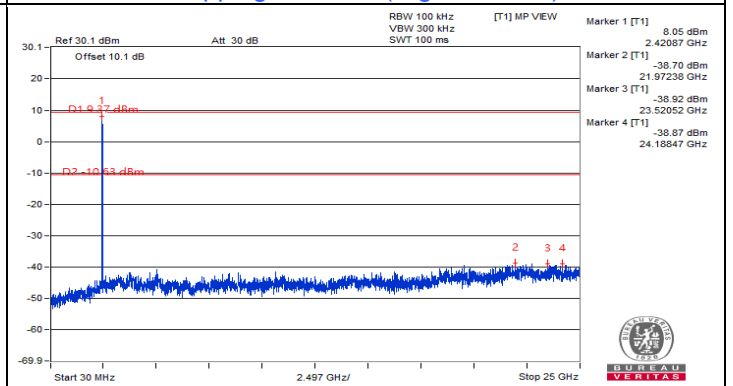

Hopping enabled (Low Channel)

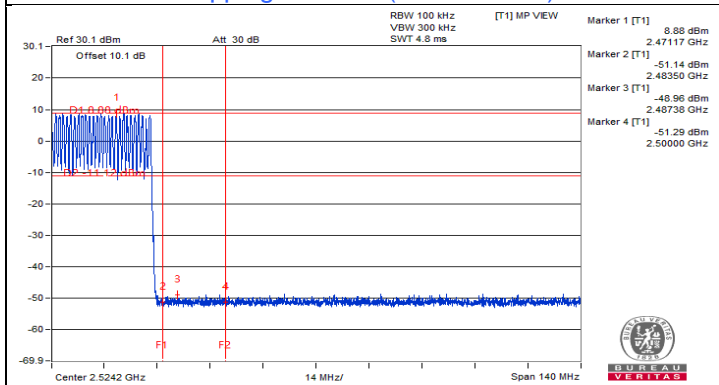

Hopping enabled (High Channel)

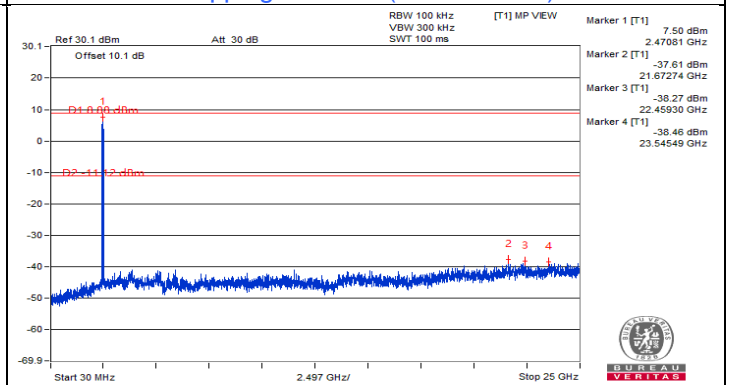

Hopping enabled (High Channel)



BUREAU VERITAS

# $\pi/4$ -DQPSK LightSpeed

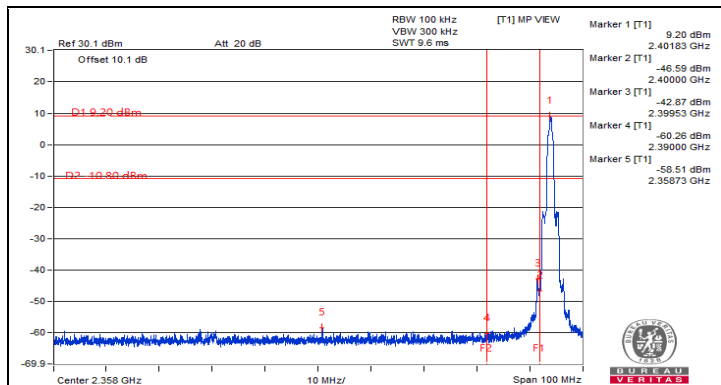

Hopping disabled (Low Channel)

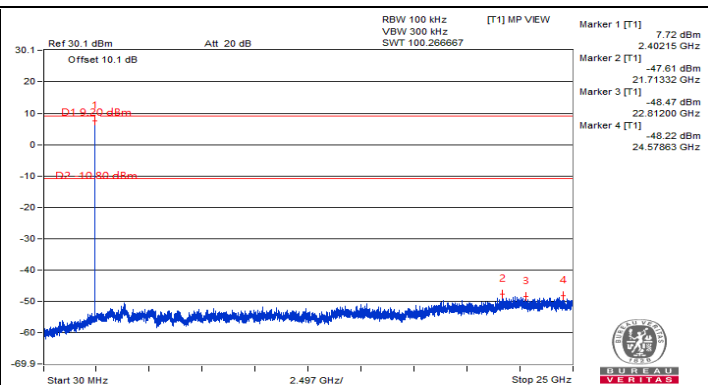

Hopping disabled (Low Channel)

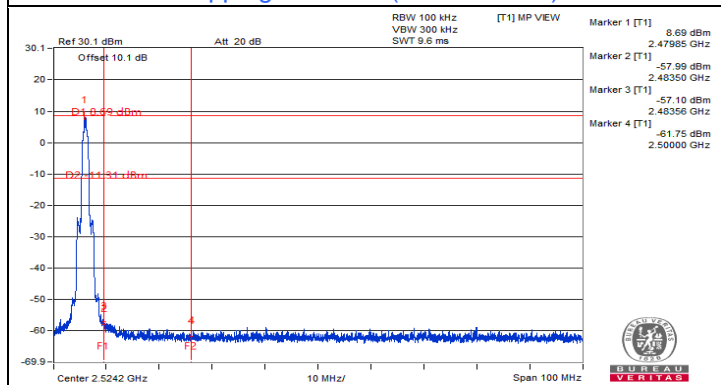

Hopping disabled (High Channel)

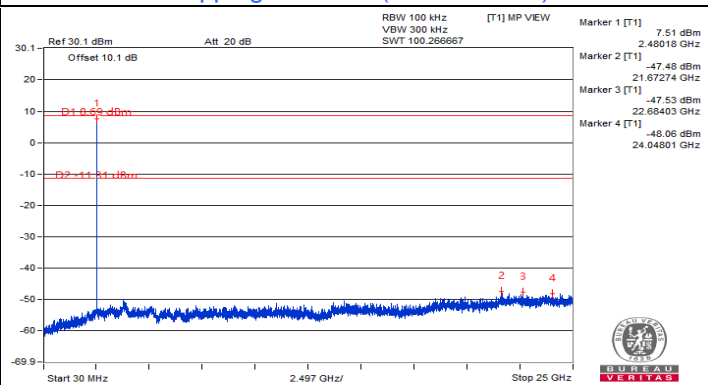

Hopping disabled (High Channel)

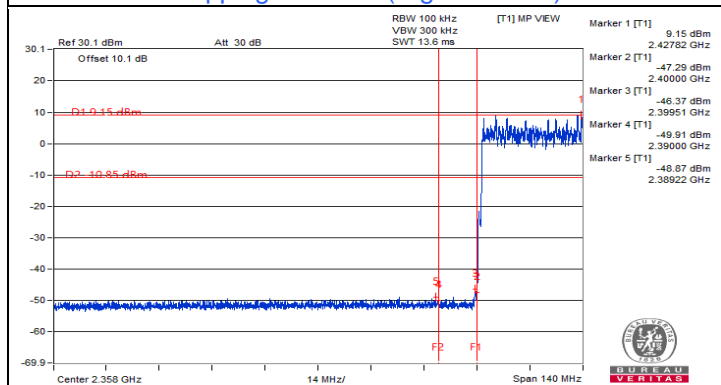

Hopping enabled (Low Channel)

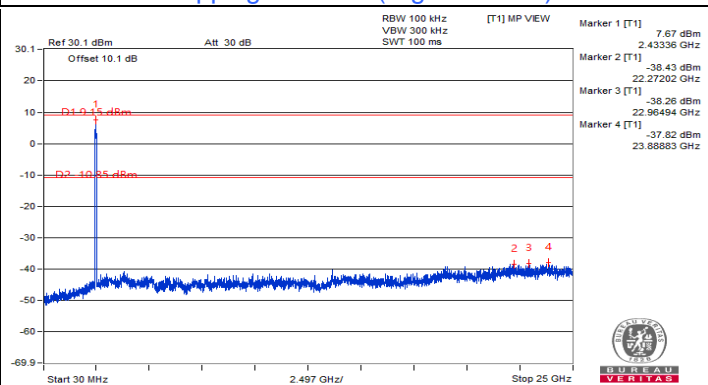

Hopping enabled (Low Channel)

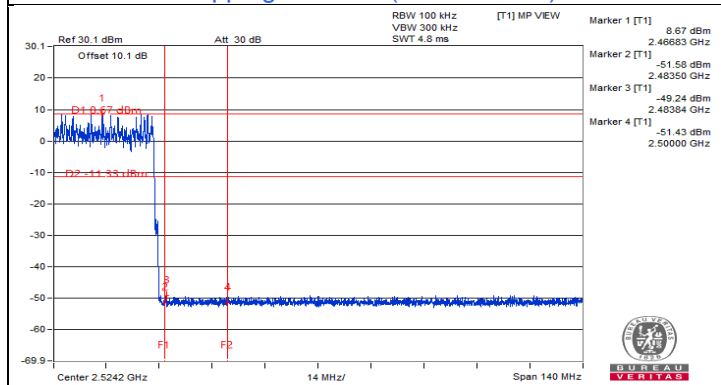

Hopping enabled (High Channel)

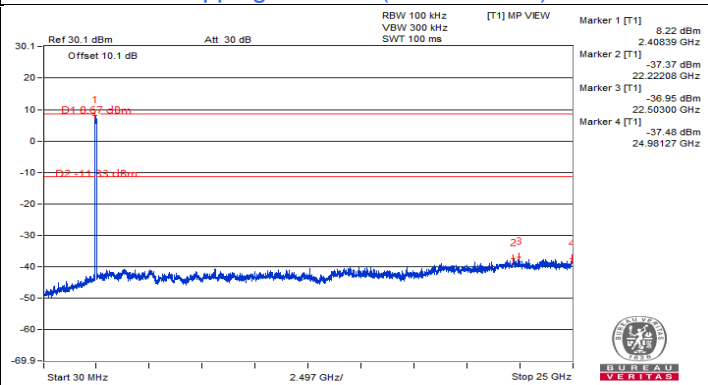

Hopping enabled (High Channel)



## 7.7 AC Power Conducted Emissions

RF Mode	BT GFSK	Channel	CH 0 : 2402 MHz
Frequency Range	150 kHz ~ 30 MHz	Detector Function & Resolution Bandwidth	Quasi-Peak (QP) / Average (AV), 9 kHz
Input Power (System)	120 Vac, 60 Hz	Environmental Conditions	25°C, 75% RH
Tested By	Carter Lin		

### Phase Of Power : Line (L)

No	Frequency (MHz)	Correction Factor (dB)	Reading Value (dBuV)		Emission Level (dBuV)		Limit (dBuV)		Margin (dB)	
			Q.P.	AV.	Q.P.	AV.	Q.P.	AV.	Q.P.	AV.
1	0.15786	9.96	38.18	22.42	48.14	32.38	65.58	55.58	-17.44	-23.20
2	0.17735	9.96	30.66	10.36	40.62	20.32	64.61	54.61	-23.99	-34.29
3	0.32962	9.97	20.74	7.83	30.71	17.80	59.46	49.46	-28.75	-31.66
4	0.49377	9.97	27.96	21.54	37.93	31.51	56.10	46.10	-18.17	-14.59
5	0.57968	9.98	21.39	8.37	31.37	18.35	56.00	46.00	-24.63	-27.65
6	0.65000	9.98	24.59	14.78	34.57	24.76	56.00	46.00	-21.43	-21.24

#### Remarks:

1. Q.P. and AV. are abbreviations of quasi-peak and average individually.
2. The emission levels of other frequencies were very low against the limit.
3. Margin value = Emission level – Limit value
4. Correction factor = Insertion loss + Cable loss
5. Emission Level = Correction Factor + Reading Value

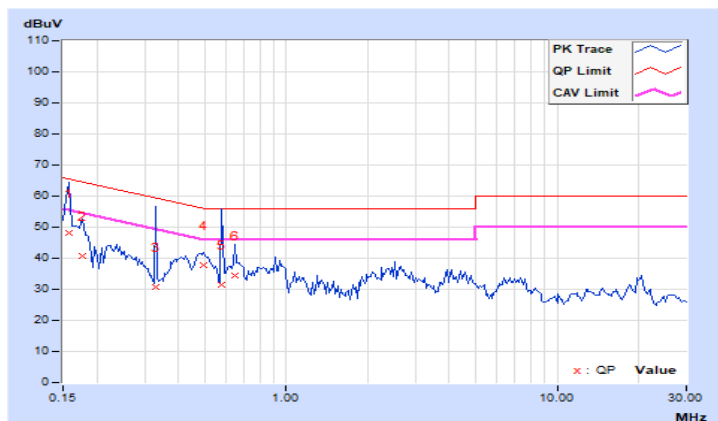

RF Mode	BT GFSK	Channel	CH 0 : 2402 MHz
Frequency Range	150 kHz ~ 30 MHz	Detector Function & Resolution Bandwidth	Quasi-Peak (QP) / Average (AV), 9 kHz
Input Power (System)	120 Vac, 60 Hz	Environmental Conditions	25°C, 75% RH
Tested By	Carter Lin		

Phase Of Power : Neutral (N)										
No	Frequency (MHz)	Correction Factor (dB)	Reading Value (dBuV)		Emission Level (dBuV)		Limit (dBuV)		Margin (dB)	
			Q.P.	AV.	Q.P.	AV.	Q.P.	AV.	Q.P.	AV.
1	0.16953	9.93	42.43	25.66	52.36	35.59	64.98	54.98	-12.62	-19.39
2	0.23594	9.94	36.44	19.71	46.38	29.65	62.24	52.24	-15.86	-22.59
3	0.48203	9.94	29.29	18.06	39.23	28.00	56.30	46.30	-17.07	-18.30
4	2.30859	10.03	28.91	19.89	38.94	29.92	56.00	46.00	-17.06	-16.08
5	4.75391	10.13	24.38	17.87	34.51	28.00	56.00	46.00	-21.49	-18.00
6	7.30859	10.25	22.42	16.12	32.67	26.37	60.00	50.00	-27.33	-23.63

**Remarks:**

1. Q.P. and AV. are abbreviations of quasi-peak and average individually.
2. The emission levels of other frequencies were very low against the limit.
3. Margin value = Emission level – Limit value
4. Correction factor = Insertion loss + Cable loss
5. Emission Level = Correction Factor + Reading Value

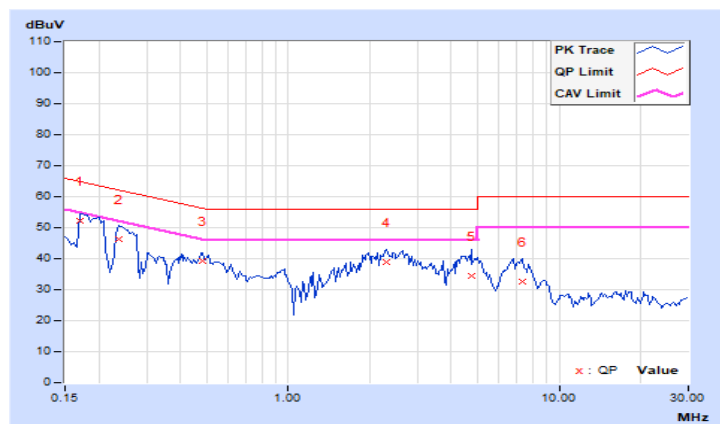

<b>RF Mode</b>	LIGHTSPEED GFSK	<b>Channel</b>	CH 0 : 2402 MHz
<b>Frequency Range</b>	150 kHz ~ 30 MHz	<b>Detector Function &amp; Resolution Bandwidth</b>	Quasi-Peak (QP) / Average (AV), 9 kHz
<b>Input Power (System)</b>	120 Vac, 60 Hz	<b>Environmental Conditions</b>	25°C, 75% RH
<b>Tested By</b>	Carter Lin		

Phase Of Power : Line (L)										
No	Frequency (MHz)	Correction Factor (dB)	Reading Value (dBuV)		Emission Level (dBuV)		Limit (dBuV)		Margin (dB)	
			Q.P.	AV.	Q.P.	AV.	Q.P.	AV.	Q.P.	AV.
1	0.15781	9.96	38.07	22.32	48.03	32.28	65.58	55.58	-17.55	-23.30
2	0.17734	9.96	30.67	10.31	40.63	20.27	64.61	54.61	-23.98	-34.34
3	0.32969	9.97	20.69	7.77	30.66	17.74	59.46	49.46	-28.80	-31.72
4	0.49375	9.97	27.94	21.56	37.91	31.53	56.10	46.10	-18.19	-14.57
5	0.57969	9.98	21.40	8.14	31.38	18.12	56.00	46.00	-24.62	-27.88
6	0.65000	9.98	24.54	14.63	34.52	24.61	56.00	46.00	-21.48	-21.39

**Remarks:**

1. Q.P. and AV. are abbreviations of quasi-peak and average individually.
2. The emission levels of other frequencies were very low against the limit.
3. Margin value = Emission level – Limit value
4. Correction factor = Insertion loss + Cable loss
5. Emission Level = Correction Factor + Reading Value

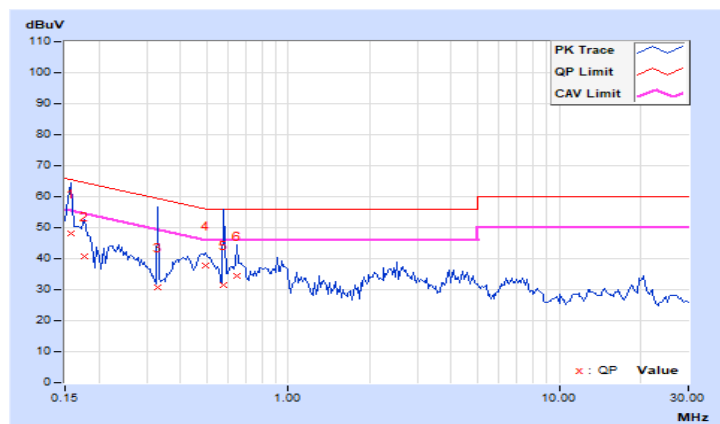

RF Mode	LIGHTSPEED GFSK	Channel	CH 0 : 2402 MHz
Frequency Range	150 kHz ~ 30 MHz	Detector Function & Resolution Bandwidth	Quasi-Peak (QP) / Average (AV), 9 kHz
Input Power (System)	120 Vac, 60 Hz	Environmental Conditions	25°C, 75% RH
Tested By	Carter Lin		

Phase Of Power : Neutral (N)										
No	Frequency (MHz)	Correction Factor (dB)	Reading Value (dBuV)		Emission Level (dBuV)		Limit (dBuV)		Margin (dB)	
			Q.P.	AV.	Q.P.	AV.	Q.P.	AV.	Q.P.	AV.
1	0.16961	9.93	42.38	25.68	52.31	35.61	64.98	54.98	-12.67	-19.37
2	0.23595	9.94	36.54	19.71	46.48	29.65	62.24	52.24	-15.76	-22.59
3	0.48218	9.94	29.31	18.12	39.25	28.06	56.30	46.30	-17.05	-18.24
4	2.30863	10.03	28.95	19.86	38.98	29.89	56.00	46.00	-17.02	-16.11
5	4.75389	10.13	24.41	17.75	34.54	27.88	56.00	46.00	-21.46	-18.12
6	7.30864	10.25	22.32	16.12	32.57	26.37	60.00	50.00	-27.43	-23.63

**Remarks:**

1. Q.P. and AV. are abbreviations of quasi-peak and average individually.
2. The emission levels of other frequencies were very low against the limit.
3. Margin value = Emission level – Limit value
4. Correction factor = Insertion loss + Cable loss
5. Emission Level = Correction Factor + Reading Value

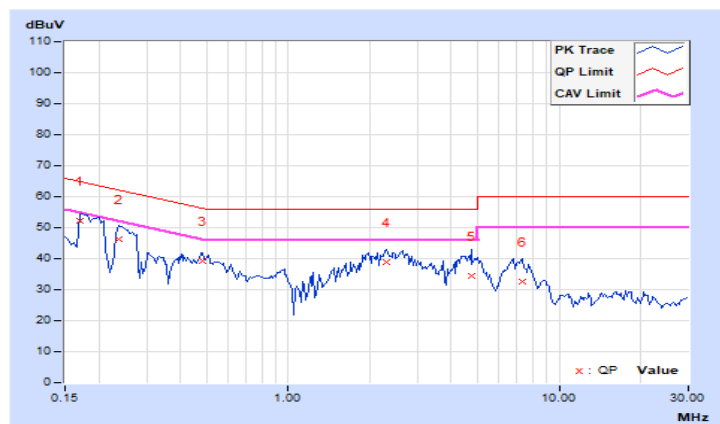

### 7.8 Unwanted Emissions below 1 GHz

<b>RF Mode</b>	BT GFSK	<b>Channel</b>	CH 0 : 2402 MHz
<b>Frequency Range</b>	9 kHz ~ 1 GHz	<b>Detector Function &amp; Bandwidth</b>	(QP) RB = 120kHz
<b>Input Power (System)</b>	120 Vac, 60 Hz	<b>Environmental Conditions</b>	22°C, 66% RH
<b>Tested By</b>	Sampson Chen		

#### Antenna Polarity & Test Distance : Horizontal at 3 m

No	Frequency (MHz)	Emission Level (dBuV/m)	Limit (dBuV/m)	Margin (dB)	Antenna Height (m)	Table Angle (Degree)	Raw Value (dBuV)	Correction Factor (dB/m)
1	33.90	25.3 QP	40.0	-14.7	2.00 H	300	38.8	-13.5
2	54.44	22.8 QP	40.0	-17.2	3.00 H	214	35.2	-12.4
3	96.61	19.6 QP	43.5	-23.9	3.00 H	268	37.4	-17.8
4	148.51	20.8 QP	43.5	-22.7	3.00 H	171	33.2	-12.4
5	193.98	18.8 QP	43.5	-24.7	1.00 H	76	34.4	-15.6
6	344.52	21.0 QP	46.0	-25.0	1.00 H	244	31.9	-10.9

#### Remarks:

1. Emission Level(dBuV/m) = Raw Value(dBuV) + Correction Factor(dB/m)
2. Correction Factor(dB/m) = Antenna Factor(dB/m) + Cable Factor(dB) – Pre-Amplifier Factor(dB)
3. Margin value = Emission Level – Limit value
4. The other emission levels were very low against the limit of frequency range 30 MHz ~ 1 GHz.
5. The emission levels were very low against the limit of frequency range 9 kHz ~ 30 MHz: the amplitude of spurious emissions attenuated more than 20 dB below the permissible value to be report.

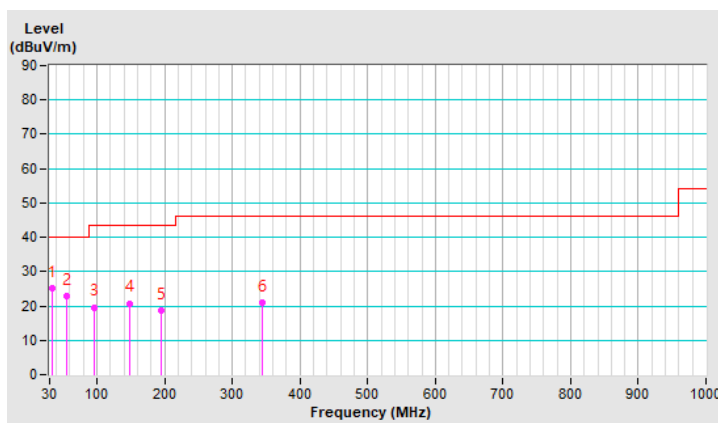

RF Mode	BT GFSK	Channel	CH 0 : 2402 MHz
Frequency Range	9 kHz ~ 1 GHz	Detector Function & Bandwidth	(QP) RB = 120kHz
Input Power (System)	120 Vac, 60 Hz	Environmental Conditions	22°C, 66% RH
Tested By	Sampson Chen		

Antenna Polarity & Test Distance : Vertical at 3 m								
No	Frequency (MHz)	Emission Level (dBuV/m)	Limit (dBuV/m)	Margin (dB)	Antenna Height (m)	Table Angle (Degree)	Raw Value (dBuV)	Correction Factor (dB/m)
1	34.39	31.7 QP	40.0	-8.3	1.00 V	1	45.1	-13.4
2	<b>42.63</b>	<b>33.3 QP</b>	<b>40.0</b>	<b>-6.7</b>	<b>1.00 V</b>	<b>107</b>	<b>45.9</b>	<b>-12.6</b>
3	54.93	32.9 QP	40.0	-7.1	1.00 V	219	45.4	-12.5
4	148.51	19.5 QP	43.5	-24.0	1.00 V	153	31.9	-12.4
5	350.00	20.6 QP	46.0	-25.4	1.50 V	239	31.5	-10.9
6	576.81	25.4 QP	46.0	-20.6	3.00 V	360	30.9	-5.5

**Remarks:**

1. Emission Level(dBuV/m) = Raw Value(dBuV) + Correction Factor(dB/m)
2. Correction Factor(dB/m) = Antenna Factor(dB/m) + Cable Factor(dB) – Pre-Amplifier Factor(dB)
3. Margin value = Emission Level – Limit value
4. The other emission levels were very low against the limit of frequency range 30 MHz ~ 1 GHz.
5. The emission levels were very low against the limit of frequency range 9 kHz ~ 30 MHz: the amplitude of spurious emissions attenuated more than 20 dB below the permissible value to be report.

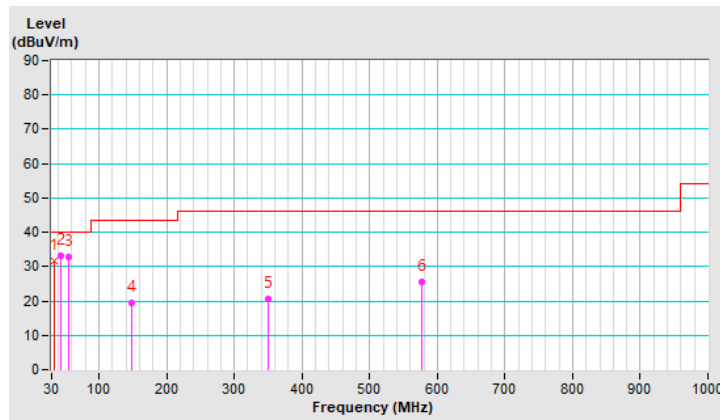

<b>RF Mode</b>	LIGHTSPEED GFSK	<b>Channel</b>	CH 0 : 2402 MHz
<b>Frequency Range</b>	9 kHz ~ 1 GHz	<b>Detector Function &amp; Bandwidth</b>	(QP) RB = 120kHz
<b>Input Power (System)</b>	120 Vac, 60 Hz	<b>Environmental Conditions</b>	22°C, 66% RH
<b>Tested By</b>	Sampson Chen		

Antenna Polarity & Test Distance : Horizontal at 3 m								
No	Frequency (MHz)	Emission Level (dBuV/m)	Limit (dBuV/m)	Margin (dB)	Antenna Height (m)	Table Angle (Degree)	Raw Value (dBuV)	Correction Factor (dB/m)
1	33.97	25.9 QP	40.0	-14.1	2.00 H	211	39.4	-13.5
2	56.07	23.8 QP	40.0	-16.2	3.00 H	276	36.1	-12.3
3	96.67	21.1 QP	43.5	-22.4	3.00 H	277	39.0	-17.9
4	150.64	20.4 QP	43.5	-23.1	3.00 H	157	32.7	-12.3
5	194.65	18.9 QP	43.5	-24.6	1.00 H	56	34.5	-15.6
6	340.68	21.1 QP	46.0	-24.9	1.00 H	249	32.0	-10.9

**Remarks:**

1. Emission Level(dBuV/m) = Raw Value(dBuV) + Correction Factor(dB/m)
2. Correction Factor(dB/m) = Antenna Factor(dB/m) + Cable Factor(dB) – Pre-Amplifier Factor(dB)
3. Margin value = Emission Level – Limit value
4. The other emission levels were very low against the limit of frequency range 30 MHz ~ 1 GHz.
5. The emission levels were very low against the limit of frequency range 9 kHz ~ 30 MHz: the amplitude of spurious emissions attenuated more than 20 dB below the permissible value to be report.

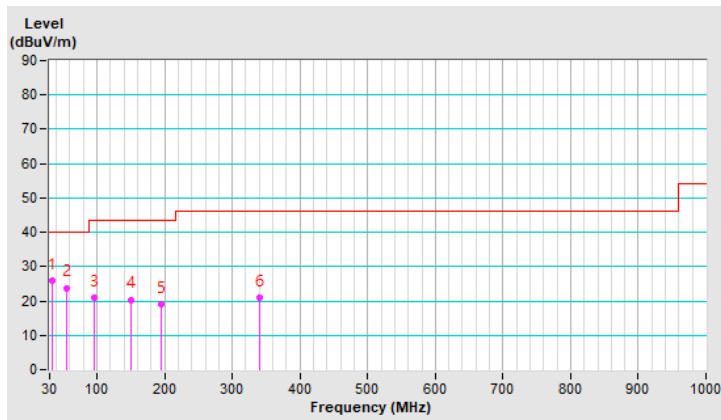

RF Mode	LIGHTSPEED GFSK	Channel	CH 0 : 2402 MHz
Frequency Range	9 kHz ~ 1 GHz	Detector Function & Bandwidth	(QP) RB = 120kHz
Input Power (System)	120 Vac, 60 Hz	Environmental Conditions	22°C, 66% RH
Tested By	Sampson Chen		

Antenna Polarity & Test Distance : Vertical at 3 m								
No	Frequency (MHz)	Emission Level (dBuV/m)	Limit (dBuV/m)	Margin (dB)	Antenna Height (m)	Table Angle (Degree)	Raw Value (dBuV)	Correction Factor (dB/m)
1	35.56	32.3 QP	40.0	-7.7	1.00 V	70	45.8	-13.5
2	41.05	33.1 QP	40.0	-6.9	1.00 V	151	45.7	-12.6
3	55.97	33.0 QP	40.0	-7.0	1.00 V	259	45.3	-12.3
4	149.65	19.3 QP	43.5	-24.2	1.00 V	123	31.6	-12.3
5	349.89	21.2 QP	46.0	-24.8	1.50 V	230	32.1	-10.9
6	577.65	25.9 QP	46.0	-20.1	3.00 V	318	31.4	-5.5

**Remarks:**

1. Emission Level(dBuV/m) = Raw Value(dBuV) + Correction Factor(dB/m)
2. Correction Factor(dB/m) = Antenna Factor(dB/m) + Cable Factor(dB) – Pre-Amplifier Factor(dB)
3. Margin value = Emission Level – Limit value
4. The other emission levels were very low against the limit of frequency range 30 MHz ~ 1 GHz.
5. The emission levels were very low against the limit of frequency range 9 kHz ~ 30 MHz: the amplitude of spurious emissions attenuated more than 20 dB below the permissible value to be report.

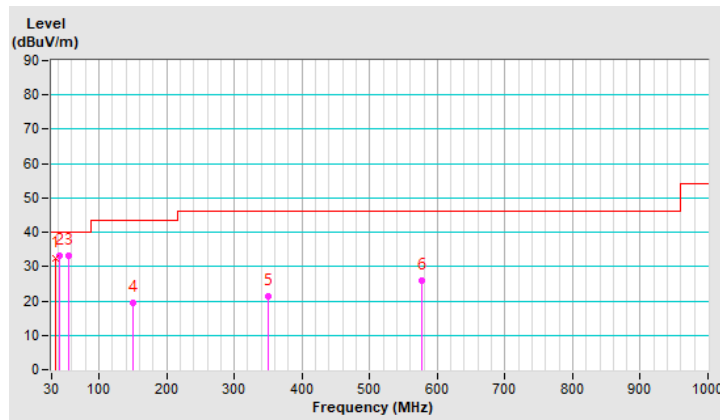



### 7.9 Unwanted Emissions above 1 GHz

<b>RF Mode</b>	BT GFSK	<b>Channel</b>	CH 0 : 2402 MHz
<b>Frequency Range</b>	1 GHz ~ 25 GHz	<b>Detector Function &amp; Bandwidth</b>	(PK) RB = 1 MHz, VB = 3 MHz (AV) RB = 1 MHz, VB = 3 MHz
<b>Input Power (System)</b>	120 Vac, 60 Hz	<b>Environmental Conditions</b>	25°C, 75% RH
<b>Tested By</b>	Sampson Chen		

Antenna Polarity & Test Distance : Horizontal at 3 m								
No	Frequency (MHz)	Emission Level (dBuV/m)	Limit (dBuV/m)	Margin (dB)	Antenna Height (m)	Table Angle (Degree)	Raw Value (dBuV)	Correction Factor (dB/m)
1	2390.00	56.3 PK	74.0	-17.7	1.46 H	3	57.1	-0.8
2	2390.00	45.6 AV	54.0	-8.4	1.46 H	3	46.4	-0.8
3	*2402.00	107.2 PK			1.46 H	3	108.0	-0.8
4	*2402.00	77.8 AV			1.46 H	3	78.6	-0.8
5	4804.00	41.8 PK	74.0	-32.2	1.20 H	175	36.8	5.0
6	4804.00	12.4 AV	54.0	-41.6	1.20 H	175	7.4	5.0

**Remarks:**

1. Emission Level(dBuV/m) = Raw Value(dBuV) + Correction Factor(dB/m)
2. Correction Factor(dB/m) = Antenna Factor(dB/m) + Cable Factor(dB) – Pre-Amplifier Factor(dB)
3. Margin value = Emission Level – Limit value
4. The other emission levels were very low against the limit.
5. " \* " : Fundamental frequency, the limit was restricted at the RF Output Power.
6. The average value of fundamental and harmonic frequency is: Average = Peak value + 20 log(Duty cycle) Where the duty cycle correction factor is calculated from following formula:  
 $20 \log(\text{Duty cycle}) = 20 \log(3.4 \text{ ms} / 100 \text{ ms}) = -29.4 \text{ dB}$

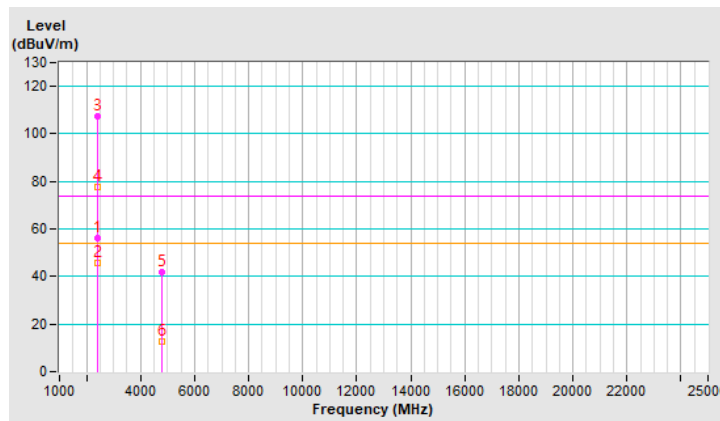

<b>RF Mode</b>	BT GFSK	<b>Channel</b>	CH 0 : 2402 MHz
<b>Frequency Range</b>	1 GHz ~ 25 GHz	<b>Detector Function &amp; Bandwidth</b>	(PK) RB = 1 MHz, VB = 3 MHz (AV) RB = 1 MHz, VB = 3 MHz
<b>Input Power (System)</b>	120 Vac, 60 Hz	<b>Environmental Conditions</b>	25°C, 75% RH
<b>Tested By</b>	Sampson Chen		

Antenna Polarity & Test Distance : Vertical at 3 m								
No	Frequency (MHz)	Emission Level (dBuV/m)	Limit (dBuV/m)	Margin (dB)	Antenna Height (m)	Table Angle (Degree)	Raw Value (dBuV)	Correction Factor (dB/m)
1	2390.00	55.0 PK	74.0	-19.0	1.01 V	22	55.8	-0.8
2	2390.00	45.7 AV	54.0	-8.3	1.01 V	22	46.5	-0.8
3	*2402.00	105.0 PK			1.01 V	22	105.8	-0.8
4	*2402.00	75.6 AV			1.01 V	22	76.4	-0.8
5	4804.00	40.7 PK	74.0	-33.3	1.16 V	318	35.7	5.0
6	4804.00	11.3 AV	54.0	-42.7	1.16 V	318	6.3	5.0

**Remarks:**

- Emission Level(dBuV/m) = Raw Value(dBuV) + Correction Factor(dB/m)
- Correction Factor(dB/m) = Antenna Factor(dB/m) + Cable Factor(dB) – Pre-Amplifier Factor(dB)
- Margin value = Emission Level – Limit value
- The other emission levels were very low against the limit.
- " \* ": Fundamental frequency, the limit was restricted at the RF Output Power.
- The average value of fundamental and harmonic frequency is: Average = Peak value + 20 log(Duty cycle) Where the duty cycle correction factor is calculated from following formula:  
 $20 \log(\text{Duty cycle}) = 20 \log(3.4 \text{ ms} / 100 \text{ ms}) = -29.4 \text{ dB}$

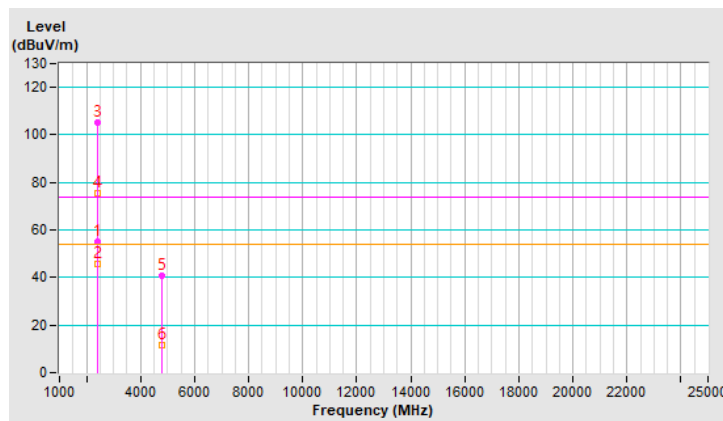

<b>RF Mode</b>	BT GFSK	<b>Channel</b>	CH 39 : 2441 MHz
<b>Frequency Range</b>	1 GHz ~ 25 GHz	<b>Detector Function &amp; Bandwidth</b>	(PK) RB = 1 MHz, VB = 3 MHz (AV) RB = 1 MHz, VB = 3 MHz
<b>Input Power (System)</b>	120 Vac, 60 Hz	<b>Environmental Conditions</b>	25°C, 75% RH
<b>Tested By</b>	Sampson Chen		

Antenna Polarity & Test Distance : Horizontal at 3 m								
No	Frequency (MHz)	Emission Level (dBuV/m)	Limit (dBuV/m)	Margin (dB)	Antenna Height (m)	Table Angle (Degree)	Raw Value (dBuV)	Correction Factor (dB/m)
1	*2441.00	106.2 PK			1.54 H	8	107.0	-0.8
2	*2441.00	76.8 AV			1.54 H	8	77.6	-0.8
3	4882.00	42.4 PK	74.0	-31.6	1.16 H	169	37.3	5.1
4	4882.00	13.0 AV	54.0	-41.0	1.16 H	169	7.9	5.1
5	7323.00	46.0 PK	74.0	-28.0	1.29 H	82	34.8	11.2
6	7323.00	16.6 AV	54.0	-37.4	1.29 H	82	5.4	11.2

**Remarks:**

1. Emission Level(dBuV/m) = Raw Value(dBuV) + Correction Factor(dB/m)
2. Correction Factor(dB/m) = Antenna Factor(dB/m) + Cable Factor(dB) – Pre-Amplifier Factor(dB)
3. Margin value = Emission Level – Limit value
4. The other emission levels were very low against the limit.
5. " \* ": Fundamental frequency, the limit was restricted at the RF Output Power.
6. The average value of fundamental and harmonic frequency is: Average = Peak value + 20 log(Duty cycle) Where the duty cycle correction factor is calculated from following formula:  
 $20 \log(\text{Duty cycle}) = 20 \log(3.4 \text{ ms} / 100 \text{ ms}) = -29.4 \text{ dB}$

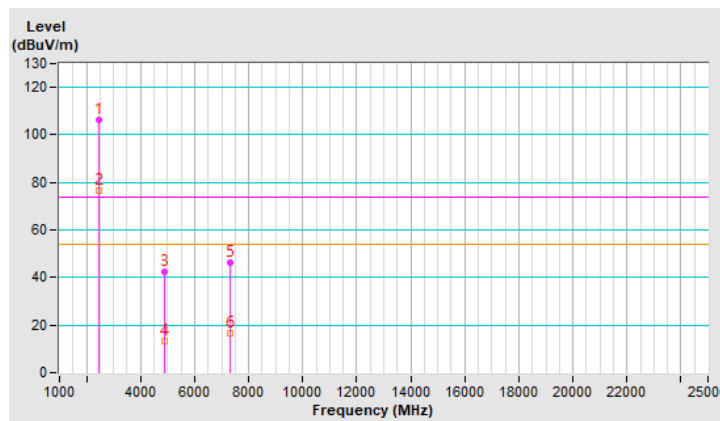

<b>RF Mode</b>	BT GFSK	<b>Channel</b>	CH 39 : 2441 MHz
<b>Frequency Range</b>	1 GHz ~ 25 GHz	<b>Detector Function &amp; Bandwidth</b>	(PK) RB = 1 MHz, VB = 3 MHz (AV) RB = 1 MHz, VB = 3 MHz
<b>Input Power (System)</b>	120 Vac, 60 Hz	<b>Environmental Conditions</b>	25°C, 75% RH
<b>Tested By</b>	Sampson Chen		

Antenna Polarity & Test Distance : Vertical at 3 m								
No	Frequency (MHz)	Emission Level (dBuV/m)	Limit (dBuV/m)	Margin (dB)	Antenna Height (m)	Table Angle (Degree)	Raw Value (dBuV)	Correction Factor (dB/m)
1	*2441.00	104.3 PK			1.29 V	10	105.1	-0.8
2	*2441.00	74.9 AV			1.29 V	10	75.7	-0.8
3	4882.00	41.3 PK	74.0	-32.7	1.22 V	321	36.2	5.1
4	4882.00	11.9 AV	54.0	-42.1	1.22 V	321	6.8	5.1
5	7323.00	44.8 PK	74.0	-29.2	2.51 V	274	33.6	11.2
6	7323.00	15.4 AV	54.0	-38.6	2.51 V	274	4.2	11.2

**Remarks:**

1. Emission Level(dBuV/m) = Raw Value(dBuV) + Correction Factor(dB/m)
2. Correction Factor(dB/m) = Antenna Factor(dB/m) + Cable Factor(dB) – Pre-Amplifier Factor(dB)
3. Margin value = Emission Level – Limit value
4. The other emission levels were very low against the limit.
5. " \* ": Fundamental frequency, the limit was restricted at the RF Output Power.
6. The average value of fundamental and harmonic frequency is: Average = Peak value + 20 log(Duty cycle) Where the duty cycle correction factor is calculated from following formula:  
 $20 \log(\text{Duty cycle}) = 20 \log(3.4 \text{ ms} / 100 \text{ ms}) = -29.4 \text{ dB}$

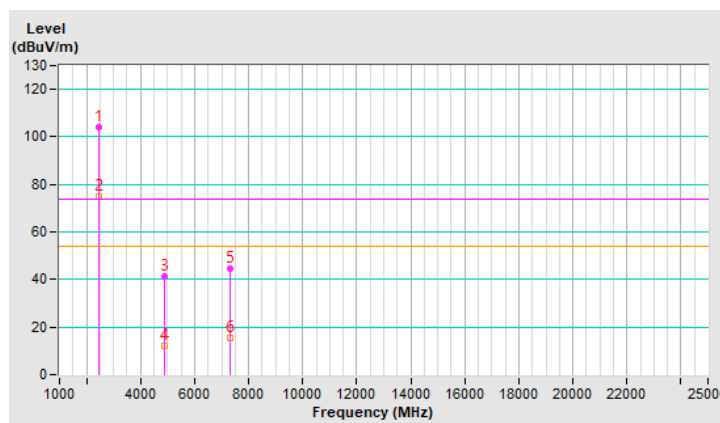

<b>RF Mode</b>	BT GFSK	<b>Channel</b>	CH 78 : 2480 MHz
<b>Frequency Range</b>	1 GHz ~ 25 GHz	<b>Detector Function &amp; Bandwidth</b>	(PK) RB = 1 MHz, VB = 3 MHz (AV) RB = 1 MHz, VB = 3 MHz
<b>Input Power (System)</b>	120 Vac, 60 Hz	<b>Environmental Conditions</b>	25°C, 75% RH
<b>Tested By</b>	Sampson Chen		

Antenna Polarity & Test Distance : Horizontal at 3 m								
No	Frequency (MHz)	Emission Level (dBuV/m)	Limit (dBuV/m)	Margin (dB)	Antenna Height (m)	Table Angle (Degree)	Raw Value (dBuV)	Correction Factor (dB/m)
1	*2480.00	105.7 PK			1.75 H	165	106.4	-0.7
2	*2480.00	76.3 AV			1.75 H	165	77.0	-0.7
3	2483.50	54.9 PK	74.0	-19.1	1.75 H	165	55.7	-0.8
4	2483.50	45.4 AV	54.0	-8.6	1.75 H	165	46.2	-0.8
5	4960.00	41.8 PK	74.0	-32.2	1.19 H	167	36.8	5.0
6	4960.00	12.4 AV	54.0	-41.6	1.19 H	167	7.4	5.0
7	7440.00	45.6 PK	74.0	-28.4	1.31 H	96	34.0	11.6
8	7440.00	16.2 AV	54.0	-37.8	1.31 H	96	4.6	11.6

**Remarks:**

1. Emission Level(dBuV/m) = Raw Value(dBuV) + Correction Factor(dB/m)
2. Correction Factor(dB/m) = Antenna Factor(dB/m) + Cable Factor(dB) – Pre-Amplifier Factor(dB)
3. Margin value = Emission Level – Limit value
4. The other emission levels were very low against the limit.
5. " \* ": Fundamental frequency, the limit was restricted at the RF Output Power.
6. The average value of fundamental and harmonic frequency is: Average = Peak value + 20 log(Duty cycle) Where the duty cycle correction factor is calculated from following formula:  
 $20 \log(\text{Duty cycle}) = 20 \log(3.4 \text{ ms} / 100 \text{ ms}) = -29.4 \text{ dB}$

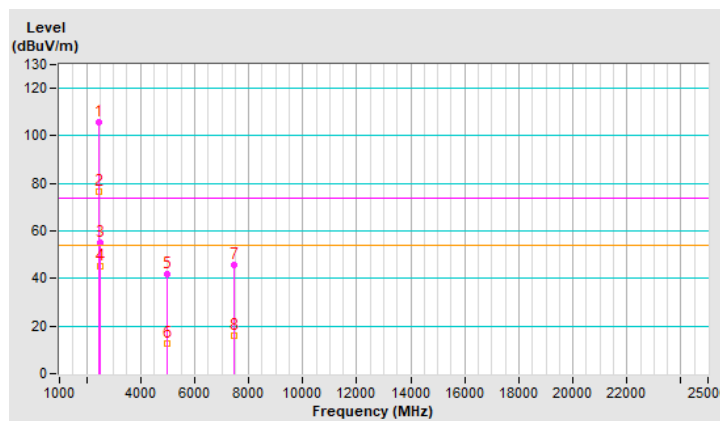

<b>RF Mode</b>	BT GFSK	<b>Channel</b>	CH 78 : 2480 MHz
<b>Frequency Range</b>	1 GHz ~ 25 GHz	<b>Detector Function &amp; Bandwidth</b>	(PK) RB = 1 MHz, VB = 3 MHz (AV) RB = 1 MHz, VB = 3 MHz
<b>Input Power (System)</b>	120 Vac, 60 Hz	<b>Environmental Conditions</b>	25°C, 75% RH
<b>Tested By</b>	Sampson Chen		

Antenna Polarity & Test Distance : Vertical at 3 m								
No	Frequency (MHz)	Emission Level (dBuV/m)	Limit (dBuV/m)	Margin (dB)	Antenna Height (m)	Table Angle (Degree)	Raw Value (dBuV)	Correction Factor (dB/m)
1	*2480.00	102.4 PK			1.64 V	38	103.1	-0.7
2	*2480.00	73.0 AV			1.64 V	38	73.7	-0.7
3	2483.50	55.1 PK	74.0	-18.9	1.64 V	38	55.9	-0.8
4	2483.50	25.7 AV	54.0	-28.3	1.64 V	38	26.5	-0.8
5	4960.00	40.9 PK	74.0	-33.1	1.17 V	311	35.9	5.0
6	4960.00	11.5 AV	54.0	-42.5	1.17 V	311	6.5	5.0
7	7440.00	45.2 PK	74.0	-28.8	2.50 V	267	33.6	11.6
8	7440.00	15.8 AV	54.0	-38.2	2.50 V	267	4.2	11.6

**Remarks:**

1. Emission Level(dBuV/m) = Raw Value(dBuV) + Correction Factor(dB/m)
2. Correction Factor(dB/m) = Antenna Factor(dB/m) + Cable Factor(dB) – Pre-Amplifier Factor(dB)
3. Margin value = Emission Level – Limit value
4. The other emission levels were very low against the limit.
5. " \* ": Fundamental frequency, the limit was restricted at the RF Output Power.
6. The average value of fundamental and harmonic frequency is: Average = Peak value + 20 log(Duty cycle) Where the duty cycle correction factor is calculated from following formula:  
 $20 \log(\text{Duty cycle}) = 20 \log(3.4 \text{ ms} / 100 \text{ ms}) = -29.4 \text{ dB}$

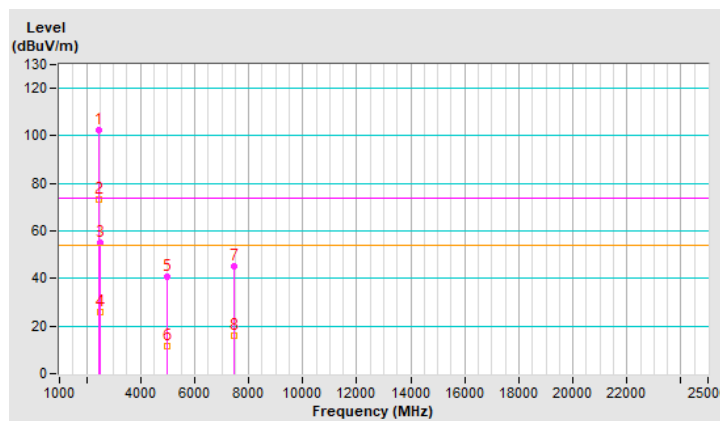

<b>RF Mode</b>	BT 8DPSK	<b>Channel</b>	CH 0 : 2402 MHz
<b>Frequency Range</b>	1 GHz ~ 25 GHz	<b>Detector Function &amp; Bandwidth</b>	(PK) RB = 1 MHz, VB = 3 MHz (AV) RB = 1 MHz, VB = 3 MHz
<b>Input Power (System)</b>	120 Vac, 60 Hz	<b>Environmental Conditions</b>	25°C, 75% RH
<b>Tested By</b>	Sampson Chen		

Antenna Polarity & Test Distance : Horizontal at 3 m								
No	Frequency (MHz)	Emission Level (dBuV/m)	Limit (dBuV/m)	Margin (dB)	Antenna Height (m)	Table Angle (Degree)	Raw Value (dBuV)	Correction Factor (dB/m)
1	2390.00	56.2 PK	74.0	-17.8	1.40 H	10	57.0	-0.8
2	2390.00	45.6 AV	54.0	-8.4	1.40 H	10	46.4	-0.8
3	*2402.00	106.9 PK			1.40 H	10	107.7	-0.8
4	*2402.00	76.7 AV			1.40 H	10	77.5	-0.8
5	4804.00	41.5 PK	74.0	-32.5	1.15 H	183	36.5	5.0
6	4804.00	11.3 AV	54.0	-42.7	1.15 H	183	6.3	5.0

**Remarks:**

1. Emission Level(dBuV/m) = Raw Value(dBuV) + Correction Factor(dB/m)
2. Correction Factor(dB/m) = Antenna Factor(dB/m) + Cable Factor(dB) – Pre-Amplifier Factor(dB)
3. Margin value = Emission Level – Limit value
4. The other emission levels were very low against the limit.
5. " \* " : Fundamental frequency, the limit was restricted at the RF Output Power.
6. The average value of fundamental and harmonic frequency is: Average = Peak value + 20 log(Duty cycle) Where the duty cycle correction factor is calculated from following formula:  
 $20 \log(\text{Duty cycle}) = 20 \log(3.1 \text{ ms} / 100 \text{ ms}) = -30.2 \text{ dB}$

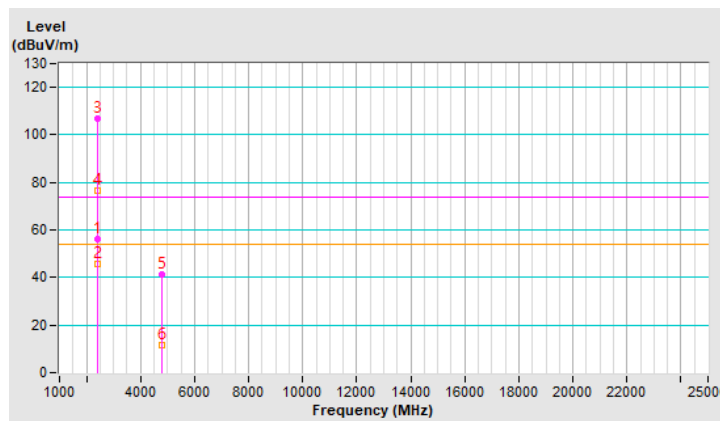

<b>RF Mode</b>	BT 8DPSK	<b>Channel</b>	CH 0 : 2402 MHz
<b>Frequency Range</b>	1 GHz ~ 25 GHz	<b>Detector Function &amp; Bandwidth</b>	(PK) RB = 1 MHz, VB = 3 MHz (AV) RB = 1 MHz, VB = 3 MHz
<b>Input Power (System)</b>	120 Vac, 60 Hz	<b>Environmental Conditions</b>	25°C, 75% RH
<b>Tested By</b>	Sampson Chen		

Antenna Polarity & Test Distance : Vertical at 3 m								
No	Frequency (MHz)	Emission Level (dBuV/m)	Limit (dBuV/m)	Margin (dB)	Antenna Height (m)	Table Angle (Degree)	Raw Value (dBuV)	Correction Factor (dB/m)
1	2390.00	54.7 PK	74.0	-19.3	1.12 V	27	55.5	-0.8
2	2390.00	45.8 AV	54.0	-8.2	1.12 V	27	46.6	-0.8
3	*2402.00	104.9 PK			1.12 V	27	105.7	-0.8
4	*2402.00	74.7 AV			1.12 V	27	75.5	-0.8
5	4804.00	41.6 PK	74.0	-32.4	1.14 V	319	36.6	5.0
6	4804.00	11.4 AV	54.0	-42.6	1.14 V	319	6.4	5.0

**Remarks:**

1. Emission Level(dBuV/m) = Raw Value(dBuV) + Correction Factor(dB/m)
2. Correction Factor(dB/m) = Antenna Factor(dB/m) + Cable Factor(dB) – Pre-Amplifier Factor(dB)
3. Margin value = Emission Level – Limit value
4. The other emission levels were very low against the limit.
5. " \* " : Fundamental frequency, the limit was restricted at the RF Output Power.
6. The average value of fundamental and harmonic frequency is: Average = Peak value + 20 log(Duty cycle) Where the duty cycle correction factor is calculated from following formula:  
 $20 \log(\text{Duty cycle}) = 20 \log(3.1 \text{ ms} / 100 \text{ ms}) = -30.2 \text{ dB}$

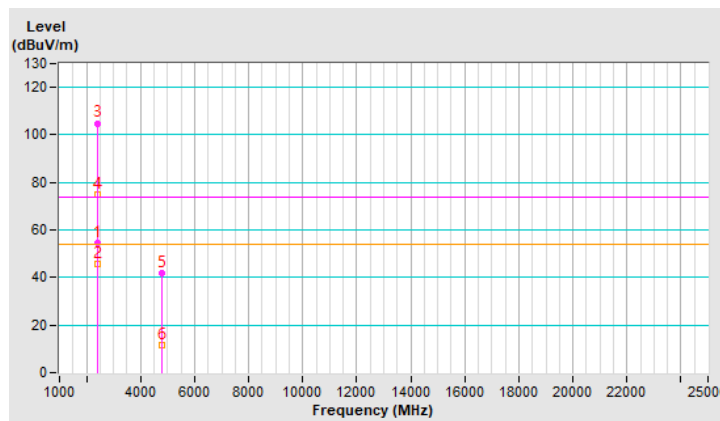



<b>RF Mode</b>	BT 8DPSK	<b>Channel</b>	CH 39 : 2441 MHz
<b>Frequency Range</b>	1 GHz ~ 25 GHz	<b>Detector Function &amp; Bandwidth</b>	(PK) RB = 1 MHz, VB = 3 MHz (AV) RB = 1 MHz, VB = 3 MHz
<b>Input Power (System)</b>	120 Vac, 60 Hz	<b>Environmental Conditions</b>	25°C, 75% RH
<b>Tested By</b>	Sampson Chen		

Antenna Polarity & Test Distance : Horizontal at 3 m								
No	Frequency (MHz)	Emission Level (dBuV/m)	Limit (dBuV/m)	Margin (dB)	Antenna Height (m)	Table Angle (Degree)	Raw Value (dBuV)	Correction Factor (dB/m)
1	*2441.00	105.9 PK			1.52 H	154	106.7	-0.8
2	*2441.00	75.7 AV			1.52 H	154	76.5	-0.8
3	4882.00	41.4 PK	74.0	-32.6	1.22 H	181	36.3	5.1
4	4882.00	11.2 AV	54.0	-42.8	1.22 H	181	6.1	5.1
5	7323.00	45.9 PK	74.0	-28.1	1.36 H	85	34.7	11.2
6	7323.00	15.7 AV	54.0	-38.3	1.36 H	85	4.5	11.2

**Remarks:**

1. Emission Level(dBuV/m) = Raw Value(dBuV) + Correction Factor(dB/m)
2. Correction Factor(dB/m) = Antenna Factor(dB/m) + Cable Factor(dB) – Pre-Amplifier Factor(dB)
3. Margin value = Emission Level – Limit value
4. The other emission levels were very low against the limit.
5. " \* " : Fundamental frequency, the limit was restricted at the RF Output Power.
6. The average value of fundamental and harmonic frequency is: Average = Peak value + 20 log(Duty cycle) Where the duty cycle correction factor is calculated from following formula:  
 $20 \log(\text{Duty cycle}) = 20 \log(3.1 \text{ ms} / 100 \text{ ms}) = -30.2 \text{ dB}$

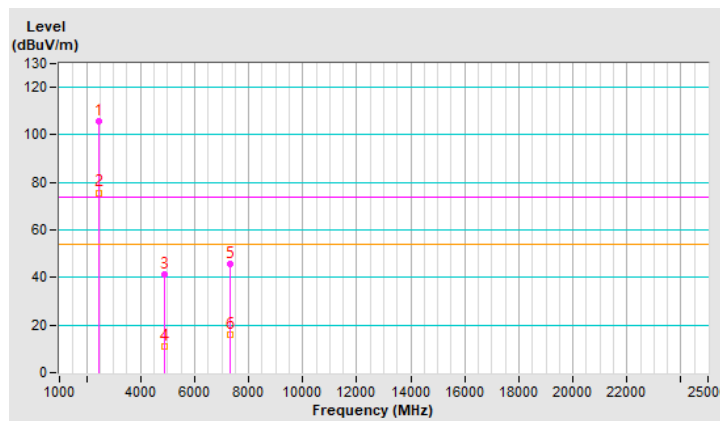

<b>RF Mode</b>	BT 8DPSK	<b>Channel</b>	CH 39 : 2441 MHz
<b>Frequency Range</b>	1 GHz ~ 25 GHz	<b>Detector Function &amp; Bandwidth</b>	(PK) RB = 1 MHz, VB = 3 MHz (AV) RB = 1 MHz, VB = 3 MHz
<b>Input Power (System)</b>	120 Vac, 60 Hz	<b>Environmental Conditions</b>	25°C, 75% RH
<b>Tested By</b>	Sampson Chen		

Antenna Polarity & Test Distance : Vertical at 3 m								
No	Frequency (MHz)	Emission Level (dBuV/m)	Limit (dBuV/m)	Margin (dB)	Antenna Height (m)	Table Angle (Degree)	Raw Value (dBuV)	Correction Factor (dB/m)
1	*2441.00	103.1 PK			1.33 V	15	103.9	-0.8
2	*2441.00	72.9 AV			1.33 V	15	73.7	-0.8
3	4882.00	40.7 PK	74.0	-33.3	1.13 V	325	35.6	5.1
4	4882.00	10.5 AV	54.0	-43.5	1.13 V	325	5.4	5.1
5	7323.00	45.4 PK	74.0	-28.6	2.46 V	275	34.2	11.2
6	7323.00	15.2 AV	54.0	-38.8	2.46 V	275	4.0	11.2

**Remarks:**

1. Emission Level(dBuV/m) = Raw Value(dBuV) + Correction Factor(dB/m)
2. Correction Factor(dB/m) = Antenna Factor(dB/m) + Cable Factor(dB) – Pre-Amplifier Factor(dB)
3. Margin value = Emission Level – Limit value
4. The other emission levels were very low against the limit.
5. " \* " : Fundamental frequency, the limit was restricted at the RF Output Power.
6. The average value of fundamental and harmonic frequency is: Average = Peak value + 20 log(Duty cycle) Where the duty cycle correction factor is calculated from following formula:  
 $20 \log(\text{Duty cycle}) = 20 \log(3.1 \text{ ms} / 100 \text{ ms}) = -30.2 \text{ dB}$

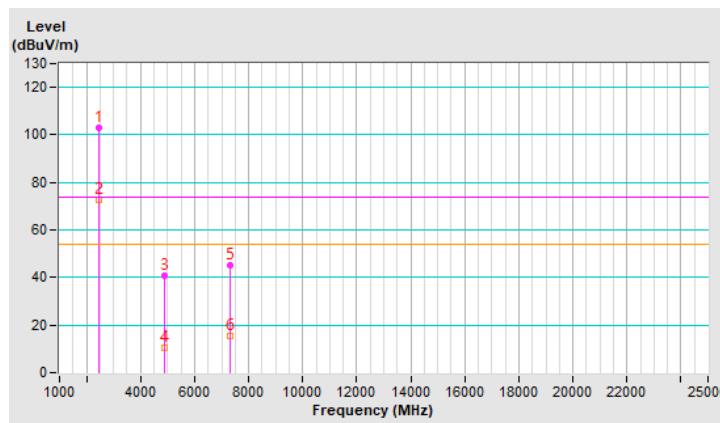

<b>RF Mode</b>	BT 8DPSK	<b>Channel</b>	CH 78 : 2480 MHz
<b>Frequency Range</b>	1 GHz ~ 25 GHz	<b>Detector Function &amp; Bandwidth</b>	(PK) RB = 1 MHz, VB = 3 MHz (AV) RB = 1 MHz, VB = 3 MHz
<b>Input Power (System)</b>	120 Vac, 60 Hz	<b>Environmental Conditions</b>	25°C, 75% RH
<b>Tested By</b>	Sampson Chen		

Antenna Polarity & Test Distance : Horizontal at 3 m								
No	Frequency (MHz)	Emission Level (dBuV/m)	Limit (dBuV/m)	Margin (dB)	Antenna Height (m)	Table Angle (Degree)	Raw Value (dBuV)	Correction Factor (dB/m)
1	*2480.00	105.3 PK			1.72 H	166	106.0	-0.7
2	*2480.00	75.1 AV			1.72 H	166	75.8	-0.7
3	2483.50	55.0 PK	74.0	-19.0	1.72 H	166	55.8	-0.8
<b>4</b>	<b>2483.50</b>	<b>46.4 AV</b>	<b>54.0</b>	<b>-7.6</b>	<b>1.72 H</b>	<b>166</b>	<b>47.2</b>	<b>-0.8</b>
5	4960.00	41.7 PK	74.0	-32.3	1.20 H	176	36.7	5.0
6	4960.00	11.5 AV	54.0	-42.5	1.20 H	176	6.5	5.0
7	7440.00	45.3 PK	74.0	-28.7	1.31 H	97	33.7	11.6
8	7440.00	15.1 AV	54.0	-38.9	1.31 H	97	3.5	11.6

**Remarks:**

1. Emission Level(dBuV/m) = Raw Value(dBuV) + Correction Factor(dB/m)
2. Correction Factor(dB/m) = Antenna Factor(dB/m) + Cable Factor(dB) – Pre-Amplifier Factor(dB)
3. Margin value = Emission Level – Limit value
4. The other emission levels were very low against the limit.
5. " \* ": Fundamental frequency, the limit was restricted at the RF Output Power.
6. The average value of fundamental and harmonic frequency is: Average = Peak value + 20 log(Duty cycle) Where the duty cycle correction factor is calculated from following formula:  
 $20 \log(\text{Duty cycle}) = 20 \log(3.1 \text{ ms} / 100 \text{ ms}) = -30.2 \text{ dB}$

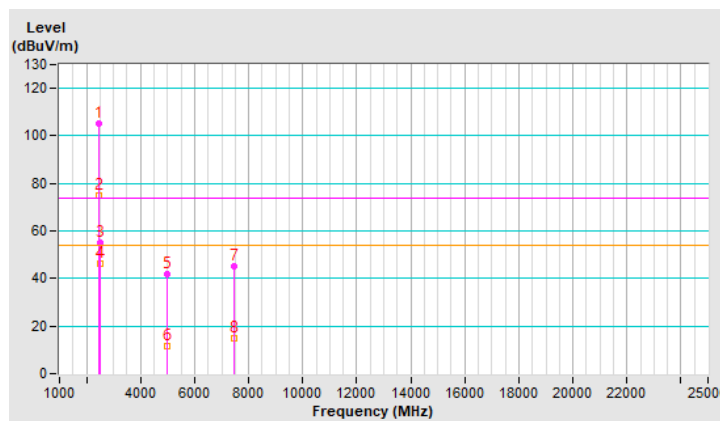

<b>RF Mode</b>	BT 8DPSK	<b>Channel</b>	CH 78 : 2480 MHz
<b>Frequency Range</b>	1 GHz ~ 25 GHz	<b>Detector Function &amp; Bandwidth</b>	(PK) RB = 1 MHz, VB = 3 MHz (AV) RB = 1 MHz, VB = 3 MHz
<b>Input Power (System)</b>	120 Vac, 60 Hz	<b>Environmental Conditions</b>	25°C, 75% RH
<b>Tested By</b>	Sampson Chen		

Antenna Polarity & Test Distance : Vertical at 3 m								
No	Frequency (MHz)	Emission Level (dBuV/m)	Limit (dBuV/m)	Margin (dB)	Antenna Height (m)	Table Angle (Degree)	Raw Value (dBuV)	Correction Factor (dB/m)
1	*2480.00	101.8 PK			1.58 V	40	102.5	-0.7
2	*2480.00	71.6 AV			1.58 V	40	72.3	-0.7
3	2483.50	55.0 PK	74.0	-19.0	1.58 V	40	55.8	-0.8
4	2483.50	45.8 AV	54.0	-8.2	1.58 V	40	46.6	-0.8
5	4960.00	40.4 PK	74.0	-33.6	1.17 V	319	35.4	5.0
6	4960.00	10.2 AV	54.0	-43.8	1.17 V	319	5.2	5.0
7	7440.00	45.7 PK	74.0	-28.3	2.48 V	274	34.1	11.6
8	7440.00	15.5 AV	54.0	-38.5	2.48 V	274	3.9	11.6

**Remarks:**

1. Emission Level(dBuV/m) = Raw Value(dBuV) + Correction Factor(dB/m)
2. Correction Factor(dB/m) = Antenna Factor(dB/m) + Cable Factor(dB) – Pre-Amplifier Factor(dB)
3. Margin value = Emission Level – Limit value
4. The other emission levels were very low against the limit.
5. " \* ": Fundamental frequency, the limit was restricted at the RF Output Power.
6. The average value of fundamental and harmonic frequency is: Average = Peak value + 20 log(Duty cycle) Where the duty cycle correction factor is calculated from following formula:  
 $20 \log(\text{Duty cycle}) = 20 \log(3.1 \text{ ms} / 100 \text{ ms}) = -30.2 \text{ dB}$

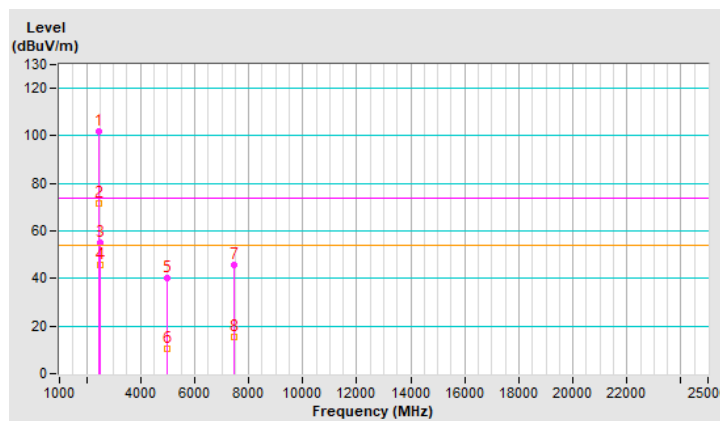

<b>RF Mode</b>	LIGHTSPEED GFSK	<b>Channel</b>	CH 0 : 2402 MHz
<b>Frequency Range</b>	1 GHz ~ 25 GHz	<b>Detector Function &amp; Bandwidth</b>	(PK) RB = 1 MHz, VB = 3 MHz (AV) RB = 1 MHz, VB = 3 MHz
<b>Input Power (System)</b>	120 Vac, 60 Hz	<b>Environmental Conditions</b>	25°C, 75% RH
<b>Tested By</b>	Sampson Chen		

Antenna Polarity & Test Distance : Horizontal at 3 m								
No	Frequency (MHz)	Emission Level (dBuV/m)	Limit (dBuV/m)	Margin (dB)	Antenna Height (m)	Table Angle (Degree)	Raw Value (dBuV)	Correction Factor (dB/m)
1	2390.00	54.8 PK	74.0	-19.2	1.49 H	11	55.6	-0.8
2	2390.00	45.3 AV	54.0	-8.7	1.49 H	11	46.1	-0.8
3	*2402.00	106.9 PK			1.49 H	11	107.7	-0.8
4	*2402.00	76.7 AV			1.49 H	11	77.5	-0.8
5	4804.00	42.3 PK	74.0	-31.7	1.11 H	178	37.3	5.0
6	4804.00	12.1 AV	54.0	-41.9	1.11 H	178	7.1	5.0

**Remarks:**

1. Emission Level(dBuV/m) = Raw Value(dBuV) + Correction Factor(dB/m)
2. Correction Factor(dB/m) = Antenna Factor(dB/m) + Cable Factor(dB) – Pre-Amplifier Factor(dB)
3. Margin value = Emission Level – Limit value
4. The other emission levels were very low against the limit.
5. " \* " : Fundamental frequency, the limit was restricted at the RF Output Power.
6. The average value of fundamental and harmonic frequency is: Average = Peak value + 20 log(Duty cycle) Where the duty cycle correction factor is calculated from following formula:  
 $20 \log(\text{Duty cycle}) = 20 \log(3.1 \text{ ms} / 100 \text{ ms}) = -30.2 \text{ dB}$

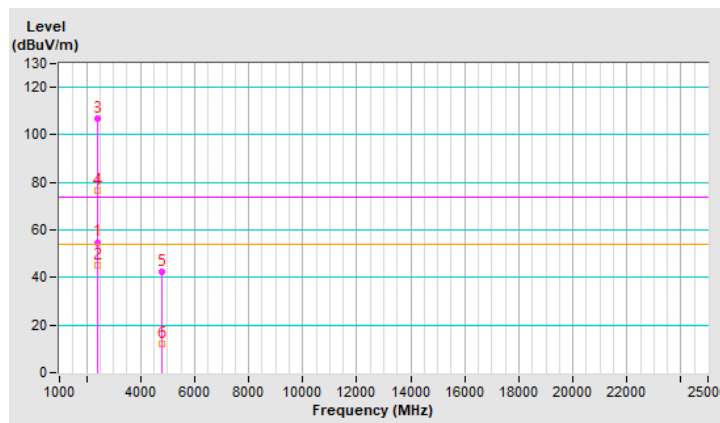

<b>RF Mode</b>	LIGHTSPEED GFSK	<b>Channel</b>	CH 0 : 2402 MHz
<b>Frequency Range</b>	1 GHz ~ 25 GHz	<b>Detector Function &amp; Bandwidth</b>	(PK) RB = 1 MHz, VB = 3 MHz (AV) RB = 1 MHz, VB = 3 MHz
<b>Input Power (System)</b>	120 Vac, 60 Hz	<b>Environmental Conditions</b>	25°C, 75% RH
<b>Tested By</b>	Sampson Chen		

Antenna Polarity & Test Distance : Vertical at 3 m								
No	Frequency (MHz)	Emission Level (dBuV/m)	Limit (dBuV/m)	Margin (dB)	Antenna Height (m)	Table Angle (Degree)	Raw Value (dBuV)	Correction Factor (dB/m)
1	2390.00	54.9 PK	74.0	-19.1	1.03 V	21	55.7	-0.8
2	2390.00	45.6 AV	54.0	-8.4	1.03 V	21	46.4	-0.8
3	*2402.00	104.8 PK			1.03 V	21	105.6	-0.8
4	*2402.00	74.6 AV			1.03 V	21	75.4	-0.8
5	4804.00	40.9 PK	74.0	-33.1	1.28 V	331	35.9	5.0
6	4804.00	10.7 AV	54.0	-43.3	1.28 V	331	5.7	5.0

**Remarks:**

1. Emission Level(dBuV/m) = Raw Value(dBuV) + Correction Factor(dB/m)
2. Correction Factor(dB/m) = Antenna Factor(dB/m) + Cable Factor(dB) – Pre-Amplifier Factor(dB)
3. Margin value = Emission Level – Limit value
4. The other emission levels were very low against the limit.
5. " \* ": Fundamental frequency, the limit was restricted at the RF Output Power.
6. The average value of fundamental and harmonic frequency is: Average = Peak value + 20 log(Duty cycle) Where the duty cycle correction factor is calculated from following formula:  
 $20 \log(\text{Duty cycle}) = 20 \log(3.1 \text{ ms} / 100 \text{ ms}) = -30.2 \text{ dB}$

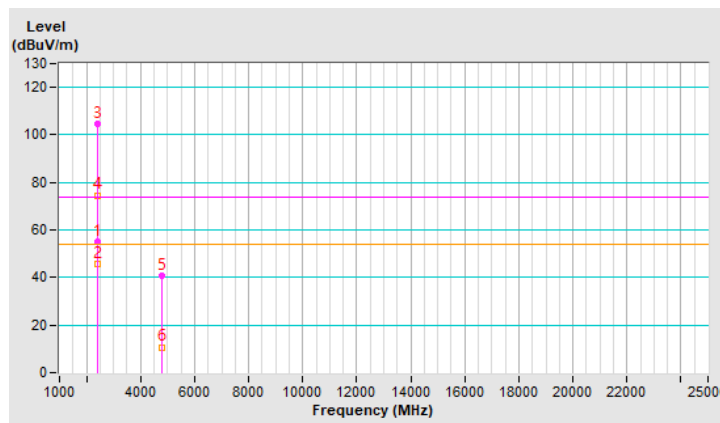

<b>RF Mode</b>	LIGHTSPEED GFSK	<b>Channel</b>	CH 39 : 2441 MHz
<b>Frequency Range</b>	1 GHz ~ 25 GHz	<b>Detector Function &amp; Bandwidth</b>	(PK) RB = 1 MHz, VB = 3 MHz (AV) RB = 1 MHz, VB = 3 MHz
<b>Input Power (System)</b>	120 Vac, 60 Hz	<b>Environmental Conditions</b>	25°C, 75% RH
<b>Tested By</b>	Sampson Chen		

**Antenna Polarity & Test Distance : Horizontal at 3 m**

No	Frequency (MHz)	Emission Level (dBuV/m)	Limit (dBuV/m)	Margin (dB)	Antenna Height (m)	Table Angle (Degree)	Raw Value (dBuV)	Correction Factor (dB/m)
1	*2441.00	105.9 PK			1.47 H	1	106.7	-0.8
2	*2441.00	75.7 AV			1.47 H	1	76.5	-0.8
3	4882.00	41.7 PK	74.0	-32.3	1.20 H	163	36.6	5.1
4	4882.00	11.5 AV	54.0	-42.5	1.20 H	163	6.4	5.1
5	7323.00	46.2 PK	74.0	-27.8	1.29 H	91	35.0	11.2
6	7323.00	16.0 AV	54.0	-38.0	1.29 H	91	4.8	11.2

**Remarks:**

- Emission Level(dBuV/m) = Raw Value(dBuV) + Correction Factor(dB/m)
- Correction Factor(dB/m) = Antenna Factor(dB/m) + Cable Factor(dB) – Pre-Amplifier Factor(dB)
- Margin value = Emission Level – Limit value
- The other emission levels were very low against the limit.
- " \* " : Fundamental frequency, the limit was restricted at the RF Output Power.
- The average value of fundamental and harmonic frequency is: Average = Peak value + 20 log(Duty cycle) Where the duty cycle correction factor is calculated from following formula:  
 $20 \log(\text{Duty cycle}) = 20 \log(3.1 \text{ ms} / 100 \text{ ms}) = -30.2 \text{ dB}$

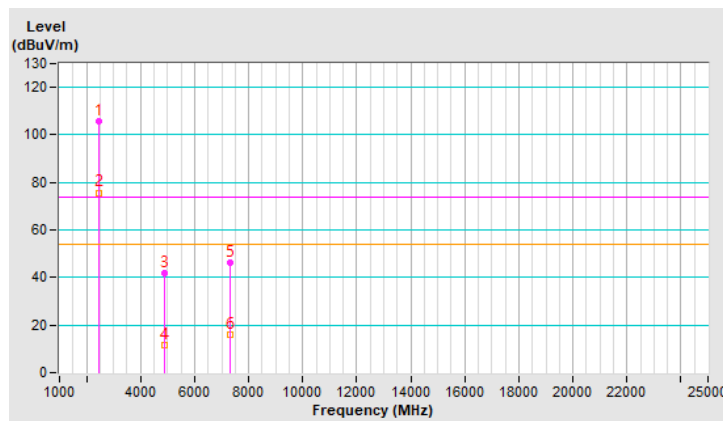

<b>RF Mode</b>	LIGHTSPEED GFSK	<b>Channel</b>	CH 39 : 2441 MHz
<b>Frequency Range</b>	1 GHz ~ 25 GHz	<b>Detector Function &amp; Bandwidth</b>	(PK) RB = 1 MHz, VB = 3 MHz (AV) RB = 1 MHz, VB = 3 MHz
<b>Input Power (System)</b>	120 Vac, 60 Hz	<b>Environmental Conditions</b>	25°C, 75% RH
<b>Tested By</b>	Sampson Chen		

Antenna Polarity & Test Distance : Vertical at 3 m								
No	Frequency (MHz)	Emission Level (dBuV/m)	Limit (dBuV/m)	Margin (dB)	Antenna Height (m)	Table Angle (Degree)	Raw Value (dBuV)	Correction Factor (dB/m)
1	*2441.00	103.1 PK			1.13 V	29	103.9	-0.8
2	*2441.00	72.9 AV			1.13 V	29	73.7	-0.8
3	4882.00	41.8 PK	74.0	-32.2	1.28 V	310	36.7	5.1
4	4882.00	11.6 AV	54.0	-42.4	1.28 V	310	6.5	5.1
5	7323.00	45.1 PK	74.0	-28.9	2.53 V	281	33.9	11.2
6	7323.00	14.9 AV	54.0	-39.1	2.53 V	281	3.7	11.2

**Remarks:**

1. Emission Level(dBuV/m) = Raw Value(dBuV) + Correction Factor(dB/m)
2. Correction Factor(dB/m) = Antenna Factor(dB/m) + Cable Factor(dB) – Pre-Amplifier Factor(dB)
3. Margin value = Emission Level – Limit value
4. The other emission levels were very low against the limit.
5. " \* " : Fundamental frequency, the limit was restricted at the RF Output Power.
6. The average value of fundamental and harmonic frequency is: Average = Peak value + 20 log(Duty cycle) Where the duty cycle correction factor is calculated from following formula:  
 $20 \log(\text{Duty cycle}) = 20 \log(3.1 \text{ ms} / 100 \text{ ms}) = -30.2 \text{ dB}$

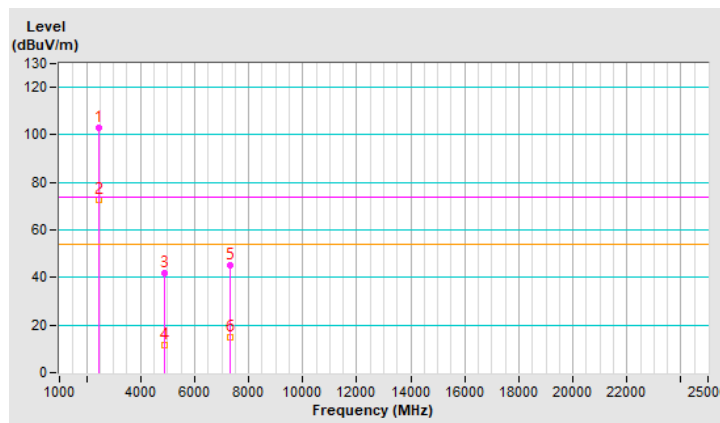



<b>RF Mode</b>	LIGHTSPEED GFSK	<b>Channel</b>	CH 78 : 2480 MHz
<b>Frequency Range</b>	1 GHz ~ 25 GHz	<b>Detector Function &amp; Bandwidth</b>	(PK) RB = 1 MHz, VB = 3 MHz (AV) RB = 1 MHz, VB = 3 MHz
<b>Input Power (System)</b>	120 Vac, 60 Hz	<b>Environmental Conditions</b>	25°C, 75% RH
<b>Tested By</b>	Sampson Chen		

**Antenna Polarity & Test Distance : Horizontal at 3 m**

No	Frequency (MHz)	Emission Level (dBuV/m)	Limit (dBuV/m)	Margin (dB)	Antenna Height (m)	Table Angle (Degree)	Raw Value (dBuV)	Correction Factor (dB/m)
1	*2480.00	105.6 PK			1.69 H	170	106.3	-0.7
2	*2480.00	75.4 AV			1.69 H	170	76.1	-0.7
3	2483.50	56.2 PK	74.0	-17.8	1.69 H	170	57.0	-0.8
4	2483.50	45.5 AV	54.0	-8.5	1.69 H	170	46.3	-0.8
5	4960.00	42.4 PK	74.0	-31.6	1.17 H	181	37.4	5.0
6	4960.00	12.2 AV	54.0	-41.8	1.17 H	181	7.2	5.0
7	7440.00	45.9 PK	74.0	-28.1	1.32 H	84	34.3	11.6
8	7440.00	15.7 AV	54.0	-38.3	1.32 H	84	4.1	11.6

**Remarks:**

1. Emission Level(dBuV/m) = Raw Value(dBuV) + Correction Factor(dB/m)
2. Correction Factor(dB/m) = Antenna Factor(dB/m) + Cable Factor(dB) – Pre-Amplifier Factor(dB)
3. Margin value = Emission Level – Limit value
4. The other emission levels were very low against the limit.
5. " \* ": Fundamental frequency, the limit was restricted at the RF Output Power.
6. The average value of fundamental and harmonic frequency is: Average = Peak value + 20 log(Duty cycle) Where the duty cycle correction factor is calculated from following formula:  
 $20 \log(\text{Duty cycle}) = 20 \log(3.1 \text{ ms} / 100 \text{ ms}) = -30.2 \text{ dB}$

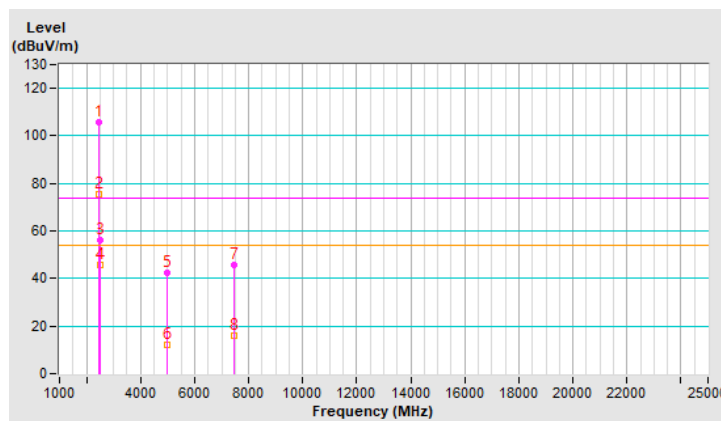



<b>RF Mode</b>	LIGHTSPEED GFSK	<b>Channel</b>	CH 78 : 2480 MHz
<b>Frequency Range</b>	1 GHz ~ 25 GHz	<b>Detector Function &amp; Bandwidth</b>	(PK) RB = 1 MHz, VB = 3 MHz (AV) RB = 1 MHz, VB = 3 MHz
<b>Input Power (System)</b>	120 Vac, 60 Hz	<b>Environmental Conditions</b>	25°C, 75% RH
<b>Tested By</b>	Sampson Chen		

Antenna Polarity & Test Distance : Vertical at 3 m								
No	Frequency (MHz)	Emission Level (dBuV/m)	Limit (dBuV/m)	Margin (dB)	Antenna Height (m)	Table Angle (Degree)	Raw Value (dBuV)	Correction Factor (dB/m)
1	*2480.00	102.1 PK			1.55 V	55	102.8	-0.7
2	*2480.00	71.9 AV			1.55 V	55	72.6	-0.7
3	2483.50	55.9 PK	74.0	-18.1	1.55 V	55	56.7	-0.8
4	2483.50	45.9 AV	54.0	-8.1	1.55 V	55	46.7	-0.8
5	4960.00	41.6 PK	74.0	-32.4	1.18 V	329	36.6	5.0
6	4960.00	11.4 AV	54.0	-42.6	1.18 V	329	6.4	5.0
7	7440.00	44.6 PK	74.0	-29.4	2.55 V	268	33.0	11.6
8	7440.00	14.4 AV	54.0	-39.6	2.55 V	268	2.8	11.6

**Remarks:**

1. Emission Level(dBuV/m) = Raw Value(dBuV) + Correction Factor(dB/m)
2. Correction Factor(dB/m) = Antenna Factor(dB/m) + Cable Factor(dB) – Pre-Amplifier Factor(dB)
3. Margin value = Emission Level – Limit value
4. The other emission levels were very low against the limit.
5. " \* ": Fundamental frequency, the limit was restricted at the RF Output Power.
6. The average value of fundamental and harmonic frequency is: Average = Peak value + 20 log(Duty cycle) Where the duty cycle correction factor is calculated from following formula:  
 $20 \log(\text{Duty cycle}) = 20 \log(3.1 \text{ ms} / 100 \text{ ms}) = -30.2 \text{ dB}$

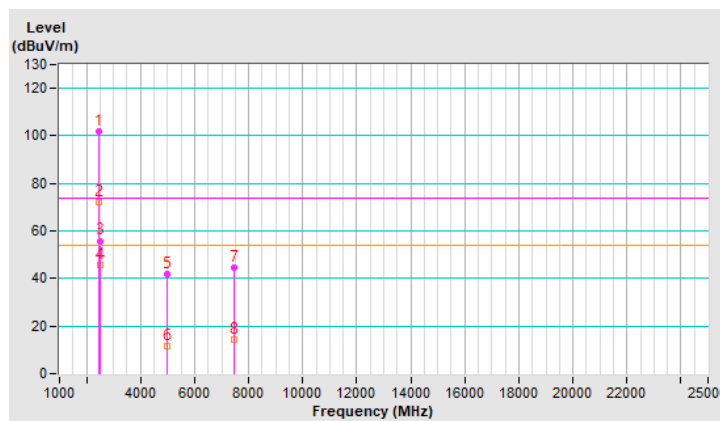

<b>RF Mode</b>	LIGHTSPEED $\pi/4$ -DQPSK	<b>Channel</b>	CH 0 : 2402 MHz
<b>Frequency Range</b>	1 GHz ~ 25 GHz	<b>Detector Function &amp; Bandwidth</b>	(PK) RB = 1 MHz, VB = 3 MHz (AV) RB = 1 MHz, VB = 3 MHz
<b>Input Power (System)</b>	120 Vac, 60 Hz	<b>Environmental Conditions</b>	25°C, 75% RH
<b>Tested By</b>	Sampson Chen		

Antenna Polarity & Test Distance : Horizontal at 3 m								
No	Frequency (MHz)	Emission Level (dBuV/m)	Limit (dBuV/m)	Margin (dB)	Antenna Height (m)	Table Angle (Degree)	Raw Value (dBuV)	Correction Factor (dB/m)
1	2390.00	55.5 PK	74.0	-18.5	1.50 H	10	56.3	-0.8
2	2390.00	45.7 AV	54.0	-8.3	1.50 H	10	46.5	-0.8
3	*2402.00	107.0 PK			1.50 H	10	107.8	-0.8
4	*2402.00	77.1 AV			1.50 H	10	77.9	-0.8
5	4804.00	42.1 PK	74.0	-31.9	1.12 H	180	37.1	5.0
6	4804.00	12.2 AV	54.0	-41.8	1.12 H	180	7.2	5.0

**Remarks:**

1. Emission Level(dBuV/m) = Raw Value(dBuV) + Correction Factor(dB/m)
2. Correction Factor(dB/m) = Antenna Factor(dB/m) + Cable Factor(dB) – Pre-Amplifier Factor(dB)
3. Margin value = Emission Level – Limit value
4. The other emission levels were very low against the limit.
5. " \* " : Fundamental frequency, the limit was restricted at the RF Output Power.
6. The average value of fundamental and harmonic frequency is: Average = Peak value + 20 log(Duty cycle) Where the duty cycle correction factor is calculated from following formula:  
 $20 \log(\text{Duty cycle}) = 20 \log(3.2 \text{ ms} / 100 \text{ ms}) = -29.9 \text{ dB}$

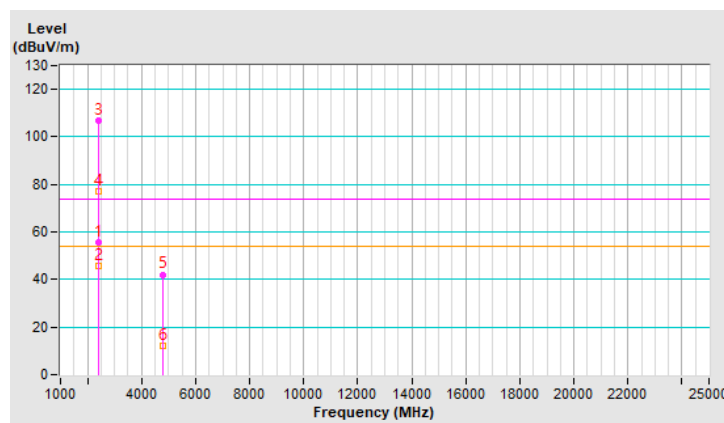

<b>RF Mode</b>	LIGHTSPEED $\pi/4$ -DQPSK	<b>Channel</b>	CH 0 : 2402 MHz
<b>Frequency Range</b>	1 GHz ~ 25 GHz	<b>Detector Function &amp; Bandwidth</b>	(PK) RB = 1 MHz, VB = 3 MHz (AV) RB = 1 MHz, VB = 3 MHz
<b>Input Power (System)</b>	120 Vac, 60 Hz	<b>Environmental Conditions</b>	25°C, 75% RH
<b>Tested By</b>	Sampson Chen		

Antenna Polarity & Test Distance : Vertical at 3 m								
No	Frequency (MHz)	Emission Level (dBuV/m)	Limit (dBuV/m)	Margin (dB)	Antenna Height (m)	Table Angle (Degree)	Raw Value (dBuV)	Correction Factor (dB/m)
1	2390.00	56.1 PK	74.0	-17.9	1.13 V	2	56.9	-0.8
2	2390.00	45.6 AV	54.0	-8.4	1.13 V	2	46.4	-0.8
3	*2402.00	105.0 PK			1.13 V	2	105.8	-0.8
4	*2402.00	75.1 AV			1.13 V	2	75.9	-0.8
5	4804.00	41.2 PK	74.0	-32.8	1.24 V	309	36.2	5.0
6	4804.00	11.3 AV	54.0	-42.7	1.24 V	309	6.3	5.0

**Remarks:**

- Emission Level(dBuV/m) = Raw Value(dBuV) + Correction Factor(dB/m)
- Correction Factor(dB/m) = Antenna Factor(dB/m) + Cable Factor(dB) – Pre-Amplifier Factor(dB)
- Margin value = Emission Level – Limit value
- The other emission levels were very low against the limit.
- " \* ": Fundamental frequency, the limit was restricted at the RF Output Power.
- The average value of fundamental and harmonic frequency is: Average = Peak value + 20 log(Duty cycle) Where the duty cycle correction factor is calculated from following formula:  
 $20 \log(\text{Duty cycle}) = 20 \log(3.2 \text{ ms} / 100 \text{ ms}) = -29.9 \text{ dB}$

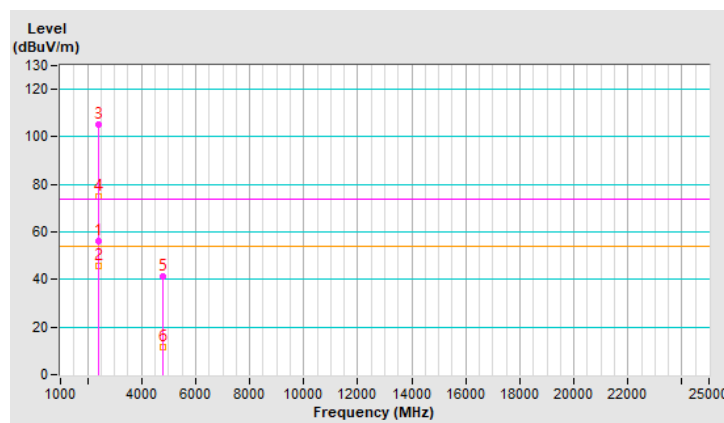

<b>RF Mode</b>	LIGHTSPEED $\pi/4$ -DQPSK	<b>Channel</b>	CH 39 : 2441 MHz
<b>Frequency Range</b>	1 GHz ~ 25 GHz	<b>Detector Function &amp; Bandwidth</b>	(PK) RB = 1 MHz, VB = 3 MHz (AV) RB = 1 MHz, VB = 3 MHz
<b>Input Power (System)</b>	120 Vac, 60 Hz	<b>Environmental Conditions</b>	25°C, 75% RH
<b>Tested By</b>	Sampson Chen		

Antenna Polarity & Test Distance : Horizontal at 3 m								
No	Frequency (MHz)	Emission Level (dBuV/m)	Limit (dBuV/m)	Margin (dB)	Antenna Height (m)	Table Angle (Degree)	Raw Value (dBuV)	Correction Factor (dB/m)
1	*2441.00	106.1 PK			1.37 H	2	106.9	-0.8
2	*2441.00	76.2 AV			1.37 H	2	77.0	-0.8
3	4882.00	42.1 PK	74.0	-31.9	1.17 H	183	37.0	5.1
4	4882.00	12.2 AV	54.0	-41.8	1.17 H	183	7.1	5.1
5	7323.00	46.5 PK	74.0	-27.5	1.26 H	84	35.3	11.2
6	7323.00	16.6 AV	54.0	-37.4	1.26 H	84	5.4	11.2

**Remarks:**

- Emission Level(dBuV/m) = Raw Value(dBuV) + Correction Factor(dB/m)
- Correction Factor(dB/m) = Antenna Factor(dB/m) + Cable Factor(dB) – Pre-Amplifier Factor(dB)
- Margin value = Emission Level – Limit value
- The other emission levels were very low against the limit.
- " \* ": Fundamental frequency, the limit was restricted at the RF Output Power.
- The average value of fundamental and harmonic frequency is: Average = Peak value + 20 log(Duty cycle) Where the duty cycle correction factor is calculated from following formula:  
 $20 \log(\text{Duty cycle}) = 20 \log(3.2 \text{ ms} / 100 \text{ ms}) = -29.9 \text{ dB}$

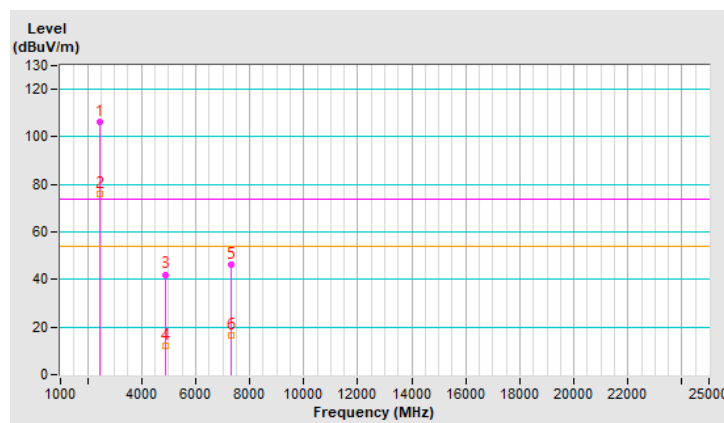

<b>RF Mode</b>	LIGHTSPEED $\pi/4$ -DQPSK	<b>Channel</b>	CH 39 : 2441 MHz
<b>Frequency Range</b>	1 GHz ~ 25 GHz	<b>Detector Function &amp; Bandwidth</b>	(PK) RB = 1 MHz, VB = 3 MHz (AV) RB = 1 MHz, VB = 3 MHz
<b>Input Power (System)</b>	120 Vac, 60 Hz	<b>Environmental Conditions</b>	25°C, 75% RH
<b>Tested By</b>	Sampson Chen		

Antenna Polarity & Test Distance : Vertical at 3 m								
No	Frequency (MHz)	Emission Level (dBuV/m)	Limit (dBuV/m)	Margin (dB)	Antenna Height (m)	Table Angle (Degree)	Raw Value (dBuV)	Correction Factor (dB/m)
1	*2441.00	103.7 PK			1.01 V	7	104.5	-0.8
2	*2441.00	73.8 AV			1.01 V	7	74.6	-0.8
3	4882.00	41.1 PK	74.0	-32.9	1.17 V	316	36.0	5.1
4	4882.00	11.2 AV	54.0	-42.8	1.17 V	316	6.1	5.1
5	7323.00	44.7 PK	74.0	-29.3	2.53 V	268	33.5	11.2
6	7323.00	14.8 AV	54.0	-39.2	2.53 V	268	3.6	11.2

**Remarks:**

1. Emission Level(dBuV/m) = Raw Value(dBuV) + Correction Factor(dB/m)
2. Correction Factor(dB/m) = Antenna Factor(dB/m) + Cable Factor(dB) – Pre-Amplifier Factor(dB)
3. Margin value = Emission Level – Limit value
4. The other emission levels were very low against the limit.
5. " \* " : Fundamental frequency, the limit was restricted at the RF Output Power.
6. The average value of fundamental and harmonic frequency is: Average = Peak value + 20 log(Duty cycle) Where the duty cycle correction factor is calculated from following formula:  
 $20 \log(\text{Duty cycle}) = 20 \log(3.2 \text{ ms} / 100 \text{ ms}) = -29.9 \text{ dB}$

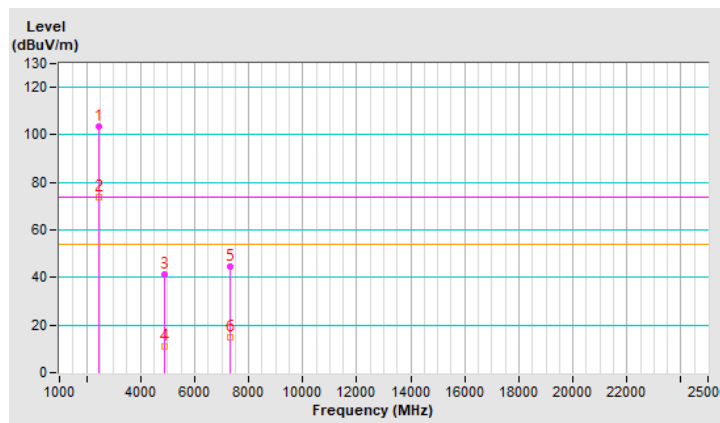

<b>RF Mode</b>	LIGHTSPEED $\pi/4$ -DQPSK	<b>Channel</b>	CH 78 : 2480 MHz
<b>Frequency Range</b>	1 GHz ~ 25 GHz	<b>Detector Function &amp; Bandwidth</b>	(PK) RB = 1 MHz, VB = 3 MHz (AV) RB = 1 MHz, VB = 3 MHz
<b>Input Power (System)</b>	120 Vac, 60 Hz	<b>Environmental Conditions</b>	25°C, 75% RH
<b>Tested By</b>	Sampson Chen		

Antenna Polarity & Test Distance : Horizontal at 3 m								
No	Frequency (MHz)	Emission Level (dBuV/m)	Limit (dBuV/m)	Margin (dB)	Antenna Height (m)	Table Angle (Degree)	Raw Value (dBuV)	Correction Factor (dB/m)
1	*2480.00	105.4 PK			1.65 H	160	106.1	-0.7
2	*2480.00	75.5 AV			1.65 H	160	76.2	-0.7
3	2483.50	54.8 PK	74.0	-19.2	1.65 H	160	55.6	-0.8
4	2483.50	45.7 AV	54.0	-8.3	1.65 H	160	46.5	-0.8
5	4960.00	42.1 PK	74.0	-31.9	1.22 H	184	37.1	5.0
6	4960.00	12.2 AV	54.0	-41.8	1.22 H	184	7.2	5.0
7	7440.00	46.6 PK	74.0	-27.4	1.28 H	78	35.0	11.6
8	7440.00	16.7 AV	54.0	-37.3	1.28 H	78	5.1	11.6

**Remarks:**

1. Emission Level(dBuV/m) = Raw Value(dBuV) + Correction Factor(dB/m)
2. Correction Factor(dB/m) = Antenna Factor(dB/m) + Cable Factor(dB) – Pre-Amplifier Factor(dB)
3. Margin value = Emission Level – Limit value
4. The other emission levels were very low against the limit.
5. " \* ": Fundamental frequency, the limit was restricted at the RF Output Power.
6. The average value of fundamental and harmonic frequency is: Average = Peak value + 20 log(Duty cycle) Where the duty cycle correction factor is calculated from following formula:  
 $20 \log(\text{Duty cycle}) = 20 \log(3.2 \text{ ms} / 100 \text{ ms}) = -29.9 \text{ dB}$

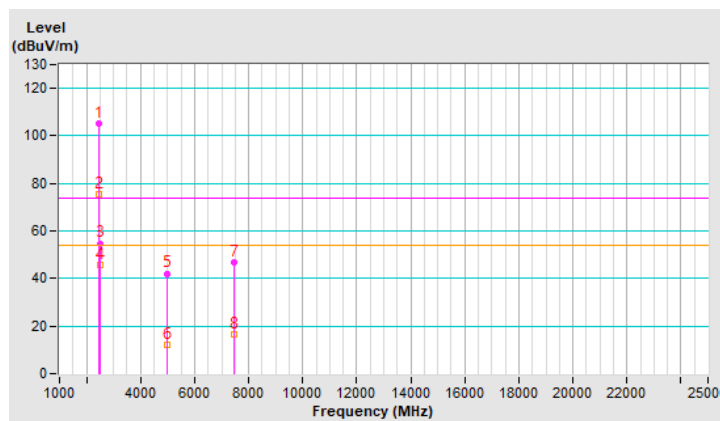

<b>RF Mode</b>	LIGHTSPEED $\pi/4$ -DQPSK	<b>Channel</b>	CH 78 : 2480 MHz
<b>Frequency Range</b>	1 GHz ~ 25 GHz	<b>Detector Function &amp; Bandwidth</b>	(PK) RB = 1 MHz, VB = 3 MHz (AV) RB = 1 MHz, VB = 3 MHz
<b>Input Power (System)</b>	120 Vac, 60 Hz	<b>Environmental Conditions</b>	25°C, 75% RH
<b>Tested By</b>	Sampson Chen		

Antenna Polarity & Test Distance : Vertical at 3 m								
No	Frequency (MHz)	Emission Level (dBuV/m)	Limit (dBuV/m)	Margin (dB)	Antenna Height (m)	Table Angle (Degree)	Raw Value (dBuV)	Correction Factor (dB/m)
1	*2480.00	100.8 PK			1.50 V	51	101.5	-0.7
2	*2480.00	70.9 AV			1.50 V	51	71.6	-0.7
3	2483.50	54.6 PK	74.0	-19.4	1.50 V	51	55.4	-0.8
4	2483.50	45.6 AV	54.0	-8.4	1.50 V	51	46.4	-0.8
5	4960.00	41.4 PK	74.0	-32.6	1.20 V	321	36.4	5.0
6	4960.00	11.5 AV	54.0	-42.5	1.20 V	321	6.5	5.0
7	7440.00	44.4 PK	74.0	-29.6	2.47 V	271	32.8	11.6
8	7440.00	14.5 AV	54.0	-39.5	2.47 V	271	2.9	11.6

**Remarks:**

1. Emission Level(dBuV/m) = Raw Value(dBuV) + Correction Factor(dB/m)
2. Correction Factor(dB/m) = Antenna Factor(dB/m) + Cable Factor(dB) – Pre-Amplifier Factor(dB)
3. Margin value = Emission Level – Limit value
4. The other emission levels were very low against the limit.
5. " \* ": Fundamental frequency, the limit was restricted at the RF Output Power.
6. The average value of fundamental and harmonic frequency is: Average = Peak value + 20 log(Duty cycle) Where the duty cycle correction factor is calculated from following formula:  
 $20 \log(\text{Duty cycle}) = 20 \log(3.2 \text{ ms} / 100 \text{ ms}) = -29.9 \text{ dB}$

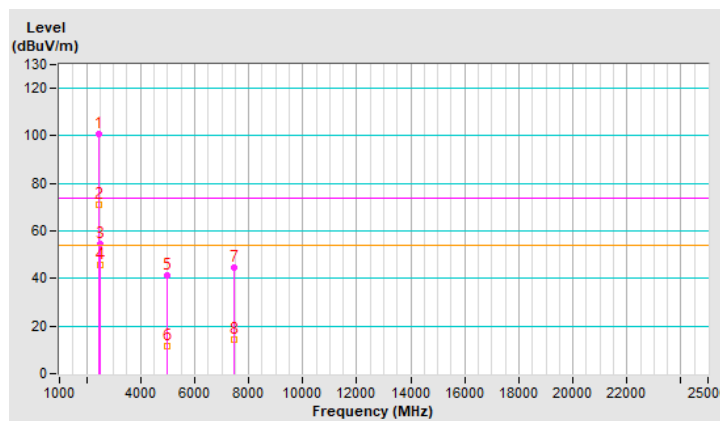



# Plot of Band Edge

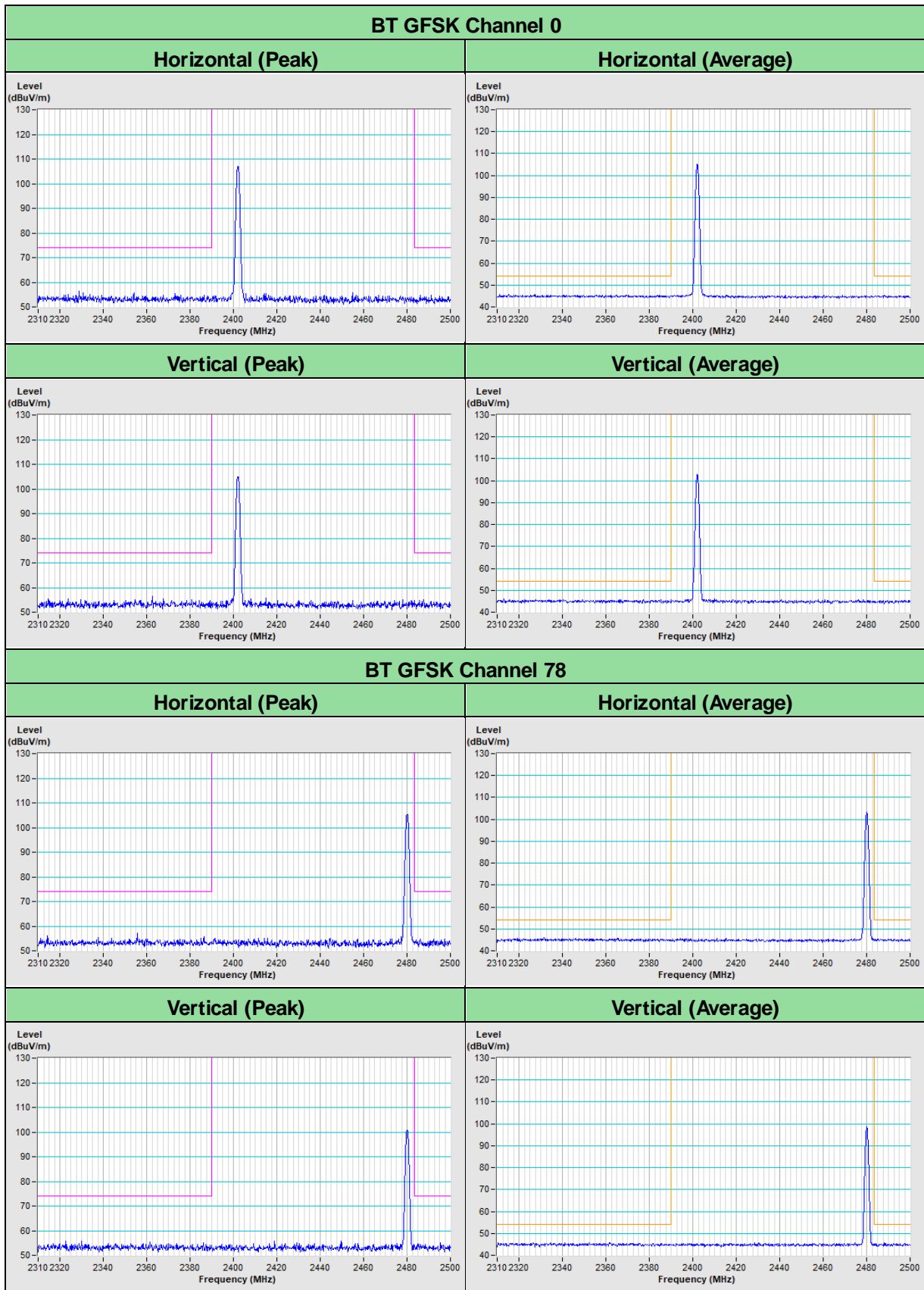







## 8 Pictures of Test Arrangements

Please refer to the attached file (Test Setup Photo)

## 9 Information of the Testing Laboratories

We, Bureau Veritas Consumer Products Services (H.K.) Ltd., Taoyuan Branch, were founded in 1988 to provide our best service in EMC, Radio, Telecom and Safety consultation. Our laboratories are FCC recognized accredited test firms and accredited according to ISO/IEC 17025.

If you have any comments, please feel free to contact us at the following:

**Lin Kou EMC/RF Lab**

Tel: 886-2-26052180

Fax: 886-2-26051924

**Hsin Chu EMC/RF/Telecom Lab**

Tel: 886-3-6668565

Fax: 886-3-6668323

**Hwa Ya EMC/RF/Safety Lab**

Tel: 886-3-3183232

Fax: 886-3-3270892

**Email:** [service.adt@bureauveritas.com](mailto:service.adt@bureauveritas.com)

**Web Site:** <http://ee.bureauveritas.com.tw>

The address and road map of all our labs can be found in our web site also.

--- END ---