

FCC Test Report (BT-EDR)

Report No.: RF181225E01

FCC ID: JNZA00082

Test Model: A00082

Received Date: Dec. 25, 2018

Test Date: Jan. 11 to Mar. 08, 2019

Issued Date: Mar. 20, 2019

Applicant: LOGITECH FAR EAST LTD.

Address: #2 Creation Rd. 4, Science-Based Ind. Park Hsinchu Taiwan, R.O.C.

Issued By: Bureau Veritas Consumer Products Services (H.K.) Ltd., Taoyuan Branch
Hsin Chu Laboratory

Lab Address: E-2, No.1, Li Hsin 1st Road, Hsinchu Science Park, Hsinchu City 300,
Taiwan R.O.C.

Test Location : E-2, No.1, Li Hsin 1st Road, Hsinchu Science Park, Hsinchu City 300,
Taiwan R.O.C.

**FCC Registration /
Designation Number:** 723255 / TW2022



This report is for your exclusive use. Any copying or replication of this report to or for any other person or entity, or use of our name or trademark, is permitted only with our prior written permission. This report sets forth our findings solely with respect to the test samples identified herein. The results set forth in this report are not indicative or representative of the quality or characteristics of the lot from which a test sample was taken or any similar or identical product unless specifically and expressly noted. Our report includes all of the tests requested by you and the results thereof based upon the information that you provided to us. You have 60 days from date of issuance of this report to notify us of any material error or omission caused by our negligence, provided, however, that such notice shall be in writing and shall specifically address the issue you wish to raise. A failure to raise such issue within the prescribed time shall constitute your unqualified acceptance of the completeness of this report, the tests conducted and the correctness of the report contents. Unless specific mention, the uncertainty of measurement has been explicitly taken into account to declare the compliance or non-compliance to the specification. The report must not be used by the client to claim product certification, approval, or endorsement by TAF or any government agencies.

Table of Contents

Release Control Record	4
1 Certificate of Conformity	5
2 Summary of Test Results	6
2.1 Measurement Uncertainty	6
2.2 Modification Record	6
3 General Information	7
3.1 General Description of EUT (BT-EDR)	7
3.2 Description of Test Modes	8
3.2.1 Test Mode Applicability and Tested Channel Detail	9
3.3 Duty Cycle of Test Signal	11
3.4 Description of Support Units	12
3.4.1 Configuration of System under Test	13
3.5 General Description of Applied Standards	14
4 Test Types and Results	15
4.1 Radiated Emission and Bandedge Measurement	15
4.1.1 Limits of Radiated Emission and Bandedge Measurement	15
4.1.2 Test Instruments	16
4.1.3 Test Procedures	18
4.1.4 Deviation from Test Standard	18
4.1.5 Test Setup	19
4.1.6 EUT Operating Conditions	20
4.1.7 Test Results	21
4.2 Conducted Emission Measurement	29
4.2.1 Limits of Conducted Emission Measurement	29
4.2.2 Test Instruments	29
4.2.3 Test Procedures	30
4.2.4 Deviation from Test Standard	30
4.2.5 Test Setup	30
4.2.6 EUT Operating Condition	30
4.2.7 Test Results	31
4.3 Number of Hopping Frequency Used	33
4.3.1 Limits of Hopping Frequency Used Measurement	33
4.3.2 Test Setup	33
4.3.3 Test Instruments	33
4.3.4 Test Procedure	33
4.3.5 Deviation from Test Standard	33
4.3.6 Test Results	34
4.4 Dwell Time on Each Channel	35
4.4.1 Limits of Dwell Time on Each Channel Measurement	35
4.4.2 Test Setup	35
4.4.3 Test Instruments	35
4.4.4 Test Procedures	35
4.4.5 Deviation from Test Standard	35
4.4.6 Test Results	36
4.5 Channel Bandwidth	40
4.5.1 Limits of Channel Bandwidth Measurement	40
4.5.2 Test Setup	40
4.5.3 Test Instruments	40
4.5.4 Test Procedure	40
4.5.5 Deviation from Test Standard	40
4.5.6 EUT Operating Condition	40
4.5.7 Test Results	41
4.6 Hopping Channel Separation	42

4.6.1	Limits of Hopping Channel Separation Measurement.....	42
4.6.2	Test Setup.....	42
4.6.3	Test Instruments	42
4.6.4	Test Procedure	42
4.6.5	Deviation from Test Standard	42
4.6.6	Test Results	43
4.7	Maximum Output Power	44
4.7.1	Limits of Maximum Output Power Measurement	44
4.7.2	Test Setup.....	44
4.7.3	Test Instruments	44
4.7.4	Test Procedure	44
4.7.5	Deviation from Test Standard	44
4.7.6	EUT Operating Condition	44
4.7.7	Test Results	45
4.8	Conducted Out of Band Emission Measurement	46
4.8.1	Limits of Conducted Out of Band Emission Measurement.....	46
4.8.2	Test Instruments	46
4.8.3	Test Procedure	46
4.8.4	Deviation from Test Standard	46
4.8.5	EUT Operating Condition	46
4.8.6	Test Results	46
5	Pictures of Test Arrangements.....	49
	Appendix – Information of the Testing Laboratories	50

Release Control Record

Issue No.	Description	Date Issued
RF181225E01	Original release.	Mar. 20, 2019

1 Certificate of Conformity

Product: Wireless Headset

Brand: logitech

Test Model: A00082

Sample Status: ENGINEERING SAMPLE

Applicant: LOGITECH FAR EAST LTD.

Test Date: Jan. 11 to Mar. 08, 2019

Standards: 47 CFR FCC Part 15, Subpart C (Section 15.247)
ANSI C63.10: 2013

The above equipment has been tested by **Bureau Veritas Consumer Products Services (H.K.) Ltd., Taoyuan Branch**, and found compliance with the requirement of the above standards. The test record, data evaluation & Equipment Under Test (EUT) configurations represented herein are true and accurate accounts of the measurements of the sample's EMC characteristics under the conditions specified in this report.

Prepared by : Wendy Wu , **Date:** Mar. 20, 2019
Wendy Wu / Specialist

Approved by : May Chen , **Date:** Mar. 20, 2019
May Chen / Manager

2 Summary of Test Results

47 CFR FCC Part 15, Subpart C (SECTION 15.247)			
FCC Clause	Test Item	Result	Remarks
15.207	AC Power Conducted Emission	PASS	Meet the requirement of limit. Minimum passing margin is -11.37dB at 0.48203MHz.
15.247(a)(1)(iii)	Number of Hopping Frequency Used	PASS	Meet the requirement of limit.
15.247(a)(1)(iii)	Dwell Time on Each Channel	PASS	Meet the requirement of limit.
15.247(a)(1)	1. Hopping Channel Separation 2. Spectrum Bandwidth of a Frequency Hopping Sequence Spread Spectrum System	PASS	Meet the requirement of limit.
15.247(b)	Maximum Peak Output Power	PASS	Meet the requirement of limit.
15.205 & 209 & 15.247(d)	Radiated Emissions & Band Edge Measurement	PASS	Meet the requirement of limit. Minimum passing margin is -8.5dB at 7323.00MHz.
15.247(d)	Antenna Port Emission	PASS	Meet the requirement of limit.
15.203	Antenna Requirement	PASS	No antenna connector is used.

NOTE:

1. If The Frequency Hopping System operating in 2400-2483.5MHz band and the output power less than 125mW. The hopping channel carrier frequencies separated by a minimum of 25kHz or two-thirds of the 20dB bandwidth of hopping channel whichever is greater.
2. Determining compliance based on the results of the compliance measurement, not taking into account measurement instrumentation uncertainty.

2.1 Measurement Uncertainty

Where relevant, the following measurement uncertainty levels have been estimated for tests performed on the EUT as specified in CISPR 16-4-2:

Measurement	Frequency	Expanded Uncertainty (k=2) (\pm)
Conducted Emissions at mains ports	150kHz ~ 30MHz	1.84 dB
Radiated Emissions up to 1 GHz	30MHz ~ 1GHz	5.12 dB
Radiated Emissions above 1 GHz	1GHz ~ 6GHz	5.13 dB
	6GHz ~ 18GHz	5.00 dB
	18GHz ~ 40GHz	5.19 dB

2.2 Modification Record

There were no modifications required for compliance.

3 General Information

3.1 General Description of EUT (BT-EDR)

Product	Wireless Headset
PMN	Logitech Zone Wireless, Logitech Zone Wireless Plus
Brand	logitech
Test Model	A00082
Status of EUT	ENGINEERING SAMPLE
Power Supply Rating	3.6Vdc from battery or 5Vdc from USB interface
Modulation Type	GFSK, $\pi/4$ -DQPSK, 8DPSK
Modulation Technology	FHSS
Transfer Rate	Up to 3Mbps
Operating Frequency	2402MHz ~ 2480MHz
Number of Channel	79
Output Power	6.546mW
Antenna Type	Refer to Note
Antenna Connector	Refer to Note
Accessory Device	NA
Data Cable Supplied	USB to Micro USB Cable x 1 (Shielded, 1.4m)

Note:

- The EUT may have a lot of colors for marketing requirement.
- When USB port is charging the rechargeable battery, the EUT has Bluetooth function under charging mode.
- The EUT could be supplied with a rechargeable battery as the following table:

Brand Name	Model No.	Spec.
Springpower Technology (Shenzhen) Co., LTD. or Logitech	383040 or 533-000167	3.6V, 400mAh, 1.44Wh

- The antenna provided to the EUT, please refer to the following table:

Antenna No.	Antenna Gain (dBi)	Frequency range (GHz)	Antenna Type	Connector Type
1	1.46	2.4~2.4835	Printed Antenna	none

- For conducted emissions, the EUT was pre-tested under the following modes:

Test Mode	Description
Mode A	Power from USB adapter
Mode B	Power from Laptop

From the above modes, the worst cases were found in **Mode B**. Therefore only the test data of the mode was recorded in this report.

- For radiated emissions, the EUT was pre-tested under the following modes:

Test Mode	Description
Mode A	Power from USB adapter
Mode B	Power from Battery

From the above modes, the worst case was found in **Mode A**. Therefore only the test data of the mode was recorded in this report.

- The above EUT information is declared by manufacturer and for more detailed features description, please refer to the manufacturer's specifications or user's manual.

3.2 Description of Test Modes

79 channels are provided for BT-EDR mode:

Channel	Freq. (MHz)	Channel	Freq. (MHz)	Channel	Freq. (MHz)	Channel	Freq. (MHz)
0	2402	20	2422	40	2442	60	2462
1	2403	21	2423	41	2443	61	2463
2	2404	22	2424	42	2444	62	2464
3	2405	23	2425	43	2445	63	2465
4	2406	24	2426	44	2446	64	2466
5	2407	25	2427	45	2447	65	2467
6	2408	26	2428	46	2448	66	2468
7	2409	27	2429	47	2449	67	2469
8	2410	28	2430	48	2450	68	2470
9	2411	29	2431	49	2451	69	2471
10	2412	30	2432	50	2452	70	2472
11	2413	31	2433	51	2453	71	2473
12	2414	32	2434	52	2454	72	2474
13	2415	33	2435	53	2455	73	2475
14	2416	34	2436	54	2456	74	2476
15	2417	35	2437	55	2457	75	2477
16	2418	36	2438	56	2458	76	2478
17	2419	37	2439	57	2459	77	2479
18	2420	38	2440	58	2460	78	2480
19	2421	39	2441	59	2461		

3.2.1 Test Mode Applicability and Tested Channel Detail

EUT CONFIGURE MODE	APPLICABLE TO				DESCRIPTION
	RE \geq 1G	RE $<$ 1G	PLC	APCM	
-	√	√	√	√	PLC: power from Laptop Other: power from USB adapter

Where **RE \geq 1G**: Radiated Emission above 1GHz **RE $<$ 1G**: Radiated Emission below 1GHz
PLC: Power Line Conducted Emission **APCM**: Antenna Port Conducted Measurement

NOTE:

- The EUT had been pre-tested on the positioned of each 3 axis. The worst case was found when positioned on **X-plane**.

Radiated Emission Test (Above 1GHz):

- Pre-Scan has been conducted to determine the worst-case mode from all possible combinations between available modulations, data rates and antenna ports (if EUT with antenna diversity architecture).
- Following channel(s) was (were) selected for the final test as listed below.

AVAILABLE CHANNEL	TESTED CHANNEL	MODULATION TECHNOLOGY	MODULATION TYPE	PACKET TYPE
0 to 78	0, 39, 78	FHSS	GFSK	DH5
0 to 78	0, 39, 78	FHSS	8DPSK	3DH5

Radiated Emission Test (Below 1GHz):

- Pre-Scan has been conducted to determine the worst-case mode from all possible combinations between available modulations, data rates and antenna ports (if EUT with antenna diversity architecture).
- Following channel(s) was (were) selected for the final test as listed below.

AVAILABLE CHANNEL	TESTED CHANNEL	MODULATION TECHNOLOGY	MODULATION TYPE	PACKET TYPE
0 to 78	78	FHSS	GFSK	DH5

Power Line Conducted Emission Test:

- Pre-Scan has been conducted to determine the worst-case mode from all possible combinations between available modulations, data rates and antenna ports (if EUT with antenna diversity architecture).
- Following channel(s) was (were) selected for the final test as listed below.

AVAILABLE CHANNEL	TESTED CHANNEL	MODULATION TECHNOLOGY	MODULATION TYPE	PACKET TYPE
0 to 78	78	FHSS	GFSK	DH5

Antenna Port Conducted Measurement:

- This item includes all test value of each mode, but only includes spectrum plot of worst value of each mode.
- Pre-Scan has been conducted to determine the worst-case mode from all possible combinations between available modulations, data rates and antenna ports (if EUT with antenna diversity architecture).
- Following channel(s) was (were) selected for the final test as listed below.

AVAILABLE CHANNEL	TESTED CHANNEL	MODULATION TECHNOLOGY	MODULATION TYPE	PACKET TYPE
0 to 78	0, 39, 78	FHSS	GFSK	DH5
0 to 78	0, 39, 78	FHSS	8DPSK	3DH5

Test Condition:

APPLICABLE TO	ENVIRONMENTAL CONDITIONS	INPUT POWER (SYSTEM)	TESTED BY
RE \geq 1G	21deg. C, 69%RH	120Vac, 60Hz	Steven Chiang
RE $<$ 1G	22deg. C, 67%RH	120Vac, 60Hz	Frank Chuang
PLC	23deg. C, 74%RH	120Vac, 60Hz	Andy Ho
APCM	25deg. C, 60%RH	120Vac, 60Hz	Jyunchun Lin

3.3 Duty Cycle of Test Signal

GFSK: Duty cycle = 2.872 ms/3.75 ms = 0.766 * 100 % = 76.6 %

8DPSK: Duty cycle = 2.885 ms/3.745 ms = 0.77* 100 % = 77 %

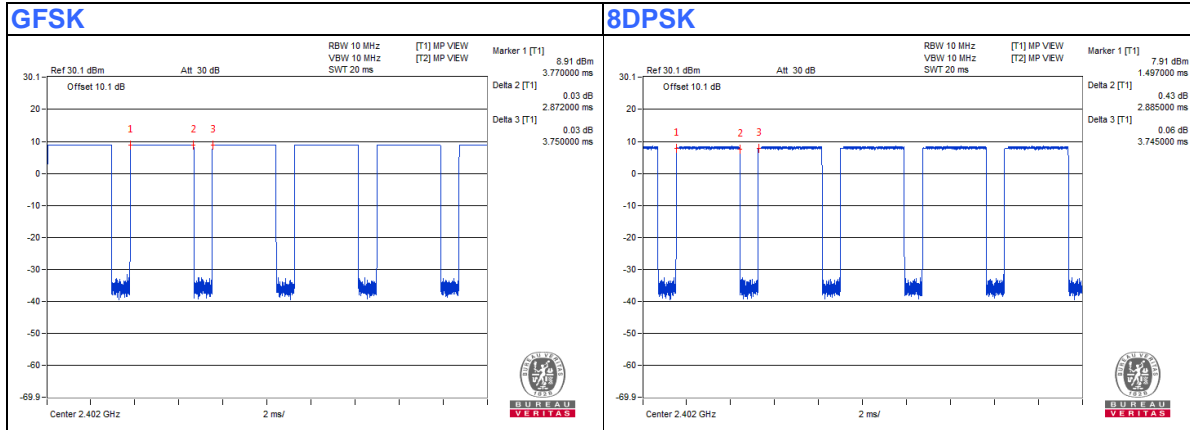

3.4 Description of Support Units

The EUT has been tested as an independent unit together with other necessary accessories or support units. The following support units or accessories were used to form a representative test configuration during the tests.

ID	Product	Brand	Model No.	Serial No.	FCC ID	Remarks
A.	USB Adapter	ASUS	EXA1205UA	NA	NA	Provided by Lab
B.	Laptop	HP	TPN-Q186	5CD8212YYG	FCC DoC	Provided by Lab

Note:

1. All power cords of the above support units are non-shielded (1.8m).

ID	Descriptions	Qty.	Length (m)	Shielding (Yes/No)	Cores (Qty.)	Remarks
1.	USB Cable	1	1.4	Yes	0	Supplied by client

3.4.1 Configuration of System under Test

For conducted emissions test:

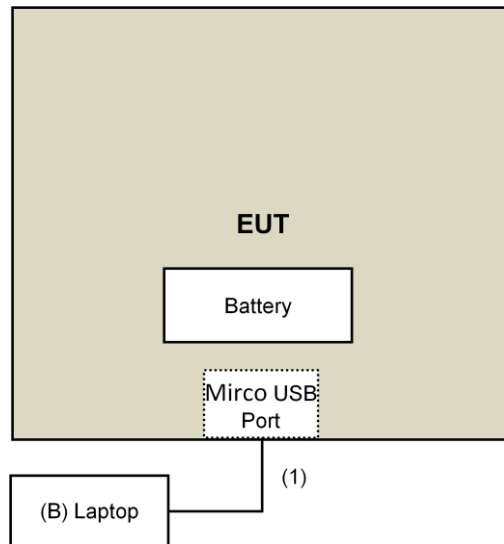

For other test:

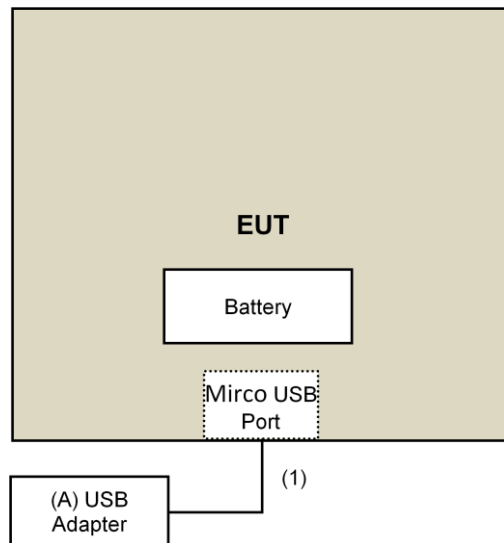

3.5 General Description of Applied Standards

The EUT is a RF Product. According to the specifications of the manufacturer, it must comply with the requirements of the following standards:

FCC Part 15, Subpart C (15.247)

KDB 558074 D01 15.247 Meas Guidance v05

ANSI C63.10-2013

All test items have been performed and recorded as per the above standards.

4 Test Types and Results

4.1 Radiated Emission and Bandedge Measurement

4.1.1 Limits of Radiated Emission and Bandedge Measurement

Radiated emissions which fall in the restricted bands must comply with the radiated emission limits specified as below table. Other emissions shall be at least 20dB below the highest level of the desired power:

Frequencies (MHz)	Field Strength (microvolts/meter)	Measurement Distance (meters)
0.009 ~ 0.490	2400/F(kHz)	300
0.490 ~ 1.705	24000/F(kHz)	30
1.705 ~ 30.0	30	30
30 ~ 88	100	3
88 ~ 216	150	3
216 ~ 960	200	3
Above 960	500	3

NOTE:

1. The lower limit shall apply at the transition frequencies.
2. Emission level (dBuV/m) = 20 log Emission level (uV/m).
3. For frequencies above 1000MHz, the field strength limits are based on average detector, however, the peak field strength of any emission shall not exceed the maximum permitted average limits, specified above by more than 20dB under any condition of modulation.

4.1.2 Test Instruments

For radiated emission (above 1GHz) test:

DESCRIPTION & MANUFACTURER	MODEL NO.	SERIAL NO.	CALIBRATED DATE	CALIBRATED UNTIL
Test Receiver Agilent	N9038A	MY50010156	July 12, 2018	July 11, 2019
Horn_Antenna SCHWARZBECK	BBHA9120-D	9120D-406	Nov. 25, 2018	Nov. 24, 2019
Pre-Amplifier EMCI	EMC12630SE	980384	Jan. 29, 2018	Jan. 28, 2019
RF Cable	EMC104-SM-SM-1200	160922	Jan. 29, 2018	Jan. 28, 2019
RF Cable	EMC104-SM-SM-2000	150317	Jan. 29, 2018	Jan. 28, 2019
RF Cable	EMC104-SM-SM-5000	150322	Jan. 29, 2018	Jan. 28, 2019
Spectrum Analyzer Keysight	N9030A	MY54490679	July 23, 2018	July 22, 2019
Pre-Amplifier EMCI	EMC184045SE	980386	Jan. 29, 2018	Jan. 28, 2019
Horn_Antenna SCHWARZBECK	BBHA 9170	BBHA9170608	Nov. 25, 2018	Nov. 24, 2019
RF Cable	EMC102-KM-KM-1200	160924	Jan. 29, 2018	Jan. 28, 2019
Software	ADT_Radiated_V8.7.08	NA	NA	NA
Antenna Tower & Turn Table Max-Full	MF-7802	MF780208406	NA	NA
Boresight Antenna Fixture	FBA-01	FBA-SIP01	NA	NA

Note:

1. The calibration interval of the above test instruments is 12 months and the calibrations are traceable to NML/ROC and NIST/USA.
2. The test was performed in 966 Chamber No. 3.
3. The CANADA Site Registration No. is 20331-1
4. Loop antenna was used for all emissions below 30 MHz.
5. Tested Date: Jan. 11, 2019

For radiated emission (below 1GHz) test:

DESCRIPTION & MANUFACTURER	MODEL NO.	SERIAL NO.	CALIBRATED DATE	CALIBRATED UNTIL
Test Receiver Agilent	N9038A	MY50010156	July 12, 2018	July 11, 2019
Pre-Amplifier EMCI	EMC001340	980142	Jan. 25, 2019	Jan. 24, 2020
Loop Antenna Electro-Metrics	EM-6879	269	Sep. 07, 2018	Sep. 06, 2019
RF Cable	NA	LOOPCAB-001	Jan. 14, 2019	Jan. 13, 2020
RF Cable	NA	LOOPCAB-002	Jan. 14, 2019	Jan. 13, 2020
Pre-Amplifier Mini-Circuits	ZFL-1000VH2B	AMP-ZFL-05	May 05, 2018	May 04, 2019
Trilog Broadband Antenna SCHWARZBECK	VULB 9168	9168-361	Nov. 22, 2018	Nov. 21, 2019
RF Cable	8D	966-3-1	Mar. 20, 2018	Mar. 19, 2019
RF Cable	8D	966-3-2	Mar. 20, 2018	Mar. 19, 2019
RF Cable	8D	966-3-3	Mar. 20, 2018	Mar. 19, 2019
Fixed attenuator Mini-Circuits	UNAT-5+	PAD-3m-3-01	Sep. 27, 2018	Sep. 26, 2019
Software	ADT_Radiated_V8.7.08	NA	NA	NA
Antenna Tower & Turn Table Max-Full	MF-7802	MF780208406	NA	NA

Note:

1. The calibration interval of the above test instruments is 12 months and the calibrations are traceable to NML/ROC and NIST/USA.
2. The test was performed in 966 Chamber No. 3.
3. The CANADA Site Registration No. is 20331-1
4. Loop antenna was used for all emissions below 30 MHz.
5. Tested Date: Mar. 08, 2019

For other test:

DESCRIPTION & MANUFACTURER	MODEL NO.	SERIAL NO.	CALIBRATED DATE	CALIBRATED UNTIL
Spectrum Analyzer R&S	FSV40	100964	June 20, 2018	June 19, 2019
Power meter Anritsu	ML2495A	1014008	May 09, 2018	May 08, 2019
Power sensor Anritsu	MA2411B	0917122	May 09, 2018	May 08, 2019
Fixed Attenuator Mini-Circuits	MDCS18N-10	MDCS18N-10-01	Apr. 16, 2018	Apr. 15, 2019

Note:

1. The calibration interval of the above test instruments is 12 months and the calibrations are traceable to NML/ROC and NIST/USA.
2. The test was performed in Oven room 2.
3. Tested Date: Jan. 21, 2019

4.1.3 Test Procedures

For Radiated emission below 30MHz

- a. The EUT was placed on the top of a rotating table 0.8 meters above the ground at a 3 meter chamber room. The table was rotated 360 degrees to determine the position of the highest radiation.
- b. The EUT was set 3 meters away from the interference-receiving antenna, which was mounted on the top of a variable-height antenna tower.
- c. Both Parallel, perpendicular, and ground-parallel orientations of the antenna are set to make the measurement.
- d. For each suspected emission, the EUT was arranged to its worst case and the rotatable table was turned from 0 degrees to 360 degrees to find the maximum reading.
- e. The test-receiver system was set to Quasi-Peak Detect Function and Specified Bandwidth with Maximum Hold Mode.

NOTE:

1. The resolution bandwidth and video bandwidth of test receiver/spectrum analyzer is 9kHz at frequency below 30MHz.

For Radiated emission above 30MHz

- a. The EUT was placed on the top of a rotating table 0.8 meters (for 30MHz ~ 1GHz) / 1.5 meters (for above 1GHz) above the ground at 3 meter chamber room for test. The table was rotated 360 degrees to determine the position of the highest radiation.
- b. The EUT was set 3 meters away from the interference-receiving antenna, which was mounted on the top of a variable-height antenna tower.
- c. The height of antenna is varied from one meter to four meters above the ground to determine the maximum value of the field strength. Both horizontal and vertical polarizations of the antenna are set to make the measurement.
- d. For each suspected emission, the EUT was arranged to its worst case and then the antenna was tuned to heights from 1 meter to 4 meters and the rotatable table was turned from 0 degrees to 360 degrees to find the maximum reading.
- e. The test-receiver system was set to quasi-peak detect function and specified bandwidth with maximum hold mode when the test frequency is below 1 GHz.
- f. The test-receiver system was set to peak and average detect function and specified bandwidth with maximum hold mode when the test frequency is above 1 GHz. If the peak reading value also meets average limit, measurement with the average detector is unnecessary.

Note:

1. The resolution bandwidth and video bandwidth of test receiver/spectrum analyzer is 120kHz for Quasi-peak detection (QP) at frequency below 1GHz.
2. The resolution bandwidth of test receiver/spectrum analyzer is 1 MHz and the video bandwidth is 3 MHz for Peak detection (PK) at frequency above 1GHz.
3. The resolution bandwidth of test receiver/spectrum analyzer is 1MHz and the video bandwidth is $\geq 1/T$ (Duty cycle $< 98\%$) or 10Hz (Duty cycle $\geq 98\%$) for Average detection (AV) at frequency above 1GHz.
4. All modes of operation were investigated and the worst-case emissions are reported.

4.1.4 Deviation from Test Standard

No deviation.

4.1.5 Test Setup

For Radiated emission below 30MHz

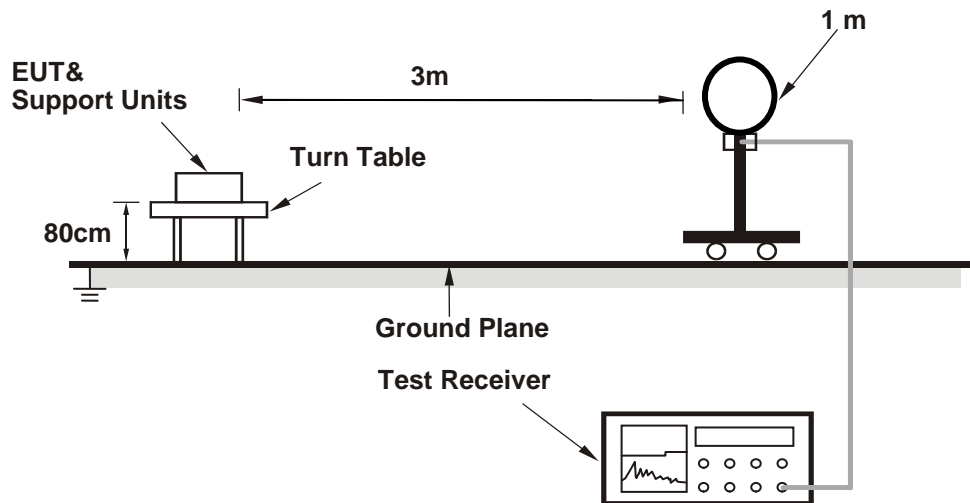

For Radiated emission 30MHz to 1GHz

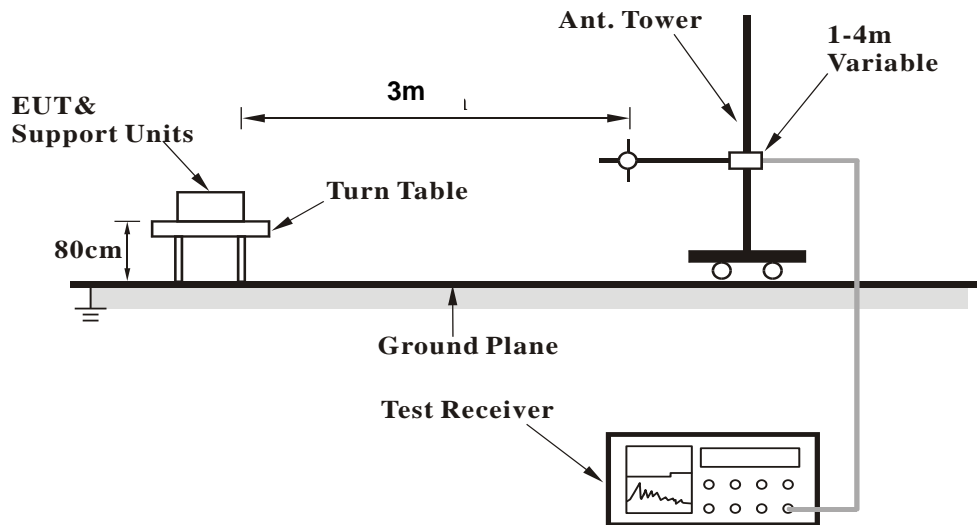

For Radiated emission above 1GHz

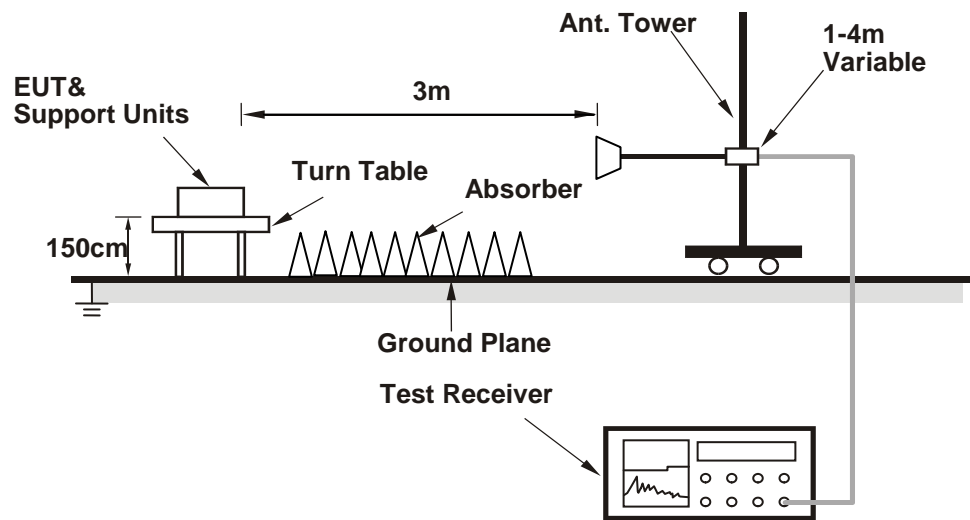

For the actual test configuration, please refer to the attached file (Test Setup Photo).

4.1.6 EUT Operating Conditions

- a. Placed the EUT on the testing table.
- b. Controlling software (CSR BlueSuite (2.5.0)) has been activated to set the EUT on specific status.

4.1.7 Test Results

Above 1GHz Data:

BT_GFSK

CHANNEL	TX Channel 0	DETECTOR FUNCTION	Peak (PK)
FREQUENCY RANGE	1GHz ~ 25GHz		Average (AV)

ANTENNA POLARITY & TEST DISTANCE: HORIZONTAL AT 3 M

NO.	FREQ. (MHz)	EMISSION LEVEL (dBuV/m)	LIMIT (dBuV/m)	MARGIN (dB)	ANTENNA HEIGHT (m)	TABLE ANGLE (Degree)	RAW VALUE (dBuV)	CORRECTION FACTOR (dB/m)
1	2322.00	54.3 PK	74.0	-19.7	2.17 H	330	56.5	-2.2
2	2322.00	43.1 AV	54.0	-10.9	2.17 H	330	45.3	-2.2
3	2390.00	54.5 PK	74.0	-19.5	2.17 H	330	56.9	-2.4
4	2390.00	42.2 AV	54.0	-11.8	2.17 H	330	44.6	-2.4
5	*2402.00	97.6 PK			2.17 H	330	99.9	-2.3
6	*2402.00	97.1 AV			2.17 H	330	99.4	-2.3
7	4804.00	38.8 PK	74.0	-35.2	1.35 H	314	36.8	2.0
8	4804.00	30.1 AV	54.0	-23.9	1.35 H	314	28.1	2.0

ANTENNA POLARITY & TEST DISTANCE: VERTICAL AT 3 M

NO.	FREQ. (MHz)	EMISSION LEVEL (dBuV/m)	LIMIT (dBuV/m)	MARGIN (dB)	ANTENNA HEIGHT (m)	TABLE ANGLE (Degree)	RAW VALUE (dBuV)	CORRECTION FACTOR (dB/m)
1	2322.00	54.7 PK	74.0	-19.3	2.31 V	26	56.9	-2.2
2	2322.00	43.5 AV	54.0	-10.5	2.31 V	26	45.7	-2.2
3	2390.00	54.6 PK	74.0	-19.4	2.31 V	26	57.0	-2.4
4	2390.00	42.3 AV	54.0	-11.7	2.31 V	26	44.7	-2.4
5	*2402.00	99.7 PK			2.31 V	26	102.0	-2.3
6	*2402.00	99.3 AV			2.31 V	26	101.6	-2.3
7	4804.00	41.1 PK	74.0	-32.9	1.64 V	17	39.1	2.0
8	4804.00	33.4 AV	54.0	-20.6	1.64 V	17	31.4	2.0

REMARKS:

1. Emission Level(dBuV/m) = Raw Value(dBuV) + Correction Factor(dB/m)
2. Correction Factor(dB/m) = Antenna Factor(dB/m) + Cable Factor(dB) – Pre-Amplifier Factor(dB)
3. The other emission levels were very low against the limit.
4. Margin value = Emission Level – Limit value
5. " * ": Fundamental frequency.

CHANNEL	TX Channel 39	DETECTOR FUNCTION	Peak (PK)
FREQUENCY RANGE	1GHz ~ 25GHz		Average (AV)

ANTENNA POLARITY & TEST DISTANCE: HORIZONTAL AT 3 M

NO.	FREQ. (MHz)	EMISSION LEVEL (dBuV/m)	LIMIT (dBuV/m)	MARGIN (dB)	ANTENNA HEIGHT (m)	TABLE ANGLE (Degree)	RAW VALUE (dBuV)	CORRECTION FACTOR (dB/m)
1	*2441.00	98.0 PK			2.11 H	323	100.5	-2.5
2	*2441.00	97.6 AV			2.11 H	323	100.1	-2.5
3	4882.00	38.7 PK	74.0	-35.3	1.28 H	306	36.8	1.9
4	4882.00	30.2 AV	54.0	-23.8	1.28 H	306	28.3	1.9
5	7323.00	45.7 PK	74.0	-28.3	2.58 H	293	37.8	7.9
6	7323.00	35.1 AV	54.0	-18.9	2.58 H	293	27.2	7.9

ANTENNA POLARITY & TEST DISTANCE: VERTICAL AT 3 M

NO.	FREQ. (MHz)	EMISSION LEVEL (dBuV/m)	LIMIT (dBuV/m)	MARGIN (dB)	ANTENNA HEIGHT (m)	TABLE ANGLE (Degree)	RAW VALUE (dBuV)	CORRECTION FACTOR (dB/m)
1	*2441.00	100.0 PK			2.26 V	30	102.5	-2.5
2	*2441.00	99.6 AV			2.26 V	30	102.1	-2.5
3	4882.00	41.9 PK	74.0	-32.1	1.65 V	11	40.0	1.9
4	4882.00	33.9 AV	54.0	-20.1	1.65 V	11	32.0	1.9
5	7323.00	51.8 PK	74.0	-22.2	1.17 V	358	43.9	7.9
6	7323.00	45.5 AV	54.0	-8.5	1.17 V	358	37.6	7.9

REMARKS:

1. Emission Level(dBuV/m) = Raw Value(dBuV) + Correction Factor(dB/m)
2. Correction Factor(dB/m) = Antenna Factor(dB/m) + Cable Factor(dB) – Pre-Amplifier Factor(dB)
3. The other emission levels were very low against the limit.
4. Margin value = Emission Level – Limit value
5. " * ": Fundamental frequency.

CHANNEL	TX Channel 78	DETECTOR FUNCTION	Peak (PK)
FREQUENCY RANGE	1GHz ~ 25GHz		Average (AV)

ANTENNA POLARITY & TEST DISTANCE: HORIZONTAL AT 3 M

NO.	FREQ. (MHz)	EMISSION LEVEL (dBuV/m)	LIMIT (dBuV/m)	MARGIN (dB)	ANTENNA HEIGHT (m)	TABLE ANGLE (Degree)	RAW VALUE (dBuV)	CORRECTION FACTOR (dB/m)
1	*2480.00	98.2 PK			2.11 H	336	100.8	-2.6
2	*2480.00	97.8 AV			2.11 H	336	100.4	-2.6
3	2483.50	54.2 PK	74.0	-19.8	2.11 H	336	56.8	-2.6
4	2483.50	42.3 AV	54.0	-11.7	2.11 H	336	44.9	-2.6
5	4960.00	38.9 PK	74.0	-35.1	1.33 H	305	36.8	2.1
6	4960.00	30.3 AV	54.0	-23.7	1.33 H	305	28.2	2.1
7	7440.00	45.7 PK	74.0	-28.3	2.58 H	305	37.6	8.1
8	7440.00	35.2 AV	54.0	-18.8	2.58 H	305	27.1	8.1

ANTENNA POLARITY & TEST DISTANCE: VERTICAL AT 3 M

NO.	FREQ. (MHz)	EMISSION LEVEL (dBuV/m)	LIMIT (dBuV/m)	MARGIN (dB)	ANTENNA HEIGHT (m)	TABLE ANGLE (Degree)	RAW VALUE (dBuV)	CORRECTION FACTOR (dB/m)
1	*2480.00	100.2 PK			2.31 V	26	102.8	-2.6
2	*2480.00	99.8 AV			2.31 V	26	102.4	-2.6
3	2483.50	55.3 PK	74.0	-18.7	2.31 V	26	57.9	-2.6
4	2483.50	42.8 AV	54.0	-11.2	2.31 V	26	45.4	-2.6
5	4960.00	41.4 PK	74.0	-32.6	1.68 V	8	39.3	2.1
6	4960.00	33.6 AV	54.0	-20.4	1.68 V	8	31.5	2.1
7	7440.00	51.8 PK	74.0	-22.2	1.18 V	345	43.7	8.1
8	7440.00	45.3 AV	54.0	-8.7	1.18 V	345	37.2	8.1

REMARKS:

1. Emission Level(dBuV/m) = Raw Value(dBuV) + Correction Factor(dB/m)
2. Correction Factor(dB/m) = Antenna Factor(dB/m) + Cable Factor(dB) – Pre-Amplifier Factor(dB)
3. The other emission levels were very low against the limit.
4. Margin value = Emission Level – Limit value
5. " * ": Fundamental frequency.

BT_8DPSK

CHANNEL	TX Channel 0	DETECTOR FUNCTION	Peak (PK)
FREQUENCY RANGE	1GHz ~ 25GHz		Average (AV)

ANTENNA POLARITY & TEST DISTANCE: HORIZONTAL AT 3 M

NO.	FREQ. (MHz)	EMISSION LEVEL (dBuV/m)	LIMIT (dBuV/m)	MARGIN (dB)	ANTENNA HEIGHT (m)	TABLE ANGLE (Degree)	RAW VALUE (dBuV)	CORRECTION FACTOR (dB/m)
1	2322.00	54.2 PK	74.0	-19.8	2.12 H	347	56.4	-2.2
2	2322.00	42.5 AV	54.0	-11.5	2.12 H	347	44.7	-2.2
3	2390.00	53.8 PK	74.0	-20.2	2.12 H	347	56.2	-2.4
4	2390.00	42.1 AV	54.0	-11.9	2.12 H	347	44.5	-2.4
5	*2402.00	96.9 PK			2.12 H	347	99.2	-2.3
6	*2402.00	94.0 AV			2.12 H	347	96.3	-2.3
7	4804.00	39.0 PK	74.0	-35.0	1.36 H	315	37.0	2.0
8	4804.00	30.5 AV	54.0	-23.5	1.36 H	315	28.5	2.0

ANTENNA POLARITY & TEST DISTANCE: VERTICAL AT 3 M

NO.	FREQ. (MHz)	EMISSION LEVEL (dBuV/m)	LIMIT (dBuV/m)	MARGIN (dB)	ANTENNA HEIGHT (m)	TABLE ANGLE (Degree)	RAW VALUE (dBuV)	CORRECTION FACTOR (dB/m)
1	2322.00	54.5 PK	74.0	-19.5	2.38 V	37	56.7	-2.2
2	2322.00	42.8 AV	54.0	-11.2	2.38 V	37	45.0	-2.2
3	2390.00	54.1 PK	74.0	-19.9	2.38 V	37	56.5	-2.4
4	2390.00	42.3 AV	54.0	-11.7	2.38 V	37	44.7	-2.4
5	*2402.00	98.8 PK			2.38 V	37	101.1	-2.3
6	*2402.00	95.9 AV			2.38 V	37	98.2	-2.3
7	4804.00	42.1 PK	74.0	-31.9	1.66 V	24	40.1	2.0
8	4804.00	34.1 AV	54.0	-19.9	1.66 V	24	32.1	2.0

REMARKS:

1. Emission Level(dBuV/m) = Raw Value(dBuV) + Correction Factor(dB/m)
2. Correction Factor(dB/m) = Antenna Factor(dB/m) + Cable Factor(dB) – Pre-Amplifier Factor(dB)
3. The other emission levels were very low against the limit.
4. Margin value = Emission Level – Limit value
5. " * ": Fundamental frequency.

CHANNEL	TX Channel 39	DETECTOR FUNCTION	Peak (PK)
FREQUENCY RANGE	1GHz ~ 25GHz		Average (AV)

ANTENNA POLARITY & TEST DISTANCE: HORIZONTAL AT 3 M

NO.	FREQ. (MHz)	EMISSION LEVEL (dBuV/m)	LIMIT (dBuV/m)	MARGIN (dB)	ANTENNA HEIGHT (m)	TABLE ANGLE (Degree)	RAW VALUE (dBuV)	CORRECTION FACTOR (dB/m)
1	*2441.00	97.4 PK			2.12 H	331	99.9	-2.5
2	*2441.00	94.5 AV			2.12 H	331	97.0	-2.5
3	4882.00	38.8 PK	74.0	-35.2	1.34 H	290	36.9	1.9
4	4882.00	30.3 AV	54.0	-23.7	1.34 H	290	28.4	1.9
5	7323.00	45.9 PK	74.0	-28.1	2.55 H	309	38.0	7.9
6	7323.00	35.5 AV	54.0	-18.5	2.55 H	309	27.6	7.9

ANTENNA POLARITY & TEST DISTANCE: VERTICAL AT 3 M

NO.	FREQ. (MHz)	EMISSION LEVEL (dBuV/m)	LIMIT (dBuV/m)	MARGIN (dB)	ANTENNA HEIGHT (m)	TABLE ANGLE (Degree)	RAW VALUE (dBuV)	CORRECTION FACTOR (dB/m)
1	*2441.00	98.2 PK			2.32 V	30	100.7	-2.5
2	*2441.00	95.3 AV			2.32 V	30	97.8	-2.5
3	4882.00	42.0 PK	74.0	-32.0	1.66 V	17	40.1	1.9
4	4882.00	33.8 AV	54.0	-20.2	1.66 V	17	31.9	1.9
5	7323.00	48.1 PK	74.0	-25.9	1.32 V	340	40.2	7.9
6	7323.00	38.2 AV	54.0	-15.8	1.32 V	340	30.3	7.9

REMARKS:

1. Emission Level(dBuV/m) = Raw Value(dBuV) + Correction Factor(dB/m)
2. Correction Factor(dB/m) = Antenna Factor(dB/m) + Cable Factor(dB) – Pre-Amplifier Factor(dB)
3. The other emission levels were very low against the limit.
4. Margin value = Emission Level – Limit value
5. " * ": Fundamental frequency.

CHANNEL	TX Channel 78	DETECTOR FUNCTION	Peak (PK)
FREQUENCY RANGE	1GHz ~ 25GHz		Average (AV)

ANTENNA POLARITY & TEST DISTANCE: HORIZONTAL AT 3 M

NO.	FREQ. (MHz)	EMISSION LEVEL (dBuV/m)	LIMIT (dBuV/m)	MARGIN (dB)	ANTENNA HEIGHT (m)	TABLE ANGLE (Degree)	RAW VALUE (dBuV)	CORRECTION FACTOR (dB/m)
1	*2480.00	97.7 PK			2.10 H	343	100.3	-2.6
2	*2480.00	94.8 AV			2.10 H	343	97.4	-2.6
3	2483.50	58.1 PK	74.0	-15.9	2.10 H	343	60.7	-2.6
4	2483.50	43.7 AV	54.0	-10.3	2.10 H	343	46.3	-2.6
5	4960.00	39.5 PK	74.0	-34.5	1.27 H	314	37.4	2.1
6	4960.00	30.7 AV	54.0	-23.3	1.27 H	314	28.6	2.1
7	7440.00	45.7 PK	74.0	-28.3	2.64 H	310	37.6	8.1
8	7440.00	35.4 AV	54.0	-18.6	2.64 H	310	27.3	8.1

ANTENNA POLARITY & TEST DISTANCE: VERTICAL AT 3 M

NO.	FREQ. (MHz)	EMISSION LEVEL (dBuV/m)	LIMIT (dBuV/m)	MARGIN (dB)	ANTENNA HEIGHT (m)	TABLE ANGLE (Degree)	RAW VALUE (dBuV)	CORRECTION FACTOR (dB/m)
1	*2480.00	98.5 PK			2.33 V	27	101.1	-2.6
2	*2480.00	96.6 AV			2.33 V	27	99.2	-2.6
3	2483.50	59.2 PK	74.0	-14.8	2.33 V	27	61.8	-2.6
4	2483.50	44.8 AV	54.0	-9.2	2.33 V	27	47.4	-2.6
5	4960.00	41.6 PK	74.0	-32.4	1.66 V	21	39.5	2.1
6	4960.00	33.6 AV	54.0	-20.4	1.66 V	21	31.5	2.1
7	7440.00	48.3 PK	74.0	-25.7	1.36 V	346	40.2	8.1
8	7440.00	38.5 AV	54.0	-15.5	1.36 V	346	30.4	8.1

REMARKS:

1. Emission Level(dBuV/m) = Raw Value(dBuV) + Correction Factor(dB/m)
2. Correction Factor(dB/m) = Antenna Factor(dB/m) + Cable Factor(dB) – Pre-Amplifier Factor(dB)
3. The other emission levels were very low against the limit.
4. Margin value = Emission Level – Limit value
5. " * ": Fundamental frequency.

Below 1GHz Data:

BT_GFSK

CHANNEL	TX Channel 78	DETECTOR FUNCTION	Quasi-Peak (QP)
FREQUENCY RANGE	9kHz ~ 1GHz		

ANTENNA POLARITY & TEST DISTANCE: HORIZONTAL AT 3 M

NO.	FREQ. (MHz)	EMISSION LEVEL (dBuV/m)	LIMIT (dBuV/m)	MARGIN (dB)	ANTENNA HEIGHT (m)	TABLE ANGLE (Degree)	RAW VALUE (dBuV)	CORRECTION FACTOR (dB/m)
1	34.97	25.6 QP	40.0	-14.4	2.00 H	18	35.6	-10.0
2	47.24	21.9 QP	40.0	-18.1	1.00 H	360	30.9	-9.0
3	148.29	21.7 QP	43.5	-21.8	2.00 H	360	29.8	-8.1
4	168.01	21.3 QP	43.5	-22.2	2.00 H	110	30.3	-9.0
5	524.05	28.1 QP	46.0	-17.9	2.00 H	232	29.9	-1.8
6	665.37	33.0 QP	46.0	-13.0	1.00 H	328	31.9	1.1

REMARKS:

1. Emission Level(dBuV/m) = Raw Value(dBuV) + Correction Factor(dB/m)
2. Correction Factor(dB/m) = Antenna Factor(dB/m) + Cable Factor(dB) – Pre-Amplifier Factor(dB)
3. Margin value = Emission Level – Limit value
4. The emission levels were very low against the limit of frequency range 9kHz~30MHz: the amplitude of spurious emissions attenuated more than 20 dB below the permissible value to be report.

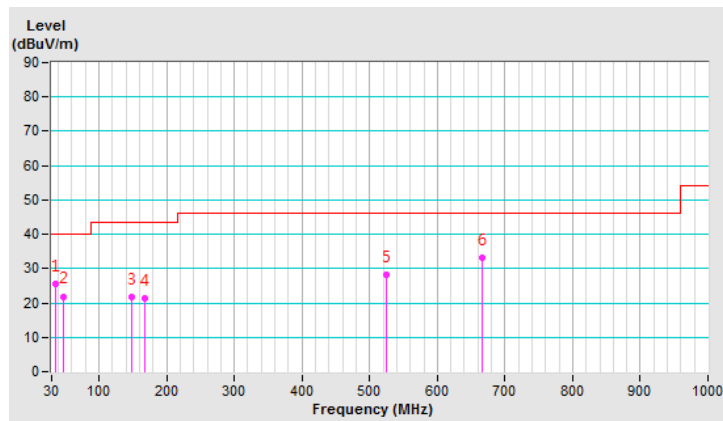

CHANNEL	TX Channel 78	DETECTOR FUNCTION	Quasi-Peak (QP)
FREQUENCY RANGE	9kHz ~ 1GHz		

ANTENNA POLARITY & TEST DISTANCE: VERTICAL AT 3 M								
NO.	FREQ. (MHz)	EMISSION LEVEL (dBuV/m)	LIMIT (dBuV/m)	MARGIN (dB)	ANTENNA HEIGHT (m)	TABLE ANGLE (Degree)	RAW VALUE (dBuV)	CORRECTION FACTOR (dB/m)
1	35.34	26.9 QP	40.0	-13.1	1.00 V	342	36.8	-9.9
2	41.52	24.2 QP	40.0	-15.8	1.00 V	97	33.5	-9.3
3	139.32	21.8 QP	43.5	-21.7	1.50 V	360	30.4	-8.6
4	173.39	20.5 QP	43.5	-23.0	1.50 V	172	29.7	-9.2
5	337.39	24.1 QP	46.0	-21.9	1.00 V	283	30.2	-6.1
6	696.29	31.9 QP	46.0	-14.1	1.50 V	27	30.2	1.7

REMARKS:

1. Emission Level(dBuV/m) = Raw Value(dBuV) + Correction Factor(dB/m)
2. Correction Factor(dB/m) = Antenna Factor(dB/m) + Cable Factor(dB) – Pre-Amplifier Factor(dB)
3. Margin value = Emission Level – Limit value
4. The emission levels were very low against the limit of frequency range 9kHz~30MHz: the amplitude of spurious emissions attenuated more than 20 dB below the permissible value to be report.

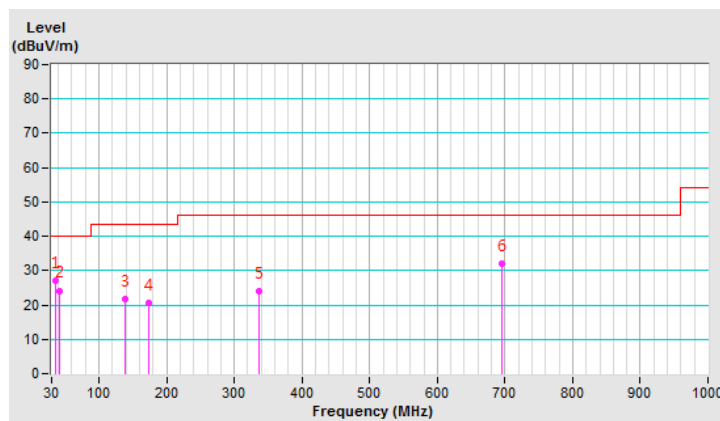

4.2 Conducted Emission Measurement

4.2.1 Limits of Conducted Emission Measurement

Frequency (MHz)	Conducted Limit (dBuV)	
	Quasi-peak	Average
0.15 - 0.5	66 - 56	56 - 46
0.50 - 5.0	56	46
5.0 - 30.0	60	50

Note: 1. The lower limit shall apply at the transition frequencies.

2. The limit decreases in line with the logarithm of the frequency in the range of 0.15 to 0.50MHz.

4.2.2 Test Instruments

DESCRIPTION & MANUFACTURER	MODEL NO.	SERIAL NO.	CALIBRATED DATE	CALIBRATED UNTIL
Test Receiver R&S	ESCS 30	847124/029	Oct. 24, 2018	Oct. 23, 2019
Line-Impedance Stabilization Network (for EUT) R&S	ESH3-Z5	848773/004	Oct. 22, 2018	Oct. 21, 2019
Line-Impedance Stabilization Network (for Peripheral) R&S	ENV216	100072	June 04, 2018	June 03, 2019
50 ohms Terminator	N/A	3	Oct. 22, 2018	Oct. 21, 2019
RF Cable	5D-FB	COCCAB-001	Sep. 28, 2018	Sep. 27, 2019
Fixed attenuator EMCI	STI02-2200-10	003	Mar. 16, 2018	Mar. 15, 2019
Software BVADT	BVADT_Cond_ V7.3.7.4	NA	NA	NA

Note:

1. The calibration interval of the above test instruments are 12 months and the calibrations are traceable to NML/ROC and NIST/USA.
2. The test was performed in Conduction 1.
3. Tested Date: Jan. 12, 2019

4.2.3 Test Procedures

- The EUT was placed 0.4 meters from the conducting wall of the shielded room with EUT being connected to the power mains through a line impedance stabilization network (LISN). Other support units were connected to the power mains through another LISN. The two LISNs provide 50 ohm/ 50uH of coupling impedance for the measuring instrument.
- Both lines of the power mains connected to the EUT were checked for maximum conducted interference.
- The frequency range from 150kHz to 30MHz was searched. Emission levels under (Limit - 20dB) was not recorded.

NOTE: The resolution bandwidth and video bandwidth of test receiver is 9kHz for quasi-peak detection (QP) and average detection (AV) at frequency 0.15MHz-30MHz.

4.2.4 Deviation from Test Standard

No deviation.

4.2.5 Test Setup

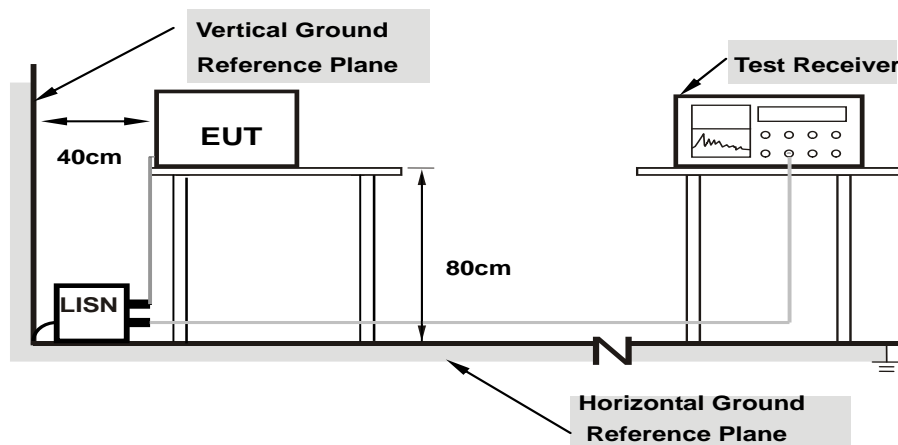

Note: 1.Support units were connected to second LISN.

For the actual test configuration, please refer to the attached file (Test Setup Photo).

4.2.6 EUT Operating Condition

Same as 4.1.6.

4.2.7 Test Results

Phase	Line (L)	Detector Function	Quasi-Peak (QP) / Average (AV)
-------	----------	-------------------	--------------------------------

No	Freq. [MHz]	Corr. Factor	Reading Value [dB (uV)]		Emission Level [dB (uV)]		Limit [dB (uV)]		Margin (dB)	
		(dB)	Q.P.	AV.	Q.P.	AV.	Q.P.	AV.	Q.P.	AV.
	1	0.15000	10.02	37.36	26.67	47.38	36.69	66.00	56.00	-18.62
2	0.21250	10.04	27.53	13.79	37.57	23.83	63.11	53.11	-25.54	-29.28
3	0.48203	10.08	29.66	24.85	39.74	34.93	56.30	46.30	-16.56	-11.37
4	0.82578	10.10	13.34	6.53	23.44	16.63	56.00	46.00	-32.56	-29.37
5	2.88672	10.20	19.19	11.53	29.39	21.73	56.00	46.00	-26.61	-24.27
6	22.47656	11.11	16.48	10.24	27.59	21.35	60.00	50.00	-32.41	-28.65

REMARKS:

1. Q.P. and AV. are abbreviations of quasi-peak and average individually.
2. The emission levels of other frequencies were very low against the limit.
3. Margin value = Emission level - Limit value
4. Correction factor = Insertion loss + Cable loss
5. Emission Level = Correction Factor + Reading Value.

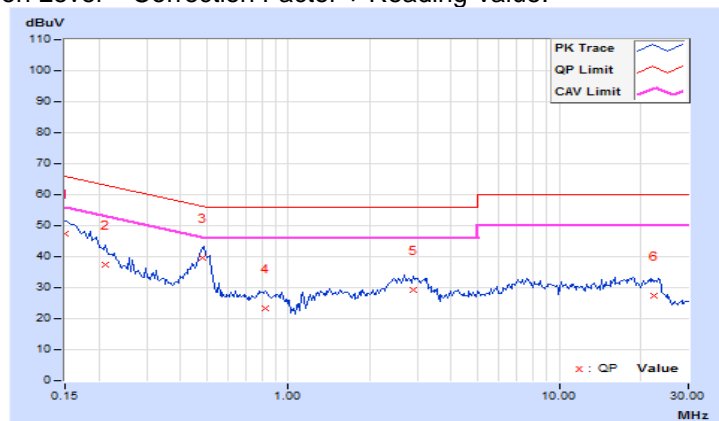

Phase	Neutral (N)	Detector Function	Quasi-Peak (QP) / Average (AV)
-------	-------------	-------------------	--------------------------------

No	Freq. [MHz]	Corr. Factor	Reading Value [dB (uV)]		Emission Level [dB (uV)]		Limit [dB (uV)]		Margin (dB)	
		(dB)	Q.P.	AV.	Q.P.	AV.	Q.P.	AV.	Q.P.	AV.
	1	0.15391	9.93	37.44	27.55	47.37	37.48	65.79	55.79	-18.42
2	0.48594	9.96	29.76	23.85	39.72	33.81	56.24	46.24	-16.52	-12.43
3	0.69688	9.97	15.96	7.92	25.93	17.89	56.00	46.00	-30.07	-28.11
4	2.67578	10.07	18.81	12.49	28.88	22.56	56.00	46.00	-27.12	-23.44
5	7.20313	10.26	19.23	13.58	29.49	23.84	60.00	50.00	-30.51	-26.16
6	22.16406	10.89	16.47	10.31	27.36	21.20	60.00	50.00	-32.64	-28.80

REMARKS:

1. Q.P. and AV. are abbreviations of quasi-peak and average individually.
2. The emission levels of other frequencies were very low against the limit.
3. Margin value = Emission level - Limit value
4. Correction factor = Insertion loss + Cable loss
5. Emission Level = Correction Factor + Reading Value.

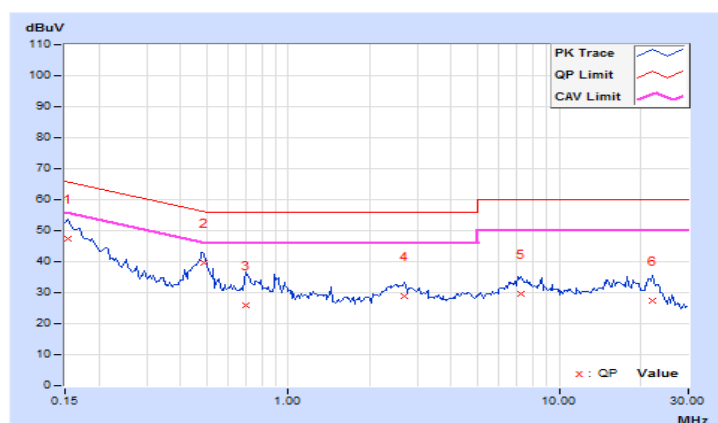

4.3 Number of Hopping Frequency Used

4.3.1 Limits of Hopping Frequency Used Measurement

At least 15 channels frequencies, and should be equally spaced.

4.3.2 Test Setup

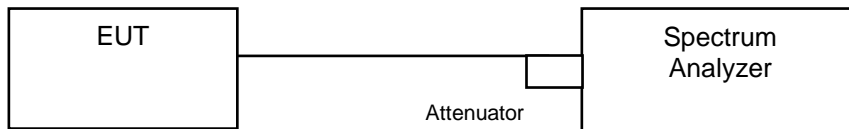

4.3.3 Test Instruments

Refer to section 4.1.2 to get information of above instrument.

4.3.4 Test Procedure

- a. Check the calibration of the measuring instrument (SA) using either an internal calibrator or a known signal from an external generator.
- b. Turn on the EUT and connect its antenna terminal to measurement via a low loss cable. Then set it to any one measured frequency within its operating range and make sure the instrument is operated in its linear range.
- c. Set the SA on MaxHold Mode, and then keep the EUT in hopping mode. Record all the signals from each channel until each one has been recorded.
- d. Set the SA on View mode and then plot the result on SA screen.
- e. Repeat above procedures until all frequencies measured were complete.

4.3.5 Deviation from Test Standard

No deviation.

4.3.6 Test Results

There are 79 hopping frequencies in the hopping mode. Please refer to next page for the test result. On the plots, it shows that the hopping frequencies are equally spaced.

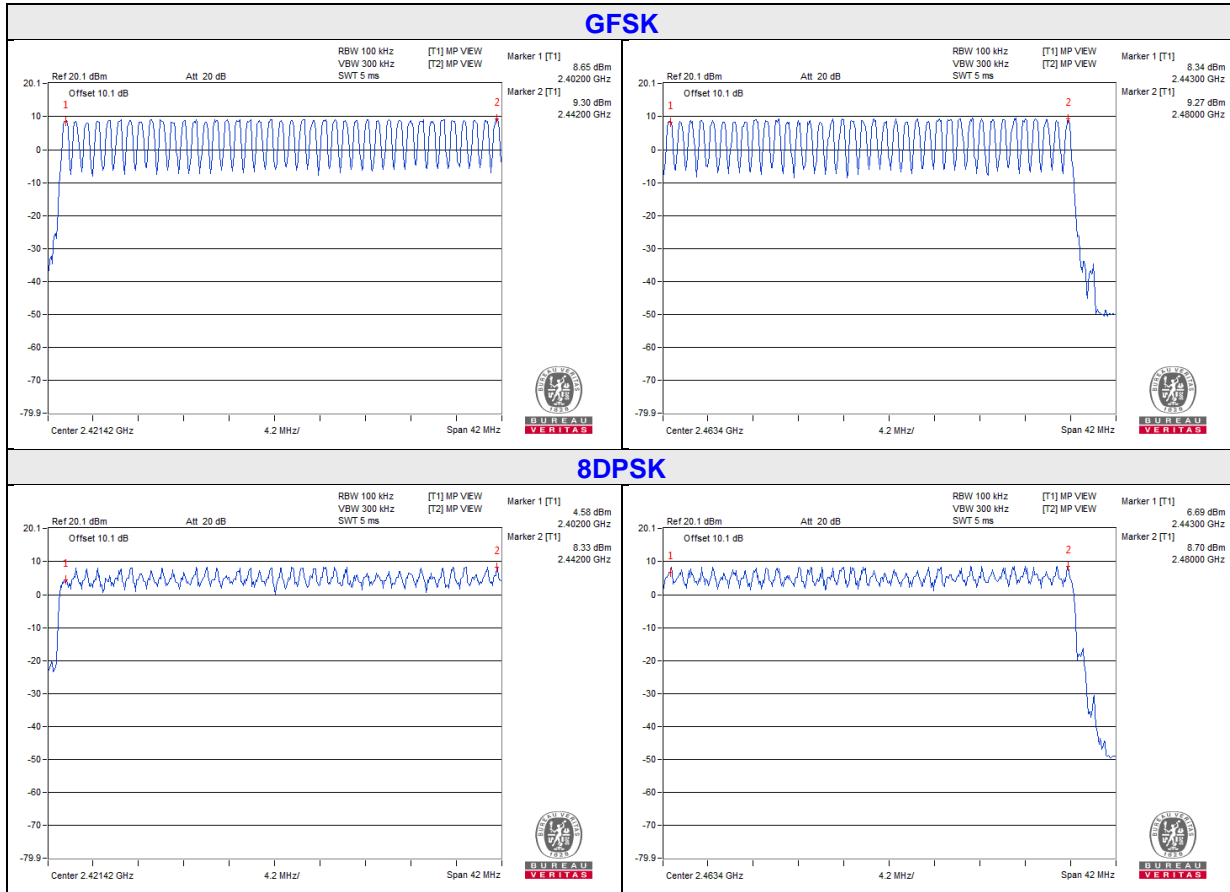

4.4 Dwell Time on Each Channel

4.4.1 Limits of Dwell Time on Each Channel Measurement

The average time of occupancy on any channel shall not be greater than 0.4 seconds within a period of 0.4 seconds multiplied by the number of hopping channels employed.

4.4.2 Test Setup

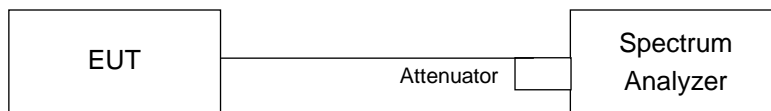

4.4.3 Test Instruments

Refer to section 4.1.2 to get information of above instrument.

4.4.4 Test Procedures

- Check the calibration of the measuring instrument (SA) using either an internal calibrator or a known signal from an external generator.
- Turn on the EUT and connect its antenna terminal to measurement via a low loss cable. Then set it to any one measured frequency within its operating range and make sure the instrument is operated in its linear range.
- Adjust the center frequency of SA on any frequency be measured and set SA to zero span mode. And then, set RBW and VBW of spectrum analyzer to proper value.
- Measure the time duration of one transmission on the measured frequency. And then plot the result with time difference of this time duration.
- Repeat above procedures until all different time-slot modes have been completed.

4.4.5 Deviation from Test Standard

No deviation.

4.4.6 Test Results

GFSK

Mode	Number of transmission in a 31.6 (79Hopping*0.4)	Length of transmission time (msec)	Result (msec)	Limit (msec)
DH1	50 (times / 5 sec) * 6.32 = 316 times	0.474	149.78	400
DH3	26 (times / 5 sec) * 6.32 = 164.32 times	1.71	280.99	400
DH5	17 (times / 5 sec) * 6.32 = 107.44 times	3.04	326.62	400

NOTE: Test plots of the transmitting time slot are shown on next page.

DH1

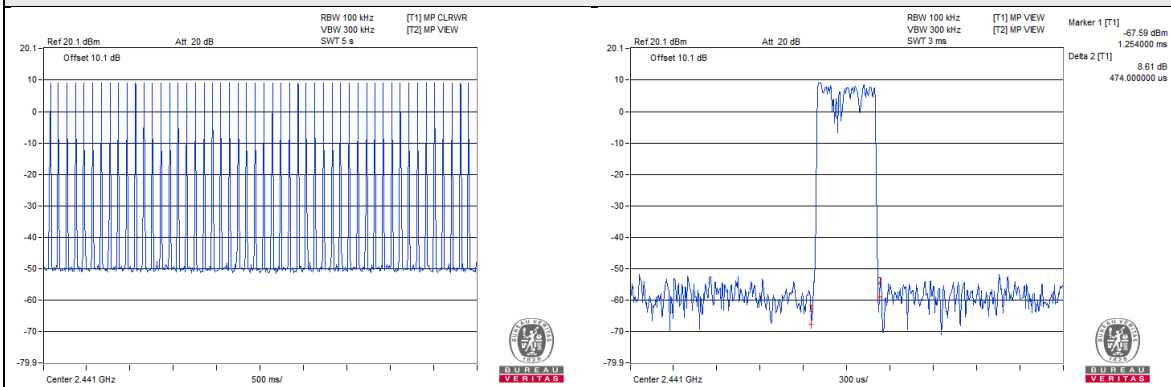

DH3

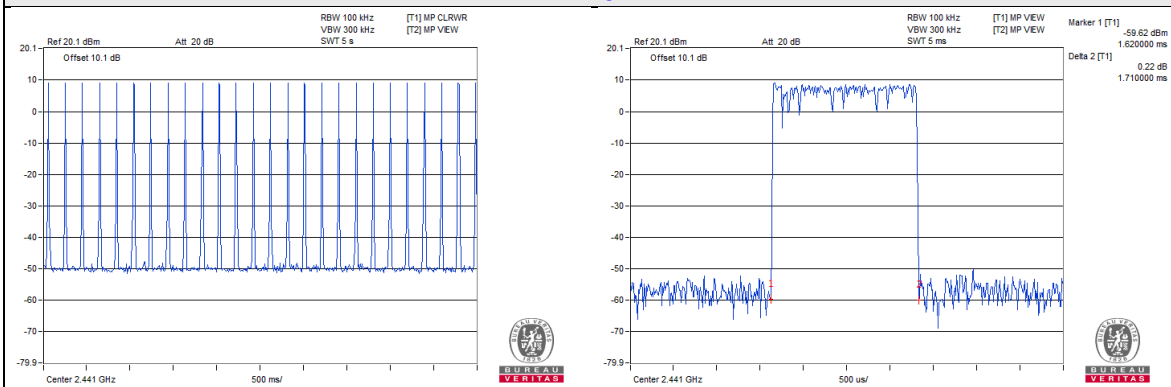

DH5

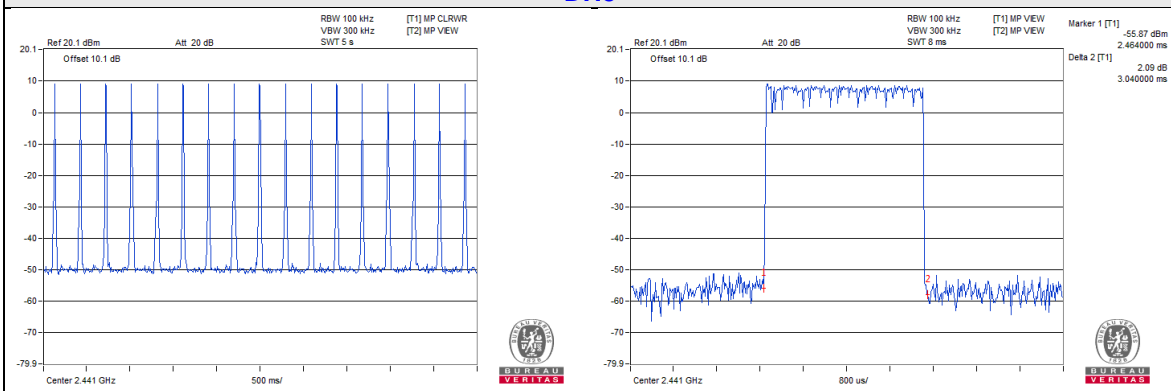

8DPSK

Mode	Number of transmission in a 31.6 (79Hopping*0.4)	Length of transmission time (msec)	Result (msec)	Limit (msec)
3DH1	50 (times / 5 sec) * 6.32 = 316 times	0.468	147.89	400
3DH3	26 (times / 5 sec) * 6.32 = 164.32 times	1.76	289.2	400
3DH5	17 (times / 5 sec) * 6.32 = 107.44 times	2.992	321.46	400

NOTE: Test plots of the transmitting time slot are shown on next page.

3DH1

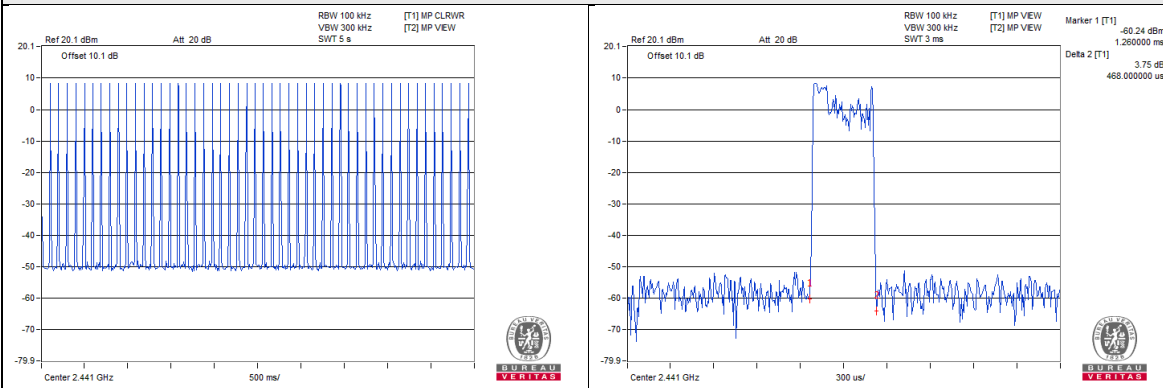

3DH3

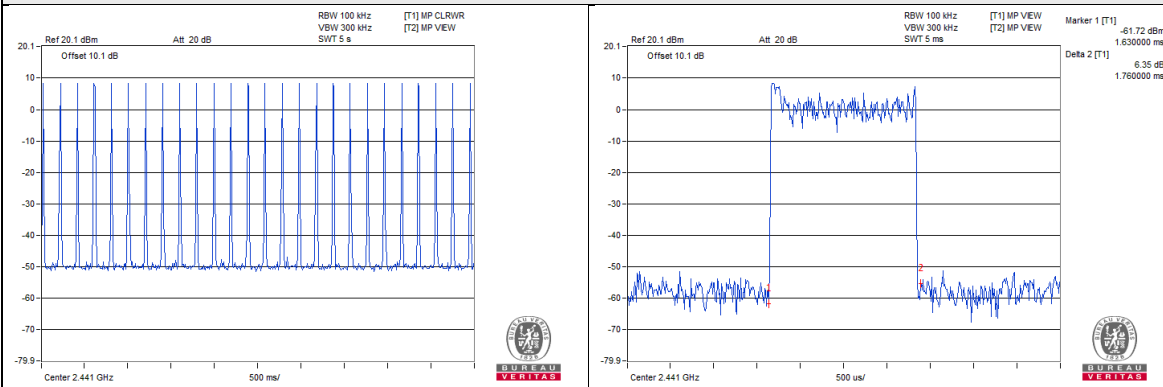

3DH5

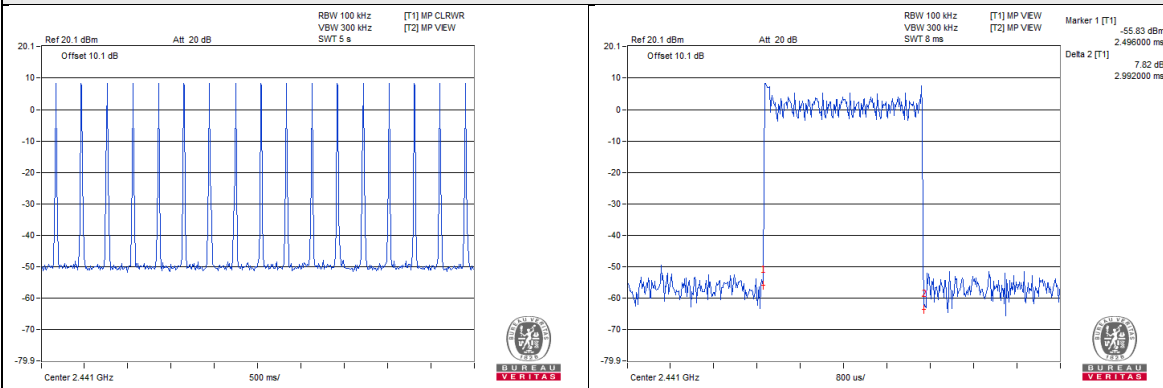

4.5 Channel Bandwidth

4.5.1 Limits of Channel Bandwidth Measurement

For frequency hopping system operating in the 2400-2483.5MHz, If the 20dB bandwidth of hopping channel is greater than 25kHz, two-thirds 20dB bandwidth of hopping channel shall be a minimum limit for the hopping channel separation.

4.5.2 Test Setup

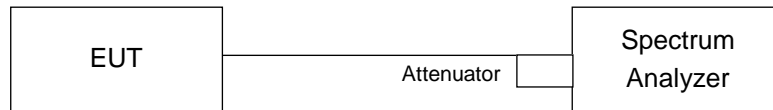

4.5.3 Test Instruments

Refer to section 4.1.2 to get information of above instrument.

4.5.4 Test Procedure

- Check the calibration of the measuring instrument using either an internal calibrator or a known signal from an external generator.
- Turn on the EUT and connect it to measurement instrument. Then set it to any one convenient frequency within its operating range. Set a reference level on the measuring instrument equal to the highest peak value.
- Measure the frequency difference of two frequencies that were attenuated 20dB from the reference level. Record the frequency difference as the emission bandwidth.
- Repeat above procedures until all frequencies measured were complete.

4.5.5 Deviation from Test Standard

No deviation.

4.5.6 EUT Operating Condition

The software provided by client enabled the EUT to transmit and receive data at lowest, middle and highest channel frequencies individually.

4.5.7 Test Results

Channel	Frequency (MHz)	20dB Bandwidth (MHz)	
		GFSK	8DPSK
0	2402	0.94	1.28
39	2441	0.94	1.30
78	2480	0.94	1.28

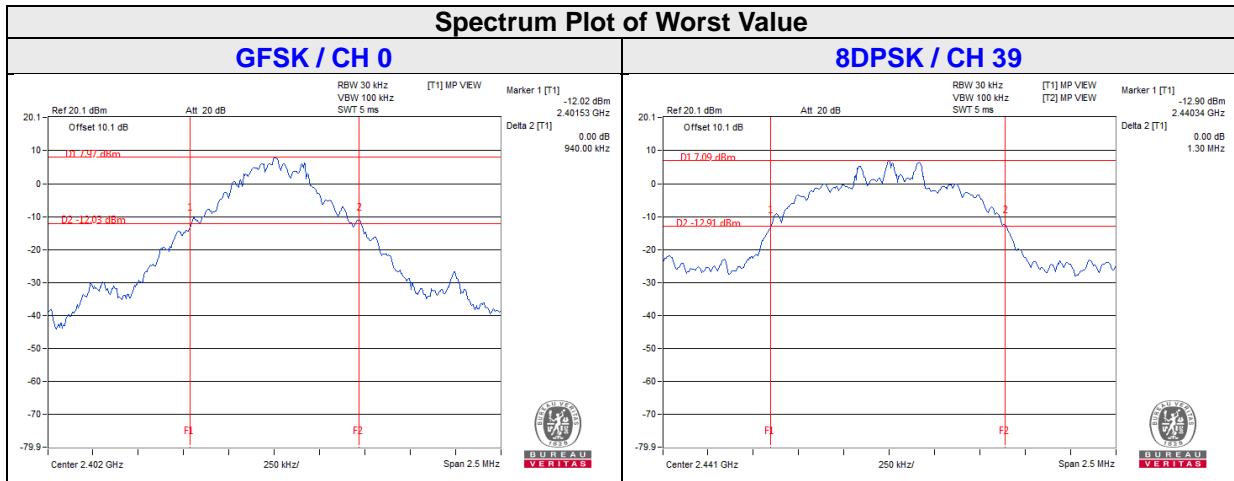

4.6 Hopping Channel Separation

4.6.1 Limits of Hopping Channel Separation Measurement

At least 25kHz or two-third of 20dB hopping channel bandwidth (whichever is greater).

4.6.2 Test Setup

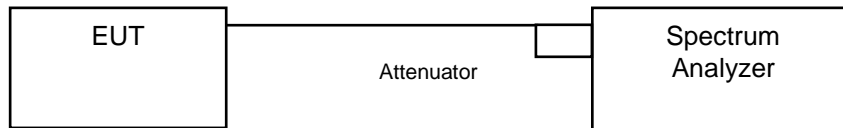

4.6.3 Test Instruments

Refer to section 4.1.2 to get information of above instrument.

4.6.4 Test Procedure

Measurement Procedure REF

- a. Check the calibration of the measuring instrument using either an internal calibrator or a known signal from an external generator.
- b. Turn on the EUT and connect it to measurement instrument. Then set it to any one convenient frequency within its operating range.
- c. By using the MaxHold function record the separation of two adjacent channels.
- d. Measure the frequency difference of these two adjacent channels by SA MARK function. And then plot the result on SA screen.
- e. Repeat above procedures until all frequencies measured were complete.

4.6.5 Deviation from Test Standard

No deviation.

4.6.6 Test Results

Channel	Frequency (MHz)	Adjacent Channel Separation (MHz)		20dB Bandwidth (MHz)		Minimum Limit (MHz)		Pass / Fail
		GFSK	8DPSK	GFSK	8DPSK	GFSK	8DPSK	
0	2402	1.00	1.00	0.94	1.28	0.63	0.86	Pass
39	2441	1.00	1.00	0.94	1.30	0.63	0.87	Pass
78	2480	1.00	1.00	0.94	1.28	0.63	0.86	Pass

NOTE: The minimum limit is two-third 20dB bandwidth.

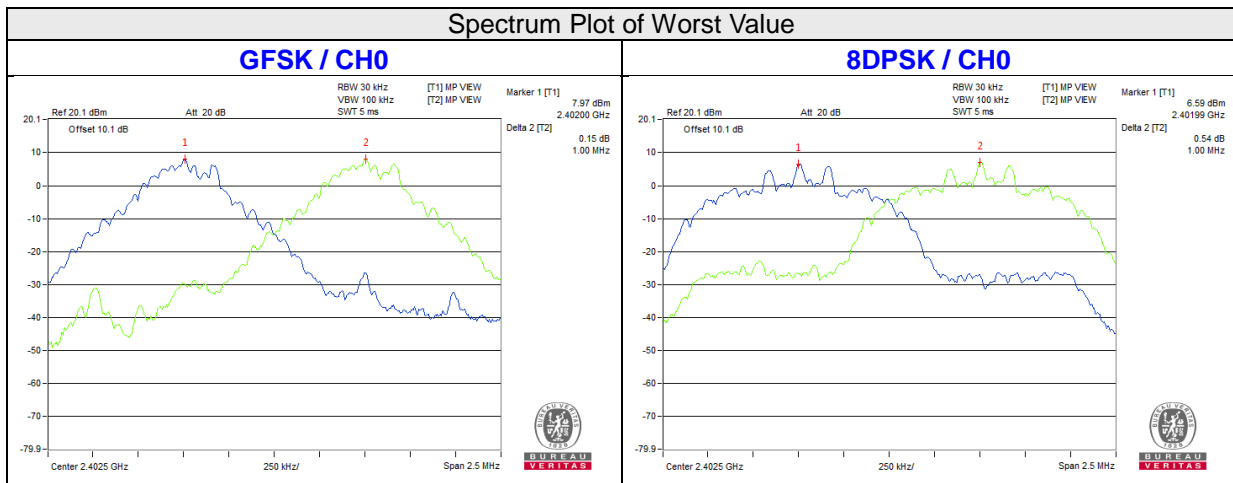

4.7 Maximum Output Power

4.7.1 Limits of Maximum Output Power Measurement

The Maximum Output Power Measurement is 125mW.

4.7.2 Test Setup

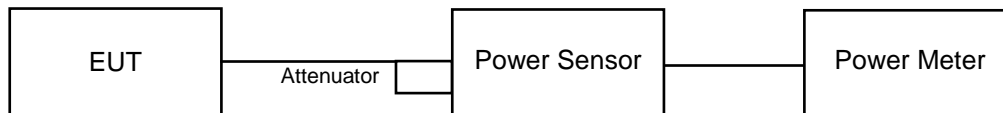

4.7.3 Test Instruments

Refer to section 4.1.2 to get information of above instrument.

4.7.4 Test Procedure

A peak power sensor was used on the output port of the EUT. A power meter was used to read the response of the peak power sensor. Record the power level.

Average power sensor was used to perform output power measurement, trigger and gating function of wide band power meter is enabled to measure max output power of TX on burst. Duty factor is not added to measured value.

4.7.5 Deviation from Test Standard

No deviation.

4.7.6 EUT Operating Condition

The software provided by client enabled the EUT to transmit and receive data at lowest, middle and highest channel frequencies individually.

4.7.7 Test Results

FOR PEAK POWER

Channel	Frequency (MHZ)	Output Power (mW)		Output Power (dBm)		Power Limit (mW)	Pass / Fail
		GFSK	8DPSK	GFSK	8DPSK		
0	2402	3.963	6.427	5.98	8.08	125	Pass
39	2441	4.009	6.546	6.03	8.16	125	Pass
78	2480	4.102	6.516	6.13	8.14	125	Pass

FOR AVERAGE POWER

Channel	Frequency (MHZ)	Average Power (mW)		Average Power (dBm)	
		GFSK	8DPSK	GFSK	8DPSK
0	2402	3.597	3.54	5.56	5.49
39	2441	3.648	3.606	5.62	5.57
78	2480	3.724	3.589	5.71	5.55

4.8 Conducted Out of Band Emission Measurement

4.8.1 Limits of Conducted Out of Band Emission Measurement

Below -20dB of the highest emission level of operating band (in 100kHz Resolution Bandwidth).

4.8.2 Test Instruments

Refer to section 4.1.2 to get information of above instrument.

4.8.3 Test Procedure

The transmitter output was connected to the spectrum analyzer via a low lose cable. Set both RBW and VBW of spectrum analyzer to 100 kHz and 300 kHz with suitable frequency span including 100 MHz bandwidth from band edge. The band edges was measured and recorded.

4.8.4 Deviation from Test Standard

No deviation.

4.8.5 EUT Operating Condition

The software provided by client enabled the EUT to transmit and receive data at lowest, middle and highest channel frequencies individually.

4.8.6 Test Results

The spectrum plots are attached on the following images. D1 line indicates the highest level, D2 line indicates the 20dB offset below D1. It shows compliance with the requirement.

GFSK

Hopping disabled_Low Channel

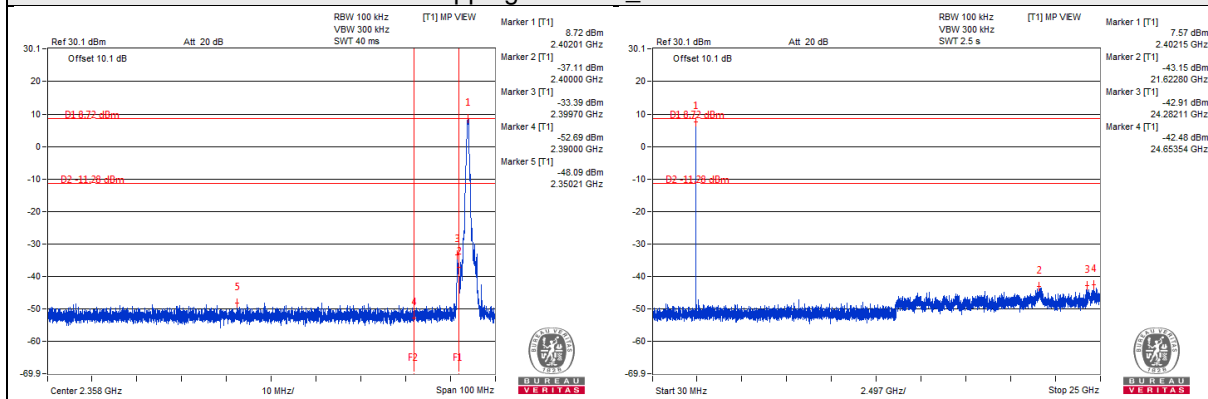

Hopping disabled_High Channel

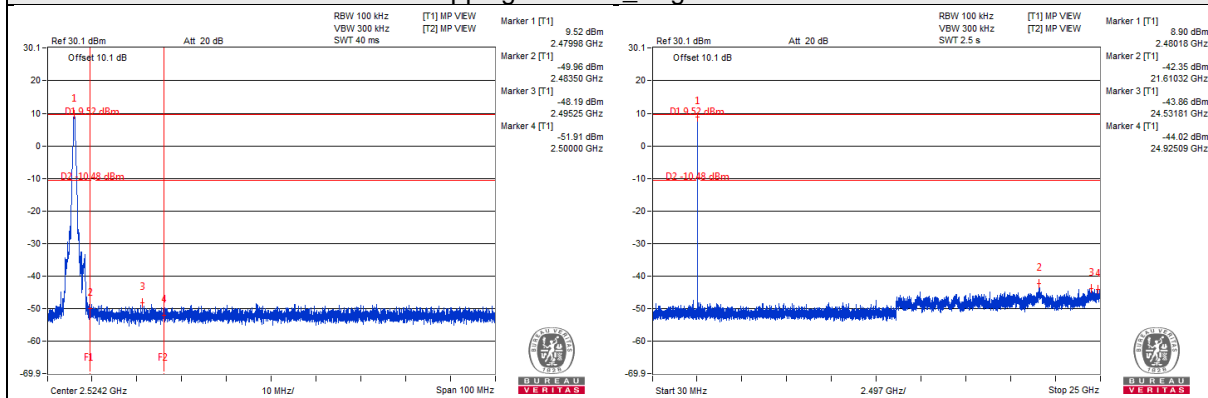

Hopping enabled_Low Channel

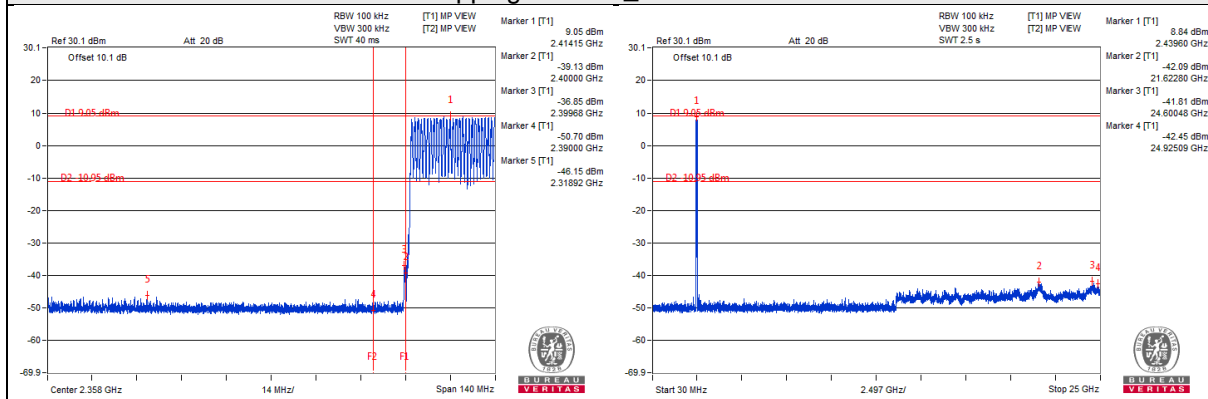

Hopping enabled_High Channel

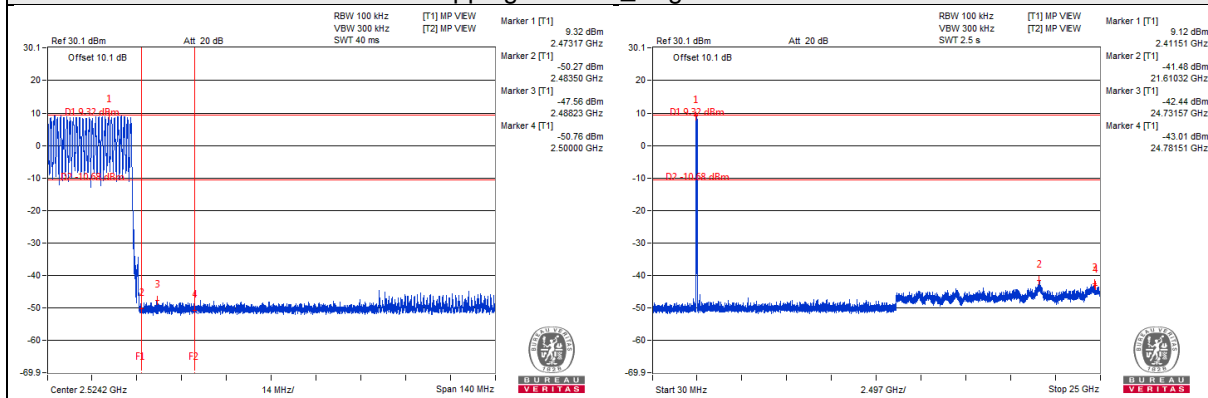

8DPSK

Hopping disabled_Low Channel

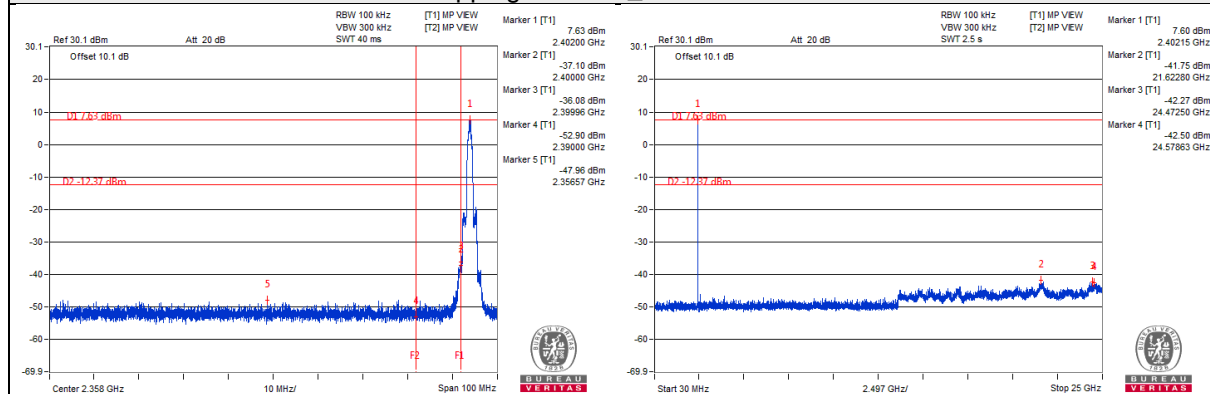

Hopping disabled_High Channel

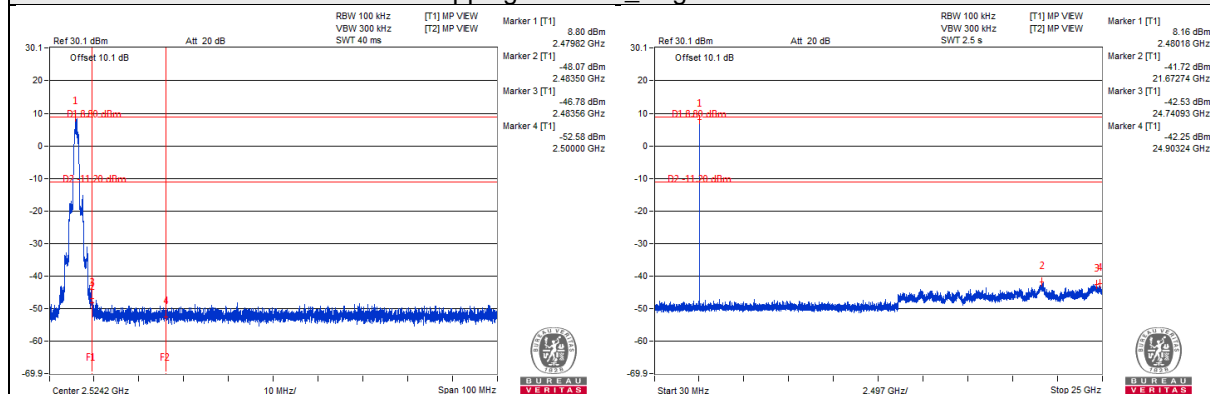

Hopping enabled_Low Channel

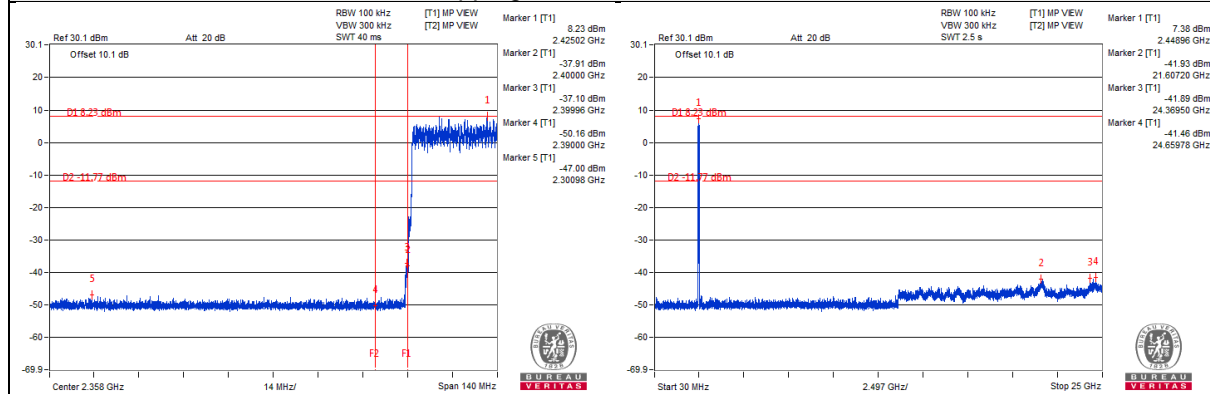

Hopping enabled_High Channel

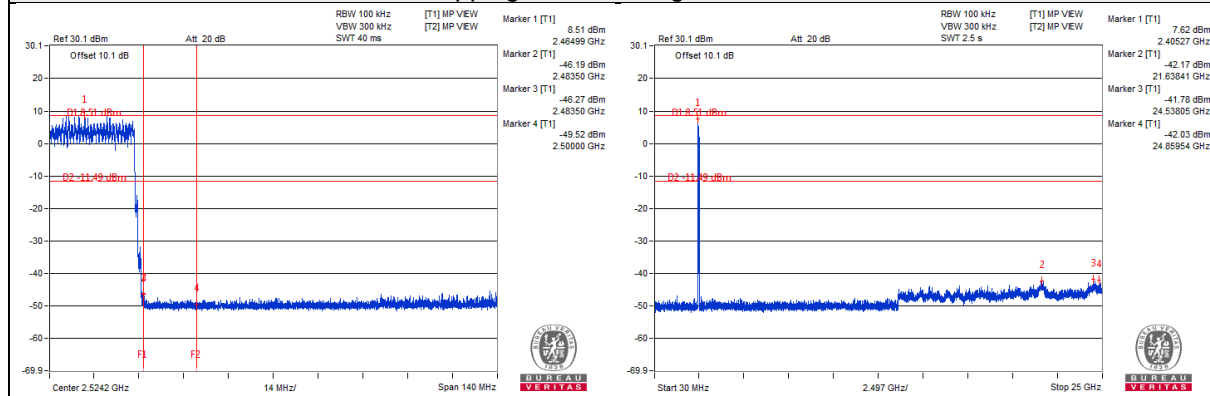

5 Pictures of Test Arrangements

Please refer to the attached file (Test Setup Photo).

Appendix – Information of the Testing Laboratories

We, Bureau Veritas Consumer Products Services (H.K.) Ltd., Taoyuan Branch, were founded in 1988 to provide our best service in EMC, Radio, Telecom and Safety consultation. Our laboratories are FCC recognized accredited test firms and accredited according to ISO/IEC 17025.

If you have any comments, please feel free to contact us at the following:

Linkou EMC/RF Lab

Tel: 886-2-26052180

Fax: 886-2-26051924

Hsin Chu EMC/RF/Telecom Lab

Tel: 886-3-6668565

Fax: 886-3-6668323

Hwa Ya EMC/RF/Safety Lab

Tel: 886-3-3183232

Fax: 886-3-3270892

Email: service.adt@tw.bureauveritas.com

Web Site: www.bureauveritas-adt.com

The address and road map of all our labs can be found in our web site also.

--- END ---