

FCC Test Report

Report No.: RF140107C15L-4

FCC ID: JNF-Z-224X

Test Model: Z-2242

Series Model: Z-2240

Received Date: Dec. 26, 2013

Test Date: May 27 ~ Aug. 26, 2015 (For all tests except AC Power Conducted Emission & Radiated Emissions (Frequency below 1GHz))

Dec. 01, 2015 ~ Jan. 30, 2016 (For AC Power Conducted Emission & Radiated Emissions (Frequency below 1GHz))

Issued Date: Feb. 02, 2016

Applicant: ZEBEX INDUSTRIES INC.

Address: B1F.-1, No. 207, Sec. 3, Beixin Rd, Xindian Dist, New Taipei City 23143, Taiwan

Issued By: Bureau Veritas Consumer Products Services (H.K.) Ltd., Taoyuan Branch

Lab Address: No. 47-2, 14th Ling, Chia Pau Vil., Lin Kou Dist., New Taipei City, Taiwan

Test Location: No. 19, Hwa Ya 2nd Rd., Wen Hwa Vil., Kwei Shan Dist., Taoyuan City 33383, TAIWAN (R.O.C.)



This report is for your exclusive use. Any copying or replication of this report to or for any other person or entity, or use of our name or trademark, is permitted only with our prior written permission. This report sets forth our findings solely with respect to the test samples identified herein. The results set forth in this report are not indicative or representative of the quality or characteristics of the lot from which a test sample was taken or any similar or identical product unless specifically and expressly noted. Our report includes all of the tests requested by you and the results thereof based upon the information that you provided to us. You have 60 days from date of issuance of this report to notify us of any material error or omission caused by our negligence, provided, however, that such notice shall be in writing and shall specifically address the issue you wish to raise. A failure to raise such issue within the prescribed time shall constitute your unqualified acceptance of the completeness of this report, the tests conducted and the correctness of the report contents. Unless specific mention, the uncertainty of measurement has been explicitly taken into account to declare the compliance or non-compliance to the specification. The report must not be used by the client to claim product certification, approval, or endorsement by TAF or any government agencies.

Table of Contents

Release Control Record	4
1 Certificate of Conformity	5
2 Summary of Test Results	6
2.1 Measurement Uncertainty.....	6
2.2 Modification Record.....	6
3 General Information	7
3.1 General Description of EUT.....	7
3.2 Description of Test Modes.....	9
3.2.1 Test Mode Applicability and Tested Channel Detail.....	10
3.3 Duty Cycle of Test Signal.....	12
3.4 Description of Support Units.....	13
3.4.1 Configuration of System under Test.....	13
3.5 General Description of Applied Standards.....	14
4 Test Types and Results	15
4.1 Radiated Emission and Bandedge Measurement.....	15
4.1.1 Limits of Radiated Emission and Bandedge Measurement.....	15
4.1.2 Test Instruments.....	16
4.1.3 Test Procedures.....	18
4.1.4 Deviation from Test Standard.....	18
4.1.5 Test Set Up.....	19
4.1.6 EUT Operating Conditions.....	19
4.1.7 Test Results.....	20
4.2 Conducted Emission Measurement.....	34
4.2.1 Limits of Conducted Emission Measurement.....	34
4.2.2 Test Instruments.....	34
4.2.3 Test Procedures.....	34
4.2.4 Deviation from Test Standard.....	35
4.2.5 Test Setup.....	35
4.2.6 EUT Operating Conditions.....	35
4.2.7 Test Results.....	36
4.3 6dB Bandwidth Measurement.....	38
4.3.1 Limits of 6dB Bandwidth Measurement.....	38
4.3.2 Test Setup.....	38
4.3.3 Test Instruments.....	38
4.3.4 Test Procedure.....	38
4.3.5 Deviation from Test Standard.....	38
4.3.6 EUT Operating Conditions.....	38
4.3.7 Test Result.....	39
4.4 Conducted Output Power Measurement.....	41
4.4.1 Limits of Conducted Output Power Measurement.....	41
4.4.2 Test Setup.....	41
4.4.3 Test Instruments.....	41
4.4.4 Test Procedures.....	41
4.4.5 Deviation from Test Standard.....	41
4.4.6 EUT Operating Conditions.....	41
4.4.7 Test Results.....	42
4.5 Power Spectral Density Measurement.....	44
4.5.1 Limits of Power Spectral Density Measurement.....	44
4.5.2 Test Setup.....	44
4.5.3 Test Instruments.....	44
4.5.4 Test Procedure.....	44
4.5.5 Deviation from Test Standard.....	44
4.5.6 EUT Operating Condition.....	44



4.5.7 Test Results	45
4.6 Conducted Out of Band Emission Measurement.....	47
4.6.1 Limits of Conducted Out of Band Emission Measurement	47
4.6.2 Test Setup.....	47
4.6.3 Test Instruments	47
4.6.4 Test Procedure	47
4.6.5 Deviation from Test Standard	47
4.6.6 EUT Operating Condition	47
4.6.7 Test Results	47
5 Pictures of Test Arrangements.....	52
Appendix – Information on the Testing Laboratories	53



A D T

Release Control Record

Issue No.	Description	Date Issued
RF140107C15L-4	Original release.	Feb. 02, 2016

1 Certificate of Conformity

Product: Rugged Mobile Handheld Computer
Brand: ZEBEX
Test Model: Z-2242
Series Model: Z-2240
Sample Status: MASS-PRODUCTION
Applicant: ZEBEX INDUSTRIES INC.
Test Date: May 27 ~ Aug. 26, 2015 (For all tests except AC Power Conducted Emission & Radiated Emissions (Frequency below 1GHz))
Dec. 01, 2015 ~ Jan. 30, 2016 (For AC Power Conducted Emission & Radiated Emissions (Frequency below 1GHz))
Standards: 47 CFR FCC Part 15, Subpart C (Section 15.247)
ANSI C63.10: 2013

The above equipment has been tested by **Bureau Veritas Consumer Products Services (H.K.) Ltd., Taoyuan Branch**, and found compliance with the requirement of the above standards. The test record, data evaluation & Equipment Under Test (EUT) configurations represented herein are true and accurate accounts of the measurements of the sample's EMC characteristics under the conditions specified in this report.

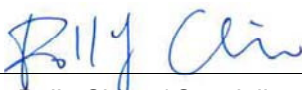
Prepared by :  , **Date:** Feb. 02, 2016
Polly Chien / Specialist

Approved by :  , **Date:** Feb. 02, 2016
Ken Liu / Senior Manager

2 Summary of Test Results

47 CFR FCC Part 15, Subpart C (SECTION 15.247)			
FCC Clause	Test Item	Result	Remarks
15.207	AC Power Conducted Emission	PASS	Meet the requirement of limit. Minimum passing margin is -11.92dB at 0.38828MHz.
15.205 / 15.209 / 15.247(d)	Radiated Emissions and Band Edge Measurement	PASS	Meet the requirement of limit. Minimum passing margin is -1.6dB at 2483.50MHz.
15.247(d)	Antenna Port Emission	PASS	Meet the requirement of limit.
15.247(a)(2)	6dB bandwidth	PASS	Meet the requirement of limit.
15.247(b)	Conducted power	PASS	Meet the requirement of limit.
15.247(e)	Power Spectral Density	PASS	Meet the requirement of limit.
15.203	Antenna Requirement	PASS	Antenna connector is IPEX not a standard connector.

2.1 Measurement Uncertainty

Where relevant, the following measurement uncertainty levels have been estimated for tests performed on the EUT as specified in CISPR 16-4-2:

Tested date: May 27 ~ Jun. 16, 2015

Measurement	Frequency	Expanded Uncertainty (k=2) (±)
Radiated Emissions above 1 GHz	1GHz ~ 18GHz	2.29 dB
	18GHz ~ 40GHz	2.29 dB

Tested date: Aug. 25, 2015 ~ Jan. 31, 2016

Measurement	Frequency	Expanded Uncertainty (k=2) (±)
Conducted Emissions at mains ports	150kHz ~ 30MHz	2.44 dB
Radiated Emissions up to 1 GHz	30MHz ~ 200MHz	3.63 dB
	200MHz ~ 1000MHz	3.64 dB

2.2 Modification Record

There were no modifications required for compliance.

3 General Information

3.1 General Description of EUT

Product	Rugged Mobile Handheld Computer
Brand	ZEBEX
Test Model	Z-2242
Series Model	Z-2240
Model Difference	Refer to note as below
Status of EUT	MASS-PRODUCTION
Power Supply Rating	3.7Vdc (Battery) 5.35Vdc (Adapter) 5.0Vdc (Cradle) 19Vdc (Wireless Power Charger)
Modulation Type	CCK, DQPSK, DBPSK for DSSS 64QAM, 16QAM, QPSK, BPSK for OFDM
Modulation Technology	DSSS, OFDM
Transfer Rate	802.11b: 11.0/ 5.5/ 2.0/ 1.0Mbps 802.11g: 54.0/ 48.0/ 36.0/ 24.0/ 18.0/ 12.0/ 9.0/ 6.0Mbps 802.11n: up to 72.2Mbps
Operating Frequency	2412 ~ 2462MHz
Number of Channel	11 for 802.11b, 802.11g, 802.11n (HT20) 7 for 802.11n (HT40)
Output Power	258.226mW
Antenna Type	PIFA antenna with 2.20dBi gain
Antenna Connector	IPEX
Accessory Device	Refer to Note as below
Data Cable Supplied	Refer to Note as below

Note:

- All brands and models are listed as below. After pretesting, the model of the Z-2242 was worst case and chosen for final test.

Brand	Model	Description
ZEBEX	Z-2242	Barcode scanner
	Z-2240	Non-barcode scanner

For marketing purpose

- The EUT provides 1 completed transmitter and 1 receiver.

Modulation Mode	TX Function
802.11b	1TX
802.11g	1TX
802.11n (HT20)	1TX
802.11n (HT40)	1TX

3. The EUT contains the following accessories.

No.	Product	Brand	Model	Description	Remark
1	Adapter	Sunny COMPUTER TECHNOLOGY CO., LTD.	SYS1561-1105-1	Input: 100-240Vac, 1.0A MAX, 50-60Hz Output: 5.35Vdc, 2A	Accessory
2	Battery 1	ETI CA Battery inc.	BP13-001080	Rating: 3.7Vdc Capacity, 3450mA	Accessory
3	Battery 2		BP14-001160	Type: Li-ion	Accessory
4	Micro USB cable	-	-	1m shielded USB to Micro B cable without core	Accessory
5	Cradle	ZEBEX	CRD-40	Input: 5Vdc	Support unit
6	Wireless Power Charger	yardiX	CXT31106	Input: 19Vdc, 0.5A Output: 19Vdc, 0.5A	Support unit
7	Adapter (for Wireless Power Charger)	-	HNC190050U	Input: 100-240Vac, 50/60Hz, 0.35A Max Output: 19.0Vdc, 0.5A 1.55m cable with 1 core attached on adapter	Support unit

* The Battery models are electrically identical, different model names are for marketing purpose. Battery 1 was chosen for final test.

4. The above EUT information is declared by manufacturer and for more detailed features description, please refer to the manufacturer's specifications or user's manual.

3.2 Description of Test Modes

11 channels are provided for 802.11b, 802.11g and 802.11n (HT20):

Channel	Frequency	Channel	Frequency
1	2412MHz	7	2442MHz
2	2417MHz	8	2447MHz
3	2422MHz	9	2452MHz
4	2427MHz	10	2457MHz
5	2432MHz	11	2462MHz
6	2437MHz		

7 channels are provided for 802.11n (HT40):

Channel	Frequency	Channel	Frequency
3	2422MHz	7	2442MHz
4	2427MHz	8	2447MHz
5	2432MHz	9	2452MHz
6	2437MHz		

3.2.1 Test Mode Applicability and Tested Channel Detail

EUT CONFIGURE MODE	APPLICABLE TO				DESCRIPTION
	RE \geq 1G	RE $<$ 1G	PLC	APCM	
A	√	√	√	√	EUT + adapter
B	-	√	-	-	EUT + Wireless power charger

Where **RE \geq 1G**: Radiated Emission above 1GHz & Bandedge Measurement **RE $<$ 1G**: Radiated Emission below 1GHz
PLC: Power Line Conducted Emission **APCM**: Antenna Port Conducted Measurement

NOTE:

- The EUT had been pre-tested on the positioned of each 3 axis. The worst case was found when positioned on **Z-plane** for adapter mode and **X-plane** for Wireless power charger mode.
- After pre-tested adapter, cradle and EUT only modes, we found adapter mode was the worst case, therefore chosen for final tests and presented in the test report.
- “-”: Means no effect.

Radiated Emission Test (Above 1GHz):

- Pre-Scan has been conducted to determine the worst-case mode from all possible combinations between available modulations, data rates and antenna ports (if EUT with antenna diversity architecture).
- Following channel(s) was (were) selected for the final test as listed below.

EUT CONFIGURE MODE	MODE	AVAILABLE CHANNEL	TESTED CHANNEL	MODULATION TECHNOLOGY	MODULATION TYPE	DATA RATE (Mbps)
A	802.11b	1 to 11	1, 6, 11	DSSS	DBPSK	1.0
A	802.11g	1 to 11	1, 6, 11	OFDM	BPSK	6.0
A	802.11n (HT20)	1 to 11	1, 6, 11	OFDM	BPSK	6.5
A	802.11n (HT40)	3 to 9	3, 6, 9	OFDM	BPSK	13.5

Radiated Emission Test (Below 1GHz):

- Pre-Scan has been conducted to determine the worst-case mode from all possible combinations between available modulations, data rates and antenna ports (if EUT with antenna diversity architecture).
- Following channel(s) was (were) selected for the final test as listed below.

EUT CONFIGURE MODE	MODE	AVAILABLE CHANNEL	TESTED CHANNEL	MODULATION TECHNOLOGY	MODULATION TYPE	DATA RATE (Mbps)
A, B	802.11n (HT20)	1 to 11	6	OFDM	BPSK	6.5

Power Line Conducted Emission Test:

- Pre-Scan has been conducted to determine the worst-case mode from all possible combinations between available modulations, data rates and antenna ports (if EUT with antenna diversity architecture).
- Following channel(s) was (were) selected for the final test as listed below.

EUT CONFIGURE MODE	MODE	AVAILABLE CHANNEL	TESTED CHANNEL	MODULATION TECHNOLOGY	MODULATION TYPE	DATA RATE (Mbps)
A	802.11n (HT20)	1 to 11	6	OFDM	BPSK	6.5

Antenna Port Conducted Measurement:

- This item includes all test value of each mode, but only includes spectrum plot of worst value of each mode.
- Pre-Scan has been conducted to determine the worst-case mode from all possible combinations between available modulations, data rates and antenna ports (if EUT with antenna diversity architecture).
- Following channel(s) was (were) selected for the final test as listed below.

EUT CONFIGURE MODE	MODE	AVAILABLE CHANNEL	TESTED CHANNEL	MODULATION TECHNOLOGY	MODULATION TYPE	DATA RATE (Mbps)
A	802.11b	1 to 11	1, 6, 11	DSSS	DBPSK	1.0
A	802.11g	1 to 11	1, 6, 11	OFDM	BPSK	6.0
A	802.11n (HT20)	1 to 11	1, 6, 11	OFDM	BPSK	6.5
A	802.11n (HT40)	3 to 9	3, 6, 9	OFDM	BPSK	13.5

Test Condition:

APPLICABLE TO	ENVIRONMENTAL CONDITIONS	INPUT POWER	TESTED BY
RE\geq1G	25deg. C, 65%RH	120Vac, 60Hz	Tank Wu
RE$<$1G	18deg. C, 70%RH	120Vac, 60Hz	Nick Hsu
	25deg. C, 65%RH	120Vac, 60Hz	Bayu Chen
PLC	20deg. C, 70%RH	120Vac, 60Hz	Jones Chang
APCM	25deg. C, 60%RH	120Vac, 60Hz	Leo Tsai

3.3 Duty Cycle of Test Signal

Duty cycle of test signal is < 98%, duty factor shall be considered.

802.11b: Duty cycle = $8.220/8.430 = 0.975$, Duty factor = $10 * \log(1/0.975) = 0.11$

802.11g: Duty cycle = $1.363/1.581 = 0.862$, Duty factor = $10 * \log(1/0.862) = 0.64$

802.11n (HT20): Duty cycle = $1.274/1.484 = 0.858$, Duty factor = $10 * \log(1/0.858) = 0.67$

802.11n (HT40): Duty cycle = $0.631/0.754 = 0.837$, Duty factor = $10 * \log(1/0.837) = 1.27$

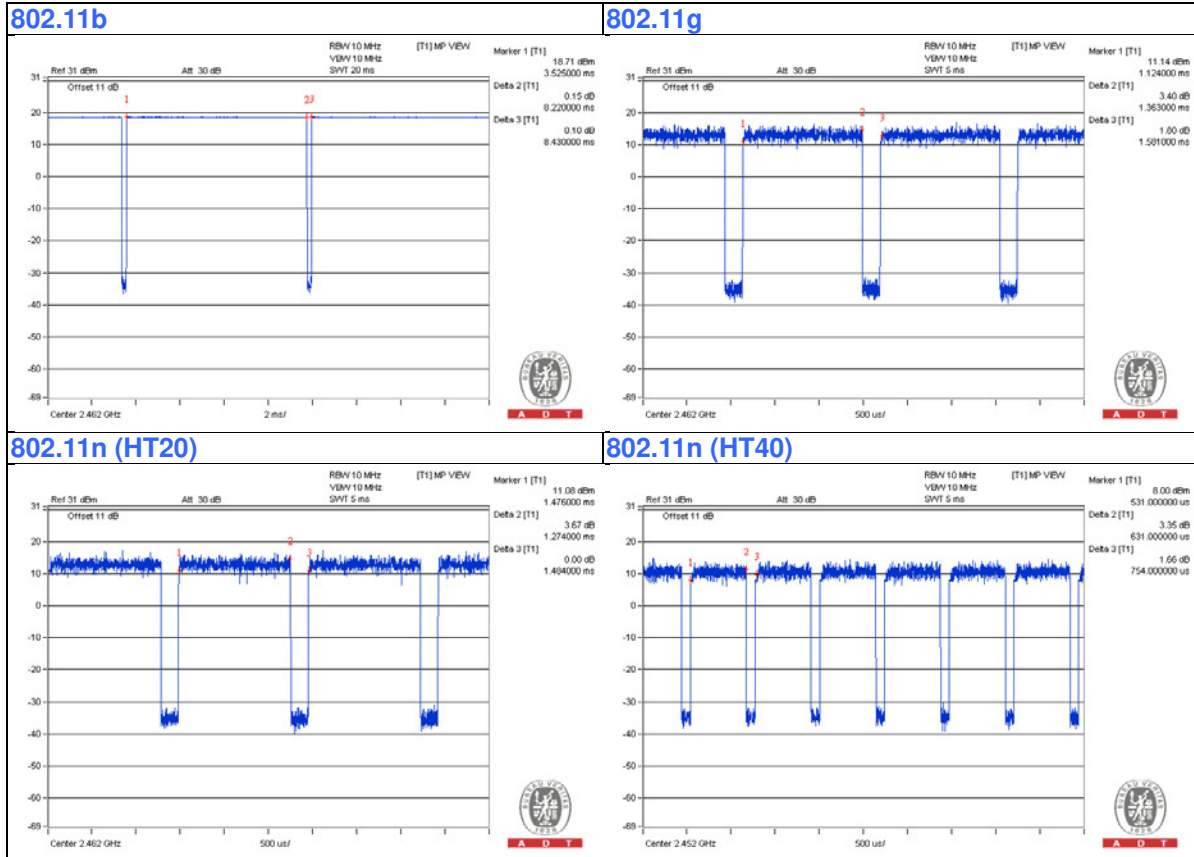

3.4 Description of Support Units

The EUT has been tested as an independent unit together with other necessary accessories or support units. The following support units or accessories were used to form a representative test configuration during the tests.

ID	Product	Brand	Model No.	Serial No.	FCC ID	Remarks
A.	Wireless Power Charger	yardiX	CXT31106	NA	NA	Provided by the manufacturer
B.	Adapter (for Wireless Power Charger)	NA	HNC190050U	NA	NA	Provided by the manufacturer

Note: All power cords of the above support units are non-shielded (1.8m).

ID	Descriptions	Qty.	Length (m)	Shielding (Yes/No)	Cores (Qty.)	Remarks
1.	Power cable	1	1.55	-	1	Provided by the manufacturer

3.4.1 Configuration of System under Test

Test Mode A

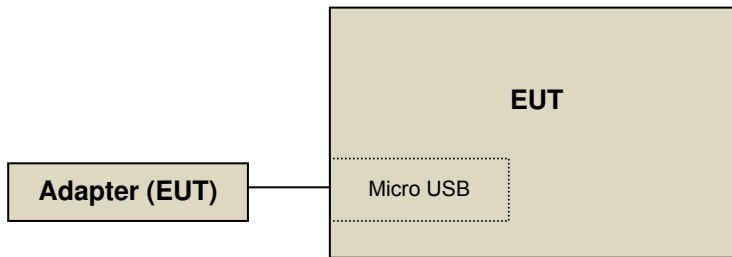

Test Mode B

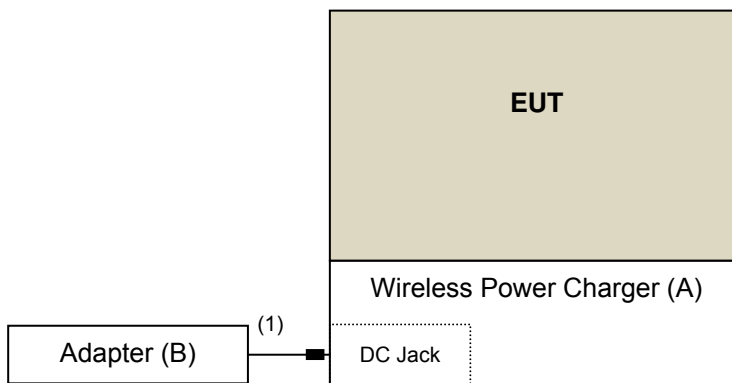

3.5 General Description of Applied Standards

The EUT is a RF Product. According to the specifications of the manufacturer, it must comply with the requirements of the following standards:

FCC Part 15, Subpart C (15.247)
558074 D01 DTS Meas Guidance v03r04
ANSI C63.10-2013

All test items have been performed and recorded as per the above standards.

NOTE: The EUT has been verified to comply with the requirements of FCC Part 15, Subpart B, Class B (DoC). The test report has been issued separately.

4 Test Types and Results

4.1 Radiated Emission and Bandedge Measurement

4.1.1 Limits of Radiated Emission and Bandedge Measurement

Radiated emissions which fall in the restricted bands must comply with the radiated emission limits specified as below table. Other emissions shall be at least 20dB below the highest level of the desired power:

Frequencies (MHz)	Field Strength (microvolts/meter)	Measurement Distance (meters)
0.009 ~ 0.490	2400/F(kHz)	300
0.490 ~ 1.705	24000/F(kHz)	30
1.705 ~ 30.0	30	30
30 ~ 88	100	3
88 ~ 216	150	3
216 ~ 960	200	3
Above 960	500	3

NOTE:

1. The lower limit shall apply at the transition frequencies.
2. Emission level (dBuV/m) = 20 log Emission level (uV/m).
3. For frequencies above 1000MHz, the field strength limits are based on average detector, however, the peak field strength of any emission shall not exceed the maximum permitted average limits, specified above by more than 20dB under any condition of modulation.



A D T

4.1.2 Test Instruments

Tested date: May 27 ~ Jun. 16, 2015

DESCRIPTION & MANUFACTURER	MODEL NO.	SERIAL NO.	DATE OF CALIBRATION	DUE DATE OF CALIBRATION
Test Receiver ROHDE & SCHWARZ	ESCI	100424	Oct. 06, 2014	Oct. 05, 2015
Spectrum Analyzer ROHDE & SCHWARZ	FSP40	100040	Jul. 25, 2014	Jul. 24, 2015
BILOG Antenna SCHWARZBECK	VULB9168	9168-155	Feb. 06, 2015	Feb. 05, 2016
HORN Antenna SCHWARZBECK	BBHA 9120D	9120D-1170	Feb. 05, 2015	Feb. 04, 2016
HORN Antenna SCHWARZBECK	BBHA 9170	BBHA9170241	Feb. 09, 2015	Feb. 08, 2016
Preamplifier Agilent	8449B	3008A01960	Aug. 09, 2014	Aug. 08, 2015
Preamplifier Agilent	8447D	2944A10631	Aug. 09, 2014	Aug. 08, 2015
RF signal cable HUBER+SUHNNER	SUCOFLEX 104	309220/4	Aug. 09, 2014	Aug. 08, 2015
RF signal cable HUBER+SUHNNER	SUCOFLEX 104	250724/4	Aug. 09, 2014	Aug. 08, 2015
RF signal cable HUBER+SUHNNER	SUCOFLEX 104	295012/4	Aug. 09, 2014	Aug. 08, 2015
Software BV ADT	ADT_Radiated_ V7.6.15.9.4	NA	NA	NA
Antenna Tower inn-co GmbH	MA 4000	010303	NA	NA
Antenna Tower Controller BV ADT	AT100	AT93021703	NA	NA
Turn Table BV ADT	TT100	TT93021703	NA	NA
Turn Table Controller BV ADT	SC100.	SC93021703	NA	NA
High Speed Peak Power Meter	ML2495A	0824011	Jul. 26, 2014	Jul. 25, 2015
Power Sensor	MA2411B	0738171	Jul. 26, 2014	Jul. 25, 2015

- NOTE:**
1. The calibration interval of the above test instruments is 12 months and the calibrations are traceable to NML/ROC and NIST/USA.
 2. The test was performed in HwaYa Chamber 4.
 3. The horn antenna and HP preamplifier (model: 8449B) are used only for the measurement of emission frequency above 1GHz if tested.
 4. The FCC Site Registration No. is 460141.
 5. The IC Site Registration No. is IC7450F-4.



A D T

Tested date: Aug. 25, 2015 ~ Jan. 30, 2016

Description & Manufacturer	Model No.	Serial No.	Cal. Date	Cal. Due
Test Receiver ROHDE & SCHWARZ	ESIB7	100187	Apr. 10, 2015	Apr. 09, 2016
Spectrum Analyzer ROHDE & SCHWARZ	FSP40	100269	Mar. 30, 2015	Mar. 29, 2016
BILOG Antenna SCHWARZBECK	VULB9168	9168-148	Feb. 02, 2015	Feb. 01, 2016
HORN Antenna SCHWARZBECK	BBHA 9120 D	9120D-1169	Feb. 09, 2015	Feb. 08, 2016
HORN Antenna SCHWARZBECK	BBHA 9170	BBHA9170241	Feb. 09, 2015	Feb. 08, 2016
Preamplifier Agilent	8449B	3008A01911	Aug. 09, 2015	Aug. 08, 2016
Preamplifier Agilent	8447D	2944A10638	Aug. 09, 2015	Aug. 08, 2016
RF signal cable HUBER+SUHNER	SUCOFLEX 104	CABLE-CH9-02(309222 +248780)	Aug. 09, 2015	Aug. 08, 2016
RF signal cable HUBER+SUHNER	SUCOFLEX 104	CABLE-CH9-03(274092)	Aug. 09, 2015	Aug. 08, 2016
RF signal cable Woken	8D-FB	Cable-CH9-01	Aug. 11, 2015	Aug. 10, 2016
Software BV ADT	ADT_Radiated_ V7.6.15.9.4	NA	NA	NA
Antenna Tower EMCO	2070/2080	512.835.4684	NA	NA
Turn Table EMCO	2087-2.03	NA	NA	NA
Antenna Tower & Turn BV ADT	AT100	AT93021705	NA	NA
Turn Table BV ADT	TT100	TT93021705	NA	NA
Turn Table Controller BV ADT	SC100	SC93021705	NA	NA

- NOTE:** 1. The calibration interval of the above test instruments is 12 months and the calibrations are traceable to NML/ROC and NIST/USA.
2. The test was performed in HwaYa Chamber 9.
3. The horn antenna and HP preamplifier (model: 8449B) are used only for the measurement of emission frequency above 1GHz if tested.
4. The FCC Site Registration No. is 215374.
5. The IC Site Registration No. is IC 7450F-9.

4.1.3 Test Procedures

- a. The EUT was placed on the top of a rotating table 0.8 meters (for below 1GHz) / 1.5 meters (for above 1GHz) above the ground at 3 meter chamber room for test. The table was rotated 360 degrees to determine the position of the highest radiation.
- b. The EUT was set 3 meters away from the interference-receiving antenna, which was mounted on the top of a variable-height antenna tower.
- c. The height of antenna is varied from one meter to four meters above the ground to determine the maximum value of the field strength. Both horizontal and vertical polarizations of the antenna are set to make the measurement.
- d. For each suspected emission, the EUT was arranged to its worst case and then the antenna was tuned to heights from 1 meter to 4 meters and the rotatable table was turned from 0 degrees to 360 degrees to find the maximum reading.
- e. The test-receiver system was set to quasi-peak detect function and specified bandwidth with maximum hold mode when the test frequency is below 1 GHz.
- f. The test-receiver system was set to peak and average detect function and specified bandwidth with maximum hold mode when the test frequency is above 1 GHz. If the peak reading value also meets average limit, measurement with the average detector is unnecessary.

Note:

1. The resolution bandwidth and video bandwidth of test receiver/spectrum analyzer is 120kHz for Quasi-peak detection (QP) at frequency below 1GHz.
2. The resolution bandwidth of test receiver/spectrum analyzer is 1 MHz and the video bandwidth is 3 MHz for Peak detection (PK) at frequency above 1GHz.
3. The resolution bandwidth of test receiver/spectrum analyzer is 1MHz and the video bandwidth is 3MHz for RMS Average (Duty cycle < 98%) for Average detection (AV) at frequency above 1GHz, then the measurement results was added to a correction factor ($10 \log(1/\text{duty cycle})$).
4. The resolution bandwidth of test receiver/spectrum analyzer is 1MHz and the video bandwidth is 10Hz (Duty cycle $\geq 98\%$) for Average detection (AV) at frequency above 1GHz.
5. All modes of operation were investigated and the worst-case emissions are reported.

4.1.4 Deviation from Test Standard

No deviation.

4.1.5 Test Set Up

<Frequency Range below 1GHz>

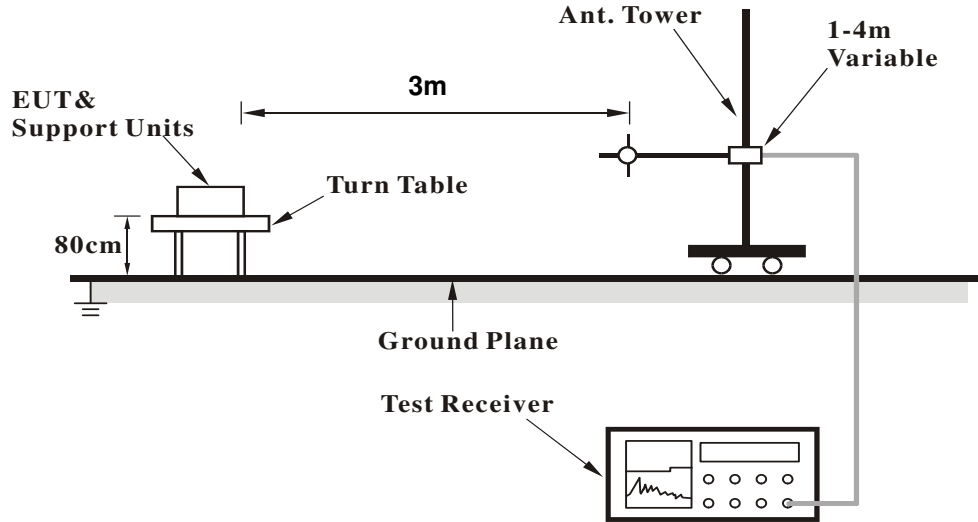

<Frequency Range above 1GHz>

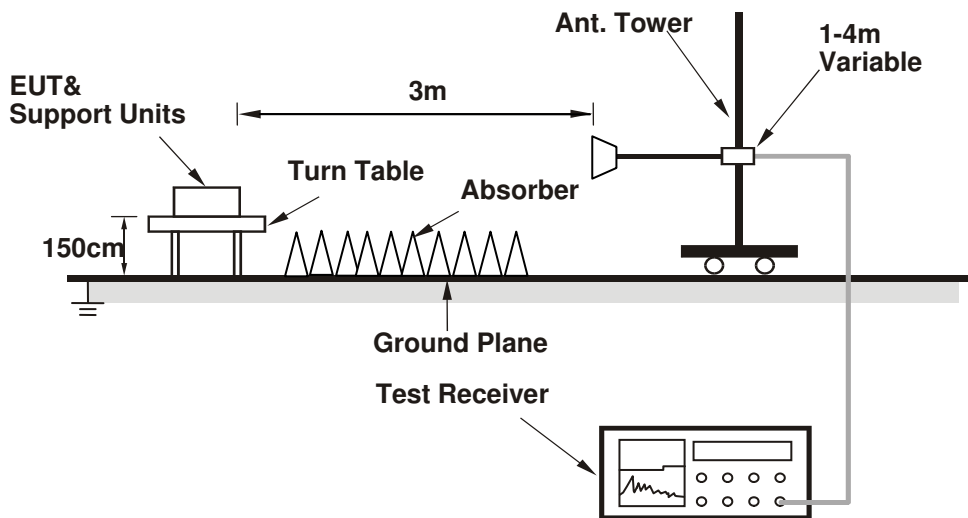

For the actual test configuration, please refer to the attached file (Test Setup Photo).

4.1.6 EUT Operating Conditions

- a. The EUT powered by adapter and under charging mode.
- b. Set the EUT under transmission condition continuously at specific channel frequency.

4.1.7 Test Results
Above 1GHz Data :
802.11b

CHANNEL	TX Channel 1	DETECTOR FUNCTION	Peak (PK)
FREQUENCY RANGE	1GHz ~ 25GHz		Average (AV)

ANTENNA POLARITY & TEST DISTANCE: HORIZONTAL AT 3 M

NO.	FREQ. (MHz)	EMISSION LEVEL (dBuV/m)	LIMIT (dBuV/m)	MARGIN (dB)	ANTENNA HEIGHT (m)	TABLE ANGLE (Degree)	RAW VALUE (dBuV)	CORRECTION FACTOR (dB/m)
1	2390.00	57.2 PK	74.0	-16.8	1.49 H	168	24.20	33.00
2	2390.00	45.4 AV	54.0	-8.6	1.49 H	168	12.40	33.00
3	*2412.00	106.2 PK			1.49 H	168	73.10	33.10
4	*2412.00	102.2 AV			1.49 H	168	69.10	33.10
5	4824.00	47.0 PK	74.0	-27.0	1.42 H	96	45.20	1.80
6	4824.00	33.4 AV	54.0	-20.6	1.42 H	96	31.60	1.80

ANTENNA POLARITY & TEST DISTANCE: VERTICAL AT 3 M

NO.	FREQ. (MHz)	EMISSION LEVEL (dBuV/m)	LIMIT (dBuV/m)	MARGIN (dB)	ANTENNA HEIGHT (m)	TABLE ANGLE (Degree)	RAW VALUE (dBuV)	CORRECTION FACTOR (dB/m)
1	2390.00	57.6 PK	74.0	-16.4	2.15 V	213	24.60	33.00
2	2390.00	45.7 AV	54.0	-8.3	2.15 V	213	12.70	33.00
3	*2412.00	107.3 PK			2.15 V	213	74.20	33.10
4	*2412.00	103.6 AV			2.15 V	213	70.50	33.10
5	4824.00	47.5 PK	74.0	-26.5	1.57 V	96	45.70	1.80
6	4824.00	35.3 AV	54.0	-18.7	1.57 V	96	33.50	1.80

REMARKS:

- Emission Level(dBuV/m) = Raw Value(dBuV) + Correction Factor(dB/m)
- Correction Factor(dB/m) = Antenna Factor(dB/m) + Cable Factor(dB)
– Pre-Amplifier Factor(dB)
- The other emission levels were very low against the limit.
- Margin value = Emission Level – Limit value
- " * " : Fundamental frequency.

CHANNEL	TX Channel 6	DETECTOR FUNCTION	Peak (PK)
FREQUENCY RANGE	1GHz ~ 25GHz		Average (AV)

ANTENNA POLARITY & TEST DISTANCE: HORIZONTAL AT 3 M

NO.	FREQ. (MHz)	EMISSION LEVEL (dBuV/m)	LIMIT (dBuV/m)	MARGIN (dB)	ANTENNA HEIGHT (m)	TABLE ANGLE (Degree)	RAW VALUE (dBuV)	CORRECTION FACTOR (dB/m)
1	*2437.00	107.4 PK			1.01 H	168	74.10	33.30
2	*2437.00	103.7 AV			1.01 H	168	70.40	33.30
3	4874.00	47.1 PK	74.0	-26.9	1.20 H	182	45.20	1.90
4	4874.00	35.2 AV	54.0	-18.8	1.20 H	182	33.30	1.90
5	7311.00	55.2 PK	74.0	-18.8	1.97 H	226	46.70	8.50
6	7311.00	44.1 AV	54.0	-9.9	1.97 H	226	35.60	8.50

ANTENNA POLARITY & TEST DISTANCE: VERTICAL AT 3 M

NO.	FREQ. (MHz)	EMISSION LEVEL (dBuV/m)	LIMIT (dBuV/m)	MARGIN (dB)	ANTENNA HEIGHT (m)	TABLE ANGLE (Degree)	RAW VALUE (dBuV)	CORRECTION FACTOR (dB/m)
1	*2437.00	108.7 PK			2.06 V	211	75.40	33.30
2	*2437.00	104.8 AV			2.06 V	211	71.50	33.30
3	4874.00	49.0 PK	74.0	-25.0	1.78 V	119	47.10	1.90
4	4874.00	40.4 AV	54.0	-13.6	1.78 V	119	38.50	1.90
5	7311.00	54.4 PK	74.0	-19.6	1.23 V	185	45.90	8.50
6	7311.00	42.4 AV	54.0	-11.6	1.23 V	185	33.90	8.50

REMARKS:

1. Emission Level(dBuV/m) = Raw Value(dBuV) + Correction Factor(dB/m)
2. Correction Factor(dB/m) = Antenna Factor(dB/m) + Cable Factor(dB) – Pre-Amplifier Factor(dB)
3. The other emission levels were very low against the limit.
4. Margin value = Emission Level – Limit value
5. " * ": Fundamental frequency.



A D T

CHANNEL	TX Channel 11	DETECTOR FUNCTION	Peak (PK)
FREQUENCY RANGE	1GHz ~ 25GHz		Average (AV)

ANTENNA POLARITY & TEST DISTANCE: HORIZONTAL AT 3 M

NO.	FREQ. (MHz)	EMISSION LEVEL (dBuV/m)	LIMIT (dBuV/m)	MARGIN (dB)	ANTENNA HEIGHT (m)	TABLE ANGLE (Degree)	RAW VALUE (dBuV)	CORRECTION FACTOR (dB/m)
1	*2462.00	104.3 PK			1.00 H	171	70.90	33.40
2	*2462.00	100.3 AV			1.00 H	171	66.90	33.40
3	2483.50	58.0 PK	74.0	-16.0	1.00 H	170	24.60	33.40
4	2483.50	46.3 AV	54.0	-7.7	1.00 H	170	12.90	33.40
5	4924.00	46.6 PK	74.0	-27.4	2.03 H	297	44.60	2.00
6	4924.00	37.6 AV	54.0	-16.4	2.03 H	297	35.60	2.00
7	7386.00	54.0 PK	74.0	-20.0	1.69 H	64	45.70	8.30
8	7386.00	40.8 AV	54.0	-13.2	1.69 H	64	32.50	8.30

ANTENNA POLARITY & TEST DISTANCE: VERTICAL AT 3 M

NO.	FREQ. (MHz)	EMISSION LEVEL (dBuV/m)	LIMIT (dBuV/m)	MARGIN (dB)	ANTENNA HEIGHT (m)	TABLE ANGLE (Degree)	RAW VALUE (dBuV)	CORRECTION FACTOR (dB/m)
1	*2462.00	103.4 PK			2.05 V	217	70.00	33.40
2	*2462.00	99.6 AV			2.05 V	217	66.20	33.40
3	2483.50	57.9 PK	74.0	-16.1	2.05 V	217	24.50	33.40
4	2483.50	46.2 AV	54.0	-7.8	2.05 V	217	12.80	33.40
5	4924.00	47.1 PK	74.0	-26.9	1.61 V	163	45.10	2.00
6	4924.00	36.5 AV	54.0	-17.5	1.61 V	163	34.50	2.00
7	7386.00	54.0 PK	74.0	-20.0	1.52 V	96	45.70	8.30
8	7386.00	40.8 AV	54.0	-13.2	1.52 V	96	32.50	8.30

REMARKS:

- Emission Level(dBuV/m) = Raw Value(dBuV) + Correction Factor(dB/m)
- Correction Factor(dB/m) = Antenna Factor(dB/m) + Cable Factor(dB)
– Pre-Amplifier Factor(dB)
- The other emission levels were very low against the limit.
- Margin value = Emission Level – Limit value
- " * ": Fundamental frequency.

802.11g

CHANNEL	TX Channel 1	DETECTOR FUNCTION	Peak (PK)
FREQUENCY RANGE	1GHz ~ 25GHz		Average (AV)

ANTENNA POLARITY & TEST DISTANCE: HORIZONTAL AT 3 M

NO.	FREQ. (MHz)	EMISSION LEVEL (dBuV/m)	LIMIT (dBuV/m)	MARGIN (dB)	ANTENNA HEIGHT (m)	TABLE ANGLE (Degree)	RAW VALUE (dBuV)	CORRECTION FACTOR (dB/m)
1	2390.00	60.9 PK	74.0	-13.1	1.50 H	167	27.90	33.00
2	2390.00	46.8 AV	54.0	-7.2	1.50 H	167	13.80	33.00
3	*2412.00	104.1 PK			1.50 H	167	71.00	33.10
4	*2412.00	93.6 AV			1.50 H	167	60.50	33.10
5	4824.00	47.5 PK	74.0	-26.5	1.54 H	158	45.70	1.80
6	4824.00	35.3 AV	54.0	-18.7	1.54 H	158	33.50	1.80

ANTENNA POLARITY & TEST DISTANCE: VERTICAL AT 3 M

NO.	FREQ. (MHz)	EMISSION LEVEL (dBuV/m)	LIMIT (dBuV/m)	MARGIN (dB)	ANTENNA HEIGHT (m)	TABLE ANGLE (Degree)	RAW VALUE (dBuV)	CORRECTION FACTOR (dB/m)
1	2390.00	56.4 PK	74.0	-17.6	2.11 V	209	23.40	33.00
2	2390.00	46.6 AV	54.0	-7.4	2.11 V	209	13.60	33.00
3	*2412.00	102.5 PK			2.11 V	209	69.40	33.10
4	*2412.00	92.1 AV			2.11 V	209	59.00	33.10
5	4824.00	47.8 PK	74.0	-26.2	1.52 V	64	46.00	1.80
6	4824.00	33.3 AV	54.0	-20.7	1.52 V	64	31.50	1.80

REMARKS:

1. Emission Level(dBuV/m) = Raw Value(dBuV) + Correction Factor(dB/m)
2. Correction Factor(dB/m) = Antenna Factor(dB/m) + Cable Factor(dB)
– Pre-Amplifier Factor(dB)
3. The other emission levels were very low against the limit.
4. Margin value = Emission Level – Limit value
5. " * ": Fundamental frequency.

CHANNEL	TX Channel 6	DETECTOR FUNCTION	Peak (PK)
FREQUENCY RANGE	1GHz ~ 25GHz		Average (AV)

ANTENNA POLARITY & TEST DISTANCE: HORIZONTAL AT 3 M

NO.	FREQ. (MHz)	EMISSION LEVEL (dBuV/m)	LIMIT (dBuV/m)	MARGIN (dB)	ANTENNA HEIGHT (m)	TABLE ANGLE (Degree)	RAW VALUE (dBuV)	CORRECTION FACTOR (dB/m)
1	*2437.00	107.1 PK			1.02 H	169	73.80	33.30
2	*2437.00	96.9 AV			1.02 H	169	63.60	33.30
3	4874.00	47.5 PK	74.0	-26.5	1.54 H	66	45.60	1.90
4	4874.00	34.4 AV	54.0	-19.6	1.54 H	66	32.50	1.90
5	7311.00	53.7 PK	74.0	-20.3	1.45 H	57	45.20	8.50
6	7311.00	41.0 AV	54.0	-13.0	1.45 H	57	32.50	8.50

ANTENNA POLARITY & TEST DISTANCE: VERTICAL AT 3 M

NO.	FREQ. (MHz)	EMISSION LEVEL (dBuV/m)	LIMIT (dBuV/m)	MARGIN (dB)	ANTENNA HEIGHT (m)	TABLE ANGLE (Degree)	RAW VALUE (dBuV)	CORRECTION FACTOR (dB/m)
1	*2437.00	107.1 PK			1.98 V	216	73.80	33.30
2	*2437.00	96.1 AV			1.98 V	216	62.80	33.30
3	4874.00	45.3 PK	74.0	-28.7	1.52 V	48	43.40	1.90
4	4874.00	33.4 AV	54.0	-20.6	1.52 V	48	31.50	1.90
5	7311.00	51.9 PK	74.0	-22.1	1.00 V	265	43.40	8.50
6	7311.00	39.3 AV	54.0	-14.7	1.00 V	265	30.80	8.50

REMARKS:

1. Emission Level(dBuV/m) = Raw Value(dBuV) + Correction Factor(dB/m)
2. Correction Factor(dB/m) = Antenna Factor(dB/m) + Cable Factor(dB) – Pre-Amplifier Factor(dB)
3. The other emission levels were very low against the limit.
4. Margin value = Emission Level – Limit value
5. " * ": Fundamental frequency.



CHANNEL	TX Channel 11	DETECTOR FUNCTION	Peak (PK)
FREQUENCY RANGE	1GHz ~ 25GHz		Average (AV)

ANTENNA POLARITY & TEST DISTANCE: HORIZONTAL AT 3 M

NO.	FREQ. (MHz)	EMISSION LEVEL (dBuV/m)	LIMIT (dBuV/m)	MARGIN (dB)	ANTENNA HEIGHT (m)	TABLE ANGLE (Degree)	RAW VALUE (dBuV)	CORRECTION FACTOR (dB/m)
1	*2462.00	100.0 PK			2.00 H	179	66.60	33.40
2	*2462.00	88.9 AV			2.00 H	179	55.50	33.40
3	2483.50	72.1 PK	74.0	-1.9	2.00 H	208	38.70	33.40
4	2483.50	52.4 AV	54.0	-1.6	2.00 H	208	19.00	33.40
5	4924.00	46.4 PK	74.0	-27.6	1.65 H	335	44.40	2.00
6	4924.00	32.8 AV	54.0	-21.2	1.65 H	335	30.80	2.00
7	7382.00	52.5 PK	74.0	-21.5	1.75 H	274	44.20	8.30
8	7382.00	39.2 AV	54.0	-14.8	1.75 H	274	30.90	8.30

ANTENNA POLARITY & TEST DISTANCE: VERTICAL AT 3 M

NO.	FREQ. (MHz)	EMISSION LEVEL (dBuV/m)	LIMIT (dBuV/m)	MARGIN (dB)	ANTENNA HEIGHT (m)	TABLE ANGLE (Degree)	RAW VALUE (dBuV)	CORRECTION FACTOR (dB/m)
1	*2462.00	97.1 PK			2.07 V	219	63.70	33.40
2	*2462.00	86.8 AV			2.07 V	219	53.40	33.40
3	2483.50	57.8 PK	74.0	-16.2	2.07 V	55	24.40	33.40
4	2483.50	45.9 AV	54.0	-8.1	2.07 V	55	12.50	33.40
5	4924.00	47.4 PK	74.0	-26.6	2.07 V	29	45.40	2.00
6	4924.00	32.9 AV	54.0	-21.1	2.07 V	29	30.90	2.00
7	7386.00	52.5 PK	74.0	-21.5	2.07 V	83	44.20	8.30
8	7386.00	38.9 AV	54.0	-15.1	2.07 V	83	30.60	8.30

REMARKS:

1. Emission Level(dBuV/m) = Raw Value(dBuV) + Correction Factor(dB/m)
2. Correction Factor(dB/m) = Antenna Factor(dB/m) + Cable Factor(dB)
– Pre-Amplifier Factor(dB)
3. The other emission levels were very low against the limit.
4. Margin value = Emission Level – Limit value
5. " * ": Fundamental frequency.



802.11n (HT20)

CHANNEL	TX Channel 1	DETECTOR FUNCTION	Peak (PK)
FREQUENCY RANGE	1GHz ~ 25GHz		Average (AV)

ANTENNA POLARITY & TEST DISTANCE: HORIZONTAL AT 3 M

NO.	FREQ. (MHz)	EMISSION LEVEL (dBuV/m)	LIMIT (dBuV/m)	MARGIN (dB)	ANTENNA HEIGHT (m)	TABLE ANGLE (Degree)	RAW VALUE (dBuV)	CORRECTION FACTOR (dB/m)
1	2390.00	65.2 PK	74.0	-8.8	1.03 H	188	32.20	33.00
2	2390.00	47.4 AV	54.0	-6.6	1.03 H	188	14.40	33.00
3	*2412.00	103.2 PK			1.03 H	188	70.10	33.10
4	*2412.00	92.8 AV			1.03 H	188	59.70	33.10
5	4824.00	46.5 PK	74.0	-27.5	1.25 H	88	44.70	1.80
6	4824.00	34.3 AV	54.0	-19.7	1.25 H	88	32.50	1.80

ANTENNA POLARITY & TEST DISTANCE: VERTICAL AT 3 M

NO.	FREQ. (MHz)	EMISSION LEVEL (dBuV/m)	LIMIT (dBuV/m)	MARGIN (dB)	ANTENNA HEIGHT (m)	TABLE ANGLE (Degree)	RAW VALUE (dBuV)	CORRECTION FACTOR (dB/m)
1	2390.00	62.7 PK	74.0	-11.3	2.27 V	221	29.70	33.00
2	2390.00	47.2 AV	54.0	-6.8	2.27 V	221	14.20	33.00
3	*2412.00	102.5 PK			2.27 V	221	69.40	33.10
4	*2412.00	92.0 AV			2.27 V	221	58.90	33.10
5	4824.00	47.7 PK	74.0	-26.3	1.52 V	64	45.90	1.80
6	4824.00	34.3 AV	54.0	-19.7	1.52 V	64	32.50	1.80

REMARKS:

1. Emission Level(dBuV/m) = Raw Value(dBuV) + Correction Factor(dB/m)
2. Correction Factor(dB/m) = Antenna Factor(dB/m) + Cable Factor(dB) – Pre-Amplifier Factor(dB)
3. The other emission levels were very low against the limit.
4. Margin value = Emission Level – Limit value
5. " * ": Fundamental frequency.



CHANNEL	TX Channel 6	DETECTOR FUNCTION	Peak (PK)
FREQUENCY RANGE	1GHz ~ 25GHz		Average (AV)

ANTENNA POLARITY & TEST DISTANCE: HORIZONTAL AT 3 M

NO.	FREQ. (MHz)	EMISSION LEVEL (dBuV/m)	LIMIT (dBuV/m)	MARGIN (dB)	ANTENNA HEIGHT (m)	TABLE ANGLE (Degree)	RAW VALUE (dBuV)	CORRECTION FACTOR (dB/m)
1	*2437.00	108.1 PK			1.01 H	177	74.80	33.30
2	*2437.00	98.1 AV			1.01 H	177	64.80	33.30
3	4874.00	48.8 PK	74.0	-25.2	1.59 H	65	46.90	1.90
4	4874.00	34.4 AV	54.0	-19.6	1.59 H	65	32.50	1.90
5	7311.00	53.7 PK	74.0	-20.3	1.00 H	25	45.20	8.50
6	7311.00	41.0 AV	54.0	-13.0	1.00 H	25	32.50	8.50

ANTENNA POLARITY & TEST DISTANCE: VERTICAL AT 3 M

NO.	FREQ. (MHz)	EMISSION LEVEL (dBuV/m)	LIMIT (dBuV/m)	MARGIN (dB)	ANTENNA HEIGHT (m)	TABLE ANGLE (Degree)	RAW VALUE (dBuV)	CORRECTION FACTOR (dB/m)
1	*2437.00	106.7 PK			1.21 V	224	73.40	33.30
2	*2437.00	95.3 AV			1.21 V	224	62.00	33.30
3	4874.00	47.5 PK	74.0	-26.5	1.57 V	84	45.60	1.90
4	4874.00	35.4 AV	54.0	-18.6	1.57 V	84	33.50	1.90
5	7311.00	53.0 PK	74.0	-21.0	1.54 V	96	44.50	8.50
6	7311.00	39.7 AV	54.0	-14.3	1.54 V	96	31.20	8.50

REMARKS:

1. Emission Level(dBuV/m) = Raw Value(dBuV) + Correction Factor(dB/m)
2. Correction Factor(dB/m) = Antenna Factor(dB/m) + Cable Factor(dB) – Pre-Amplifier Factor(dB)
3. The other emission levels were very low against the limit.
4. Margin value = Emission Level – Limit value
5. " * ": Fundamental frequency.

CHANNEL	TX Channel 11	DETECTOR FUNCTION	Peak (PK)
FREQUENCY RANGE	1GHz ~ 25GHz		Average (AV)

ANTENNA POLARITY & TEST DISTANCE: HORIZONTAL AT 3 M

NO.	FREQ. (MHz)	EMISSION LEVEL (dBuV/m)	LIMIT (dBuV/m)	MARGIN (dB)	ANTENNA HEIGHT (m)	TABLE ANGLE (Degree)	RAW VALUE (dBuV)	CORRECTION FACTOR (dB/m)
1	*2462.00	100.9 PK			1.00 H	172	67.50	33.40
2	*2462.00	90.6 AV			1.00 H	172	57.20	33.40
3	2483.50	62.5 PK	74.0	-11.5	1.00 H	172	29.10	33.40
4	2483.50	47.7 AV	54.0	-6.3	1.00 H	172	14.30	33.40
5	4924.00	48.6 PK	74.0	-25.4	1.75 H	96	46.60	2.00
6	4924.00	35.5 AV	54.0	-18.5	1.75 H	96	33.50	2.00

ANTENNA POLARITY & TEST DISTANCE: VERTICAL AT 3 M

NO.	FREQ. (MHz)	EMISSION LEVEL (dBuV/m)	LIMIT (dBuV/m)	MARGIN (dB)	ANTENNA HEIGHT (m)	TABLE ANGLE (Degree)	RAW VALUE (dBuV)	CORRECTION FACTOR (dB/m)
1	*2462.00	98.7 PK			1.23 V	223	65.30	33.40
2	*2462.00	87.8 AV			1.23 V	223	54.40	33.40
3	2483.50	61.2 PK	74.0	-12.8	1.23 V	223	27.80	33.40
4	2483.50	46.5 AV	54.0	-7.5	1.23 V	223	13.10	33.40
5	4924.00	46.6 PK	74.0	-27.4	1.47 V	99	44.60	2.00
6	4924.00	34.5 AV	54.0	-19.5	1.47 V	99	32.50	2.00

REMARKS:

1. Emission Level(dBuV/m) = Raw Value(dBuV) + Correction Factor(dB/m)
2. Correction Factor(dB/m) = Antenna Factor(dB/m) + Cable Factor(dB) – Pre-Amplifier Factor(dB)
3. The other emission levels were very low against the limit.
4. Margin value = Emission Level – Limit value
5. " * ": Fundamental frequency.

802.11n (HT40)

CHANNEL	TX Channel 3	DETECTOR FUNCTION	Peak (PK)
FREQUENCY RANGE	1GHz ~ 25GHz		Average (AV)

ANTENNA POLARITY & TEST DISTANCE: HORIZONTAL AT 3 M

NO.	FREQ. (MHz)	EMISSION LEVEL (dBuV/m)	LIMIT (dBuV/m)	MARGIN (dB)	ANTENNA HEIGHT (m)	TABLE ANGLE (Degree)	RAW VALUE (dBuV)	CORRECTION FACTOR (dB/m)
1	2390.00	63.1 PK	74.0	-10.9	1.03 H	187	30.10	33.00
2	2390.00	48.3 AV	54.0	-5.7	1.03 H	187	15.30	33.00
3	*2422.00	99.7 PK			1.03 H	187	66.50	33.20
4	*2422.00	89.9 AV			1.03 H	187	56.70	33.20
5	4844.00	47.5 PK	74.0	-26.5	1.95 H	89	45.70	1.80
6	4844.00	35.3 AV	54.0	-18.7	1.95 H	89	33.50	1.80

ANTENNA POLARITY & TEST DISTANCE: VERTICAL AT 3 M

NO.	FREQ. (MHz)	EMISSION LEVEL (dBuV/m)	LIMIT (dBuV/m)	MARGIN (dB)	ANTENNA HEIGHT (m)	TABLE ANGLE (Degree)	RAW VALUE (dBuV)	CORRECTION FACTOR (dB/m)
1	2390.00	62.4 PK	74.0	-11.6	1.58 V	220	29.40	33.00
2	2390.00	48.1 AV	54.0	-5.9	1.58 V	220	15.10	33.00
3	*2422.00	98.5 PK			1.58 V	220	65.30	33.20
4	*2422.00	88.4 AV			1.58 V	220	55.20	33.20
5	4844.00	47.3 PK	74.0	-26.7	1.54 V	77	45.50	1.80
6	4844.00	34.0 AV	54.0	-20.0	1.54 V	77	32.20	1.80

REMARKS:

1. Emission Level(dBuV/m) = Raw Value(dBuV) + Correction Factor(dB/m)
2. Correction Factor(dB/m) = Antenna Factor(dB/m) + Cable Factor(dB) – Pre-Amplifier Factor(dB)
3. The other emission levels were very low against the limit.
4. Margin value = Emission Level – Limit value
5. " * ": Fundamental frequency.

CHANNEL	TX Channel 6	DETECTOR FUNCTION	Peak (PK)
FREQUENCY RANGE	1GHz ~ 25GHz		Average (AV)

ANTENNA POLARITY & TEST DISTANCE: HORIZONTAL AT 3 M

NO.	FREQ. (MHz)	EMISSION LEVEL (dBuV/m)	LIMIT (dBuV/m)	MARGIN (dB)	ANTENNA HEIGHT (m)	TABLE ANGLE (Degree)	RAW VALUE (dBuV)	CORRECTION FACTOR (dB/m)
1	*2437.00	102.6 PK			1.03 H	189	69.30	33.30
2	*2437.00	91.3 AV			1.03 H	189	58.00	33.30
3	4874.00	47.4 PK	74.0	-26.6	1.96 H	44	45.50	1.90
4	4874.00	36.1 AV	54.0	-17.9	1.96 H	44	34.20	1.90
5	7311.00	53.8 PK	74.0	-20.2	1.54 H	44	45.30	8.50
6	7311.00	40.7 AV	54.0	-13.3	1.54 H	44	32.20	8.50

ANTENNA POLARITY & TEST DISTANCE: VERTICAL AT 3 M

NO.	FREQ. (MHz)	EMISSION LEVEL (dBuV/m)	LIMIT (dBuV/m)	MARGIN (dB)	ANTENNA HEIGHT (m)	TABLE ANGLE (Degree)	RAW VALUE (dBuV)	CORRECTION FACTOR (dB/m)
1	*2437.00	99.4 PK			1.22 V	224	66.10	33.30
2	*2437.00	88.7 AV			1.22 V	224	55.40	33.30
3	4874.00	47.8 PK	74.0	-26.2	1.95 V	7	45.90	1.90
4	4874.00	34.5 AV	54.0	-19.5	1.95 V	7	32.60	1.90
5	7311.00	53.0 PK	74.0	-21.0	1.54 V	77	44.50	8.50
6	7311.00	39.7 AV	54.0	-14.3	1.54 V	77	31.20	8.50

REMARKS:

1. Emission Level(dBuV/m) = Raw Value(dBuV) + Correction Factor(dB/m)
2. Correction Factor(dB/m) = Antenna Factor(dB/m) + Cable Factor(dB) – Pre-Amplifier Factor(dB)
3. The other emission levels were very low against the limit.
4. Margin value = Emission Level – Limit value
5. " * ": Fundamental frequency.

CHANNEL	TX Channel 9	DETECTOR FUNCTION	Peak (PK)
FREQUENCY RANGE	1GHz ~ 25GHz		Average (AV)

ANTENNA POLARITY & TEST DISTANCE: HORIZONTAL AT 3 M

NO.	FREQ. (MHz)	EMISSION LEVEL (dBuV/m)	LIMIT (dBuV/m)	MARGIN (dB)	ANTENNA HEIGHT (m)	TABLE ANGLE (Degree)	RAW VALUE (dBuV)	CORRECTION FACTOR (dB/m)
1	*2452.00	97.5 PK			1.00 H	179	64.20	33.30
2	*2452.00	86.9 AV			1.00 H	179	53.60	33.30
3	2483.50	61.7 PK	74.0	-12.3	1.00 H	179	28.30	33.40
4	2483.50	47.5 AV	54.0	-6.5	1.00 H	179	14.10	33.40
5	4904.00	47.2 PK	74.0	-26.8	1.27 H	4	45.20	2.00
6	4904.00	34.5 AV	54.0	-19.5	1.27 H	4	32.50	2.00

ANTENNA POLARITY & TEST DISTANCE: VERTICAL AT 3 M

NO.	FREQ. (MHz)	EMISSION LEVEL (dBuV/m)	LIMIT (dBuV/m)	MARGIN (dB)	ANTENNA HEIGHT (m)	TABLE ANGLE (Degree)	RAW VALUE (dBuV)	CORRECTION FACTOR (dB/m)
1	*2452.00	95.4 PK			2.35 V	224	62.10	33.30
2	*2452.00	83.7 AV			2.35 V	224	50.40	33.30
3	2483.50	58.3 PK	74.0	-15.7	2.35 V	224	24.90	33.40
4	2483.50	46.0 AV	54.0	-8.0	2.35 V	224	12.60	33.40
5	4904.00	46.2 PK	74.0	-27.8	1.12 V	47	44.20	2.00
6	4904.00	33.4 AV	54.0	-20.6	1.12 V	47	31.40	2.00

REMARKS:

1. Emission Level(dBuV/m) = Raw Value(dBuV) + Correction Factor(dB/m)
2. Correction Factor(dB/m) = Antenna Factor(dB/m) + Cable Factor(dB) – Pre-Amplifier Factor(dB)
3. The other emission levels were very low against the limit.
4. Margin value = Emission Level – Limit value
5. " * ": Fundamental frequency.

Below 1GHz Data:
802.11n (HT20)

CHANNEL	TX Channel 6	DETECTOR FUNCTION	Quasi-Peak (QP)
FREQUENCY RANGE	30MHz ~ 1GHz	TEST MODE	A

ANTENNA POLARITY & TEST DISTANCE: HORIZONTAL AT 3 M

NO.	FREQ. (MHz)	EMISSION LEVEL (dBuV/m)	LIMIT (dBuV/m)	MARGIN (dB)	ANTENNA HEIGHT (m)	TABLE ANGLE (Degree)	RAW VALUE (dBuV)	CORRECTION FACTOR (dB/m)
1	57.12	31.8 QP	40.0	-8.2	2.00 H	223	46.50	-14.70
2	84.34	21.5 QP	40.0	-18.5	2.00 H	121	40.80	-19.30
3	142.67	21.4 QP	43.5	-22.1	2.00 H	94	35.60	-14.20
4	185.44	32.9 QP	43.5	-10.6	2.00 H	93	48.30	-15.40
5	214.61	24.8 QP	43.5	-18.7	1.51 H	262	41.10	-16.30
6	315.71	22.5 QP	46.0	-23.5	1.00 H	248	34.30	-11.80

ANTENNA POLARITY & TEST DISTANCE: VERTICAL AT 3 M

NO.	FREQ. (MHz)	EMISSION LEVEL (dBuV/m)	LIMIT (dBuV/m)	MARGIN (dB)	ANTENNA HEIGHT (m)	TABLE ANGLE (Degree)	RAW VALUE (dBuV)	CORRECTION FACTOR (dB/m)
1	51.29	29.7 QP	40.0	-10.3	1.00 V	9	44.10	-14.40
2	74.62	31.9 QP	40.0	-8.1	2.00 V	252	49.30	-17.40
3	84.34	33.7 QP	40.0	-6.3	1.00 V	215	53.00	-19.30
4	111.56	26.2 QP	43.5	-17.3	1.00 V	86	43.30	-17.10
5	189.33	30.3 QP	43.5	-13.2	1.00 V	308	46.10	-15.80
6	329.32	18.8 QP	46.0	-27.2	1.50 V	9	30.10	-11.30

REMARKS:

1. Emission Level(dBuV/m) = Raw Value(dBuV) + Correction Factor(dB/m)
2. Correction Factor(dB/m) = Antenna Factor(dB/m) + Cable Factor(dB) – Pre-Amplifier Factor(dB)
3. The other emission levels were very low against the limit.
4. Margin value = Emission Level – Limit value

CHANNEL	TX Channel 6	DETECTOR FUNCTION	Quasi-Peak (QP)
FREQUENCY RANGE	30MHz ~ 1GHz	TEST MODE	B

ANTENNA POLARITY & TEST DISTANCE: HORIZONTAL AT 3 M

NO.	FREQ. (MHz)	EMISSION LEVEL (dBuV/m)	LIMIT (dBuV/m)	MARGIN (dB)	ANTENNA HEIGHT (m)	TABLE ANGLE (Degree)	RAW VALUE (dBuV)	CORRECTION FACTOR (dB/m)
1	45.52	33.9 QP	40.0	-6.1	1.00 H	186	48.20	-14.30
2	84.32	33.0 QP	40.0	-7.0	1.49 H	36	52.00	-19.00
3	94.02	36.9 QP	43.5	-6.6	2.00 H	71	56.50	-19.60
4	176.31	39.4 QP	43.5	-4.1	1.49 H	309	54.00	-14.60
5	272.50	31.2 QP	46.0	-14.8	1.00 H	286	44.50	-13.30
6	462.62	26.6 QP	46.0	-19.4	2.00 H	250	35.60	-9.00

ANTENNA POLARITY & TEST DISTANCE: VERTICAL AT 3 M

NO.	FREQ. (MHz)	EMISSION LEVEL (dBuV/m)	LIMIT (dBuV/m)	MARGIN (dB)	ANTENNA HEIGHT (m)	TABLE ANGLE (Degree)	RAW VALUE (dBuV)	CORRECTION FACTOR (dB/m)
1	49.35	33.8 QP	40.0	-6.2	1.00 V	15	47.60	-13.80
2	84.19	27.0 QP	40.0	-13.0	1.25 V	216	46.00	-19.00
3	94.02	35.3 QP	43.5	-8.2	1.01 V	256	54.90	-19.60
4	177.44	35.4 QP	43.5	-8.1	1.01 V	231	50.10	-14.70
5	307.42	27.6 QP	46.0	-18.4	1.26 V	54	39.80	-12.20
6	889.42	30.1 QP	46.0	-15.9	1.51 V	15	31.30	-1.20

REMARKS:

1. Emission Level(dBuV/m) = Raw Value(dBuV) + Correction Factor(dB/m)
2. Correction Factor(dB/m) = Antenna Factor(dB/m) + Cable Factor(dB)
– Pre-Amplifier Factor(dB)
3. The other emission levels were very low against the limit.
4. Margin value = Emission Level – Limit value

4.2 Conducted Emission Measurement

4.2.1 Limits of Conducted Emission Measurement

Frequency (MHz)	Conducted Limit (dBuV)	
	Quasi-peak	Average
0.15 - 0.5	66 - 56	56 - 46
0.50 - 5.0	56	46
5.0 - 30.0	60	50

Note: 1. The lower limit shall apply at the transition frequencies.

2. The limit decreases in line with the logarithm of the frequency in the range of 0.15 to 0.50MHz.

4.2.2 Test Instruments

Tested date: Dec. 10, 2015

Description & Manufacturer	Model No.	Serial No.	Date Of Calibration	Due Date Of Calibration
Test Receiver ROHDE & SCHWARZ	ESCS 30	100288	Apr. 27, 2015	Apr. 26, 2016
RF signal cable (with 10dB PAD) Woken	5D-FB	Cable-cond2-01	Dec. 26, 2014	Dec. 25, 2015
LISN ROHDE & SCHWARZ (EUT)	ESH2-Z5	100100	Dec. 30, 2014	Dec. 29, 2015
LISN ROHDE & SCHWARZ (Peripheral)	ESH3-Z5	100312	Jul. 21, 2015	Jul. 20, 2016
Software ADT	BV ADT_Cond_ V7.3.7.3	NA	NA	NA

NOTE: 1. The calibration interval of the above test instruments is 12 months and the calibrations are traceable to NML/ROC and NIST/USA.

2. The test was performed in HwaYa Shielded Room 2.

3. The VCCI Site Registration No. is C-2047.

4.2.3 Test Procedures

- The EUT was placed 0.4 meters from the conducting wall of the shielded room with EUT being connected to the power mains through a line impedance stabilization network (LISN). Other support units were connected to the power mains through another LISN. The two LISNs provide 50 ohm/ 50uH of coupling impedance for the measuring instrument.
- Both lines of the power mains connected to the EUT were checked for maximum conducted interference.
- The frequency range from 150kHz to 30MHz was searched. Emission levels under (Limit - 20dB) was not recorded.

NOTE: The resolution bandwidth and video bandwidth of test receiver is 9kHz for quasi-peak detection (QP) and average detection (AV) at frequency 0.15MHz-30MHz.

4.2.4 Deviation from Test Standard

No deviation.

4.2.5 Test Setup

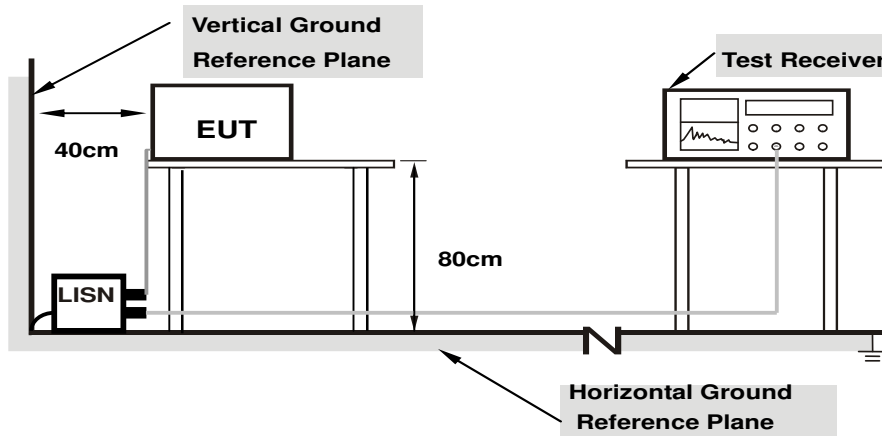

Note: 1.Support units were connected to second LISN.

For the actual test configuration, please refer to the attached file (Test Setup Photo).

4.2.6 EUT Operating Conditions

Same as 4.1.6.

4.2.7 Test Results

Phase	Line (L)	Detector Function	Quasi-Peak (QP) / Average (AV)
-------	----------	-------------------	--------------------------------

No	Freq. [MHz]	Corr. Factor (dB)	Reading Value [dB (uV)]		Emission Level [dB (uV)]		Limit [dB (uV)]		Margin (dB)	
			Q.P.	AV.	Q.P.	AV.	Q.P.	AV.	Q.P.	AV.
	1	0.16953	9.94	37.75	28.72	47.69	38.66	64.98	54.98	-17.29
2	0.38828	9.95	31.42	26.23	41.37	36.18	58.10	48.10	-16.73	-11.92
3	0.47813	9.97	27.13	21.49	37.10	31.46	56.37	46.37	-19.28	-14.92
4	0.88047	10.04	28.14	18.92	38.18	28.96	56.00	46.00	-17.82	-17.04
5	1.31250	10.09	26.98	16.73	37.07	26.82	56.00	46.00	-18.93	-19.18
6	1.72656	10.13	23.95	16.46	34.08	26.59	56.00	46.00	-21.92	-19.41

REMARKS:

1. Q.P. and AV. are abbreviations of quasi-peak and average individually.
2. The emission levels of other frequencies were very low against the limit.
3. Margin value = Emission level - Limit value
4. Correction factor = Insertion loss + Cable loss
5. Emission Level = Correction Factor + Reading Value.

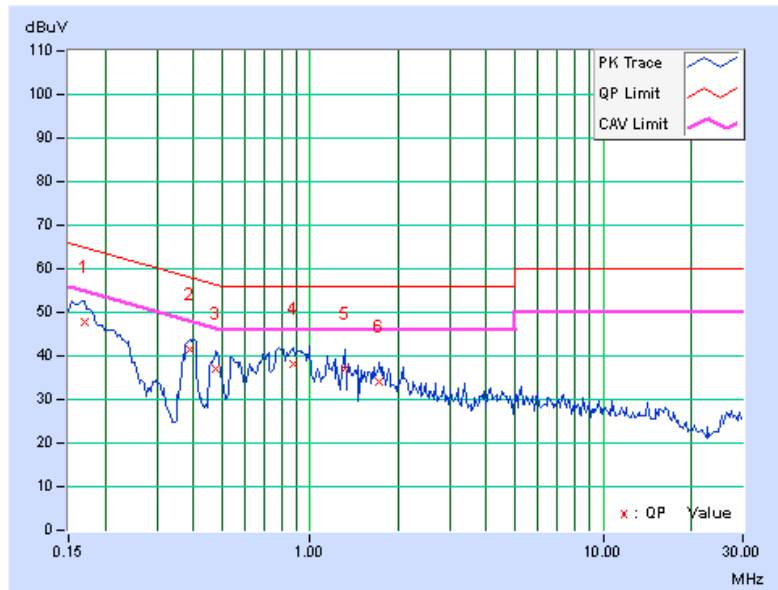

Phase	Neutral (N)	Detector Function	Quasi-Peak (QP) / Average (AV)
-------	-------------	-------------------	--------------------------------

No	Freq. [MHz]	Corr. Factor (dB)	Reading Value		Emission Level		Limit		Margin	
			[dB (uV)]		[dB (uV)]		[dB (uV)]		(dB)	
			Q.P.	AV.	Q.P.	AV.	Q.P.	AV.	Q.P.	AV.
1	0.16172	9.95	34.90	24.11	44.85	34.06	65.38	55.38	-20.52	-21.31
2	0.21250	9.97	32.43	25.19	42.40	35.16	63.11	53.11	-20.71	-17.95
3	0.39219	10.00	28.01	22.65	38.01	32.65	58.02	48.02	-20.01	-15.37
4	0.48984	10.01	25.80	15.95	35.81	25.96	56.17	46.17	-20.36	-20.21
5	0.88438	10.06	26.90	17.79	36.96	27.85	56.00	46.00	-19.04	-18.15
6	1.69531	10.16	27.55	20.23	37.71	30.39	56.00	46.00	-18.29	-15.61

REMARKS:

1. Q.P. and AV. are abbreviations of quasi-peak and average individually.
2. The emission levels of other frequencies were very low against the limit.
3. Margin value = Emission level - Limit value
4. Correction factor = Insertion loss + Cable loss
5. Emission Level = Correction Factor + Reading Value.

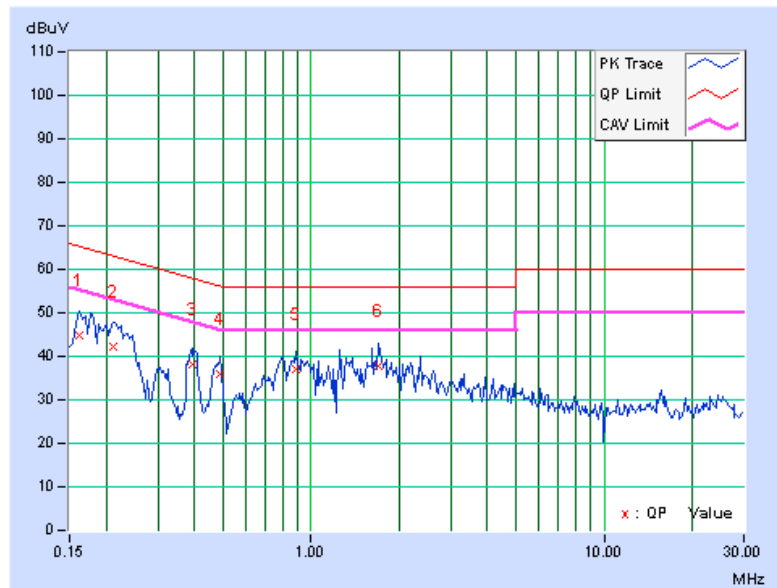

4.3 6dB Bandwidth Measurement

4.3.1 Limits of 6dB Bandwidth Measurement

The minimum of 6dB Bandwidth Measurement is 0.5 MHz.

4.3.2 Test Setup

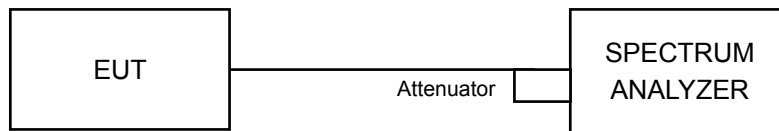

4.3.3 Test Instruments

Refer to section 4.1.2 to get information of above instrument.

4.3.4 Test Procedure

- a. Set resolution bandwidth (RBW) = 100kHz
- b. Set the video bandwidth (VBW) $\geq 3 \times$ RBW, Detector = Peak.
- c. Trace mode = max hold.
- d. Sweep = auto couple.
- e. Measure the maximum width of the emission that is constrained by the frequencies associated with the two amplitude points (upper and lower) that are attenuated by 6 dB relative to the maximum level measured in the fundamental emission

4.3.5 Deviation from Test Standard

No deviation.

4.3.6 EUT Operating Conditions

The software provided by client to enable the EUT under transmission condition continuously at lowest, middle and highest channel frequencies individually.

4.3.7 Test Result

802.11b

Channel	Frequency (MHz)	6dB Bandwidth (MHz)	Minimum Limit (MHz)	Pass / Fail
1	2412	9.59	0.5	PASS
6	2437	9.55	0.5	PASS
11	2462	9.02	0.5	PASS

802.11g

Channel	Frequency (MHz)	6dB Bandwidth (MHz)	Minimum Limit (MHz)	Pass / Fail
1	2412	16.34	0.5	PASS
6	2437	16.39	0.5	PASS
11	2462	16.43	0.5	PASS

802.11n (HT20)

Channel	Frequency (MHz)	6dB Bandwidth (MHz)	Minimum Limit (MHz)	Pass / Fail
1	2412	17.20	0.5	PASS
6	2437	17.61	0.5	PASS
11	2462	17.66	0.5	PASS

802.11n (HT40)

Channel	Frequency (MHz)	6dB Bandwidth (MHz)	Minimum Limit (MHz)	Pass / Fail
3	2422	35.46	0.5	PASS
6	2437	35.42	0.5	PASS
9	2452	35.26	0.5	PASS

Spectrum Plot of Worst Value

802.11b

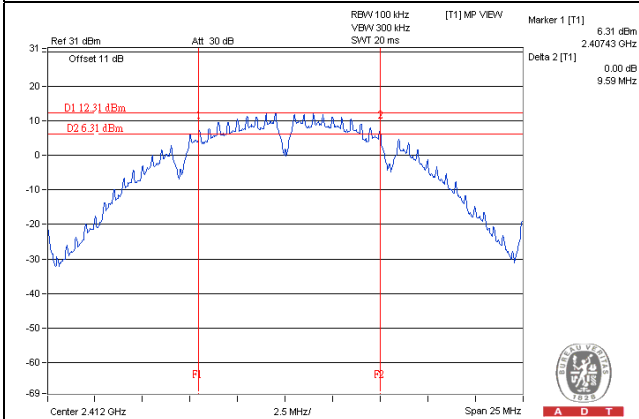

802.11g

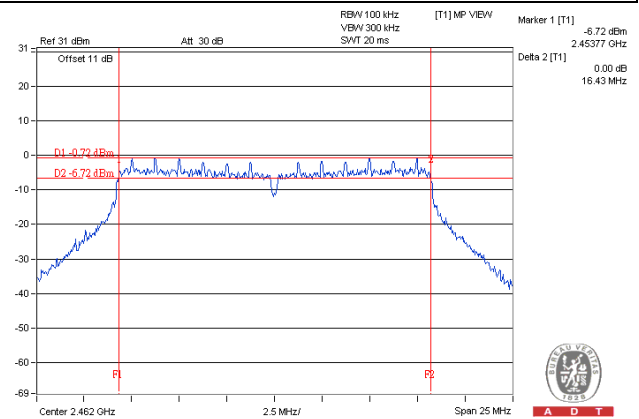

802.11n (HT20)

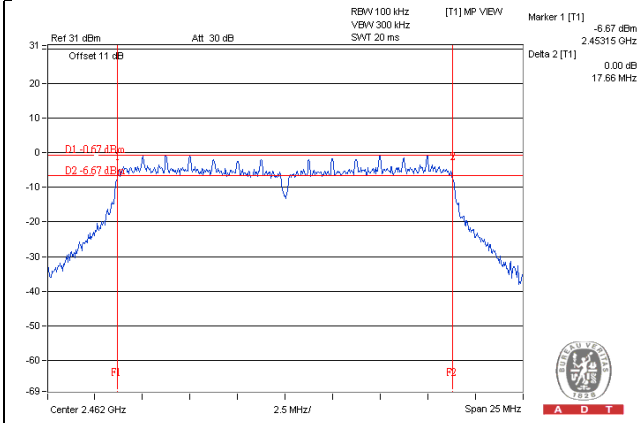

802.11n (HT40)

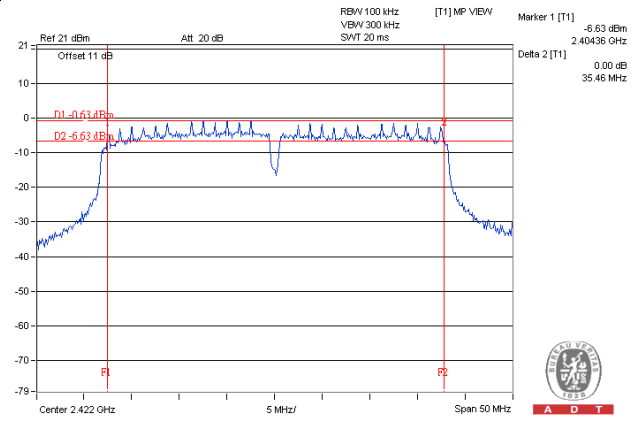

4.4 Conducted Output Power Measurement

4.4.1 Limits of Conducted Output Power Measurement

For systems using digital modulation in the 2400–2483.5 MHz bands: 1 Watt (30dBm)

4.4.2 Test Setup

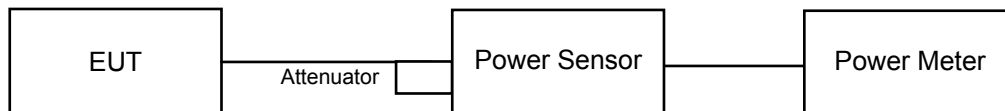

4.4.3 Test Instruments

Refer to section 4.1.2 to get information of above instrument.

4.4.4 Test Procedures

A peak power sensor was used on the output port of the EUT. A power meter was used to read the response of the peak power sensor. Record the power level.

An average power sensor was used on the output port of the EUT. A power meter was used to read the response of the average power sensor and set the detector to average. Record the power level.

4.4.5 Deviation from Test Standard

No deviation.

4.4.6 EUT Operating Conditions

Same as Item 4.3.6.

4.4.7 Test Results

FOR PEAK POWER

802.11b

Channel	Frequency (MHz)	Peak Power (mW)	Peak Power (dBm)	Limit (dBm)	Pass/Fail
1	2412	138.357	21.41	30	Pass
6	2437	139.637	21.45	30	Pass
11	2462	137.721	21.39	30	Pass

802.11g

Channel	Frequency (MHz)	Peak Power (mW)	Peak Power (dBm)	Limit (dBm)	Pass/Fail
1	2412	199.986	23.01	30	Pass
6	2437	254.097	24.05	30	Pass
11	2462	94.189	19.74	30	Pass

802.11n (HT20)

Channel	Frequency (MHz)	Peak Power (mW)	Peak Power (dBm)	Limit (dBm)	Pass/Fail
1	2412	178.649	22.52	30	Pass
6	2437	258.226	24.12	30	Pass
11	2462	107.647	20.32	30	Pass

802.11n (HT40)

Channel	Frequency (MHz)	Peak Power (mW)	Peak Power (dBm)	Limit (dBm)	Pass/Fail
3	2422	142.889	21.55	30	Pass
6	2437	158.125	21.99	30	Pass
9	2452	67.920	18.32	30	Pass

FOR AVERAGE POWER**802.11b**

Channel	Frequency (MHz)	Average Power (mW)	Average Power (dBm)
1	2412	82.414	19.16
6	2437	83.176	19.20
11	2462	82.224	19.15

802.11g

Channel	Frequency (MHz)	Average Power (mW)	Average Power (dBm)
1	2412	40.272	16.05
6	2437	38.459	15.85
11	2462	14.355	11.57

802.11n (HT20)

Channel	Frequency (MHz)	Average Power (mW)	Average Power (dBm)
1	2412	37.154	15.70
6	2437	90.782	19.58
11	2462	16.596	12.20

802.11n (HT40)

Channel	Frequency (MHz)	Average Power (mW)	Average Power (dBm)
3	2422	24.099	13.82
6	2437	27.606	14.41
9	2452	12.331	10.91

4.5 Power Spectral Density Measurement

4.5.1 Limits of Power Spectral Density Measurement

The Maximum of Power Spectral Density Measurement is 8dBm.

4.5.2 Test Setup

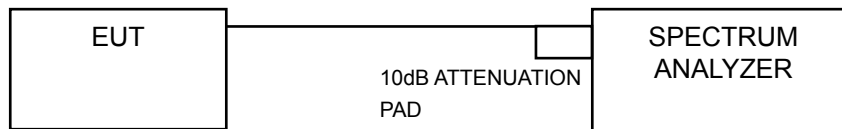

4.5.3 Test Instruments

Refer to section 4.1.2 to get information of above instrument.

4.5.4 Test Procedure

- a. Set analyzer center frequency to DTS channel center frequency.
- b. Set the span to 1.5 times the DTS bandwidth.
- c. Set the RBW to: $3 \text{ kHz} \leq \text{RBW} \leq 100 \text{ kHz}$.
- d. Set the VBW $\geq 3 \times \text{RBW}$.
- e. Detector = peak.
- f. Sweep time = auto couple.
- g. Trace mode = max hold.
- h. Allow trace to fully stabilize.
- i. Use the peak marker function to determine the maximum amplitude level within the RBW.

4.5.5 Deviation from Test Standard

No deviation.

4.5.6 EUT Operating Condition

Same as Item 4.3.6

4.5.7 Test Results

802.11b

Channel	Freq. (MHz)	PSD (dBm)	Limit (dBm)	Pass /Fail
1	2412	-1.88	8	Pass
6	2437	-1.18	8	Pass
11	2462	-5.95	8	Pass

802.11g

Channel	Freq. (MHz)	PSD (dBm)	Limit (dBm)	Pass /Fail
1	2412	-7.82	8	Pass
6	2437	-6.31	8	Pass
11	2462	-15.11	8	Pass

802.11n (HT20)

Channel	Freq. (MHz)	PSD (dBm)	Limit (dBm)	Pass /Fail
1	2412	-8.48	8	Pass
6	2437	-6.97	8	Pass
11	2462	-15.38	8	Pass

802.11n (HT40)

Channel	Freq. (MHz)	PSD (dBm)	Limit (dBm)	PASS /FAIL
3	2422	-14.80	8	PASS
6	2437	-13.73	8	PASS
9	2452	-17.30	8	PASS

Spectrum Plot of Worst Value

802.11b

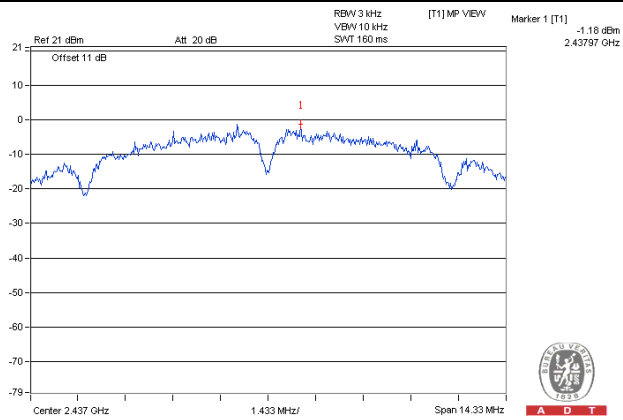

802.11g

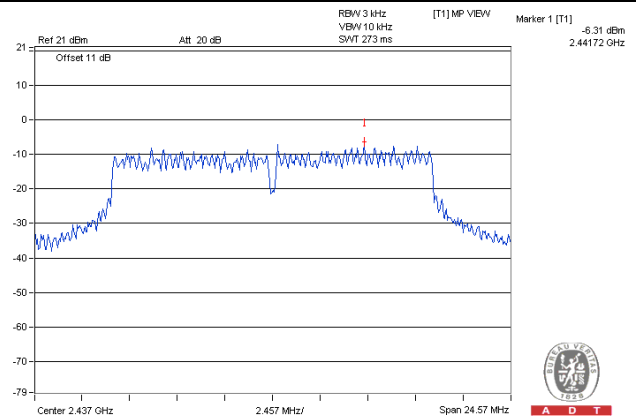

802.11n (HT20)

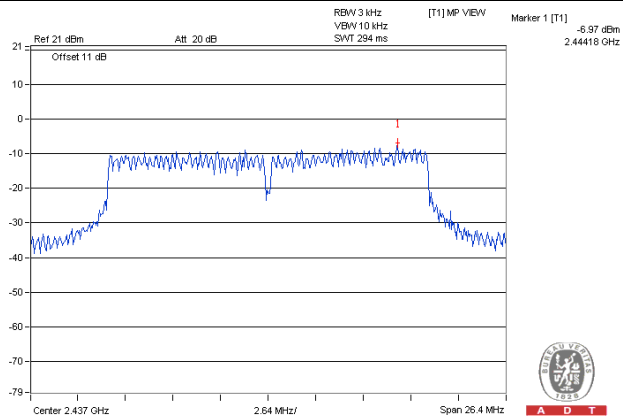

802.11n (HT40)

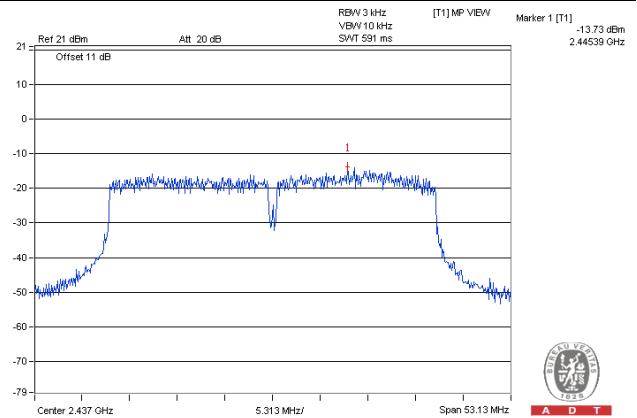

4.6 Conducted Out of Band Emission Measurement

4.6.1 Limits of Conducted Out of Band Emission Measurement

Below 20dB of the highest emission level of operating band (in 100kHz Resolution Bandwidth).

4.6.2 Test Setup

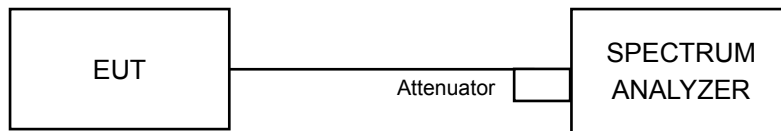

4.6.3 Test Instruments

Refer to section 4.1.2 to get information of above instrument.

4.6.4 Test Procedure

MEASUREMENT PROCEDURE REF

1. Set the RBW = 100 kHz.
2. Set the VBW \geq 300 kHz.
3. Detector = peak.
4. Sweep time = auto couple.
5. Trace mode = max hold.
6. Allow trace to fully stabilize.
7. Use the peak marker function to determine the maximum power level in any 100 kHz band segment within the fundamental EBW.

MEASUREMENT PROCEDURE OOB

1. Set RBW = 100 kHz.
2. Set VBW \geq 300 kHz.
3. Detector = peak.
4. Sweep = auto couple.
5. Trace Mode = max hold.
6. Allow trace to fully stabilize.
7. Use the peak marker function to determine the maximum amplitude level.

4.6.5 Deviation from Test Standard

No deviation.

4.6.6 EUT Operating Condition

Same as Item 4.3.6

4.6.7 Test Results

The spectrum plots are attached on the following pages. D1 line indicates the highest level, and D2 line indicates the 20dB offset below D1. It shows compliance with the requirement.

802.11b

CH 1

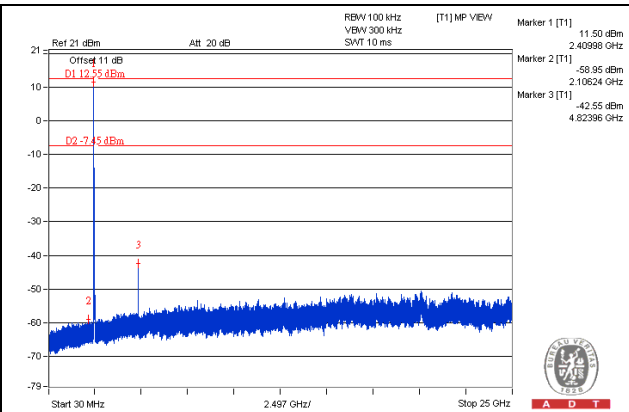
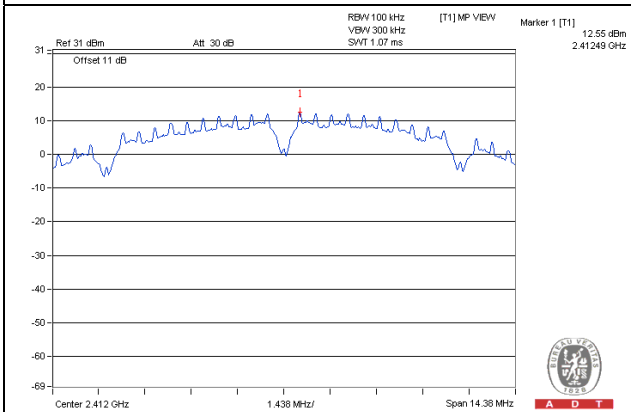

CH 6

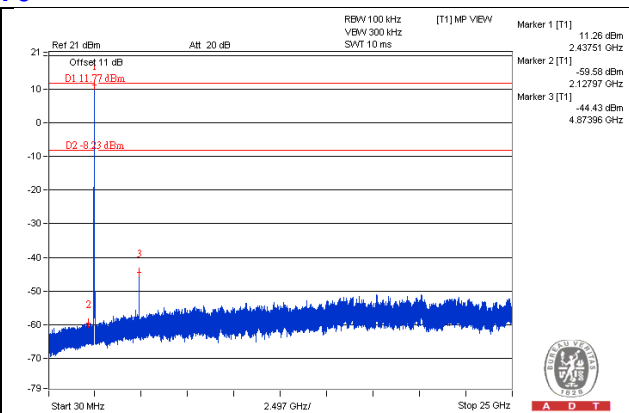
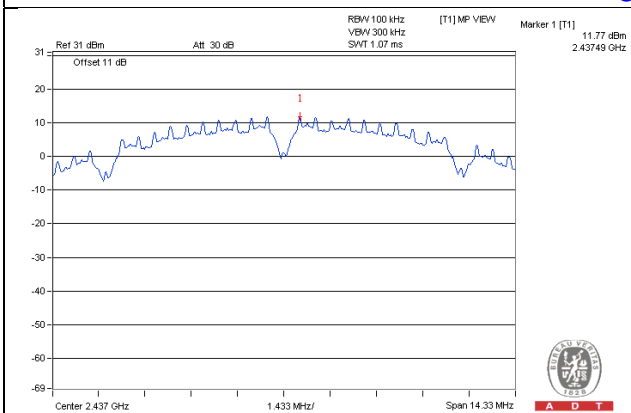

CH 11

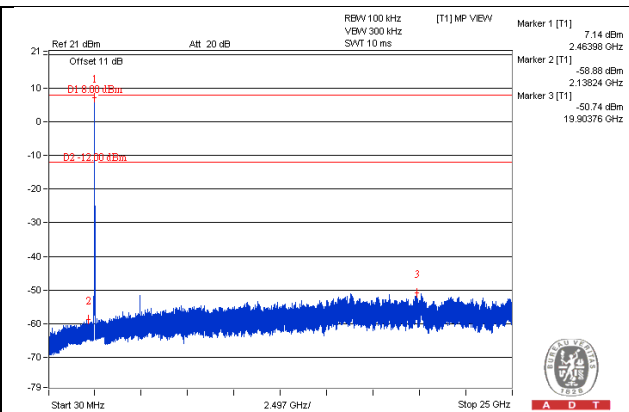
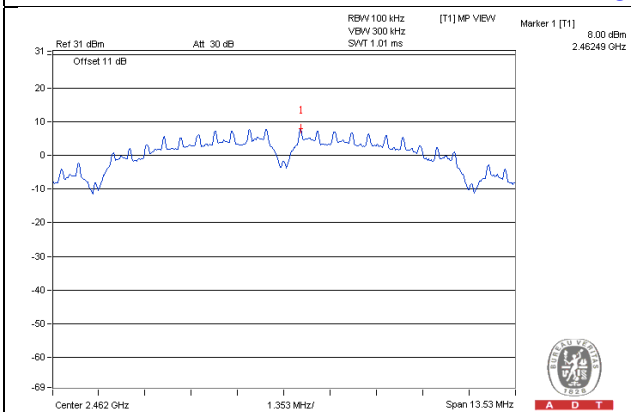

CH 1 Band edge

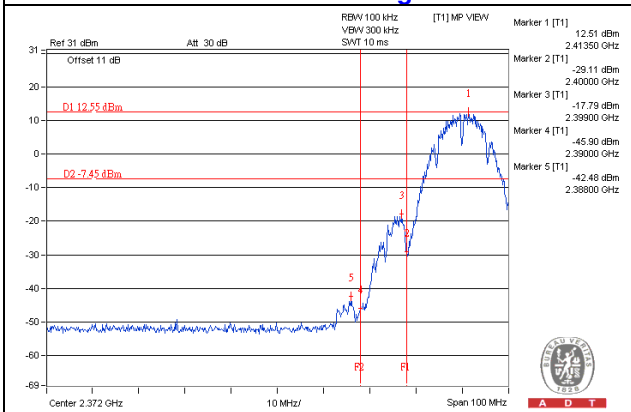

CH 11 Band edge

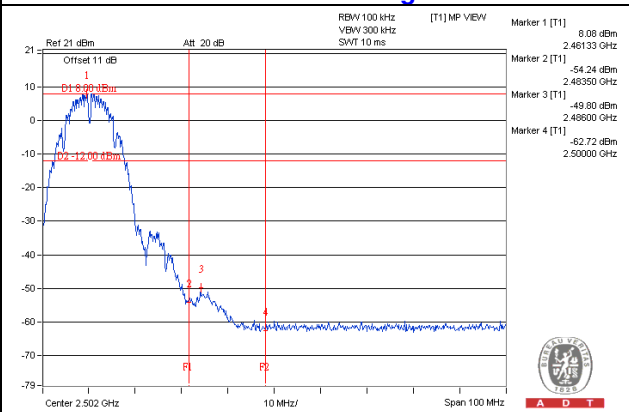

802.11g

CH 1

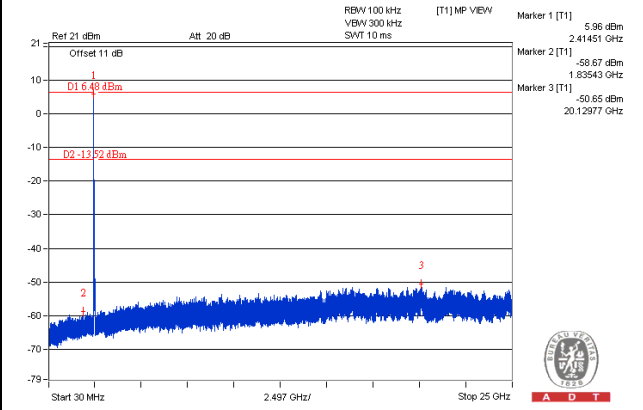
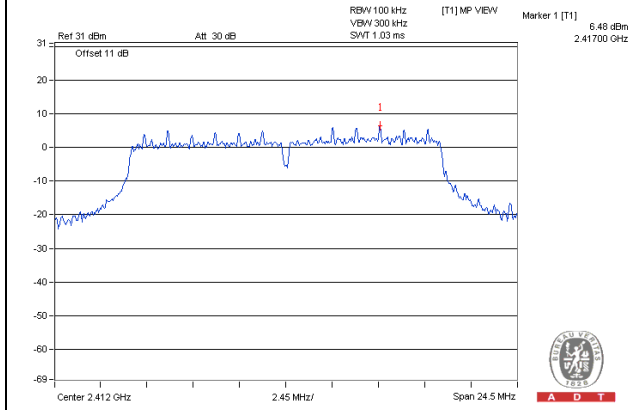

CH 6

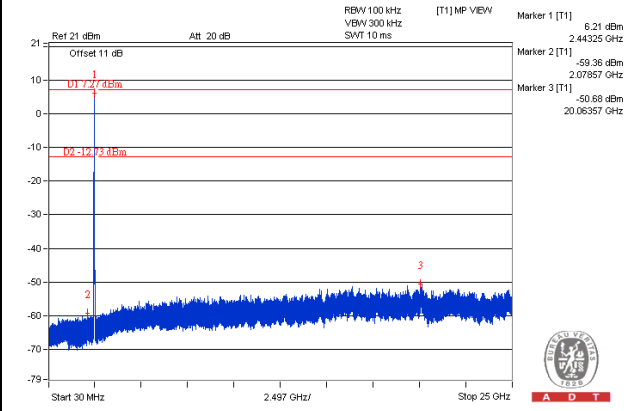
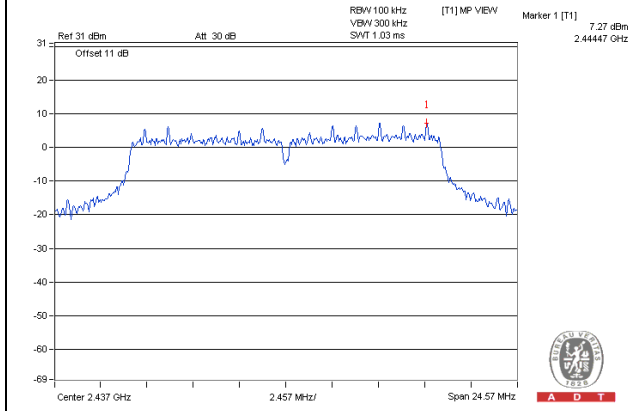

CH 11

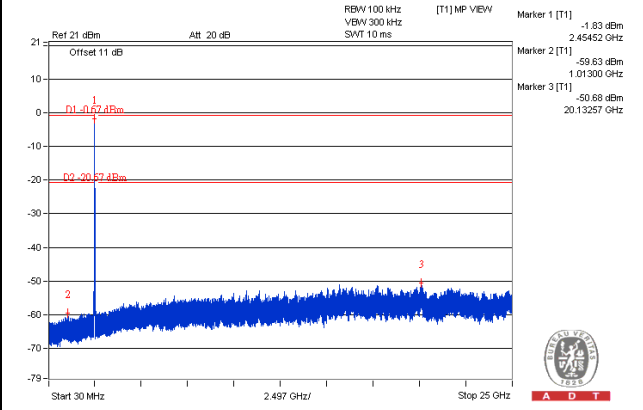
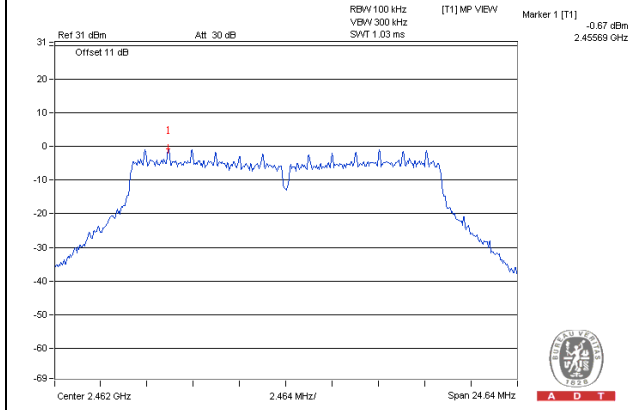

CH 1 Band edge

CH 11 Band edge

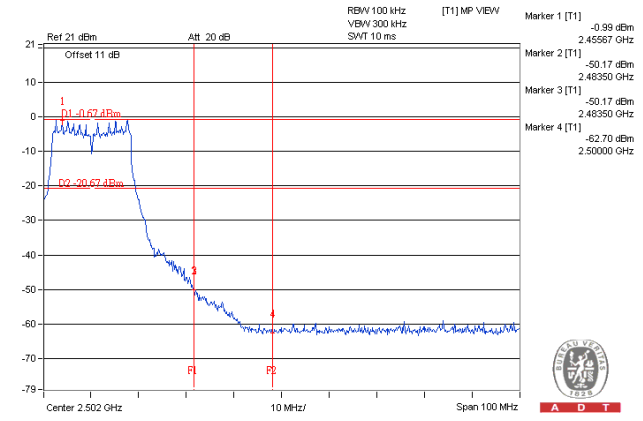
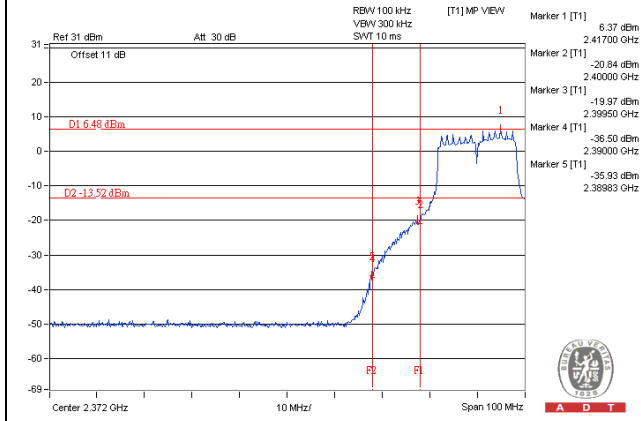

802.11n (HT20)

CH 1

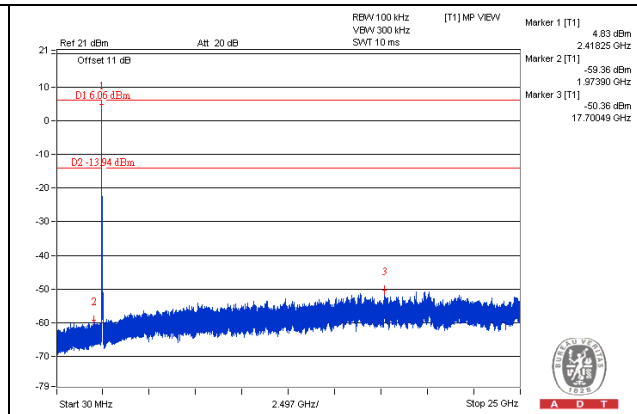
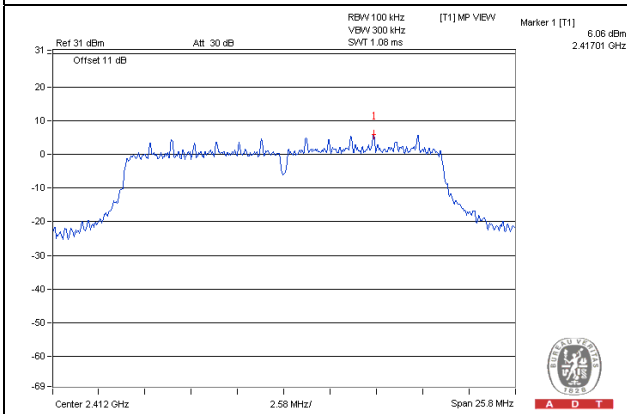

CH 6

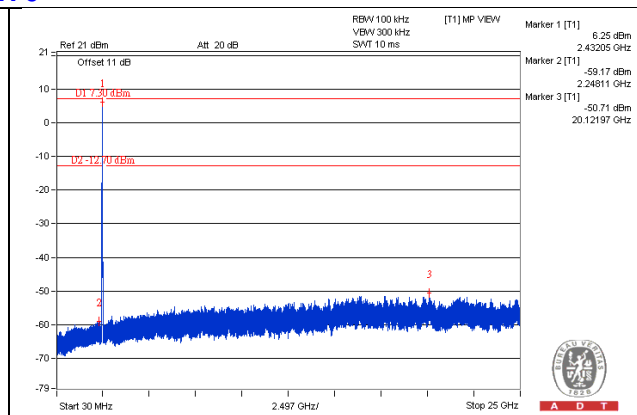
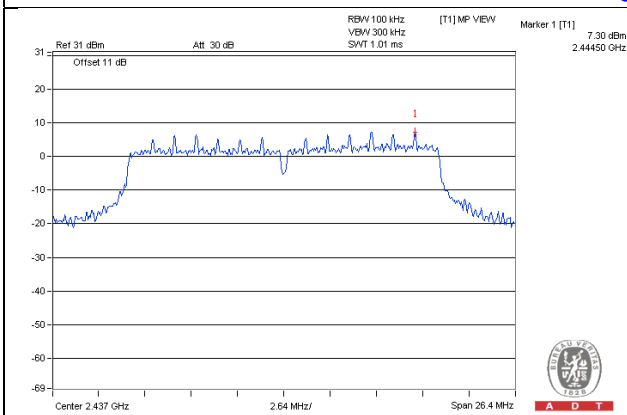

CH 11

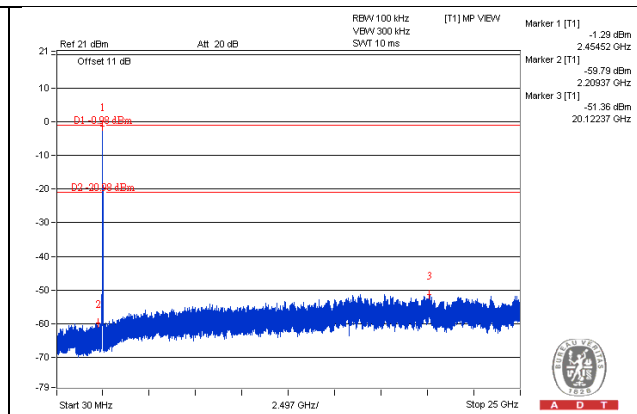
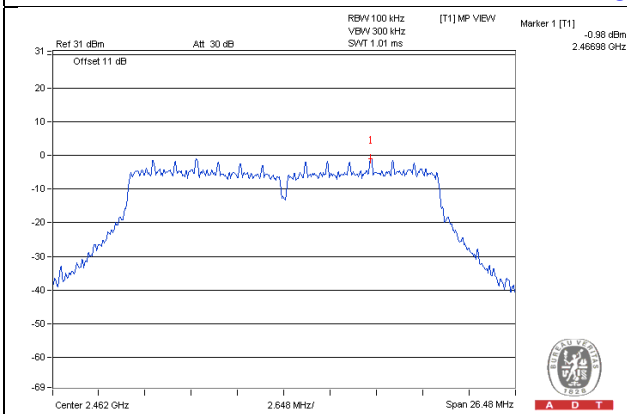

CH 1 Band edge

CH 11 Band edge

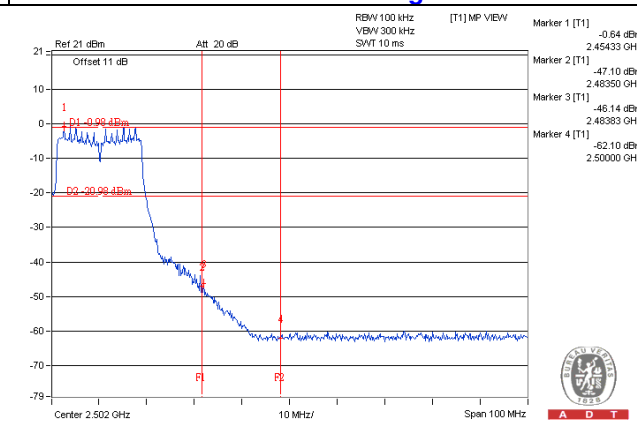
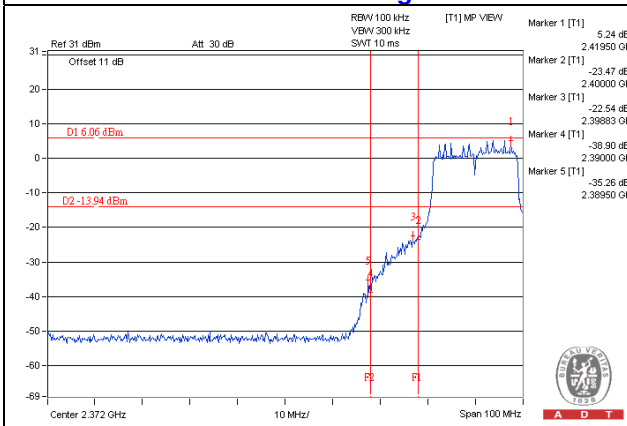

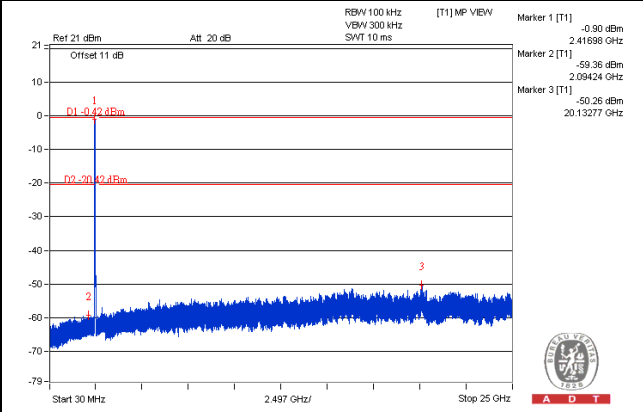
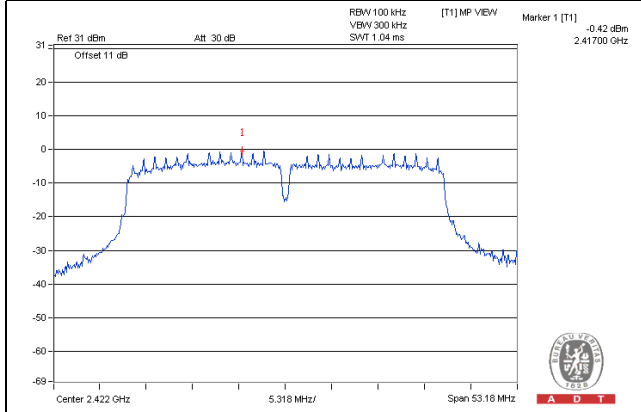
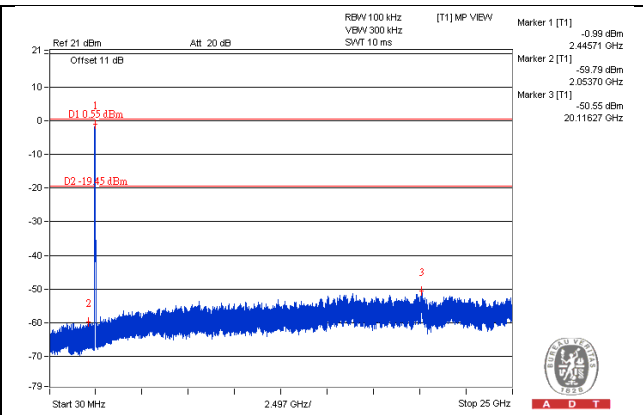
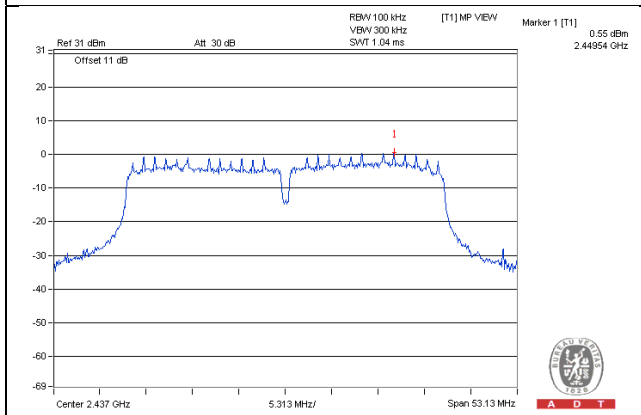
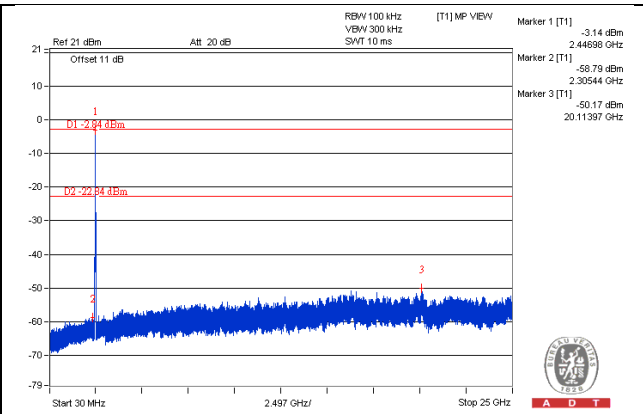
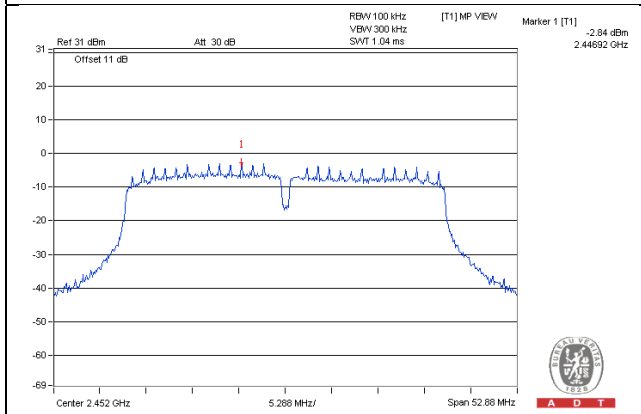
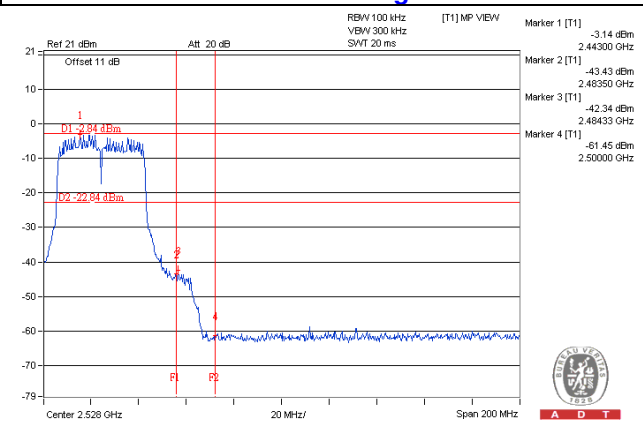
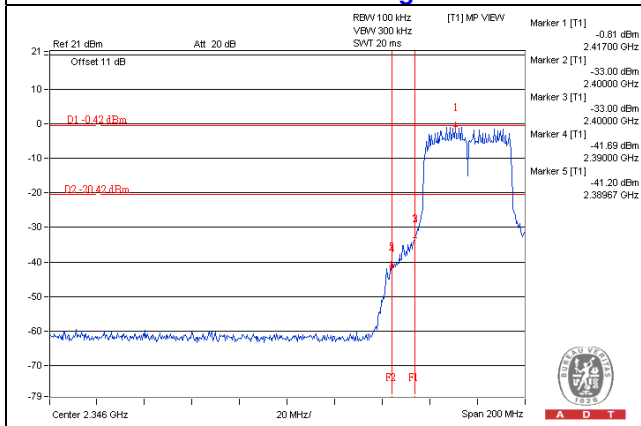
802.11n (HT40)
CH 3

CH 6

CH 9

CH 3 Band edge
CH 9 Band edge

5 Pictures of Test Arrangements

Please refer to the attached file (Test Setup Photo).

Appendix – Information on the Testing Laboratories

We, Bureau Veritas Consumer Products Services (H.K.) Ltd., Taoyuan Branch, were founded in 1988 to provide our best service in EMC, Radio, Telecom and Safety consultation. Our laboratories are accredited and approved according to ISO/IEC 17025.

If you have any comments, please feel free to contact us at the following:

Linko EMC/RF Lab

Tel: 886-2-26052180

Fax: 886-2-26051924

Hsin Chu EMC/RF/Telecom Lab

Tel: 886-3-6668565

Fax: 886-3-6668323

Hwa Ya EMC/RF/Safety Lab

Tel: 886-3-3183232

Fax: 886-3-3270892

Email: service.adt@tw.bureauveritas.com

Web Site: www.bureauveritas-adt.com

The address and road map of all our labs can be found in our web site also.

--- END ---