

FCC Test Report

Report No.: RF140107C15L-5

FCC ID: JNF-Z-224X

Test Model: Z-2242

Series Model: Z-2240

Received Date: Dec. 26, 2013

Test Date: May 30 ~ Aug. 26, 2015 (For all tests except AC Power Conducted Emission & Radiated Emissions (Frequency below 1GHz))

Dec. 01, 2015 ~ Jan. 30, 2016 (For AC Power Conducted Emission & Radiated Emissions (Frequency below 1GHz))

Issued Date: Feb. 02, 2016

Applicant: ZEBEX INDUSTRIES INC.

Address: B1F.-1, No. 207, Sec. 3, Beixin Rd, Xindian Dist, New Taipei City 23143, Taiwan

Issued By: Bureau Veritas Consumer Products Services (H.K.) Ltd., Taoyuan Branch

Lab Address: No. 47-2, 14th Ling, Chia Pau Vil., Lin Kou Dist., New Taipei City, Taiwan, R.O.C.

Test Location: No.19, Hwa Ya 2nd Rd., Wen Hwa Vil., Kwei Shan Dist., Taoyuan City 33383, TAIWAN (R.O.C.)



This report is for your exclusive use. Any copying or replication of this report to or for any other person or entity, or use of our name or trademark, is permitted only with our prior written permission. This report sets forth our findings solely with respect to the test samples identified herein. The results set forth in this report are not indicative or representative of the quality or characteristics of the lot from which a test sample was taken or any similar or identical product specifically and expressly noted. Our report includes all of the tests requested by you and the results thereof based upon the information that you provided to us. You have 60 days from date of issuance of this report to notify us of any material error or omission caused by our negligence, provided, however, that such notice shall be in writing and shall specifically address the issue you wish to raise. A failure to raise such issue within the prescribed time shall constitute your unqualified acceptance of the completeness of this report, the tests conducted and the correctness of the report contents. Unless specific mention, the uncertainty of measurement has been explicitly taken into account to declare the compliance or non-compliance to the specification. The report must not be used by the client to claim product certification, approval, or endorsement by TAF or any government agencies.



Table of Contents

Release Control Record	4
1 Certificate of Conformity	5
2 Summary of Test Results	6
2.1 Measurement Uncertainty.....	6
2.2 Modification Record.....	6
3 General Information	7
3.1 General Description of EUT.....	7
3.2 Description of Test Modes.....	9
3.2.1 Test Mode Applicability and Tested Channel Detail.....	11
3.3 Duty Cycle of Test Signal.....	14
3.4 Description of Support Units.....	15
3.4.1 Configuration of System under Test.....	15
3.5 General Description of Applied Standards.....	16
4 Test Types and Results	17
4.1 Radiated Emission and Bandedge Measurement.....	17
4.1.1 Limits of Radiated Emission and Bandedge Measurement.....	17
4.1.2 Test Instruments.....	18
4.1.3 Test Procedures.....	20
4.1.4 Deviation from Test Standard.....	20
4.1.5 Test Set Up.....	21
4.1.6 EUT Operating Conditions.....	21
4.1.7 Test Results.....	22
4.2 Conducted Emission Measurement.....	57
4.2.1 Limits of Conducted Emission Measurement.....	57
4.2.2 Test Instruments.....	57
4.2.3 Test Procedures.....	58
4.2.4 Deviation from Test Standard.....	58
4.2.5 Test Setup.....	58
4.2.6 EUT Operating Conditions.....	58
4.2.7 Test Results.....	59
4.3 Transmit Power Measurement.....	61
4.3.1 Limits of Transmit Power Measurement.....	61
4.3.2 Test Setup.....	61
4.3.3 Test Instruments.....	61
4.3.4 Test Procedure.....	61
4.3.5 Deviation from Test Standard.....	61
4.3.6 EUT Operating Conditions.....	61
4.3.7 Test Result.....	62
4.4 Peak Power Spectral Density Measurement.....	70
4.4.1 Limits of Peak Power Spectral Density Measurement.....	70
4.4.2 Test Setup.....	70
4.4.3 Test Instruments.....	70
4.4.4 Test Procedures.....	70
4.4.5 Deviation from Test Standard.....	70
4.4.6 EUT Operating Conditions.....	70
4.4.7 Test Results.....	71
4.5 Frequency Stability.....	75
4.5.1 Limits of Frequency Stability Measurement.....	75
4.5.2 Test Setup.....	75
4.5.3 Test Instruments.....	75
4.5.4 Test Procedure.....	75
4.5.5 Deviation from Test Standard.....	75
4.5.6 EUT Operating Condition.....	75



4.5.7 Test Results	76
4.6 6dB Bandwidth Measurement.....	77
4.6.1 Limits of 6dB Bandwidth Measurement.....	77
4.6.2 Test Setup.....	77
4.6.3 Test Instruments	77
4.6.4 Test Procedure	77
4.6.5 Deviation from Test Standard	77
4.6.6 EUT Operating Condition	77
4.6.7 Test Results	78
5 Pictures of Test Arrangements.....	80
Appendix – Information on the Testing Laboratories	81



A D T

Release Control Record

Issue No.	Description	Date Issued
RF140107C15L-5	Original release	Feb. 02, 2016

1 Certificate of Conformity

Product: Rugged Mobile Handheld Computer
Brand: ZEBEX
Test Model: Z-2242
Series Model: Z-2240
Sample Status: MASS-PRODUCTION
Applicant: ZEBEX INDUSTRIES INC.
Test Date: May 30 ~ Aug. 26, 2015 (For all tests except AC Power Conducted Emission & Radiated Emissions (Frequency below 1GHz))
Dec. 01, 2015 ~ Jan. 30, 2016 (For AC Power Conducted Emission & Radiated Emissions (Frequency below 1GHz))
Standards: 47 CFR FCC Part 15, Subpart E (Section 15.407)
ANSI C63.10: 2013

The above equipment has been tested by **Bureau Veritas Consumer Products Services (H.K.) Ltd., Taoyuan Branch**, and found compliance with the requirement of the above standards. The test record, data evaluation & Equipment Under Test (EUT) configurations represented herein are true and accurate accounts of the measurements of the sample's EMC characteristics under the conditions specified in this report.

Prepared by :  , **Date:** Feb. 02, 2016
Polly Chien / Specialist

Approved by :  , **Date:** Feb. 02, 2016
Ken Liu / Senior Manager

2 Summary of Test Results

47 CFR FCC Part 15, Subpart E (SECTION 15.407)			
FCC Clause	Test Item	Result	Remarks
15.407(b)(6)	AC Power Conducted Emissions	Pass	Meet the requirement of limit. Minimum passing margin is -11.88dB at 0.40000MHz.
15.407(b)(1/2/3/4/6)	Radiated Emissions & Band Edge Measurement	Pass	Meet the requirement of limit. Minimum passing margin is -1.0dB at 5150.00MHz, 5722.90MHz & 5714.90MHz.
15.407(a)(1/2/3)	Max Average Transmit Power	Pass	Meet the requirement of limit.
15.407(a)(1/2/3)	Peak Power Spectral Density	Pass	Meet the requirement of limit.
15.407(e)	6dB bandwidth	Pass	Meet the requirement of limit. (U-NII-3 Band only)
15.407(g)	Frequency Stability	Pass	Meet the requirement of limit.
15.203	Antenna Requirement	Pass	Antenna connector is IPEX not a standard connector.

2.1 Measurement Uncertainty

Where relevant, the following measurement uncertainty levels have been estimated for tests performed on the EUT as specified in CISPR 16-4-2:

Tested date: May 27 ~ Jun. 16, 2015

Measurement	Frequency	Expanded Uncertainty (k=2) (±)
Radiated Emissions above 1 GHz	1GHz ~ 18GHz	2.29 dB
	18GHz ~ 40GHz	2.29 dB

Tested date: Aug. 25, 2015 ~ Jan. 31, 2016

Measurement	Frequency	Expanded Uncertainty (k=2) (±)
Conducted Emissions at mains ports	150kHz ~ 30MHz	2.44 dB
Radiated Emissions up to 1 GHz	30MHz ~ 200MHz	3.63 dB

2.2 Modification Record

There were no modifications required for compliance.

3 General Information

3.1 General Description of EUT

Product	Rugged Mobile Handheld Computer
Brand	ZEBEX
Test Model	Z-2242
Series Model	Z-2240
Model Difference	Refer to note as below
Status of EUT	MASS-PRODUCTION
Power Supply Rating	3.7Vdc (Battery) 5.35Vdc (Adapter) 5.0Vdc (Cradle) 19Vdc (Wireless Power Charger)
Modulation Type	64QAM, 16QAM, QPSK, BPSK
Modulation Technology	OFDM
Transfer Rate	802.11a: 54.0/ 48.0/ 36.0/ 24.0/ 18.0/ 12.0/ 9.0/ 6.0Mbps 802.11n: up to 72.2Mbps
Operating Frequency	5180 ~ 5240MHz, 5260 ~ 5320MHz, 5500 ~ 5700MHz & 5745 ~ 5825MHz
Number of Channel	5180 ~ 5240MHz: 4 for 802.11a, 802.11n (HT20) 2 for 802.11n (HT40) 5260 ~ 5320MHz: 4 for 802.11a, 802.11n (HT20) 2 for 802.11n (HT40) 5500 ~ 5700MHz: 8 for 802.11a, 802.11n (HT20) 3 for 802.11n (HT40) 5745 ~ 5825MHz: 5 for 802.11a, 802.11n (HT20) 2 for 802.11n (HT40)
Output Power	5180 ~ 5240MHz: 38.194mW 5260 ~ 5320MHz: 36.644mW 5500 ~ 5700MHz: 71.121mW 5745 ~ 5825MHz: 68.234mW
Antenna Type	PIFA antenna with 3.67dBi gain
Antenna Connector	IPEX
Accessory Device	Refer to Note as below
Data Cable Supplied	Refer to Note as below

Note:

1. All brands and models are listed as below. After pretesting, the model of the Z-2242 was worst case and chosen for final test.

Brand	Model	Description
ZEBEX	Z-2242	Barcode scanner
	Z-2240	Non-barcode scanner
		For marketing purpose

2. The EUT provides 1 completed transmitter and 1 receiver.

Modulation Mode	TX Function
802.11a	1TX
802.11n (HT20)	1TX
802.11n (HT40)	1TX

3. The EUT contains the following accessories.

No.	Product	Brand	Model	Description	Remark
1	Adapter	Sunny COMPUTER TECHNOLOGY CO., LTD.	SYS1561-1105-1	Input: 100-240Vac, 1.0A MAX, 50-60Hz Output: 5.35Vdc, 2A	Accessory
2	Battery 1	ETI CA Battery inc.	BP13-001080	Rating: 3.7Vdc Capacity, 3450mA	Accessory
3	Battery 2		BP14-001160	Type: Li-ion	Accessory
4	Micro USB cable	-	-	1m shielded USB to Micro B cable without core	Accessory
5	Cradle	ZEBEX	CRD-40	Input: 5Vdc	Support unit
6	Wireless Power Charger	yardiX	CXT31106	Input: 19Vdc, 0.5A Output: 19Vdc, 0.5A	Support unit
7	Adapter (for Wireless Power Charger)	-	HNC190050U	Input: 100-240Vac, 50/60Hz, 0.35A Max Output: 19.0Vdc, 0.5A 1.55m cable with 1 core attached on adapter	Support unit

* The Battery models are electrically identical, different model names are for marketing purpose. Battery 1 was chosen for final test.

4. The EUT has disabled the 5600-5650MHz band by S/W to avoid 5600-5650MHz.

5. The above EUT information is declared by manufacturer and for more detailed features description, please refer to the manufacturer's specifications or user's manual.

3.2 Description of Test Modes

FOR 5180 ~ 5240MHz

4 channels are provided for 802.11a, 802.11n (HT20):

Channel	Frequency	Channel	Frequency
36	5180 MHz	44	5220 MHz
40	5200 MHz	48	5240 MHz

2 channels are provided for 802.11n (HT40):

Channel	Frequency	Channel	Frequency
38	5190 MHz	46	5230 MHz

FOR 5260 ~ 5320MHz

4 channels are provided for 802.11a, 802.11n (HT20):

Channel	Frequency	Channel	Frequency
52	5260 MHz	60	5300 MHz
56	5280 MHz	64	5320 MHz

2 channels are provided for 802.11n (HT40):

Channel	Frequency	Channel	Frequency
54	5270 MHz	62	5310 MHz

FOR 5500 ~ 5700MHz

8 channels are provided for 802.11a, 802.11n (HT20):

Channel	Frequency	Channel	Frequency
100	5500 MHz	116	5580 MHz
104	5520 MHz	132	5660 MHz
108	5540 MHz	136	5680 MHz
112	5560 MHz	140	5700 MHz

3 channels are provided for 802.11n (HT40):

Channel	Frequency	Channel	Frequency
102	5510 MHz	134	5670 MHz
110	5550 MHz		

FOR 5745 ~ 5825MHz:

5 channels are provided for 802.11a, 802.11n (HT20):

Channel	Frequency	Channel	Frequency
149	5745MHz	161	5805MHz
153	5765MHz	165	5825MHz
157	5785MHz		

2 channels are provided for 802.11n (HT40):

Channel	Frequency	Channel	Frequency
151	5755MHz	159	5795MHz

3.2.1 Test Mode Applicability and Tested Channel Detail

EUT CONFIGURE MODE	APPLICABLE TO				DESCRIPTION
	RE \geq 1G	RE $<$ 1G	PLC	APCM	
A	√	√	√	√	EUT + adapter
B	-	√	-	-	EUT + Wireless power charger

Where **RE \geq 1G**: Radiated Emission above 1GHz & Bandedge Measurement
RE $<$ 1G: Radiated Emission below 1GHz
PLC: Power Line Conducted Emission
APCM: Antenna Port Conducted Measurement

NOTE:

- The EUT had been pre-tested on the positioned of each 3 axis. The worst case was found when positioned on **Z-plane** for adapter mode and **X-plane** for Wireless power charger mode.
- After pre-tested adapter, cradle and EUT only modes, we found adapter mode was the worst case, therefore chosen for final tests and presented in the test report.
- "-": Means no effect.

Radiated Emission Test (Above 1GHz):

- Pre-Scan has been conducted to determine the worst-case mode from all possible combinations between available modulations, data rates and antenna ports (if EUT with antenna diversity architecture).
- Following channel(s) was (were) selected for the final test as listed below.

EUT CONFIGURE MODE	MODE	FREQ. BAND (MHz)	AVAILABLE CHANNEL	TESTED CHANNEL	MODULATION TECHNOLOGY	MODULATION TYPE	DATA RATE (Mbps)
A	802.11a	5180-5240	36 to 48	36, 40, 48	OFDM	BPSK	6.0
A	802.11n (HT20)		36 to 48	36, 40, 48	OFDM	BPSK	6.5
A	802.11n (HT40)		38 to 46	38, 46	OFDM	BPSK	13.5
A	802.11a	5260-5320	52 to 64	52, 60, 64	OFDM	BPSK	6.0
A	802.11n (HT20)		52 to 64	52, 60, 64	OFDM	BPSK	6.5
A	802.11n (HT40)		54 to 62	54, 62	OFDM	BPSK	13.5
A	802.11a	5500-5700	100 to 140	100, 116, 140	OFDM	BPSK	6.0
A	802.11n (HT20)		100 to 140	100, 116, 140	OFDM	BPSK	6.5
A	802.11n (HT40)		102 to 134	102, 110, 134	OFDM	BPSK	13.5
A	802.11a	5745-5825	149 to 165	149, 157, 165	OFDM	BPSK	6.0
A	802.11n (HT20)		149 to 165	149, 157, 165	OFDM	BPSK	6.5
A	802.11n (HT40)		151 to 159	151, 159	OFDM	BPSK	13.5

Radiated Emission Test (Below 1GHz):

- Pre-Scan has been conducted to determine the worst-case mode from all possible combinations between available modulations, data rates and antenna ports (if EUT with antenna diversity architecture).
- Following channel(s) was (were) selected for the final test as listed below.

EUT CONFIGURE MODE	MODE	FREQ. BAND (MHz)	AVAILABLE CHANNEL	TESTED CHANNEL	MODULATION TECHNOLOGY	MODULATION TYPE	DATA RATE (Mbps)
A, B	802.11n (HT20)	5180-5240	36 to 48	116	OFDM	BPSK	6.5
		5260-5320	52 to 64		OFDM	BPSK	6.5
		5500-5700	100 to 140		OFDM	BPSK	6.5
		5745-5825	149 to 165		OFDM	BPSK	6.5

Power Line Conducted Emission Test:

- Pre-Scan has been conducted to determine the worst-case mode from all possible combinations between available modulations, data rates and antenna ports (if EUT with antenna diversity architecture).
- Following channel(s) was (were) selected for the final test as listed below.

EUT CONFIGURE MODE	MODE	FREQ. BAND (MHz)	AVAILABLE CHANNEL	TESTED CHANNEL	MODULATION TECHNOLOGY	MODULATION TYPE	DATA RATE (Mbps)
A	802.11n (HT20)	5180-5240	36 to 48	116	OFDM	BPSK	6.5
		5260-5320	52 to 64		OFDM	BPSK	6.5
		5500-5700	100 to 140		OFDM	BPSK	6.5
		5745-5825	149 to 165		OFDM	BPSK	6.5

Antenna Port Conducted Measurement:

- This item includes all test value of each mode, but only includes spectrum plot of worst value of each mode.
- Pre-Scan has been conducted to determine the worst-case mode from all possible combinations between available modulations, data rates and antenna ports (if EUT with antenna diversity architecture).
- Following channel(s) was (were) selected for the final test as listed below.

EUT CONFIGURE MODE	MODE	FREQ. BAND (MHz)	AVAILABLE CHANNEL	TESTED CHANNEL	MODULATION TECHNOLOGY	MODULATION TYPE	DATA RATE (Mbps)
A	802.11a	5180-5240	36 to 48	36, 40, 48	OFDM	BPSK	6.0
A	802.11n (HT20)		36 to 48	36, 40, 48	OFDM	BPSK	6.5
A	802.11n (HT40)		38 to 46	38, 46	OFDM	BPSK	13.5
A	802.11a	5260-5320	52 to 64	52, 60, 64	OFDM	BPSK	6.0
A	802.11n (HT20)		52 to 64	52, 60, 64	OFDM	BPSK	6.5
A	802.11n (HT40)		54 to 62	54, 62	OFDM	BPSK	13.5
A	802.11a	5500-5700	100 to 140	100, 116, 140	OFDM	BPSK	6.0
A	802.11n (HT20)		100 to 140	100, 116, 140	OFDM	BPSK	6.5
A	802.11n (HT40)		102 to 134	102, 110, 134	OFDM	BPSK	13.5
A	802.11a	5745-5825	149 to 165	149, 157, 165	OFDM	BPSK	6.0
A	802.11n (HT20)		149 to 165	149, 157, 165	OFDM	BPSK	6.5
A	802.11n (HT40)		151 to 159	151, 159	OFDM	BPSK	13.5



Test Condition:

APPLICABLE TO	ENVIRONMENTAL CONDITIONS	INPUT POWER	TESTED BY
RE \geq 1G	25deg. C, 65%RH	120Vac, 60Hz	Tank Wu
RE<1G	18deg. C, 70%RH	120Vac, 60Hz	Nick Hsu
	25deg. C, 65%RH	120Vac, 60Hz	Bayu Chen
PLC	20deg. C, 70%RH	120Vac, 60Hz	Jones Chang
APCM	25deg. C, 60%RH	120Vac, 60Hz	Leo Tsai

3.3 Duty Cycle of Test Signal

Duty cycle of test signal is < 98 %, duty factor is required

802.11a: Duty cycle = $1.363/1.573 = 0.866$, Duty factor = $10 * \log(1/0.866) = 0.62$

802.11n (HT20): Duty cycle = $1.272/1.497 = 0.850$, Duty factor = $10 * \log(1/0.850) = 0.71$

802.11n (HT40): Duty cycle = $0.632/0.747 = 0.846$, Duty factor = $10 * \log(1/0.846) = 0.73$

802.11a

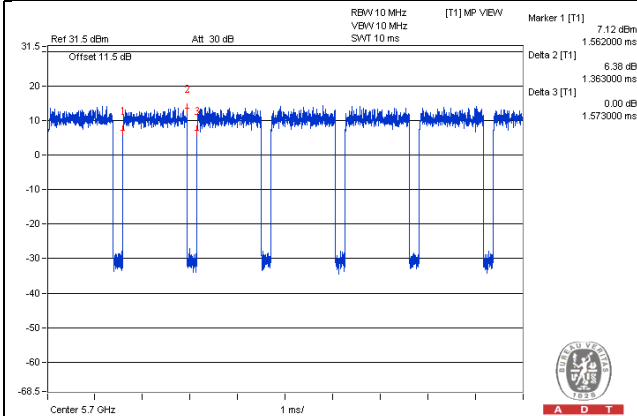

802.11n (HT20)

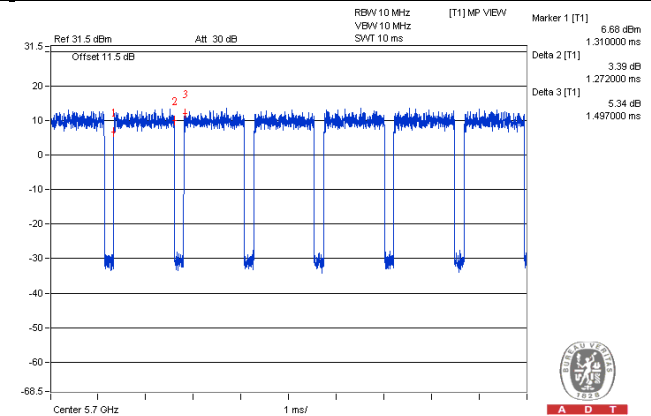

802.11n (HT40)

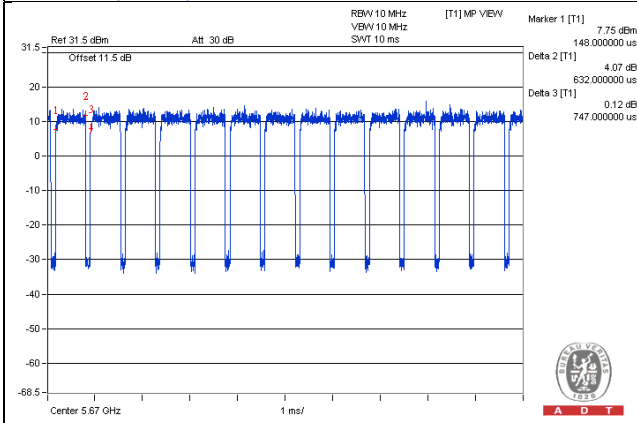

3.4 Description of Support Units

The EUT has been tested as an independent unit together with other necessary accessories or support units. The following support units or accessories were used to form a representative test configuration during the tests.

ID	Product	Brand	Model No.	Serial No.	FCC ID	Remarks
A.	Wireless Power Charger	yardiX	CXT31106	NA	NA	Provided by the manufacturer
B.	Adapter (for Wireless Power Charger)	NA	HNC190050U	NA	NA	Provided by the manufacturer

Note: All power cords of the above support units are non-shielded (1.8m).

ID	Descriptions	Qty.	Length (m)	Shielding (Yes/No)	Cores (Qty.)	Remarks
1.	Power cable	1	1.55	-	1	Provided by the manufacturer

3.4.1 Configuration of System under Test

Test Mode A

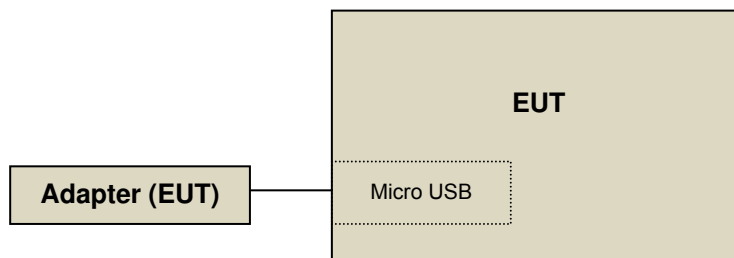

Test Mode B

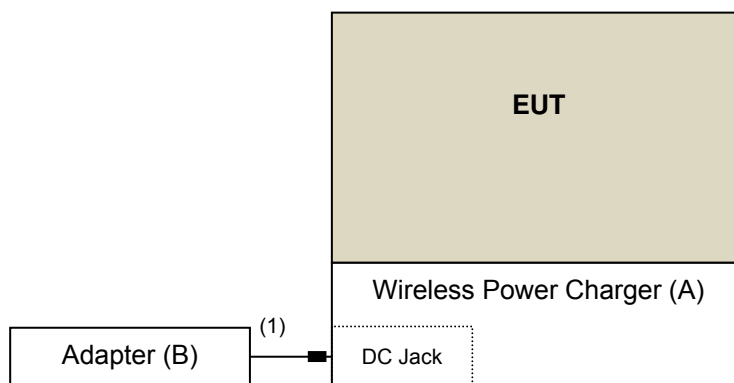

3.5 General Description of Applied Standards

The EUT is a RF Product. According to the specifications of the manufacturer, it must comply with the requirements of the following standards:

FCC Part 15, Subpart E (15.407)

789033 D02 General UNII Test Procedures New Rules v01r01

ANSI C63.10-2013

All test items have been performed and recorded as per the above standards.

NOTE: The EUT has been verified to comply with the requirements of FCC Part 15, Subpart B, Class B (DoC). The test report has been issued separately.

4 Test Types and Results

4.1 Radiated Emission and Bandedge Measurement

4.1.1 Limits of Radiated Emission and Bandedge Measurement

Radiated emissions which fall in the restricted bands must comply with the radiated emission limits specified as below table. Other emissions shall be at least 20dB below the highest level of the desired power:

Frequencies (MHz)	Field Strength (microvolts/meter)	Measurement Distance (meters)
0.009 ~ 0.490	2400/F(kHz)	300
0.490 ~ 1.705	24000/F(kHz)	30
1.705 ~ 30.0	30	30
30 ~ 88	100	3
88 ~ 216	150	3
216 ~ 960	200	3
Above 960	500	3

NOTE:

1. The lower limit shall apply at the transition frequencies.
2. Emission level (dBuV/m) = 20 log Emission level (uV/m).
3. For frequencies above 1000MHz, the field strength limits are based on average detector, however, the peak field strength of any emission shall not exceed the maximum permitted average limits, specified above by more than 20dB under any condition of modulation.

LIMITS OF UNWANTED EMISSION OUT OF THE RESTRICTED BANDS

APPLICABLE TO	LIMIT	
789033 D02 General UNII Test Procedures New Rules v01	FIELD STRENGTH AT 3m	
	PK:74 (dBuV/m)	AV:54 (dBuV/m)
APPLICABLE TO	EIRP LIMIT	EQUIVALENT FIELD STRENGTH AT 3m
15.407(b)(1)	PK:-27 (dBm/MHz)	PK:68.2(dBuV/m)
15.407(b)(2)		
15.407(b)(3)		
15.407(b)(4)	PK:-27 (dBm/MHz) ^{*1} PK:-17 (dBm/MHz) ^{*2}	PK: 68.2(dBuV/m) ^{*1} PK:78.2 (dBuV/m) ^{*2}

NOTE: ^{*1} beyond 10MHz of the band edge ^{*2} within 10 MHz of band edge

The following formula is used to convert the equipment isotropic radiated power (eirp) to field strength:

$$E = \frac{1000000\sqrt{30P}}{3} \mu\text{V/m, where P is the eirp (Watts).}$$

4.1.2 Test Instruments

Tested date: May 27 ~ Jun. 16, 2015

DESCRIPTION & MANUFACTURER	MODEL NO.	SERIAL NO.	DATE OF CALIBRATION	DUE DATE OF CALIBRATION
Test Receiver ROHDE & SCHWARZ	ESCI	100424	Oct. 06, 2014	Oct. 05, 2015
Spectrum Analyzer ROHDE & SCHWARZ	FSP40	100040	Jul. 25, 2014	Jul. 24, 2015
BILOG Antenna SCHWARZBECK	VULB9168	9168-155	Feb. 06, 2015	Feb. 05, 2016
HORN Antenna SCHWARZBECK	BBHA 9120D	9120D-1170	Feb. 05, 2015	Feb. 04, 2016
HORN Antenna SCHWARZBECK	BBHA 9170	BBHA9170241	Feb. 09, 2015	Feb. 08, 2016
Preamplifier Agilent	8449B	3008A01960	Aug. 09, 2014	Aug. 08, 2015
Preamplifier Agilent	8447D	2944A10631	Aug. 09, 2014	Aug. 08, 2015
RF signal cable HUBER+SUHNNER	SUCOFLEX 104	309220/4	Aug. 09, 2014	Aug. 08, 2015
RF signal cable HUBER+SUHNNER	SUCOFLEX 104	250724/4	Aug. 09, 2014	Aug. 08, 2015
RF signal cable HUBER+SUHNNER	SUCOFLEX 104	295012/4	Aug. 09, 2014	Aug. 08, 2015
Software BV ADT	ADT_Radiated_ V7.6.15.9.4	NA	NA	NA
Antenna Tower inn-co GmbH	MA 4000	010303	NA	NA
Antenna Tower Controller BV ADT	AT100	AT93021703	NA	NA
Turn Table BV ADT	TT100	TT93021703	NA	NA
Turn Table Controller BV ADT	SC100.	SC93021703	NA	NA
26GHz ~ 40GHz Amplifier	EM26400	815221	Oct. 18, 2014	Oct. 17, 2015
High Speed Peak Power Meter	ML2495A	0824011	Jul. 26, 2014	Jul. 25, 2015
Power Sensor	MA2411B	0738171	Jul. 26, 2014	Jul. 25, 2015

- NOTE:**
1. The calibration interval of the above test instruments is 12 months and the calibrations are traceable to NML/ROC and NIST/USA.
 2. The test was performed in HwaYa Chamber 4.
 3. The horn antenna and HP preamplifier (model: 8449B) are used only for the measurement of emission frequency above 1GHz if tested.
 4. The FCC Site Registration No. is 460141.
 5. The IC Site Registration No. is IC7450F-4.



A D T

Tested date: Aug. 25, 2015 ~ Jan. 30, 2016

Description & Manufacturer	Model No.	Serial No.	Cal. Date	Cal. Due
Test Receiver ROHDE & SCHWARZ	ESIB7	100187	Apr. 10, 2015	Apr. 09, 2016
Spectrum Analyzer ROHDE & SCHWARZ	FSP40	100269	Mar. 30, 2015	Mar. 29, 2016
BILOG Antenna SCHWARZBECK	VULB9168	9168-148	Feb. 02, 2015	Feb. 01, 2016
HORN Antenna SCHWARZBECK	BBHA 9120 D	9120D-1169	Feb. 09, 2015	Feb. 08, 2016
HORN Antenna SCHWARZBECK	BBHA 9170	BBHA9170241	Feb. 09, 2015	Feb. 08, 2016
Preamplifier Agilent	8449B	3008A01911	Aug. 09, 2015	Aug. 08, 2016
Preamplifier Agilent	8447D	2944A10638	Aug. 09, 2015	Aug. 08, 2016
RF signal cable HUBER+SUHNER	SUCOFLEX 104	CABLE-CH9-02(309222 +248780)	Aug. 09, 2015	Aug. 08, 2016
RF signal cable HUBER+SUHNER	SUCOFLEX 104	CABLE-CH9-03(274092)	Aug. 09, 2015	Aug. 08, 2016
RF signal cable Woken	8D-FB	Cable-CH9-01	Aug. 11, 2015	Aug. 10, 2016
Software BV ADT	ADT_Radiated_ V7.6.15.9.4	NA	NA	NA
Antenna Tower EMCO	2070/2080	512.835.4684	NA	NA
Turn Table EMCO	2087-2.03	NA	NA	NA
Antenna Tower & Turn BV ADT	AT100	AT93021705	NA	NA
Turn Table BV ADT	TT100	TT93021705	NA	NA
Turn Table Controller BV ADT	SC100	SC93021705	NA	NA

NOTE: 1. The calibration interval of the above test instruments is 12 months and the calibrations are traceable to NML/ROC and NIST/USA.

2. The test was performed in HwaYa Chamber 9.

3. The horn antenna and HP preamplifier (model: 8449B) are used only for the measurement of emission frequency above 1GHz if tested.

4. The FCC Site Registration No. is 215374.

5. The IC Site Registration No. is IC 7450F-9.

4.1.3 Test Procedures

- a. The EUT was placed on the top of a rotating table 0.8 meters (for below 1GHz) / 1.5 meters (for above 1GHz) above the ground at 3 meter chamber room for test. The table was rotated 360 degrees to determine the position of the highest radiation.
- b. The EUT was set 3 meters away from the interference-receiving antenna, which was mounted on the top of a variable-height antenna tower.
- c. The height of antenna is varied from one meter to four meters above the ground to determine the maximum value of the field strength. Both horizontal and vertical polarizations of the antenna are set to make the measurement.
- d. For each suspected emission, the EUT was arranged to its worst case and then the antenna was tuned to heights from 1 meter to 4 meters and the rotatable table was turned from 0 degrees to 360 degrees to find the maximum reading.
- e. The test-receiver system was set to quasi-peak detect function and specified bandwidth with maximum hold mode when the test frequency is below 1 GHz.
- f. The test-receiver system was set to peak and average detect function and specified bandwidth with maximum hold mode when the test frequency is above 1 GHz. If the peak reading value also meets average limit, measurement with the average detector is unnecessary.

Note:

1. The resolution bandwidth and video bandwidth of test receiver/spectrum analyzer is 120kHz for Quasi-peak detection (QP) at frequency below 1GHz.
2. The resolution bandwidth of test receiver/spectrum analyzer is 1 MHz and the video bandwidth is 3 MHz for Peak detection (PK) at frequency above 1GHz.
3. The resolution bandwidth of test receiver/spectrum analyzer is 1MHz and the video bandwidth is 3MHz for RMS Average (Duty cycle < 98%) for Average detection (AV) at frequency above 1GHz, then the measurement results was added to a correction factor ($10 \log(1/\text{duty cycle})$).
4. The resolution bandwidth of test receiver/spectrum analyzer is 1MHz and the video bandwidth is 10Hz (Duty cycle $\geq 98\%$) for Average detection (AV) at frequency above 1GHz.
5. All modes of operation were investigated and the worst-case emissions are reported.

4.1.4 Deviation from Test Standard

No deviation.

4.1.5 Test Set Up

<Frequency Range below 1GHz>

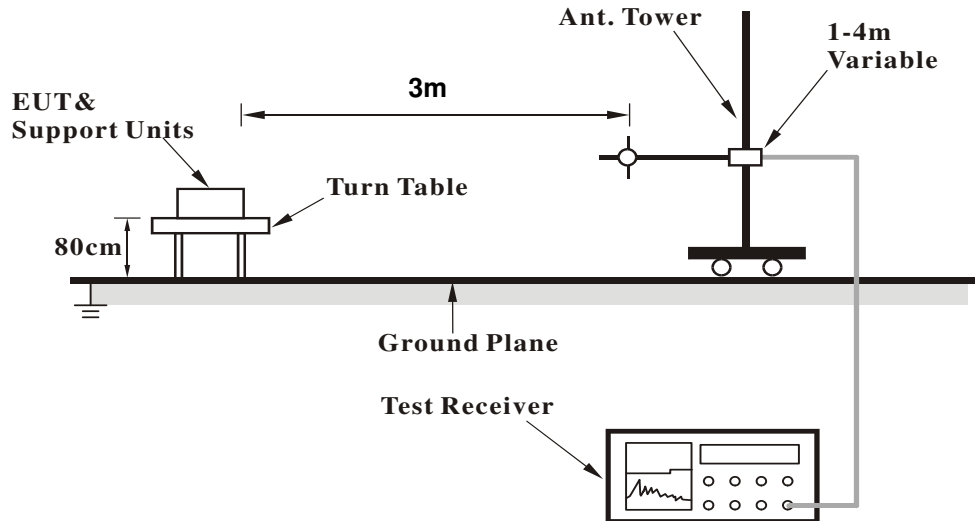

<Frequency Range above 1GHz>

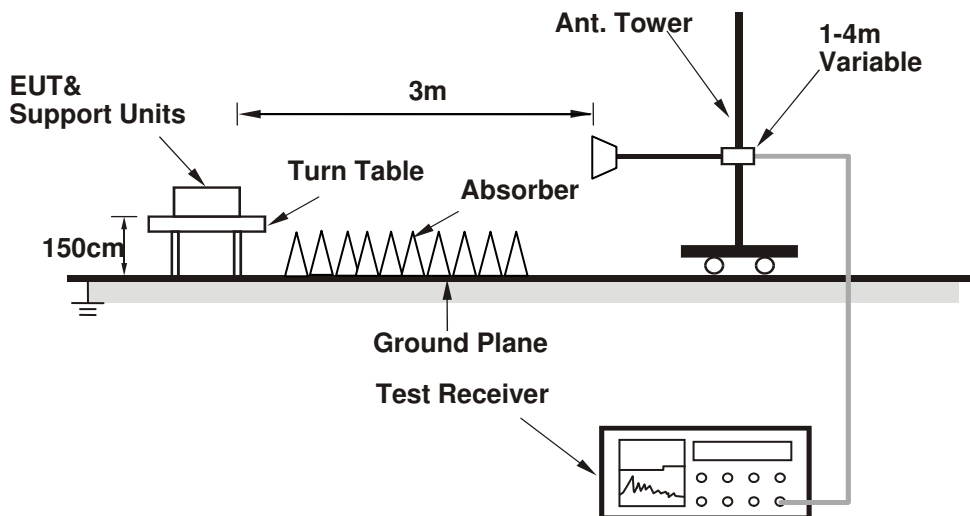

For the actual test configuration, please refer to the attached file (Test Setup Photo)

4.1.6 EUT Operating Conditions

- a. The EUT powered by adapter and under charging mode.
- b. Set the EUT under transmission condition continuously at specific channel frequency.

4.1.7 Test Results
ABOVE 1GHz DATA
802.11a

CHANNEL	TX Channel 36	DETECTOR FUNCTION	Peak (PK)
FREQUENCY RANGE	1GHz ~ 40GHz		Average (AV)

ANTENNA POLARITY & TEST DISTANCE: HORIZONTAL AT 3 M

NO.	FREQ. (MHz)	EMISSION LEVEL (dBuV/m)	LIMIT (dBuV/m)	MARGIN (dB)	ANTENNA HEIGHT (m)	TABLE ANGLE (Degree)	RAW VALUE (dBuV)	CORRECTION FACTOR (dB/m)
1	5150.00	47.9 PK	74.0	-26.1	1.00 H	217	45.90	2.00
2	5150.00	43.5 AV	54.0	-10.5	1.00 H	217	41.50	2.00
3	*5180.00	100.4 PK			1.00 H	217	60.40	40.00
4	*5180.00	89.3 AV			1.00 H	217	49.30	40.00
5	#10360.00	59.6 PK	74.0	-14.4	1.00 H	218	44.60	15.00
6	#10360.00	46.5 AV	54.0	-7.5	1.00 H	218	31.50	15.00

ANTENNA POLARITY & TEST DISTANCE: VERTICAL AT 3 M

NO.	FREQ. (MHz)	EMISSION LEVEL (dBuV/m)	LIMIT (dBuV/m)	MARGIN (dB)	ANTENNA HEIGHT (m)	TABLE ANGLE (Degree)	RAW VALUE (dBuV)	CORRECTION FACTOR (dB/m)
1	5150.00	57.7 PK	74.0	-16.3	1.83 V	235	55.70	2.00
2	5150.00	43.5 AV	54.0	-10.5	1.83 V	235	41.50	2.00
3	*5180.00	101.2 PK			1.83 V	233	61.20	40.00
4	*5180.00	90.1 AV			1.83 V	233	50.10	40.00
5	#10360.00	60.6 PK	74.0	-13.4	1.54 V	96	45.60	15.00
6	#10360.00	47.5 AV	54.0	-6.5	1.54 V	96	32.50	15.00

REMARKS:

1. Emission Level(dBuV/m) = Raw Value(dBuV) + Correction Factor(dB/m)
2. Correction Factor(dB/m) = Antenna Factor(dB/m) + Cable Factor(dB) – Pre-Amplifier Factor(dB)
3. The other emission levels were very low against the limit.
4. Margin value = Emission Level – Limit value
5. " * ": Fundamental frequency.
6. " # ": The radiated frequency is out of the restricted band.

CHANNEL	TX Channel 40	DETECTOR FUNCTION	Peak (PK)
FREQUENCY RANGE	1GHz ~ 40GHz		Average (AV)

ANTENNA POLARITY & TEST DISTANCE: HORIZONTAL AT 3 M

NO.	FREQ. (MHz)	EMISSION LEVEL (dBuV/m)	LIMIT (dBuV/m)	MARGIN (dB)	ANTENNA HEIGHT (m)	TABLE ANGLE (Degree)	RAW VALUE (dBuV)	CORRECTION FACTOR (dB/m)
1	*5200.00	101.9 PK			1.00 H	217	61.80	40.10
2	*5200.00	90.8 AV			1.00 H	217	50.70	40.10
3	#10400.00	58.5 PK	74.0	-15.5	1.25 H	44	43.50	15.00
4	#10400.00	46.2 AV	54.0	-7.8	1.25 H	44	31.20	15.00

ANTENNA POLARITY & TEST DISTANCE: VERTICAL AT 3 M

NO.	FREQ. (MHz)	EMISSION LEVEL (dBuV/m)	LIMIT (dBuV/m)	MARGIN (dB)	ANTENNA HEIGHT (m)	TABLE ANGLE (Degree)	RAW VALUE (dBuV)	CORRECTION FACTOR (dB/m)
1	*5200.00	101.1 PK			1.83 V	233	61.00	40.10
2	*5200.00	90.2 AV			1.83 V	233	50.10	40.10
3	#10400.00	60.2 PK	74.0	-13.8	1.24 V	7	45.20	15.00
4	#10400.00	47.2 AV	54.0	-6.8	1.24 V	7	32.20	15.00

REMARKS:

1. Emission Level(dBuV/m) = Raw Value(dBuV) + Correction Factor(dB/m)
2. Correction Factor(dB/m) = Antenna Factor(dB/m) + Cable Factor(dB) – Pre-Amplifier Factor(dB)
3. The other emission levels were very low against the limit.
4. Margin value = Emission Level – Limit value
5. " * ": Fundamental frequency.
6. " # ": The radiated frequency is out of the restricted band.

CHANNEL	TX Channel 48	DETECTOR FUNCTION	Peak (PK)
FREQUENCY RANGE	1GHz ~ 40GHz		Average (AV)

ANTENNA POLARITY & TEST DISTANCE: HORIZONTAL AT 3 M

NO.	FREQ. (MHz)	EMISSION LEVEL (dBuV/m)	LIMIT (dBuV/m)	MARGIN (dB)	ANTENNA HEIGHT (m)	TABLE ANGLE (Degree)	RAW VALUE (dBuV)	CORRECTION FACTOR (dB/m)
1	*5240.00	106.2 PK			1.00 H	216	66.10	40.10
2	*5240.00	95.1 AV			1.00 H	216	55.00	40.10
3	5350.00	57.0 PK	74.0	-17.0	1.96 H	48	55.00	2.00
4	5350.00	43.2 AV	54.0	-10.8	1.96 H	48	41.20	2.00
5	#10480.00	59.4 PK	74.0	-14.6	1.05 H	241	44.30	15.10
6	#10480.00	46.3 AV	54.0	-7.7	1.05 H	241	31.20	15.10

ANTENNA POLARITY & TEST DISTANCE: VERTICAL AT 3 M

NO.	FREQ. (MHz)	EMISSION LEVEL (dBuV/m)	LIMIT (dBuV/m)	MARGIN (dB)	ANTENNA HEIGHT (m)	TABLE ANGLE (Degree)	RAW VALUE (dBuV)	CORRECTION FACTOR (dB/m)
1	*5240.00	103.9 PK			1.00 V	121	63.80	40.10
2	*5240.00	92.7 AV			1.00 V	121	52.60	40.10
3	5350.00	55.7 PK	74.0	-18.3	1.00 V	121	53.70	2.00
4	5350.00	42.7 AV	54.0	-11.3	1.00 V	121	40.70	2.00
5	#10480.00	59.7 PK	74.0	-14.3	1.27 V	54	44.60	15.10
6	#10480.00	48.4 AV	54.0	-5.6	1.27 V	54	33.30	15.10

REMARKS:

1. Emission Level(dBuV/m) = Raw Value(dBuV) + Correction Factor(dB/m)
2. Correction Factor(dB/m) = Antenna Factor(dB/m) + Cable Factor(dB) – Pre-Amplifier Factor(dB)
3. The other emission levels were very low against the limit.
4. Margin value = Emission Level – Limit value
5. " * ": Fundamental frequency.
6. " # ": The radiated frequency is out of the restricted band.

CHANNEL	TX Channel 52	DETECTOR FUNCTION	Peak (PK)
FREQUENCY RANGE	1GHz ~ 40GHz		Average (AV)

ANTENNA POLARITY & TEST DISTANCE: HORIZONTAL AT 3 M

NO.	FREQ. (MHz)	EMISSION LEVEL (dBuV/m)	LIMIT (dBuV/m)	MARGIN (dB)	ANTENNA HEIGHT (m)	TABLE ANGLE (Degree)	RAW VALUE (dBuV)	CORRECTION FACTOR (dB/m)
1	5150.00	55.7 PK	74.0	-18.3	1.26 H	64	53.70	2.00
2	5150.00	43.2 AV	54.0	-10.8	1.26 H	64	41.20	2.00
3	*5260.00	99.4 PK			1.00 H	203	59.30	40.10
4	*5260.00	88.4 AV			1.00 H	203	48.30	40.10
5	#10520.00	58.8 PK	74.0	-15.2	1.15 H	245	43.50	15.30
6	#10520.00	45.6 AV	54.0	-8.4	1.15 H	245	30.30	15.30

ANTENNA POLARITY & TEST DISTANCE: VERTICAL AT 3 M

NO.	FREQ. (MHz)	EMISSION LEVEL (dBuV/m)	LIMIT (dBuV/m)	MARGIN (dB)	ANTENNA HEIGHT (m)	TABLE ANGLE (Degree)	RAW VALUE (dBuV)	CORRECTION FACTOR (dB/m)
1	5150.00	56.6 PK	74.0	-17.4	1.54 V	99	54.60	2.00
2	5150.00	43.3 AV	54.0	-10.7	1.54 V	99	41.30	2.00
3	*5260.00	98.2 PK			1.21 V	103	58.10	40.10
4	*5260.00	87.5 AV			1.21 V	103	47.40	40.10
5	#10520.00	59.9 PK	74.0	-14.1	1.47 V	59	44.60	15.30
6	#10520.00	45.6 AV	54.0	-8.4	1.47 V	59	30.30	15.30

REMARKS:

1. Emission Level(dBuV/m) = Raw Value(dBuV) + Correction Factor(dB/m)
2. Correction Factor(dB/m) = Antenna Factor(dB/m) + Cable Factor(dB) – Pre-Amplifier Factor(dB)
3. The other emission levels were very low against the limit.
4. Margin value = Emission Level – Limit value
5. " * ": Fundamental frequency.
6. " # ": The radiated frequency is out of the restricted band.

CHANNEL	TX Channel 60	DETECTOR FUNCTION	Peak (PK)
FREQUENCY RANGE	1GHz ~ 40GHz		Average (AV)

ANTENNA POLARITY & TEST DISTANCE: HORIZONTAL AT 3 M

NO.	FREQ. (MHz)	EMISSION LEVEL (dBuV/m)	LIMIT (dBuV/m)	MARGIN (dB)	ANTENNA HEIGHT (m)	TABLE ANGLE (Degree)	RAW VALUE (dBuV)	CORRECTION FACTOR (dB/m)
1	*5300.00	100.4 PK			1.00 H	219	60.30	40.10
2	*5300.00	89.7 AV			1.00 H	219	49.60	40.10
3	10600.00	61.5 PK	74.0	-12.5	1.25 H	66	45.30	16.20
4	10600.00	48.7 AV	54.0	-5.3	1.25 H	66	32.50	16.20

ANTENNA POLARITY & TEST DISTANCE: VERTICAL AT 3 M

NO.	FREQ. (MHz)	EMISSION LEVEL (dBuV/m)	LIMIT (dBuV/m)	MARGIN (dB)	ANTENNA HEIGHT (m)	TABLE ANGLE (Degree)	RAW VALUE (dBuV)	CORRECTION FACTOR (dB/m)
1	*5300.00	97.8 PK			1.00 V	121	57.70	40.10
2	*5300.00	87.1 AV			1.00 V	121	47.00	40.10
3	10600.00	60.8 PK	74.0	-13.2	1.32 V	69	44.60	16.20
4	10600.00	47.5 AV	54.0	-6.5	1.32 V	69	31.30	16.20

REMARKS:

1. Emission Level(dBuV/m) = Raw Value(dBuV) + Correction Factor(dB/m)
2. Correction Factor(dB/m) = Antenna Factor(dB/m) + Cable Factor(dB) – Pre-Amplifier Factor(dB)
3. The other emission levels were very low against the limit.
4. Margin value = Emission Level – Limit value
5. " * ": Fundamental frequency.



CHANNEL	TX Channel 64	DETECTOR FUNCTION	Peak (PK)
FREQUENCY RANGE	1GHz ~ 40GHz		Average (AV)

ANTENNA POLARITY & TEST DISTANCE: HORIZONTAL AT 3 M

NO.	FREQ. (MHz)	EMISSION LEVEL (dBuV/m)	LIMIT (dBuV/m)	MARGIN (dB)	ANTENNA HEIGHT (m)	TABLE ANGLE (Degree)	RAW VALUE (dBuV)	CORRECTION FACTOR (dB/m)
1	*5320.00	99.3 PK			1.51 H	217	59.10	40.20
2	*5320.00	88.2 AV			1.51 H	217	48.00	40.20
3	5350.00	56.5 PK	74.0	-17.5	1.51 H	217	54.50	2.00
4	5350.00	43.6 AV	54.0	-10.4	1.51 H	217	41.60	2.00
5	10640.00	61.0 PK	74.0	-13.0	1.96 H	335	44.70	16.30
6	10640.00	47.6 AV	54.0	-6.4	1.96 H	335	31.30	16.30

ANTENNA POLARITY & TEST DISTANCE: VERTICAL AT 3 M

NO.	FREQ. (MHz)	EMISSION LEVEL (dBuV/m)	LIMIT (dBuV/m)	MARGIN (dB)	ANTENNA HEIGHT (m)	TABLE ANGLE (Degree)	RAW VALUE (dBuV)	CORRECTION FACTOR (dB/m)
1	*5320.00	96.7 PK			1.27 V	130	56.50	40.20
2	*5320.00	86.1 AV			1.27 V	130	45.90	40.20
3	5350.00	56.6 PK	74.0	-17.4	1.41 V	115	54.60	2.00
4	5350.00	43.2 AV	54.0	-10.8	1.41 V	115	41.20	2.00
5	10640.00	62.0 PK	74.0	-12.0	1.52 V	66	45.70	16.30
6	10640.00	47.5 AV	54.0	-6.5	1.52 V	66	31.20	16.30

REMARKS:

1. Emission Level(dBuV/m) = Raw Value(dBuV) + Correction Factor(dB/m)
2. Correction Factor(dB/m) = Antenna Factor(dB/m) + Cable Factor(dB)
– Pre-Amplifier Factor(dB)
3. The other emission levels were very low against the limit.
4. Margin value = Emission Level – Limit value
5. " * ": Fundamental frequency.
6. " # ": The radiated frequency is out of the restricted band.



CHANNEL	TX Channel 100	DETECTOR FUNCTION	Peak (PK)
FREQUENCY RANGE	1GHz ~ 40GHz		Average (AV)

ANTENNA POLARITY & TEST DISTANCE: HORIZONTAL AT 3 M

NO.	FREQ. (MHz)	EMISSION LEVEL (dBuV/m)	LIMIT (dBuV/m)	MARGIN (dB)	ANTENNA HEIGHT (m)	TABLE ANGLE (Degree)	RAW VALUE (dBuV)	CORRECTION FACTOR (dB/m)
1	5460.00	56.7 PK	74.0	-17.3	1.01 H	208	54.60	2.10
2	5460.00	43.7 AV	54.0	-10.3	1.01 H	208	41.60	2.10
3	#5470.00	56.5 PK	74.0	-17.5	1.01 H	208	54.30	2.20
4	#5470.00	43.2 AV	54.0	-10.8	1.01 H	208	41.00	2.20
5	*5500.00	99.3 PK			1.01 H	208	59.00	40.30
6	*5500.00	88.6 AV			1.01 H	208	48.30	40.30
7	11000.00	62.4 PK	74.0	-11.6	1.57 H	88	44.70	17.70
8	11000.00	48.9 AV	54.0	-5.1	1.57 H	88	31.20	17.70

ANTENNA POLARITY & TEST DISTANCE: VERTICAL AT 3 M

NO.	FREQ. (MHz)	EMISSION LEVEL (dBuV/m)	LIMIT (dBuV/m)	MARGIN (dB)	ANTENNA HEIGHT (m)	TABLE ANGLE (Degree)	RAW VALUE (dBuV)	CORRECTION FACTOR (dB/m)
1	5460.00	55.8 PK	74.0	-18.2	1.70 V	234	53.70	2.10
2	5460.00	43.3 AV	54.0	-10.7	1.70 V	234	41.20	2.10
3	#5470.00	56.8 PK	74.0	-17.2	1.69 V	234	54.60	2.20
4	#5470.00	44.1 AV	54.0	-9.9	1.69 V	234	41.90	2.20
5	*5500.00	98.8 PK			1.70 V	234	58.50	40.30
6	*5500.00	88.1 AV			1.70 V	234	47.80	40.30
7	11000.00	61.3 PK	74.0	-12.7	1.42 V	55	43.60	17.70
8	11000.00	48.9 AV	54.0	-5.1	1.42 V	55	31.20	17.70

REMARKS:

1. Emission Level(dBuV/m) = Raw Value(dBuV) + Correction Factor(dB/m)
2. Correction Factor(dB/m) = Antenna Factor(dB/m) + Cable Factor(dB)
– Pre-Amplifier Factor(dB)
3. The other emission levels were very low against the limit.
4. Margin value = Emission Level – Limit value
5. " * ": Fundamental frequency.
6. " # ": The radiated frequency is out of the restricted band.

CHANNEL	TX Channel 116	DETECTOR FUNCTION	Peak (PK)
FREQUENCY RANGE	1GHz ~ 40GHz		Average (AV)

ANTENNA POLARITY & TEST DISTANCE: HORIZONTAL AT 3 M

NO.	FREQ. (MHz)	EMISSION LEVEL (dBuV/m)	LIMIT (dBuV/m)	MARGIN (dB)	ANTENNA HEIGHT (m)	TABLE ANGLE (Degree)	RAW VALUE (dBuV)	CORRECTION FACTOR (dB/m)
1	*5580.00	103.4 PK			1.00 H	210	62.90	40.50
2	*5580.00	93.3 AV			1.00 H	210	52.80	40.50
3	11160.00	61.0 PK	74.0	-13.0	1.63 H	99	44.60	16.40
4	11160.00	47.6 AV	54.0	-6.4	1.63 H	99	31.20	16.40

ANTENNA POLARITY & TEST DISTANCE: VERTICAL AT 3 M

NO.	FREQ. (MHz)	EMISSION LEVEL (dBuV/m)	LIMIT (dBuV/m)	MARGIN (dB)	ANTENNA HEIGHT (m)	TABLE ANGLE (Degree)	RAW VALUE (dBuV)	CORRECTION FACTOR (dB/m)
1	*5580.00	104.1 PK			1.99 V	232	63.60	40.50
2	*5580.00	93.6 AV			1.99 V	232	53.10	40.50
3	11160.00	61.0 PK	74.0	-13.0	1.59 V	258	44.60	16.40
4	11160.00	47.6 AV	54.0	-6.4	1.59 V	258	31.20	16.40

REMARKS:

1. Emission Level(dBuV/m) = Raw Value(dBuV) + Correction Factor(dB/m)
2. Correction Factor(dB/m) = Antenna Factor(dB/m) + Cable Factor(dB) – Pre-Amplifier Factor(dB)
3. The other emission levels were very low against the limit.
4. Margin value = Emission Level – Limit value
5. " * " : Fundamental frequency.



CHANNEL	TX Channel 140	DETECTOR FUNCTION	Peak (PK)
FREQUENCY RANGE	1GHz ~ 40GHz		Average (AV)

ANTENNA POLARITY & TEST DISTANCE: HORIZONTAL AT 3 M

NO.	FREQ. (MHz)	EMISSION LEVEL (dBuV/m)	LIMIT (dBuV/m)	MARGIN (dB)	ANTENNA HEIGHT (m)	TABLE ANGLE (Degree)	RAW VALUE (dBuV)	CORRECTION FACTOR (dB/m)
1	*5700.00	101.1 PK			1.60 H	171	60.30	40.80
2	*5700.00	89.7 AV			1.60 H	171	48.90	40.80
3	#5725.00	60.6 PK	74.0	-13.4	1.59 H	172	58.00	2.60
4	#5725.00	47.2 AV	54.0	-6.8	1.59 H	172	44.60	2.60
5	11400.00	61.7 PK	74.0	-12.3	1.84 H	41	45.50	16.20
6	11400.00	48.1 AV	54.0	-5.9	1.84 H	41	31.90	16.20

ANTENNA POLARITY & TEST DISTANCE: VERTICAL AT 3 M

NO.	FREQ. (MHz)	EMISSION LEVEL (dBuV/m)	LIMIT (dBuV/m)	MARGIN (dB)	ANTENNA HEIGHT (m)	TABLE ANGLE (Degree)	RAW VALUE (dBuV)	CORRECTION FACTOR (dB/m)
1	*5700.00	98.2 PK			1.38 V	155	57.40	40.80
2	*5700.00	87.2 AV			1.38 V	155	46.40	40.80
3	#5725.00	57.0 PK	74.0	-17.0	1.38 V	155	54.40	2.60
4	#5725.00	44.9 AV	54.0	-9.1	1.38 V	155	42.30	2.60
5	11400.00	61.8 PK	74.0	-12.2	1.84 V	99	45.60	16.20
6	11400.00	47.5 AV	54.0	-6.5	1.84 V	99	31.30	16.20

REMARKS:

1. Emission Level(dBuV/m) = Raw Value(dBuV) + Correction Factor(dB/m)
2. Correction Factor(dB/m) = Antenna Factor(dB/m) + Cable Factor(dB) – Pre-Amplifier Factor(dB)
3. The other emission levels were very low against the limit.
4. Margin value = Emission Level – Limit value
5. " * ": Fundamental frequency.
6. " # ": The radiated frequency is out of the restricted band.



CHANNEL	TX Channel 149	DETECTOR FUNCTION	Peak (PK)
FREQUENCY RANGE	1GHz ~ 40GHz		Average (AV)

ANTENNA POLARITY & TEST DISTANCE: HORIZONTAL AT 3 M

NO.	FREQ. (MHz)	EMISSION LEVEL (dBuV/m)	LIMIT (dBuV/m)	MARGIN (dB)	ANTENNA HEIGHT (m)	TABLE ANGLE (Degree)	RAW VALUE (dBuV)	CORRECTION FACTOR (dB/m)
1	#5714.90	69.3 PK	74.0	-4.7	1.66 H	215	66.70	2.60
2	#5714.90	47.3 AV	54.0	-6.7	1.66 H	215	44.70	2.60
3	#5722.90	76.7 PK	78.2	-1.5	1.66 H	215	74.10	2.60
4	#5725.00	62.7 PK	78.2	-15.5	1.66 H	215	60.10	2.60
5	*5745.00	104.7 PK			1.66 H	215	63.70	41.00
6	*5745.00	94.2 AV			1.66 H	215	53.20	41.00
7	11490.00	61.6 PK	74.0	-12.4	1.59 H	66	45.70	15.90
8	11490.00	47.4 AV	54.0	-6.6	1.59 H	66	31.50	15.90

ANTENNA POLARITY & TEST DISTANCE: VERTICAL AT 3 M

NO.	FREQ. (MHz)	EMISSION LEVEL (dBuV/m)	LIMIT (dBuV/m)	MARGIN (dB)	ANTENNA HEIGHT (m)	TABLE ANGLE (Degree)	RAW VALUE (dBuV)	CORRECTION FACTOR (dB/m)
1	#5714.90	66.8 PK	74.0	-7.2	1.92 V	237	64.20	2.60
2	#5714.90	45.3 AV	54.0	-8.7	1.92 V	237	42.70	2.60
3	#5722.90	74.8 PK	78.2	-3.4	1.92 V	237	72.20	2.60
4	#5725.00	59.3 PK	78.2	-18.9	1.92 V	237	56.70	2.60
5	*5745.00	103.1 PK			1.92 V	237	62.10	41.00
6	*5745.00	92.5 AV			1.92 V	237	51.50	41.00
7	11490.00	60.4 PK	74.0	-13.6	1.54 V	77	44.50	15.90
8	11490.00	47.1 AV	54.0	-6.9	1.54 V	77	31.20	15.90

REMARKS:

1. Emission Level(dBuV/m) = Raw Value(dBuV) + Correction Factor(dB/m)
2. Correction Factor(dB/m) = Antenna Factor(dB/m) + Cable Factor(dB)
– Pre-Amplifier Factor(dB)
3. The other emission levels were very low against the limit.
4. Margin value = Emission Level – Limit value
5. " * ": Fundamental frequency.
6. " # ": The radiated frequency is out of the restricted band.

CHANNEL	TX Channel 157	DETECTOR FUNCTION	Peak (PK)
FREQUENCY RANGE	1GHz ~ 40GHz		Average (AV)

ANTENNA POLARITY & TEST DISTANCE: HORIZONTAL AT 3 M

NO.	FREQ. (MHz)	EMISSION LEVEL (dBuV/m)	LIMIT (dBuV/m)	MARGIN (dB)	ANTENNA HEIGHT (m)	TABLE ANGLE (Degree)	RAW VALUE (dBuV)	CORRECTION FACTOR (dB/m)
1	*5785.00	104.9 PK			1.56 H	217	63.80	41.10
2	*5785.00	94.3 AV			1.56 H	217	53.20	41.10
3	11570.00	61.3 PK	74.0	-12.7	1.96 H	65	45.70	15.60
4	11570.00	48.2 AV	54.0	-5.8	1.96 H	65	32.60	15.60

ANTENNA POLARITY & TEST DISTANCE: VERTICAL AT 3 M

NO.	FREQ. (MHz)	EMISSION LEVEL (dBuV/m)	LIMIT (dBuV/m)	MARGIN (dB)	ANTENNA HEIGHT (m)	TABLE ANGLE (Degree)	RAW VALUE (dBuV)	CORRECTION FACTOR (dB/m)
1	*5785.00	102.5 PK			1.84 V	238	61.40	41.10
2	*5785.00	92.1 AV			1.84 V	238	51.00	41.10
3	11570.00	60.6 PK	74.0	-13.4	1.25 V	65	45.00	15.60
4	11570.00	47.1 AV	54.0	-6.9	1.25 V	65	31.50	15.60

REMARKS:

1. Emission Level(dBuV/m) = Raw Value(dBuV) + Correction Factor(dB/m)
2. Correction Factor(dB/m) = Antenna Factor(dB/m) + Cable Factor(dB) – Pre-Amplifier Factor(dB)
3. The other emission levels were very low against the limit.
4. Margin value = Emission Level – Limit value
5. " * " : Fundamental frequency.



CHANNEL	TX Channel 165	DETECTOR FUNCTION	Peak (PK)
FREQUENCY RANGE	1GHz ~ 40GHz		Average (AV)

ANTENNA POLARITY & TEST DISTANCE: HORIZONTAL AT 3 M

NO.	FREQ. (MHz)	EMISSION LEVEL (dBuV/m)	LIMIT (dBuV/m)	MARGIN (dB)	ANTENNA HEIGHT (m)	TABLE ANGLE (Degree)	RAW VALUE (dBuV)	CORRECTION FACTOR (dB/m)
1	*5825.00	100.9 PK			1.03 H	203	59.80	41.10
2	*5825.00	90.5 AV			1.03 H	203	49.40	41.10
3	#5850.00	47.3 PK	78.2	-30.9	1.03 H	203	44.30	3.00
4	#5852.10	60.3 PK	78.2	-17.9	1.03 H	203	57.30	3.00
5	#5860.10	56.7 PK	74.0	-17.3	1.03 H	203	53.70	3.00
6	#5860.10	44.0 AV	54.0	-10.0	1.03 H	203	41.00	3.00
7	11650.00	60.2 PK	74.0	-13.8	1.54 H	88	44.60	15.60
8	11650.00	46.9 AV	54.0	-7.1	1.54 H	88	31.30	15.60

ANTENNA POLARITY & TEST DISTANCE: VERTICAL AT 3 M

NO.	FREQ. (MHz)	EMISSION LEVEL (dBuV/m)	LIMIT (dBuV/m)	MARGIN (dB)	ANTENNA HEIGHT (m)	TABLE ANGLE (Degree)	RAW VALUE (dBuV)	CORRECTION FACTOR (dB/m)
1	*5825.00	97.7 PK			2.43 V	314	56.60	41.10
2	*5825.00	86.6 AV			2.43 V	314	45.50	41.10
3	#5850.00	47.0 PK	78.2	-31.2	2.43 V	314	44.00	3.00
4	#5852.10	56.8 PK	78.2	-21.4	2.43 V	314	53.80	3.00
5	#5860.10	57.6 PK	74.0	-16.4	2.43 V	314	54.60	3.00
6	#5860.10	43.5 AV	54.0	-10.5	2.43 V	314	40.50	3.00
7	11650.00	60.8 PK	74.0	-13.2	1.84 V	99	45.20	15.60
8	11650.00	47.2 AV	54.0	-6.8	1.84 V	99	31.60	15.60

REMARKS:

- Emission Level(dBuV/m) = Raw Value(dBuV) + Correction Factor(dB/m)
- Correction Factor(dB/m) = Antenna Factor(dB/m) + Cable Factor(dB)
– Pre-Amplifier Factor(dB)
- The other emission levels were very low against the limit.
- Margin value = Emission Level – Limit value
- " * ": Fundamental frequency.
- " # ": The radiated frequency is out of the restricted band.

802.11n (HT20)

CHANNEL	TX Channel 36	DETECTOR FUNCTION	Peak (PK)
FREQUENCY RANGE	1GHz ~ 40GHz		Average (AV)

ANTENNA POLARITY & TEST DISTANCE: HORIZONTAL AT 3 M

NO.	FREQ. (MHz)	EMISSION LEVEL (dBuV/m)	LIMIT (dBuV/m)	MARGIN (dB)	ANTENNA HEIGHT (m)	TABLE ANGLE (Degree)	RAW VALUE (dBuV)	CORRECTION FACTOR (dB/m)
1	5150.00	56.6 PK	74.0	-17.4	1.63 H	95	54.60	2.00
2	5150.00	43.4 AV	54.0	-10.6	1.63 H	95	41.40	2.00
3	*5180.00	100.1 PK			1.27 H	84	60.10	40.00
4	*5180.00	89.1 AV			1.27 H	84	49.10	40.00
5	#10360.00	58.9 PK	74.0	-15.1	1.20 H	55	43.90	15.00
6	#10360.00	46.3 AV	54.0	-7.7	1.20 H	55	31.30	15.00

ANTENNA POLARITY & TEST DISTANCE: VERTICAL AT 3 M

NO.	FREQ. (MHz)	EMISSION LEVEL (dBuV/m)	LIMIT (dBuV/m)	MARGIN (dB)	ANTENNA HEIGHT (m)	TABLE ANGLE (Degree)	RAW VALUE (dBuV)	CORRECTION FACTOR (dB/m)
1	5150.00	55.7 PK	74.0	-18.3	1.26 V	66	53.70	2.00
2	5150.00	42.7 AV	54.0	-11.3	1.26 V	66	40.70	2.00
3	*5180.00	101.0 PK			1.57 V	44	61.00	40.00
4	*5180.00	89.8 AV			1.57 V	44	49.80	40.00
5	#10360.00	59.6 PK	74.0	-14.4	1.85 V	75	44.60	15.00
6	#10360.00	45.7 AV	54.0	-8.3	1.85 V	75	30.70	15.00

REMARKS:

1. Emission Level(dBuV/m) = Raw Value(dBuV) + Correction Factor(dB/m)
2. Correction Factor(dB/m) = Antenna Factor(dB/m) + Cable Factor(dB) – Pre-Amplifier Factor(dB)
3. The other emission levels were very low against the limit.
4. Margin value = Emission Level – Limit value
5. " * ": Fundamental frequency.
6. " # ": The radiated frequency is out of the restricted band.

CHANNEL	TX Channel 40	DETECTOR FUNCTION	Peak (PK)
FREQUENCY RANGE	1GHz ~ 40GHz		Average (AV)

ANTENNA POLARITY & TEST DISTANCE: HORIZONTAL AT 3 M

NO.	FREQ. (MHz)	EMISSION LEVEL (dBuV/m)	LIMIT (dBuV/m)	MARGIN (dB)	ANTENNA HEIGHT (m)	TABLE ANGLE (Degree)	RAW VALUE (dBuV)	CORRECTION FACTOR (dB/m)
1	*5200.00	101.5 PK			1.58 H	44	61.40	40.10
2	*5200.00	90.4 AV			1.58 H	44	50.30	40.10
3	#10400.00	60.2 PK	74.0	-13.8	1.85 H	54	45.20	15.00
4	#10400.00	46.5 AV	54.0	-7.5	1.85 H	54	31.50	15.00

ANTENNA POLARITY & TEST DISTANCE: VERTICAL AT 3 M

NO.	FREQ. (MHz)	EMISSION LEVEL (dBuV/m)	LIMIT (dBuV/m)	MARGIN (dB)	ANTENNA HEIGHT (m)	TABLE ANGLE (Degree)	RAW VALUE (dBuV)	CORRECTION FACTOR (dB/m)
1	*5200.00	100.8 PK			1.35 V	96	60.70	40.10
2	*5200.00	89.8 AV			1.35 V	96	49.70	40.10
3	#10400.00	58.6 PK	74.0	-15.4	1.45 V	225	43.60	15.00
4	#10400.00	45.8 AV	54.0	-8.2	1.45 V	225	30.80	15.00

REMARKS:

1. Emission Level(dBuV/m) = Raw Value(dBuV) + Correction Factor(dB/m)
2. Correction Factor(dB/m) = Antenna Factor(dB/m) + Cable Factor(dB) – Pre-Amplifier Factor(dB)
3. The other emission levels were very low against the limit.
4. Margin value = Emission Level – Limit value
5. " * ": Fundamental frequency.
6. " # ": The radiated frequency is out of the restricted band.

CHANNEL	TX Channel 48	DETECTOR FUNCTION	Peak (PK)
FREQUENCY RANGE	1GHz ~ 40GHz		Average (AV)

ANTENNA POLARITY & TEST DISTANCE: HORIZONTAL AT 3 M

NO.	FREQ. (MHz)	EMISSION LEVEL (dBuV/m)	LIMIT (dBuV/m)	MARGIN (dB)	ANTENNA HEIGHT (m)	TABLE ANGLE (Degree)	RAW VALUE (dBuV)	CORRECTION FACTOR (dB/m)
1	*5240.00	105.8 PK			1.48 H	96	65.70	40.10
2	*5240.00	94.6 AV			1.48 H	96	54.50	40.10
3	5350.00	56.6 PK	74.0	-17.4	1.54 H	87	54.60	2.00
4	5350.00	43.2 AV	54.0	-10.8	1.54 H	87	41.20	2.00
5	#10480.00	59.9 PK	74.0	-14.1	1.15 H	347	44.80	15.10
6	#10480.00	46.3 AV	54.0	-7.7	1.15 H	347	31.20	15.10

ANTENNA POLARITY & TEST DISTANCE: VERTICAL AT 3 M

NO.	FREQ. (MHz)	EMISSION LEVEL (dBuV/m)	LIMIT (dBuV/m)	MARGIN (dB)	ANTENNA HEIGHT (m)	TABLE ANGLE (Degree)	RAW VALUE (dBuV)	CORRECTION FACTOR (dB/m)
1	*5240.00	103.5 PK			1.96 V	64	63.40	40.10
2	*5240.00	92.2 AV			1.96 V	64	52.10	40.10
3	5350.00	56.5 PK	74.0	-17.5	1.87 V	41	54.50	2.00
4	5350.00	43.1 AV	54.0	-10.9	1.87 V	41	41.10	2.00
5	#10480.00	58.8 PK	74.0	-15.2	1.57 V	66	43.70	15.10
6	#10480.00	45.5 AV	54.0	-8.5	1.57 V	66	30.40	15.10

REMARKS:

1. Emission Level(dBuV/m) = Raw Value(dBuV) + Correction Factor(dB/m)
2. Correction Factor(dB/m) = Antenna Factor(dB/m) + Cable Factor(dB) – Pre-Amplifier Factor(dB)
3. The other emission levels were very low against the limit.
4. Margin value = Emission Level – Limit value
5. " * ": Fundamental frequency.
6. " # ": The radiated frequency is out of the restricted band.



CHANNEL	TX Channel 52	DETECTOR FUNCTION	Peak (PK)
FREQUENCY RANGE	1GHz ~ 40GHz		Average (AV)

ANTENNA POLARITY & TEST DISTANCE: HORIZONTAL AT 3 M

NO.	FREQ. (MHz)	EMISSION LEVEL (dBuV/m)	LIMIT (dBuV/m)	MARGIN (dB)	ANTENNA HEIGHT (m)	TABLE ANGLE (Degree)	RAW VALUE (dBuV)	CORRECTION FACTOR (dB/m)
1	5150.00	56.9 PK	74.0	-17.1	1.54 H	99	54.90	2.00
2	5150.00	44.5 AV	54.0	-9.5	1.54 H	99	42.50	2.00
3	*5260.00	100.3 PK			1.52 H	44	60.20	40.10
4	*5260.00	89.0 AV			1.52 H	44	48.90	40.10
5	#10520.00	61.0 PK	74.0	-13.0	1.45 H	99	45.70	15.30
6	#10520.00	46.9 AV	54.0	-7.1	1.45 H	99	31.60	15.30

ANTENNA POLARITY & TEST DISTANCE: VERTICAL AT 3 M

NO.	FREQ. (MHz)	EMISSION LEVEL (dBuV/m)	LIMIT (dBuV/m)	MARGIN (dB)	ANTENNA HEIGHT (m)	TABLE ANGLE (Degree)	RAW VALUE (dBuV)	CORRECTION FACTOR (dB/m)
1	5150.00	55.9 PK	74.0	-18.1	1.75 V	84	53.90	2.00
2	5150.00	42.9 AV	54.0	-11.1	1.75 V	84	40.90	2.00
3	*5260.00	98.7 PK			1.35 V	229	58.60	40.10
4	*5260.00	88.0 AV			1.35 V	229	47.90	40.10
5	#10520.00	59.0 PK	74.0	-15.0	1.00 V	265	43.70	15.30
6	#10520.00	45.7 AV	54.0	-8.3	1.00 V	265	30.40	15.30

REMARKS:

1. Emission Level(dBuV/m) = Raw Value(dBuV) + Correction Factor(dB/m)
2. Correction Factor(dB/m) = Antenna Factor(dB/m) + Cable Factor(dB) – Pre-Amplifier Factor(dB)
3. The other emission levels were very low against the limit.
4. Margin value = Emission Level – Limit value
5. " * ": Fundamental frequency.
6. " # ": The radiated frequency is out of the restricted band.

CHANNEL	TX Channel 60	DETECTOR FUNCTION	Peak (PK)
FREQUENCY RANGE	1GHz ~ 40GHz		Average (AV)

ANTENNA POLARITY & TEST DISTANCE: HORIZONTAL AT 3 M

NO.	FREQ. (MHz)	EMISSION LEVEL (dBuV/m)	LIMIT (dBuV/m)	MARGIN (dB)	ANTENNA HEIGHT (m)	TABLE ANGLE (Degree)	RAW VALUE (dBuV)	CORRECTION FACTOR (dB/m)
1	*5300.00	100.5 PK			1.87 H	55	60.40	40.10
2	*5300.00	90.1 AV			1.87 H	55	50.00	40.10
3	10600.00	61.6 PK	74.0	-12.4	2.05 H	85	45.40	16.20
4	10600.00	48.9 AV	54.0	-5.1	2.05 H	85	32.70	16.20

ANTENNA POLARITY & TEST DISTANCE: VERTICAL AT 3 M

NO.	FREQ. (MHz)	EMISSION LEVEL (dBuV/m)	LIMIT (dBuV/m)	MARGIN (dB)	ANTENNA HEIGHT (m)	TABLE ANGLE (Degree)	RAW VALUE (dBuV)	CORRECTION FACTOR (dB/m)
1	*5300.00	98.1 PK			1.95 V	234	58.00	40.10
2	*5300.00	87.4 AV			1.95 V	234	47.30	40.10
3	10600.00	59.8 PK	74.0	-14.2	1.24 V	350	43.60	16.20
4	10600.00	47.7 AV	54.0	-6.3	1.24 V	350	31.50	16.20

REMARKS:

1. Emission Level(dBuV/m) = Raw Value(dBuV) + Correction Factor(dB/m)
2. Correction Factor(dB/m) = Antenna Factor(dB/m) + Cable Factor(dB) – Pre-Amplifier Factor(dB)
3. The other emission levels were very low against the limit.
4. Margin value = Emission Level – Limit value
5. " * ": Fundamental frequency.

CHANNEL	TX Channel 64	DETECTOR FUNCTION	Peak (PK)
FREQUENCY RANGE	1GHz ~ 40GHz		Average (AV)

ANTENNA POLARITY & TEST DISTANCE: HORIZONTAL AT 3 M

NO.	FREQ. (MHz)	EMISSION LEVEL (dBuV/m)	LIMIT (dBuV/m)	MARGIN (dB)	ANTENNA HEIGHT (m)	TABLE ANGLE (Degree)	RAW VALUE (dBuV)	CORRECTION FACTOR (dB/m)
1	*5320.00	100.0 PK			1.51 H	44	59.80	40.20
2	*5320.00	88.5 AV			1.51 H	44	48.30	40.20
3	5350.00	57.3 PK	74.0	-16.7	1.94 H	274	55.30	2.00
4	5350.00	44.5 AV	54.0	-9.5	1.94 H	274	42.50	2.00
5	10640.00	61.9 PK	74.0	-12.1	1.27 H	88	45.60	16.30
6	10640.00	48.1 AV	54.0	-5.9	1.27 H	88	31.80	16.30

ANTENNA POLARITY & TEST DISTANCE: VERTICAL AT 3 M

NO.	FREQ. (MHz)	EMISSION LEVEL (dBuV/m)	LIMIT (dBuV/m)	MARGIN (dB)	ANTENNA HEIGHT (m)	TABLE ANGLE (Degree)	RAW VALUE (dBuV)	CORRECTION FACTOR (dB/m)
1	*5320.00	97.2 PK			1.96 V	57	57.00	40.20
2	*5320.00	86.7 AV			1.96 V	57	46.50	40.20
3	5350.00	57.6 PK	74.0	-16.4	1.58 V	124	55.60	2.00
4	5350.00	43.8 AV	54.0	-10.2	1.58 V	124	41.80	2.00
5	10640.00	59.8 PK	74.0	-14.2	1.00 V	141	43.50	16.30
6	10640.00	46.9 AV	54.0	-7.1	1.00 V	141	30.60	16.30

REMARKS:

1. Emission Level(dBuV/m) = Raw Value(dBuV) + Correction Factor(dB/m)
2. Correction Factor(dB/m) = Antenna Factor(dB/m) + Cable Factor(dB) – Pre-Amplifier Factor(dB)
3. The other emission levels were very low against the limit.
4. Margin value = Emission Level – Limit value
5. " * ": Fundamental frequency.



CHANNEL	TX Channel 100	DETECTOR FUNCTION	Peak (PK)
FREQUENCY RANGE	1GHz ~ 40GHz		Average (AV)

ANTENNA POLARITY & TEST DISTANCE: HORIZONTAL AT 3 M

NO.	FREQ. (MHz)	EMISSION LEVEL (dBuV/m)	LIMIT (dBuV/m)	MARGIN (dB)	ANTENNA HEIGHT (m)	TABLE ANGLE (Degree)	RAW VALUE (dBuV)	CORRECTION FACTOR (dB/m)
1	5460.00	57.2 PK	74.0	-16.8	1.59 H	99	55.10	2.10
2	5460.00	44.2 AV	54.0	-9.8	1.59 H	99	42.10	2.10
3	#5470.00	57.3 PK	74.0	-16.7	1.52 H	99	55.10	2.20
4	#5470.00	43.9 AV	54.0	-10.1	1.52 H	99	41.70	2.20
5	*5500.00	99.8 PK			1.24 H	77	59.50	40.30
6	*5500.00	89.2 AV			1.24 H	77	48.90	40.30
7	11000.00	63.1 PK	74.0	-10.9	1.84 H	234	45.40	17.70
8	11000.00	49.2 AV	54.0	-4.8	1.84 H	234	31.50	17.70

ANTENNA POLARITY & TEST DISTANCE: VERTICAL AT 3 M

NO.	FREQ. (MHz)	EMISSION LEVEL (dBuV/m)	LIMIT (dBuV/m)	MARGIN (dB)	ANTENNA HEIGHT (m)	TABLE ANGLE (Degree)	RAW VALUE (dBuV)	CORRECTION FACTOR (dB/m)
1	5460.00	56.2 PK	74.0	-17.8	1.74 V	84	54.10	2.10
2	5460.00	43.8 AV	54.0	-10.2	1.74 V	84	41.70	2.10
3	#5470.00	57.3 PK	74.0	-16.7	1.89 V	254	55.10	2.20
4	#5470.00	44.5 AV	54.0	-9.5	1.89 V	254	42.30	2.20
5	*5500.00	99.6 PK			1.47 V	352	59.30	40.30
6	*5500.00	88.5 AV			1.47 V	352	48.20	40.30
7	11000.00	63.0 PK	74.0	-11.0	1.54 V	210	45.30	17.70
8	11000.00	49.1 AV	54.0	-4.9	1.54 V	210	31.40	17.70

REMARKS:

1. Emission Level(dBuV/m) = Raw Value(dBuV) + Correction Factor(dB/m)
2. Correction Factor(dB/m) = Antenna Factor(dB/m) + Cable Factor(dB)
– Pre-Amplifier Factor(dB)
3. The other emission levels were very low against the limit.
4. Margin value = Emission Level – Limit value
5. " * ": Fundamental frequency.
6. " # ": The radiated frequency is out of the restricted band.

CHANNEL	TX Channel 116	DETECTOR FUNCTION	Peak (PK)
FREQUENCY RANGE	1GHz ~ 40GHz		Average (AV)

ANTENNA POLARITY & TEST DISTANCE: HORIZONTAL AT 3 M

NO.	FREQ. (MHz)	EMISSION LEVEL (dBuV/m)	LIMIT (dBuV/m)	MARGIN (dB)	ANTENNA HEIGHT (m)	TABLE ANGLE (Degree)	RAW VALUE (dBuV)	CORRECTION FACTOR (dB/m)
1	*5580.00	103.2 PK			1.69 H	258	62.70	40.50
2	*5580.00	93.0 AV			1.69 H	258	52.50	40.50
3	11160.00	61.1 PK	74.0	-12.9	1.89 H	67	44.70	16.40
4	11160.00	47.8 AV	54.0	-6.2	1.89 H	67	31.40	16.40

ANTENNA POLARITY & TEST DISTANCE: VERTICAL AT 3 M

NO.	FREQ. (MHz)	EMISSION LEVEL (dBuV/m)	LIMIT (dBuV/m)	MARGIN (dB)	ANTENNA HEIGHT (m)	TABLE ANGLE (Degree)	RAW VALUE (dBuV)	CORRECTION FACTOR (dB/m)
1	*5580.00	104.4 PK			1.42 V	66	63.90	40.50
2	*5580.00	93.7 AV			1.42 V	66	53.20	40.50
3	11160.00	61.6 PK	74.0	-12.4	1.42 V	55	45.20	16.40
4	11160.00	48.1 AV	54.0	-5.9	1.42 V	55	31.70	16.40

REMARKS:

1. Emission Level(dBuV/m) = Raw Value(dBuV) + Correction Factor(dB/m)
2. Correction Factor(dB/m) = Antenna Factor(dB/m) + Cable Factor(dB) – Pre-Amplifier Factor(dB)
3. The other emission levels were very low against the limit.
4. Margin value = Emission Level – Limit value
5. " * ": Fundamental frequency.

CHANNEL	TX Channel 140	DETECTOR FUNCTION	Peak (PK)
FREQUENCY RANGE	1GHz ~ 40GHz		Average (AV)

ANTENNA POLARITY & TEST DISTANCE: HORIZONTAL AT 3 M

NO.	FREQ. (MHz)	EMISSION LEVEL (dBuV/m)	LIMIT (dBuV/m)	MARGIN (dB)	ANTENNA HEIGHT (m)	TABLE ANGLE (Degree)	RAW VALUE (dBuV)	CORRECTION FACTOR (dB/m)
1	*5700.00	100.5 PK			1.14 H	284	59.70	40.80
2	*5700.00	89.3 AV			1.14 H	284	48.50	40.80
3	#5725.00	60.1 PK	74.0	-13.9	1.96 H	67	57.50	2.60
4	#5725.00	46.7 AV	54.0	-7.3	1.96 H	67	44.10	2.60
5	11400.00	61.1 PK	74.0	-12.9	1.57 H	44	44.90	16.20
6	11400.00	47.6 AV	54.0	-6.4	1.57 H	44	31.40	16.20

ANTENNA POLARITY & TEST DISTANCE: VERTICAL AT 3 M

NO.	FREQ. (MHz)	EMISSION LEVEL (dBuV/m)	LIMIT (dBuV/m)	MARGIN (dB)	ANTENNA HEIGHT (m)	TABLE ANGLE (Degree)	RAW VALUE (dBuV)	CORRECTION FACTOR (dB/m)
1	*5700.00	97.9 PK			1.63 V	155	57.10	40.80
2	*5700.00	86.8 AV			1.63 V	155	46.00	40.80
3	#5725.00	56.7 PK	74.0	-17.3	1.35 V	187	54.10	2.60
4	#5725.00	44.5 AV	54.0	-9.5	1.35 V	187	41.90	2.60
5	11400.00	60.9 PK	74.0	-13.1	1.20 V	113	44.70	16.20
6	11400.00	47.2 AV	54.0	-6.8	1.20 V	113	31.00	16.20

REMARKS:

1. Emission Level(dBuV/m) = Raw Value(dBuV) + Correction Factor(dB/m)
2. Correction Factor(dB/m) = Antenna Factor(dB/m) + Cable Factor(dB) – Pre-Amplifier Factor(dB)
3. The other emission levels were very low against the limit.
4. Margin value = Emission Level – Limit value
5. " * ": Fundamental frequency.
6. " # ": The radiated frequency is out of the restricted band.

CHANNEL	TX Channel 149	DETECTOR FUNCTION	Peak (PK)
FREQUENCY RANGE	1GHz ~ 40GHz		Average (AV)

ANTENNA POLARITY & TEST DISTANCE: HORIZONTAL AT 3 M

NO.	FREQ. (MHz)	EMISSION LEVEL (dBuV/m)	LIMIT (dBuV/m)	MARGIN (dB)	ANTENNA HEIGHT (m)	TABLE ANGLE (Degree)	RAW VALUE (dBuV)	CORRECTION FACTOR (dB/m)
1	#5714.90	66.2 PK	74.0	-7.8	1.52 H	217	63.60	2.60
2	#5714.90	45.6 AV	54.0	-8.4	1.52 H	217	43.00	2.60
3	#5722.90	77.2 PK	78.2	-1.0	1.52 H	217	74.60	2.60
4	#5725.00	62.1 PK	78.2	-16.1	1.52 H	217	59.50	2.60
5	*5745.00	104.0 PK			1.52 H	217	63.00	41.00
6	*5745.00	93.1 AV			1.52 H	217	52.10	41.00
7	11490.00	60.6 PK	74.0	-13.4	1.54 H	88	44.70	15.90
8	11490.00	47.1 AV	54.0	-6.9	1.54 H	88	31.20	15.90

ANTENNA POLARITY & TEST DISTANCE: VERTICAL AT 3 M

NO.	FREQ. (MHz)	EMISSION LEVEL (dBuV/m)	LIMIT (dBuV/m)	MARGIN (dB)	ANTENNA HEIGHT (m)	TABLE ANGLE (Degree)	RAW VALUE (dBuV)	CORRECTION FACTOR (dB/m)
1	#5714.90	64.7 PK	74.0	-9.3	1.96 V	66	62.10	2.60
2	#5714.90	43.8 AV	54.0	-10.2	1.96 V	66	41.20	2.60
3	#5722.90	74.9 PK	78.2	-3.3	1.54 V	77	72.30	2.60
4	#5725.00	59.8 PK	78.2	-18.4	1.26 V	335	57.20	2.60
5	*5745.00	102.4 PK			1.42 V	333	61.40	41.00
6	*5745.00	91.8 AV			1.42 V	333	50.80	41.00
7	11490.00	60.4 PK	74.0	-13.6	1.57 V	74	44.50	15.90
8	11490.00	47.3 AV	54.0	-6.7	1.57 V	74	31.40	15.90

REMARKS:

1. Emission Level(dBuV/m) = Raw Value(dBuV) + Correction Factor(dB/m)
2. Correction Factor(dB/m) = Antenna Factor(dB/m) + Cable Factor(dB) – Pre-Amplifier Factor(dB)
3. The other emission levels were very low against the limit.
4. Margin value = Emission Level – Limit value
5. " * ": Fundamental frequency.
6. " # ": The radiated frequency is out of the restricted band.

CHANNEL	TX Channel 157	DETECTOR FUNCTION	Peak (PK)
FREQUENCY RANGE	1GHz ~ 40GHz		Average (AV)

ANTENNA POLARITY & TEST DISTANCE: HORIZONTAL AT 3 M

NO.	FREQ. (MHz)	EMISSION LEVEL (dBuV/m)	LIMIT (dBuV/m)	MARGIN (dB)	ANTENNA HEIGHT (m)	TABLE ANGLE (Degree)	RAW VALUE (dBuV)	CORRECTION FACTOR (dB/m)
1	*5785.00	104.5 PK			1.84 H	51	63.40	41.10
2	*5785.00	93.8 AV			1.84 H	51	52.70	41.10
3	11570.00	60.6 PK	74.0	-13.4	1.67 H	159	45.00	15.60
4	11570.00	47.4 AV	54.0	-6.6	1.67 H	159	31.80	15.60

ANTENNA POLARITY & TEST DISTANCE: VERTICAL AT 3 M

NO.	FREQ. (MHz)	EMISSION LEVEL (dBuV/m)	LIMIT (dBuV/m)	MARGIN (dB)	ANTENNA HEIGHT (m)	TABLE ANGLE (Degree)	RAW VALUE (dBuV)	CORRECTION FACTOR (dB/m)
1	*5785.00	102.1 PK			1.78 V	258	61.00	41.10
2	*5785.00	92.0 AV			1.78 V	258	50.90	41.10
3	11570.00	59.5 PK	74.0	-14.5	2.01 V	85	43.90	15.60
4	11570.00	46.5 AV	54.0	-7.5	2.01 V	85	30.90	15.60

REMARKS:

1. Emission Level(dBuV/m) = Raw Value(dBuV) + Correction Factor(dB/m)
2. Correction Factor(dB/m) = Antenna Factor(dB/m) + Cable Factor(dB) – Pre-Amplifier Factor(dB)
3. The other emission levels were very low against the limit.
4. Margin value = Emission Level – Limit value
5. " * ": Fundamental frequency.



CHANNEL	TX Channel 165	DETECTOR FUNCTION	Peak (PK)
FREQUENCY RANGE	1GHz ~ 40GHz		Average (AV)

ANTENNA POLARITY & TEST DISTANCE: HORIZONTAL AT 3 M

NO.	FREQ. (MHz)	EMISSION LEVEL (dBuV/m)	LIMIT (dBuV/m)	MARGIN (dB)	ANTENNA HEIGHT (m)	TABLE ANGLE (Degree)	RAW VALUE (dBuV)	CORRECTION FACTOR (dB/m)
1	*5825.00	100.8 PK			1.06 H	277	59.70	41.10
2	*5825.00	90.2 AV			1.06 H	277	49.10	41.10
3	#5850.00	45.2 PK	78.2	-33.0	1.87 H	44	42.20	3.00
4	#5852.10	59.9 PK	78.2	-18.3	1.46 H	139	56.90	3.00
5	#5860.10	56.6 PK	74.0	-17.4	1.89 H	204	53.60	3.00
6	#5860.10	44.3 AV	54.0	-9.7	1.89 H	204	41.30	3.00
7	11650.00	60.1 PK	74.0	-13.9	1.54 H	144	44.50	15.60
8	11650.00	47.2 AV	54.0	-6.8	1.54 H	144	31.60	15.60

ANTENNA POLARITY & TEST DISTANCE: VERTICAL AT 3 M

NO.	FREQ. (MHz)	EMISSION LEVEL (dBuV/m)	LIMIT (dBuV/m)	MARGIN (dB)	ANTENNA HEIGHT (m)	TABLE ANGLE (Degree)	RAW VALUE (dBuV)	CORRECTION FACTOR (dB/m)
1	*5825.00	97.4 PK			2.48 V	96	56.30	41.10
2	*5825.00	86.2 AV			2.48 V	96	45.10	41.10
3	#5850.00	47.1 PK	78.2	-31.1	1.69 V	66	44.10	3.00
4	#5852.10	57.3 PK	78.2	-20.9	1.48 V	87	54.30	3.00
5	#5860.10	57.5 PK	74.0	-16.5	1.95 V	262	54.50	3.00
6	#5860.10	43.9 AV	54.0	-10.1	1.95 V	262	40.90	3.00
7	11650.00	59.5 PK	74.0	-14.5	1.52 V	334	43.90	15.60
8	11650.00	46.3 AV	54.0	-7.7	1.52 V	334	30.70	15.60

REMARKS:

1. Emission Level(dBuV/m) = Raw Value(dBuV) + Correction Factor(dB/m)
2. Correction Factor(dB/m) = Antenna Factor(dB/m) + Cable Factor(dB)
– Pre-Amplifier Factor(dB)
3. The other emission levels were very low against the limit.
4. Margin value = Emission Level – Limit value
5. " * ": Fundamental frequency.
6. " # ": The radiated frequency is out of the restricted band.

802.11n (HT40)

CHANNEL	TX Channel 38	DETECTOR FUNCTION	Peak (PK)
FREQUENCY RANGE	1GHz ~ 40GHz		Average (AV)

ANTENNA POLARITY & TEST DISTANCE: HORIZONTAL AT 3 M								
NO.	FREQ. (MHz)	EMISSION LEVEL (dBuV/m)	LIMIT (dBuV/m)	MARGIN (dB)	ANTENNA HEIGHT (m)	TABLE ANGLE (Degree)	RAW VALUE (dBuV)	CORRECTION FACTOR (dB/m)
1	5150.00	68.7 PK	74.0	-5.3	1.37 H	217	66.70	2.00
2	5150.00	53.0 AV	54.0	-1.0	1.37 H	217	51.00	2.00
3	*5190.00	98.7 PK			1.37 H	217	58.70	40.00
4	*5190.00	88.7 AV			1.37 H	217	48.70	40.00
5	#10380.00	58.8 PK	74.0	-15.2	1.34 H	249	43.80	15.00
6	#10380.00	46.4 AV	54.0	-7.6	1.34 H	249	31.40	15.00

ANTENNA POLARITY & TEST DISTANCE: VERTICAL AT 3 M								
NO.	FREQ. (MHz)	EMISSION LEVEL (dBuV/m)	LIMIT (dBuV/m)	MARGIN (dB)	ANTENNA HEIGHT (m)	TABLE ANGLE (Degree)	RAW VALUE (dBuV)	CORRECTION FACTOR (dB/m)
1	5150.00	65.5 PK	74.0	-8.5	1.39 V	83	63.50	2.00
2	5150.00	48.7 AV	54.0	-5.3	1.39 V	83	46.70	2.00
3	*5190.00	95.9 PK			1.47 V	159	55.90	40.00
4	*5190.00	85.5 AV			1.47 V	159	45.50	40.00
5	#10380.00	58.4 PK	74.0	-15.6	1.36 V	57	43.40	15.00
6	#10380.00	46.5 AV	54.0	-7.5	1.36 V	57	31.50	15.00

REMARKS:

1. Emission Level(dBuV/m) = Raw Value(dBuV) + Correction Factor(dB/m)
2. Correction Factor(dB/m) = Antenna Factor(dB/m) + Cable Factor(dB) – Pre-Amplifier Factor(dB)
3. The other emission levels were very low against the limit.
4. Margin value = Emission Level – Limit value
5. " * ": Fundamental frequency.
6. " # ": The radiated frequency is out of the restricted band.

CHANNEL	TX Channel 46	DETECTOR FUNCTION	Peak (PK)
FREQUENCY RANGE	1GHz ~ 40GHz		Average (AV)

ANTENNA POLARITY & TEST DISTANCE: HORIZONTAL AT 3 M

NO.	FREQ. (MHz)	EMISSION LEVEL (dBuV/m)	LIMIT (dBuV/m)	MARGIN (dB)	ANTENNA HEIGHT (m)	TABLE ANGLE (Degree)	RAW VALUE (dBuV)	CORRECTION FACTOR (dB/m)
1	*5230.00	99.1 PK			1.38 H	218	59.00	40.10
2	*5230.00	88.5 AV			1.38 H	218	48.40	40.10
3	5350.00	69.1 PK	74.0	-4.9	1.44 H	215	67.10	2.00
4	5350.00	52.8 AV	54.0	-1.2	1.44 H	215	50.80	2.00
5	#10460.00	59.5 PK	74.0	-14.5	1.36 H	233	44.50	15.00
6	#10460.00	47.0 AV	54.0	-7.0	1.36 H	233	32.00	15.00

ANTENNA POLARITY & TEST DISTANCE: VERTICAL AT 3 M

NO.	FREQ. (MHz)	EMISSION LEVEL (dBuV/m)	LIMIT (dBuV/m)	MARGIN (dB)	ANTENNA HEIGHT (m)	TABLE ANGLE (Degree)	RAW VALUE (dBuV)	CORRECTION FACTOR (dB/m)
1	*5230.00	96.5 PK			1.14 V	108	56.40	40.10
2	*5230.00	86.1 AV			1.14 V	108	46.00	40.10
3	5350.00	55.7 PK	74.0	-18.3	1.24 V	275	53.70	2.00
4	5350.00	43.2 AV	54.0	-10.8	1.24 V	275	41.20	2.00
5	#10460.00	58.3 PK	74.0	-15.7	1.36 V	184	43.30	15.00
6	#10460.00	46.2 AV	54.0	-7.8	1.36 V	184	31.20	15.00

REMARKS:

1. Emission Level(dBuV/m) = Raw Value(dBuV) + Correction Factor(dB/m)
2. Correction Factor(dB/m) = Antenna Factor(dB/m) + Cable Factor(dB) – Pre-Amplifier Factor(dB)
3. The other emission levels were very low against the limit.
4. Margin value = Emission Level – Limit value
5. " * ": Fundamental frequency.
6. " # ": The radiated frequency is out of the restricted band.

CHANNEL	TX Channel 54	DETECTOR FUNCTION	Peak (PK)
FREQUENCY RANGE	1GHz ~ 40GHz		Average (AV)

ANTENNA POLARITY & TEST DISTANCE: HORIZONTAL AT 3 M

NO.	FREQ. (MHz)	EMISSION LEVEL (dBuV/m)	LIMIT (dBuV/m)	MARGIN (dB)	ANTENNA HEIGHT (m)	TABLE ANGLE (Degree)	RAW VALUE (dBuV)	CORRECTION FACTOR (dB/m)
1	5150.00	56.6 PK	74.0	-17.4	1.74 H	211	54.60	2.00
2	5150.00	43.7 AV	54.0	-10.3	1.74 H	211	41.70	2.00
3	*5270.00	99.0 PK			1.36 H	216	58.90	40.10
4	*5270.00	89.0 AV			1.36 H	216	48.90	40.10
5	#10540.00	60.5 PK	74.0	-13.5	1.13 H	180	44.90	15.60
6	#10540.00	47.8 AV	54.0	-6.2	1.13 H	180	32.20	15.60

ANTENNA POLARITY & TEST DISTANCE: VERTICAL AT 3 M

NO.	FREQ. (MHz)	EMISSION LEVEL (dBuV/m)	LIMIT (dBuV/m)	MARGIN (dB)	ANTENNA HEIGHT (m)	TABLE ANGLE (Degree)	RAW VALUE (dBuV)	CORRECTION FACTOR (dB/m)
1	5150.00	55.4 PK	74.0	-18.6	1.80 V	35	53.40	2.00
2	5150.00	43.0 AV	54.0	-11.0	1.80 V	35	41.00	2.00
3	*5270.00	95.9 PK			1.06 V	309	55.80	40.10
4	*5270.00	86.1 AV			1.06 V	309	46.00	40.10
5	#10540.00	59.9 PK	74.0	-14.1	1.45 V	77	44.30	15.60
6	#10540.00	47.9 AV	54.0	-6.1	1.45 V	77	32.30	15.60

REMARKS:

1. Emission Level(dBuV/m) = Raw Value(dBuV) + Correction Factor(dB/m)
2. Correction Factor(dB/m) = Antenna Factor(dB/m) + Cable Factor(dB) – Pre-Amplifier Factor(dB)
3. The other emission levels were very low against the limit.
4. Margin value = Emission Level – Limit value
5. " * ": Fundamental frequency.
6. " # ": The radiated frequency is out of the restricted band.

CHANNEL	TX Channel 62	DETECTOR FUNCTION	Peak (PK)
FREQUENCY RANGE	1GHz ~ 40GHz		Average (AV)

ANTENNA POLARITY & TEST DISTANCE: HORIZONTAL AT 3 M

NO.	FREQ. (MHz)	EMISSION LEVEL (dBuV/m)	LIMIT (dBuV/m)	MARGIN (dB)	ANTENNA HEIGHT (m)	TABLE ANGLE (Degree)	RAW VALUE (dBuV)	CORRECTION FACTOR (dB/m)
1	*5310.00	92.7 PK			1.00 H	220	52.60	40.10
2	*5310.00	82.6 AV			1.00 H	220	42.50	40.10
3	5350.00	56.8 PK	74.0	-17.2	1.84 H	156	54.80	2.00
4	5350.00	43.7 AV	54.0	-10.3	1.84 H	156	41.70	2.00
5	10620.00	61.3 PK	74.0	-12.7	1.32 H	196	45.10	16.20
6	10620.00	48.9 AV	54.0	-5.1	1.32 H	196	32.70	16.20

ANTENNA POLARITY & TEST DISTANCE: VERTICAL AT 3 M

NO.	FREQ. (MHz)	EMISSION LEVEL (dBuV/m)	LIMIT (dBuV/m)	MARGIN (dB)	ANTENNA HEIGHT (m)	TABLE ANGLE (Degree)	RAW VALUE (dBuV)	CORRECTION FACTOR (dB/m)
1	*5310.00	90.9 PK			1.00 V	124	50.80	40.10
2	*5310.00	80.4 AV			1.00 V	124	40.30	40.10
3	5350.00	56.1 PK	74.0	-17.9	1.91 V	152	54.10	2.00
4	5350.00	43.5 AV	54.0	-10.5	1.91 V	152	41.50	2.00
5	10620.00	60.9 PK	74.0	-13.1	1.16 V	135	44.70	16.20
6	10620.00	48.2 AV	54.0	-5.8	1.16 V	135	32.00	16.20

REMARKS:

1. Emission Level(dBuV/m) = Raw Value(dBuV) + Correction Factor(dB/m)
2. Correction Factor(dB/m) = Antenna Factor(dB/m) + Cable Factor(dB) – Pre-Amplifier Factor(dB)
3. The other emission levels were very low against the limit.
4. Margin value = Emission Level – Limit value
5. " * ": Fundamental frequency.

CHANNEL	TX Channel 102	DETECTOR FUNCTION	Peak (PK)
FREQUENCY RANGE	1GHz ~ 40GHz		Average (AV)

ANTENNA POLARITY & TEST DISTANCE: HORIZONTAL AT 3 M

NO.	FREQ. (MHz)	EMISSION LEVEL (dBuV/m)	LIMIT (dBuV/m)	MARGIN (dB)	ANTENNA HEIGHT (m)	TABLE ANGLE (Degree)	RAW VALUE (dBuV)	CORRECTION FACTOR (dB/m)
1	5460.00	58.5 PK	74.0	-15.5	1.82 H	223	56.40	2.10
2	5460.00	44.6 AV	54.0	-9.4	1.82 H	223	42.50	2.10
3	*5510.00	91.7 PK			1.99 H	309	51.40	40.30
4	*5510.00	81.2 AV			1.99 H	309	40.90	40.30
5	11020.00	61.3 PK	74.0	-12.7	1.77 H	259	43.90	17.40
6	11020.00	49.0 AV	54.0	-5.0	1.77 H	259	31.60	17.40

ANTENNA POLARITY & TEST DISTANCE: VERTICAL AT 3 M

NO.	FREQ. (MHz)	EMISSION LEVEL (dBuV/m)	LIMIT (dBuV/m)	MARGIN (dB)	ANTENNA HEIGHT (m)	TABLE ANGLE (Degree)	RAW VALUE (dBuV)	CORRECTION FACTOR (dB/m)
1	5460.00	57.0 PK	74.0	-17.0	1.77 V	217	54.90	2.10
2	5460.00	44.0 AV	54.0	-10.0	1.77 V	217	41.90	2.10
3	*5510.00	90.4 PK			1.14 V	313	50.10	40.30
4	*5510.00	79.4 AV			1.14 V	313	39.10	40.30
5	11020.00	61.4 PK	74.0	-12.6	1.74 V	176	44.00	17.40
6	11020.00	48.8 AV	54.0	-5.2	1.74 V	176	31.40	17.40

REMARKS:

1. Emission Level(dBuV/m) = Raw Value(dBuV) + Correction Factor(dB/m)
2. Correction Factor(dB/m) = Antenna Factor(dB/m) + Cable Factor(dB) – Pre-Amplifier Factor(dB)
3. The other emission levels were very low against the limit.
4. Margin value = Emission Level – Limit value
5. " * ": Fundamental frequency.

CHANNEL	TX Channel 110	DETECTOR FUNCTION	Peak (PK)
FREQUENCY RANGE	1GHz ~ 40GHz		Average (AV)

ANTENNA POLARITY & TEST DISTANCE: HORIZONTAL AT 3 M

NO.	FREQ. (MHz)	EMISSION LEVEL (dBuV/m)	LIMIT (dBuV/m)	MARGIN (dB)	ANTENNA HEIGHT (m)	TABLE ANGLE (Degree)	RAW VALUE (dBuV)	CORRECTION FACTOR (dB/m)
1	*5550.00	104.5 PK			1.49 H	218	64.10	40.40
2	*5550.00	93.7 AV			1.49 H	218	53.30	40.40
3	11100.00	61.2 PK	74.0	-12.8	1.29 H	160	44.60	16.60
4	11100.00	48.7 AV	54.0	-5.3	1.29 H	160	32.10	16.60

ANTENNA POLARITY & TEST DISTANCE: VERTICAL AT 3 M

NO.	FREQ. (MHz)	EMISSION LEVEL (dBuV/m)	LIMIT (dBuV/m)	MARGIN (dB)	ANTENNA HEIGHT (m)	TABLE ANGLE (Degree)	RAW VALUE (dBuV)	CORRECTION FACTOR (dB/m)
1	*5550.00	99.9 PK			1.00 V	306	59.50	40.40
2	*5550.00	89.9 AV			1.00 V	306	49.50	40.40
3	11100.00	60.8 PK	74.0	-13.2	1.37 V	251	44.20	16.60
4	11100.00	48.3 AV	54.0	-5.7	1.37 V	251	31.70	16.60

REMARKS:

1. Emission Level(dBuV/m) = Raw Value(dBuV) + Correction Factor(dB/m)
2. Correction Factor(dB/m) = Antenna Factor(dB/m) + Cable Factor(dB) – Pre-Amplifier Factor(dB)
3. The other emission levels were very low against the limit.
4. Margin value = Emission Level – Limit value
5. " * ": Fundamental frequency.

CHANNEL	TX Channel 134	DETECTOR FUNCTION	Peak (PK)
FREQUENCY RANGE	1GHz ~ 40GHz		Average (AV)

ANTENNA POLARITY & TEST DISTANCE: HORIZONTAL AT 3 M

NO.	FREQ. (MHz)	EMISSION LEVEL (dBuV/m)	LIMIT (dBuV/m)	MARGIN (dB)	ANTENNA HEIGHT (m)	TABLE ANGLE (Degree)	RAW VALUE (dBuV)	CORRECTION FACTOR (dB/m)
1	*5670.00	98.5 PK			1.61 H	172	57.80	40.70
2	*5670.00	87.6 AV			1.61 H	172	46.90	40.70
3	#5725.00	59.2 PK	74.0	-14.8	1.48 H	210	56.60	2.60
4	#5725.00	45.7 AV	54.0	-8.3	1.48 H	210	43.10	2.60
5	11340.00	61.2 PK	74.0	-12.8	1.76 H	204	44.70	16.50
6	11340.00	48.8 AV	54.0	-5.2	1.76 H	204	32.30	16.50

ANTENNA POLARITY & TEST DISTANCE: VERTICAL AT 3 M

NO.	FREQ. (MHz)	EMISSION LEVEL (dBuV/m)	LIMIT (dBuV/m)	MARGIN (dB)	ANTENNA HEIGHT (m)	TABLE ANGLE (Degree)	RAW VALUE (dBuV)	CORRECTION FACTOR (dB/m)
1	*5670.00	95.2 PK			1.00 V	192	54.50	40.70
2	*5670.00	84.8 AV			1.00 V	192	44.10	40.70
3	#5725.00	57.5 PK	74.0	-16.5	1.58 V	161	54.90	2.60
4	#5725.00	44.9 AV	54.0	-9.1	1.58 V	161	42.30	2.60
5	11340.00	60.9 PK	74.0	-13.1	1.79 V	145	44.40	16.50
6	11340.00	48.7 AV	54.0	-5.3	1.79 V	145	32.20	16.50

REMARKS:

1. Emission Level(dBuV/m) = Raw Value(dBuV) + Correction Factor(dB/m)
2. Correction Factor(dB/m) = Antenna Factor(dB/m) + Cable Factor(dB) – Pre-Amplifier Factor(dB)
3. The other emission levels were very low against the limit.
4. Margin value = Emission Level – Limit value
5. " * ": Fundamental frequency.
6. " # ": The radiated frequency is out of the restricted band.



CHANNEL	TX Channel 151	DETECTOR FUNCTION	Peak (PK)
FREQUENCY RANGE	1GHz ~ 40GHz		Average (AV)

ANTENNA POLARITY & TEST DISTANCE: HORIZONTAL AT 3 M

NO.	FREQ. (MHz)	EMISSION LEVEL (dBuV/m)	LIMIT (dBuV/m)	MARGIN (dB)	ANTENNA HEIGHT (m)	TABLE ANGLE (Degree)	RAW VALUE (dBuV)	CORRECTION FACTOR (dB/m)
1	#5714.90	73.0 PK	74.0	-1.0	1.43 H	271	70.40	2.60
2	#5714.90	50.5 AV	54.0	-3.5	1.43 H	271	47.90	2.60
3	#5722.90	73.9 PK	78.2	-4.3	1.11 H	270	71.30	2.60
4	#5725.00	57.4 PK	78.2	-20.8	1.00 H	270	54.80	2.60
5	*5755.00	97.0 PK			1.40 H	271	56.00	41.00
6	*5755.00	86.0 AV			1.40 H	271	45.00	41.00
7	11510.00	59.9 PK	74.0	-14.1	1.00 H	141	44.20	15.70
8	11510.00	47.2 AV	54.0	-6.8	1.00 H	141	31.50	15.70

ANTENNA POLARITY & TEST DISTANCE: VERTICAL AT 3 M

NO.	FREQ. (MHz)	EMISSION LEVEL (dBuV/m)	LIMIT (dBuV/m)	MARGIN (dB)	ANTENNA HEIGHT (m)	TABLE ANGLE (Degree)	RAW VALUE (dBuV)	CORRECTION FACTOR (dB/m)
1	#5714.90	71.7 PK	74.0	-2.3	1.00 V	272	69.10	2.60
2	#5714.90	51.7 AV	54.0	-2.3	1.00 V	272	49.10	2.60
3	#5722.90	73.7 PK	78.2	-4.5	1.00 V	270	71.10	2.60
4	#5725.00	56.4 PK	78.2	-21.8	1.03 V	270	53.80	2.60
5	*5755.00	95.8 PK			1.00 V	269	54.80	41.00
6	*5755.00	84.9 AV			1.00 V	269	43.90	41.00
7	11510.00	60.0 PK	74.0	-14.0	1.00 V	269	44.30	15.70
8	11510.00	47.4 AV	54.0	-6.6	1.00 V	269	31.70	15.70

REMARKS:

- Emission Level(dBuV/m) = Raw Value(dBuV) + Correction Factor(dB/m)
- Correction Factor(dB/m) = Antenna Factor(dB/m) + Cable Factor(dB)
– Pre-Amplifier Factor(dB)
- The other emission levels were very low against the limit.
- Margin value = Emission Level – Limit value
- " * ": Fundamental frequency.
- " # ": The radiated frequency is out of the restricted band.



CHANNEL	TX Channel 159	DETECTOR FUNCTION	Peak (PK)
FREQUENCY RANGE	1GHz ~ 40GHz		Average (AV)

ANTENNA POLARITY & TEST DISTANCE: HORIZONTAL AT 3 M

NO.	FREQ. (MHz)	EMISSION LEVEL (dBuV/m)	LIMIT (dBuV/m)	MARGIN (dB)	ANTENNA HEIGHT (m)	TABLE ANGLE (Degree)	RAW VALUE (dBuV)	CORRECTION FACTOR (dB/m)
1	*5795.00	100.6 PK			1.00 H	170	59.50	41.10
2	*5795.00	89.2 AV			1.00 H	170	48.10	41.10
3	#5850.00	48.7 PK	78.2	-29.5	1.00 H	140	45.70	3.00
4	#5852.10	63.6 PK	78.2	-14.6	1.00 H	140	60.60	3.00
5	#5860.10	60.6 PK	74.0	-13.4	1.00 H	141	57.60	3.00
6	#5860.10	44.9 AV	54.0	-9.1	1.00 H	141	41.90	3.00
7	11590.00	62.2 PK	74.0	-11.8	1.05 H	163	46.60	15.60
8	11590.00	48.4 AV	54.0	-5.6	1.05 H	163	32.80	15.60

ANTENNA POLARITY & TEST DISTANCE: VERTICAL AT 3 M

NO.	FREQ. (MHz)	EMISSION LEVEL (dBuV/m)	LIMIT (dBuV/m)	MARGIN (dB)	ANTENNA HEIGHT (m)	TABLE ANGLE (Degree)	RAW VALUE (dBuV)	CORRECTION FACTOR (dB/m)
1	*5795.00	96.2 PK			1.07 V	260	55.10	41.10
2	*5795.00	85.9 AV			1.07 V	260	44.80	41.10
3	#5850.00	46.4 PK	78.2	-31.8	1.11 V	281	43.40	3.00
4	#5852.10	62.2 PK	78.2	-16.0	1.10 V	275	59.20	3.00
5	#5860.10	58.9 PK	74.0	-15.1	1.11 V	280	55.90	3.00
6	#5860.10	43.9 AV	54.0	-10.1	1.11 V	280	40.90	3.00
7	11590.00	59.5 PK	74.0	-14.5	1.11 V	282	43.90	15.60
8	11590.00	46.0 AV	54.0	-8.0	1.11 V	282	30.40	15.60

REMARKS:

- Emission Level(dBuV/m) = Raw Value(dBuV) + Correction Factor(dB/m)
- Correction Factor(dB/m) = Antenna Factor(dB/m) + Cable Factor(dB)
– Pre-Amplifier Factor(dB)
- The other emission levels were very low against the limit.
- Margin value = Emission Level – Limit value
- " * ": Fundamental frequency.
- " # ": The radiated frequency is out of the restricted band.

BELOW 1GHz WORST-CASE DATA

802.11n (HT20)

CHANNEL	TX Channel 116	DETECTOR FUNCTION	Quasi-Peak (QP)
FREQUENCY RANGE	30MHz ~ 1GHz	TEST MODE	A

ANTENNA POLARITY & TEST DISTANCE: HORIZONTAL AT 3 M

NO.	FREQ. (MHz)	EMISSION LEVEL (dBuV/m)	LIMIT (dBuV/m)	MARGIN (dB)	ANTENNA HEIGHT (m)	TABLE ANGLE (Degree)	RAW VALUE (dBuV)	CORRECTION FACTOR (dB/m)
1	57.12	32.0 QP	40.0	-8.0	1.99 H	52	46.70	-14.70
2	90.17	21.8 QP	43.5	-21.7	1.99 H	144	41.50	-19.70
3	131.00	19.4 QP	43.5	-24.1	1.50 H	16	34.90	-15.50
4	162.11	25.2 QP	43.5	-18.3	1.50 H	265	39.00	-13.80
5	183.50	32.4 QP	43.5	-11.1	1.50 H	97	47.70	-15.30
6	218.50	23.5 QP	46.0	-22.5	1.00 H	252	39.70	-16.20

ANTENNA POLARITY & TEST DISTANCE: VERTICAL AT 3 M

NO.	FREQ. (MHz)	EMISSION LEVEL (dBuV/m)	LIMIT (dBuV/m)	MARGIN (dB)	ANTENNA HEIGHT (m)	TABLE ANGLE (Degree)	RAW VALUE (dBuV)	CORRECTION FACTOR (dB/m)
1	30.00	27.1 QP	40.0	-12.9	1.51 V	334	43.10	-16.00
2	57.12	33.8 QP	40.0	-6.2	1.00 V	191	48.50	-14.70
3	111.56	27.0 QP	43.5	-16.5	1.00 V	59	44.10	-17.10
4	136.84	23.5 QP	43.5	-20.0	1.00 V	216	38.20	-14.70
5	181.55	28.8 QP	43.5	-14.7	1.00 V	295	44.00	-15.20
6	284.60	18.0 QP	46.0	-28.0	1.00 V	69	30.50	-12.50

REMARKS:

1. Emission Level(dBuV/m) = Raw Value(dBuV) + Correction Factor(dB/m)
2. Correction Factor(dB/m) = Antenna Factor(dB/m) + Cable Factor(dB)
– Pre-Amplifier Factor(dB)
3. The other emission levels were very low against the limit.
4. Margin value = Emission Level – Limit value

CHANNEL	TX Channel 116	DETECTOR FUNCTION	Quasi-Peak (QP)
FREQUENCY RANGE	30MHz ~ 1GHz	TEST MODE	B

ANTENNA POLARITY & TEST DISTANCE: HORIZONTAL AT 3 M

NO.	FREQ. (MHz)	EMISSION LEVEL (dBuV/m)	LIMIT (dBuV/m)	MARGIN (dB)	ANTENNA HEIGHT (m)	TABLE ANGLE (Degree)	RAW VALUE (dBuV)	CORRECTION FACTOR (dB/m)
1	33.88	31.8 QP	40.0	-8.2	1.51 H	331	47.20	-15.40
2	82.38	32.5 QP	40.0	-7.5	1.26 H	15	51.20	-18.70
3	177.44	39.2 QP	43.5	-4.3	1.51 H	314	53.90	-14.70
4	272.50	29.8 QP	46.0	-16.2	1.26 H	287	43.10	-13.30
5	309.36	28.8 QP	46.0	-17.2	1.00 H	300	40.90	-12.10
6	730.34	38.8 QP	46.0	-7.2	1.26 H	15	42.70	-3.90

ANTENNA POLARITY & TEST DISTANCE: VERTICAL AT 3 M

NO.	FREQ. (MHz)	EMISSION LEVEL (dBuV/m)	LIMIT (dBuV/m)	MARGIN (dB)	ANTENNA HEIGHT (m)	TABLE ANGLE (Degree)	RAW VALUE (dBuV)	CORRECTION FACTOR (dB/m)
1	49.40	33.6 QP	40.0	-6.4	1.00 V	7	47.40	-13.80
2	82.38	33.0 QP	40.0	-7.0	1.24 V	224	51.70	-18.70
3	177.44	35.1 QP	43.5	-8.4	1.49 V	345	49.80	-14.70
4	272.50	24.1 QP	46.0	-21.9	1.00 V	319	37.40	-13.30
5	309.36	27.6 QP	46.0	-18.4	1.00 V	67	39.70	-12.10
6	817.64	29.1 QP	46.0	-16.9	1.00 V	285	31.20	-2.10

REMARKS:

1. Emission Level(dBuV/m) = Raw Value(dBuV) + Correction Factor(dB/m)
2. Correction Factor(dB/m) = Antenna Factor(dB/m) + Cable Factor(dB)
– Pre-Amplifier Factor(dB)
3. The other emission levels were very low against the limit.
4. Margin value = Emission Level – Limit value

4.2 Conducted Emission Measurement

4.2.1 Limits of Conducted Emission Measurement

Frequency (MHz)	Conducted Limit (dBuV)	
	Quasi-peak	Average
0.15 - 0.5	66 - 56	56 - 46
0.50 - 5.0	56	46
5.0 - 30.0	60	50

Note: 1. The lower limit shall apply at the transition frequencies.

2. The limit decreases in line with the logarithm of the frequency in the range of 0.15 to 0.50MHz.

4.2.2 Test Instruments

Tested date: Dec. 10, 2015

Description & Manufacturer	Model No.	Serial No.	Date Of Calibration	Due Date Of Calibration
Test Receiver ROHDE & SCHWARZ	ESCS 30	100288	Apr. 27, 2015	Apr. 26, 2016
RF signal cable (with 10dB PAD) Woken	5D-FB	Cable-cond2-01	Dec. 26, 2014	Dec. 25, 2015
LISN ROHDE & SCHWARZ (EUT)	ESH2-Z5	100100	Dec. 30, 2014	Dec. 29, 2015
LISN ROHDE & SCHWARZ (Peripheral)	ESH3-Z5	100312	Jul. 21, 2015	Jul. 20, 2016
Software ADT	BV ADT_Cond_ V7.3.7.3	NA	NA	NA

NOTE: 1. The calibration interval of the above test instruments is 12 months and the calibrations are traceable to NML/ROC and NIST/USA.

2. The test was performed in HwaYa Shielded Room 2.

3. The VCCI Site Registration No. is C-2047.

4.2.3 Test Procedures

- The EUT was placed 0.4 meters from the conducting wall of the shielded room with EUT being connected to the power mains through a line impedance stabilization network (LISN). Other support units were connected to the power mains through another LISN. The two LISNs provide 50 ohm/ 50uH of coupling impedance for the measuring instrument.
- Both lines of the power mains connected to the EUT were checked for maximum conducted interference.
- The frequency range from 150kHz to 30MHz was searched. Emission levels under (Limit - 20dB) was not recorded.

NOTE: The resolution bandwidth and video bandwidth of test receiver is 9kHz for quasi-peak detection (QP) and average detection (AV) at frequency 0.15MHz-30MHz.

4.2.4 Deviation from Test Standard

No deviation.

4.2.5 Test Setup

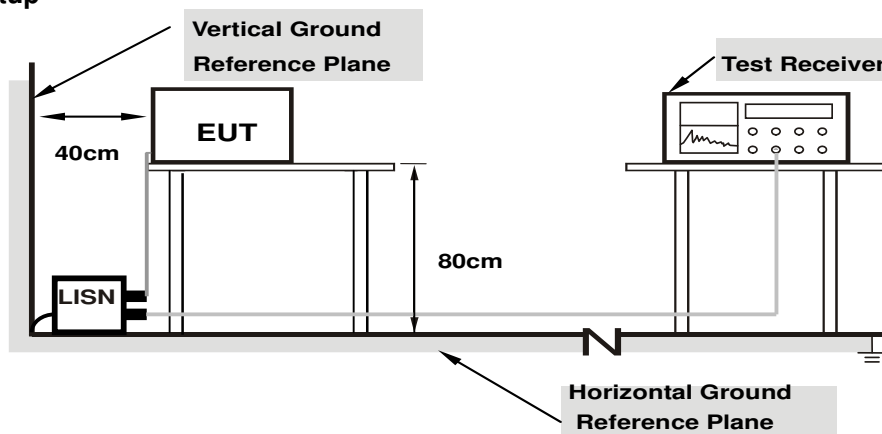

Note: 1.Support units were connected to second LISN.

For the actual test configuration, please refer to the attached file (Test Setup Photo).

4.2.6 EUT Operating Conditions

Same as 4.1.6.

4.2.7 Test Results

Phase	Line (L)	Detector Function	Quasi-Peak (QP) / Average (AV)
-------	----------	-------------------	--------------------------------

No	Freq. [MHz]	Corr. Factor (dB)	Reading Value		Emission Level		Limit		Margin	
			[dB (uV)]		[dB (uV)]		[dB (uV)]		(dB)	
			Q.P.	AV.	Q.P.	AV.	Q.P.	AV.	Q.P.	AV.
1	0.17344	9.94	36.79	28.30	46.73	38.24	64.79	54.79	-18.06	-16.55
2	0.40000	9.95	31.90	26.02	41.85	35.97	57.85	47.85	-16.00	-11.88
3	0.49375	9.97	27.22	17.53	37.19	27.50	56.10	46.10	-18.92	-18.61
4	0.86875	10.04	27.59	19.92	37.63	29.96	56.00	46.00	-18.37	-16.04
5	1.33594	10.10	28.32	19.83	38.42	29.93	56.00	46.00	-17.58	-16.07
6	2.05469	10.16	21.88	14.78	32.04	24.94	56.00	46.00	-23.96	-21.06

REMARKS:

1. Q.P. and AV. are abbreviations of quasi-peak and average individually.
2. The emission levels of other frequencies were very low against the limit.
3. Margin value = Emission level - Limit value
4. Correction factor = Insertion loss + Cable loss
5. Emission Level = Correction Factor + Reading Value.

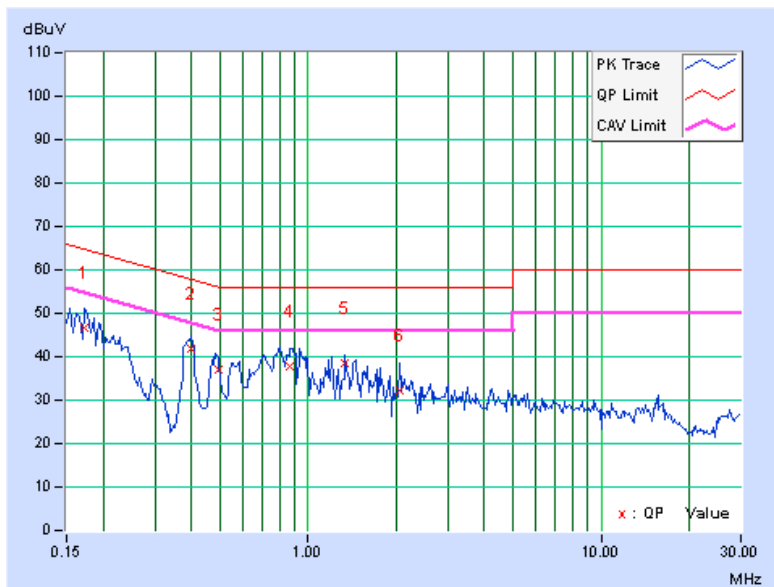

Phase	Neutral (N)	Detector Function	Quasi-Peak (QP) / Average (AV)
-------	-------------	-------------------	--------------------------------

No	Freq. [MHz]	Corr. Factor (dB)	Reading Value [dB (uV)]		Emission Level [dB (uV)]		Limit [dB (uV)]		Margin (dB)	
			Q.P.	AV.	Q.P.	AV.	Q.P.	AV.	Q.P.	AV.
			1	0.16953	9.96	35.66	25.28	45.62	35.24	64.98
2	0.39219	10.00	28.17	22.71	38.17	32.71	58.02	48.02	-19.85	-15.31
3	0.47422	10.01	25.06	19.06	35.07	29.07	56.44	46.44	-21.37	-17.37
4	0.80234	10.05	26.27	17.95	36.32	28.00	56.00	46.00	-19.68	-18.00
5	1.33594	10.12	28.66	20.35	38.78	30.47	56.00	46.00	-17.22	-15.53
6	5.81250	10.36	17.00	11.32	27.36	21.68	60.00	50.00	-32.64	-28.32

REMARKS:

1. Q.P. and AV. are abbreviations of quasi-peak and average individually.
2. The emission levels of other frequencies were very low against the limit.
3. Margin value = Emission level - Limit value
4. Correction factor = Insertion loss + Cable loss
5. Emission Level = Correction Factor + Reading Value.

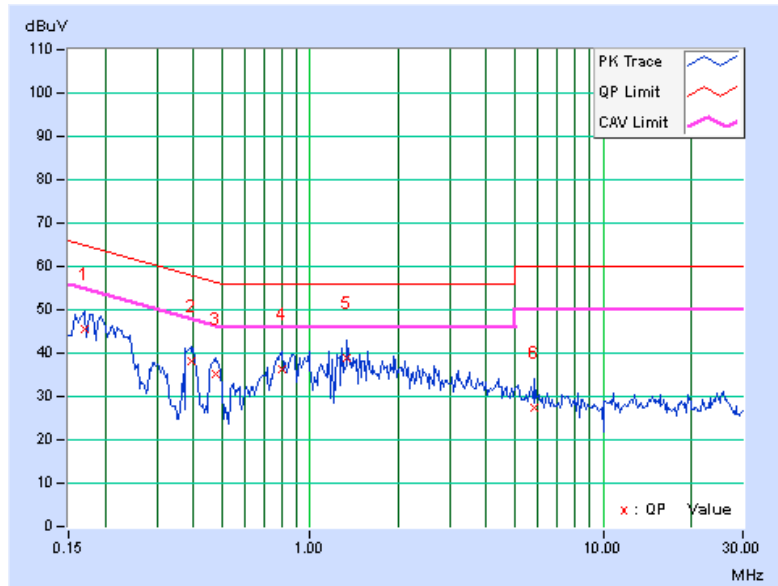

4.3 Transmit Power Measurement

4.3.1 Limits of Transmit Power Measurement

Operation Band	EUT Category		LIMIT
U-NII-1		Outdoor Access Point	1 Watt (30 dBm) (Max. e.i.r.p \leq 125mW(21 dBm) at any elevation angle above 30 degrees as measured from the horizon)
		Fixed point-to-point Access Point	1 Watt (30 dBm)
		Indoor Access Point	1 Watt (30 dBm)
	√	Mobile and Portable client device	250mW (24 dBm)
U-NII-2A		√	250mW (24 dBm) or 11 dBm+10 log B*
U-NII-2C		√	250mW (24 dBm) or 11 dBm+10 log B*
U-NII-3		√	1 Watt (30 dBm)

*B is the 26 dB emission bandwidth in megahertz

Per KDB 662911 Method of conducted output power measurement on IEEE 802.11 devices,

Array Gain = 0 dB (i.e., no array gain) for $N_{ANT} \leq 4$;

Array Gain = 0 dB (i.e., no array gain) for channel widths ≥ 40 MHz for any N_{ANT} ;

Array Gain = 5 log(N_{ANT}/N_{SS}) dB or 3 dB, whichever is less for 20-MHz channel widths with $N_{ANT} \geq 5$.

For power measurements on all other devices: Array Gain = 10 log(N_{ANT}/N_{SS}) dB.

4.3.2 Test Setup

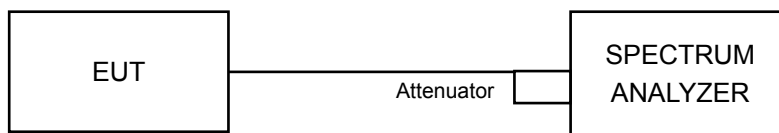

4.3.3 Test Instruments

Refer to section 4.1.2 to get information of above instrument.

4.3.4 Test Procedure

FOR AVERAGE POWER MEASUREMENT

Method PM is used to perform output power measurement, trigger and gating function of wide band power meter is enabled to measure max output power of TX on burst. Duty factor is not added to measured value.

4.3.5 Deviation from Test Standard

No deviation.

4.3.6 EUT Operating Conditions

The software provided by client to enable the EUT under transmission condition continuously at lowest, middle and highest channel frequencies individually.

4.3.7 Test Result

POWER OUTPUT:

802.11a

Channel	Frequency (MHz)	Maximum Conducted Power (mW)	Maximum Conducted Power (dBm)	Power Limit (dBm)	Pass / Fail
36	5180	37.497	15.74	24	Pass
40	5200	38.019	15.80	24	Pass
48	5240	24.889	13.96	24	Pass
52	5260	26.792	14.28	24	Pass
60	5300	34.914	15.43	24	Pass
64	5320	31.333	14.96	24	Pass
100	5500	22.491	13.52	24	Pass
116	5580	60.256	17.80	24	Pass
140	5700	27.416	14.38	24	Pass
149	5745	40.738	16.10	30	Pass
157	5785	66.681	18.24	30	Pass
165	5825	47.206	16.74	30	Pass

NOTE:

For U-NII-2A, U-NII-2C Band:

1. $11\text{dBm} + 10\log(44.37) = 27.47\text{ dBm} > 24\text{dBm}$.
2. $11\text{dBm} + 10\log(45.41) = 27.57\text{ dBm} > 24\text{dBm}$.
3. $11\text{dBm} + 10\log(41.87) = 27.22\text{ dBm} > 24\text{dBm}$.
4. $11\text{dBm} + 10\log(34.54) = 26.38\text{ dBm} > 24\text{dBm}$.
5. $11\text{dBm} + 10\log(44.32) = 27.47\text{ dBm} > 24\text{dBm}$.
6. $11\text{dBm} + 10\log(22.83) = 24.59\text{ dBm} > 24\text{dBm}$.

802.11n (HT20)

Channel	Frequency (MHz)	Maximum Conducted Power (mW)	Maximum Conducted Power (dBm)	Power Limit (dBm)	Pass / Fail
36	5180	37.584	15.75	24	Pass
40	5200	38.194	15.82	24	Pass
48	5240	24.660	13.92	24	Pass
52	5260	31.117	14.93	24	Pass
60	5300	34.754	15.41	24	Pass
64	5320	36.644	15.64	24	Pass
100	5500	24.604	13.91	24	Pass
116	5580	57.016	17.56	24	Pass
140	5700	25.351	14.04	24	Pass
149	5745	32.584	15.13	30	Pass
157	5785	68.234	18.34	30	Pass
165	5825	47.863	16.80	30	Pass

NOTE:

For U-NII-2A, U-NII-2C Band:

1. $11\text{dBm} + 10\log(48.09) = 27.82\text{ dBm} > 24\text{dBm}$.
2. $11\text{dBm} + 10\log(48.10) = 27.82\text{ dBm} > 24\text{dBm}$.
3. $11\text{dBm} + 10\log(47.34) = 27.75\text{ dBm} > 24\text{dBm}$.
4. $11\text{dBm} + 10\log(39.18) = 26.93\text{ dBm} > 24\text{dBm}$.
5. $11\text{dBm} + 10\log(45.61) = 27.59\text{ dBm} > 24\text{dBm}$.
6. $11\text{dBm} + 10\log(23.02) = 24.62\text{ dBm} > 24\text{dBm}$.

802.11n (HT40)

Channel	Frequency (MHz)	Maximum Conducted Power (mW)	Maximum Conducted Power (dBm)	Power Limit (dBm)	Pass / Fail
38	5190	24.210	13.84	24	Pass
46	5230	22.233	13.47	24	Pass
54	5270	33.729	15.28	24	Pass
62	5310	15.488	11.90	24	Pass
102	5510	10.116	10.05	24	Pass
110	5550	71.121	18.52	24	Pass
134	5670	34.356	15.36	24	Pass
151	5755	33.806	15.29	30	Pass
159	5795	66.681	18.24	30	Pass

NOTE:
For U-NII-2A, U-NII-2C Band:

1. $11\text{dBm} + 10\log(100.00) = 31.00\text{ dBm} > 24\text{dBm}$.
2. $11\text{dBm} + 10\log(63.94) = 29.06\text{ dBm} > 24\text{dBm}$.
3. $11\text{dBm} + 10\log(46.77) = 27.70\text{ dBm} > 24\text{dBm}$.
4. $11\text{dBm} + 10\log(94.56) = 30.76\text{ dBm} > 24\text{dBm}$.
5. $11\text{dBm} + 10\log(65.07) = 29.13\text{ dBm} > 24\text{dBm}$.

26dB BANDWIDTH:
802.11a

Channel	Frequency (MHz)	26dBc Bandwidth (MHz)	Pass / Fail
36	5180	47.83	Pass
40	5200	46.42	Pass
48	5240	42.85	Pass
52	5260	44.37	Pass
60	5300	45.41	Pass
64	5320	41.87	Pass
100	5500	34.54	Pass
116	5580	44.32	Pass
140	5700	22.83	Pass

802.11n (HT20)

Channel	Frequency (MHz)	26dBc Bandwidth (MHz)	Pass / Fail
36	5180	49.73	Pass
40	5200	50.41	Pass
48	5240	41.41	Pass
52	5260	48.09	Pass
60	5300	48.10	Pass
64	5320	47.34	Pass
100	5500	39.18	Pass
116	5580	45.61	Pass
140	5700	23.02	Pass

802.11n (HT40)

Channel	Frequency (MHz)	26dBc Bandwidth (MHz)	Pass / Fail
38	5190	98.67	Pass
46	5230	96.25	Pass
54	5270	100.00	Pass
62	5310	63.94	Pass
102	5510	46.77	Pass
110	5550	94.56	Pass
134	5670	65.07	Pass

SPECTRUM PLOT OF WORST VALUE

802.11a

802.11n (HT20)

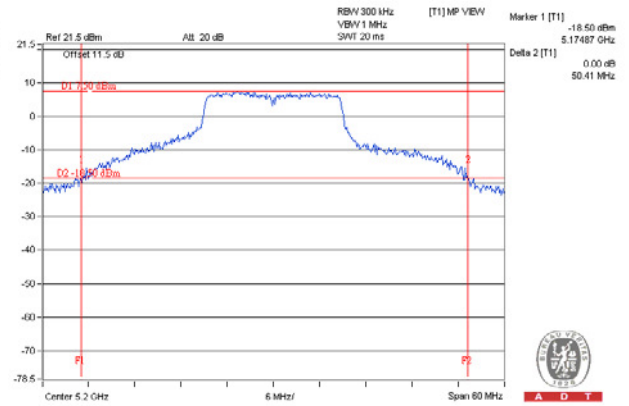
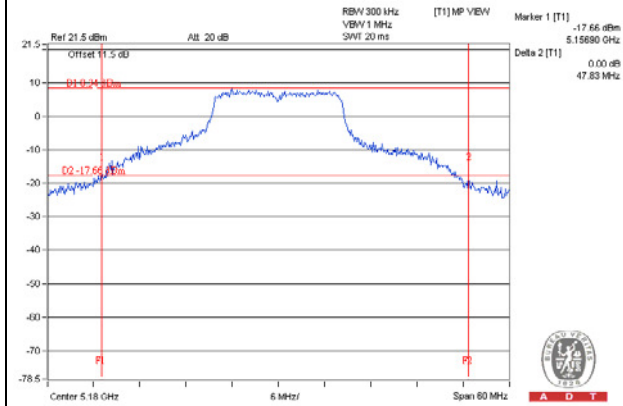

802.11n (HT40)

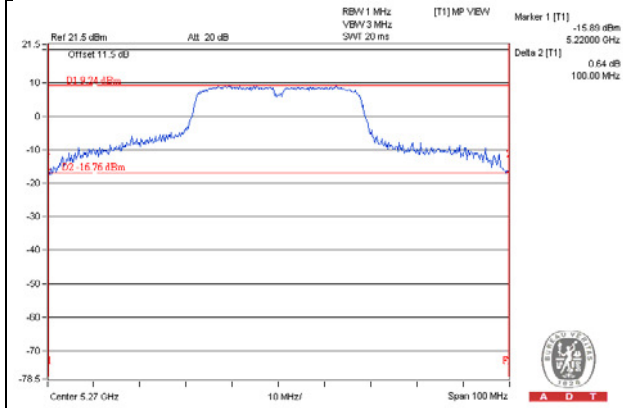

OCCUPIED BANDWIDTH:**802.11a**

Channel	Frequency (MHz)	Occupied Bandwidth (MHz)
36	5180	31.56
40	5200	31.68
48	5240	19.56
52	5260	24.24
60	5300	29.28
64	5320	23.16
100	5500	17.64
116	5580	24.96
140	5700	17.28
149	5745	24.26
157	5785	30.36
165	5825	27.72

802.11n (HT20)

Channel	Frequency (MHz)	Occupied Bandwidth (MHz)
36	5180	33.96
40	5200	34.08
48	5240	19.92
52	5260	30.36
60	5300	31.44
64	5320	27.60
100	5500	18.84
116	5580	26.88
140	5700	18.24
149	5745	23.76
157	5785	30.12
165	5825	27.84

802.11n (HT40)

Channel	Frequency (MHz)	Occupied Bandwidth (MHz)
38	5190	41.04
46	5230	37.92
54	5270	43.44
62	5310	36.96
102	5510	36.72
110	5550	37.92
134	5670	36.96
151	5755	38.16
159	5795	43.92

SPECTRUM PLOT OF WORST VALUE

802.11a

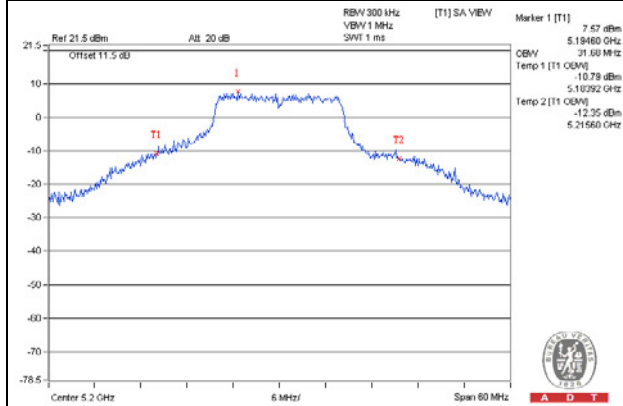

802.11n (HT20)

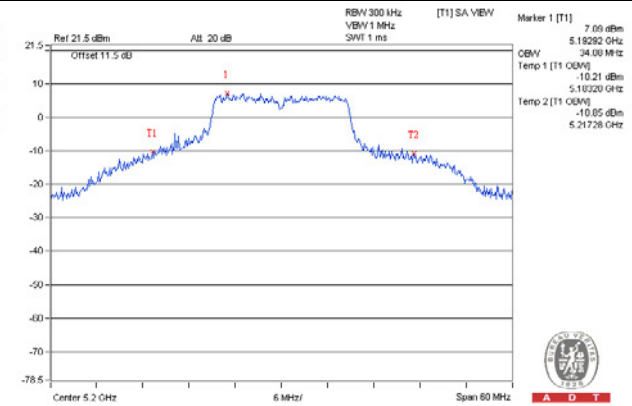

802.11n (HT40)

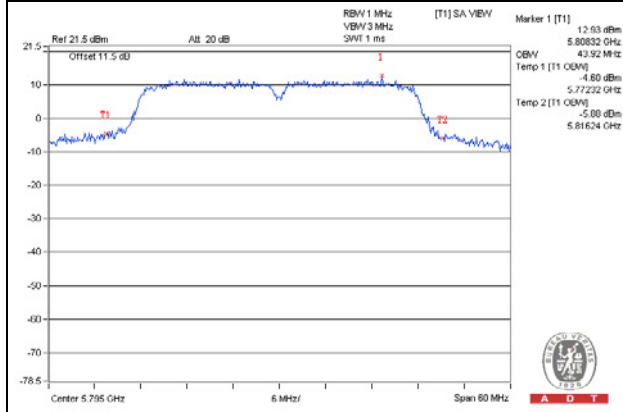

EUT MAXIMUM CONDUCTED POWER
802.11a

Frequency Band (MHz)	Max. Power	
	Output Power (mW)	Output Power (dBm)
5250~5350	34.914	15.43
5470~5725	60.256	17.80

NOTE: Manufacturer provides Transmit Power Control description to meet this requirement.

802.11n (HT20)

Frequency Band (MHz)	Max. Power	
	Output Power (mW)	Output Power (dBm)
5250~5350	36.644	15.64
5470~5725	57.016	17.56

NOTE: Manufacturer provides Transmit Power Control description to meet this requirement.

802.11n (HT40)

Frequency Band (MHz)	Max. Power	
	Output Power (mW)	Output Power (dBm)
5250~5350	33.729	15.28
5470~5725	71.121	18.52

NOTE: Manufacturer provides Transmit Power Control description to meet this requirement.

4.4 Peak Power Spectral Density Measurement

4.4.1 Limits of Peak Power Spectral Density Measurement

Operation Band	EUT Category		LIMIT
U-NII-1		Outdoor Access Point	17dBm/ MHz
		Fixed point-to-point Access Point	
		Indoor Access Point	
	√	Mobile and Portable client device	11dBm/ MHz
U-NII-2A	√		11dBm/ MHz
U-NII-2C	√		11dBm/ MHz
U-NII-3	√		30dBm/ 500kHz

4.4.2 Test Setup

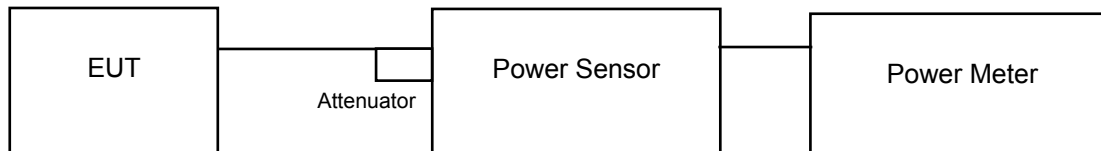

4.4.3 Test Instruments

Refer to section 4.1.2 to get information of above instrument.

4.4.4 Test Procedures

For U-NII-1, U-NII-2A, U-NII-2C band:

Using method SA-2 alternative

- 1) Set span to encompass the entire emission bandwidth (EBW) of the signal.
- 2) Set RBW = 30 kHz, Set VBW ≥ 1 MHz, Detector = RMS
- 3) Set Channel power measure = 1MHz
- 4) Sweep time = 20ms.
- 5) Perform a single sweep.
- 6) Record the max value and add 10 log (1/duty cycle)

For U-NII-3 band:

- 1) Set span to encompass the entire emission bandwidth (EBW) of the signal.
- 2) Set RBW = 1 MHz, Set VBW ≥ 3 MHz, Detector = RMS
- 3) Sweep time = auto, trigger set to “free run”.
- 5) Trace average at least 100 traces in power averaging mode.
- 6) Record the max value and add 10 log (1/duty cycle)

4.4.5 Deviation from Test Standard

No deviation.

4.4.6 EUT Operating Conditions

Same as Item 4.3.6.

4.4.7 Test Results

For U-NII-1, U-NII-2A, U-NII-2C Band

802.11a

Channel	Frequency (MHz)	PSD W/O Duty Factor (dBm)	Duty Factor	PSD with duty factor (dBm)	Maximum Limit (dBm)	Pass / Fail
36	5180	2.16	0.62	2.78	11	Pass
40	5200	2.25	0.62	2.87	11	Pass
48	5240	-0.50	0.62	0.12	11	Pass
52	5260	0.12	0.62	0.74	11	Pass
60	5300	1.61	0.62	2.23	11	Pass
64	5320	-0.42	0.62	0.20	11	Pass
100	5500	-1.41	0.62	-0.79	11	Pass
116	5580	1.49	0.62	2.11	11	Pass
140	5700	-7.26	0.62	-6.64	11	Pass

NOTE: Refer to section 3.3 for duty cycle spectrum plot.

802.11n (HT20)

Channel	Frequency (MHz)	PSD W/O Duty Factor (dBm)	Duty Factor	PSD with duty factor (dBm)	Maximum Limit (dBm)	Pass / Fail
36	5180	1.98	0.71	2.69	11	Pass
40	5200	2.03	0.71	2.74	11	Pass
48	5240	-0.91	0.71	-0.20	11	Pass
52	5260	0.51	0.71	1.22	11	Pass
60	5300	0.70	0.71	1.41	11	Pass
64	5320	0.71	0.71	1.42	11	Pass
100	5500	-1.29	0.71	-0.58	11	Pass
116	5580	1.20	0.71	1.91	11	Pass
140	5700	-8.08	0.71	-7.37	11	Pass

NOTE: Refer to section 3.3 for duty cycle spectrum plot.

802.11n (HT40)

Channel	Frequency (MHz)	PSD W/O Duty Factor (dBm)	Duty Factor	PSD WITH Duty Factor (dBm)	Maximum Limit (dBm)	Pass / Fail
38	5190	-2.02	0.73	-1.29	11	Pass
46	5230	-4.10	0.73	-3.37	11	Pass
54	5270	-1.94	0.73	-1.21	11	Pass
62	5310	-7.40	0.73	-6.67	11	Pass
102	5510	-7.55	0.73	-6.82	11	Pass
110	5550	-2.37	0.73	-1.64	11	Pass
134	5670	-6.28	0.73	-5.55	11	Pass

NOTE: Refer to section 3.3 for duty cycle spectrum plot.

SPECTRUM PLOT OF WORST VALUE

802.11a

802.11n (HT20)

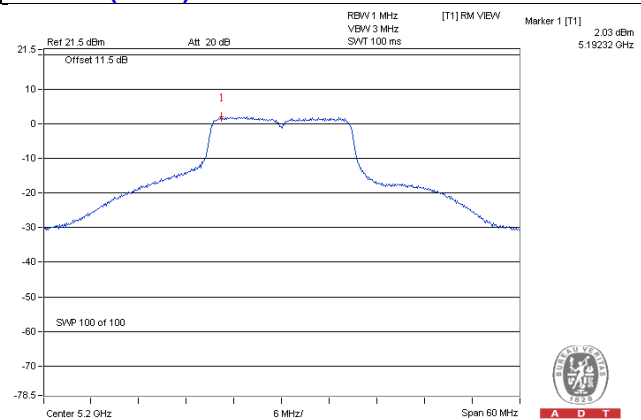
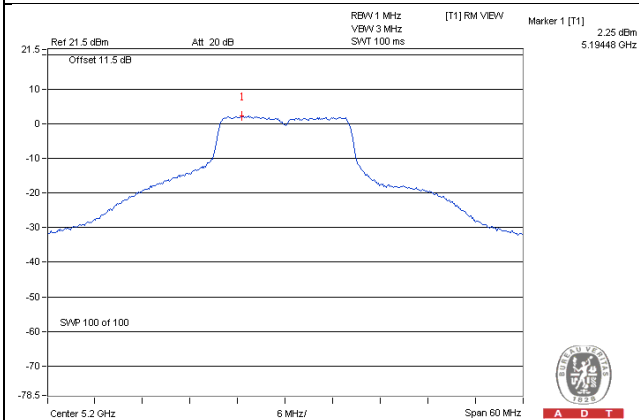

802.11n (HT40)

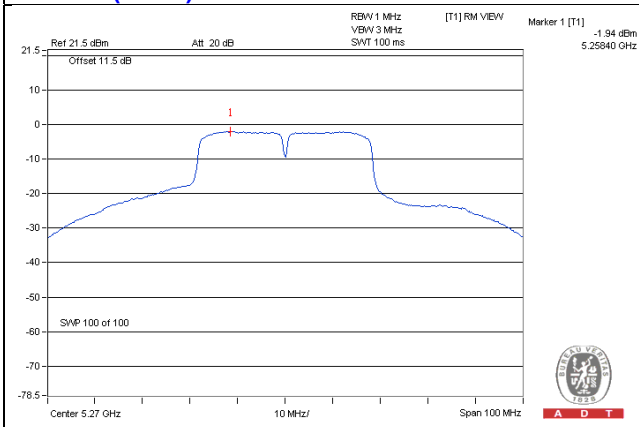

For U-NII-3 Band

802.11a

Chan.	Freq. (MHz)	PSD (dBm/300kHz)	PSD (dBm/500kHz)	Duty Factor	Total PSD (dBm/500kHz)	Limit (dBm/500kHz)	Pass / Fail
149	5745	-6.38	-4.16	0.62	-3.54	30	Pass
157	5785	-4.87	-2.65	0.62	-2.03	30	Pass
165	5825	-5.43	-3.21	0.62	-2.59	30	Pass

NOTE: Refer to section 3.3 for duty cycle spectrum plot.

802.11n (HT20)

Chan.	Freq. (MHz)	PSD (dBm/300kHz)	PSD (dBm/500kHz)	Duty Factor	Total PSD (dBm/500kHz)	Limit (dBm/500kHz)	Pass / Fail
149	5745	-6.41	-4.19	0.71	-3.48	30	Pass
157	5785	-4.92	-2.70	0.71	-1.99	30	Pass
165	5825	-5.25	-3.03	0.71	-2.32	30	Pass

NOTE: Refer to section 3.3 for duty cycle spectrum plot.

802.11n (HT40)

Chan.	Freq. (MHz)	PSD (dBm/300kHz)	PSD (dBm/500kHz)	Duty Factor	Total PSD (dBm/500kHz)	Limit (dBm/500kHz)	Pass / Fail
151	5755	-9.82	-7.60	0.73	-6.87	30	Pass
159	5795	-7.98	-5.76	0.73	-5.03	30	Pass

NOTE: Refer to section 3.3 for duty cycle spectrum plot.

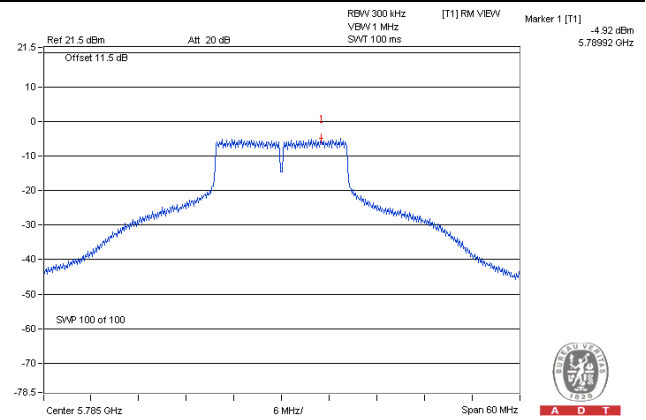
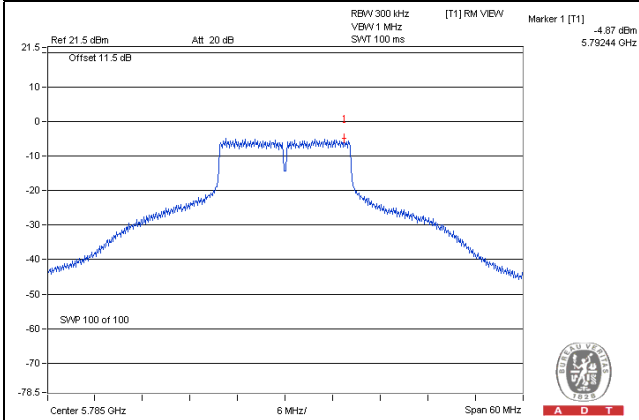
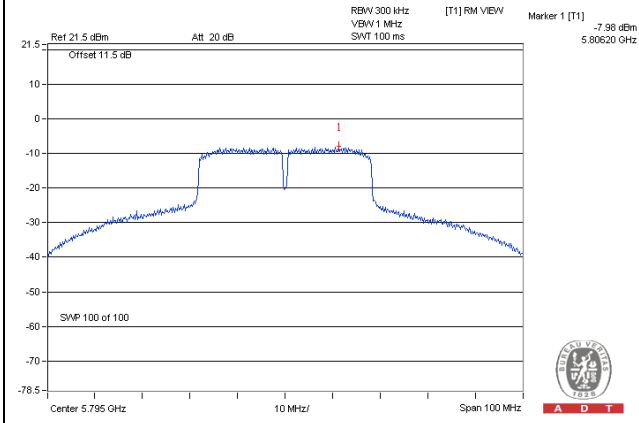
SPECTRUM PLOT OF WORST VALUE**802.11a****802.11n (HT20)****802.11n (HT40)**

4.5 Frequency Stability

4.5.1 Limits of Frequency Stability Measurement

The frequency of the carrier signal shall be maintained within band of operation

4.5.2 Test Setup

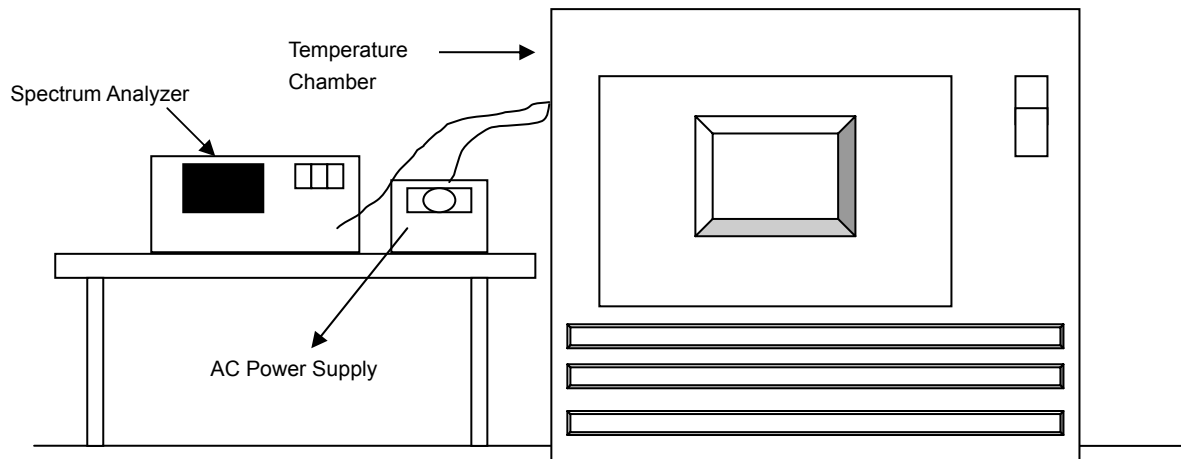

4.5.3 Test Instruments

Refer to section 4.1.2 to get information of above instrument.

4.5.4 Test Procedure

- a. The EUT was placed inside the environmental test chamber and powered by nominal AC voltage.
- b. Turn the EUT on and couple its output to a spectrum analyzer.
- c. Turn the EUT off and set the chamber to the highest temperature specified.
- d. Allow sufficient time (approximately 30 min) for the temperature of the chamber to stabilize, turn the EUT on and measure the operating frequency after 2, 5, and 10 minutes.
- e. Repeat step 2 and 3 with the temperature chamber set to the lowest temperature.
- f. The test chamber was allowed to stabilize at +20 degree C for a minimum of 30 minutes. The supply voltage was then adjusted on the EUT from 85% to 115% and the frequency record.

4.5.5 Deviation from Test Standard

No deviation.

4.5.6 EUT Operating Condition

Set the EUT transmit at un-modulation mode to test frequency stability.

4.5.7 Test Results

Frequency Stability Versus Temp.									
Operating Frequency: 5180MHz									
Temp. (°C)	Power Supply (Vac)	0 Minute		2 Minute		5 Minute		10 Minute	
		Measured Frequency (MHz)	Frequency Drift (%)	Measured Frequency (MHz)	Frequency Drift (%)	Measured Frequency (MHz)	Frequency Drift (%)	Measured Frequency (MHz)	Frequency Drift (%)
50	120	5180.0024	0.00005	5180.0056	0.00011	5180.0045	0.00009	5180.0062	0.00012
40	120	5180.0197	0.00038	5180.0171	0.00033	5180.0154	0.00030	5180.018	0.00035
30	120	5180.0102	0.00020	5180.0091	0.00018	5180.0101	0.00019	5180.0096	0.00019
20	120	5180.0159	0.00031	5180.0174	0.00034	5180.0164	0.00032	5180.0159	0.00031
10	120	5180.0239	0.00046	5180.0283	0.00055	5180.025	0.00048	5180.0247	0.00048
0	120	5179.9903	-0.00019	5179.9882	-0.00023	5179.9907	-0.00018	5179.9888	-0.00022
-10	120	5180.0051	0.00010	5180.0077	0.00015	5180.0028	0.00005	5180.0047	0.00009
-20	120	5179.9781	-0.00042	5179.9785	-0.00042	5179.9796	-0.00039	5179.9764	-0.00046
-30	120	5180.0062	0.00012	5180.0035	0.00007	5180.0026	0.00005	5180.0045	0.00009

Frequency Stability Versus Voltage.									
Operating Frequency: 5180MHz									
Temp. (°C)	Power Supply (Vac)	0 Minute		2 Minute		5 Minute		10 Minute	
		Measured Frequency (MHz)	Frequency Drift (%)	Measured Frequency (MHz)	Frequency Drift (%)	Measured Frequency (MHz)	Frequency Drift (%)	Measured Frequency (MHz)	Frequency Drift (%)
20	138	5180.0167	0.00032	5180.0166	0.00032	5180.0157	0.00030	5180.0167	0.00032
	120	5180.0159	0.00031	5180.0174	0.00034	5180.0164	0.00032	5180.0159	0.00031
	102	5180.0168	0.00032	5180.0166	0.00032	5180.0159	0.00031	5180.0166	0.00032

4.6 6dB Bandwidth Measurement

4.6.1 Limits of 6dB Bandwidth Measurement

The minimum of 6dB Bandwidth Measurement is 0.5MHz.

4.6.2 Test Setup

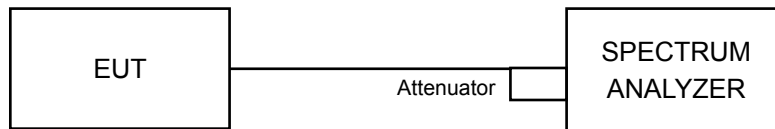

4.6.3 Test Instruments

Refer to section 4.1.2 to get information of above instrument.

4.6.4 Test Procedure

MEASUREMENT PROCEDURE REF

- Set resolution bandwidth (RBW) = 100kHz
- Set the video bandwidth (VBW) $\geq 3 \times$ RBW, Detector = Peak.
- Trace mode = max hold.
- Sweep = auto couple.
- Measure the maximum width of the emission that is constrained by the frequencies associated with the two amplitude points (upper and lower) that are attenuated by 6 dB relative to the maximum level measured in the fundamental emission

4.6.5 Deviation from Test Standard

No deviation.

4.6.6 EUT Operating Condition

The software provided by client to enable the EUT under transmission condition continuously at lowest, middle and highest channel frequencies individually.

4.6.7 Test Results

802.11a

Channel	Frequency (MHz)	6dB Bandwidth (MHz)	Minimum Limit (MHz)	Pass / Fail
149	5745	16.39	0.5	Pass
157	5785	16.42	0.5	Pass
165	5825	16.40	0.5	Pass

802.11n (HT20)

Channel	Frequency (MHz)	6dB Bandwidth (MHz)	Minimum Limit (MHz)	Pass / Fail
149	5745	16.41	0.5	Pass
157	5785	16.41	0.5	Pass
165	5825	16.41	0.5	Pass

802.11n (HT40)

Channel	Frequency (MHz)	6dB Bandwidth (MHz)	Minimum Limit (MHz)	Pass / Fail
151	5755	35.67	0.5	Pass
159	5795	35.24	0.5	Pass

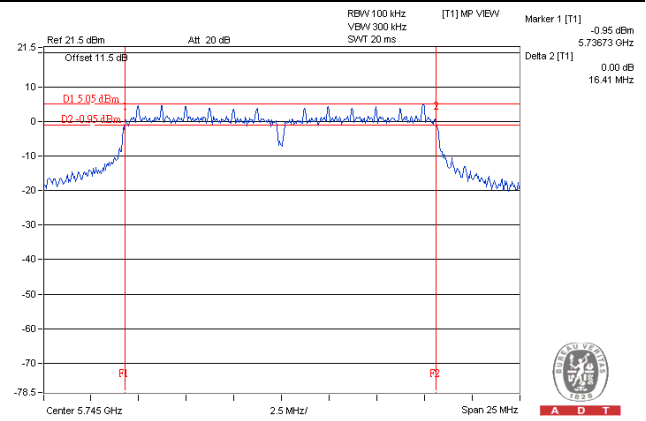
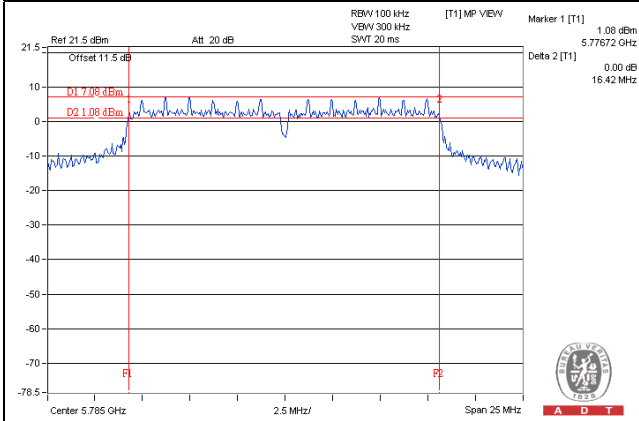
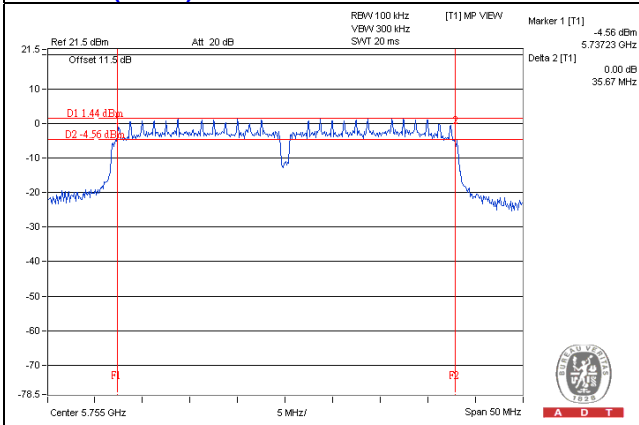
SPECTRUM PLOT OF WORST VALUE**802.11a****802.11n (HT20)****802.11n (HT40)**



5 Pictures of Test Arrangements

Please refer to the attached file (Test Setup Photo).

Appendix – Information on the Testing Laboratories

We, Bureau Veritas Consumer Products Services (H.K.) Ltd., Taoyuan Branch, were founded in 1988 to provide our best service in EMC, Radio, Telecom and Safety consultation. Our laboratories are accredited and approved according to ISO/IEC 17025.

If you have any comments, please feel free to contact us at the following:

Linko EMC/RF Lab

Tel: 886-2-26052180

Fax: 886-2-26051924

Hsin Chu EMC/RF Lab/Telecom Lab

Tel: 886-3-6668565

Fax: 886-3-6668323

Hwa Ya EMC/RF/Safety

Tel: 886-3-3183232

Fax: 886-3-3270892

Email: service.adt@tw.bureauveritas.com

Web Site: www.bureauveritas-adt.com

The address and road map of all our labs can be found in our web site also.

--- END ---